



**BOSCH**

Invented for life

# Diesel

Diesel fuel  
injection – new  
products and  
eXchange

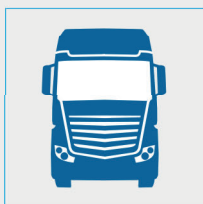
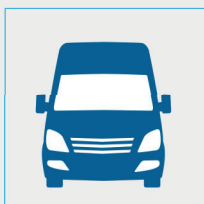
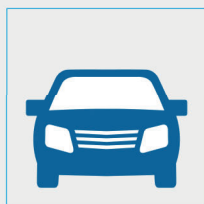
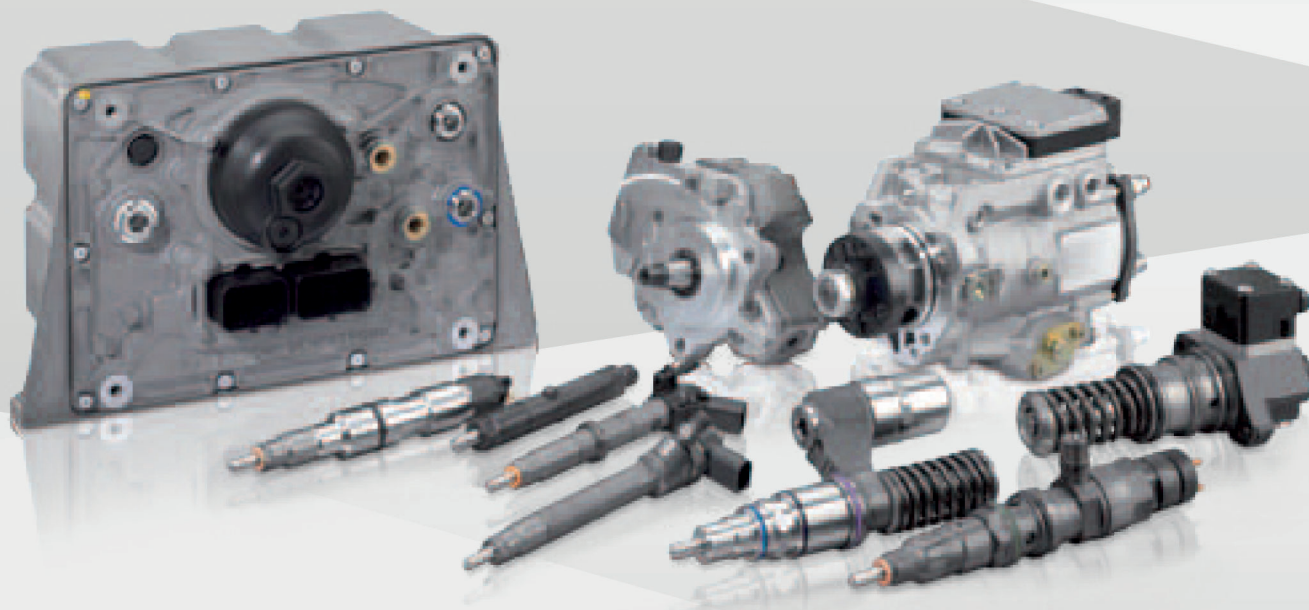



de

Als führender Entwickler und Hersteller verfügt Bosch über einzigartiges Diesel-Know-how und überzeugt durch Qualität, Zuverlässigkeit und innovative Technologie.

Ob Diesel-Neuware oder Bosch eXchange-Erzeugnisse - Bosch hat die passende Lösung.

en

As the leading developer and manufacturer, Bosch has unique diesel know-how and provides quality, reliability and innovative technology.

No matter if new parts or Bosch eXchange products - Bosch has the perfect solution.

fr

En tant que développeur et fabricant, Bosch détient un savoir-faire unique dans le domaine diesel et convainc par sa qualité, fiabilité et sa technologie innovante.

Qu'il s'agisse de nouveaux produits Bosch ou de produits Bosch eXchange - Bosch a toujours la solution adéquate.

it

In qualità di sviluppatore e produttore leader, Bosch dispone di una conoscenza unica in materia di diesel e convince grazie alla qualità, all'affidabilità e alle tecnologie innovative.

Che siano prodotti diesel nuovi o prodotti eXchange - Bosch ha la soluzione adatta.

es

Como desarrollador y fabricante líder, Bosch dispone de un conocimiento único sobre el diésel y convence con su calidad, fiabilidad y tecnología innovadora.

Tanto si se trata de productos diésel nuevos o de productos Bosch eXchange, Bosch tiene la solución adecuada.

pt

Enquanto líder no desenvolvimento e na produção, a Bosch possui um know-how único na área do diesel e convence pela sua qualidade, fiabilidade e tecnologia inovadora.

Sejam produtos diesel novos ou produtos Bosch eXchange - a Bosch tem a solução certa.

sv

Som ledande utvecklare och tillverkare förfogar Bosch över ett unikt kunnande för dieselkomponenter och övertygar med kvalitet, tillförlitlighet och innovativ teknik.

Om det gäller nya dieselkomponenter eller Bosch eXchange-komponenter - Bosch har den passande lösningen.

fi

Boschin käytettävissä on johtavana kehittäjänä ja valmistajana ainutlaatuinen tietotaito, joka vakuuttaa laadulla, luotettavuudella sekä innovatiivisella teknologialla.

Olipa kyse sitten uudesta diesel-osasta tai Boschin eXchange-tuotteesta - Boschilta löydät aina sopivan ratkaisun.

pl

Jako wiodący projektant i producent firma Bosch dysponuje wyjątkowym know-how z dziedziny silników wysokoprężnych i przekonuje do siebie jakością, niezawodnością i innowacyjnymi technologiami.

Nowe produkty do silników wysokoprężnych czy wyroby Bosch eXchange - Bosch zawsze ma odpowiednie rozwiązanie.

ru

Являясь ведущим разработчиком и изготовителем, компания Bosch обладает уникальными технологиями в области дизельных систем, активно внедряет инновации, обеспечивая тем самым высочайшее качество и надежность своей продукции.

Компания Bosch найдет подходящее решение как в виде новых дизельных компонентов, так и изделий Bosch eXchange.



**de****Online - Katalog****en****Online Catalogue****fr****Catalogue online****it****Catalogo online****es****Catálogo online****pt****Catálogo online****sv****Online - katalog****fi****Verkkokuvasto****pl****Katalog online****ru****Онлайн каталог****de**

Wählen Sie Ihre Sprache

**en**

Choose your language

**fr**

Choisissez votre langue

**it**

Seleziona vostra lingua

**es**

Elija su idioma

**pt**

Selecione o seu idioma

**sv**

Välj ditt språk

**fi**

Valitse kieli

**pl**

Wybierz język

**ru**

Выберите язык

**Bosch Automotive Catalog**

Vehicle search Product search Comparison List Watch List

Choose your country: **Product detail view**

**Last viewed items**

- Injector, CR system 0 445 120 146
- Control unit, diesel injector 0 281 001 001
- Injector, CR system 0 445 120 146
- View more

**Last viewed vehicles**

- RENAULT Megane IV 1.8 DCV1.8 40 001 00011
- TOYOTA Yaris 1.4 D-4D 1.4 40 000 0014
- BMW 118i d2 116 000 0018
- View more

**Injector, CR system**  
Bosch order number: 0 445 120 146

Add to compare list Add to watch list

Export PDF

Usage in vehicles

Spare parts

Start new product search Start new vehicle search

**Description**

Description	Original product
Part number	0445120146
Designation	Injector, CR system
Production discontinuation	-

**79 Countries  
28 Languages**

# www.bosch-automotive-catalog.com

Einfacher und schneller Zugriff auf Kfz-Ausrüstungsdaten von Bosch.

Easy and quick access to vehicle application data from Bosch.

Accès facile et rapide aux données de rechange automobile Bosch.

Ricerca semplice e veloce dei dati Bosch di equipaggiamento veicoli.

Fácil y rápido acceso a la información de equipamiento Bosch para vehículos.

Fácil e rápido acceso a dados de equipamentos automotivos da Bosch.

Enkel och snabb tillgång till fordonssuppgifter utrustning från Bosch.

Helppo ja nopea pääsy autotekniikka tietojia Boschilta.

Łatwy i szybki dostęp do danych urządzeń samochodowych Bosch.

Легкий и быстрый доступ к автомобильным данным оборудования из Bosch.

# Inhalt Content Contenu Contenuto Contenido Conteúdo Innehåll Sisältö Spis treści Содержание

Angebot / Offer / Offre / Offerta / Oferta /  
 Proposta / Offert / Tarjous / Oferta / Ассортимент

A2			
A10			
A12			
A16			
A18			

Verwendung / Applications / Affectation / Impiego / Aplicación  
 Toepassing / Användning / Utilização / Použití / Применение

B 2-29	B 129-219	B 301-364	B 428-453	B 476-517	-	-	B 575-581	B 582-593	
B 30-117	B 220-289	B 365-414	B 454-469	B B518-529	B 530-537	B 539-573	-	B 594-638	
B 118-127	B 290-299	B 415-426	B 470-474	-	B 538	-	-	-	
B 128	B 300	B 427	B 475	-	-	B 574	-	-	

Gegenüberstellung / Cross-reference / Table de correspondance / Comparazione / Equivalencias  
 Comparação / Jämförelse / Vertailu / Zamienniki / Сопоставления

C2



de

**Bosch-Dieseleinspritzung**  
**Neuware**

en

**Bosch diesel injection**  
**new products**

fr

**Injection diesel**  
**Bosch**  
**pièces neuves**

it

**Iniezione diesel**  
**Bosch**  
**componenti nuovi**

es

**Inyección diesel de**  
**Bosch**  
**producto nuevo**



**Hohe Zuverlässigkeit**  
**durch Erstausrüstungsqualität**

**Highly reliable thanks to**  
**original-equipment quality**

**Grande fiabilità grazie alla**  
**qualità OEM**

**Elevata affidabilità grazie alla**  
**qualità da primo equipaggiamento**

**Elevada fiabilidad gracias a**  
**la calidad de equipamiento original**

- ▶ Moderne Bosch-Dieseleinspritzsysteme zeichnen sich durch einen hohen Einspritzdruck mit einer exakten Einspritzung aus. Dies erfordert eine hohe Qualität und Fertigungstoleranzen im Bereich von tausendstel Millimetern.
- ▶ Breites Produktprogramm des weltweit führenden Zulieferers für Diesel-Erstausrüstung
- ▶ Hohe Marktdeckung für Pkw, leichte und schwere Nutzfahrzeuge, Landmaschinen und Sonderanwendungen
- ▶ Umfangreiche Produktinformationen, z. B. in der Werkstatt-Software ESI[tronic]
- ▶ Schnelle Verfügbarkeit der Ersatzteile bereits bei Markteinführung des Fahrzeuges
- ▶ Schneller, zuverlässiger Lieferservice
- ▶ Modern Bosch diesel injection systems feature a high injection pressure with high-precision injection. This requires the high quality and manufacturing tolerances in the range of a few thousands of a millimeter.
- ▶ Broad product range offered by the world's leading supplier of diesel original equipment
- ▶ High market coverage for passenger cars, light and heavy commercial vehicles, agricultural machinery and special applications
- ▶ Extensive product information, e.g. in the ESI[tronic] workshop software
- ▶ Quick availability of spare parts starting from the time of the vehicle's introduction into the market
- ▶ Fast, reliable delivery service
- ▶ Les systèmes modernes à injection diesel de Bosch se caractérisent par une pression élevée lors de l'injection accompagnée d'une parfaite précision d'injection. Ceci exige une qualité élevée et des tolérances de fabrication de l'ordre du millièbre de millimètre.
- ▶ Large programme de produits de l'équipementier automobile leader mondial pour l'équipement d'origine diesel
- ▶ Large couverture du marché des voitures particulières, véhicules utilitaires légers et lourds, machines agricoles et applications spéciales
- ▶ Nombreuses informations sur les produits par ex. dans le logiciel d'atelier ESI[tronic]
- ▶ Disponibilité rapide des pièces de rechange dès la commercialisation du véhicule
- ▶ Service de livraison rapide et fiable
- ▶ I moderni sistemi di iniezione diesel di Bosch si contraddistinguono per una elevata pressione ed una iniezione molto precisa. Ciò richiede elevata qualità e tolleranze di fabbricazione nella gamma di millesimi di millimetro.
- ▶ Vasta gamma di prodotti del fornitore leader a livello mondiale per il primo equipaggiamento diesel
- ▶ Elevata copertura del mercato per autovetture, veicoli commerciali leggeri e pesanti, macchina agricola e applicazioni speciali
- ▶ Informazioni dettagliate sui prodotti, ad es. nel software ESI[tronic]
- ▶ Rapida disponibilità delle parti di ricambio già al momento dell'introduzione sul mercato del veicolo
- ▶ Veloce, servizio di consegna affidabile
- ▶ Los sistemas modernos de inyección diesel de Bosch se caracterizan por una alta presión de inyección y una inyección exacta. Esto requiere una elevada calidad y unas tolerancias de fabricación de milésimas de milímetro.
- ▶ Amplia gama de productos del proveedor líder a nivel mundial para el equipamiento de primer montaje para diésel
- ▶ Gran cobertura en el mercado para turismo, vehículos industriales ligeros y pesados, maquinaria agrícola y aplicaciones especiales
- ▶ Información completa sobre los productos, p.ej. en el software para talleres ESI[tronic]
- ▶ Rápida disponibilidad de las piezas de repuesto ya en la introducción del vehículo en el mercado
- ▶ Servicio de entrega rápida y fiable

pt

## Sistema de injeção diesel Bosch produtos novos

sv

## Bosch diesel-insprutning ny artikel

fi

## Bosch-dieselruiskutus - Uudet tuotteet

pl

## Wtrysk paliwa do silników diesla Bosch produkt nowy

ru

## Система впрыска дизельного топлива Bosch Новый продукт



### Elevada fiabilidade graças à qualidade de equipamento original

- ▶ Os sistemas modernos de injeção diesel da Bosch caracterizam-se por uma injeção de alta pressão e com uma injeção exacta. Tal requer uma elevada qualidade e tolerâncias de produção na ordem dos milésimos de milímetro.
- ▶ Vasta gama de produtos do fornecedor líder mundial para equipamentos originais para veículos diesel
- ▶ Elevada cobertura de mercado para veículos ligeiros de passageiros, veículos comerciais ligeiros e pesados, máquinas agrícolas e aplicações especiais
- ▶ Informação completa sobre os produtos. Por exemplo no software ESI[tronic] para as oficinas
- ▶ Rápida disponibilidade de peças de substituição logo aquando do lançamento do veículo no mercado
- ▶ Serviço de entrega rápido e fiável

### Hög tillförlitlighet med originalutrustningskvalitet

- ▶ Moderna Bosch dieselinsprutningssystem kännetecknas av högt insprutningstryck med exakt insprutning. Det kräver hög kvalitet och tillverkningstoleranser på tusendelar av en millimeter.
- ▶ Brett produktprogram från den världsledande leverantören av dieseloriginaldelar
- ▶ Täcker väl in marknaden för personbilar, lätta och tunga arbetsfordon, jordbruksmaskiner och specialtillämpningar
- ▶ Omfattande produktinformation, t.ex. verkstads mjukvaran ESI[tronic]
- ▶ Snabb tillgång till reservdelar redan när fordonet introduceras på marknaden
- ▶ Snabb, pålitlig leveransservice

### Luotettava ensivarustelulaatua

- ▶ Moderneille Bosch-dieselruiskutusjärjestelmille on ominaista korkea ruiskutusaine ja hienosäädetty, tarkka ruiskutus. Tämä vaatii korkeaa laatua ja valmistustoleransseja millimetrin tuhannesosien alueella.
- ▶ Maa- ja laajuisesti johtavan toimittajan laaja ensiasennustuotevalikoima
- ▶ Korkea markkinoiden kattavuusaste henkilöautojen, kevyiden ja raskaiden hyötyajoneuvojen, maatalouskoneiden ja erikoissovellusten kohdalla
- ▶ Kattavat tuotetiedotteet, esim. korjaamoille suunnatussa ESI[tronic]-ohjelmistossa
- ▶ Varaosien nopea saatavuus jo markkinoilletulon yhteydessä
- ▶ Nopea, luotettava toimitusketju

### Duża niezawodność dzięki jakości pierwszego wyposażenia

- ▶ Nowoczesne układy wtryskowe do silników wysokoprężnych Bosch charakteryzują się precyzyjnym wtryskiem paliwa pod wysokim ciśnieniem. Wymaga to wysokiej jakości i tolerancji produkcyjnych w zakresie tysięcznych części milimetra.
- ▶ Bogaty program produktów wiodącego na świecie dostawcy pierwszego wyposażenia do silników wysokoprężnych
- ▶ Duże pokrycie rynku samochodów osobowych, lekkich i ciężkich pojazdów użytkowych, maszyn rolniczych i zastosowań specjalnych
- ▶ Obszerne informacje o produkcie, np. w oprogramowaniu dla serwisów samochodowych ESI[tronic]
- ▶ Szybka dostępność części zamiennych już od momentu wprowadzenia pojazdu na rynek
- ▶ Szybka i niezawodna dostawa

### Высокая степень надежности благодаря качеству от прямого поставщика

- ▶ Современные системы впрыска дизельного топлива Bosch характеризуются высоким давлением впрыска с точным впрыском. Для этого требуется соблюдение высоких стандартов качества и производственных допусков в тысячные доли миллиметра.
- ▶ Широкий ассортимент продукции от ведущего поставщика компонентов дизельных систем, применяемых при заводском комплектовании автомобилей
- ▶ Широкий охват рынка легковых автомобилей, легких и тяжелых коммерческих автомобилей, сельскохозяйственной и специальной техники
- ▶ Обширная информация о продуктах, например программное обеспечение для СТО ESI[tronic]
- ▶ Высокая доступность запасных частей уже на момент вывода автомобиля на рынок
- ▶ Быстрая, надежная доставка

de

**Bosch eXchange-  
Programm für  
Diseleinspritzung**

en

**Bosch eXchange  
program for diesel  
injection**

fr

**Bosch eXchange  
programme pour  
injection diesel**

it

**Bosch eXchange  
programma per  
iniezione diesel**

es

**Bosch eXchange  
programa para  
inyección diesel**



**Qualität ohne Kompromisse**

- ▶ Umfassendes Know-how des weltweit führenden Automobil-Zulieferers
- ▶ Instandsetzung in zertifizierten Bosch-Werken mit neuester Produktionstechnologie
- ▶ Produktweiterentwicklungen in der Erstausrüstung fließen mit in den Instandsetzungsprozess ein
- ▶ Konsequenter Ersatz aller Verschleißteile und aller kritischen Bauteile
- ▶ Ausschließliche Verwendung von Original-Bosch-Ersatzteilen
- ▶ 100%ige Funktionsprüfung aller instandgesetzten Aggregate wie bei Neuteilen
- ▶ Umweltschonend durch Reduzierung der CO<sub>2</sub>-Emissionen und Einsparung von Ressourcen

**Quality without compromises**

- ▶ Extensive know-how delivered by the world's leading automotive supplier
- ▶ Repairs in certified Bosch plants with state-of-the-art production technology
- ▶ Further product developments in OEM are incorporated into the repair process
- ▶ Strict policy of replacing all wearing parts and all critical components
- ▶ Exclusive use of original Bosch spare parts
- ▶ 100% identical functional tests for repaired equipment assemblies as for new parts
- ▶ Environmentally friendly due to reduced CO<sub>2</sub> emissions and resource economy

**La qualité sans compromis**

- ▶ Savoir faire reconnu du leader mondial de l'équipement automobile mis à la disposition de l'échange standard
- ▶ Réparations réalisées dans des usines Bosch certifiées avec la technologie de produits dernier cri
- ▶ Utilisation de pièces d'Origine dans le processus de réparation
- ▶ Remplacement systématique de toutes les pièces d'usure et de tous les composants critiques
- ▶ Utilisation exclusive de pièces de rechange d'origine Bosch
- ▶ Contrôle de fonctionnement à 100% appliqué à tous les groupes réparés, comme pour les composants neufs
- ▶ Solution écologique grâce à la réduction des émissions de CO<sub>2</sub> et à l'économie de ressources

**Qualità senza compromessi**

- ▶ Vasta conoscenza del fornitore automotive leader a livello mondiale
- ▶ Riparazione eseguita in stabilimenti Bosch certificati con le più nuove tecnologie produttive
- ▶ Gli sviluppi sui prodotti di primo equipaggiamento affluiscono nel processo di riparazione
- ▶ Sostituzione costante di tutte le parti soggette ad usura e di tutti i componenti critici
- ▶ Uso esclusivo di ricambi originali Bosch per il processo di rigenerazione
- ▶ Controllo funzionale al 100% di tutti i componenti riparati come per i componenti nuovi
- ▶ Nel completo rispetto dell'ambiente riducendo le emissioni di CO<sub>2</sub> e risparmiando risorse

**Calidad sin compromisos**

- ▶ Extenso conocimiento del proveedor automovilístico líder a nivel mundial
- ▶ Puesta en marcha en talleres Bosch certificados con la última tecnología de producción
- ▶ Los desarrollos de productos en el primer montaje se integran en el proceso de reparación correctivo
- ▶ Sustitución consecutiva de todas las piezas de desgaste y todos los componentes críticos
- ▶ Se emplean exclusivamente recambios originales Bosch
- ▶ Comprobación de funcionamiento al 100% de todos los equipos reparados agregados, al igual que en las piezas nuevas
- ▶ Respetuoso con el medioambiente gracias a la reducción de las emisiones de CO<sub>2</sub> y el ahorro de recursos



pt

### Bosch programa de intercâmbio para injeção diesel

sv

### Bosch eXchange program för diesel-injektion

fi

### Bosch eXchange dieselruiskutusosien vaihto-ohjelma

pl

### Program Bosch eXchange części układów wtryskowych Diesla

ru

### Программа Bosch обмен на дизельное инжекции



#### Qualidade sem compromissos

- Know-how abrangente do fornecedor automóvel líder mundial
- Reparação em oficinas Bosch certificadas com a mais recente tecnologia de produção
- Os desenvolvimentos de produtos em equipamentos originais são integrados no processo de reparação
- Substituição consistente de todas as peças de desgaste e todos os componentes críticos
- Utilização exclusiva de peças de reposição originais Bosch
- Teste funcional a 100% de todos os agregados reparados tal como em peças novas
- Ecológico graças à redução das emissões de CO<sub>2</sub> e à economia de recursos

#### Kvalitet utan kompromisser

- Omfattande kunskande hos den världsledande underleveratören till bilindustrin
- Reparationer utförs utslutande i certifierade Boschverkstäder med den nyaste produktions-tekniken
- Produktutvecklingen för originaldelar kommer även tillgodo i reparationsledet
- Konsekvent byte av alla slitdelar och kritiska komponenter
- Enbart Bosch originalreservdelar används
- 100% funktionskontroll av både reparerade delar och originaldelar
- Skonar miljön tack vare minskade CO<sub>2</sub>-utsläpp och mindre resurskrav

#### Tinkimätöntä laatua

- Maailmanlaajuisesti johtavan autoteollisuuden toimittajan laaja tietotaito
- Kunnostus yksinomaan valtuutetuilla Boschin tehtailla uusinta tuoteteknologiaa hyödyntäen
- Ensiasennuksen tuotekehitys sopii hyvin yhteen kunnostus-prosessin kanssa
- Kaikkien kuluvien osien ja kriittisten rakenneosien johdonmukainen korvaus
- Varaosina käytetään vain alkuperäisiä Bosch-varaosia
- 100-prosenttinen toimintotesti suoritetaan kaikille kunnostetuille laitteille ja uusille osille
- Ympäristöstävällinen - vähemmän CO<sub>2</sub>-päästöjä ja enemmän luonnonvarojen säästöä

#### Jakość bez kompromisów

- Wszechstronne know-how wiodącego światowego dostawcy części samochodowych
- Naprawy w certyfikowanych warsztatach Bosch z wykorzystaniem najnowocześniejszych technologii produkcyjnych
- Dalszy rozwój produktów w pierwszym wyposażeniu jest częścią procesu napraw
- Konsekwentne zastępowanie wszystkich części ulegających zużyciu i wszystkich krytycznych podzespołów
- Stosowanie wyłącznie oryginalnych części zamiennych Bosch
- 100-procentowa kontrola działania wszystkich naprawionych podzespołów jak w przypadku nowych części
- Ochrona środowiska dzięki redukcji emisji CO<sub>2</sub> i oszczędzaniu zasobów

#### Качество без компромиссов

- Инновационные технологии от ведущего мирового поставщика комплектующих для автомобильной промышленности
- Ремонт осуществляется в сертифицированных мастерских Bosch с использованием новейших технологий
- Все новейшие производственные разработки находят применение и в случае ремонта
- Последовательная замена всех быстроизнашивающихся частей и критичных деталей
- Использование исключительно оригинальных запчастей Bosch
- Все отремонтированные агрегаты проходят контрольные проверки в том же объеме (100%), что и новые
- Бережное отношение к природе за счет снижения выбросов CO<sub>2</sub> и экономии ресурсов

de

**Bosch eXchange – die ausgezeichnete Instandsetzungs-alternative für jede Werkstatt. Effizient, einfach, schnell.**

en

**Bosch eXchange – the excellent repair alternative for every workshop. Efficient, easy, fast.**

fr

**Bosch eXchange – Une excellente alternative de réparation pour tous les ateliers. Efficace, simple et rapide.**

it

**Bosch eXchange – l'alternativa di riparazione eccellente per ogni officina. Efficiente, facile, veloce.**

es

**Bosch eXchange: la alternativa extraordinaria de mantenimiento correctivo para cada taller. Eficiente, simple, rápido.**



- ▶ Günstiger Preis für eine zeitwertgerechte Fahrzeugreparatur
- ▶ Schnelle Schadensbehebung
- ▶ Kalkulierbare Reparaturzeit
- ▶ Keine Investition in teure Komponenten-Prüftechnik
- ▶ Hohe Marktdeckung und breites Typenspektrum mit regelmäßiger Programm-erweiterung
- ▶ Keine Entscheidungsprobleme für Altteile

- ▶ Economical prices for repairs based on current vehicle value
- ▶ Rapid elimination of damage
- ▶ Calculable repair time
- ▶ No investment in expensive component testing equipment
- ▶ High market coverage and broad range of types, regular program extensions
- ▶ No disposal problems for used parts

#### Return conditions for used parts

Under the Bosch eXchange program, all diesel components can be returned unless they exhibit one or more of the following features:

- ▶ Part number can not be read
- ▶ Severe corrosion
- ▶ Disassembled or incomplete
- ▶ Severe mechanical damage

The factory inspection determines whether products are suitable for exchange based on the above guidelines. Engine-mounting parts and fixing bolts are not covered by the Bosch eXchange program. These must be unscrewed and should be reused.

- ▶ Un prix avantageux pour une réparation adaptée à la valeur du véhicule
- ▶ Dépannage rapide
- ▶ Temps de réparation prévisible
- ▶ Pas d'investissement dans de coûteux systèmes de contrôle des composants
- ▶ Une forte couverture du marché et une vaste gamme, avec une permanente remise à jour
- ▶ Pas de problèmes d'élimination des anciennes pièces

#### Conditions de reprise des pièces usagées

Peuvent être repris, dans le cadre de la gamme Bosch eXchange, tous les composants diesel, dans la mesure où ils ne présentent pas l'un ou plusieurs des critères suivants :

- ▶ Référence non lisible
- ▶ Forte corrosion
- ▶ démontés ou incomplets
- ▶ Dommages mécaniques importants

Le service de contrôle de l'usine décide si l'échange est possible en fonction des critères mentionnés ci-dessus. Les pièces rapportées du moteur et les vis de fixation ne font pas partie de la gamme Bosch eXchange. Elles doivent être dévissées et réutilisées.

- ▶ Prezzo conveniente per una riparazione in linea con il valore attuale del veicolo
- ▶ Rapida riparazione del veicolo
- ▶ Tempi di riparazione facilmente quantificabili
- ▶ Non sono richiesti grandi investimenti in attrezzature per il controllo dei componenti
- ▶ Elevata copertura del mercato, ampia gamma di prodotti e aggiornamenti costanti del programma
- ▶ Nessun problema di smaltimento dei componenti usati

#### Condizioni per la restituzione di componenti usati

Nell'ambito del programma Bosch eXchange possono essere restituiti i componenti diesel, a patto che non presentino una o più delle seguenti caratteristiche:

- ▶ Numero parte non può essere letto
- ▶ Marcata corrosione
- ▶ smontato o incompleta
- ▶ Gravi danni meccanici

Un attento controllo determinerà se il componente può essere restituito in base ai criteri menzionati sopra. Parti applicate sul motore e viti di fissaggio non sono comprese nel programma Bosch eXchange. Esse vanno pertanto smontate e se ne consiglia il riutilizzo.

- ▶ Precio económico de reparación basado en el valor actual del vehículo
- ▶ Subsanación rápida de los daños
- ▶ Tiempo de reparación calculable
- ▶ No son necesarias inversiones en sistemas para la comprobación de componentes
- ▶ Alto grado de cobertura del mercado y amplio espectro de modelos, con una actualización constante del programa
- ▶ Sin problemas de eliminación de piezas viejas

#### Condiciones para la readmisión de piezas viejas

Se pueden readmitir en el marco del programa Bosch eXchange todos los componentes diesel, siempre y cuando no presenten una "o" varias de las siguientes características:

- ▶ Número de referencia que no se puede leer
- ▶ Fuerte corrosión
- ▶ desmontado debería llevar mayúscula como en el resto de puntos

▶ Importantes daños mecánicos  
Considero que suena mejor utilizar intercambio en lugar de canje según las normas arriba citadas. Las piezas de montaje exterior del motor y los tornillos de fijación no son parte del programa Bosch eXchange. Se tienen que desatornillar y volver a utilizar.

#### Rücknahmebedingungen für Altteile

Rücknahmefähig im Rahmen des Bosch-eXchange-Programms sind alle Dieselkomponenten, sofern sie nicht eines oder mehrere der folgenden Merkmale aufweisen:

- ▶ Sachnummer nicht lesbar
- ▶ Starke Korrosion
- ▶ Zerlegt oder unvollständig
- ▶ Starke mechanische Beschädigung

Die werkseitige Prüfung entscheidet über die Tauschfähigkeit nach den oben genannten Richtlinien. Motoranbauteile und Befestigungsschrauben sind nicht Teil des Bosch-eXchange-Programms. Sie müssen abgeschraubt und sollten wiederverwendet werden.

pt

**Bosch eXchange – a alternativa de reparação perfeita para todas as oficinas. Eficiente, simples, rápido.**

sv

**Bosch eXchange – det utmärkta reparationsalternativet för alla verkstäder. Effektivt, enkelt, snabbt.**

fi

**Bosch eXchange – erinomainen kunnostusvaihtoehto jokaiseen korjaamoon. Tehokas, helppo, nopea.**

pl

**Bosch eXchange – doskonała alternatywa do napraw dla każdego warsztatu. Wydajnie, łatwo, szybko.**

ru

**Bosch eXchange – отличная альтернатива ремонту для каждой СТО. Эффективно, просто, быстро.**



- ▶ Preço económico para uma reparação de acordo com o valor actual do veículo
- ▶ Eliminação rápida de danos
- ▶ Tempo de reparação facilmente quantificável
- ▶ Sem necessidade de investimentos em dispendiosos equipamentos de teste de componentes
- ▶ Elevado grau de cobertura de mercado e amplo espectro de modelos com uma actualização constante do programa
- ▶ Sem problemas de eliminação de peças usadas

#### Condições de devolução para peças usadas

No âmbito do programa Bosch eXchange, é possível devolver todos os componentes diesel, desde que estes não apresentem um ou vários dos seguintes sinais:

- ▶ Número da peça não pode ser lido
- ▶ Forte corrosão
- ▶ desmontado ou incompletas danificadas
- ▶ Fortes danos mecânicos

O serviço de verificação da fábrica determinará se o produto poderá ser substituído, de acordo com as directrizes acima referidas. As peças de montagem do motor e os parafusos de fixação não estão incluídos no programa Bosch eXchange. Têm de ser desapertados e reutilizados.

- ▶ Bra pris för reparation anpassad till nuvarande marknadsvärde
- ▶ Snabb skadevårdning
- ▶ Reparationstid som kan beräknas
- ▶ Ingen investering i dyr komponent-provningsteknik
- ▶ Hög marknadstäckning och brett modellspektrum med ständig programuppdatering
- ▶ Inga omhändertagningsproblem med gamla delar

#### Villkor för att returnera använda delar

Återkallningsbara enligt Bosch-eXchange-programmet är samtliga dieselkomponenter, om de inte uppvisar en eller flera av följande egenskaper:

- ▶ Artikelnummer kan inte läsas
- ▶ Kraftig korrosion
- ▶ Isärmonterade eller ofullständiga
- ▶ Kraftigt mekanisk skada

Kontrollen i fabrik avgör om byte kan göras enligt ovanstående direktiv. Motorpåbyggnadsdelar och fästskruvar ingår inte i Bosch eXchange-programmet. De måste skruvas av och ska sättas tillbaka efteråt.

- ▶ Korjauksen oikea hinta auton arvoon nähden
- ▶ Nopea vikojen korjaus
- ▶ Ennakoitavat korjausajat
- ▶ Ei vaadi investointeja kalliiseen testaustekniikkaan
- ▶ Suuri markkinakattavuus ja laaja tyypivalikoima, aukottomat ohjelmapäivitykset
- ▶ Käytettyjen osien hävitysongelmia ei ole

#### Käytettyjen osien palautusehdot

Palautuskelpoisia ovat Bosch-eXchange-ohjelmassa kaikki dieselkomponentit, jos niissä ei ole havaittu yhtä tai useampaa seuraavista puutteista tai vioista:

- ▶ Osanumeroa ei voi lukea
- ▶ voimakas korroosio
- ▶ purettu osiin tai puutteellinen
- ▶ Suuri mekaaninen vaurio

Tehdas päättää tulotarkastuksessa, onko komponentti vaihtokelpoinen em. kriteerien perusteella. Moottoriin kiinnitettävät osat ja kiinnitysruuvit eivät kuulu Bosch-eXchange-ohjelmaan. Ne on irrotettava ja ne tulee käyttää uudelleen.

- ▶ Przystępna cena naprawy, odpowiednia do aktualnej wartości pojazdu
- ▶ Szybkie usuwanie usterek
- ▶ Przewidywalny czas naprawy
- ▶ Brak wydatków na drogie urządzenia do testowania komponentów
- ▶ Wysokie pokrycie rynku i szeroka oferta typów z ciągłą aktualizacją asortymentu
- ▶ Brak problemu utylizacji zużytych części

#### Warunki odbioru zużytych części

W ramach programu Bosch eXchange wymianie podlegają takie komponenty do silników wysokoprężnych, które nie posiadają jednej lub kilku z poniższych kluczowych uszkodzeń:

- ▶ Numer części nie może być odczytany
- ▶ Silna korozja
- ▶ Produkt rozmontowany lub niekompletny
- ▶ Poważne uszkodzenie mechaniczne

Weryfikacja w miejscu selekcji decyduje o możliwości zwrotu części według wymienionych wyżej wytycznych. Elementy silnika i śruby mocujące nie należą do asortymentu Bosch eXchange. Należy je odkręcić i użyć ponownie.

- ▶ Выгодная цена для ремонта за реальную стоимость
- ▶ Быстрое устранение повреждений
- ▶ Расчетное время ремонта
- ▶ Без инвестиции в дорогое оборудование для испытания компонентов
- ▶ Большой охват рынка и широкий спектр типов с постоянной актуализацией программы
- ▶ Отсутствие проблем с утилизацией бывших в эксплуатации старых деталей

#### Условия возврата бывших в употреблении деталей

Возврату в рамках программы Bosch eXchange подвергаются все дизельные компоненты, если они не имеют одного или нескольких из следующих признаков:

- ▶ Номер детали не могут быть прочитаны
- ▶ Сильная коррозия
- ▶ разобранном или неполной
- ▶ Значительное механическое повреждение

В результате заводского испытания принимается решение о возможности замены в соответствии с указанными выше правилами. Пристраиваемые к двигателю детали и крепежные винты не являются частью программы Bosch eXchange. Их необходимо открутить и использовать повторно.



de

**Rücknahmebedingungen für Dieselkomponenten**

en

**Return conditions for diesel components**

fr

**Conditions de reprise pour les composants diesel**

it

**Criteri di ritorno per i componenti diesel**

es

**Condiciones de devolución para componentes diésel**



**Kundenfreundliche Altteilerücknahme und Pfandwert-erstattung**

- ▶ Übersichtliche Pfandklassen
- ▶ Eindeutige Rücknahmekriterien
- ▶ Einfaches Rücknahmesystem mit „Back in Box“
- ▶ Weitere Informationen zur Altteilerücknahme mit CoremanNet finden Sie unter: [www.coremannet.com](http://www.coremannet.com)

**Customer-friendly used parts return and refunding**

- ▶ Clear reimbursement classes
- ▶ Clear return criteria
- ▶ Simple “back in box” return system
- ▶ For more information about returning used parts with CoremanNet, visit: [www.coremannet.com](http://www.coremannet.com)

**Reprise des pièces usagées et restitution de la consigne**

- ▶ Des classes de consignes claires
- ▶ Des critères de reprise simples
- ▶ Un système de reprise simple avec «Back in Box»
- ▶ Vous trouverez davantage d'informations sur la reprise des pièces usagées avec CoremanNet sur : [www.coremannet.com](http://www.coremannet.com)

**Procedimenti chiari e semplici per la restituzione di componenti usati e il rimborso del valore del reso**

- ▶ Chiara definizione del valore dei contributi di rigenerazione
- ▶ Criteri univoci di restituzione
- ▶ Semplice sistema di restituzione secondo il principio «Back in Box»
- ▶ Ulteriori informazioni sulla restituzione di componenti usati sono reperibili all'indirizzo: [www.coremannet.com](http://www.coremannet.com)

**Recogida de piezas viejas y restitución del valor de devolución conveniente para los clientes**

- ▶ Clases de prendas claras
- ▶ Criterios de devolución claros
- ▶ Sencillo sistema devolución con «Back in Box»
- ▶ Para mayor información sobre la recogida de piezas viejas a través de CoremanNet, visitar: [www.coremannet.com](http://www.coremannet.com)

pt

**Condições de devolução para componentes diesel**

sv

**Villkor för retur av dieselkomponenter**

fi

**Diesel-komponenttien palautusehdot**

pl

**Warunki zwrotu komponentów do silników wysokoprężnych**

ru

**Условия возврата для дизельных компонентов**

### Nozzle-and-holder assemblies / CR injectors

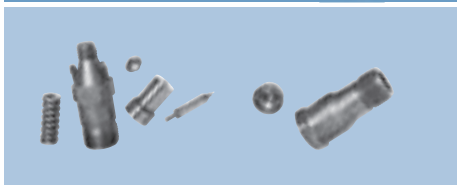

Incomplete or dismantled nozzle holder

### Diesel injection pumps / CR pumps CP 1 / 3

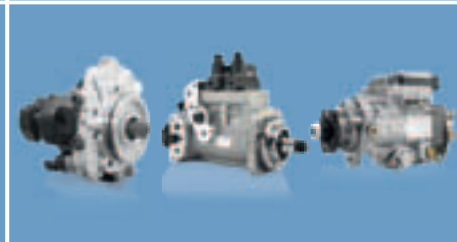

Incomplete or dismantled pump

Damaged drive shaft or flange, heavy mechanical damage

### Unit pumps / Unit injectors



Heavy corrosion

Heavy corrosion



Heavy mechanical damage



Heavy mechanical damage on drive flange or shaft

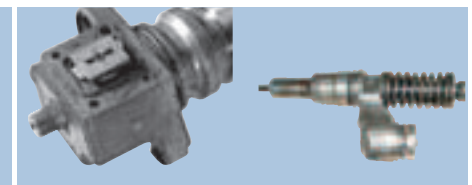

Incomplete or dismantled unit

Incomplete or dismantled unit

### Reasons for rejected return: ► Heavy corrosion ► Incomplete unit ► Dismantled unit ► Mechanical damage

#### Devolução de peças usadas e reembolso práticos para o cliente

- Classes de reembolso claras
- Critérios de devolução claros
- Sistema de devolução simples com "Back in Box"
- Pode encontrar mais informações sobre a devolução de peças usadas com CoremanNet em: [www.coremannet.com](http://www.coremannet.com)

#### Kundvänlig insamling av begagnade delar och pantåterbetalning

- Överskådliga pantklasser
- Entydiga återkallningskriterier
- Enkelt återkallningssystem med "Back in Box"
- Mer information om insamling av begagnade apparater med CoremanNet finns på: [www.coremannet.com](http://www.coremannet.com)

#### Asiakasystävällistä palvelua: käytettyjen osien palautus ja runkoarvon hyvitys

- Selkeä palautusosien luokittelu
- Yksiselitteiset palautuskriteerit
- Käytettyjen osien palautus 'Back in Box'
- Lisätietoja CoremanNetin käytettyjen osien palautuksesta löytyy osoitteesta: [www.coremannet.com](http://www.coremannet.com)

#### Wygodny odbiór zużytych części oraz zwrot wartości kosztu wymiany

- Przejrzyste wartości kosztu wymiany
- Jednoznaczne kryteria zwrotów
- Prosty system zwrotów „Back in Box“
- Więcej informacji na temat odbioru zużytych części z użyciem CoremanNet można znaleźć na stronie: [www.coremannet.com](http://www.coremannet.com)

#### Удобный для клиентов порядок возврата бывших в употреблении деталей и возмещения залоговой стоимости

- Легко обозримые классы залога
- Однозначные критерии возврата
- Простая система возврата по принципу "Back in Box"
- Дальнейшую информацию о порядке возврата бывших в употреблении деталей по системе CoremanNet Вы найдете здесь: [www.coremannet.com](http://www.coremannet.com)

de

**Düsenhalter-kombinationen:**  
Umschlüssel-Hilfe

en

**Nozzle-and-holder assemblies:**  
conversion key

fr

**Ensembles porte-injecteurs:**  
aide au changement de code

it

**Gruppi porta-polverizzatore:**  
schema ausiliare per l'identificazione

es

**Conjuntos inyectoros:**  
ayuda de descodificación



**Bitte beachten!**

Mit den Angaben der Typformel des Original-Bosch-Düsenhalters und dem angegebenen Einspritzdruck allein ist es nicht in allen Fällen möglich, auf die entsprechende Bestellnummer der Bosch eXchange Düsenhalterkombination zu schließen. Der Unterschied liegt entweder in der eingebauten Düse (Beispiel ①) oder bei gleicher Düse im unterschiedlichen Düsenhalter (Beispiel ②).

Daher ist es in diesen Fällen unbedingt erforderlich, die entsprechenden Bosch eXchange Düsenhalterkombinationen über das Fahrzeug im Verwendungsteil festzustellen.

Sollte das nicht möglich sein, muss in diesen Fällen die alte Düsenhalterkombination demontiert werden, um zur Düsenhalter-Typformel und dem Öffnungsdruck die eingebaute Düse zu ermitteln.

In einigen Fällen kann man, bedingt durch Rationalmaßnahmen in der Fertigung, mehrere Düsenhalterkombinationen (Beispiel ③) ein und derselben Austausch-Düsenhalterkombination zuordnen.

Nicht aufgeführte Bestellnummern sind nicht im Austausch-Programm enthalten.

**Please note!**

Only the type designation of the original Bosch nozzle holder and the stated pressure do not always suffice to draw conclusions as to the corresponding part number of the Bosch eXchange nozzle-and-holder assembly.

The difference lies either in the nozzle fitted (example ① below) or, if the nozzle is the same, in the different nozzle holder (example ② below).

It is therefore essential in such cases to identify the corresponding Bosch eXchange nozzle-and-holder assemblies via the vehicle in the Application section of the catalog.

If this is not possible, the old nozzle-and-holder assembly must be disassembled, so as to determine the fitted nozzle in addition to the nozzle holder type designation and opening pressure.

Due to the rationalization of production, several different nozzle-and-holder assemblies may sometimes correspond to one and the same exchange nozzle-and-holder assembly (example ③).

Order numbers not listed are not included in the exchange program.

**Remarque !**

Les données de la formule de type du porte-injecteur Bosch d'origine et de la pression d'ouverture voulue ne permettent pas toujours, à elles seules, de retrouver la référence correspondante du porte-injecteur avec injecteur en Bosch eXchange. La divergence résulte soit de l'injecteur intégré (exemple ①), soit du porte-injecteur différent pour le même injecteur (exemple ②).

Dans ce cas, il est donc indispensable de déterminer, dans la section «Applications», le porte-injecteur avec injecteur de Bosch eXchange par sélection du véhicule adéquat.

Si cela n'est pas possible, l'ancien porte-injecteur avec injecteur doit être démonté afin de pouvoir déterminer l'injecteur intégré à partir de la formule de type du porte-injecteur et de la pression d'ouverture.

Dans certains cas, il est possible, en raison de la rationalisation de la fabrication, d'affecter à plusieurs ensembles injecteur/porte-injecteur (exemple ③) un seul et même porte-injecteur avec injecteur d'échange standard.

Les numéros de série non stipulés ne figurent pas dans la gamme d'échange standard.

**Attenzione!**

Solo con l'indicazione della sigla del portapolverizzatore originale Bosch e della pressione d'iniezione, non è sempre possibile risalire al numero di ordinazione del portapolverizzatore completo.

La differenza è che in uno stesso corpo si possono montare polverizzatori differenti (Es. ①) oppure lo stesso polverizzatore può essere montato su corpi differenti (Es. ②).

In questo caso è assolutamente necessario stabilire, attraverso il veicolo, il portapolverizzatore completo Bosch eXchange, nella parte dedicata all'uso.

Qualora non fosse possibile, bisognerebbe smontare il portapolverizzatore vecchio per leggere la sigla del polverizzatore che servirà, insieme alla sigla del corpo ed alla pressione di apertura, a determinare il codice del prodotto eXchange.

In alcuni casi è possibile che in base alla produzione, ad un codice eXchange vengano abbinati più di un portapolverizzatore completo (Es. ③).

I numeri d'ordine non elencati non sono compresi nel programma di sostituzione.

**Por favor, tenga en cuenta!**

Aún disponiendo de las indicaciones existentes relacionadas con el tipo del portainyector original de Bosch, así como de la presión indicada, no es siempre posible deducir el número de pedido correspondiente del portainyector con inyector de Bosch eXchange.

La diferencia se encuentra, o bien en el inyector montado (ejemplo ①) o, en el caso de inyector idéntico, en el diferente portainyector (ejemplo ②).

Por ello, en estos casos es absolutamente imprescindible determinar el correspondiente portainyector con inyector de Bosch eXchange a través del vehículo en la sección «Aplicaciones».

Si esto no es posible, en estos casos se deberá desmontar el portainyector con inyector, para así determinar el tipo de portainyector y la presión de abertura del inyector montado.

En algunos casos, y debido a las medidas de racionalización llevadas a cabo en la producción, se puede asignar a varios portainyectores con inyector (ejemplo ③) un mismo portainyector con inyector de intercambio.

Los números de pedido no indicados no están incluidos en el programa de sustitución.





**Beispiel für Umschlüsselung**

**Example of recoding**

**Exemple de recodage**

**Esempio di ricodifica**

**Ejemplo de recodificación**

	 Typ	 Typ	 bar		 eXchange
①	KCA 30 S 44	DN 0 SD 261	115	0 432 217 131	<b>0 986 430 022</b>
	KCA 30 S 44	DN 0 SD 265	115	0 432 217 141	<b>0 986 430 025</b>
	KCA 30 S 44	DN 0 SD 220	115	0 432 217 142	<b>0 986 430 020</b>
②	KCE 27 S 3	DN 0 SD 310	115	0 432 217 253	<b>0 986 430 245</b>
	KCA 27 S 55	DN 0 SD 310	115	0 432 217 262	<b>0 986 430 246</b>
③	KDAL 80 S 47	DLLA 140 S 1003	200	0 432 231 680	<b>0 986 430 038</b>
	KDAL 80 S 42	DLLA 140 S 1003	200	0 432 231 764	<b>0 986 430 038</b>
	KDAL 80 S 14/14	DLLA 144 S 8200	175	0 432 231 797	<b>0 986 430 038</b>



pt

**Conjuntos porta-injectores:**

ajuda para recodificação

**Respeite as seguintes instruções!**

Nem sempre as indicações da designação do porta-injector original da Bosch e a pressão de injeção referida bastam para inferir o respectivo número de referência do conjunto porta-injector eXchange da Bosch. A diferença poderá estar ou no injector montado (exemplo ①) ou no porta-injector diferente caso o injector seja idêntico (exemplo ②). Por conseguinte será imprescindível, nestes casos, determinar os respectivos conjuntos porta-injectores eXchange da Bosch através do veículo na secção de aplicação. Se tal não for possível, o conjunto porta-injector usado tem de ser desmontado para se poder apurar o injector instalado relativamente à designação do porta-injector e à pressão de abertura do injector montado. Nalguns casos, vários conjuntos porta-injectores (exemplo ③) podem corresponder ao mesmo conjunto porta-injector de substituição devido a medidas de racionalização no fabrico. Os números de referência não mencionados não constam do programa de substituição.

sv

**Munstyckshållarkombinationer:**

Omkodningshjälp

**Obs.!**

Med enbart uppgifterna i typformeln för Boschs originalmunstyckshållare och det angivna insprutningstrycket är det inte alltid möjligt att få fram det tillhörande beställningsnumret för Bosch eXchange-munstyckshållarkombinationen. Skillnaden ligger antingen i det monterade munstycket (exempel ①) eller vid samma munstycke i olika munstyckshållare (exempel ②). Därför måste du i dessa fall ovillkorligen bestämma tillhörande Bosch eXchange munstyckshållarkombinationer via fordonet i användningsdelen. Om detta inte går måste du i dessa fall demontera den gamla munstyckshållarkombinationen för att kunna bestämma munstyckshållarens typformel och det monterade munstyckets öppningstryck. I vissa fall kan man på grund av rationaliseringar i tillverkningen tilldela flera munstyckshållarkombinationer (exempel ③) till en och samma munstyckshållarkombinationsbytesdel. Ej uppräknade beställningsnummer ingår inte i utbytesprogrammet.

fi

**Suutin-pidin-yhdistelmät:**

Uudelleenkodeaus

**Ota huomioon!**

Tiedot alkuperäisen Bosch-suutinpitimen tyyppikaavasta ja ilmoitetusta ruiskutusaineesta eivät yksinään riitä kaikissa tapauksissa selvittämään Bosch eXchange suutinpidin-yhdistelmän oikeaa tilausnumeroa. Eroja saattaa olla joko asennetussa suuttimessa (esimerkki ①) tai sama suutin on asennettu erityyppiseen pitimeen (esimerkki ②). Tällaisissa tapauksissa on oikeat Bosch eXchange suutinpidin-yhdistelmät välttämättä selvitettävä ajoneuvoon asennetun suuttimen osan perusteella. Mikäli se ei ole mahdollista, ko. tapauksessa on vanha suutinpidin-yhdistelmä irrotettava autosta, jotta saadaan selville asennetun suuttimen tyyppikaava sekä avautumisaine. Osassa tapauksista on mahdollista, että useampi suutinpidin-yhdistelmä sopii yhteen ja samaan vaihtosaan (esimerkki ③), mikä johtuu valmistusprosessin rationalisointitoimenpiteistä. Mikäli tilausnumero ei sisälly luetteloon, se ei kuulu vaihtosaohjelmaan.

pl

**Kombinacje dysz z osadami:**

Pomoc w konwersji

**Uwaga!**

Podanie jedynie formuły typu oryginalnej osady dyszy oraz podanego ciśnienia wtrysku nie w każdym przypadku jest wystarczające do określenia odpowiedniego numeru katalogowego kombinacji dyszy i jej osady Bosch eXchange. Różnica leży w zamontowanej dyszy (przykład ①) lub – w przypadku tej samej dyszy – w osadzie (przykład ②). Dlatego w takich przypadkach konieczne jest określenie odpowiednich kombinacji dysz i osad Bosch eXchange w aplikacji zamontowanej dyszy. W niektórych przypadkach, w związku z racjonalizacją produkcji, można przyporządkować liczne kombinacje dysz z osadami (przykład ③) do jednej i tej samej wymiennej kombinacji dyszy z osadą. Numery katalogowe, których nie podano, nie zostały objęte programem wymiany.

ru





**Сочетания держателей форсунок:**

справка по декодированию

**Просим учитывать!**

Указав только обозначение типа оригинального держателя форсунки Bosch и давление впрыскивания, не всегда возможно определить соответствующий № для заказа сочетания держателей форсунок Bosch eXchange. Различие заключается либо в установленной форсунке (пример ①), либо в ином держателе форсунки при одинаковой форсунке (пример ②). Поэтому в данных случаях обязательно требуется определить соответствующие сочетания держателей форсунок Bosch eXchange по транспортному средству, в применяемой детали. Если это невозможно, то в данных случаях необходимо демонтировать старое сочетание держателей форсунок, чтобы определить установленную форсунку по обозначению типа держателя форсунки и давлению начала впрыскивания. В некоторых случаях, при принятии рационализаторских мер во время производства, можно соотнести несколько сочетаний держателей форсунок (пример ③) с одним и тем же заменяемым сочетанием держателей форсунок. Не указанные № для заказа не включены в программу замены.

**Exemplo de recodificação****Exempel för omkodning****Esimerkki uudelleenkodeauksesta****Przykład konwersji****Пример декодирования**

	 Typ	 Typ	 bar	 bar	 eXchange
①	KCA 30 S 44	DN 0 SD 261	115	0 432 217 131	<b>0 986 430 022</b>
	KCA 30 S 44	DN 0 SD 265	115	0 432 217 141	<b>0 986 430 025</b>
	KCA 30 S 44	DN 0 SD 220	115	0 432 217 142	<b>0 986 430 020</b>
②	KCE 27 S 3	DN 0 SD 310	115	0 432 217 253	<b>0 986 430 245</b>
	KCA 27 S 55	DN 0 SD 310	115	0 432 217 262	<b>0 986 430 246</b>
③	KDAL 80 S 47	DLLA 140 S 1003	200	0 432 231 680	<b>0 986 430 038</b>
	KDAL 80 S 42	DLLA 140 S 1003	200	0 432 231 764	<b>0 986 430 038</b>
	KDAL 80 S 14/14	DLLA 144 S 8200	175	0 432 231 797	<b>0 986 430 038</b>

de

**Düsenhalter-  
kombinationen**Gegenüberstellung:  
Typformel Düsen-  
halter → Bosch  
eXchange

en

**Nozzle-and-holder  
assemblies**Cross-reference:  
Type formula nozzle-  
holder → Bosch  
eXchange

fr

**Ensembles porte-  
injecteurs**Table de correspon-  
dance : Formule de  
type Porte-injecteur  
→ Bosch eXchange

it

**Gruppi porta-  
polverizzatore**Confronto: Sigla  
portapolverizzatore  
→ Bosch eXchange

es

**Conjuntos inyectores**Equivalencias:  
Fórmula de tipo  
portainyector →  
Bosch eXchange**KBAL ...**

KBAL 100 S 52	DLLA 154 S 970	230...238	0 432 291 672	<b>0 986 430 336</b>
KBAL 116 S 66	DLLA 140 S 1054	265...273	0 432 291 635	<b>0 986 430 169</b>
KBAL 116 S 75	DLLA 148 S 1272	240...248	0 432 291 534	<b>0 986 430 301</b>
KBAL 65 S 13/13	DLLA 149 S 774	180...188	0 432 291 753	<b>0 986 430 067</b>
KBAL 96 P 35	DLLA 158 P 456/	260...270	0 432 191 655	<b>0 986 430 490</b>

**KBE ...**

KBE 58 S 8	DN 0 SD 301	120...128	0 432 297 057	<b>0 986 430 532</b>
------------	-------------	-----------	---------------	----------------------

**KBEL ...**

KBEL 100 P 123	DLLA 144 P 510	320...328	0 432 191 633	<b>0 986 430 352</b>
KBEL 100 P 202	DLLA 149 P 541	320...328	0 432 191 616	<b>0 986 430 348</b>
KBEL 100 P 64	DLLA 148 P 513	320...328	0 432 191 630	<b>0 986 430 349</b>
KBEL 109 P 11/13	DLLA 150 P 91/	305...313	0 432 192 881	<b>0 986 430 034</b>
KBEL 109 P 81	DSLA 145 P 300	240...252	0 432 193 845	<b>0 986 430 256</b>
KBEL 109 S 6/13	DLLA 150 S 853	255...263	0 432 292 881	<b>0 986 430 074</b>
KBEL 110 P 140	DSLA 134 P 604	240...252	0 432 193 757	<b>0 986 430 522</b>
KBEL 117 P 122	DLLA 150 P 555	260...268	0 432 191 611	<b>0 986 430 370</b>
KBEL 117 P 122	DLLA 152 P 571	260...268	0 432 191 612	<b>0 986 430 369</b>
KBEL 117 P 7/4	DLLA 148 P 149	260...268	0 432 191 788	<b>0 986 430 167</b>
KBEL 117 P 7/4	DLLA 150 P 110	265...273	0 432 191 815	<b>0 986 430 164</b>
KBEL 117 P 7/4	DLLA 150 P 177	260...268	0 432 191 771	<b>0 986 430 166</b>
KBEL 117 P 7/4	DLLA 150 P 178	260...268	0 432 191 770	<b>0 986 430 165</b>
KBEL 117 P 7/4	DLLA 150 P 31	275...283	0 432 191 863	<b>0 986 430 032</b>
KBEL 117 P 7/4	DLLA 150 P 52	265...277	0 432 191 848	<b>0 986 430 000</b>
KBEL 117 P 73	DLLA 152 P 285	260...268	0 432 191 737	<b>0 986 430 353</b>
KBEL 117 P 73	DLLA 152 P 313	260...268	0 432 191 730	<b>0 986 430 263</b>
KBEL 117 P 73	DLLA 152 P 339	260...268	0 432 191 715	<b>0 986 430 354</b>
KBEL 95 P 9/4	DLLA 143 P 40	275...283	0 432 191 854	<b>0 986 430 002</b>
KBEL 98 P 101	DLLA 145 P 466	245...253	0 432 191 658	<b>0 986 430 498</b>
KBEL 98 P 102	DLLA 145 P 286	255...267	0 432 191 529	<b>0 986 430 491</b>
KBEL 98 P 102	DLLA 145 P 433	260...268	0 432 191 669	<b>0 986 430 364</b>
KBEL 98 P 102	DLLA 145 P 504	260...268	0 432 191 634	<b>0 986 430 368</b>
KBEL 98 P 27	DLLA 143 P 93	255...263	0 432 191 825	<b>0 986 430 163</b>
KBEL 98 P 27	DLLA 143 P 96	265...273	0 432 191 822	<b>0 986 430 162</b>
KBEL 98 P 74	DLLA 145 P 328	260...268	0 432 191 724	<b>0 986 430 311</b>

**KCA ...**

KCA 17 S 42	DN 0 SD 299	175...180	0 432 217 218	<b>0 986 430 240</b>
KCA 17 S 42	DN 0 SD 299 A	130...135	0 432 217 248	<b>0 986 430 244</b>
KCA 17 S 42	DN 0 SD 299 C	175...180	0 432 217 289	<b>0 986 430 375</b>
KCA 17 S 70	DN 0 SD 301	150...158	0 432 217 222	<b>0 986 430 249</b>
KCA 21 S 71	DN 0 SD 300	154...162	0 432 217 223	<b>0 986 430 241</b>
KCA 21 S 71	DN 0 SD 318	154...162	0 432 217 278	<b>0 986 430 302</b>
KCA 27 S 55	DN 0 SD 261	115...123	0 432 217 161	<b>0 986 430 172</b>
KCA 27 S 55	DN 0 SD 265	115...123	0 432 217 157	<b>0 986 430 197</b>
KCA 27 S 55	DN 0 SD 265	135...143	0 432 217 169	<b>0 986 430 173</b>
KCA 27 S 55	DN 0 SD 310	115...123	0 432 217 262	<b>0 986 430 246</b>
KCA 27 S 55	DN 0 SD 314	135...143	0 432 217 266	<b>0 986 430 247</b>
KCA 27 S 77	DN 0 SD 308	150...158	0 432 217 243	<b>0 986 430 206</b>
KCA 27 S 77	DN 0 SD 308	150...158	0 432 217 244	<b>0 986 430 206</b>
KCA 27 S 77/	DN 0 SD 308	150...158	0 432 217 283	<b>0 986 430 206</b>
KCA 27 S 77/	DN 0 SD 308	150...158	0 432 217 284	<b>0 986 430 206</b>
KCA 27 S 80	DN 0 SD 322	135...143	0 432 217 299	<b>0 986 430 449</b>

pt

**conjuntos porta-injectores**

Confrontação:  
designação porta-injector → Bosch eXchange

sv

**Munstyckshållar-kombinationer**

jämförelse: Typformel  
Munstyckshållare → Bosch eXchange

fi

**Suutinpidin-yhdistelmien**

vertailu: Tyyprikaava  
Suutinpidin → Bosch eXchange

pl





**Zestawienie kombinacji**

dyszy z obsadą:  
Formuła typu Obsada dyszy → Bosch eXchange

ru

**Сочетания держателей форсунок**

Сопоставление:  
обозначение типа держателя форсунки → Bosch eXchange

 Typ	 Typ	 bar		 eXchange
KCA 30 S 36/4	DN 0 SD 293	155...163	0 432 217 078	<b>0 986 430 080</b>
KCA 30 S 36/4	DN 0 SD 293	155...163	0 432 217 079	<b>0 986 430 080</b>
KCA 30 S 44	DN 0 SD 293	130...138	0 432 217 083	<b>0 986 430 081</b>
KCA 30 S 44	DN 0 SD 294	130...138	0 432 217 198	<b>0 986 430 189</b>
KCA 30 S 44	DN 0 SD 293	130...138	0 432 217 084	<b>0 986 430 081</b>
KCA 30 S 44	DN 0 SD 294	130...138	0 432 217 207	<b>0 986 430 189</b>
KCA 30 S 44	DN 0 SD 220	115...123	0 432 217 142	<b>0 986 430 020</b>
KCA 30 S 44	DN 0 SD 261	115...123	0 432 217 131	<b>0 986 430 022</b>
KCA 30 S 44	DN 0 SD 265	115...123	0 432 217 141	<b>0 986 430 025</b>
KCA 30 S 44	DN 0 SD 320	130...138	0 432 217 293	<b>0 986 430 520</b>
KCA 30 S 46	DN 0 SD 240/	115...123	0 432 217 125	<b>0 986 430 151</b>
KCA 30 S 79	DN 0 SD 297	130...138	0 432 217 239	<b>0 986 430 187</b>
KCA 30 S 79	DN 0 SD 297	155...163	0 432 217 241	<b>0 986 430 188</b>
KCA 30 S 79	DN 0 SD 297	130...138	0 432 217 271	<b>0 986 430 187</b>
KCA 30 S 79	DN 0 SD 297	130...138	0 432 217 240	<b>0 986 430 187</b>
KCA 30 S 79	DN 0 SD 297	155...163	0 432 217 242	<b>0 986 430 188</b>
KCA 30 S 79	DN 0 SD 297	130...138	0 432 217 272	<b>0 986 430 187</b>
KCA 30 SD 27/4	DN 0 SD 220	115...123	0 432 217 054	<b>0 986 430 020</b>
<b>KCE ...</b>				
KCE 27 S 3	DN 0 SD 310	115...123	0 432 217 253	<b>0 986 430 245</b>
KCE 27 S 3	DN 0 SD 310	135...143	0 432 217 280	<b>0 986 430 388</b>
KCE 27 S 3	DN 0 SD 319	115...123	0 432 217 287	<b>0 986 430 307</b>
KCE 30 S 5	DN 0 SD 312	140...145	0 432 217 268	<b>0 986 430 381</b>
<b>KDAL ...</b>				
KDAL 74 S 21/19	DLLA 142 S 792	200...210	0 432 231 823	<b>0 986 430 045</b>
KDAL 74 S 21/19	DLLA 150 S 187	200...210	0 432 231 887	<b>0 986 430 056</b>
KDAL 74 S 44	DLLA 134 S 1201	240...250	0 432 231 713	<b>0 986 430 210</b>
KDAL 74 S 44	DLLA 137 S 1157	200...210	0 432 231 724	<b>0 986 430 221</b>
KDAL 74 S 44	DLLA 142 S 1096	200...210	0 432 231 736	<b>0 986 430 178</b>
KDAL 74 S 44	DLLA 142 S 1173	200...210	0 432 231 722	<b>0 986 430 214</b>
KDAL 74 S 44	DLLA 142 S 1257	200...210	0 432 231 688	<b>0 986 430 221</b>
KDAL 80 S 14/14	DLLA 144 S 8200	175...183	0 432 231 797	<b>0 986 430 038</b>
KDAL 80 S 42	DLLA 136 S 1034	200...208	0 432 231 760	<b>0 986 430 168</b>
KDAL 80 S 42	DLLA 140 S 1003	200...208	0 432 231 764	<b>0 986 430 038</b>
KDAL 80 S 46	DLLA 134 S 1199	200...208	0 432 231 714	<b>0 986 430 211</b>
KDAL 80 S 46	DLLA 134 S 999	200...208	0 432 231 766	<b>0 986 430 133</b>
KDAL 80 S 46	DLLA 138 S 1191	200...208	0 432 231 717	<b>0 986 430 205</b>
KDAL 80 S 47	DLLA 134 S 1199	200...208	0 432 231 677	<b>0 986 430 211</b>
KDAL 80 S 47	DLLA 134 S 999	200...208	0 432 231 704	<b>0 986 430 133</b>
KDAL 80 S 47	DLLA 136 S 1034	200...208	0 432 231 703	<b>0 986 430 168</b>
KDAL 80 S 47	DLLA 138 S 1191	200...210	0 432 231 678	<b>0 986 430 205</b>
KDAL 80 S 47	DLLA 140 S 1003	200...208	0 432 231 680	<b>0 986 430 038</b>
KDAL 80 S 56	DLLA 136 S 943	235...243	0 432 231 778	<b>0 986 430 159</b>
KDAL 80 S 59	DLLA 131 S 1131	200...210	0 432 231 674	<b>0 986 430 508</b>
KDAL 80 S 59	DLLA 140 S 1003	175...185	0 432 231 673	<b>0 986 430 507</b>
<b>KDEL ...</b>				
KDEL 109 P 62	DLLA 147 P 538	275...283	0 432 131 703	<b>0 986 430 390</b>
KDEL 75 P 16	DLLA 149 P 514	320...328	0 432 131 767	<b>0 986 430 347</b>
KDEL 77 P 59	DLLA 144 P 666	320...328	0 432 131 714	<b>0 986 430 511</b>
KDEL 80 P 33	DLLA 142 P 418	265...275	0 432 131 726	<b>0 986 430 326</b>
KDEL 80 P 33	DLLA 142 P 419	265...275	0 432 131 728	<b>0 986 430 327</b>
KDEL 80 P 33	DLLA 142 P 479	235...245	0 432 131 781	<b>0 986 430 361</b>
KDEL 82 P 12	DLLA 146 P 1311/	295...303	0 432 131 857	<b>0 986 430 321</b>



**A14**

**de**

**Düsenhalter-kombinationen**

Gegenüberstellung:  
Typformel Düsenhalter → Bosch eXchange  
(Fortsetzung)

**en**

**Nozzle-and-holder assemblies**

Cross-reference:  
Type formula nozzle-holder → Bosch eXchange  
(continued)

**fr**

**Ensembles porte-injecteurs**

Table de correspondance : Formule de type Porte-injecteur → Bosch eXchange  
(suite)

**it**





**Gruppi portapolverizzatore**

Confronto: Sigla portapolverizzatore → Bosch eXchange  
(seguito)

**es**

**Conjuntos inyectores**

Equivalencias:  
Fórmula de tipo portainyector → Bosch eXchange  
(continuación)

 Typ	 Typ	 bar		 eXchange
KDEL 82 P 12	DLLA 152 P 452	320...328	0 432 131 788	<b>0 986 430 312</b>
KDEL 82 P 12	DLLA 152 P 531	320...328	0 432 131 760	<b>0 986 430 451</b>
KDEL 82 P 18	DLLA 134 P 422	260...270	0 432 131 798	<b>0 986 430 261</b>
KDEL 82 P 18	DLLA 134 P 430	260...270	0 432 131 794	<b>0 986 430 252</b>
KDEL 82 P 23	DLLA 134 P 180	265...273	0 432 131 820	<b>0 986 430 257</b>
KDEL 82 P 38	DSLA 154 P 492/	270...278	0 432 133 855	<b>0 986 430 313</b>
KDEL 82 P 7	DLLA 144 P 184	295...303	0 432 131 860	<b>0 986 430 196</b>
KDEL 82 P 7	DLLA 144 P 184/	280...294	0 432 131 667	<b>0 986 430 196</b>
KDEL 82 P 7	DLLA 144 P 184/	295...303	0 432 131 853	<b>0 986 430 196</b>
KDEL 82 P 7	DLLA 146 P 166	295...303	0 432 131 866	<b>0 986 430 228</b>
KDEL 82 P 7	DLLA 146 P 166/	295...303	0 432 131 831	<b>0 986 430 228</b>
KDEL 95 S 21	DLLA 160 S 1305	255...263	0 432 231 667	<b>0 986 430 330</b>
KDEL 97 P 10	DLLA 142 P 221	305...313	0 432 131 850	<b>0 986 430 031</b>
KDEL 97 P 10	DLLA 146 P 154-	305...313	0 432 131 871	<b>0 986 430 120</b>
KDEL 97 P 13	DLLA 155 P 230	305...313	0 432 131 846	<b>0 986 430 274</b>
KDEL 97 P 13	DLLA 155 P 306	265...273	0 432 131 825	<b>0 986 430 213</b>
KDEL 97 P 3	DLLA 142 P 87	305...313	0 432 131 878	<b>0 986 430 031</b>
KDEL 99 P 15	DLLA 155 P 307	260...268	0 432 131 824	<b>0 986 430 212</b>
KDEL 99 P 39	DLLA 150 P 573	285...293	0 432 131 751	<b>0 986 430 387</b>
KDEL 99 P 39	DLLA 152 P 496	315...323	0 432 131 773	<b>0 986 430 385</b>
KDEL 99 P 5	DLLA 144 P 144	305...313	0 432 131 873	<b>0 986 430 030</b>

pt

**conjuntos porta-injectores**

Confrontação:  
designação porta-injector → Bosch eXchange  
(continuação)

sv

**Munstyckshållarkombinationer**

Jämförelse: Typformel  
Munstyckshållare → Bosch eXchange  
(fortsättning)

fi

**Suutinpidin-yhdistelmien**

vertailu: Tyypikaava  
Suutinpidin → Bosch eXchange  
(jatkoa)

pl

**Zestawienie kombinacji**

dyszy z obsadą:  
Formuła typu Obsada dyszy → Bosch eXchange  
(kontynuacja)





ru

**Сочетания держателей форсунок**

Сопоставление:  
обозначение типа держателя форсунки → Bosch eXchange  
(продолжение)



de	en	fr	it	es
Dichtringe und Wärmeschutzscheiben für Düsenhalterkombinationen	Sealing washers and thermal-protection discs for nozzle-and-holder assemblies	Joints d'étanchéité et vitres pare-chaleur pour ensembles porte-injecteurs	Anelli di tenuta e rondelle termo-isolanti per gruppi portapolverizzatore	Anillos de junta y arandelas calorífugas para conjuntos inyectoros

			
0 986 430 000		<b>1 460 105 313*</b>	-
0 986 430 002		<b>1 460 105 313*</b>	-
0 986 430 020		-	<b>2 430 501 004</b>
0 986 430 022		-	<b>2 430 501 004</b>
0 986 430 025		-	<b>2 430 501 004</b>
0 986 430 030		-	<b>2 430 105 026</b>
0 986 430 031		-	<b>F 00V C17 503</b>
0 986 430 032		<b>1 460 105 313*</b>	-
0 986 430 034		<b>1 460 105 313*</b>	<b>2 430 105 026</b>
0 986 430 038		-	<b>2 430 105 020*</b>
0 986 430 045		<b>1 460 105 313*</b>	-
0 986 430 046		<b>1 460 105 313*</b>	-
0 986 430 056		<b>1 460 105 313*</b>	<b>2 430 105 020*</b>
0 986 430 067		<b>1 460 105 313*</b>	<b>2 430 105 020</b>
0 986 430 074		<b>1 460 105 313*</b>	<b>2 430 105 020</b>
0 986 430 080		-	<b>1 410 501 072</b>
0 986 430 081		-	<b>1 410 501 072</b>
0 986 430 133		<b>1 460 105 313*</b>	<b>2 430 105 020*</b>
0 986 430 151		-	<b>2 430 501 009</b>
0 986 430 159		<b>2 916 710 602</b>	<b>2 430 105 020</b>
0 986 430 162		<b>2 916 710 602</b>	<b>2 430 105 026*</b>
0 986 430 163		<b>2 916 710 602</b>	<b>2 430 105 026*</b>
0 986 430 164		<b>1 460 105 313*</b>	<b>2 430 105 026*</b>
0 986 430 165		<b>1 460 105 313*</b>	<b>2 430 105 026*</b>
0 986 430 166		<b>1 460 105 313*</b>	<b>2 430 105 026*</b>
0 986 430 167		<b>1 460 105 313*</b>	<b>2 430 105 026*</b>
0 986 430 168		<b>1 460 105 313*</b>	<b>2 430 105 020*</b>
0 986 430 169		<b>1 460 105 313*</b>	<b>2 430 105 020*</b>
0 986 430 172		-	<b>2 430 501 011</b>
0 986 430 173		-	<b>2 430 501 011</b>
0 986 430 178		<b>1 460 105 313*</b>	<b>2 430 105 020*</b>
0 986 430 187		-	<b>1 410 501 072</b>
0 986 430 188		-	<b>1 410 501 072</b>
0 986 430 189		-	<b>1 410 501 072</b>
0 986 430 196		<b>2 916 710 602</b>	-
0 986 430 197		-	<b>2 430 501 011</b>
0 986 430 206		-	<b>1 410 501 072</b>
0 986 430 210		<b>1 460 105 313*</b>	-
0 986 430 214		<b>1 460 105 313*</b>	-
0 986 430 221		<b>1 460 105 313*</b>	-
0 986 430 245		-	<b>2 430 501 011</b>
0 986 430 246		-	<b>2 430 501 011</b>
0 986 430 247		-	<b>2 430 501 011</b>
0 986 430 307		-	<b>2 430 501 011</b>
0 986 430 388		-	<b>2 430 501 011</b>



- \* nicht im Lieferumfang
- \* Not included in delivery
- \* Non compris dans la livraison
- \* Non compreso nel volume di fornitura
- \* No se incluye en el suministro
- \* não incluído no volume de entrega
- \* ingår inte i leveransen
- \* ei sisälly toimitukseen
- \* nie załączono
- \* не входит в комплект поставки





de

Wärmeschutz für Düsen

en

Thermal protection for nozzles

fr

Protection thermique pour injecteurs

it

Isolamento termico per polverizzatori

es

Protección antitérmica para inyectoros



Wärmeschutzhülsen für Lochdüsen

Thermal-protection sleeves for hole-type nozzles

Douilles calorifuges pour injecteurs à trous

Bussole di isolamento termico per polverizzatori a fori

Manguitos de protección antitérmica para inyectoros de orificio

Mangas de protecção térmica para injectores de orificio

Värmeskyddshylsor för hålmunstycken

Lämmönsuojaholkit reikäsuuttimiin

Tuleje termoizolacyjne do dysz otworkowych

Теплозащитные втулки для бесштифтовых форсунок

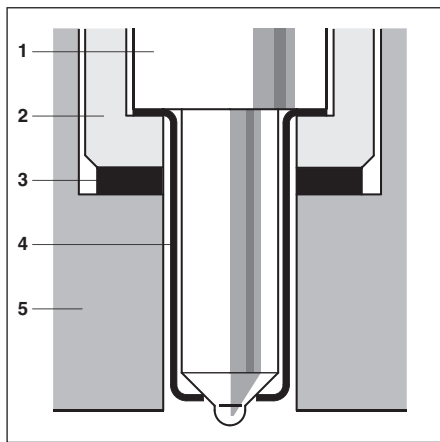
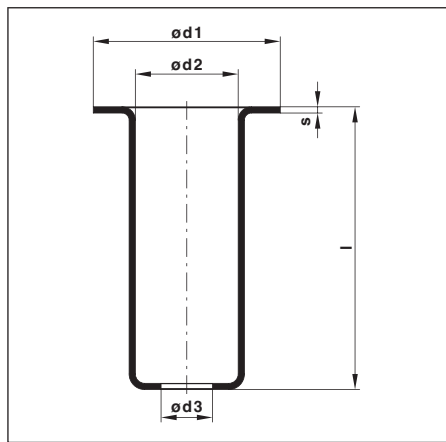

- 3** Dichtscheibe  
Sealing disc  
Joint  
Rosetta di tenuta  
Junta  
Anilha  
Tättningsbricka  
Tiivistelevy  
Uszczelka  
Уплотнительная шайба

d1 mm	d2 mm	d3 mm	l mm	s mm	
13,6	9,5	6,2	25,0	0,5	<b>2 430 422 011</b>
14,9	7,18	6,94	17,4	1,5	<b>F 00Z W00 003</b>
15,5	9,5	6,2	24,6	0,5	<b>2 430 422 004</b>
16,5	9,5	6,2	25,0	0,5	<b>2 430 422 005</b>
21,0	9,3	9,0	17,3	2,0	<b>2 430 422 002</b>

- 1** Lochdüse  
Hole-type nozzle  
Injecteur à trous  
Polverizzatore a fori  
Inyector de orificio  
Injector de orificio  
Hålmunstycke  
Reikäsuutin  
Dysza otworkowa  
Бесштифтовая форсунка

- 4** Wärmeschutzhülse  
Thermal-protection sleeve  
Douille calorifuge  
Bussole di isolamento termico  
Manguito de protección antitérmica  
Manga de protecção térmica  
Värmeskyddshylsa  
Lämmönsuojaholkit  
Tuleja termoizolacyjna  
Теплозащитная втулка

- 2** Düsenspannmutter  
Nozzle-retaining nut  
Ecrou-raccord d'injecteur  
Dado bloccapolverizzatore  
Tuerca de sujeción de inyector  
Porca de fixação do injector  
Munstycksspännmutter  
Suuttimen kiristysmutteri  
Nakrętka mocująca dyszy  
Накидная гайка крепления форсунки

- 5** Zylinderkopf  
Cylinder head  
Culasse  
Testata  
Culata  
Cabeça do motor  
Cylinderlock  
Sylinderinkansi  
Głowica cylindra  
Головка блока цилиндров

pt

Protecção térmica  
para injectores

sv

Värmeskydd för  
munstycken

fi

Suuttimien  
lämmönsuoja

pl

Izolacja cieplna  
dysz

ru

Теплозащита  
форсунок

Dichtscheiben für Düsenhalter/CRI mit Loch- und Zapfendüsen

Sealing discs for nozzle-holders/CRI with hole-type and pintle nozzles

Joints pour porte-injecteurs/CRI avec injecteurs à trous ou à téton

Rosette di tenuta per portapolverizzatori/CRI con polverizzatori a fori e polverizzatori a pernetto

Juntas para portainyectores/CRI con inyectores de orificio e inyectores de espiga

Anilhas para porta-injector/CRI com inyectores de orificio e de pino

Tättningsbrickor för munstyckshållare/CRI med hål- och tappmunstycken

Tiivistelevyt suutinpitimiin/CRI, joissa reikä- ja tappisuuttimet

Podkładki uszczelniające do obsady dyszy/CRI z dyszami otworkowymi i czopikowymi

Уплотнительные шайбы для держателей форсунок/CRI с бесштифтовыми и штифтовыми форсунками

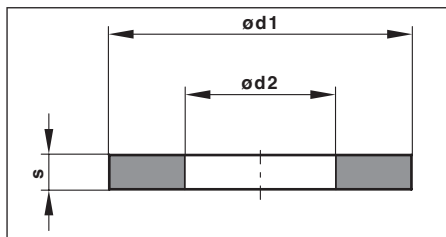

d1 mm	d2 mm	s mm	
13,0	7,0	1,5	F 00V P01 004
13,0	7,0	2,5	F 00V C17 505
14,0	7,3	1,0	F 002 C71 401
14,0	7,3	2,0	9 431 030 172
14,0	7,3	3,8	9 431 030 171
14,4	7,0	1,5	F 00R J02 175
15,0	7,0	1,5	F 00V C17 503
15,0	7,0	1,5	F 00R J01 453
15,0	7,0	2,0	F 00V C17 504
15,0	7,0	2,0	F 00R J01 086
15,0	7,3	0,5	2 430 105 048
15,0	7,3	2,0	2 430 105 035
15,0	7,3	2,5	2 430 105 042
15,0	7,3	3,0	2 430 105 043
15,0	9,2	1,5	2 430 105 026
15,1	7,0	1,5	2 430 105 049
15,5	9,3	2,0	2 430 105 023
16,0	7,75	1,3	2 430 105 057
16,0	7,75	1,5	2 430 105 055
18,0	11,5	1,5	F 002 C71 402
18,8	9,7	2,0	2 430 105 020
19,3	7,3	2,0	9 432 030 111
19,3	9,7	1,6	2 430 100 048
19,3	9,7	2,0	2 439 105 020
19,3	14,3	2,0	2 430 105 012
19,3	14,3	2,0	9 431 030 161
20,4	15,7	2,0	2 430 105 010
21,0	17,2	1,5	2 430 105 045
21,1	17,4	2,3	2 430 105 044
21,5	15,7	2,0	2 430 105 011
24,0	18,2	2,0	1 410 105 005
24,5	16,6	2,0	9 431 030 119
25,9	22,2	1,5	2 430 105 027
35,0	28,0	1,0	3 410 105 603

de

**Wärmeschutz  
für Düsen**  
(Fortsetzung)

en

**Thermal protection  
for nozzles**  
(continued)

fr

**Protection thermique  
pour injecteurs**  
(suite)

it

**Isolamento termico  
per pulverizzatori**  
(seguito)

es

**Protección antitérmica  
para inyectores**  
(continuación)



**Wärmeschutzscheiben für Drosselzapfendüsen**

**Thermal-protection discs for throttling pintle nozzles**

**Rondelles calorifuges pour injecteurs à téton et étranglement**

**Rosette di isolamento termico per pulverizzatori a pernetto strozzato**

**Arandelas de protección antitérmica para inyectores de espiga con efecto estrangulador**

**Anilhas de protecção térmica para inyectores de espiga**

**Värmeskyddsbrickor för stryptappmunstycken**

**Lämmönsuojalevyt kuristintappisuuttimiin**

**Podkładki termoizolacyjne do dysz czopikowych dławiących**

**Теплозащитные шайбы для штифтовых форсунок с дроссельной иглой**

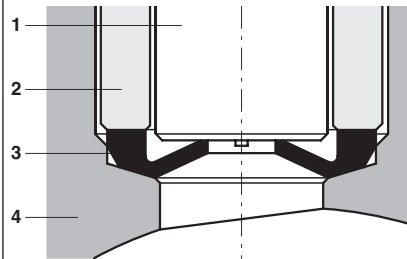

**1 Drosselzapfendüse**

Throttling pintle nozzle  
Injecteur à téton et étranglement  
Polverizzatore a pernetto strozzato  
Inyector de espiga con efecto estrangulador  
Injector de espiga  
Stryptappmunstycke  
Kuristintappisuutin  
Dysza czopikowa dławiąca  
Штифтовая форсунка с дроссельной иглой

**2 Düsenspannmutter**

Nozzle-retaining nut  
Ecrou-raccord d'injecteur  
Dado bloccapolverizzatore  
Tuerca de sujeción de inyector  
Porca de fixação do inyector  
Munstycksspännmutter  
Suuttimen kiristysmutteri  
Nakrętka mocująca dyszy  
Накидная гайка крепления форсунки

**3 Wärmeschutzscheibe**

Thermal-protection disc  
Rondelle calorifuge  
Rosetta isolamento termico  
Arandela de protección antitérmica  
Anilha de protecção térmica  
Värmeskyddsbricka  
Lämmönsuojalevy  
Podkładka termoizolacyjna  
Теплозащитная шайба

**4 Zylinderkopf**

Cylinder head  
Culasse  
Testata  
Culata  
Cabeça do motor  
Cylinderlock  
Sylinderinkansi  
Głowica cylindra  
Головка блока цилиндров

pt

**Protecção térmica  
para injectores**  
(continuação)

sv

**Värmeskydd för  
munstycken**  
(fortsättning)

fi

**Suuttimien  
lämmönsuoja**  
(jatkoa)

pl

**Izolacja cieplna  
dysz**  
(kontynuacja)

ru

**Теплозащита  
форсунок**  
(продолжение)

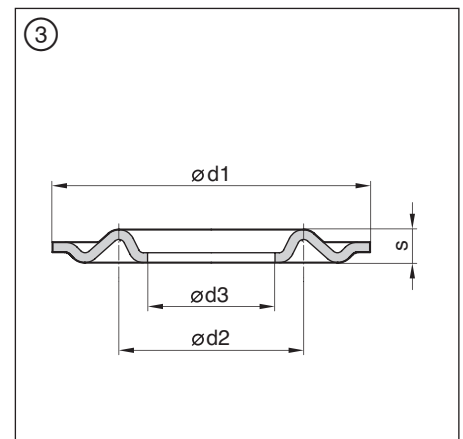
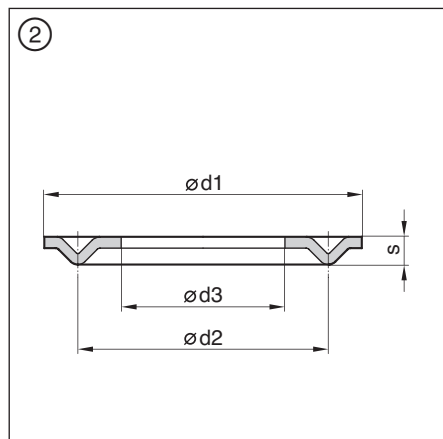
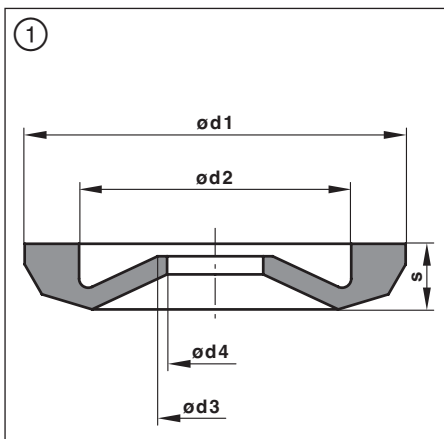

① ② ③

d1 mm	d2 mm	d3 mm	d4 mm	s mm	
11,2	5,5	3,0	–	1,35	<b>2 430 190 101</b>
13,8	8,0	5,5	–	1,35	<b>2 430 190 010</b>
13,8	10,0	6,5	–	1,35	<b>2 430 190 002</b>
20,1	14,5	11,7	10,0	2,6	<b>2 430 501 009</b>
20,1	14,6	8,8	7,7	2,6	<b>2 430 501 011</b>
20,3	14,5	–	5,30*	3,5	<b>1 410 501 072</b>

\* innen/inside/intérieur/interno/interior/interior/invändigt/sisä/wewnątrz/внутри





de	en	fr	it	es
<p><b>Verwendungsteil</b></p> <p><b>Benutzerhinweise</b></p> <p>In diesem Katalog sind die Daten von Fahrzeugen, Motoren und Geräten für den europäischen Markt von Baujahr 1996 bis einschließlich 2016 erfasst. Diese wurden aus Hersteller- und Importeurangaben, aus Fahrzeuguntersuchungen sowie aus Unterlagen von Bosch nach bestem Wissen sorgfältig zusammengestellt und geben den Stand zum Zeitpunkt der Drucklegung wieder.</p> <p>Zwangsläufige Abweichungen durch länderspezifische technische Änderungen können nie ganz ausgeschlossen werden. Bosch kann daher insoweit nicht für die Vollständigkeit und Fehlerfreiheit der Daten haften. Für Irrtümer und Druckfehler, die zu Schäden am Eigentum oder Vermögen führen, haftet Bosch nur bei grob fahrlässiger Pflichtverletzung und bei Vorsatz für unmittelbare Schäden. Bei Personenschäden haftet Bosch auch bei leichter Fahrlässigkeit.</p>	<p><b>Applications</b></p> <p><b>Notes for users</b></p> <p>This catalog contains the data from the vehicles, engines, and equipment for the European market from year of manufacture 1996 up to and including the year 2016. This data has been assembled from information provided by manufacturers and importers, and taken from Bosch documentation, as well as from investigations made on vehicles. It has been compiled to the best of our knowledge and belief, and reflects the status at the date of going to print.</p> <p>Inevitable deviations due to country-specific technical changes can never be completely excluded. Therefore, Bosch in this respect cannot be responsible for the completeness and accuracy of the data. For mistakes and misprint, which lead to damage of property or fortune, Bosch is responsible only in case of grossly negligent violation of duties and in case of intention for direct damage. In case of personal injury, Bosch is also liable concerning slight negligence.</p>	<p><b>Affectations</b></p> <p><b>A l'attention de l'utilisateur</b></p> <p>Le présent catalogue mentionne les données spécifiques de véhicules, moteurs et appareils pour le marché européen depuis l'année de fabrication 1996 jusqu'au millésime 2016 inclus. Ces informations ont été rassemblées soigneusement et en toute impartialité à partir des indications des constructeurs et importateurs, des contrôles techniques des véhicules et de la documentation Bosch, et matérialisent le stade des connaissances au moment de la mise sous presse.</p> <p>Des écarts inévitables ne peuvent jamais être complètement exclus en raison des différences spécifiques à chaque pays. Bosch ne peut donc pas à cet égard être tenu responsable de l'exactitude des données. Pour des erreurs et fautes d'impression, qui causeraient des dégâts matériels, Bosch est responsable seulement en cas de violation de ses obligations par faute lourde intentionnelle en ce qui concerne les dommages matériels. En cas de dommages corporels, Bosch peut être également tenu pour responsable dans les cas de faute légère.</p>	<p><b>Impiego</b></p> <p><b>Avvertenze per la consultazione</b></p> <p>Nella seguente parte di catalogo sono contemplati veicoli, motori ed apparecchi a partire dall'anno di costruzione 1996 fino all'anno 2016. Tali informazioni sono state rilevate dalle documentazioni di Case Auto, Importatori, da verifiche eseguite sui veicoli, così come da documentazione Bosch.</p> <p>Eventuali discordanze, dovute a variazioni delle caratteristiche tecniche per specifici Paesi, non possono essere contemplate. Bosch non potrà quindi essere considerata responsabile per mancanze o inesattezze dei dati. Per eventuali danni a cose o danni patrimoniali, dovuti ad errori o refusi di stampa, Bosch è responsabile solo in caso di dolo o colpa grave. In caso di danni alla persona, Bosch è responsabile anche in caso di colpa meno grave.</p>	<p><b>Aplicación</b></p> <p><b>Instrucciones para el usuario</b></p> <p>Los datos de este catálogo para vehículos, motores y utensilios del mercado europeo comprenden los años de construcción desde 1996 hasta 2016 inclusive. Éstos son creados para la edición indicada sobre la base de documentos de Bosch, exámenes o inspecciones de vehículos así como datos de fabricantes e importadores.</p> <p>Las diferentes especificaciones técnicas propias de cada país nunca pueden ser excluidas completamente. Por lo tanto, Bosch en este aspecto, no puede ser responsable de la absoluta exactitud de los datos. En el caso de errores, incluidos los de imprenta, que generen daños ó pérdidas de la propiedad o posesiones, Bosch es responsable únicamente en los casos de violación negligente de sus obligaciones y en el supuesto de intención o dolo para el daño directo. Bosch está también obligado a responder en casos de injurias personales por negligencia.</p>
<p><b>pt</b></p> <p><b>Utilização</b></p> <p><b>Instruções para o utilizador</b></p> <p>Na parte do catálogo que se segue encontram-se registados veículos, motores e aparelhos até ao ano de 2016 inclusive e, retroactivamente, até ao ano de fabrico de 1996. Não nos responsabilizamos por quaisquer alterações do equipamento efectuadas pelos fabricantes do veículo, dos motores e dos aparelhos ou pelos fabricantes de produtos de outras marcas.</p> <p>Não é, de todo, possível excluir a existência de discrepâncias decorrentes de alterações técnicas específicas dos diversos países. Nesta medida, a Bosch não pode garantir que os dados sejam completos e isentos de erros. A Bosch não se responsabiliza por erros, omissões e erros de impressão, que conduzam a perdas e danos, excepto nos casos de danos resultantes directamente de negligência grave ou dolo. Em caso de danos pessoais, a Bosch responsabiliza também por danos resultantes de negligência simples.</p>	<p><b>sv</b></p> <p><b>Användningsdel</b></p> <p><b>Användarvägledning</b></p> <p>I denna katalog finns data angivna för fordon, motorer och apparater för den europeiska marknaden från årsmodell 1996 till och med 2016. Uppgifterna kommer från tillverkarna och importörerna, från fordonsundersökningar och från underlag från Bosch och är omsorgsfullt sammanställda enligt tillgänglig kunskap och anger läget vid tryckningstidpunkten.</p> <p>I vissa länder kan specifi ka avvikelser förekomma p. g. a. tekniska ändringar varför Bosch ej kan hållas ansvarig för ej komplett information. Vid fel som leder till direkt skada på egendom eller fordon, kan Bosch hållas ansvarig endast om grov oaktsamhet kan påvisas. Vid personskador kan Bosch hållas ansvarig om vårdslöshet kan påvisas.</p>	<p><b>fi</b></p> <p><b>Sovelluskohteet</b></p> <p><b>Esitteen käyttäjälle</b></p> <p>Oheiseen esitteeseen on koostettu ajoneuvo-, moottori- ja laitekohtaisia tietoja, jotka kattavat Euroopan maissa markkinoitua mallit v. m. 1996 lähtien – v. m. 2016 mukaan lukien. Tiedot on kerätty valikoiden valmistajien ja maahantuojien laatimista tiedoista, katsastusdokumenteista sekä Bosch-dokumenteista ja ne vastaavat painatusajankohdan tietämystasoa.</p> <p>Teknisiin muutoksiin tai poikkeamiin perustuvia maakohtaisia eroja ei voi täysin sulkea pois. Siksi Bosch ei voi ottaa vastuuta luettelon tietojen täydellisyydestä ja virheettömyydestä. Taloudellisiin menetyksiin mahdollisesti johtavien virheiden osalta Bosch on vastuussa ainoastaan karkeista huolimattomuusvirheistä johtuvista välittömistä vaurioista. Myös henkilövahingoissa Boschilla on vain vähäinen vastuu.</p>	<p><b>pl</b></p> <p><b>Zastosowanie</b></p> <p><b>Wskazówki dla użytkownika</b></p> <p>Katalog zawiera dane pojazdów, silników i urządzeń na rynek europejski od roku produkcji 1996 do 2016 włącznie. Zostały one starannie zestawione na podstawie danych producentów i importerów, badań pojazdów oraz dokumentacji firmy Bosch zgodnie z aktualnym stanem wiedzy w momencie oddania do druku.</p> <p>W katalogu mogą występować różnice w stosunku do poszczególnych pojazdów w związku ze specyficznymi dla poszczególnych krajów wersjami wyposażenia i specyfikacji technicznej. Bosch nie ponosi odpowiedzialności za kompletność i dokładność danych. Za błędy i nieścisłości w druku, które mogą prowadzić do szkód mienia Bosch jest odpowiedzialny jedynie w przypadkach rażącego zaniedbania obowiązków oraz w przypadku spowodowania szkód. Bosch jest odpowiedzialny za uszkodzenia ciała jedynie w przypadkach zaniedbania z własnej strony.</p>	<p><b>ru</b></p> <p><b>Применение</b></p> <p><b>Вниманию пользователей</b></p> <p>В настоящем каталоге приводятся данные по автомобилям, двигателям и прочему оборудованию на европейском рынке с 1996 по 2016 год выпуска включительно. Они были тщательно подобраны из информации, предоставленной производителями и импортерами, по результатам тестирования автомобилей, а также из документации компании Bosch и отражают состояние на момент публикации в печать. Неизбежные расхождения из-за специфических для каждой страны технических модификаций не могут быть полностью исключены. Поэтому компания Bosch не несет ответственность за полноту и точность предоставленных данных. В случае, если ошибки или опечатки привели к ущербу для собственности или повлекли материальные затраты, компания Bosch принимает на себя ответственность только если это является преднамеренным вредом или грубой небрежностью со стороны фирмы Bosch. Если по! страдало физическое лицо, фирма Bosch несет ответственность даже при допущении незначительной небрежности.</p>

**Hinweise zur Benutzung**

- ① **Fahrzeugmarke**  
Hervorhebung der Hersteller im Graubalken
- ② **Fahrzeugmodell**  
Alphanumerisch aufsteigend
- ③ **Modelldetail**  
Besondere Fahrzeugmerkmale
- ④ **Hubraum**  
in l
- ⑤ **Motorleistung**  
in kW
- ⑥ **Motortyp**  
Siehe spezieller Hinweis in den Fahrzeugpapieren
- ⑦ **Export-Land**  
Gilt nur für spezielle Exportfahrzeuge
- ⑧ **Bildzeichen-Erläuterung**  
Siehe Katalogende
- ⑨ **Einbauzeitraum**
- ⑩ **Zylinder**  
Anzahl der im Motor vorhandenen Zylinder
- ⑪ **Sonderfall**  
Erläuterung siehe Katalogende
- ⑫ **Bestellnummer**

B2 | ALFA ROMEO

ALFA ROMEO									
<b>145</b>									
1.9 TD [930 MY95]	1.9	66	AR 33601 <M7>; AR 67501 <M6>	04.94-11.96	4	0 432 217 211			
TD [930 MY97]	1.9	66	AR 33601 <M5>; AR 67501 <M6>	11.96-05.98	4	0 432 217 211			
<b>146</b>									
1.9 TD [930 MY95]	1.9	66	AR 33601 <U2 M6 CF2>; AR 67501 <U2 M5>	12.94-11.96	4	0 432 217 211			
TD [930 MY97]	1.9	66	AR 33601 <M5>; AR 67501 <M6>	11.96-05.98	4	0 432 217 211			
<b>155</b>									
1.9 TD [167 MY92]	1.9	66	AR 67501 <U6 M1>	04.93-04.96	4	0 432 217 211			
TD [167 MY96]	1.9	66	AR 33601 <M1>	05.96-10.97	4	0 432 217 211			
2.5 TD [167 MY92]	2.5	92	VM07B / VM31B <M2/M3>	04.93-04.96	4	0 432 217 222	0 986 430 249		
					4	0 432 217 249 <sup>1</sup>			
TD [167 MY96]	2.5	92	VM31B <M2>	05.96-10.97	4	0 432 217 222	0 986 430 249		
					4	0 432 217 249 <sup>1</sup>			
<b>164</b>									
2.5 D Turbo [164]	2.5	92	VM08B / VM32B <M8/M9>	09.92-10.98	4	0 432 217 222	0 986 430 249		
					4	0 432 217 249 <sup>1</sup>			

AUDI									
<b>A3</b>									
	1.9 TDI [8L1]	1.9	66	AGR	09.96-08.00	4	0 432 193 732		
				ALH	08.97-06.01	AG	4 0 432 193 734 <sup>1</sup>		
							4 0 432 193 702		
						GS	4 0 432 193 704 <sup>1</sup>		
							4 0 432 193 693 <sup>1</sup>		
							4 0 432 193 695		
		81		AHF	01.97-08.00		4 0 432 193 744 <sup>1</sup>		
				ASV	09.99-06.01		4 0 432 193 746		
							4 0 432 193 592 <sup>1</sup>		
							4 0 432 193 594		
<b>A4</b>									
1.9 TDI [8D2; B5]	1.9	55	AFF	03.96-06.00	4	0 432 193 837 <sup>1</sup>			
		66	AHH	04.97-10.00	4	0 432 193 838			
			AHU	08.96-06.00	4	0 432 193 702			
			IZ	11.94-07.96	4	0 432 193 704 <sup>1</sup>			
					4	0 432 193 837 <sup>1</sup>			
					4	0 432 193 838			
TDI, TDI quattro [8D2; B5]	1.9	81	AFN	02.96-12.98	4	0 432 193 837 <sup>1</sup>			
				02.96-07.99	4	0 432 193 744 <sup>1</sup>			
					4	0 432 193 746			
			AVG	08.99-06.00	4	0 432 193 744 <sup>1</sup>			
					4	0 432 193 746			
2.5 TDI [8EC; B7]	2.5	120	BDG	11.04-05.06	6	0 432 193 744 <sup>1</sup>			
					6	0 432 133 783 <sup>1</sup>			
TDI [8E2; B6]	2.5	120	BCZ	06.03-12.04	6	0 432 133 785			
					6	0 432 133 792 <sup>1</sup>			
					6	0 432 133 794			
					6	0 432 133 783 <sup>1</sup>			
					6	0 432 133 785			
			BDG	06.03-12.04	EU3	6 0 432 133 792 <sup>1</sup>			
					EU4	6 0 432 133 783 <sup>1</sup>			
					6	0 432 133 785			
					6	0 432 133 792 <sup>1</sup>			
					6	0 432 133 794			
					6	0 432 133 783 <sup>1</sup>			
					6	0 432 133 785			
TDI quattro [8E2; B6]	2.5	132	BAU	11.02-12.04	EU3	6 0 432 133 792 <sup>1</sup>			
					EU4	6 0 432 133 783 <sup>1</sup>			
					6	0 432 133 785			
					6	0 432 133 794			
					6	0 432 133 783 <sup>1</sup>			
					6	0 432 133 785			

Bosch Automotive Aftermarket 2019 | 2020

en

## How to use this catalog

fr

## Consignes d'utilisation

it

## Istruzioni d'uso

es

## Indicaciones para la utilización

### ① **Manufacturer**

indicated in bold print  
within gray bar

### ② **Model**

In ascending alpha-numeric  
order

### ③ **Model details**

Special vehicle features

### ④ **Engine capacity**

in litres

### ⑤ **Engine output**

in kW

### ⑥ **Engine type**

See details in service book

### ⑦ **Export market**

Only valid for export vehicles

### ⑧ **Icon explanations**

See end of catalog

### ⑨ **Mounting duration**

### ⑩ **Cylinders**

Number of cylinders  
in engine

### ⑪ **Special notes**

For explanations see end of  
catalog

### ⑫ **Ordernumber**

### ① **Marque de véhicule**

Mise en avant des  
constructeurs sur fond gris

### ② **Modèle de véhicule**

Classé par ordre alphanumé-  
rique croissant

### ③ **Détail du modèle**

Caractéristiques particulières  
du véhicule

### ④ **Cylindrée**

en litres

### ⑤ **Puissance du moteur**

en kW

### ⑥ **Type de moteur**

Voir la remarque spécifique  
dans les papier du véhicule

### ⑦ **Pays d'exportation**

Applicable uniquement  
aux véhicules spéciaux  
d'exportation

### ⑧ **Signification des picto- grammes**

En fin de catalogue

### ⑨ **Période de montage**

### ⑩ **Cylindres**

Nombre de cylindres  
du moteur

### ⑪ **Particularités**

Signification des abréviations  
en fin de catalogue

### ⑫ **Référence**

### ① **Marchio veicolo**

Evidenziatura del produttore  
con banda grigia

### ② **Modello veicolo**

In ordine alfanumerico  
crescente

### ③ **Dettagli modello**

Caratteristiche particolari  
veicolo

### ④ **Cilindrata**

in l

### ⑤ **Potenza motore**

in kW

### ⑥ **Modello motore**

Vedi nota speciale nei docu-  
menti del veicolo

### ⑦ **Paese d'esportazione**

Vale solo per veicoli  
d'esportazione speciali

### ⑧ **Significati icone**

Vedi fine catalogo

### ⑨ **Periodo di montaggio**

### ⑩ **Cilindro**

Numero dei cilindri  
nel motore

### ⑪ **Casi particolari**

Per il significato, vedi fine  
catalogo

### ⑫ **Numero di ordinazione**

### ① **Marca de vehículo**

Fabricante destacado en gris

### ② **Modelo de vehículo**

Orden alfanumérico creciente

### ③ **Detalle del modelo**

Características especiales  
del vehículo

### ④ **Cilindrada**

en l

### ⑤ **Potencia del motor**

en kW

### ⑥ **Tipo de motor**

Ver indicación especial en la  
documentación del vehículo

### ⑦ **País de exportación**

Indicación referente al país en  
que se utilizará el producto

### ⑧ **Explicación de símbolo gráfico**

Véase el final del catálogo

### ⑨ **Periodo de montaje**

### ⑩ **Cilindros**

Número de cilindros en  
el motor

### ⑪ **Caso especial**

Explicación, véase el final del  
catálogo

### ⑫ **Referencia**



**Notas sobre a utilização**

**B2 | ALFA ROMEO**



<b>ALFA ROMEO</b>						
<b>145</b>						
1.9 TD [930 MY95]	1.9	66	AR 33601 <M7>; AR 67501 <M6>	04.94-11.96	4	0 432 217 211
TD [930 MY97]	1.9	66	AR 33601 <M5>; AR 67501 <M6>	11.96-05.98	4	0 432 217 211
<b>146</b>						
1.9 TD [930 MY95]	1.9	66	AR 33601 <U2 M6 CF2>; AR 67501 <U2 M5>	12.94-11.96	4	0 432 217 211
TD [930 MY97]	1.9	66	AR 33601 <M5>; AR 67501 <M6>	11.96-05.98	4	0 432 217 211
<b>155</b>						
1.9 TD [167 MY92]	1.9	66	AR 67501 <U6 M1>	04.93-04.96	4	0 432 217 211
TD [167 MY96]	1.9	66	AR 33601 <M1>	05.96-10.97	4	0 432 217 211
2.5 TD [167 MY92]	2.5	92	VM07B / VM31B <M2/M3>	04.93-04.96	4	0 432 217 222 0 986 430 249
					4	0 432 217 249 <sup>1</sup>
TD [167 MY96]	2.5	92	VM31B <M2>	05.96-10.97	4	0 432 217 222 0 986 430 249
					4	0 432 217 249 <sup>1</sup>
<b>164</b>						
2.5 D Turbo [164]	2.5	92	VM08B / VM32B <M8/M9>	09.92-10.98	4	0 432 217 222 0 986 430 249
					4	0 432 217 249 <sup>1</sup>

**AUDI**

<b>A3</b>						
	1.9 TDI [8L1]	1.9	66	AGR	09.96-08.00	4 0 432 193 732
				ALH	08.97-06.01 AG	4 0 432 193 734 <sup>1</sup>
						4 0 432 193 702
					GS	4 0 432 193 704 <sup>1</sup>
						4 0 432 193 693 <sup>1</sup>
						4 0 432 193 695
		81		AHF	01.97-08.00	4 0 432 193 744 <sup>1</sup>
				ASV	09.99-06.01	4 0 432 193 746
						4 0 432 193 592 <sup>1</sup>
						4 0 432 193 594
<b>A4</b>						
1.9 TDI [8D2; B5]	1.9	55	AFF	03.96-06.00	4 0 432 193 837 <sup>1</sup>	
		66	AHH	04.97-10.00	4 0 432 193 838	
			AHU	08.96-06.00	4 0 432 193 702	
			IZ	11.94-07.96	4 0 432 193 704 <sup>1</sup>	
					4 0 432 193 837 <sup>1</sup>	
					4 0 432 193 838	
TDI, TDI quattro [8D2; B5]	1.9	81	AFN	02.96-12.98	4 0 432 193 837 <sup>1</sup>	
				02.96-07.99	4 0 432 193 838	
					4 0 432 193 744 <sup>1</sup>	
					4 0 432 193 746	
			AVG	08.99-06.00	4 0 432 193 744 <sup>1</sup>	
					4 0 432 193 746	
2.5 TDI [8EC; B7]	2.5	120	BDG	11.04-05.06	6 0 432 133 783 <sup>1</sup>	
					6 0 432 133 785	
TDI [8E2; B6]	2.5	120	BCZ	06.03-12.04	6 0 432 133 792 <sup>1</sup>	
					6 0 432 133 794	
				EU4	6 0 432 133 783 <sup>1</sup>	
					6 0 432 133 785	
			BDG	06.03-12.04	6 0 432 133 792 <sup>1</sup>	
				EU3	6 0 432 133 794	
				EU4	6 0 432 133 783 <sup>1</sup>	
					6 0 432 133 785	
TDI quattro [8E2; B6]	2.5	132	BAU	11.02-12.04	6 0 432 133 785	
				EU3	6 0 432 133 792 <sup>1</sup>	
				EU4	6 0 432 133 783 <sup>1</sup>	
					6 0 432 133 785	

- ① **Marca do veículo**  
Fabricantes destacados na barra cinzenta
- ② **Modelo do veículo**  
Por ordem alfanumérica crescente
- ③ **Pormenor do modelo**  
Características especiais do veículo
- ④ **Cilindrada**  
em l
- ⑤ **Potência do motor**  
em kW
- ⑥ **Tipo de motor**  
Ver as indicações especiais constantes na documentação do veículo
- ⑦ **País de exportação**  
Apenas válido para veículos de exportação especiais
- ⑧ **Explicação do pictogramm**  
Explicação, ver final do catálogo
- ⑨ **Período da instalação**  
Primeira e última data da instalação referente ao modelo do veículo
- ⑩ **Número de cilindros**
- ⑪ **Caso especial**  
Explicação, ver final do catálogo
- ⑫ **Referência**

sv

## Bruksanvisning

fi

Ohjeita käyttöön  
liittyen

pl

Wskazówki dla  
użytkownika

ru

Указания по  
применению

## ① Fabrikat

Tillverkaren markerad i det  
grå fältet

## ② Fordonsmodell

Alfanumeriskt stigande

## ③ Modelledetalj

Speciella fordonskännetecken

## ④ Slagvolym

i l

## ⑤ Motoreffekt

i kW

## ⑥ Motortyp

Se speciell anteckning  
i fordonshandlingarna

## ⑦ Exportland

Gäller för speciella  
exportfordon

## ⑧ Bildsymbolernas förklaring

Se förklaring i slutet av  
katalogen

## ⑨ Monteringsperiod

Monteringsperiod för  
respektive produkt

## ⑩ Cylinderantal

## ⑪ Specialfall

Se förklaring i slutet av  
katalogen

## ⑫ Artikelnummer

## ① Automerkki

Valmistaja näkyy harmaassa  
palkissa

## ② Automalli

Aakkosnumeerisessa  
järjestyksessä

## ③ Mallitietoa

Ajoneuvomallin erityispiirteet

## ④ Iskutilavuus

sisään l

## ⑤ Moottorin teho

sisään kW

## ⑥ Moottorityyppi

Ks. erilliset tiedot  
rekisteriotteesta

## ⑦ Vientimaa

Pätee vain erikoismallisiin  
vientiautoihin

## ⑧ Kuvatunnusien merkitys

Ks. esitteen lopusta

## ⑨ Asennusajanjakso

## ⑩ Sylinteriluku

Moottorin sylinteriluku

## ⑪ Erikoistapaus

Selitys, ks. kuvaston lopusta

## ⑫ Tilausnumero

## ① Marka pojazdu

producent podany na  
szarym tle

## ② Model pojazdu

alfanumerycznie, rosnąco

## ③ Szczegóły modelu

cechy szczególne pojazdu

## ④ Pojemność skokowa

w l

## ⑤ Moc silnika

w kW

## ⑥ Typ silnika

patrz wskazówka w dokumen-  
tach pojazdu

## ⑦ Kraj eksportu

dotyczy tylko specjalnych  
pojazdów eksportowych

## ⑧ Objaśnienie symboli

Objaśnienie patrz koniec  
katalogu

## ⑨ Okres montażu

okres, w którym montowany  
był dany produkt

## ⑩ Liczba cylindrów

## ⑪ Przypadek szczególny

Objaśnienie patrz koniec  
katalogu

## ⑫ Nr katalogowy

## ① Марка автомобиля

Выделение производителей  
серыми полосками

## ② Модель автомобиля

В алфавитно-цифровом  
порядке

## ③ Особенность модели

Особые характеристики  
автомобиля

## ④ Объем двигателя

в литрах

## ⑤ Мощность двигателя

в кВт

## ⑥ Тип двигателя

См. специальное указание  
в документах на автомобиль

## ⑦ Страна-экспортер

Действительно только для  
специальных экспортных  
автомобилей

## ⑧ Разъяснение пиктограмм

См. разъяснения в конце  
кataloga

## ⑨ Время установки.

Время установки  
соответствующего изделия

## ⑩ Количество цилиндров

## ⑪ Особые случаи

См. разъяснения в конце  
kataloga

## ⑫ Номер для заказа



**ALFA ROMEO**

<b>145</b>						
1.9 TD [930 MY97]	1,9	66	AR 33601 <M5>; AR 67501 <M6>	11.96-05.98	4	<b>0 432 217 211</b>
<b>146</b>						
1.9 TD [930 MY97]	1,9	66	AR 33601 <M5>; AR 67501 <M6>	11.96-05.98	4	<b>0 432 217 211</b>
<b>164</b>						
2.5 D Turbo [164]	2,5	92	VM08B / VM32B <M8/M9>	09.92-10.98	4	<b>0 432 217 222 0 986 430 249</b>
					4	<b>0 432 217 249<sup>1</sup></b>

**AUDI**

<b>A3</b>						
1.9 TDI [8L1]	1,9	66	AGR	09.96-08.00	4	<b>0 432 193 732</b>
			ALH	08.97-06.01	AG	4 <b>0 432 193 734<sup>1</sup></b>
						4 <b>0 432 193 702</b>
					GS	4 <b>0 432 193 704<sup>1</sup></b>
						4 <b>0 432 193 693<sup>1</sup></b>
						4 <b>0 432 193 695</b>
		81	AHF	01.97-08.00	4	<b>0 432 193 746</b>
			ASV	09.99-06.01	4	<b>0 432 193 592<sup>1</sup></b>
					4	<b>0 432 193 594</b>
<b>A4</b>						
1.9 TDI [8D2; B5]	1,9	55	AFF	03.96-06.00	4	<b>0 432 193 837<sup>1</sup></b>
					4	<b>0 432 193 838</b>
		66	AHH	04.97-10.00	4	<b>0 432 193 702</b>
					4	<b>0 432 193 704<sup>1</sup></b>
			AHU	08.96-06.00	4	<b>0 432 193 837<sup>1</sup></b>
					4	<b>0 432 193 838</b>
TDI, TDI quattro [8D2; B5]	1,9	81	AFN	02.96-12.98	4	<b>0 432 193 746</b>
				02.96-07.99	4	<b>0 432 193 746</b>
			AVG	08.99-06.00	4	<b>0 432 193 746</b>
2.5 TDI [8EC; B7]	2,5	120	BDG	11.04-05.06	6	<b>0 432 133 783<sup>1</sup></b>
					6	<b>0 432 133 785</b>
TDI [8E2; B6]	2,5	120	BCZ	06.03-12.04	DBB,EU3	6 <b>0 432 133 792<sup>1</sup></b>
					EU3	6 <b>0 432 133 794</b>
					EU4	6 <b>0 432 133 783<sup>1</sup></b>
						6 <b>0 432 133 785</b>
			BDG	06.03-12.04	DBB,EU3	6 <b>0 432 133 792<sup>1</sup></b>
					EU3	6 <b>0 432 133 794</b>
					EU4	6 <b>0 432 133 783<sup>1</sup></b>
						6 <b>0 432 133 785</b>
TDI quattro [8E2; B6]	2,5	132	BAU	11.02-12.04	DBB,EU3	6 <b>0 432 133 792<sup>1</sup></b>
					EU3	6 <b>0 432 133 794</b>
					EU4	6 <b>0 432 133 783<sup>1</sup></b>
						6 <b>0 432 133 785</b>
			BDH	11.02-12.04	DBB,EU3	6 <b>0 432 133 792<sup>1</sup></b>
					EU3	6 <b>0 432 133 794</b>
					EU4	6 <b>0 432 133 783<sup>1</sup></b>
						6 <b>0 432 133 785</b>
TDI, TDI quattro [8D2; B5]	2,5	110	AFB	08.97-06.00	6	<b>0 432 133 833<sup>1</sup></b>
					6	<b>0 432 133 835</b>
			AKN	07.98-10.00	AG	6 <b>0 432 133 815<sup>1</sup></b>
						6 <b>0 432 133 817</b>
					GS	6 <b>0 432 133 822<sup>1</sup></b>
						6 <b>0 432 133 824</b>
TDI, TDI quattro [8E2; B6]	2,5	114/120/ 132	AKE; AYM; BFC	12.00-05.03	DBB,EU3	6 <b>0 432 133 792<sup>1</sup></b>
					EU3	6 <b>0 432 133 794</b>
					EU4	6 <b>0 432 133 783<sup>1</sup></b>
						6 <b>0 432 133 785</b>





<b>A4 Avant</b>											
1.9 TDI [8D5; B5]	1,9	66	AHH	04.97-09.01	4	0 432 193 702					
			AHU	08.96-06.00	4	0 432 193 704 <sup>1</sup>					
TDI, TDI quattro [8D5; B5]	1,9	81	AFN	02.96-07.99	4	0 432 193 746					
			AVG	08.99-06.00	4	0 432 193 746					
2.5 TDI [8ED; B7]	2,5	120	BDG	11.04-05.06	6	0 432 133 783 <sup>1</sup>					
					6	0 432 133 785					
TDI [8E5; B6]	2,5	120	BCZ	06.03-12.04	DBB,EU3	6	0 432 133 792 <sup>1</sup>				
					EU3	6	0 432 133 794				
					EU4	6	0 432 133 783 <sup>1</sup>				
			BDG	06.03-12.04	DBB,EU3	6	0 432 133 792 <sup>1</sup>				
					EU3	6	0 432 133 794				
					EU4	6	0 432 133 783 <sup>1</sup>				
		6	0 432 133 785								
TDI quattro [8E5; B6]	2,5	132	BAU	11.02-12.04	DBB,EU3	6	0 432 133 792 <sup>1</sup>				
					EU3	6	0 432 133 794				
					EU4	6	0 432 133 783 <sup>1</sup>				
			BDH	11.02-12.04	DBB,EU3	6	0 432 133 792 <sup>1</sup>				
					EU3	6	0 432 133 794				
					EU4	6	0 432 133 783 <sup>1</sup>				
		6	0 432 133 785								
TDI, TDI quattro [8D5; B5]	2,5	110	AFB	11.97-06.00	6	0 432 133 833 <sup>1</sup>					
					6	0 432 133 835					
			AKN	07.98-09.01	AG	6	0 432 133 815 <sup>1</sup>				
					GS	6	0 432 133 817				
		6	0 432 133 824								
TDI, TDI quattro [8E5; B6]	2,5	114/120/ 132	AKE; AYM; BFC	09.01-05.03	DBB,EU3	6	0 432 133 792 <sup>1</sup>				
					EU3	6	0 432 133 794				
					EU4	6	0 432 133 783 <sup>1</sup>				
							6	0 432 133 785			
<b>A4 Cabriolet</b>											
2.5 TDI [8H7; B6]	2,5	120	BCZ	06.03-12.05	DBB,EU3	6	0 432 133 792 <sup>1</sup>				
					EU3	6	0 432 133 794				
					EU4	6	0 432 133 783 <sup>1</sup>				
							6	0 432 133 785			
					BDG	06.03-12.05	DBB,EU3	6	0 432 133 792 <sup>1</sup>		
							EU3	6	0 432 133 794		
			EU4	6			0 432 133 783 <sup>1</sup>				
					6	0 432 133 785					
			BFC	08.02-05.03	DBB,EU3	6	0 432 133 792 <sup>1</sup>				
					EU3	6	0 432 133 794				
					EU4	6	0 432 133 783 <sup>1</sup>				
					6	0 432 133 785					
<b>A6</b>											
1.9 TDI [4B2; C5]	1,9	81	AFN; AVG	04.97-10.00	4	0 432 193 746					
2.5 TDI [4B2; C5]	2,5	114	AYM	06.01-06.02	DBB,EU3	6	0 432 133 792 <sup>1</sup>				
					EU3	6	0 432 133 794				
					EU4	6	0 432 133 783 <sup>1</sup>				
							6	0 432 133 785			
					120 BCZ	11.02-05.04	DBB,EU3	6	0 432 133 792 <sup>1</sup>		
							EU3	6	0 432 133 794		
EU4	6	0 432 133 783 <sup>1</sup>									
		6	0 432 133 785								
BDG	11.02-05.04	DBB,EU3	6	0 432 133 792 <sup>1</sup>							
		EU3	6	0 432 133 794							
		EU4	6	0 432 133 783 <sup>1</sup>							
		6	0 432 133 785								







◀ AUDI

2.5 TDI [4B2; C5]	2,5	120	BFC	07.02-05.03	DBB,EU3	6	0 432 133 792 <sup>1</sup>	
					EU3	6	0 432 133 794	
					EU4	6	0 432 133 783 <sup>1</sup>	
TDI, TDI quattro [4B2; C5]	2,5	110	AFB	04.97-05.00		6	0 432 133 833 <sup>1</sup>	
						6	0 432 133 835	
						6	0 432 133 785	
			AKN	11.98-04.01	AG		6	0 432 133 815 <sup>1</sup>
							6	0 432 133 817
						GS	6	0 432 133 822 <sup>1</sup>
			132	AKE	10.99-05.01		6	0 432 133 802 <sup>1</sup>
							6	0 432 133 804
						06.01-08.03	DBB,EU3	6
						EU3	6	0 432 133 794
						EU4	6	0 432 133 783 <sup>1</sup>
							6	0 432 133 785
BAU	11.02-05.04	DBB,EU3		6	0 432 133 792 <sup>1</sup>			
			EU3	6	0 432 133 794			
			EU4	6	0 432 133 783 <sup>1</sup>			
BDH	11.02-05.04	DBB,EU3		6	0 432 133 792 <sup>1</sup>			
			EU3	6	0 432 133 794			
			EU4	6	0 432 133 783 <sup>1</sup>			
				6	0 432 133 785			

**A6 Allroad**

2.5 TDI [4BH; C5]	2,5	120	BCZ	06.03-08.05		6	0 432 133 794
					DBB	6	0 432 133 792 <sup>1</sup>
					132	AKE	05.00-05.03
						6	0 432 133 804
BAU	06.03-08.05	DBB		6	0 432 133 794		
				6	0 432 133 792 <sup>1</sup>		

**A6 Avant**

1.9 TDI [4B5; C5]	1,9	81	AFN	02.98-04.01		4	0 432 193 746	
2.5 TDI [4B5; C5]	2,5	114	AYM	06.01-06.02	DBB,EU3	6	0 432 133 792 <sup>1</sup>	
					EU3	6	0 432 133 794	
					EU4	6	0 432 133 783 <sup>1</sup>	
			120	BCZ	11.02-01.05	DBB,EU3	6	0 432 133 792 <sup>1</sup>
						EU3	6	0 432 133 794
						EU4	6	0 432 133 783 <sup>1</sup>
			BDG	11.02-01.05	DBB,EU3		6	0 432 133 792 <sup>1</sup>
						EU3	6	0 432 133 794
						EU4	6	0 432 133 783 <sup>1</sup>
			BFC	07.02-08.03	DBB,EU3		6	0 432 133 792 <sup>1</sup>
						EU3	6	0 432 133 794
						EU4	6	0 432 133 783 <sup>1</sup>
TDI, TDI quattro [4B5; C5]	2,5	110	AFB	02.98-05.00		6	0 432 133 833 <sup>1</sup>	
						6	0 432 133 835	
					AKN	11.98-04.01	AG	6
						6	0 432 133 817	
					GS	6	0 432 133 822 <sup>1</sup>	
						6	0 432 133 824	
132	AKE	10.99-05.01		6	0 432 133 802 <sup>1</sup>			
				6	0 432 133 804			
			06.01-08.03	DBB,EU3	6	0 432 133 792 <sup>1</sup>		
			EU3	6	0 432 133 794			
			EU4	6	0 432 133 783 <sup>1</sup>			
				6	0 432 133 785			



2.5 TDI, TDI quattro [4B5; C5]	2,5	132	BAU	11.02-01.05	DBB,EU3	6	0 432 133 792 <sup>1</sup>
					EU3	6	0 432 133 794
					EU4	6	0 432 133 783 <sup>1</sup>
			BDH	11.02-01.05	DBB,EU3	6	0 432 133 792 <sup>1</sup>
					EU3	6	0 432 133 794
					EU4	6	0 432 133 783 <sup>1</sup>
					6	0 432 133 785	

<b>A8</b>									
2.5 TDI, TDI quattro [4D2; D2]	2,5	110	AFB	06.97-06.00		6	0 432 133 833 <sup>1</sup>		
						6	0 432 133 835		
					AKN	11.97-09.02	AG	6	0 432 133 815 <sup>1</sup>
						6	0 432 133 817		
							GS	6	0 432 133 822 <sup>1</sup>
								6	0 432 133 824
		132	AKE	11.99-09.02		6	0 432 133 802 <sup>1</sup>		
						6	0 432 133 804		

<b>Cabriolet</b>							
1.9 TDI [8G7; B4]	1,9	66	AHU	07.96-08.00		4	0 432 193 837 <sup>1</sup>
						4	0 432 193 838

**BMW**

<b>Serie 3</b>							
318 d [E 46]	2,0	85	20 4D 1 <M 47 D 20>	09.01-03.03		4	0 432 191 398
						4	0 432 191 401 <sup>1</sup>
tds [E 36]	1,7	66	17 4T 1 <M 41 D 18>	10.94-03.98		4	0 432 217 278 0 986 430 302
						4	0 432 217 279 <sup>1</sup>
320 d [E 46]	2,0	100	20 4D 1 <M 47 D 20>	04.98-09.01		4	0 432 191 527 <sup>1</sup>
						4	0 432 191 528
325 td, tds [E 36]	2,5	85/105	25 6T 1 <M 51 D 25>	02.96-12.98		6	0 432 217 278 0 986 430 302
						6	0 432 217 279 <sup>1</sup>
<b>Serie 3 Compact</b>							
318 tds [E 36]	1,7	66	17 4T 1 <M 41 D 18>	01.95-09.00		4	0 432 217 278 0 986 430 302
						4	0 432 217 279 <sup>1</sup>
<b>Serie 3 Touring</b>							
318 d [E 46]	2,0	85	20 4D 1 <M 47 D 20>	03.02-03.03		4	0 432 191 398
						4	0 432 191 401 <sup>1</sup>
tds [E 36]	1,7	66	17 4T 1 <M 41 D 18>	03.95-12.99		4	0 432 217 278 0 986 430 302
						4	0 432 217 279 <sup>1</sup>
320 d [E 46]	2,0	100	20 4D 1 <M 47 D 20>	10.99-09.01		4	0 432 191 527 <sup>1</sup>
						4	0 432 191 528
325 tds [E 36]	2,5	105	25 6T 1 <M 51 D 25>	02.96-12.99		6	0 432 217 278 0 986 430 302
						6	0 432 217 279 <sup>1</sup>
<b>Serie 5</b>							
520 d [E 39]	2,0	100	20 4D 1 <M 47 D 20>	04.00-07.03		4	0 432 191 527 <sup>1</sup>
						4	0 432 191 528
525 td, tds [E 39]	2,5	85/105	25 6T 1 <M 51 D 25>	01.96-09.00		6	0 432 217 278 0 986 430 302
						6	0 432 217 279 <sup>1</sup>
<b>Serie 5 Touring</b>							
520 d [E 39]	2,0	100	20 4D 1 <M 47 D 20>	04.00-07.03		4	0 432 191 527 <sup>1</sup>
						4	0 432 191 528
525 tds [E 39]	2,5	105	25 6T 1 <M 51 D 25>	03.97-09.00		6	0 432 217 278 0 986 430 302
						6	0 432 217 279 <sup>1</sup>
<b>Serie 7</b>							
725 tds [E 38]	2,5	105	25 6T 1 <M 51 D 25>	01.96-12.00		6	0 432 217 278 0 986 430 302
						6	0 432 217 279 <sup>1</sup>





**CHEVROLET**

**Blazer**

2.5 D	2,5	74	4A		10.97-01.00	4	<b>0 432 193 766</b>
-------	-----	----	----	--	-------------	---	----------------------

**CHRYSLER**

**Cherokee**

2.5 D	2,5	83	VM		01.99-01.04	4	<b>0 432 217 281</b>
						4	<b>0 432 217 282<sup>1</sup></b>
						4	<b>0 432 217 294<sup>1</sup></b>
3.1 D	3,1	110	EXA <VM 3,1 TDI>		01.00-12.01	5	<b>0 432 217 303<sup>1</sup></b>
						5	<b>0 432 217 311</b>

**Voyager**

2.5 TD [GS]	2,5	85	VM HR 425 CLIEE <ENC>		01.95-12.00	4	<b>0 432 217 222</b>	<b>0 986 430 249</b>
					09.96-12.00	4	<b>0 432 217 304<sup>1</sup></b>	

**CITROEN**

**Berlingo**

1.9 D [M49]	1,9	50-51	DJY <XUD9>; D9B <XUD9>		07.96-11.02 BO	4	<b>0 432 217 248</b>	<b>0 986 430 244</b>
-------------	-----	-------	------------------------	--	----------------	---	----------------------	----------------------

**C 15**

1.8 D	1,8	44	161A <XUD7> Org.-Nr. 5654→		04.92-05.00 BO	4	<b>0 432 217 248</b>	<b>0 986 430 244</b>
-------	-----	----	-------------------------------	--	----------------	---	----------------------	----------------------

**Evasion**

1.9 D Turbo [U60]	1,9	66	DHX <XUD9TE>		10.94-07.02	4	<b>0 432 217 286<sup>1</sup></b>	
-------------------	-----	----	--------------	--	-------------	---	----------------------------------	--

**Jumpy**

1.9 D Turbo [U64]	1,9	66	DHX <XUD9TE>		10.95-01.07	4	<b>0 432 217 286<sup>1</sup></b>	
-------------------	-----	----	--------------	--	-------------	---	----------------------------------	--

**Xantia**

1.9 D [X1]	1,9	50-52	DJY/DJZ <XUD9A/Y> D9B <XUD9A/L>		05.94-01.98 BO 07.93-01.98 BO	4	<b>0 432 217 248</b>	<b>0 986 430 244</b>
D Turbo [X1]	1,9	66	DHX, DHY <XUD9BTF/Y, L3>		02.94-01.98	4	<b>0 432 217 286<sup>1</sup></b>	<b>0 986 430 375</b>
D Turbo [X2]	1,9	66	DHX <XUD9BTF/L3>		12.97-12.01	4	<b>0 432 217 286<sup>1</sup></b>	

**Xantia Break**

1.9 D Turbo [X1]	1,9	55/66	DHW <XUD9SD>; DHX, DHY <XUD9BTF/L3>		09.95-01.98	4	<b>0 432 217 286<sup>1</sup></b>	<b>0 986 430 375</b>
D Turbo [X2]	1,9	66	DHX <XUD9BTF/L3>		12.97-12.01	4	<b>0 432 217 286<sup>1</sup></b>	

**XM**

2.1 D Turbo [Y4]	2,1	80-81	PHZ <XUD11ATE> P8B <XUD11ATE>		07.94-10.00 07.94-10.00	4	<b>0 432 217 235</b>	<b>0 986 430 240</b>
2.5 D Turbo [Y4]	2,5	94-96	THY <DK5ATE>		07.94-10.00	4	<b>0 432 217 269</b>	<b>0 432 217 270<sup>1</sup></b>

**Xsara**

1.9 D [N6]	1,9	50	DJY <XUD9A>		07.97-08.00 BO	4	<b>0 432 217 248</b>	<b>0 986 430 244</b>
D Turbo [N6]	1,9	55	DHV <XUD9BSD>		01.98-08.00	4	<b>0 432 217 248</b>	<b>0 986 430 244</b>
						4	<b>0 432 217 301<sup>1</sup></b>	

**Xsara Break**

1.9 D [N6]	1,9	50	DJY <XUD9A>		04.98-08.00 BO	4	<b>0 432 217 248</b>	<b>0 986 430 244</b>
D Turbo [N6]	1,9	55	DHV <XUD9BSD>		04.98-08.00	4	<b>0 432 217 248</b>	<b>0 986 430 244</b>
						4	<b>0 432 217 301<sup>1</sup></b>	

**Xsara Coupé**

1.9 D [N6]	1,9	50	DJY <XUD9A>		07.97-08.00 BO	4	<b>0 432 217 248</b>	<b>0 986 430 244</b>
D Turbo [N6]	1,9	55	DHV <XUD9BSD>		01.98-08.00	4	<b>0 432 217 248</b>	<b>0 986 430 244</b>
						4	<b>0 432 217 301<sup>1</sup></b>	





## DAEWOO

## Korando

2.3 D [KJ]	2,3	57	OM 661 D23 <OM 601.990>	07.96-12.00	4	0 432 217 157	0 986 430 197
2.9 D [KJ]	2,9	72	OM 662 D29 <OM 602.910>	07.96-12.00	5	0 432 217 157	0 986 430 197
TD Intercooler [KJ]	2,9	88	OM 662 LA <OM 602>	07.96-12.00	5	0 432 217 169	0 986 430 173

## Musso

2.3 D [FJ]	2,3	57	OM 661 D23 <OM 601.910>	07.93-12.00	4	0 432 217 157	0 986 430 197
2.9 D [FJ]	2,9	72	OM 662 D29 <OM 602.910>	07.93-12.00	5	0 432 217 157	0 986 430 197
TD Intercooler [FJ]	2,9	88	OM 662 D29 LA <OM 602.910>	05.97-12.00	5	0 432 217 169	0 986 430 173

## DODGE

## Caravan

2.5 TD [NS]	2,5	85	VM HR 425 CLIEE <ENC>	01.95-08.03	4	0 432 217 222	0 986 430 249
				09.96-08.03	4	0 432 217 304 <sup>1</sup>	

## Ram 2500 Pickup

5.9	5,9			09.97-08.02	GS	6	0 432 193 630
				09.99-08.02	AG	6	0 432 193 581
		131	ETB	09.97-08.98		6	0 432 193 630
		183	ETC	09.00-08.01	AG	6	0 432 193 581
					GS	6	0 432 193 630

## Ram 3500 Pickup

5.9	5,9			09.00-08.02	AG	8	0 432 193 581
					GS	8	0 432 193 630
, 4x4	5,9	160-175		09.97-08.02	GS	6	0 432 193 630
				09.99-08.02	AG	6	0 432 193 581
4x4	5,9	131	ETB	09.97-08.98		6	0 432 193 630

## FIAT

## Brava

1.9 TD [182]	1,9	55	182 A8.000 <M9>; 182 A8.000 <M20>	03.96-09.01	4	0 432 217 297	
--------------	-----	----	-----------------------------------	-------------	---	---------------	--

## Bravo

1.9 TD [182]	1,9	55	182 A8.000 <M9>; 182 A8.000 <M20>	03.96-10.01	4	0 432 217 297	
--------------	-----	----	-----------------------------------	-------------	---	---------------	--

## Fiorino Furgao

1.7 D	1,7	52	146 B2.000	01.04-12.08	4	0 432 217 195	
-------	-----	----	------------	-------------	---	---------------	--

## Marea

1.9 TD [185]	1,9	55,1	182 A8.000 <M2>	10.96-09.02	4	0 432 217 297	
2.4 TD [185]	2,4	91	185 A2.000 <M3>				
			Mot.-Nr. →0918278	10.96-02.99	5	0 432 217 273	
			Mot.-Nr. →0918279	09.96-02.99	5	0 432 217 274 <sup>1</sup>	
			Mot.-Nr. 0918279→	09.96-02.99	5	0 432 217 297	
			Mot.-Nr. 0918280→	09.96-02.99	5	0 432 217 296 <sup>1</sup>	

## Marengo

1.9 TD [285]	1,9	55/55,1	182 A8.000 <M2>	01.97-09.02	4	0 432 217 297	
--------------	-----	---------	-----------------	-------------	---	---------------	--

## Palio

1.7 D	1,7	52	M 708 N7 17 L	09.97-08.01	4	0 432 217 211	
-------	-----	----	---------------	-------------	---	---------------	--

## Palio Weekend

1.7 TD [178]	1,7	51	176 A3.000 <M3>	09.97-10.00	4	0 432 217 211	
--------------	-----	----	-----------------	-------------	---	---------------	--

## Punto

1.7 TD [176]	1,7	46/51	176 A3.000 <M2>; 176 B7.000 <M3>	05.97-08.99	4	0 432 217 211	
--------------	-----	-------	----------------------------------	-------------	---	---------------	--

## Punto Soft Van

1.7 TD [276]	1,7	46	176 B7.000 <M3>	05.97-08.99	4	0 432 217 211	
--------------	-----	----	-----------------	-------------	---	---------------	--

## Punto Van

1.7 TD [276]	1,7	51/53	176 A3.000 <M2>; 176 A5.000 <M1>	05.97-08.99	4	0 432 217 211	
--------------	-----	-------	----------------------------------	-------------	---	---------------	--

## Scudo

1.9 D [220]	1,9	51	D9B <M2>	10.95-05.00	4	0 432 217 248	0 986 430 244
TD [220]	1,9	66	DHX <M4>	03.97-05.00	4	0 432 217 286 <sup>1</sup>	
					4	0 432 217 289	0 986 430 375





◀ FIAT

<b>1.9 TD [220]</b>	1,9	68	D8B <M3>	10.95-05.00	4	<b>0 432 217 218</b>	<b>0 986 430 240</b>
<b>Siena</b>							
<b>1.7 TD [178]</b>	1,7	46/47	176 B7.000 <M41>; 178 C9.066 <M40>	05.99-12.01	4	<b>0 432 217 211</b>	
<b>Strada</b>							
<b>1.7 D Turbo</b>	1,7	52		07.99-12.08	4	<b>0 432 217 211</b>	
TDS [278]	1,7	51	176 A3.000 <M10>	03.99-03.03	4	<b>0 432 217 211</b>	
<b>Ulysse</b>							
<b>1.9 TD [220]</b>	1,9	66	DHX <M4>; D8B <M3>	01.95-05.98	4	<b>0 432 217 218</b>	<b>0 986 430 240</b>
			DHX <M7>	10.96-12.99	4	<b>0 432 217 286</b> <sup>1</sup>	
					4	<b>0 432 217 289</b>	<b>0 986 430 375</b>

**FISSORE**

<b>Rayton</b>							
<b>2.4 D Turbo 4x4</b>	2,4	82	HR 492 HIM	03.88-12.01	4	<b>0 432 297 047</b>	











**FORCE MOTORS (BAJAJ TEMPO)**

<b>Trax Tempo</b>							
<b>2.4 D</b>	2,4	44	OM616 <D98>	01.92-07.05	4	<b>9 430 032 327</b>	

**FORD**

<b>Escort</b>							
<b>1.8 D</b>	1,8	44	RTF; RTH <Endura-DE>	01.95-11.01	BO	4	<b>0 432 217 267</b>
<b>Escort VII</b>							
<b>1.8 D [95]</b>	1,8	44	RT... <D18NA>; RTH <D18NA>	01.95-09.01	BO	4	<b>0 432 217 267</b>
<b>Escort VII Express 55</b>							
<b>1.8 D [95]</b>	1,8	44	RTF <D18NA>; RTH <D18NA>	01.95-09.01	BO	4	<b>0 432 217 267</b>
<b>Escort VII Express 75</b>							
<b>1.8 D [95]</b>	1,8	44	RTF <D18NA>; RTH <D18NA>	01.95-09.01	BO	4	<b>0 432 217 267</b>
<b>Escort VII Turnier</b>							
<b>1.8 D [95]</b>	1,8	44	RTF <D18NA>; RTH <D18NA>	01.95-09.01	BO	4	<b>0 432 217 267</b>
<b>Fiesta</b>							
<b>1.8 D</b>	1,8	44	RTC; RTD <Endura-DE>	05.99-08.03		4	<b>0 432 217 267</b>
<b>Fiesta IV</b>							
<b>1.8 D [96]</b>	1,8	44	RT... <D18, Endura-DE>	10.95-06.01	BO,E93	4	<b>0 432 217 267</b>
					BO,E96	4	<b>0 432 217 293</b> <b>0 986 430 520</b>
					BO,KOC, N07	4	<b>0 432 217 188</b> <b>0 986 430 208</b>
<b>Fiesta IV Courier</b>							
<b>1.8 D [96]</b>	1,8	44	RT... <D18, Endura-DE>	10.95-06.01	BO,E93	4	<b>0 432 217 267</b>
					BO,KOC, N07	4	<b>0 432 217 188</b> <b>0 986 430 208</b>
<b>Galaxy</b>							
<b>1.9 TDI [95]</b>	1,9	66	AHU <D19N (VW 19N)>	09.96-03.00		4	<b>0 432 193 829</b> <sup>1</sup>
		81	AFN <D19P (VW 19P)>; AVG <D19P (VW 19P)>	11.97-03.00		4	<b>0 432 193 838</b>
						4	<b>0 432 193 746</b>
<b>Mondeo III</b>							
<b>2.0 TDDi [01]</b>	2,0	66	D5BA <Duratorq-DI>	10.00-03.07		4	<b>0 432 133 800</b>
		85	D6BA <Duratorq-DI>	10.00-08.02		4	<b>0 432 133 801</b>
<b>Mondeo III Turnier</b>							
<b>2.0 TDDi [01]</b>	2,0	66	D5BA <Duratorq-DI>	10.00-03.07		4	<b>0 432 133 800</b>
		85	D6BA <Duratorq-DI>	10.00-08.02		4	<b>0 432 133 801</b>
<b>Ranger</b>							
<b>2.5 TD [99]</b>	2,5	80-86	WL-T <MD25TI(HP)>	01.99-10.07	ZDA	4	<b>9 430 610 157</b>
<b>Scorpio II</b>							
<b>2.5 TD [95]</b>	2,5	85	SCC <VM25-TCI>	10.94-12.98		4	<b>0 432 217 222</b> <b>0 986 430 249</b>
						4	<b>0 432 217 249</b> <sup>1</sup>



									
<b>2.5 TD [95]</b>	2,5	92	SCD <VM25-TCI>	10.94-12.98			4	<b>0 432 217 222</b>	<b>0 986 430 249</b>
							4	<b>0 432 217 249</b> <sup>1</sup>	
<b>Scorpio II Turnier</b>									
<b>2.5 TD [95]</b>	2,5	85/92	SCC <VM25-TCI>; SCD <VM25-TCI>	10.94-12.98			4	<b>0 432 217 222</b>	<b>0 986 430 249</b>
							4	<b>0 432 217 249</b> <sup>1</sup>	
<b>FSO</b>									
<b>Polonez Caro</b>									
<b>1.9 D</b>	1,9	51	XUD 9A	01.93-12.02			4	<b>0 432 217 201</b>	
<b>HONDA</b>									
<b>Accord Hatchback</b>									
<b>2.0 TDi [CH8]</b>	2,0	77	20T2N	01.99-10.00			4	<b>0 432 193 819</b>	
							4	<b>0 432 193 820</b> <sup>1</sup>	
<b>Accord Sedan</b>									
<b>2.0 D Turbo [CF1]</b>	2,0	77	20T2N	09.95-10.98			4	<b>0 432 193 819</b>	
							4	<b>0 432 193 820</b> <sup>1</sup>	
<b>TDi [CH2]</b>	2,0	77	20T2N	01.99-02.03			4	<b>0 432 193 819</b>	
							4	<b>0 432 193 820</b> <sup>1</sup>	
<b>Civic Aerodeck</b>									
<b>2.0 D Turbo [MB/MC]</b>	2,0	77	20T2N	04.98-02.01			4	<b>0 432 193 819</b>	
							4	<b>0 432 193 820</b> <sup>1</sup>	
<b>Civic Fastback</b>									
<b>2.0 D [MB]</b>	2,0	74-77	20T2N	03.97-02.01			4	<b>0 432 193 819</b>	
							4	<b>0 432 193 820</b> <sup>1</sup>	
<b>JEEP</b>									
<b>Cherokee</b>									
<b>2.5 D Turbo [XJ]</b>	2,5	85-89	ENC,ENO <VM HR 425 CLIRX>	10.95-12.01			4	<b>0 432 217 222</b>	<b>0 986 430 249</b>
							4	<b>0 432 217 249</b> <sup>1</sup>	
<b>KIA</b>									
<b>Carnival</b>									
<b>2.9 D Turbo [UP]</b>	2,9	93	J3	06.98-09.01			4	<b>0 432 193 655</b>	
<b>Sedona</b>									
<b>2.9 D Turbo [UP]</b>	2,9	93	J3	06.98-09.01			4	<b>0 432 193 655</b>	
<b>LADA</b>									
<b>Niva</b>									
<b>1.5 TD</b>	1,5	48	3411	09.94-12.99			4	<b>0 432 217 194</b>	
<b>1.8 TD</b>	1,8	55	3431	07.99-12.00			4	<b>0 432 217 194</b>	
<b>Serie 2100</b>									
<b>2104 1.5 TD</b>	1,5	48	341	01.97-12.00			4	<b>0 432 217 194</b>	
<b>LANCIA</b>									
<b>Dedra Berlina</b>									
<b>1.9 TD [835]</b>	1,9	66	835A4.000/160D1.000 <M1/M2>	10.94-10.99			4	<b>0 432 217 211</b>	
<b>Dedra Station Wagon</b>									
<b>1.9 TD [835]</b>	1,9	66	835A4.000/160D1.000 <M1/M2>	10.94-10.99			4	<b>0 432 217 211</b>	





◀ LANCIA

Kappa Berlina							
2.4 TD [838]	2,4	91	838A7.000 <M2>				
			Ricam.Nr →2065499	06.96-03.98	5	0 432 217 273	
					5	0 432 217 274 <sup>1</sup>	
			Ricam.Nr 2065500→	06.96-03.98	5	0 432 217 296 <sup>1</sup>	
					5	0 432 217 297	
Kappa Station Wagon							
2.4 D Turbo [838]	2,4	91	838A7.000 <M2>				
			Ricam.Nr →2065499	06.96-03.98	5	0 432 217 273	
					5	0 432 217 274 <sup>1</sup>	
			Ricam.Nr 2065500→	06.96-03.98	5	0 432 217 296 <sup>1</sup>	
					5	0 432 217 297	

**LAND ROVER GROUP**

Defender 90							
2.5 D Turbo	2,5	80-83	Gemini TCI D.I. 23L <200/300 Tdi>				
			Mot.-Nr. 11 L...→	08.90-12.01	4	0 432 193 879	
			Mot.-Nr. 16 L...→	09.94-12.01	4	0 432 193 835	
Defender 110							
2.5 D Turbo	2,5	65-83	Gemini TCI D.I. 23L <200/300 Tdi>				
			Mot.-Nr. 11 L...→	08.90-12.01	4	0 432 193 879	
			Mot.-Nr. 16 L...→	09.94-12.01	4	0 432 193 835	
		85	Maxion HS4TCC <Euro I>	08.98-12.05	4	0 432 193 835	
				02.00-12.05	4	0 432 193 583	
Defender 130							
2.5 D Turbo	2,5	80-83	Gemini TCI D.I. 23L <200/300 Tdi>				
			Mot.-Nr. 11 L...→	08.90-12.01	4	0 432 193 879	
			Mot.-Nr. 16 L...→	09.94-12.01	4	0 432 193 835	
Discovery I							
2.5 TDi	2,5	82-90	19L 21L 22L 23L 300	10.93-12.98	4	0 432 193 834 <sup>1</sup>	
				AGR	4	0 432 193 835	
Freelander I							
2.0 D [LN]	2,0	70-72	20T2N <L-Serie>	09.97-09.03	BO	4	0 432 193 700 <sup>1</sup>
						4	0 432 193 701
Range Rover II							
2.5 D [LP]	2,5	100-102	25 6T	09.94-08.02		6	0 432 217 223 0 986 430 241
						6	0 432 217 236 <sup>1</sup>

**MAHINDRA**

Bolero							
2.5 D	2,5	53	XD 3P IDI	08.00-04.05	BS1	4	F 002 C6Z 397
D, D XL, D XLS	2,5	46	MDI 3200TC	05.05-02.07	TW	4	F 002 C8Z 885
						4	F 002 C8Z 890
DXL	2,5	43	MDI 3200 D	02.04-03.05	BS1	4	F 002 C8Z 867
					BS2	4	F 002 C8Z 881
D XLS	2,5	44,5	XD 3PH	02.04-12.05	BS1	4	F 002 C6Z 397
D 4WD	2,5	46	MDI 3200 TC	05.05-02.07	TW	4	F 002 C8Z 885
						4	F 002 C8Z 890
		53	XD 3P IDI	08.00-04.05		4	F 002 C6Z 397
Bolero Invader							
2.5 D	2,5	40	MDI 3200	03.03-10.04		4	F 002 C8Z 867
D, D 4WD	2,5	46	MDI 3200 TC	12.04-06.07	TW	4	F 002 C8Z 885
						4	F 002 C8Z 890
D GLX	2,5	53	XD 3P IDI	03.03-10.04		4	F 002 C6Z 397
Classic							
2.1 D 4WD	2,1	46	XDP 4.90	11.97-05.98		4	F 002 C6Z 201
MM 540/550							
DP2.1 D 4WD	2,1	46	XDP 4.90 C	11.97→		4	F 002 C6Z 201



<b>Savari</b>							
2.5 D	2,5	43	MDI 3200		02.01-06.02	4	F 002 C7Z 208
					07.02→	4	F 002 C8Z 868

<b>Voyager</b>							
2.5 D	2,5	53	XD 3PBM		11.97-01.03	4	F 002 C6Z 201

**MAZDA**

<b>MPV</b>							
2.5 12V D Turbo [LV]	2,5	85	WLT		03.96-05.99	ZDA	4 9 430 610 157

<b>Serie B</b>							
2500 D [UN]	2,5	57	MD25NA		02.99-07.02	EU3,ZDA	4 9 430 610 441

					02.99-03.06	KZE,RSA, ZDA	4 9 430 610 159
						WEI,ZDA	4 9 430 610 158

D Turbo, D Turbo 4x4 [UN]	2,5	62	WLE7		09.01-07.02	EU3,ZDA	4 9 430 610 157
					09.01-03.06	KZE,RSA, ZDA	4 9 430 610 159
						WEI,ZDA	4 9 430 610 158

D Turbo 4x4 [UN]	2,5	64-80	WLT		02.99-07.02	EU3,ZDA	4 9 430 610 441
					02.99-03.06	KZE,RSA, ZDA	4 9 430 610 159
						WEI,ZDA	4 9 430 610 158

D 4x4 [UN]	2,5	57			02.99-07.02	EU3,ZDA	4 9 430 610 441
					02.99-03.06	KZE,RSA, ZDA	4 9 430 610 159
						WEI,ZDA	4 9 430 610 158

12V D [UF]	2,5	63	WL		03.96-05.99	ZDA	4 9 430 610 157
12V D 4x4 [UF]	2,5	57-63	WL		03.96-05.99	ZDA	4 9 430 610 157

<b>323</b>							
2.0 D [BA]	2,0	52	RF		03.97-06.98		4 9 430 610 439
D [BJ]	2,0	52	RF		05.98-10.00	ZDA	4 9 430 610 440

<b>323 Hatchback</b>							
P 2.0 D [BA]	2,0	52	RF		03.97-09.00		4 9 430 610 439
2.0 D [BJ]	2,0	52	RF		06.98-09.99	ZDA	4 9 430 610 440

**MERCEDES-BENZ**

<b>Serie C</b>							
200 D [202]	2,0	55-65	OM 604.915 <D 20>		09.96-06.99	CAV,EFZ	4 0 432 217 287 0 986 430 307

220 D [202]	2,2	55-70	OM 604.910 <D 22>		08.93-06.99	CAV,EFZ	4 0 432 217 287 0 986 430 307
250 D Turbo [202]	2,5	110	OM 605.960 <AD 25 LA>		09.95-04.00		5 0 432 217 280 0 986 430 388

<b>Serie C (T-Modell)</b>							
200 D [202]	2,0	65	OM 604.915 <D 20>		09.96-06.99	CAV,EFZ	4 0 432 217 287 0 986 430 307
220 D [202]	2,2	55-70	OM 604.910 <D 22>		05.96-06.99	CAV,EFZ	4 0 432 217 287 0 986 430 307
250 D Turbo [202]	2,5	110	OM 605.960 <AD 25 LA>		05.96-02.01		5 0 432 217 280 0 986 430 388

<b>Serie E</b>							
200 D [210]	2,0	65	OM 604.917 <D20>		03.97-07.99	CAV,EFZ	4 0 432 217 287 0 986 430 307
220 D [210]	2,2	55-70	OM 604.912 <D22>		06.95-07.99	CAV,EFZ	4 0 432 217 287 0 986 430 307
250 D [210]	2,5	83	OM 605.912 <D25>		06.95-07.99		5 0 432 217 253 0 986 430 245
D Turbo [210]	2,5	110	OM 605.962 <AD25 LA>		09.97-07.99		5 0 432 217 280 0 986 430 388

290 D Turbo [210]	2,9	95	OM 602.982 <DE LA>				
			Mot.-Nr. →..030404		01.96-07.99	GS	5 0 432 193 758
							5 0 432 193 768 <sup>1</sup>
			Mot.-Nr. →..032988		01.96-07.99	AG	5 0 432 193 758
							5 0 432 193 768 <sup>1</sup>
			Mot.-Nr. ..030405→		01.96-07.99	GS	5 0 432 193 637 <sup>1</sup>
							5 0 432 193 639
			Mot.-Nr. ..032989→		01.96-07.99	AG	5 0 432 193 637 <sup>1</sup>
							5 0 432 193 639
300 D Turbo [210]	3,0	130	OM 606.962 <D 30>		03.97-07.99		6 0 432 217 280 0 986 430 388





◀ MERCEDES-BENZ

Serie E (T-Modell)							
250 D [210]	2,5	83	OM 605.912 <D25>	05.96-06.98		5	<b>0 432 217 253 0 986 430 245</b>
D Turbo [210]	2,5	110	OM 605.962 <A D25 LA>	09.97-07.99		5	<b>0 432 217 280 0 986 430 388</b>
290 D Turbo [210]	2,9	95	OM 602.982 <DE LA>				
			Mot.-Nr. →..030404	05.96-07.99	GS	5	<b>0 432 193 758</b>
						5	<b>0 432 193 768<sup>1</sup></b>
			Mot.-Nr. →..032988	05.96-07.99	AG	5	<b>0 432 193 758</b>
						5	<b>0 432 193 768<sup>1</sup></b>
			Mot.-Nr...030405→	05.96-07.99	GS	5	<b>0 432 193 637<sup>1</sup></b>
						5	<b>0 432 193 639</b>
			Mot.-Nr...032989→	05.96-07.99	AG	5	<b>0 432 193 637<sup>1</sup></b>
						5	<b>0 432 193 639</b>
300 D Turbo [210]	3,0	130	OM 606.962 <D 30>	03.97-07.99		6	<b>0 432 217 280 0 986 430 388</b>
Serie G							
290 DT [461]	2,9	90	OM 602.983				
			Komp.Nr. 180 Komp.Nr. ML9	04.97-09.01	TW	5	<b>0 432 193 623<sup>1</sup></b>
						5	<b>0 432 193 625</b>
			Mot.-Nr. →980 10/50,20/60 182045	04.97-09.01	TW	5	<b>0 432 193 758</b>
			→980 12/52,22/62 009698			5	<b>0 432 193 768<sup>1</sup></b>
			→982 10/50,20/60 030404				
			→982 12/52,22/62 032988				
			→983/984/985/989 044623				
			Komp.Nr. 180 Komp.Nr. ML9				
			Mot.-Nr. 980 10/50,20/60 182046	04.97-09.01	TW	5	<b>0 432 193 637<sup>1</sup></b>
			→980 12/52,22/62 009699			5	<b>0 432 193 639</b>
			→982 10/50,20/60 030405				
			→982 12/52,22/62 032989				
			→983/984/985/989 044624				
			→ Komp.Nr. 180 Komp.Nr. ML9				
300 D Turbo [463]	3,0	130	OM 606.964	09.96-11.00		6	<b>0 432 217 280 0 986 430 388</b>
Serie S							
300 D Turbo [140]	3,0	130	OM 606.961	06.96-09.98		6	<b>0 432 217 280 0 986 430 388</b>



**MG**

ZR							
2.0 D Turbo	2,0	74/82	20 T2N <L-Serie>	10.01-05.05		4	<b>0 432 193 571<sup>1</sup></b>
						4	<b>0 432 193 601</b>
ZS							
2.0 TD	2,0	74	20 T2N <L-Serie>	10.01-05.05		4	<b>0 432 193 571<sup>1</sup></b>
						4	<b>0 432 193 601</b>

**MITSUBISHI**

L 200							
2.5 D, D 2WD, D 4WD [K6/K7]	2,5	55-64	4D56	06.95-12.07	ZDA	4	<b>9 430 612 750</b>
D Turbo Interc. 2WD [K6/K7]	2,5	74-85	4D56	01.96-12.07	FBH,ZDA	4	<b>9 430 613 643</b>
				03.98-06.01	NOR,ZDA	4	<b>9 430 612 750</b>
				07.01-12.07	NOR,ZDA	4	<b>9 430 610 179</b>
D Turbo Interc. 4WD [K6/K7]	2,5	73-85	4D56	01.96-12.07	FBH,ZDA	4	<b>9 430 613 643</b>
					NOR,ZDA	4	<b>9 430 610 179</b>
					ZDA	4	<b>9 430 612 750</b>
D Turbo 4WD [K0-K3]	2,5	73	4D56	06.94-03.01	ZDA	4	<b>9 430 610 179</b>
L 200 Forte							
2.5 D Turbo Interc. 4WD [K7]	2,5	73-85	4D56	01.97→	FBH,ZDA	4	<b>9 430 613 643</b>
					NOR,ZDA	4	<b>9 430 610 179</b>
L 300 Wagon							
2.5 D 2WD long [P]	2,5	51	4D56	07.94-12.00	ZDA	4	<b>9 430 610 179</b>
L 400							
2.5 D Turbo 2WD, D Turbo 4WD	2,5	64	4D56	12.94-03.01	ZDA	4	<b>9 430 610 179</b>



<b>Pajero</b>							
2.5 TD [V]	2,5	62	4D56	06.95-05.98	ZDA	4	9 430 610 179
				06.98-05.99	ZDA	4	9 430 612 750
TD Interc. [V]	2,5	73-77	4D56	12.90-06.00	WEG,ZDA	4	9 430 610 154
					WEG,ZDA	4	9 430 610 179
TD Interc. 4WD [V60; V70]	2,5	73-85	4D56	02.00-08.06	ZDA	4	9 430 610 179
2.8 D [V]	2,8	92	4M40	06.94-05.99	ZDA	4	9 430 610 422
TD [V]	2,8	92	4M40	07.95-12.98		4	9 430 610 119
TD Interc. 4WD [V]	2,8	103	4M40	11.93-04.00	WEG,ZDA	4	9 430 610 435
					WEG	4	9 430 610 119
3.2 Di-D 4WD [V60; V70]	3,2	118-121	4M41	02.00-08.06	ZDA	4	9 430 613 989
<b>Pajero Cabrio</b>							
2.5 D 4WD [V]	2,5	62	4D56	06.95-05.98	ZDA	4	9 430 610 179
				06.98-05.99	ZDA	4	9 430 612 750
TD Interc. 4WD [V]	2,5	73-77	4D56	06.94-05.01	ZDA	4	9 430 610 179
<b>Pajero Sport</b>							
2.5 TD, TD+ [K]	2,5	73-85/98	4D56	08.98-02.09	ZDA	4	9 430 610 179
<b>Space Gear</b>							
2.5 D Turbo Interc. 2WD, D Turbo Interc. 4WD, D Turbo 2WD short	2,5	64/73	4D56	12.94-03.01	ZDA	4	9 430 610 179

## NISSAN

<b>Almera</b>							
2.0 D [N15]	2,0	55	CD20	04.96-04.00	ZDA	4	9 443 611 765 <sup>1</sup>
				05.96-04.00	ZDA	4	9 430 610 386
2.2 D Turbo [N16]	2,2	81	YD22DDT	04.00-03.01		4	9 430 613 823
D Turbo [N16E]	2,2	81	YD22DDT	03.01-02.03		4	9 430 613 621
					WW,ZDA	4	9 430 613 450
<b>Almera Hatchback</b>							
2.0 D [N15]	2,0	55	CD20	04.96-04.00	ZDA	4	9 443 611 765 <sup>1</sup>
				05.96-04.00	ZDA	4	9 430 610 386
2.2 D Turbo [N16E]	2,2	81	YD22DDT	01.00-03.01		4	9 430 613 823
				04.01-02.03		4	9 430 613 621
					WW,ZDA	4	9 430 613 450
<b>Almera Tino</b>							
2.2 D Turbo [V10M]	2,2	81-84	YD22DDTI	05.00-01.03		4	9 430 613 823
<b>Hardbody</b>							
2.5 D Turbo, D Turbo 4x4 [D22]	2,5	98	YD25DDTI	01.06→	ZDA	4	9 430 613 778 <sup>1</sup>
2.7 TD 4x4 [D21]	2,7	76	TD27	05.02-06.06	ZDA	4	9 430 615 042
3.2 D 4x4 [D22]	3,2	76	QD32	05.02-12.08		4	9 430 613 540
<b>Patrol</b>							
2.8 D, D Turbo [260]	2,8	57/70	A428II; A428T	04.89-05.98	ZDA	4	9 430 610 033
		80/85	RD28; RD28T	04.89-05.98	ZDA	6	9 430 610 037
<b>Patrol GR</b>							
2.8 D Turbo, D Turbo 4x4 [Y61]	2,8	95-96	RD28TI	10.97-02.00		6	9 443 610 422 <sup>1</sup>
					ZDA	6	9 430 610 297
3.0 Di Hardtop 4x4, Di 4x4 [Y61]	3,0	116	ZD30DDTI	02.00-07.01		4	9 430 613 211
				08.01-07.04		4	9 430 613 871
				08.04-03.10		4	9 430 613 801
<b>Pickup</b>							
2.5 D, D Turbo 4WD, D 4WD [D22]	2,5	61/76	TD25; TD25TI	02.98-11.01		4	9 430 613 540
D, D 4WD [D21]	2,5	59-63	TD25	08.87-02.98		4	9 430 610 065
D Turbo, D Turbo 4WD [D22]	2,5	98	YD25	11.01-01.08	ZDA	4	9 430 613 778 <sup>1</sup>
2.7 D 2WD [D22]	2,7	64	TD27	02.97-11.11		4	9 430 613 540
3.2 D 4WD [D22]	3,2	76	QD32	02.97→		4	9 430 613 540
<b>Primera Hatchback</b>							
2.0 D Turbo [P11E]	2,0	66	CD20T	10.97-12.01		4	0 432 217 308
						4	0 432 217 309 <sup>1</sup>
<b>Primera Sedan</b>							
2.0 D Turbo [P11E]	2,0	66	CD20T	10.97-12.01		4	0 432 217 308
						4	0 432 217 309 <sup>1</sup>







◀ NISSAN

Primera Wagon										
2.0 D Turbo [WP11E]	2,0	66	CD20T		01.98-12.01		4	0 432 217 308		
							4	0 432 217 309 <sup>1</sup>		
Serena										
2.3 D [C23]	2,3	55	LD23		09.94-11.01		4	0 432 117 001		
Sunny Wagon										
1.7 D [Y10]	1,7	40	CD17 <VA>		05.92-04.98		4	9 430 610 098		
2.0 D [Y10]	2,0	55	CD20 <VC>		11.90-03.00		4	9 430 610 105		
Terrano II										
2.7 D Turbo 4x4 [R20]	2,7	74	TD27T		04.99-02.02 ZDA		4	9 430 610 170		
			91-92	TD27Ti		01.96-02.02 DKF,ZDA		4	9 430 610 170	
								4	9 443 610 385 <sup>1</sup>	
								4	0 432 217 306 <sup>1</sup>	
			92	TD27Ti		01.96-12.06 BO		4	0 432 217 306 <sup>1</sup>	
						11.97-12.06 BO		4	0 432 217 305	
						11.97-12.06		4	0 432 217 305	
								4	0 432 217 306 <sup>1</sup>	
						11.98-12.99 TW		4	0 432 217 306 <sup>1</sup>	
						11.98-> TW		4	0 432 217 305	
					4	0 432 217 306 <sup>1</sup>				
			01.00-> TW,ZDA		4	9 443 610 385 <sup>1</sup>				
3.0 D Turbo 4x4 [R20]	3,0	113	ZD30		02.02-12.06		4	9 430 613 871		
Xterra										
2.8 D [N50]	2,8	97	4.07 TCA <Euro II (WM28TI)>		02.03-07.05		4	0 432 193 566		

**OPEL**

Astra									
1.7 DT [G]	1,7	50	X 17 DTL		03.98-08.00		4	0 432 217 299	0 986 430 449
			TD [F]	X 17 DTL	09.94-02.98 BO		4	0 432 217 299	0 986 430 449
					17 TD/TC4 <OHC EE1>	12.91-02.98 DKF,ZDA		4	9 430 610 128
2.0 DT [G]	2,0	60	X 20 DTL <Ecotec 16V Turbo>		02.98-08.00 EU3,NT5		4	0 432 193 633	
					03.98-08.00 EU2,NC8		4	0 432 193 686	
DTI [G]	2,0	74	Y 20 DTH <Ecotec>						
				Fg.-Nr. →22999999 →25999999	09.99-01.05		4	0 432 193 634	
				→28999999 →2H999999					
				Fg.-Nr. 32000001 → 35000001 →	09.99-01.05		4	0 432 193 525	
			38000001 → 3H000001 →						
DTL [G]	2,0	60	Y 20 DTL <Turbo>		09.00-01.04 EU3,NT5		4	0 432 193 633	
2.2 DTI [G]	2,2	92	Y 22 DTR <Ecotec>		09.01-01.04		4	0 432 193 569	
Astra Cabrio									
2.2 DTI [G]	2,2	92	Y 22 DTR <Ecotec>		03.02-08.05		4	0 432 193 569	
Astra Caravan									
1.7 DT [G]	1,7	50	X 17 DTL		03.98-08.00		4	0 432 217 299	0 986 430 449
			TD [F]	X 17 DTL	08.94-02.98 BO		4	0 432 217 299	0 986 430 449
					17 TD/TC4 <OHC EE1>	12.91-02.98 DKF,ZDA		4	9 430 610 128
2.0 DT [G]	2,0	60	X 20 DTL <Ecotec 16V Turbo>		02.98-08.00 EU3,NT5		4	0 432 193 633	
					03.98-08.00 EU2,NC8		4	0 432 193 686	
DTI [G]	2,0	74	Y 20 DTH <Ecotec>						
				Fg.-Nr. →22999999 →25999999	09.00-06.04		4	0 432 193 634	
				→28999999 →2H999999					
				Fg.-Nr. 32000001 → 35000001 →	09.00-06.04		4	0 432 193 525	
			38000001 → 3H000001 →						
DTL [G]	2,0	60	Y 20 DTL <Turbo>		09.00-06.04 EU3,NT5		4	0 432 193 633	
2.2 DTI [G]	2,2	92	Y 22 DTR <Ecotec>		09.01-06.04		4	0 432 193 569	
Astra Coupé									
2.2 DTI [G]	2,2	92	Y 22 DTR <Ecotec>		03.02-02.05		4	0 432 193 569	
Combo									
1.7 D	1,7	44	X 17 D 4EE1		04.96-10.01		4	9 430 610 136	
			17 D <4EE1>						
				Mot.-Nr. →602344	09.94-10.01		4	9 430 610 136	



<b>Corsa</b>									
1.5 D [B]	1,5	37	15 D <4EC1>						
			Mot.-Nr. →957024	03.93-08.00	DKF	4	9 430 610 136		
			Mot.-Nr. 957025→	03.93-08.00	DKF	4	9 430 610 136		
TD [B]	1,5	49	15 TD <T4EC1 Turbo>						
			Mot.-Nr. →957024	03.93-08.00	DKF	4	9 430 610 136		
			Mot.-Nr. 957025→	03.93-08.00	DKF	4	9 430 610 136		
XD [B]	1,5	37	X 15 D <4EC1>						
			Mot.-Nr. →957024	04.96-08.00	DKF	4	9 430 610 136		
			Mot.-Nr. 957025→	04.96-08.00	DKF	4	9 430 610 136		
XTD [B]	1,5	49	X 15 TD <4EE1 Turbo>						
			Mot.-Nr. →957024	04.96-08.00	DKF	4	9 430 610 136		
			Mot.-Nr. 957025→	04.96-08.00	DKF	4	9 430 610 136		
1.7 D [B]	1,7	44	X 17 D <4EE1>	04.96-08.00		4	9 430 610 136		
			17 D <4EE1>						
			Mot.-Nr. →602344	03.93-08.00		4	9 430 610 136		
D Utility [B]	1,7	42	X 17 D4EE1	09.98-12.00	ZDA	4	9 430 613 598		
<b>Frontera</b>									
2.2 DTI [B]	2,2	85	X 22 DTH <Turbo>	09.98-10.02		4	0 432 193 650		
		88	Y 22 DTH <Turbo>	09.02-09.04		4	0 432 193 512		
2.5 TDS Turbo [A]	2,5	85	VM 41 B <Venturi-25TD>	06.96-08.98		0	0 432 217 222	0 986 430 249	
						0	0 432 217 249 <sup>1</sup>		
2.8 TDI [A]	2,8	83	4JB1T <(28TD)>	02.95-08.98	DKF	4	9 430 610 163		
					DKF,EFV	4	9 430 610 163		
<b>Omega</b>									
2.0 DTI Turbo [B]	2,0	74	X 20 DTH	09.97-08.00	NT5	4	0 432 193 634		
2.2 DTI [B]	2,2	88	Y 22 DTH <Turbo>	06.00-07.03		4	0 432 193 570		
2.5 TD [B]	2,5	96	U 25 TD; X 25 TD	08.96-02.01		6	0 432 217 278	0 986 430 302	
						6	0 432 217 279 <sup>1</sup>		
<b>Signum</b>									
2.0 DTI	2,0	74	Y 20 DTH <Ecotec>	05.03-09.05		4	0 432 193 525		
2.2 DTI	2,2	86-92	Y 22 DTR <Ecotec>	05.03-09.05		4	0 432 193 570		
<b>Sintra</b>									
2.2 TD	2,2	85	X 22 DTH <Turbo>	09.97-10.98		4	0 432 193 688		
<b>Vectra</b>									
1.7 TD [B]	1,7	60	X 17 TD <TC4 EE1>	09.95-09.98	DKF,ZDA	4	9 430 610 128		
2.0 DI [B]	2,0	60	X 20 DTL <Ecotec 16V Turbo>						
			Fg.-Nr. XL000001→	09.96-08.02		4	0 432 193 686		
			Fg.-Nr. X1000001→	09.96-08.02		4	0 432 193 633		
			Mot.-Nr. →17062265	09.96-08.02		4	0 432 193 797		
			Mot.-Nr. 17062266→Fgst.Nr.W7999999	09.96-08.02		4	0 432 193 686		
DTI [B]	2,0	74	X 20 DTH						
			Fg.-Nr. XL000001→	09.97-08.03		4	0 432 193 687		
			Fg.-Nr. X1000001→X7000001→	09.97-08.03		4	0 432 193 634		
			Mot.-Nr. 17062266→Fgst.Nr.W7999999	09.97-08.03		4	0 432 193 687		
			Y 20 DTH <Ecotec>						
			Fg.-Nr. XL000001→	09.00-09.03		4	0 432 193 686		
			Fg.-Nr. X1000001→	09.00-09.03		4	0 432 193 633		
			Mot.-Nr. →17062265	09.00-09.03		4	0 432 193 797		
			Mot.-Nr. 17062266→Fgst.Nr.W7999999	09.00-09.03		4	0 432 193 686		
DTI, DTI GTS [C]	2,0	74	Y 20 DTH <Ecotec>	04.02-09.05		4	0 432 193 525		
2.2 DTI [B]	2,2	92	Y 22 DTR <Ecotec>	09.00-09.03		4	0 432 193 569		
DTI, DTI GTS [C]	2,2	86-92	Y 22 DTR <Ecotec>	04.02-09.05		4	0 432 193 569		
<b>Vectra Caravan</b>									
1.7 TD [B]	1,7	60	X 17 TD <TC4 EE1>	09.95-09.98	DKF,ZDA	4	9 430 610 128		
2.0 DI [B]	2,0	60	X 20 DTL <Ecotec 16V Turbo>						
			Fg.-Nr. XL000001→	09.96-08.00		4	0 432 193 686		
			Fg.-Nr. X1000001→	09.96-08.00		4	0 432 193 633		
			Mot.-Nr. →17062265	09.96-08.00		4	0 432 193 797		
			Mot.-Nr. 17062266→Fgst.Nr.W7999999	09.96-08.00		4	0 432 193 686		





◀ OPEL

<b>2.0 DTI [B]</b>	2,0	74	X 20 DTH					
			Fg.-Nr. XL000001→	09.97-08.03		4	<b>0 432 193 687</b>	
			Fg.-Nr. X1000001→X7000001→	09.97-08.03		4	<b>0 432 193 634</b>	
			Mot.-Nr. 17062266→Fgst.Nr.W7999999	09.97-08.03		4	<b>0 432 193 687</b>	
			Y 20 DTH <Ecotec>					
			Fg.-Nr. XL000001→	09.00-09.03		4	<b>0 432 193 686</b>	
			Fg.-Nr. X1000001→	09.00-09.03		4	<b>0 432 193 633</b>	
			Mot.-Nr. →17062265	09.00-09.03		4	<b>0 432 193 797</b>	
			Mot.-Nr. 17062266→Fgst.Nr.W7999999	09.00-09.03		4	<b>0 432 193 686</b>	
DTI [C]	2,0	74	Y 20 DTH <Ecotec>	09.03-09.05		4	<b>0 432 193 525</b>	
<b>2.2 DTI [B]</b>	2,2	92	Y 22 DTR <Ecotec>	09.00-09.03		4	<b>0 432 193 569</b>	
DTI [C]	2,2	86-92	Y 22 DTR <Ecotec>	09.03-09.05		4	<b>0 432 193 569</b>	
<b>Zafira</b>								
<b>2.0 DI [A]</b>	2,0	60	X 20 DTL <Ecotec 16V Turbo>	03.99-08.00	EU2,NC8	4	<b>0 432 193 686</b>	
					EU3,NT5	4	<b>0 432 193 633</b>	
DTI [A]	2,0	74	Y 20 DTH <Ecotec>					
			Fg.-Nr. →22999999 →25999999	04.99-07.05		4	<b>0 432 193 634</b>	
			→28999999 →2H999999					
			Fg.-Nr. 32000001→ 35000001→	04.99-07.05		4	<b>0 432 193 525</b>	
			38000001→ 3H000001→					
<b>2.2 DTI [A]</b>	2,2	92	Y 22 DTR <Ecotec>	03.02-07.05		4	<b>0 432 193 569</b>	

**PEUGEOT**

**Expert**

<b>1.9 D Turbo [U64]</b>	1,9	66-68	DHX <XUD9TE>	09.95-05.00		4	<b>0 432 217 286<sup>1</sup></b>	
		68	D8B <XUD9TE>	09.95-07.98		4	<b>0 432 217 289</b>	<b>0 986 430 375</b>
							<b>0 432 217 218</b>	<b>0 986 430 240</b>

**Partner**

<b>1.9 D [M4]</b>	1,9	50	DJY <XUD9Y>	07.96-08.02	BO	4	<b>0 432 217 248</b>	<b>0 986 430 244</b>
		51	WJZ <DW8>	11.98-08.02	BO	4	<b>0 432 217 310</b>	

**Ranch**

<b>1.9 D [M4]</b>	1,9	51	WJZ <DW8>	11.98-08.02	BO	4	<b>0 432 217 310</b>	
-------------------	-----	----	-----------	-------------	----	---	----------------------	--

**106**

<b>1.5 D [S2]</b>	1,5	40-42	VJY <TUD5>; VJZ <TUD5>	05.96-05.05	BO	4	<b>0 432 217 288</b>	
		42	VJX <TUD5B>	07.00-05.05		4	<b>0 432 217 310</b>	

**205**

<b>1.8 D</b>	1,8	44	A9A,161A <XUD7>	07.87-12.98	BO	4	<b>0 432 217 153</b>	
<b>1.9 D</b>	1,9	47	DJZ,162 <XUD9>	10.87-09.98	BO	4	<b>0 432 217 153</b>	

**205 Pickup**

<b>1.8 D</b>	1,8	44	<XUD7>	10.85-09.98	BO	4	<b>0 432 217 153</b>	
--------------	-----	----	--------	-------------	----	---	----------------------	--

**306**

<b>1.9 D</b>	1,9	50	<XUD9>	10.97→		4	<b>0 432 217 248</b>	<b>0 986 430 244</b>
D [N5]	1,9	50/51	DJY <XUD9>; D9B <XUD9>	05.97-10.03	BO	4	<b>0 432 217 248</b>	<b>0 986 430 244</b>
		51	WJZ <DW8>	09.98-10.03	BO	4	<b>0 432 217 310</b>	
D Turbo [N5]	1,9	55	DHV <XUD9BSD>	06.98-10.03		4	<b>0 432 217 248</b>	<b>0 986 430 244</b>

**306 Break**

<b>1.9 D [N5]</b>	1,9	50/51	DJY <XUD9>; D9B <XUD9>	05.97-03.02	BO	4	<b>0 432 217 248</b>	<b>0 986 430 244</b>
		51	WJZ <DW8>	09.98-03.02	BO	4	<b>0 432 217 310</b>	
D Turbo [N5]	1,9	55	DHV <XUD9BSD>	06.98-03.02		4	<b>0 432 217 248</b>	<b>0 986 430 244</b>

**406**

<b>1.9 D Turbo [D8]</b>	1,9	66-68	DHX <XUD9TE>	12.95-03.99		4	<b>0 432 217 286<sup>1</sup></b>	
						4	<b>0 432 217 289</b>	<b>0 986 430 375</b>
			D8B <XUD9TE>	12.95-03.99		4	<b>0 432 217 218</b>	<b>0 986 430 240</b>

**406 Break**

<b>1.9 D Turbo [D8]</b>	1,9	66-68	DHX <XUD9TE>	10.96-03.99		4	<b>0 432 217 286<sup>1</sup></b>	
						4	<b>0 432 217 289</b>	<b>0 986 430 375</b>
			D8B <XUD9TE>	10.96-03.99		4	<b>0 432 217 218</b>	<b>0 986 430 240</b>

**605**

<b>2.5 D Turbo [Y30]</b>	2,5	94-96	THY <DK5ATE>	07.94-05.99		4	<b>0 432 217 269</b>	
						4	<b>0 432 217 270<sup>1</sup></b>	



806						
1.9 D Turbo [U60]	1,9	66	DHX <XUD9TE>	12.94-08.02	4	0 432 217 286 <sup>1</sup>
					4	0 432 217 289 0 986 430 375
		66-68	D8B <XUD9TE>	12.94-08.02	4	0 432 217 218 0 986 430 240

## RENAULT

Clio I						
1.9 D	1,9	47	F8Q 732	03.96→	4	0 432 217 250
D [X57]	1,9	47	F8Q 678	10.94-02.98 BO	4	0 432 217 226
			F8Q 732	06.90-02.98 BO	4	0 432 217 226
		47-48	F8Q 730	07.92-02.98 BO	4	0 432 217 258

Clio II						
1.9 DTI [BB/CB/SB]	1,9	59	F9Q 780	03.99-10.07	4	0 432 193 643
			F9Q 782	08.00-10.07	4	0 432 193 563 <sup>1</sup>
					4	0 432 193 564

Espace III						
1.9 dTi [JEO]	1,9	72	F9Q 720	02.99-10.02	4	0 432 193 753
			F9Q 722	10.99-10.02	4	0 432 193 754 <sup>1</sup>
					4	0 432 193 610 <sup>1</sup>
					4	0 432 193 611
2.2 D Turbo [JEO]	2,2	83	G8T 714	10.96-10.02	4	0 432 217 285
					4	0 432 217 307 <sup>1</sup>

Kangoo I						
1.9 DTI [FC./KC.]	1,9	59	F9Q 780	09.98-12.07	4	0 432 193 643
					4	0 432 193 644 <sup>1</sup>
DTI, DTI 4x4 [FC./KC.]	1,9	59	F9Q 782	02.00-12.07	4	0 432 193 563 <sup>1</sup>
					4	0 432 193 564

Laguna I						
1.9 DTI [B56]	1,9	72	F9Q 710; F9Q 717	04.99-02.01 BO	4	0 432 193 610 <sup>1</sup>
			F9Q 716	10.97-09.99	4	0 432 193 611
					4	0 432 193 753
					4	0 432 193 754 <sup>1</sup>
2.2 D [B56]	2,2	61-63	G8T 752; G8T 792; G8T 794	09.95-02.01	4	0 432 217 263 0 986 430 267
D Turbo [B56]	2,2	83-85	G8T 760	02.96-02.01	4	0 432 217 285

Laguna I Grandtour						
1.9 DTI [K56]	1,9	72	F9Q 710; F9Q 717	04.99-02.01 BO	4	0 432 193 610 <sup>1</sup>
			F9Q 716	10.97-09.99	4	0 432 193 611
					4	0 432 193 753
					4	0 432 193 754 <sup>1</sup>
DTI [S56]	1,9	72	F9Q 716	03.98-02.01	4	0 432 193 753
					4	0 432 193 754 <sup>1</sup>
2.2 D, D Turbo [K56]	2,2	61-63/ 83-85	G8T 752; G8T 760; G8T 792; G8T 794	09.95-02.01	4	0 432 217 263 0 986 430 267
D, D Turbo [S56]	2,2	61-63/ 83-85	G8T 752; G8T 760; G8T 792	09.95-02.01	4	0 432 217 263 0 986 430 267

Megane						
1.9 D	1,9	68	F9QT	06.99-11.09	4	0 432 193 611

Megane I						
1.9 D [X64]	1,9	47-48	F8Q 620; F8Q 624	01.96-02.99 BO	4	0 432 217 292
DTI [X64]	1,9	59	F9Q 744	01.01-10.02	4	0 432 193 563 <sup>1</sup>
					4	0 432 193 564
		69	F9Q 730	06.97-02.99	4	0 432 193 753
					4	0 432 193 754 <sup>1</sup>
		72	F9Q 731	03.99-10.02 BO	4	0 432 193 610 <sup>1</sup>
					4	0 432 193 611
			F9Q 734	06.97-02.99	4	0 432 193 753
					4	0 432 193 754 <sup>1</sup>
			F9Q 736	03.99-10.02 BO	4	0 432 193 610 <sup>1</sup>
					4	0 432 193 611





## ◀ RENAULT

Megane I Classic						
1.9 D [X64]	1,9	47-48	F8Q 624	09.96-09.03	4	0 432 217 292
DTI [X64]	1,9	59	F9Q 744	11.00-09.03	4	0 432 193 563 <sup>1</sup>
					4	0 432 193 564
		72	F9Q 730; F9Q 734	08.97-09.03	4	0 432 193 753
					4	0 432 193 754 <sup>1</sup>
			F9Q 731	04.99-09.03 BO	4	0 432 193 610 <sup>1</sup>
					4	0 432 193 611
			F9Q 736	04.99-09.03 BO	4	0 432 193 610 <sup>1</sup>
					4	0 432 193 611
Megane I Coupé						
1.9 DTI [X64]	1,9	72	F9Q 731	03.99-10.02 BO	4	0 432 193 610 <sup>1</sup>
					4	0 432 193 611
			F9Q 734	06.97-02.99	4	0 432 193 753
					4	0 432 193 754 <sup>1</sup>
			F9Q 736	03.99-10.02 BO	4	0 432 193 610 <sup>1</sup>
					4	0 432 193 611
Megane I Grandtour						
1.9 D [X64]	1,9	59	F9Q 744	01.01-09.03	4	0 432 193 563 <sup>1</sup>
					4	0 432 193 564
DTI [X64]	1,9	72	F9Q 731; F9Q 736	07.98-09.03 BO	4	0 432 193 610 <sup>1</sup>
					4	0 432 193 611
R 21						
1.9 D	1,9	47	F8Q 706	01.93-12.00	4	0 432 217 250
Safrane						
2.2 12V D Turbo [B54]	2,2	83	G8T 740	10.96-12.00 BO	4	0 432 217 285
Scenic I						
1.9 DTI [JA]	1,9	59	F9Q 744	11.00-04.03	4	0 432 193 563 <sup>1</sup>
					4	0 432 193 564
		72	F9Q 731	03.99-04.03	4	0 432 193 610 <sup>1</sup>
					4	0 432 193 611
			F9Q 736	03.99-04.03	4	0 432 193 610 <sup>1</sup>
					4	0 432 193 611
		72-74	F9Q 734	06.97-02.99	4	0 432 193 753
					4	0 432 193 754 <sup>1</sup>
19						
1.9 D [X53]	1,9	47	F8Q 706	09.88-12.01 BO	4	0 432 217 227
				05.92-12.01 BO	4	0 432 217 258
			F8Q 742	06.90-12.01 BO	4	0 432 217 226

## ROVER

Serie 200						
220 SD	2,0	63	20T2R			
			Fg.-Nr. YD 471565→	09.95-03.00	4	0 432 193 571 <sup>1</sup>
					4	0 432 193 601
			Fg.-Nr. →YD 471564	09.95-03.00	4	0 432 193 819
					4	0 432 193 820 <sup>1</sup>
SDI	2,0	77	20T2N <L-Serie>			
			Fg.-Nr. YD 471565→	09.95-03.00	4	0 432 193 571 <sup>1</sup>
					4	0 432 193 601
			Fg.-Nr. →YD 471564	09.95-03.00	4	0 432 193 819
					4	0 432 193 820 <sup>1</sup>
Serie 400						
420 SD	2,0	63	20T2R			
			Fg.-Nr. YD 471064→	10.95-03.00	4	0 432 193 571 <sup>1</sup>
					4	0 432 193 601
			Fg.-Nr. →YD 471063	10.95-03.00	4	0 432 193 819
					4	0 432 193 820 <sup>1</sup>





<b>420 SDI</b>	2,0	77	20 T2N <L-Serie> Fg.-Nr. YD 471064→	10.95-03.00	4	<b>0 432 193 571</b> <sup>1</sup>
			Fg.-Nr. →YD 471063	10.95-03.00	4	<b>0 432 193 601</b>
					4	<b>0 432 193 819</b>
					4	<b>0 432 193 820</b> <sup>1</sup>
<b>Serie 400 Tourer</b>						
<b>418 TD</b>	1,8	65	XUD7TE <PSA>	02.96-03.00 BO	4	<b>0 432 217 200</b>
<b>Serie 600</b>						
<b>620 SDi</b>	2,0	77	20 T2N <L-Serie>	03.95-12.98	4	<b>0 432 193 819</b>
					4	<b>0 432 193 820</b> <sup>1</sup>
<b>Serie 800</b>						
<b>825 TD</b>	2,5	87/88	VM-425-SLIER; VM-425-SLIRR	10.91-12.98	4	<b>0 432 217 222 0 986 430 249</b>
		92	VM-425-CLIER	01.96-12.98	4	<b>0 432 217 222 0 986 430 249</b>
					4	<b>0 432 217 249</b> <sup>1</sup>
<b>25</b>						
<b>2.0 iDT</b>	2,0	74/83	20 T2N <L-Serie>	02.00-05.05	4	<b>0 432 193 571</b> <sup>1</sup>
					4	<b>0 432 193 601</b>
<b>45</b>						
<b>2.0 iDT</b>	2,0	74/83	20 T2N <L-Serie>	02.00-05.05	4	<b>0 432 193 571</b> <sup>1</sup>
					4	<b>0 432 193 601</b>

**SAAB (SAAB AUTOMOBILE AB)**

<b>9-3</b>						
<b>2.2 TiD [9440]</b>	2,2	95	D223L Fg.-Nr. →12020000	09.02-08.04	4	<b>0 432 193 688</b>
			Fg.-Nr. 12020001→	09.02-08.04	4	<b>0 432 193 569</b>
<b>16V D Turbo [9400]</b>	2,2	85	D223L <X 22 DTH> Fg.-Nr. →12020000	02.98-11.00	4	<b>0 432 193 688</b>
			Fg.-Nr. 12020001→	02.98-11.00	4	<b>0 432 193 569</b>
		92	D223L <Y 22 DTH> Fg.-Nr. →12020000	11.00-09.02	4	<b>0 432 193 688</b>
			Fg.-Nr. 12020001→	11.00-09.02	4	<b>0 432 193 569</b>
<b>9-3 Coupé</b>						
<b>2.2 16V D Turbo [9400]</b>	2,2	92	D223L <Y 22 DTH> Fg.-Nr. →12020000	11.00-09.02	4	<b>0 432 193 688</b>
			Fg.-Nr. 12020001→	11.00-09.02	4	<b>0 432 193 569</b>
<b>9-5</b>						
<b>2.2 TiD [9600]</b>	2,2	88	D223L	03.02-08.05	4	<b>0 432 193 570</b>
<b>9-5 Kombi</b>						
<b>2.2 TiD [9600]</b>	2,2	88	D223L	03.02-08.05	4	<b>0 432 193 570</b>

**SEAT**

<b>Alhambra</b>						
<b>1.9 TDI [7V8]</b>	1,9	66	AHU	07.96-02.00	4	<b>0 432 193 829</b> <sup>1</sup>
					4	<b>0 432 193 838</b>
		81	AFN; AVG	05.97-02.00	4	<b>0 432 193 746</b>
<b>Arosa</b>						
<b>1.7 SDI [6H1]</b>	1,7	44	AKU	08.97-10.03	4	<b>0 432 193 680</b> <sup>1</sup>
					4	<b>0 432 193 682</b>
<b>Cordoba</b>						
<b>1.9 D [6K2]</b>	1,9	47-50	1Y	09.93-12.02	4	<b>0 432 217 240 0 986 430 187</b>
		48	AGP	01.00→	4	<b>0 432 217 240 0 986 430 187</b>
<b>SDI [6K2]</b>	1,9	47	AEY	12.95-12.02	4	<b>0 432 193 794</b>
					4	<b>0 432 193 795</b> <sup>1</sup>
		50	AGP	05.99-08.02	4	<b>0 432 193 597</b> <sup>1</sup>
					4	<b>0 432 193 599</b>
			AQM	06.99-08.02	4	<b>0 432 193 597</b> <sup>1</sup>
					4	<b>0 432 193 599</b>





◀ SEAT

1.9 SDI [6L2]	1,9	47	ASY	09.02-12.05	4	0 432 193 573 <sup>1</sup>	
					4	0 432 193 599	
TDI [6K2]	1,9	66	AGR	05.99-12.02	4	0 432 193 732	
					4	0 432 193 734 <sup>1</sup>	
				05.99→	4	0 432 193 732	
					4	0 432 193 734 <sup>1</sup>	
				01.00→	4	0 432 193 829 <sup>1</sup>	
					4	0 432 193 838	
			AHU	07.96-06.99	4	0 432 193 829 <sup>1</sup>	
					4	0 432 193 838	
			ALH	05.99-05.01	4	0 432 193 695	
			1Z	07.96-06.99	4	0 432 193 829 <sup>1</sup>	
					4	0 432 193 838	
		81	AFN	03.97-06.99	4	0 432 193 746	
			ASV	05.99-12.02	4	0 432 193 594	

**Cordoba Vario**

1.9 SDI [6K5]	1,9	47	AEY	06.97-06.99	4	0 432 193 794	
					4	0 432 193 795 <sup>1</sup>	
		50	AGP; AQM	05.99-08.02	4	0 432 193 597 <sup>1</sup>	
					4	0 432 193 599	
TDI [6K5]	1,9	66	AGR	05.99-07.99	4	0 432 193 702	
					4	0 432 193 704 <sup>1</sup>	
				08.99-08.02	4	0 432 193 732	
					4	0 432 193 734 <sup>1</sup>	
			AHU	06.97-06.99	4	0 432 193 829 <sup>1</sup>	
					4	0 432 193 838	
			ALH	05.99-07.99	4	0 432 193 702	
					4	0 432 193 704 <sup>1</sup>	
				08.99-05.01	4	0 432 193 695	
		81	AFN	02.98-06.99	4	0 432 193 746	
			ASV	05.99-08.02	4	0 432 193 594	

**Ibiza**

1.9 D [6K1]	1,9	47-50	1Y	03.93-10.99	4	0 432 217 240	0 986 430 187
SDI [6K1]	1,9	47	AEY	12.95-10.99	4	0 432 193 794	
					4	0 432 193 795 <sup>1</sup>	
		50	AGP	05.99-05.02	4	0 432 193 597 <sup>1</sup>	
					4	0 432 193 599	
			AQM	05.99-05.02	4	0 432 193 597 <sup>1</sup>	
					4	0 432 193 599	
SDI [6L1]	1,9	47	ASY	01.02-12.05	4	0 432 193 599	
			Mot.-Nr. →100 000	01.02-05.02	4	0 432 193 597 <sup>1</sup>	
			Mot.-Nr. 100 001→	06.02-12.05	4	0 432 193 573 <sup>1</sup>	
TDI [6K1]	1,9	66	AGR	05.99-05.02	4	0 432 193 732	
					4	0 432 193 734 <sup>1</sup>	
			AHU	12.96-06.99	4	0 432 193 829 <sup>1</sup>	
					4	0 432 193 838	
			ALH	05.99-05.02	4	0 432 193 695	
		81	AFN	03.97-06.99	4	0 432 193 746	
			ASV	05.99-05.02	4	0 432 193 594	

**Inca**

1.9 D	1,9	47	AEY	05.99→	4	0 432 217 240	0 986 430 187
D [6K9]	1,9	47	1Y	11.95-06.03	4	0 432 217 240	0 986 430 187
SDI [6K9]	1,9	47	AEY	12.95-09.00	4	0 432 193 795 <sup>1</sup>	
			AYQ				
			Mot.-Nr. →061 300	09.00-06.03	4	0 432 193 680 <sup>1</sup>	
					4	0 432 193 682	
			Mot.-Nr. 061 301→	09.00-06.03	4	0 432 193 544 <sup>1</sup>	
					4	0 432 193 682	



<b>Leon</b>							
<b>1.9 SDI [1M1]</b>	1,9	50	AQM	Mot.-Nr. →152 596	12.99-10.03	4	<b>0 432 193 597<sup>1</sup></b>
						4	<b>0 432 193 599</b>
				Mot.-Nr. 152 597→	12.99-10.03	4	<b>0 432 193 575<sup>1</sup></b>
						4	<b>0 432 193 599</b>
<b>TDI [1M1]</b>	1,9	66	AGR		12.99-09.02	4	<b>0 432 193 732</b>
						4	<b>0 432 193 734<sup>1</sup></b>
				ALH	03.99-07.04	4	<b>0 432 193 695</b>
				Fg.-Nr. →1M..2R120 000	03.99-04.02	4	<b>0 432 193 693<sup>1</sup></b>
			Fg.-Nr. 1M..2R120 001→	05.02-07.04	4	<b>0 432 193 579<sup>1</sup></b>	
			81	AHF	10.98-09.02	4	<b>0 432 193 746</b>
				ASV	10.99-10.05	4	<b>0 432 193 594</b>
				Mot.-Nr. →402 738	10.99-10.05	4	<b>0 432 193 592<sup>1</sup></b>
Mot.-Nr. 402 739→	10.99-10.05	4		<b>0 432 193 575<sup>1</sup></b>			
<b>Toledo</b>							
<b>1.9 D [1L2]</b>	1,9	47	1Y		05.91-03.99	4	<b>0 432 217 210</b>
<b>SDI [1M2]</b>	1,9	50	AQM		06.00-10.03	4	<b>0 432 193 597<sup>1</sup></b>
						4	<b>0 432 193 599</b>
<b>TDI [1L2]</b>	1,9	66	AHU		06.96-03.99	4	<b>0 432 193 829<sup>1</sup></b>
						4	<b>0 432 193 838</b>
			81	AFN	11.96-03.99	4	<b>0 432 193 746</b>
<b>TDI [1M2]</b>	1,9	66	AGR		04.99-09.02	4	<b>0 432 193 732</b>
						4	<b>0 432 193 734<sup>1</sup></b>
				ALH	04.99-07.04	4	<b>0 432 193 695</b>
				Fg.-Nr. →1M..2..R120 000	04.99-04.02	4	<b>0 432 193 693<sup>1</sup></b>
			Fg.-Nr. 1M..2..R120 001→	05.02-07.04	4	<b>0 432 193 680<sup>1</sup></b>	
			81	AHF	10.98-09.02	4	<b>0 432 193 746</b>
				ASV	10.99-07.04	4	<b>0 432 193 594</b>
				Mot.-Nr. →402 738	10.99-07.04	4	<b>0 432 193 592<sup>1</sup></b>
Mot.-Nr. 402 739→	10.99-07.04	4		<b>0 432 193 575<sup>1</sup></b>			
<b>SKODA</b>							
<b>Fabia</b>							
<b>1.9 SDI [6Y3]</b>	1,9	47	ASY		09.99-12.07	4	<b>0 432 193 599</b>
				Fg.-Nr. →6Y..2..592 833 →6Y..2X043 509	09.99-06.02	4	<b>0 432 193 597<sup>1</sup></b>
				Fg.-Nr. 6Y..2..592 834→6Y..2X043 510→	07.02-12.07	4	<b>0 432 193 573<sup>1</sup></b>
<b>Fabia Combi</b>							
<b>1.9 SDI [6Y5]</b>	1,9	47	ASY		08.00-12.07	4	<b>0 432 193 599</b>
				Fg.-Nr. →6Y..2..592 833 →6Y..2X043 509	08.00-06.02	4	<b>0 432 193 597<sup>1</sup></b>
				Fg.-Nr. 6Y..2..592 834→6Y..2X043 510→	07.02-12.07	4	<b>0 432 193 573<sup>1</sup></b>
<b>Fabia Schrägheck</b>							
<b>1.9 SDI [6Y2]</b>	1,9	47	ASY		09.99-03.08	4	<b>0 432 193 599</b>
				Fg.-Nr. →6Y..2..592 833 →6Y..2X043 509	09.99-06.02	4	<b>0 432 193 597<sup>1</sup></b>
				Fg.-Nr. 6Y..2..592 834→6Y..2X043 510→	07.02-03.08	4	<b>0 432 193 573<sup>1</sup></b>
<b>Felicia</b>							
<b>1.9 D [6U1]</b>	1,9	47	AEF		10.95-08.01	4	<b>0 432 217 240 0 986 430 187</b>
<b>Felicia Combi</b>							
<b>1.9 D [6U5]</b>	1,9	47	AEF		10.95-08.01	4	<b>0 432 217 240 0 986 430 187</b>
<b>Felicia Fun</b>							
<b>1.9 D [6UF]</b>	1,9	47	AEF		08.96-03.01	4	<b>0 432 217 240 0 986 430 187</b>
<b>Octavia</b>							
<b>1.9 SDI [1U2]</b>	1,9	50	AQM		08.00-12.03	4	<b>0 432 193 599</b>
				Fg.-Nr. →1U..3.666 021 →1U..38665 263	08.00-04.02	4	<b>0 432 193 597<sup>1</sup></b>
				Fg.-Nr. 1U..3.666 022→1U..38665 264→	05.02-12.03	4	<b>0 432 193 573<sup>1</sup></b>
<b>SDI, TDI [1U2]</b>	1,9	50/66	AGP; AGR		09.96-12.09	4	<b>0 432 193 732</b>
						4	<b>0 432 193 734<sup>1</sup></b>



◀ SKODA

1.9 TDI [1U2]	1,9	66	ALH	08.00-03.10	AG	4	0 432 193 702	
					GS	4	0 432 193 695	
				Fg.-Nr. →1U..3.666 021 →1U..38665 263	08.00-04.02	AG	4	0 432 193 704 <sup>1</sup>
					GS	4	0 432 193 693 <sup>1</sup>	
				Fg.-Nr. 1U..3.666 022→1U..38665 264→	05.02-03.10	AG	4	0 432 193 584 <sup>1</sup>
					GS	4	0 432 193 579 <sup>1</sup>	
				81	AHF	05.97-01.06	4	0 432 193 746
				ASV	08.00-01.06	4	0 432 193 594	
	Fg.-Nr. →1U..3.666 021 →1U..38665 263	08.00-04.02	4	0 432 193 592 <sup>1</sup>				
	Fg.-Nr. 1U..3.666 022→1U..38665 264→	05.02-01.06	4	0 432 193 542 <sup>1</sup>				

**Octavia Combi**

1.9 SDI [1U5]	1,9	50	AGP	05.97-07.00		4	0 432 193 732	
						4	0 432 193 734 <sup>1</sup>	
				AQM	08.00-12.03	4	0 432 193 599	
				Fg.-Nr. →1U..3.666 021 →1U..38665 263	08.00-04.02	4	0 432 193 597 <sup>1</sup>	
	Fg.-Nr. 1U..3.666 022→1U..38665 264→	05.02-12.03	4	0 432 193 573 <sup>1</sup>				
TDI [1U5]	1,9	66	ALH	08.00-03.10	AG	4	0 432 193 702	
					GS	4	0 432 193 695	
				Fg.-Nr. →1U..3.666 021 →1U..38665 263	08.00-04.02	AG	4	0 432 193 704 <sup>1</sup>
					GS	4	0 432 193 693 <sup>1</sup>	
				Fg.-Nr. 1U..3.666 022→1U..38665 264→	05.02-03.10	AG	4	0 432 193 584 <sup>1</sup>
					GS	4	0 432 193 579 <sup>1</sup>	
				81	AHF	08.97-01.06	4	0 432 193 746
				ASV	08.00-01.06	4	0 432 193 594	
	Fg.-Nr. →1U..3.666 021 →1U..38665 263	08.00-04.02	4	0 432 193 592 <sup>1</sup>				
	Fg.-Nr. 1U..3.666 022→1U..38665 264→	05.02-01.06	4	0 432 193 542 <sup>1</sup>				
TDI, TDI 4x4 [1U5]	1,9	66	AGR	05.98-12.09		4	0 432 193 732	
						4	0 432 193 734 <sup>1</sup>	

**Pick-Up**

1.9 D [6U7]	1,9	47	AEF	01.96-03.01		4	0 432 217 240	0 986 430 187
-------------	-----	----	-----	-------------	--	---	---------------	---------------

**Superb**

2.5 TDI [3U4]	2,5	114	AYM	12.01-08.03		6	0 432 133 794
					DBB	6	0 432 133 792 <sup>1</sup>
				120	BDG	06.03-03.08	6
					6	0 432 133 785	

**SSANGYONG**

**Korando**

2.3 D [KJ]	2,3	58-59	OM 661 D23 <OM 601.990>	07.96-12.05		4	0 432 217 157	0 986 430 197
2.9 D [KJ]	2,9	72	OM 662 D29 <OM 602.910>	07.96-12.05		5	0 432 217 157	0 986 430 197
TD Intercooler 4WD [KJ]	2,9	88	OM 662 LA <OM 602>	07.96-11.98		5	0 432 217 169	0 986 430 173

**Musso**

2.3 D [MJ]	2,3	57-58	OM 661 D23 <OM 601.910>	07.93-12.05		4	0 432 217 157	0 986 430 197
2.9 D [MJ]	2,9	70-74	OM 662 D29 <OM 602.910>	07.93-12.05		5	0 432 217 157	0 986 430 197
D 4WD [MJ]	2,9	70	OM 662 D29 <OM 602.910>	12.94-04.05		5	0 430 211 066	
TD Intercooler [MJ]	2,9	88	OM 662 D29 LA <OM 602.910>	05.97-12.05		5	0 432 217 169	0 986 430 173

**STEYR (STEYR-DAIMLER-PUCH AG)**

**G**

300 DT	3,0	130	OM 606.964	01.98→		6	0 432 217 280	0 986 430 388
--------	-----	-----	------------	--------	--	---	---------------	---------------

**TATA (TELCO)**

**Safari**

2.0 D Turbo	2,0	66	483 DL	02.98-12.08		4	9 430 032 328
D Turbo 4x4	2,0	66	483 DL	08.00-09.07		4	9 430 032 328

**Sierra**

1.9 D	1,9	44-50	483 DL	07.95-06.98		4	9 430 032 280
-------	-----	-------	--------	-------------	--	---	---------------



<b>1.9 D Turbo</b>	1,9	66	483 DL TCIC	06.97-05.02	4	<b>9 430 032 328</b>
<b>Sumo</b>						
<b>1.9 D</b>	1,9	50	483 DL	07.95-07.00	4	<b>9 430 032 280</b>
				08.00→	4	<b>9 430 032 328</b>
D Turbo 4x4	1,9	66	483 DL TCIC	01.98→	4	<b>9 430 032 328</b>
<b>Tatamobile</b>						
<b>1.9 D</b>	1,9	44-50	483 DL	07.95-07.00	4	<b>9 430 032 280</b>
<b>Telcoline</b>						
<b>2.0 TDi</b>	2,0	64		10.03→	4	<b>9 430 032 238</b>
<b>207</b>						
<b>DI 3.0 D</b>	3,0	48	497SP	05.02→	4	<b>F 002 C8Z 208</b>

## UAZ

<b>Hunter 3151</b>						
<b>2.2 D 4x4</b>	2,2	72	5143.1 <Euro 2>	01.06→	4	<b>0 432 193 549</b>

## VAUXHALL

<b>Astra</b>						
<b>1.7 D/DR [F]</b>	1,7	42-44	17 D/DR <OHC>	12.91-02.98	4	<b>0 432 217 299 0 986 430 449</b>
DT [G]	1,7	50	X 17 DTL	03.98-08.00	4	<b>0 432 217 299 0 986 430 449</b>
DTL [F]	1,7	50	X 17 DTL	07.95-02.98	4	<b>0 432 217 299 0 986 430 449</b>
TD [F]	1,7	60	17 DT/TC4 <EE1 OHC>	12.91-02.98 DKF,ZDA	4	<b>9 430 610 128 0 986 433 002</b>
<b>2.0 DTI [G]</b>	2,0	74	Y 20 DTH <Ecotec>			
			Mot.-Nr. →22999999 →25999999	09.00-08.05	4	<b>0 432 193 634</b>
			→28999999 →2H999999			
DTL [G]	2,0	60	X 20 DTL <Turbo>	02.98-08.00 EU2,NC8	4	<b>0 432 193 686</b>
				EU3,NT5	4	<b>0 432 193 633</b>
			Y 20 DTL <Turbo>	09.00-08.05	4	<b>0 432 193 633</b>
<b>2.2 DTI [G]</b>	2,2	92	Y 22 DTR <Turbo>	09.01-08.05	4	<b>0 432 193 569</b>
<b>Astra Estate</b>						
<b>1.7 D/DR [F]</b>	1,7	42-44	17 D/DR <OHC>	12.91-02.98	4	<b>0 432 217 299 0 986 430 449</b>
DT [G]	1,7	50	X 17 DTL	03.98-08.00	4	<b>0 432 217 299 0 986 430 449</b>
DTL [F]	1,7	50	X 17 DTL	07.95-02.98	4	<b>0 432 217 299 0 986 430 449</b>
TD [F]	1,7	60	17 DT <TC4EE1>	12.91-02.98 DKF,ZDA	4	<b>9 430 610 128 0 986 433 002</b>
<b>2.0 DTI [G]</b>	2,0	74	Y 20 DTH <Ecotec>			
			Mot.-Nr. →22999999 →25999999	09.00-08.05	4	<b>0 432 193 634</b>
			→28999999 →2H999999			
DTL [G]	2,0	60	X 20 DTL <Turbo>	03.98-08.00 EU2,NC8	4	<b>0 432 193 686</b>
				EU3,NT5	4	<b>0 432 193 633</b>
			Y 20 DTL <Turbo>	09.00-08.05	4	<b>0 432 193 633</b>
<b>Astra Van</b>						
<b>1.7 D/DR, DTL [F]</b>	1,7	42-44/50	X 17 DTL; 17 D/DR <OHC>	12.91-02.98	4	<b>0 432 217 299 0 986 430 449</b>
DT [G]	1,7	50	X 17 DTL	03.98-08.00	4	<b>0 432 217 299 0 986 430 449</b>
<b>2.0 DTI [G]</b>	2,0	74	Y 20 DTH <Ecotec>			
			Mot.-Nr. →22999999 →25999999	09.00-08.05	4	<b>0 432 193 634</b>
			→28999999 →2H999999			
DTL [G]	2,0	60	X 20 DTL <Turbo>	03.98-08.00 EU2,NC8	4	<b>0 432 193 686</b>
				EU3,NT5	4	<b>0 432 193 633</b>
<b>Combo</b>						
<b>1.7 D</b>	1,7	44	X 17 D 4EE1	04.96-10.01	4	<b>9 430 610 136</b>
			17 D <4EE1>			
			Mot.-Nr. →602344	09.94-10.01 DKF	4	<b>9 430 610 136</b>
<b>Corsa</b>						
<b>1.5 D [B]</b>	1,5	37	X 15 D <4EC1 OHC>			
			Mot.-Nr. →957024	04.96-08.00 DKF	4	<b>9 430 610 136</b>
			Mot.-Nr. 957025→	04.96-08.00 DKF	4	<b>9 430 610 136</b>
			15 D <4EC1>			
			Mot.-Nr. →957024	09.94-08.00 DKF	4	<b>9 430 610 136</b>
			Mot.-Nr. 957025→	09.94-08.00 DKF	4	<b>9 430 610 136</b>





◀ VAUXHALL

<b>1.5 TD [B]</b>	1,5	49	15 TD <T4EC1 Turbo> Mot.-Nr. →957024 Mot.-Nr. 957025→	09.94-08.00 DKF	4	<b>9 430 610 136</b>
				09.94-08.00 DKF	4	<b>9 430 610 136</b>
XTD [B]	1,5	49	X 15 TD <4EE1 Turbo>	04.96-08.00	4	<b>9 430 610 136</b>
<b>1.7 D [B]</b>	1,7	44	X 17 D 4EE1 17 D <4EE1> Mot.-Nr. →602344	04.96-08.00	4	<b>9 430 610 136</b>
				09.94-08.00 DKF	4	<b>9 430 610 136</b>
<b>Frontera</b>						
<b>2.2 DTI [B]</b>	2,2	85/88	X 22 DTH <Turbo>; Y 22 DTH <Turbo>	09.98-09.04 NC8	4	<b>0 432 193 650</b>
<b>2.5 TDS Turbo [A]</b>	2,5	85	VM41B <Venturi-25TD>	06.96-08.98	4	<b>0 432 217 222 0 986 430 249</b>
					4	<b>0 432 217 249<sup>1</sup></b>
<b>2.8 TDI Turbo [A]</b>	2,8	83	4JB1T	02.95-08.98 DKF,EFV	4	<b>9 430 610 163</b>
<b>Monterey</b>						
<b>3.1 TD [A]</b>	3,1	84	4JG2 TC	04.96-08.98	4	<b>9 430 610 141</b>
<b>Omega</b>						
<b>2.0 DTI [B]</b>	2,0	74	X 20 DTH Turbo	09.97-08.00 NT5	4	<b>0 432 193 634</b>
<b>2.2 DTI [B]</b>	2,2	88	Y 22 DTH <Turbo>	06.00-09.03	4	<b>0 432 193 570</b>
<b>2.5 TD, TDI [B]</b>	2,5	96	U 25 TD <R6 Turbo>; X 25 TD <Turbo>	08.96-09.04	6	<b>0 432 217 278 0 986 430 302</b>
					6	<b>0 432 217 279<sup>1</sup></b>
<b>Signum</b>						
<b>2.0 DTI</b>	2,0	74	Y 20 DTH <Ecotec>	05.03-09.05	4	<b>0 432 193 525</b>
<b>2.2 DTI</b>	2,2	86-92	Y 22 DTR <Ecotec>	05.03-09.08	4	<b>0 432 193 525</b>
<b>Sintra</b>						
<b>2.2 TD</b>	2,2	85	X 22 DTH <Turbo>	09.97-09.99	4	<b>0 432 193 688</b>
<b>Vectra</b>						
<b>1.7 TD [B]</b>	1,7	60	X 17 TD <TC4 EE1 Turbo>	09.95-08.01 DKF,ZDA	4	<b>9 430 610 128</b>
<b>2.0 DI [B]</b>	2,0	60	X 20 DTL <Ecotec 16V Turbo> Fg.-Nr. XL000001→ Fg.-Nr. X1000001→ Mot.-Nr. →17062265 Mot.-Nr. 17062266→Fgst.Nr.W7999999	09.96-08.00 09.96-08.00 09.96-08.00 09.96-08.00	4 4 4 4	<b>0 432 193 686</b> <b>0 432 193 633</b> <b>0 432 193 797</b> <b>0 432 193 686</b>
DTI [B]	2,0	74	X 20 DTH <16V Turbo> Fg.-Nr. XL000001→ Fg.-Nr. X1000001→XL000001→ Mot.-Nr. 17062266→Fgst.Nr.W7999999	09.97-08.00 09.97-08.00 09.97-08.00	4 4 4	<b>0 432 193 687</b> <b>0 432 193 634</b> <b>0 432 193 687</b>
			Y 20 DTH <Ecotec> Fg.-Nr. XL000001→ Fg.-Nr. X1000001→ Mot.-Nr. →17062265 Mot.-Nr. 17062266→Fgst.Nr.W7999999	09.00-08.01 09.00-08.01 09.00-08.01 09.00-08.01	4 4 4 4	<b>0 432 193 686</b> <b>0 432 193 633</b> <b>0 432 193 797</b> <b>0 432 193 686</b>
DTI [C]	2,0	74	Y 20 DTH <Ecotec>	04.02-09.05	4	<b>0 432 193 525</b>
<b>2.2 DTI [B]</b>	2,2	92	Y 22 DTR <Turbo>	09.00-08.01	4	<b>0 432 193 569</b>
DTI [C]	2,2	86-92	Y 22 DTR <Turbo Ecotec>	04.02-09.05	4	<b>0 432 193 569</b>
<b>Vectra Estate</b>						
<b>1.7 TD [B]</b>	1,7	60	X 17 TD <TC4 EE1 Turbo>	09.95-08.01 DKF,ZDA	4	<b>9 430 610 128</b>
<b>2.0 DI [B]</b>	2,0	60	X 20 DTL <Ecotec 16V Turbo> Fg.-Nr. X1000001→ Mot.-Nr. →17062265 Mot.-Nr. 17062266→Fgst.Nr.W7999999 Fg.-Nr. XL000001→	09.96-08.00 09.96-08.00 09.96-08.00	4 4 4	<b>0 432 193 633</b> <b>0 432 193 797</b> <b>0 432 193 686</b>
DTI [B]	2,0	74	X 20 DTH <16V Turbo> Fg.-Nr. X1000001→XL000001→ Mot.-Nr. 17062266→Fgst.Nr.W7999999 Fg.-Nr. XL000001→	09.97-08.00 09.97-08.00	4 4	<b>0 432 193 634</b> <b>0 432 193 687</b>
			Y 20 DTH <Ecotec> Fg.-Nr. X1000001→ Mot.-Nr. →17062265 Mot.-Nr. 17062266→Fgst.Nr.W7999999 Fg.-Nr. XL000001→	09.00-08.01 09.00-08.01 09.00-08.01	4 4 4	<b>0 432 193 633</b> <b>0 432 193 797</b> <b>0 432 193 686</b>
DTI [C]	2,0	74	Y 20 DTH <Ecotec>	09.03-09.05	4	<b>0 432 193 525</b>
<b>2.2 DTI [B]</b>	2,2	92	Y 22 DTR <Turbo>	09.00-08.01	4	<b>0 432 193 569</b>
DTI [C]	2,2	86-92	Y 22 DTR <Ecotec>	09.03-09.05	4	<b>0 432 193 569</b>







<b>Zafira</b>							
<b>2.0 DI [A]</b>	2,0	60	X 20 DTL <Turbo Ecotec>	03.99-08.00	EU2,NC8	4	<b>0 432 193 686</b>
					EU3,NT5	4	<b>0 432 193 633</b>
<b>DTI [A]</b>	2,0	74	Y 20 DTH <Ecotec>				
			Mot.-Nr. →22999999 →25999999 →28999999 →2H999999	04.99-06.05		4	<b>0 432 193 634</b>
			Mot.-Nr. 32000001 → 35000001 → 38000001 → 3H000001 →	04.99-06.05		4	<b>0 432 193 525</b>
<b>2.2 DTI [A]</b>	2,2	92	Y 22 DTR <Turbo Ecotec>	03.02-06.05		4	<b>0 432 193 569</b>

**VOLVO**

<b>S40 I</b>							
<b>1.9 D</b>	1,9	70	D4192T2	03.98-07.00		4	<b>0 432 193 753</b>
						4	<b>0 432 193 754<sup>1</sup></b>
<b>S70</b>							
<b>2.5 TDI</b>	2,5	103	D5252T				
			Fg.-Nr. →598544FC1 →596595FC2	01.97-07.00		5	<b>0 432 193 771<sup>1</sup></b>
						5	<b>0 432 193 786</b>
			Fg.-Nr. 598545FC1 → 596596FC2 →	01.97-07.00		5	<b>0 432 193 613<sup>1</sup></b>
						5	<b>0 432 193 615</b>
<b>S80 I</b>							
<b>2.5 TDI</b>	2,5	103	D5252T	08.98-07.01		5	<b>0 432 193 613<sup>1</sup></b>
						5	<b>0 432 193 615</b>
<b>V40 I</b>							
<b>1.9 D</b>	1,9	70	D4192T2	08.98-07.00		4	<b>0 432 193 753</b>
						4	<b>0 432 193 754<sup>1</sup></b>
<b>V70 I</b>							
<b>2.5 TDI</b>	2,5	103	D5252T				
			Fg.-Nr. →587536	01.97-03.00		5	<b>0 432 193 771<sup>1</sup></b>
						5	<b>0 432 193 786</b>
			Fg.-Nr. 587537 →	01.97-03.00		5	<b>0 432 193 613<sup>1</sup></b>
						5	<b>0 432 193 615</b>
<b>V70 II</b>							
<b>2.5 D</b>	2,5	103	D5252T	03.00-07.01		5	<b>0 432 193 613<sup>1</sup></b>
						5	<b>0 432 193 615</b>

**VW (VOLKSWAGEN)**

<b>Bora</b>							
<b>1.9 SDI [1J2]</b>	1,9	50	AGP	09.98-04.01		4	<b>0 432 193 732</b>
						4	<b>0 432 193 734<sup>1</sup></b>
			AQM	09.98-05.05		4	<b>0 432 193 599</b>
			Fg.-Nr. →1J..2..900 000	09.98-04.02		4	<b>0 432 193 597<sup>1</sup></b>
			Fg.-Nr. 1J..3..000 001 →	05.02-05.05		4	<b>0 432 193 573<sup>1</sup></b>
<b>TDI [1J2]</b>	1,9	66	ALH	09.98-05.05	AG	4	<b>0 432 193 702</b>
					GS	4	<b>0 432 193 695</b>
			Fg.-Nr. →1J..2..900 000	09.98-04.02	AG	4	<b>0 432 193 704<sup>1</sup></b>
					GS	4	<b>0 432 193 693<sup>1</sup></b>
			Fg.-Nr. 1J..3..000 001 →	05.02-05.05	AG	4	<b>0 432 193 584<sup>1</sup></b>
		81	AHF	09.98-05.05		4	<b>0 432 193 746</b>
			Fg.-Nr. 1J..3..000 001 →	05.02-05.05		4	<b>0 432 193 577<sup>1</sup></b>
			ASV	05.00-05.05		4	<b>0 432 193 594</b>
			Fg.-Nr. →1J..2..900 000	05.00-04.02		4	<b>0 432 193 592<sup>1</sup></b>
			Fg.-Nr. 1J..3..000 001 →	05.02-05.05		4	<b>0 432 193 542<sup>1</sup></b>
<b>TDI, TDI 4Motion [1J2]</b>	1,9	66	AGR	09.98-05.05		4	<b>0 432 193 732</b>
			Fg.-Nr. →1J..2..900 000	09.98-04.02		4	<b>0 432 193 734<sup>1</sup></b>
			Fg.-Nr. 1J..3..000 001 →	05.02-05.05		4	<b>0 432 193 575<sup>1</sup></b>



◀ VW

Bora Variant							
1.9 TDI [1J6]	1,9	66	AGR		09.98-05.05	4	0 432 193 732
				Fg.-Nr. →1J..2..900 000	09.98-04.02	4	0 432 193 734 <sup>1</sup>
				Fg.-Nr. 1J..3..000 001→	05.02-05.05	4	0 432 193 575 <sup>1</sup>
		81	AHF		05.99-05.05	4	0 432 193 746
				Fg.-Nr. 1J..3..000 001→	05.02-05.05	4	0 432 193 577 <sup>1</sup>
			ASV		05.00-05.05	4	0 432 193 594
				Fg.-Nr. →1J..2..900 000	05.00-04.02	4	0 432 193 592 <sup>1</sup>
				Fg.-Nr. 1J..3..000 001→	05.02-05.05	4	0 432 193 542 <sup>1</sup>
Caddy							
1.7 SDI [9K9]	1,7	42	AHB		07.96-09.00	4	0 432 193 707 <sup>1</sup>
						4	0 432 193 709
1.9 D [9K9]	1,9	47	1Y		11.95-06.03	4	0 432 217 240 0 986 430 187
SDI [9K9]	1,9	47	AYQ		09.00-06.03	4	0 432 193 682
				Mot.-Nr. AYQ 061 301→	05.02-06.03	4	0 432 193 544 <sup>1</sup>
				Mot.-Nr. →AYQ 061 300	09.00-04.02	4	0 432 193 680 <sup>1</sup>
		47-66	AEY		11.95-09.00	4	0 432 193 794
						4	0 432 193 795 <sup>1</sup>
TDI [9K9]	1,9	66	AHU		09.96-09.00	4	0 432 193 829 <sup>1</sup>
						4	0 432 193 838
			ALE		10.97-09.00	4	0 432 193 693 <sup>1</sup>
						4	0 432 193 695
			ALH		09.00-06.03	4	0 432 193 693 <sup>1</sup>
						4	0 432 193 695
Caddy Pickup							
1.9 D [9U7]	1,9	47	AEF		06.96-12.00	4	0 432 217 240 0 986 430 187
Golf III							
1.9 TD [1H1/1W1]	1,9	55	AAZ		09.92-08.98 TW	4	0 432 193 732
						4	0 432 193 734 <sup>1</sup>
						4	0 432 217 284 0 986 430 206
Golf III Cabriolet							
1.9 TDI [1E7]	1,9	66	AHU		08.96-04.98	4	0 432 193 829 <sup>1</sup>
						4	0 432 193 838
			ALE		04.97-04.98	4	0 432 193 693 <sup>1</sup>
						4	0 432 193 695
		81	AFN		07.96-05.98	4	0 432 193 746
Golf III Variant							
1.9 D [1H5]	1,9	47	1Y		07.93-02.99	4	0 432 217 240 0 986 430 187
SDI [1H5]	1,9	47	AEY		01.95-02.99	4	0 432 193 794
						4	0 432 193 795 <sup>1</sup>
TD [1H5]	1,9	55	AAZ		07.93-02.99	4	0 432 217 284 0 986 430 206
TDI [1H5]	1,9	66	AHU		08.96-02.99	4	0 432 193 829 <sup>1</sup>
						4	0 432 193 838
			ALE		05.97-02.99	4	0 432 193 693 <sup>1</sup>
						4	0 432 193 695
		81	AFN		02.96-02.99	4	0 432 193 746
Golf IV							
1.9 SDI [1J1]	1,9	50	AGP		08.97-04.01	4	0 432 193 732
						4	0 432 193 734 <sup>1</sup>
			AQM		11.98-04.02	4	0 432 193 597 <sup>1</sup>
						4	0 432 193 599
					05.02-05.04	4	0 432 193 573 <sup>1</sup>
						4	0 432 193 599
TDI [1J1]	1,9	66	ALH		10.97-04.02 AG	4	0 432 193 702
						4	0 432 193 704 <sup>1</sup>
					GS	4	0 432 193 693 <sup>1</sup>
						4	0 432 193 695
					05.02-05.04 AG	4	0 432 193 584 <sup>1</sup>
						4	0 432 193 702
					GS	4	0 432 193 579 <sup>1</sup>
						4	0 432 193 695





<b>1.9 TDI [1J1]</b>	1,9	81	AHF	10.97-04.02	4	<b>0 432 193 746</b>	
				05.00-12.05	4	<b>0 432 193 594</b>	
					4	<b>0 432 193 738<sup>1</sup></b>	
				05.02-05.04	4	<b>0 432 193 577<sup>1</sup></b>	
					4	<b>0 432 193 746</b>	
				ASV	05.00-04.02	4	<b>0 432 193 592<sup>1</sup></b>
		4	<b>0 432 193 594</b>				
			05.02-05.04	4	<b>0 432 193 542<sup>1</sup></b>		
				4	<b>0 432 193 594</b>		
<b>TDI, TDI 4Motion [1J1]</b>	1,9	66	AGR	10.97-09.02	4	<b>0 432 193 732</b>	
					4	<b>0 432 193 734<sup>1</sup></b>	

**Golf IV Cabriolet**

<b>1.9 TDI [1E7]</b>	1,9	66	AHU	04.98-06.00	4	<b>0 432 193 829<sup>1</sup></b>			
					4	<b>0 432 193 838</b>			
				ALE	04.98-12.01	4	<b>0 432 193 693<sup>1</sup></b>		
					4	<b>0 432 193 695</b>			
				81	AFN	04.98-08.99	4	<b>0 432 193 746</b>	
					AVG	08.99-10.00	4	<b>0 432 193 746</b>	

**Golf IV Station Wagon**

<b>1.9 TDI [1J5]</b>	1,9	81	AHF	04.02-12.05	4	<b>0 432 193 594</b>	
					4	<b>0 432 193 738<sup>1</sup></b>	

**Golf IV Variant**

<b>1.9 SDI [1J5]</b>	1,9	50	AGP	05.00-04.01	4	<b>0 432 193 732</b>				
					4	<b>0 432 193 734<sup>1</sup></b>				
				AQM	05.99-04.02	4	<b>0 432 193 597<sup>1</sup></b>			
					4	<b>0 432 193 599</b>				
					05.02-06.06	4	<b>0 432 193 573<sup>1</sup></b>			
					4	<b>0 432 193 599</b>				
<b>TDI [1J5]</b>	1,9	66	ALH	05.99-04.02	AG	4	<b>0 432 193 702</b>			
						4	<b>0 432 193 704<sup>1</sup></b>			
					GS	4	<b>0 432 193 693<sup>1</sup></b>			
						4	<b>0 432 193 695</b>			
					05.02-06.06	AG	4	<b>0 432 193 584<sup>1</sup></b>		
						4	<b>0 432 193 702</b>			
						GS	4	<b>0 432 193 579<sup>1</sup></b>		
						4	<b>0 432 193 695</b>			
					81	AHF	05.99-04.02	4	<b>0 432 193 746</b>	
							05.02-06.06	4	<b>0 432 193 577<sup>1</sup></b>	
								4	<b>0 432 193 746</b>	
						ASV	05.02-06.06	4	<b>0 432 193 542<sup>1</sup></b>	
				4	<b>0 432 193 594</b>					
<b>TDI, TDI 4Motion [1J5]</b>	1,9	66	AGR	05.99-04.02		4	<b>0 432 193 732</b>			
						4	<b>0 432 193 734<sup>1</sup></b>			
					05.99-09.02	4	<b>0 432 193 732</b>			
						4	<b>0 432 193 734<sup>1</sup></b>			

**Jetta**

<b>1.9 TD [1H2/1W2]</b>	1,9	55	AAZ	08.92-07.98	4	<b>0 432 217 284</b>	<b>0 986 430 206</b>
<b>TDI [1H2/1W2]</b>	1,9	66	1Z	08.95→	4	<b>0 432 193 794</b>	
					4	<b>0 432 193 795<sup>1</sup></b>	

**Jetta IV**

<b>1.9 TDI [1J2]</b>	1,9	81	AHF	09.99-12.05	4	<b>0 432 193 746</b>	
----------------------	-----	----	-----	-------------	---	----------------------	--

**Lupo**

<b>1.7 SDI [6X1]</b>	1,7	44	AKU	10.98-07.05	4	<b>0 432 193 682</b>		
				Fg.-Nr. →6E..2..010 000→6X..2..080 000	10.98-04.02	4	<b>0 432 193 680<sup>1</sup></b>	
				Fg.-Nr. 6E..3..000 001→6X..3..000 001→	05.02-07.05	4	<b>0 432 193 544<sup>1</sup></b>	

**New Beetle**

<b>1.9 TDI [1C1/9C1]</b>	1,9	66	ALH	01.98-06.04	AG	4	<b>0 432 193 702</b>	
						4	<b>0 432 193 704<sup>1</sup></b>	
					GS	4	<b>0 432 193 695</b>	
				Fg.-Nr. →1C..2..999 000	01.98-05.02	GS	4	<b>0 432 193 693<sup>1</sup></b>





◀ VW

Passat								
1.9 TDI [3B2]	1,9	66	AHH	08.97-11.00	4	0 432 193 702		
			AHU	10.96-11.00	4	0 432 193 704 <sup>1</sup>		
TDI, TDI Syncro [3B2]	1,9	81	AFN	10.96-11.00	4	0 432 193 746		
			AVG	08.99-11.00	4	0 432 193 746		
2.5 TDI [3B3]	2,5	120	BDG	05.03-05.05	6	0 432 133 783 <sup>1</sup>		
					6	0 432 133 794		
TDI, TDI Syncro [3B2]	2,5	110	AFB	08.98-11.00	6	0 432 133 833 <sup>1</sup>		
					6	0 432 133 835		
			AKN	08.98-11.00	AG	6	0 432 133 815 <sup>1</sup>	
					GS	6	0 432 133 822 <sup>1</sup>	
TDI, TDI 4Motion [3B3]	2,5	110	AKN	10.00-05.03	AG	6	0 432 133 815 <sup>1</sup>	
					GS	6	0 432 133 822 <sup>1</sup>	
TDI 4Motion [3B3]	2,5	132	BAU	01.03-05.05		6	0 432 133 794	
					DBB	6	0 432 133 792 <sup>1</sup>	
TDI 4Motion [3B3]	2,5	132	BDH	01.03-05.05		6	0 432 133 783 <sup>1</sup>	
						6	0 432 133 794	

Passat Variant								
1.9 TDI [3B5]	1,9	66	AHH	05.98-11.00	4	0 432 193 702		
			AHU	05.97-11.00	4	0 432 193 704 <sup>1</sup>		
TDI, TDI Syncro [3B5]	1,9	81	AFN	05.97-08.00	4	0 432 193 746		
				05.97-11.00	4	0 432 193 746		
			AVG	08.99-11.00	4	0 432 193 746		
2.5 TDI [3B6]	2,5	120	BDG	05.03-05.05	6	0 432 133 783 <sup>1</sup>		
					6	0 432 133 794		
TDI, TDI Syncro [3B5]	2,5	110	AFB	08.98-11.00	6	0 432 133 833 <sup>1</sup>		
					6	0 432 133 835		
			AKN	05.99-11.00	AG	6	0 432 133 815 <sup>1</sup>	
					GS	6	0 432 133 822 <sup>1</sup>	
TDI, TDI 4Motion [3B6]	2,5	110	AKN	10.00-05.03	AG	6	0 432 133 815 <sup>1</sup>	
					GS	6	0 432 133 822 <sup>1</sup>	
TDI 4Motion [3B6]	2,5	132	BAU	01.03-05.05		6	0 432 133 794	
					DBB	6	0 432 133 792 <sup>1</sup>	
TDI 4Motion [3B6]	2,5	132	BDH	01.03-05.05		6	0 432 133 783 <sup>1</sup>	
						6	0 432 133 794	

Polo							
1.7 SDI [6N1]	1,7	42	AHG	04.97-12.99	4	0 432 193 707 <sup>1</sup>	
					4	0 432 193 709	
SDI [6N2]	1,7	42	AKU	05.97-12.99	4	0 432 193 680 <sup>1</sup>	
					4	0 432 193 682	
SDI [6N2]	1,7	42	AHG	10.99-09.01	4	0 432 193 707 <sup>1</sup>	
					4	0 432 193 709	
SDI [6N2]	1,7	42	AKU	10.99-09.01	4	0 432 193 680 <sup>1</sup>	
					4	0 432 193 682	
1.9 D [6N1]	1,9	47	AEF	10.94-12.99	4	0 432 217 240	0 986 430 187
			AGD	07.96-12.99	4	0 432 193 794	
D [6N2]	1,9	47	AEF	10.99-09.01	4	0 432 217 240	0 986 430 187
			AGD	10.99-09.01	4	0 432 193 794	
SDI [6N2]	1,9	47	AGD	10.99-09.01	4	0 432 193 794	
					4	0 432 193 795 <sup>1</sup>	



1.9 SDI [6N2]	1,9	47	ASX		10.99-09.01	4	0 432 193 732	
						4	0 432 193 734 <sup>1</sup>	
SDI [9N1]	1,9	47	ASY		09.01-05.05	4	0 432 193 599	
				Fg.-Nr. →9N..2..120 000	09.01-04.02	4	0 432 193 597 <sup>1</sup>	
				Fg.-Nr. 9N..3..000 001→	05.02-05.05	4	0 432 193 573 <sup>1</sup>	
SDI [9N2]	1,9	47	ASY		11.03-05.07	4	0 432 193 573 <sup>1</sup>	
						4	0 432 193 599	
SDI [9N3]	1,9	47	ASY		04.05-12.09	4	0 432 193 573 <sup>1</sup>	
						4	0 432 193 599	

**Polo Classic**

1.7 SDI [6V2]	1,7	44	AKW		11.97-08.99	4	0 432 193 680 <sup>1</sup>	
						4	0 432 193 682	
1.9 SD	1,9	47	1Y <M9N>		05.96-08.08	4	0 432 217 240	0 986 430 187
SDI [6V2]	1,9	47	AEY		12.95-08.99	4	0 432 193 794	
						4	0 432 193 795 <sup>1</sup>	
		50	AGP		08.99-09.01	4	0 432 193 597 <sup>1</sup>	
						4	0 432 193 599	
			AQM		08.99-09.01	4	0 432 193 597 <sup>1</sup>	
						4	0 432 193 599	
TDI	1,9	66	AGR		09.00-08.08	4	0 432 193 732	
						4	0 432 193 734 <sup>1</sup>	
			AHU <M2K>		03.99-08.00	4	0 432 193 829 <sup>1</sup>	
						4	0 432 193 838	
TDI [6V2]	1,9	66	AGR		10.99-09.01	4	0 432 193 732	
						4	0 432 193 734 <sup>1</sup>	
			AHU		07.96-08.99	4	0 432 193 829 <sup>1</sup>	
						4	0 432 193 838	
			ALE		11.97-08.99	4	0 432 193 693 <sup>1</sup>	
						4	0 432 193 695	
			ALH		10.99-09.01	4	0 432 193 693 <sup>1</sup>	
						4	0 432 193 695	
		81	AFN		06.98-08.99	4	0 432 193 746	
			ASV		10.99-09.01	4	0 432 193 592 <sup>1</sup>	
						4	0 432 193 594	

**Polo Variant**

1.7 SDI [6V5]	1,7	44	AKW		08.97-08.99	4	0 432 193 680 <sup>1</sup>	
						4	0 432 193 682	
1.9 SDI [6V5]	1,9	47	AEY		06.97-08.99	4	0 432 193 794	
						4	0 432 193 795 <sup>1</sup>	
		50	AGP		10.99-09.01	4	0 432 193 597 <sup>1</sup>	
						4	0 432 193 599	
			AQM		10.99-09.01	4	0 432 193 597 <sup>1</sup>	
						4	0 432 193 599	
TDI [6V5]	1,9	66	AGR		10.99-09.01	4	0 432 193 732	
						4	0 432 193 734 <sup>1</sup>	
			AHU		06.97-08.99	4	0 432 193 829 <sup>1</sup>	
						4	0 432 193 838	
			ALE		11.97-08.99	4	0 432 193 693 <sup>1</sup>	
						4	0 432 193 695	
			ALH		10.99-09.01	4	0 432 193 693 <sup>1</sup>	
						4	0 432 193 695	
		81	AFN		06.98-08.99	4	0 432 193 746	
			ASV		10.99-09.01	4	0 432 193 592 <sup>1</sup>	
						4	0 432 193 594	

**Sharan**

1.9 TDI [7M8]	1,9	66	AHU		07.96-02.00	4	0 432 193 829 <sup>1</sup>	
						4	0 432 193 838	
		81	AFN; AVG		09.96-02.00	4	0 432 193 746	





**ASTRA**

BM						
44 D 12 R	8,1	118	OM-8360.05.200	04.91→	6	0 432 281 710
201	8,0	118	OM-8360.05.200; OM-8360.05.300	06.79→	6	0 432 281 710

**AVIA**

A						
21 T	3,6	76	D421.76.01 <Euro 2>	10.96-12.98	4	0 432 133 831
31 T	3,6	76	D421.76.01 <Euro 2>	10.96-12.98	4	0 432 133 831
60	3,6	76	D421.76.00 <Euro 2>	10.96-12.98	4	0 432 133 831
			85	D421.85.00 <Euro 2>	01.97-07.00 KOC	4
75	3,6	76	D421.76.00 <Euro 2>	10.96-12.98	4	0 432 133 831
			85	D421.85.00 <Euro 2>	01.97-07.00 KOC	4

**CHERKASSKY BUS**

Bogdan						
A092	4,8	107	4HE1-XS <Euro 2>	06.03→	4	9 430 613 139
			4HE1-XS <Euro 3>	06.08→ ZDA	4	9 430 613 447 <sup>1</sup>
A0921	4,8	107	4HE1-XS <Euro 2>	12.04→	4	9 430 613 139
			4HE1-XS <Euro 3>	01.08→ ZDA	4	9 430 613 447 <sup>1</sup>
A09202	4,6	89	4HG1-T <Euro 2>	12.04→ ZDA	4	9 430 613 635
A09212	4,6	89	4HG1-T <Euro 2>	12.04→ ZDA	4	9 430 613 635

**CHEVROLET**

Luv						
3.0 D-MAX	3,0	96	4JH1-TC	09.04→ ZDA	4	9 430 613 961

Silverado						
4.1 D	4,1	66	S4	11.96-12.01	4	F 000 439 008

**CITROEN**

Jumper						
1.9 D [23]	1,9	51	DJY <XUD9>; D9B <XUD9AU>	02.94-02.02	4	0 432 217 248 0 986 430 244
			D Turbo [23]	DHX <XUD9UTF>; D8C <XUD9UTF>	02.94-02.02	4
2.5 D [23]	2,5	63	T9A <DJ5>	02.94-02.02	4	0 432 217 268 0 986 430 381
			TDi [23]	THX <DJ5TED>	10.96-02.02	4
2.8 D [23]	2,8	64	8140 63 <SOFIM 2800>	01.99-02.02	4	0 432 117 002
			T	8140 43 <SOFIM 2800 TD>	12.01-08.05	4

**DAF**

CF							
65 .180	6,2	133	NS 133 M <EURO 2>	03.98-05.00	6	0 432 191 644	
			.210	NS 156 M <EURO 2>	02.98-04.02 TW	6	0 432 191 593
						6	0 432 191 647
.240	6,2	177	NS 177 M <EURO 2>	03.98-03.01	6	0 432 191 593	
75 .250	9,2	183	PE 183 <Euro3>	12.99-06.02	6	0 432 191 470	
				02.01-02.07 MEB	6	0 432 191 254	
			.250, .290, .320	PF 183 <Euro 2>; PF 212 <Euro 2>; PF 235 <Euro 2>	12.97-04.02	6	0 432 191 570
			.290, .320	PE 212 <Euro3>; PE 235 <Euro3>	01.99-02.02	6	0 432 191 470
			.310	PE 228 <Euro3>	02.01-07.07 MEB,TW	6	0 432 191 254
			6	0 432 191 382			





<b>75</b>	.360	9,2	265	PE 265 <Euro3>	02.01-05.07	TW	6	<b>0 432 191 254</b>	
							6	<b>0 432 191 382</b>	
<b>85</b>	.250, .380, .430	12,6	250/280/315	XF 250 <Euro 2>; XF 280 <Euro 2>; XF 315 <Euro 2>	10.97-09.02		6	<b>0 432 191 583</b>	
	.340	12,6	250	XE 250 <Euro 3>	07.99-01.02		6	<b>0 432 191 504</b>	
					09.06-01.08		6	<b>0 432 191 253</b>	
	.380	12,6	280	XE 280 <Euro 3>	08.99-02.02		6	<b>0 432 191 504</b>	
					06.01-12.07		6	<b>0 432 191 253</b>	
	.430	12,6	315	XE 315 <Euro 3>	09.99-01.02		6	<b>0 432 191 504</b>	
					01.01-10.07		6	<b>0 432 191 253</b>	
	.480	12,6	355	XE 355 <Euro 3>	10.01-10.07		6	<b>0 432 191 253</b>	
<b>XF</b>									
<b>95</b>	.380	12,6	280	XE 280 C <Euro 3>	04.98-04.03		6	<b>0 432 191 504</b>	
				XF280M <Euro 2>	01.97-04.02	TW	6	<b>0 432 191 583</b>	
							6	<b>0 432 191 604</b>	
	.380, .430, .480	12,6	280/315/355	XE 280 <Euro 3>; XE 315 <Euro 3>; XE 355 <Euro 3>	01.02-12.07	TW	6	<b>0 432 191 253</b>	
							6	<b>0 432 191 315</b>	
	.430	12,6	315	XE 315 C <Euro 3>	01.99-08.03		6	<b>0 432 191 504</b>	
				XF315M <Euro 2>	01.97-12.02		6	<b>0 432 191 583</b>	
	.460	12,6	335	XE 335 <Euro 3>	02.04-02.07		6	<b>0 432 191 315</b>	
	.480	12,6	355	XE 355 C <Euro 3>	05.98-09.03	TW	6	<b>0 432 191 315</b>	
							6	<b>0 432 191 504</b>	
				XF355M <Euro 2>	01.97-04.02	TW	6	<b>0 432 191 583</b>	
							6	<b>0 432 191 604</b>	
	.530	12,6	390	XE 390 C <Euro 3>	11.99-09.03		6	<b>0 432 191 504</b>	
					11.01-01.07	TW	6	<b>0 432 191 253</b>	
							6	<b>0 432 191 315</b>	
<b>65</b>									
<b>.180</b>	ATi	6,2	133	NS 133 M <EURO 2>	01.93-08.98		6	<b>0 432 191 644</b>	
<b>.210</b>	ATi	6,2	156	NS 156 M <EURO 2>	01.93-04.02		6	<b>0 432 191 647</b>	
<b>.240</b>	ATi	6,2	177	NS 177 L	03.96-08.98		6	<b>0 432 191 593</b>	
<b>75</b>									
<b>.240</b>	ATi	8,7	180	RS 180 M <Euro 2>	03.93-12.99		6	<b>0 432 191 570</b>	
						TW	6	<b>0 432 191 703</b>	
							6	<b>0 432 191 704</b>	
<b>.270</b>	ATi	8,7	200	RS 200 M <Euro 2>	03.93-04.02		6	<b>0 432 191 704</b>	
<b>.300</b>	ATi	8,7	222	RS 222 M <Euro 2>	03.93-12.98		6	<b>0 432 191 673</b>	
<b>85</b>									
<b>.330</b>	ATi	11,6	242	WS 242 <Euro 1/2>	02.90-12.98	TW	6	<b>0 432 291 528</b>	
							6	<b>0 432 291 542</b>	
<b>.360</b>	ATi	11,6	268	WS 268 <Euro 1/2>	12.91-12.98	TW	6	<b>0 432 291 528</b>	
							6	<b>0 432 291 542</b>	
							6	<b>0 432 291 543</b>	
							6	<b>0 432 291 587</b>	
<b>.400</b>	ATi	11,6	295	WS 295 <Euro 1/2>	05.95-12.99	TW	6	<b>0 432 291 528</b>	
							6	<b>0 432 291 543</b>	
<b>95</b>									
<b>.400</b>	ATi	11,6	295	WS 295 <Euro 0/1/2>	10.89-09.98	KOC,TW	6	<b>0 432 291 588</b>	
						TW	6	<b>0 432 291 525</b>	
							6	<b>0 432 291 528</b>	
							6	<b>0 432 291 543</b>	
							6	<b>0 432 291 561</b>	
							6	<b>0 432 291 587</b>	
<b>.430</b>	ATi	11,6	315	WS 315 <Euro 0/1/2>	04.91-12.98		6	<b>0 432 191 583</b>	
						KOC,TW	6	<b>0 432 291 603</b>	
						TW	6	<b>0 432 291 525</b>	
							6	<b>0 432 291 528</b>	
							6	<b>0 432 291 543</b>	
							6	<b>0 432 291 561</b>	





**FIAT**

<b>Ducato</b>									
2.5 D	2,5	62	8140.67.2200		11.97-12.99	4	0 432 297 057	0 986 430 532	
2.8 D	2,8	63	8140.63.22.60 <PC/NA>		04.99-05.05	4	0 432 117 002		
D Turbo	2,8	90	8140.43.22.00 <ID/TCA>		04.99-08.00	4	0 432 193 666		
					09.00-05.05	4	0 432 193 757	0 986 430 522	
D Turbo Interc.	2,8	103,3	8140.43.22.00 <ID/TCA>		10.99-05.05	4	0 432 193 757	0 986 430 522	
<b>Ducato Cargo</b>									
2.5 D	2,5	62	8140.67.2200		11.97-05.05	4	0 432 297 057	0 986 430 532	
2.8 D	2,8	63	8140.63.22.60 <PC/NA>		04.99-05.05	4	0 432 117 002		
D Turbo	2,8	90	8140.43.22.00 <ID/TCA>		04.99-08.00	4	0 432 193 666		
					09.00-05.05	4	0 432 193 757	0 986 430 522	
<b>Ducato Combinato</b>									
2.8 D, iDTD	2,8	66/76	8140.63		06.98→	4	0 432 117 002		
<b>Ducato Furgon</b>									
2.8 D	2,8	66	8140.63		06.98-11.04	4	0 432 117 002		
<b>Ducato 10</b>									
1.9 D, TD, TD CAT [230]	1,9	51/59/60	230 A2.000 <M1>; 230 A3.000 <M2>; 230 A4.000 <M3>		03.94-03.98	4	0 432 217 195		
2.5 D [230]	2,5	62	8140.67 <M4>		03.94-03.98	4	0 432 297 057	0 986 430 532	
TD ECO [230]	2,5	80	8140.47R <M7>		03.94-03.98	4	0 432 193 842 <sup>1</sup>		
						4	0 432 193 843		
TD EGR, TD EGR 4x4 [230]	2,5	85	8140.47 <M6>		03.94-03.98	4	0 432 193 845	0 986 430 256	
TD 4x4 [230]	2,5	85	8140.47 <M5>						
			Mot.-Nr. →1997700		03.94-04.98	4	0 432 193 845	0 986 430 256	
2.8 D [230]	2,8	64	8140.63 <M10>		04.98-03.02	4	0 432 117 002		
TD EGR, TD EGR 4x4 [230]	2,8	90	8140.43 <M9>						
			Mot.-Nr. →3050379		11.98-03.00	4	0 432 193 666		
			Mot.-Nr. 3050380→		04.00-03.02	4	0 432 193 757	0 986 430 522	
TD, TD 4x4 [230]	2,8	90	8140.43 <M8>						
			Mot.-Nr. →3050379		11.98-03.00	4	0 432 193 666		
			Mot.-Nr. 3050380→		04.00-03.02	4	0 432 193 757	0 986 430 522	
<b>Ducato 11</b>									
2.8 TD, TD EGR, TD EGR 4x4 [244]	2,8	90	8140.43 <M25>; 8140.43 <M26>		10.02-08.06	4	0 432 193 757	0 986 430 522	
<b>Ducato 14</b>									
1.9 TD, TD CAT [230]	1,9	59/60	230 A3.000 <M2>; 230 A4.000 <M3>		03.94-03.98	4	0 432 217 195		
2.5 D [230]	2,5	62	8140.67 <M4>		03.94-03.98	4	0 432 297 057	0 986 430 532	
TD [230]	2,5	85	8140.47 <M5>						
			Mot.-Nr. →1997700		03.94-03.02	4	0 432 193 845	0 986 430 256	
TD ECO, TD ECO 4x4 [230]	2,5	80	8140.47R <M7>		03.94-03.98	4	0 432 193 842 <sup>1</sup>		
						4	0 432 193 843		
TD EGR, TD EGR 4x4 [230]	2,5	85	8140.47 <M6>		03.94-03.98	4	0 432 193 845	0 986 430 256	
2.8 D [230]	2,8	64	8140.63 <M10>		04.98-03.02	4	0 432 117 002		
TD EGR, TD EGR 4x4 [230]	2,8	90	8140.43 <M9>						
			Mot.-Nr. →3050379		11.98-03.00	4	0 432 193 666		
			Mot.-Nr. 3050380→		04.00-03.02	4	0 432 193 757	0 986 430 522	
TD, TD 4x4 [230]	2,8	90	8140.43 <M8>						
			Mot.-Nr. →3050379		11.98-03.00	4	0 432 193 666		
			Mot.-Nr. 3050380→		04.00-03.02	4	0 432 193 757	0 986 430 522	
<b>Ducato 15</b>									
2.8 TD, TD EGR, TD EGR 4x4, TD 4x4 [244]	2,8	90	8140.43 <M25>; 8140.43 <M26>		10.02-08.06	4	0 432 193 757	0 986 430 522	
<b>Ducato 18</b>									
2.5 D, D 4x4 [230]	2,5	62	8140.67 <M4>		03.94-03.98	4	0 432 297 057	0 986 430 532	
TD ECO [230]	2,5	80	8140.47R <M7>		03.94-03.98	4	0 432 193 842 <sup>1</sup>		
						4	0 432 193 843		
TD, TD 4x4 [230]	2,5	85	8140.47 <M5>						
			Mot.-Nr. →1997700		03.94-03.02	4	0 432 193 845	0 986 430 256	
2.8 D, D 4x4 [230]	2,8	64	8140.63 <M10>		04.98-03.02	4	0 432 117 002		





2.8 TD EGR, TD EGR 4x4 [230]	2,8	90	8140.43 <M9>					
			Mot.-Nr. →3050379	11.98-03.00	4	0 432 193 666		
			Mot.-Nr. 3050380→	04.00-03.02	4	0 432 193 757	0 986 430 522	
TD, TD 4x4 [230]	2,8	90	8140.43 <M8>					
			Mot.-Nr. →3050379	11.98-03.00	4	0 432 193 666		
			Mot.-Nr. 3050380→	04.00-03.02	4	0 432 193 757	0 986 430 522	
TD, TD 4x4 [244]	2,8	90	8140.43 <M25>	10.02-08.06	4	0 432 193 757	0 986 430 522	

## FORD

<b>A</b>								
0407	2,5	50-51	4AB, 4CA	01.86-12.99	KOC	4	0 432 191 836	
<b>Cargo</b>								
1317	9,6	125	F6L 413 F	08.82-12.99		6	0 432 291 807	0 986 430 124
1320	9,6	150	F6L 413 FZ	07.93-12.99		6	0 432 291 644	
1517	9,6	125	F6L 413 F	08.82-12.99		6	0 432 291 807	0 986 430 124
2420	9,6	150	F6L 413 FZ	07.93-12.99		6	0 432 291 644	
2817	9,6	125	F6L 413 F	04.82-12.99		6	0 432 291 807	0 986 430 124
3020	9,6	150	F6L 413 FZ	07.93-12.99		6	0 432 291 644	
<b>Econovan</b>								
2.0 D	2,0	41	RF <Mazda>	02.86-12.99	ZDA	4	9 430 610 007	
<b>Serie F</b>								
100 3.9 D 4x4	3,9	49		01.83-08.99		4	F 000 439 009	
<b>Transit</b>								
FT 300 S 2.4 TDI [00]	2,4	74	<IDI24>	01.01-05.06		4	0 432 133 768	
FT 330 L 2.4 TDI [00]	2,4	66/88	<IDI24>	01.01-05.06		4	0 432 193 838	
FT 330 M 2.4 TDI [00]	2,4	66/88	<IDI24>	01.01-05.06		4	0 432 193 838	
FT 330 S 2.4 TDI [00]	2,4	66	<IDI24>	01.01-05.06		4	0 432 193 838	
		74	<IDI24>	01.01-05.06		4	0 432 133 768	
						4	0 432 193 838	
		88	<IDI24>	01.01-05.06		4	0 432 193 838	
FT 350 E 2.4 TDI [00]	2,4	66/88/96	<IDI24>	01.01-05.06		4	0 432 193 838	
FT 350 L 2.4 TDI [00]	2,4	66/88/96	<IDI24>	01.01-05.06		4	0 432 193 838	
FT 350 M 2.4 TDI [00]	2,4	66/88/96	<IDI24>	01.01-05.06		4	0 432 193 838	
FT 430 E 2.4 TDI [00]	2,4	96	<IDI24>	06.04-05.06		4	0 432 193 838	

## GMC (GENERAL MOTORS CORP.)

<b>GMC</b>								
3500 HD	4,2	110	6.07T <Sprint 6.07T>	08.96-12.99		6	0 432 193 691	
				01.00-12.01		6	0 432 193 565	

## GOLAZ GOLITSINO

<b>Serie 6000</b>								
6228	9,0	221	DC 9.03 <Euro 3>	01.06→		6	0 432 191 464 <sup>1</sup>	
6298	9,0	221	DC 9.03 <Euro 3>	01.00→		6	0 432 191 464 <sup>1</sup>	
<b>Serie 50000</b>								
52911	9,0	221	DC 9.03 <Euro 3>	01.07→		6	0 432 191 464 <sup>1</sup>	

## HEULIEZ

<b>GX</b>								
77 H	5,5	117	MIDS 06.02.12 B	01.90→		6	0 432 281 695	0 986 430 342



**IKARUS**











Serie 200							
255	10,4	141	Raba/D 2156 HM6U	01.71-12.02	KOC	6	0 432 221 849
260 .22	10,4	141	Raba/D 2156 HM6U	06.78→	KOC	6	0 432 221 849
.29	10,7	162	Raba/D 2356 HM6U	01.81→		6	0 432 221 865
280 .25	10,7	162	Raba/D 2356 HM6U	01.78→		6	0 432 221 865

**ISUZU**

Elf NPR 115							
3.2 TD	3,2	101	4BD1-T	10.97→		4	9 430 613 298
FTM 1200T							
7.1 D Turbo	7,1	169	6HE1-TC	05.99→		6	9 430 615 401
FTR 32MT							
7.1 D Turbo	7,1	169	6HE1-TC	05.99→	ZDA	6	9 430 610 534
FTR 800							
8.2 D	8,2	147	6HH1-S	05.99→	ZDA	6	9 430 610 534
D Turbo	8,2	129	6HH1-N	05.99→	ZDA	6	9 430 615 290
FVR 900T							
9.8 D Turbo	9,8	199	6SD1TC-N	05.99→	ZDA	6	9 430 611 665
FVR 2300							
9.8 D Turbo	9,8	199	6SD1TC-N	05.99→	ZDA	6	9 430 611 665
FVZ 1400T							
9.8 D Turbo	9,8	199	6SD1TC-N	05.99→		6	9 430 615 296
					ZDA	6	9 430 611 665
N-Serie							
NHR 55E 2.8 D Turbo, 2.8 TD	2,8	67/70	4JB1T; 4JB1-TC	09.05-12.08	ZDA	4	9 430 613 958
NPR 66L 4.3 D	4,3	78	4HF1	09.99-12.06	ZDA	4	9 430 610 152
NPR 66P 4.3 D	4,3	78	4HF1	09.99-12.06	ZDA	4	9 430 610 152
NPR 300 4.3 D	4,3	78	4HF1	09.99-12.06	ZDA	4	9 430 610 152
NQR 70R 4.8 D Turbo	4,8	104	4HE1-T	09.99-12.06		4	9 430 615 309
NQR 75P 5.2 D Turbo	5,2	110	4HK1 <Euro 3>	07.06→	ZDA	4	9 430 613 635
N100 P 4.3 D Turbo	4,3	78	4HF1-S	02.06-12.08	ZDA	4	9 430 610 152
N250 T Carrier 2.8 D Turbo	2,8	67	4JB1T	09.99-12.07	ZDA	4	9 430 613 958

**IVECO**

Daily							
A40 -10 Turbo, -12 Turbo	2,8	76/90	8140.23.37... <Euro 2>; 8140.43.37... <Euro 2>; 8140.43.3723 <Euro 2>	05.96-05.99		4	0 432 193 757 0 986 430 522
A45 -10 Turbo, -12 Turbo	2,8	76/90	8140.23.3721 <Euro 2>; 8140.43.37... <Euro 2>; 8140.43.3723 <Euro 2>	05.96-05.99		4	0 432 193 757 0 986 430 522
A49 -10 Turbo	2,8	76	8140.23.37... <Euro 2>	05.96-05.99		4	0 432 193 757 0 986 430 522
29 L 9 [00]	2,8	62	8140.63.4000	05.99-12.01		4	0 432 117 002
11 [00]	2,8	78	8140.43C	05.99-09.02		4	0 432 193 757 0 986 430 522
35 10, 12	2,8	76/90	8140.23 <ID/TCA>; 8140.43 <ID/TCA>	11.97-07.07		4	0 432 193 757 0 986 430 522
35 C 9 [00]	2,8	62	8140.63.40...	05.99-12.01		4	0 432 117 002
11 [00]	2,8	78	8140.43C...	05.99-09.02		4	0 432 193 757 0 986 430 522
35 S 9 [00]	2,8	62	8140.63.40...	05.99-12.01		4	0 432 117 002
11 [00]	2,8	78	8140.43C...	05.99-03.02		4	0 432 193 757 0 986 430 522
40 10	2,5	76	8140.27S	11.97-12.01		4	0 432 193 757 0 986 430 522
12	2,8	76	8140.43	11.97-07.07		4	0 432 193 757 0 986 430 522
49 12	2,8	90	8140.43	11.97-07.07		4	0 432 193 757 0 986 430 522
50 C 11 [00]	2,8	78	8140.43C...	05.99-09.02		4	0 432 193 757 0 986 430 522
59 12	2,8	76	8140.43	11.97-07.07		4	0 432 193 757 0 986 430 522
60 12	2,8	90	8140.43	10.02-07.07		4	0 432 193 757 0 986 430 522
Daily, Grinta							
30 -8	2,5	60	8140.67F.37... <Euro 2>	05.96-03.98		4	0 432 297 057 0 986 430 532

										
<b>30</b> -8		2,8	62	8140.63.37... <Euro 2>		04.98-05.99		4	<b>0 432 117 002</b>	
-10 Turbo		2,8	76	8140.23.37... <Euro 2>; 8140.23.3713 <Euro 2>		05.96-05.99		4	<b>0 432 193 757</b>	<b>0 986 430 522</b>
<b>35</b> -8		2,5	60	8140.67F.37... <Euro 2>		05.96-03.98		4	<b>0 432 297 057</b>	<b>0 986 430 532</b>
		2,8	62	8140.63.37... <Euro 2>		04.98-05.99		4	<b>0 432 117 002</b>	
-10 Turbo, -12 Turbo		2,8	76/90	8140.23.37... <Euro 2>; 8140.23.3713 <Euro 2>; 8140.43.37... <Euro 2>; 8140.43.39... <Euro 2>		05.96-05.99		4	<b>0 432 193 757</b>	<b>0 986 430 522</b>
<b>40</b> -10 Turbo 4x4		2,8	76	8140.23.3801 <Euro 2>		05.96-05.99		4	<b>0 432 193 757</b>	<b>0 986 430 522</b>
<b>49</b> -10 Turbo, -12 Turbo		2,8	76/90	8140.23.37... <Euro 2>; 8140.23.3713 <Euro 2>; 8140.43.37... <Euro 2>		05.96-05.99		4	<b>0 432 193 757</b>	<b>0 986 430 522</b>
<b>59</b> -12 Turbo		2,8	90	8140.43.37... <Euro 2>		05.96-05.99		4	<b>0 432 193 757</b>	<b>0 986 430 522</b>
<b>EuroCargo</b>										
<b>65 E</b> 12		4,0	85	8040.45D...		06.96-07.00		4	<b>0 432 193 798</b>	
<b>75 E</b> 12, 14		4,0	85/100	8040.45D.51...; 8040.45.5...		01.93-08.00		4	<b>0 432 193 798</b>	
15		6,0	105	8060.45R.50...		01.93-08.00		6	<b>0 432 193 798</b>	
<b>80 E</b> 15		6,0	105	8060.45R.50...		01.93-08.00		6	<b>0 432 193 798</b>	
15, 18		6,0	105/130	8060.25R.42...; 8060.25V.40...		01.91-08.00		6	<b>0 432 291 559</b>	
18		5,9	130	8060.45B.51...		09.91-07.00		6	<b>0 432 193 798</b>	
21		6,0	152	8060.45X.4180		01.92-06.00		6	<b>0 432 193 847</b>	
				8060.45.41...		01.91-08.00		6	<b>0 432 191 741</b>	
				8060.45.4403		01.91-08.00		6	<b>0 432 191 692</b>	
				8060.45.52...		01.91-08.00		6	<b>0 432 193 798</b>	
<b>85 E</b> 18		6,0	130	8060.25V.4900		01.91-08.00		6	<b>0 432 291 559</b>	
				8060.45B.43...		09.91-07.00		6	<b>0 432 191 692</b>	
				8060.45B.51...		09.91-07.00		6	<b>0 432 193 798</b>	
<b>90 E</b> 15, 18		6,0	105/130	8060.45B.51...; 8060.45R.50...		09.91-08.00		6	<b>0 432 193 798</b>	
18		6,0	130	8060.45B.43...		09.91-07.00		6	<b>0 432 191 692</b>	
21		6,0	152	8060.45.47...		01.91-12.00		6	<b>0 432 191 741</b>	
				8060.45.52...		01.91-08.00		6	<b>0 432 193 798</b>	
<b>100 E</b> 15		6,0	105	8060.25R.42...		01.91-08.00		6	<b>0 432 291 559</b>	
15, 21		6,0	105/152	8060.45R.50...; 8060.45.52...		01.91-08.00		6	<b>0 432 193 798</b>	
18		5,9	130	8060.45B.51...		09.91-07.00		6	<b>0 432 193 798</b>	
		6,0	130	8060.25V.40...		01.91-11.00		6	<b>0 432 291 559</b>	
21		6,0	152	8060.45X.4180 TCA		01.92-11.00		6	<b>0 432 193 847</b>	
				8060.45.41...		01.91-11.00		6	<b>0 432 191 741</b>	
				8060.45.4403		01.91-08.00		6	<b>0 432 191 692</b>	
<b>120 E</b> 15		6,0	105	8060.25R.4...		12.91-07.00		6	<b>0 432 291 559</b>	
				8060.45R.50...		12.91-07.00		6	<b>0 432 193 798</b>	
18		6,0	130	8060.25V.4...		09.91-07.00		6	<b>0 432 291 559</b>	
18, 21		6,0	130/152	8060.45B.51...; 8060.45.52...		01.91-08.00		6	<b>0 432 193 798</b>	
23		6,0	167	8060.45K.6090		02.92-07.00		6	<b>0 432 193 846</b>	
				8060.45S.60...	CH	10.91-08.00		6	<b>0 432 193 846</b>	
					CH	10.91-08.00		6	<b>0 432 191 732</b>	
				8060.45S.72...		10.91-08.00		6	<b>0 432 193 730</b>	
<b>130 E</b> 15		6,0	105	8060.25R.4...		02.92-07.00		6	<b>0 432 291 559</b>	
				8060.45R.50...		12.91-07.00		6	<b>0 432 193 798</b>	
18		6,0	130	8060.25V.4...		11.91-07.00		6	<b>0 432 291 559</b>	
				8060.45B.51...		09.91-07.00		6	<b>0 432 193 798</b>	
23		6,0	167	8060.45K.6090		11.91-07.00		6	<b>0 432 193 846</b>	
				8060.45S.60...	CH	04.92-07.00		6	<b>0 432 193 846</b>	
					CH	04.92-07.00		6	<b>0 432 191 732</b>	
				8060.45S.72...		04.92-07.00		6	<b>0 432 193 730</b>	
<b>135 E</b> 18		5,8	130	8060.25V.472...		01.94-07.00		6	<b>0 432 291 559</b>	
				8060.45B.51...		01.94-07.00		6	<b>0 432 193 798</b>	
23		5,8	167	8060.45S.67...	CH	01.94-07.00		6	<b>0 432 193 846</b>	
					CH	01.94-07.00		6	<b>0 432 191 732</b>	
				8060.45S.725...		01.94-07.00		6	<b>0 432 193 730</b>	
<b>150 E</b> 15		6,0	105	8060.25R.4...		12.91-07.00		6	<b>0 432 291 559</b>	
				8060.45R.50...		12.91-07.00		6	<b>0 432 193 798</b>	
18		6,0	130	8060.25V.4...		09.91-07.00		6	<b>0 432 291 559</b>	
18, 21		6,0	130/152	8060.45B.51...; 8060.45.52...		01.91-08.00		6	<b>0 432 193 798</b>	
23		6,0	167	8060.45K.6090		02.92-07.00		6	<b>0 432 193 846</b>	















◀ IVECO

<b>150 23</b>	6,0	167	8060.45S.6...	CH	10.91-07.00	6	<b>0 432 193 846</b>
				GH	10.91-07.00		
			8060.45S.720...		10.91-07.00	6	<b>0 432 193 730</b>
27	7,7	196	8360.46...-Euro1		09.91-07.00	6	<b>0 432 291 554</b>
					09.91-07.00	6	<b>0 432 291 514</b>
<b>170 E 18</b>	5,8	130	8060.25V.41...		01.94-07.00	6	<b>0 432 291 559</b>
					09.91-07.00	6	<b>0 432 193 798</b>
23	5,8	167	8060.45S.6...	CH	01.94-07.00	6	<b>0 432 193 846</b>
				GH	01.94-07.00	6	<b>0 432 191 732</b>
					01.94-07.00	6	<b>0 432 193 730</b>
27	7,7	196	8360.46...		09.91-07.00	6	<b>0 432 291 514</b>
<b>170 R 15</b>	6,0	105	8060.25R.436...		12.91-07.00	6	<b>0 432 291 559</b>
<b>180 E 21</b>	6,0	152	8060.45.41...		04.92-07.00	6	<b>0 432 191 741</b>
					04.92-07.00	6	<b>0 432 191 692</b>
					04.92-07.00	6	<b>0 432 193 798</b>
<b>260 E 23</b>	6,0	167	8060.45S.6...	CH	12.91-07.00	6	<b>0 432 193 846</b>
				GH	12.91-07.00	6	<b>0 432 191 732</b>
					12.91-07.00	6	<b>0 432 193 730</b>
27	7,7	196	8360.46...-Euro1		09.91-07.00	6	<b>0 432 291 554</b>
					07.92-07.00	6	<b>0 432 291 514</b>
<b>280 E 23</b>	6,0	167	8060.45S.6...	CH	12.91-11.00	6	<b>0 432 193 846</b>
				GH	12.91-11.00	6	<b>0 432 191 732</b>
					12.91-11.00	6	<b>0 432 193 730</b>
			8060.45S.7203		12.91-11.00	6	<b>0 432 193 730</b>
<b>320 E 27</b>	7,7	196	8360.46...		10.91-08.00	6	<b>0 432 291 514</b>
						6	<b>0 432 291 554</b>
<b>EuroClass</b>							
<b>380 .12.38</b>	9,5	278	8460.41 M <Euro I, EDC>		01.93-11.02 KOC	6	<b>0 432 191 679</b>
<b>EuroStar</b>							
<b>180 E 38</b>	9,5	276	8460.41N.6...		09.92-07.00	6	<b>0 432 193 641</b>
					04.92-07.00	6	<b>0 432 291 516</b>
42	14,0	309	8210.42L.4620 -Euro2		04.92-07.00	6	<b>0 432 291 516</b>
<b>190 E 38</b>	9,5	276	8460.41L.5... <Euro1>	Mot.-Nr. →33841	06.92-07.00 BO	6	<b>0 432 191 731</b>
				Mot.-Nr. 33842→406951	06.92-07.00 KOC	6	<b>0 432 191 679</b>
				Mot.-Nr. 406952→	06.92-07.00	6	<b>0 432 191 646</b>
				8460.41N.6... <Euro2>	09.92-07.00	6	<b>0 432 193 641</b>
				8210.42L.4... <Euro1>	04.92-07.00	6	<b>0 432 291 555</b>
42	14,0	309	8210.42L.4... <Euro2>		04.92-11.00	6	<b>0 432 291 516</b>
		345	8210.42L.4... <Euro2>		04.92-11.00	6	<b>0 432 291 516</b>
47	13,8	345	8210.42M.5... <Euro2>		04.92-11.00	6	<b>0 432 291 519</b>
52	17,2	378	8280.42S.3...		04.92-11.00	8	<b>0 432 291 549</b>
<b>240 E 38</b>	9,5	276	8460.41L.5...	Mot.-Nr. →33841	09.92-11.00 BO	6	<b>0 432 191 731</b>
				Mot.-Nr. 33842→406951	09.92-11.00 KOC	6	<b>0 432 191 679</b>
				Mot.-Nr. 406952→	09.92-11.00	6	<b>0 432 191 646</b>
				8460.41N.6...	09.92-11.00	6	<b>0 432 193 641</b>
				8210.42L.4... <Euro1>	04.92-12.00	6	<b>0 432 291 555</b>
42	14,0	309	8210.42L.4...-Euro2		04.92-12.00	6	<b>0 432 291 516</b>
		345	8210.42M... <Euro 2>		11.95-12.02	6	<b>0 432 291 519</b>
47	14,0	345	8280.42S.3...		04.92-12.00	8	<b>0 432 291 549</b>
52	17,2	378	8280.42S.3...		04.92-12.00	8	<b>0 432 291 549</b>
<b>260 E 42</b>	14,0	309	8210.42L.4... <Euro2>		06.92-12.00	6	<b>0 432 291 516</b>
					06.92-12.00	6	<b>0 432 291 519</b>
47	14,0	345	8210.42M.5... <Euro 2>		06.92-12.00	6	<b>0 432 291 519</b>
<b>400 E 38</b>	9,5	276	8460.41L.5...-Euro1	Mot.-Nr. →33841	09.92-11.00 BO	6	<b>0 432 191 731</b>
				Mot.-Nr. 33842→406951	09.92-11.00 KOC	6	<b>0 432 191 679</b>
				Mot.-Nr. 406952→	09.92-11.00	6	<b>0 432 191 646</b>
				8460.41N.6...	09.92-11.00	6	<b>0 432 193 641</b>
				8210.42L.4... <Euro1>	04.92-12.00	6	<b>0 432 291 555</b>
42	14,0	309	8210.42L.4...-Euro2		04.92-12.00	6	<b>0 432 291 516</b>
		345	8210.42M.5... <Euro2>		04.92-11.00	6	<b>0 432 291 519</b>
47	14,0	345	8280.42S.3...		04.92-12.00	8	<b>0 432 291 549</b>
52	17,2	378	8280.42S.3...		04.92-12.00	8	<b>0 432 291 549</b>
<b>440 E 38</b>	9,5	276	8460.41L.5... <Euro1>	Mot.-Nr. →33841	04.93-11.00 BO	6	<b>0 432 191 731</b>
				Mot.-Nr. 33842→406951	04.93-11.00 KOC	6	<b>0 432 191 679</b>
				Mot.-Nr. 406952→	04.93-11.00	6	<b>0 432 191 646</b>





										
<b>440 E 38</b>		9,5	276	8460.41N.6...Euro2		04.93-11.00		6	<b>0 432 193 641</b>	
42		14,0	309	8210.42L.4... <Euro1>		04.92-12.00		6	<b>0 432 291 555</b>	
47		13,8	345	8210.42M.5... <Euro2>		04.92-12.00		6	<b>0 432 291 519</b>	
52		17,2	378	8280.42S.3...		04.92-12.00		8	<b>0 432 291 549</b>	
<b>EuroTech</b>										
<b>175 E 27</b>		7,7	196	OM-8360.46.417 TCA		04.92-07.00		6	<b>0 432 291 554</b>	
<b>179 E 27</b>		7,7	196	8360.46.417 TCA		04.92-07.00		6	<b>0 432 291 554</b>	
<b>180 E 24, 27</b>		7,7	176/196	8360.46... <Euro1>; 8360.46R... <Euro1>		07.92-07.00		6	<b>0 432 291 554</b>	
				8360.46... <Euro2>; 8360.46R... <Euro2>		07.92-07.00		6	<b>0 432 291 514</b>	
30		9,5	221	8460.41C.3... <Euro1>						
				Mot.-Nr. →33870		07.92-07.00		6	<b>0 432 191 731</b>	
				Mot.-Nr. 33871→406951		07.92-07.00	KOC	6	<b>0 432 191 679</b>	
				Mot.-Nr. 406952→		07.92-07.00		6	<b>0 432 191 646</b>	
30, 34		9,5	221/254	8460.41C.30... <Euro2>; 8460.41K.4... <Euro2>		04.92-07.00		6	<b>0 432 193 792</b>	
34		9,5	254	8460.41K.4... <Euro1>						
				Mot.-Nr. →33841		04.92-07.00		6	<b>0 432 191 731</b>	
				Mot.-Nr. 33842→406951		04.92-07.00	KOC	6	<b>0 432 191 679</b>	
				Mot.-Nr. 406952→		04.92-07.00		6	<b>0 432 191 646</b>	
38		9,5	276	8460.41L.5... <Euro1>						
				Mot.-Nr. →33841		09.92-07.00	BO	6	<b>0 432 191 731</b>	
				Mot.-Nr. 33842→406951		09.92-07.00	KOC	6	<b>0 432 191 679</b>	
				Mot.-Nr. 406952→		09.92-07.00		6	<b>0 432 191 646</b>	
				8460.41N.6...		09.92-07.00		6	<b>0 432 193 641</b>	
42		14,0	309	8210.42L.4... <Euro1>		04.92-07.00		6	<b>0 432 291 555</b>	
52		17,2	378	8280.42S.350		04.92-07.00		8	<b>0 432 291 549</b>	
<b>190 E 24, 27</b>		7,7	176/196	8360.46... <Euro1>; 8360.46R... <Euro1>		07.92-07.00		6	<b>0 432 291 554</b>	
				8360.46... <Euro2>; 8360.46R... <Euro2>		07.92-07.00		6	<b>0 432 291 514</b>	
30		9,5	221	8460.41C.3... <Euro1>						
				Mot.-Nr. →33870		07.92-07.00		6	<b>0 432 191 731</b>	
				Mot.-Nr. 33871→406951		07.92-07.00	KOC	6	<b>0 432 191 679</b>	
				Mot.-Nr. 406952→		07.92-07.00		6	<b>0 432 191 646</b>	
30, 34		9,5	221/254	8460.41C.30... <Euro2>; 8460.41K.4... <Euro2>		04.92-07.00		6	<b>0 432 193 792</b>	
34		9,5	254	8460.41K.4... <Euro1>						
				Mot.-Nr. →33841		04.92-07.00		6	<b>0 432 191 731</b>	
				Mot.-Nr. 33842→406951		04.92-07.00	KOC	6	<b>0 432 191 679</b>	
				Mot.-Nr. 406952→		04.92-07.00		6	<b>0 432 191 646</b>	
38		9,5	276	8460.41L.5... <Euro1>						
				Mot.-Nr. →33841		06.92-07.00	BO	6	<b>0 432 191 731</b>	
				Mot.-Nr. 33842→406951		06.92-07.00	KOC	6	<b>0 432 191 679</b>	
				Mot.-Nr. 406952→		06.92-07.00		6	<b>0 432 191 646</b>	
				8460.41L.6... <Euro2>; 8460.41N.6...		09.92-07.00		6	<b>0 432 193 641</b>	
42		14,0	309	8210.42L.4... <Euro1>		04.92-07.00		6	<b>0 432 291 555</b>	
			345	8210.42L.4... Euro2		04.92-11.00		6	<b>0 432 291 516</b>	
<b>240 E 25, 30, 34</b>		9,5	185/221/254	8460.41C.3032 <Euro2>; 8460.41K.4... <Euro2>; 8460.41T.2036		09.95-12.02		6	<b>0 432 193 792</b>	
30		9,5	221	8460.41C.3... <Euro1>						
				Mot.-Nr. →33870		09.96-12.02		6	<b>0 432 191 731</b>	
				Mot.-Nr. 33871→406951		09.96-12.02	KOC	6	<b>0 432 191 679</b>	
				Mot.-Nr. 406952→		09.96-12.02		6	<b>0 432 191 646</b>	
34		9,5	254	8460.41K.4... <Euro1>						
				Mot.-Nr. →33841		09.95-12.02		6	<b>0 432 191 731</b>	
				Mot.-Nr. 33842→406951		09.95-12.02	KOC	6	<b>0 432 191 679</b>	
				Mot.-Nr. 406952→		09.95-12.02		6	<b>0 432 191 646</b>	
38		9,5	276	8460.41L.5...						
				Mot.-Nr. →33841		09.92-11.00	BO	6	<b>0 432 191 731</b>	
				Mot.-Nr. 33842→406951		09.92-11.00	KOC	6	<b>0 432 191 679</b>	
				Mot.-Nr. 406952→		09.92-11.00		6	<b>0 432 191 646</b>	
				8460.41N.6...		09.92-11.00		6	<b>0 432 193 641</b>	
42		14,0	309	8210.42L.4... <Euro1>		04.92-12.00		6	<b>0 432 291 555</b>	
				8210.42L.4... <Euro2>		04.92-12.00		6	<b>0 432 291 516</b>	
<b>260 E 38</b>		9,5	276	8460.41N.6... <Euro 2>		06.92-07.00		6	<b>0 432 193 641</b>	















◀ IVECO

<b>260 E 27</b>	14,0	309	8210.42L.4... <Euro1>	06.92-12.00	6	<b>0 432 291 555</b>
			8210.42L.4...-Euro2	06.92-12.00	6	<b>0 432 291 516</b>
52	17,2	378	8280.42S.3...	04.92-07.00	8	<b>0 432 291 549</b>
<b>325 E 27</b>	7,7	196	8360.46... <Euro1>	07.92-07.00	6	<b>0 432 291 554</b>
			8360.46... <Euro2>	07.92-07.00	6	<b>0 432 291 514</b>
<b>400 E 30</b>	9,5	221	8460.41C.3... <Euro1>			
			Mot.-Nr. →33870	04.92-12.00	6	<b>0 432 191 731</b>
			Mot.-Nr. 33871→406951	04.92-12.00 KOC	6	<b>0 432 191 679</b>
			Mot.-Nr. 406952→	04.92-12.00	6	<b>0 432 191 646</b>
30, 34	9,5	221/254	8460.41C.30... <Euro2>; 8460.41K.4... <Euro2>	04.92-12.00	6	<b>0 432 193 792</b>
34	9,5	254	8460.41K.4... <Euro1>			
			Mot.-Nr. →33841	04.92-12.00	6	<b>0 432 191 731</b>
			Mot.-Nr. 33842→406951	04.92-12.00 KOC	6	<b>0 432 191 679</b>
			Mot.-Nr. 406952→	04.92-12.00	6	<b>0 432 191 646</b>
38	9,5	276	8460.41L.5... <Euro1>			
			Mot.-Nr. →33841	09.92-11.00 BO	6	<b>0 432 191 731</b>
			Mot.-Nr. 33842→406951	09.92-11.00 KOC	6	<b>0 432 191 679</b>
			Mot.-Nr. 406952→	09.92-11.00	6	<b>0 432 191 646</b>
			8460.41N.6...-Euro2	09.92-11.00	6	<b>0 432 193 641</b>
42	14,0	309	8210.42L.4... <Euro1>	04.92-12.00	6	<b>0 432 291 555</b>
			8210.42L.4... <Euro2>	04.92-12.00	6	<b>0 432 291 516</b>
52	17,2	378	8280.42S.3...	04.92-12.00	8	<b>0 432 291 549</b>
<b>440 E 34</b>	9,5	254	8460.41K.4... <Euro1>			
			Mot.-Nr. →33841	04.92-07.00	6	<b>0 432 191 731</b>
			Mot.-Nr. 33842→406951	04.92-07.00 KOC	6	<b>0 432 191 679</b>
			Mot.-Nr. 406952→	04.92-07.00	6	<b>0 432 191 646</b>
			8460.41K.4... <Euro2>	04.92-07.00	6	<b>0 432 193 792</b>
38	9,5	276	8460.41L.5...-Euro1			
			Mot.-Nr. →33841	04.93-11.00 BO	6	<b>0 432 191 731</b>
			Mot.-Nr. 33842→406951	04.93-11.00 KOC	6	<b>0 432 191 679</b>
			Mot.-Nr. 406952→	04.93-11.00	6	<b>0 432 191 646</b>
			8460.41N.6...	04.93-11.00	6	<b>0 432 193 641</b>
42	14,0	309	8210.42L.4... <Euro1>	04.92-12.00	6	<b>0 432 291 555</b>
			8210.42L.4... <Euro2>	04.92-12.00	6	<b>0 432 291 516</b>
<b>EuroTrakker</b>						
<b>180 E 25</b>	9,5	185	8460.41T...	04.97-11.00	6	<b>0 432 193 792</b>
<b>190 E 30</b>	9,5	221	8460.41C.3... <Euro1>			
			Mot.-Nr. →33870	07.92-07.00	6	<b>0 432 191 731</b>
			Mot.-Nr. 33871→406951	07.92-07.00 KOC	6	<b>0 432 191 679</b>
			Mot.-Nr. 406952→	07.92-07.00	6	<b>0 432 191 646</b>
30, 34	9,5	221/254	8460.41C.30... <Euro2>; 8460.41K.4...-Euro2	04.92-07.00	6	<b>0 432 193 792</b>
34	9,5	254	8460.41K.4...-Euro1			
			Mot.-Nr. →33841	04.92-07.00	6	<b>0 432 191 731</b>
			Mot.-Nr. 33842→406951	04.92-07.00 KOC	6	<b>0 432 191 679</b>
			Mot.-Nr. 406952→	04.92-07.00	6	<b>0 432 191 646</b>
37	13,8	272	8210.42K... <Euro1>	04.93-11.00	6	<b>0 432 291 555</b>
			8210.42K... <Euro2>	04.93-11.00	6	<b>0 432 291 516</b>
42	14,0	309	8210.42L.4... <Euro1>	04.92-07.00	6	<b>0 432 291 555</b>
47	14,0	345	8210.42L.4... <Euro2>	04.92-11.00	6	<b>0 432 291 516</b>
<b>260 E 30</b>	9,5	221	8460.41C.3... <Euro1>			
			Mot.-Nr. →33870	07.92-07.00	6	<b>0 432 191 731</b>
			Mot.-Nr. 33871→406951	07.92-07.00 KOC	6	<b>0 432 191 679</b>
			Mot.-Nr. 406952→	07.92-07.00	6	<b>0 432 191 646</b>
30, 34	9,5	221/254	8460.41C.30... <Euro2>; 8460.41K.4... <Euro2>	04.92-07.00	6	<b>0 432 193 792</b>
34	9,5	254	8460.41K.4... <Euro1>			
			Mot.-Nr. →33841	04.92-07.00	6	<b>0 432 191 731</b>
			Mot.-Nr. 33842→406951	04.92-07.00 KOC	6	<b>0 432 191 679</b>
			Mot.-Nr. 406952→	04.92-07.00	6	<b>0 432 191 646</b>
37	9,5	272	8210.42K.3... <Euro1>	12.94-12.01	6	<b>0 432 291 555</b>
			8210.42K.3... <Euro2>	12.94-12.01	6	<b>0 432 291 516</b>



										
<b>260</b> 42		14,0	309	8210.42L.4... <Euro1>		06.92-12.00		6	<b>0 432 291 555</b>	
				8210.42L.4... <Euro2>		06.92-12.00		6	<b>0 432 291 516</b>	
47		14,0	345	8210.42M.5... <Euro 2>		06.92-12.00		6	<b>0 432 291 519</b>	
<b>330 E</b> 34		9,5	254	8460.41K.4... <Euro1>						
				Mot.-Nr. →33841		04.92-07.00		6	<b>0 432 191 731</b>	
				Mot.-Nr. 33842→406951		04.92-07.00 KOC		6	<b>0 432 191 679</b>	
				Mot.-Nr. 406952→		04.92-07.00		6	<b>0 432 191 646</b>	
37		13,8	272	8210.42K.3... <Euro1>		04.93-11.00		6	<b>0 432 291 555</b>	
<b>340 E</b> 34		9,5	254	8460.41K.4... <Euro1>						
				Mot.-Nr. →33841		04.92-07.00		6	<b>0 432 191 731</b>	
				Mot.-Nr. 33842→406951		04.92-07.00 KOC		6	<b>0 432 191 679</b>	
				Mot.-Nr. 406952→		04.92-07.00		6	<b>0 432 191 646</b>	
				8460.41K.4... <Euro2>		04.92-07.00		6	<b>0 432 193 792</b>	
37		13,8	272	8210.42K.3... <Euro1>		03.95-12.02		6	<b>0 432 291 555</b>	
				8210.42K.3... <Euro2>		03.95-12.02		6	<b>0 432 291 516</b>	
42		14,0	309	8210.42L.4... <Euro1>		06.92-12.00		6	<b>0 432 291 555</b>	
				8210.42L.4... <Euro2>		06.92-12.00		6	<b>0 432 291 516</b>	
<b>380 E</b> 34		9,5	254	8460.41K.4... <Euro1>						
				Mot.-Nr. →33841		04.92-07.00		6	<b>0 432 191 731</b>	
				Mot.-Nr. 33842→406951		04.92-07.00 KOC		6	<b>0 432 191 679</b>	
				Mot.-Nr. 406952→		04.92-07.00		6	<b>0 432 191 646</b>	
				8460.41K.4... <Euro2>		04.92-07.00		6	<b>0 432 193 792</b>	
37		13,8	272	8210.42K... <Euro1>		03.95-12.02		6	<b>0 432 291 555</b>	
				8210.42K.3... <Euro2>		03.95-12.02		6	<b>0 432 291 516</b>	
42		14,0	309	8210.42L... <Euro1>		06.92-12.00		6	<b>0 432 291 555</b>	
				8210.42L.4... <Euro2>		06.92-12.00		6	<b>0 432 291 516</b>	
47		14,0	345	8210.42M.5... <Euro 2>		06.92-12.00		6	<b>0 432 291 519</b>	
<b>400 E</b> 34		9,5	254	8460.41K.4...Euro1						
				Mot.-Nr. →33841		04.92-12.00		6	<b>0 432 191 731</b>	
				Mot.-Nr. 33842→406951		04.92-12.00 KOC		6	<b>0 432 191 679</b>	
				Mot.-Nr. 406952→		04.92-12.00		6	<b>0 432 191 646</b>	
				8460.41K.4...Euro2		04.92-12.00		6	<b>0 432 193 792</b>	
37		13,8	272	8210.42K... <Euro1>		07.94-12.00		6	<b>0 432 291 555</b>	
				8210.42K.3... <Euro2>		07.94-12.00		6	<b>0 432 291 516</b>	
42		14,0	309	8210.42L.4... <Euro1>		04.92-12.00		6	<b>0 432 291 555</b>	
				8210.42L.4... <Euro2>		04.92-12.00		6	<b>0 432 291 516</b>	
<b>410 E</b> 37		13,8	272	8210.42K.3... <Euro1>		04.92-11.00		6	<b>0 432 291 555</b>	
				8210.42K.3... <Euro2>		04.92-11.00		6	<b>0 432 291 516</b>	
42		14,0	309	8210.42L.4... <Euro1>		04.92-11.00		6	<b>0 432 291 555</b>	
				8210.42L.4... <Euro2>		04.92-11.00		6	<b>0 432 291 516</b>	
<b>440 E</b> 34		9,5	254	8460.41K.4...Euro1						
				Mot.-Nr. →33841		04.92-07.00		6	<b>0 432 191 731</b>	
				Mot.-Nr. 33842→406951		04.92-07.00 KOC		6	<b>0 432 191 679</b>	
				Mot.-Nr. 406952→		04.92-07.00		6	<b>0 432 191 646</b>	
				8460.41K.4...Euro2		04.92-07.00		6	<b>0 432 193 792</b>	
37		14,0	272	8210.42K.3... <Euro1>		04.92-11.00		6	<b>0 432 291 555</b>	
				8210.42K.3... <Euro2>		04.92-11.00		6	<b>0 432 291 516</b>	
42		14,0	309	8210.42L.4... <Euro1>		04.92-12.00		6	<b>0 432 291 555</b>	
				8210.42L.4... <Euro2>		04.92-12.00		6	<b>0 432 291 516</b>	
<b>720 E</b> 42		13,8	309	8210.42L... <Euro1>		09.93-12.00		6	<b>0 432 291 555</b>	
				8210.42L.4... <Euro2>		09.93-12.00		6	<b>0 432 291 516</b>	
47		13,8	345	8210.42M.5... <Euro2>		04.92-12.00		6	<b>0 432 291 519</b>	
<b>Scudato</b>										
<b>35</b> .10		2,8	76	8140.23 <ID/TCA>		01.99-12.03		4	<b>0 432 193 757</b>	<b>0 986 430 522</b>
<b>49</b> .12		2,8	76	8140.43		11.99-05.02		4	<b>0 432 193 757</b>	<b>0 986 430 522</b>
<b>59</b> .12		2,8	76	8140.43		06.02-09.05		4	<b>0 432 193 757</b>	<b>0 986 430 522</b>
<b>Turbocity-I</b>										
<b>680</b> .12.26		9,5	191	8460.21.601		06.89-11.98		6	<b>0 432 191 751</b>	
<b>Turbocity-S</b>										
<b>580</b> .10.21, .12.21		9,5	155	8460.21.611 R		10.88-11.98		6	<b>0 432 191 766</b>	
<b>Turbocity-U</b>										
<b>480</b> .10.21, .12.21		9,5	155	8460.21.611 R		04.88-11.98		6	<b>0 432 191 766</b>	





◀ IVECO

TurboStar						
190 -38 PT	13,8	277	8210.42..		07.91-11.00	6 0432 291 580
-48	17,2	353	8280.42.050		11.91-11.00	8 0432 291 595
240 -48	17,2	350	8280.42...; 8280.42.050		03.89-11.99	8 0432 291 595
260 -36	13,8	277	8210.42.1...		07.90-12.00	6 0432 291 580
-48	17,2	350	8280.42...		06.89-11.99	8 0432 291 595
TurboTech						
190 -24	9,5	177	8460.21.2...		10.88-01.98	6 0432 191 766
-32	9,5	234	8460.41.1...		10.88-01.98	6 0432 191 763
		236	8460.41.16...		10.91-01.01	6 0432 191 731
220 -32	9,5	234	8460.41.1...		03.89-11.99	6 0432 191 763
-36	13,8	277	8210.42.151		07.90-11.00	6 0432 291 580
240 -26	9,5	192	8460.21.10..		07.90-11.00	6 0432 191 818
-32	9,5	234	8460.41.1...		03.89-11.98	6 0432 191 763
260 -32	9,5	234	8460.41.1...		07.90-12.00	6 0432 191 763
-36	13,8	277	8210.42.073; 8210.42.1...; 8210.42.151		07.90-12.99	6 0432 291 580
180						
180 -23 AH, -23 AHW, -25 AH, -25 AHW	13,4	174/194	F8L 513		07.91-07.00	8 0432 291 644
-34 AH, -34 AHW	12,8	250	BF8L 513		07.91-07.00	8 0432 291 699
220						
220 -34 HTM	12,8	250	BF8L 513		09.91-11.00	8 0432 291 699
240						
240 -25 ANW, -35 ANW	13,4	194	F8L 513		07.91-12.00	8 0432 291 644
260						
260 -23 AH, -25 AH...	13,4	168-174/ 194	F8L 513		04.89-12.99	8 0432 291 644
-34 AH, -34 AHW	12,8	250	BF8L 513		04.89-12.99	8 0432 291 699
300						
300 -32 AH...	12,8	225-232	BF8L 513		04.89-12.99	8 0432 291 699
315 .8.18	5,5	130	8060.25V.4600		06.91-11.00	6 0432 291 559
			8060.45B.5160		06.91-11.00	6 0432 193 798
316 .8.18	5,5	130	8060.25V.4600		06.91-11.00	6 0432 291 559
			8060.45B.5160		06.91-11.00	6 0432 193 798
330						
330 -36 H	13,8	265	8210.42.009		10.91-12.99	6 0432 291 580
340						
-34 AH	12,8	250	BF8L 513		03.89-12.98	8 0432 291 699
370						
370 S 24	9,5	177	8460.21.7...		01.87-11.98	6 0432 191 818
370 SE 27	7,7	196	8360.46.4370		07.92-07.00	6 0432 291 514
			8360.46.4637		07.92-07.00	6 0432 291 554
29	9,5	214	8460.41.721			
			Mot.-Nr. →33841		01.92-11.00	6 0432 191 731
			Mot.-Nr. 33842→406951		01.92-11.00 KOC	6 0432 191 679
			Mot.-Nr. 406952→		01.92-11.00	6 0432 191 646
380						
380 .10.29, .12.29	9,5	214	8460.41.72...			
			Mot.-Nr. →33841		01.92-11.00	6 0432 191 731
			Mot.-Nr. 33842→406951		01.92-11.00 KOC	6 0432 191 679
			Mot.-Nr. 406952→		01.92-11.00	6 0432 191 646
			8460.41.73...			
			Mot.-Nr. →33841		01.92-11.00	6 0432 191 731
			Mot.-Nr. 33842→406951		01.92-11.00 KOC	6 0432 191 679
			Mot.-Nr. 406952→		01.92-11.00	6 0432 191 646



**KÄSSBOHRER****Setra**

<b>S 215 HDH</b>	14,6	320	OM 442 LA				
			Mot.-Nr. →860061	06.96-06.01	8	<b>0 432 131 801</b>	<b>0 986 430 265</b>
					8	<b>0 432 131 804<sup>1</sup></b>	
			Mot.-Nr. 860062→	06.96-06.01	8	<b>0 432 131 726</b>	<b>0 986 430 326</b>
					8	<b>0 432 131 730<sup>1</sup></b>	
<b>S 312 HD</b>	14,6	280	OM 442 LA				
			Mot.-Nr. →860061	09.91-07.01	8	<b>0 432 131 800</b>	<b>0 986 430 264</b>
					8	<b>0 432 131 803<sup>1</sup></b>	
			Mot.-Nr. 860062→	09.91-07.01	8	<b>0 432 131 728</b>	<b>0 986 430 327</b>
					8	<b>0 432 131 729<sup>1</sup></b>	

**KAVZ KURGAN****Serie 4000**

<b>4239</b>	7,1	162	BF6M 1013-22E3 <Euro 3>	09.08→	6	<b>0 432 191 326</b>	
			BF6M 1013-33E3 <Euro 3>	09.08→	6	<b>0 432 191 327</b>	

**KIA****Ceres**

<b>2.4 D</b>	2,4	72	SC	06.99→	4	<b>9 430 610 098</b>	
--------------	-----	----	----	--------	---	----------------------	--

**LAZ****InterLAZ LE**

<b>6.9</b>	6,9	206	D 0836 LOH02 <Euro 3>	01.08→	6	<b>0 432 133 766</b>	
------------	-----	-----	-----------------------	--------	---	----------------------	--

**LEYLAND-DAF****95**

<b>.310</b>	11,6	225	WS 225 ATi	04.89-12.01	KOC	6	<b>0 432 291 602</b>
<b>.350</b>	11,6	259	WS 259 ATi	04.89-12.01	KOC	6	<b>0 432 291 603</b>
<b>.380</b>	11,6	282	WS 282 ATi	04.89-12.01	KOC	6	<b>0 432 291 603</b>

**LORRAINE (PLAXTON)****Lorraine**

<b>170</b>	5,5	123	8060.24.652	06.88→	6	<b>0 432 291 655</b>	
<b>240</b>	9,5	177	8460.21.708	06.88→	6	<b>0 432 191 818</b>	
, Regional	9,6	177	8220.22.102,4,6 708; 8220.22.708	06.88→	6	<b>0 432 191 844</b>	

**MACK (TRUCKS)****FR 1**

<b>11.0</b>	11,0	250	EE6-335	10.86→	6	<b>9 430 233 008</b>	
-------------	------	-----	---------	--------	---	----------------------	--





**MAHINDRA**











<b>Bolero Camper</b>						
2.5 D	2,5	43	MDI 3200 D	06.03-11.03	4	F 002 C8Z 867
				12.03→	4	F 002 C8Z 881
		74	NEF TCI	10.04→	4	F 002 C7Z 242
<b>FJ Bus</b>						
2.1 D [FJ 460 DP]	2,1	44	XDP-4.90 IDI	11.97-02.00	4	F 002 C6Z 201
<b>FJ Chassis</b>						
3.3 D [FJ 470 DP]	2,1	44	XDP-4.90 IDI	02.85-02.00	4	9 430 032 243
<b>FJ Truck</b>						
2.1 D [FJ 470 DP]	2,1	44	XDP-4.90 IDI	11.97-02.00	4	F 002 C6Z 201
D 4WD [FJ 460 DP]	2,1	44	XDP-4.90 IDI	11.97-06.98	4	F 002 C6Z 201
<b>LoadKing Pride</b>						
2.6 TCI	2,6	54	NEF 3200 TCI	03.05-12.09	4	F 002 C7Z 231
<b>NC 640 DP Pick up</b>						
2.1 D, D 4WD	2,1	46	XDP 4.90	11.97-10.03	4	F 002 C6Z 201
<b>Tourister</b>						
2.5 D	2,5	45	MDI 3200 TCI E	01.10→	4	F 002 C8Z 867

**MAN**

<b>Ale</b>						
	4,6		D 0834 LOH01 <Euro 3>	02.00-12.01	4	0 432 133 799 <sup>1</sup>
					TW	4 0 432 133 765
						4 0 432 133 798
		125	D 0824 LOH05 <Euro 3>	01.99-01.00	4	0 432 133 855 0 986 430 313
<b>Bus</b>						
28.230 HG0CL-SKD [A61]	6,9	170	D 0826 LOH07	01.94-05.01	6	0 432 131 820 0 986 430 257
<b>Bus 8t</b>						
8.150 FOC [L50]	4,6	114-118	D 0824 LFO01 <V1700, Euro 2>	02.95-07.98	4	0 432 131 820 0 986 430 257
FOCL [L51]	4,6	114-118	D 0824 LFO01 <V1700, Euro 2>	11.95-07.98	4	0 432 131 820 0 986 430 257
8.160 FOC [L50]	4,6	114-118	D 0824 LFL09 <V1700, Euro 2>	06.97-02.01	4	0 432 131 820 0 986 430 257
FOCL [L51]	4,6	118	D 0824 LFL09 <V1700, Euro 2>	06.97-02.01	4	0 432 131 820 0 986 430 257
8.220 FOC [L52]	6,9	162	D 0826 LFL03 <V2300, Euro 2>	04.95-02.01	6	0 432 133 855 0 986 430 313
			D 0826 LFL10 <V2300, Euro 2>	07.98-02.01	6	0 432 131 820 0 986 430 257
			D 0826 LFL03 <V2300, Euro 2>	11.95-07.98	6	0 432 133 855 0 986 430 313
			D 0826 LFL10 <V2300, Euro 2>	07.98-09.01	6	0 432 131 820 0 986 430 257
			D 0836 LFL02 <V3900, Euro 3>	07.01-12.06	6	0 432 133 799 <sup>1</sup>
					TW	6 0 432 133 765
						6 0 432 133 798
<b>Bus 11t</b>						
11.220 HOCL [469]	6,9	162	D 0826 LOH15 <V2900,>	11.95-12.00	6	0 432 133 855 0 986 430 313
			D 0826 LOH19 <V2900, Euro 2>	07.98-09.01	6	0 432 131 820 0 986 430 257
			D 0826 LUH12 <Euro 2>	07.98-12.00	6	0 432 133 842 <sup>1</sup>
						6 0 432 133 855 0 986 430 313
			D 0836 LOH03 <V4900, Euro 3>	01.01-05.01	6	0 432 133 799 <sup>1</sup>
				01.01-12.04	6	0 432 133 765
<b>Bus 12t</b>						
12.220 HOCL [M2000 LE]	6,9	162	D 0836 LFL02 <V3900, Euro 3>	09.02→	6	0 432 133 765
HOCL-NL [A76]	6,9	162	D 0826 LOH19 <V2900, Euro 2>	07.98-09.02	6	0 432 131 820 0 986 430 257
			D 0836 LOH03 <V4900, Euro 3>	04.99-05.01	6	0 432 133 799 <sup>1</sup>
				04.99-09.06	6	0 432 133 765
HOCL-NL-CIB [A80]	6,9	162	D 0836 LOH03 <Euro 3>	05.01-05.01	6	0 432 133 799 <sup>1</sup>
				05.01-08.08	6	0 432 133 765
HOCL-SR [A77]	6,9	162	D 0836 LOH03 <Euro 3>	03.03-09.06	6	0 432 133 765
					6	0 432 133 799 <sup>1</sup>
12.280 HOCL-NL [A76]	6,9	206	D 0836 LOH02 <V4900, Euro 3>	04.01-09.02	6	0 432 133 766
<b>Bus 13t</b>						
13.220 HOCL [A53]	6,9	162	D 0826 LOH15 <V2900,>	07.98-09.01	6	0 432 133 855 0 986 430 313





										
<b>13.220</b> HOCL [A53]	6,9	162	D 0826 LUH12 <Euro 2>		07.98-09.01		6	<b>0 432 133 842</b> <sup>1</sup>		
			D 0836 LOH03 <V4900, Euro 3>		09.01-05.04		6	<b>0 432 133 855</b>	<b>0 986 430 313</b>	
<b>Bus 14t</b>										
<b>14.220</b> HOCL-NL [A66]	6,9	162	D 0826 LOH19 <V2900, Euro 2>		07.98-09.01		6	<b>0 432 131 820</b>	<b>0 986 430 257</b>	
			D 0826 LUH12 <Euro 2>		07.98-09.01		6	<b>0 432 133 842</b> <sup>1</sup>		
			D 0836 LOH03 <V4900, Euro 3>		01.01-05.01		6	<b>0 432 133 799</b> <sup>1</sup>		
					01.01-09.06		6	<b>0 432 133 765</b>		
		206	D 0836 LOH02 <Euro 3>		01.02-09.02		6	<b>0 432 133 766</b>		
<b>14.280</b> HOCL-R [A83]	6,9	206	D 0836 LOH02 <Euro 3>		05.02-03.10		6	<b>0 432 133 766</b>		
HOCL-SR [A67]	6,9	206	D 0836 LOH02 <Euro 3>		06.03-10.06		6	<b>0 432 133 766</b>		
<b>Bus 18t</b>										
<b>18.220</b> HOCL-NL [A69]	6,9	162	D 0826 LOH19 <V2900, Euro 2>		07.98-09.01		6	<b>0 432 131 820</b>	<b>0 986 430 257</b>	
			D 0836 LOH03 <V4900, Euro 3>		01.01-05.01		6	<b>0 432 133 799</b> <sup>1</sup>		
					01.01-09.06		6	<b>0 432 133 765</b>		
HOCL-R-NL-CIB [A84]	6,9	162	D 0836 LOH03 <Euro 3>		02.03-→		6	<b>0 432 133 765</b>		
<b>18.230</b> HOCL-R-SKD [A64]	6,9	170	D 0826 LOH07		05.96-05.05		6	<b>0 432 131 820</b>	<b>0 986 430 257</b>	
HOCL-SDK [A60]	6,9	170	D 0826 LOH07		01.94-05.00		6	<b>0 432 131 820</b>	<b>0 986 430 257</b>	
<b>18.260</b> HOCL [A51]	12,0	191	D 2866 LOH31 <V1500, Euro 2>		09.96-09.01		6	<b>0 432 131 631</b> <sup>1</sup>		
			D 2866 LOH35 <V4800, Euro 3>		06.01-09.06		6	<b>0 432 191 417</b> <sup>1</sup>		
							6	<b>0 432 191 419</b>		
HOCL-NL [A69]	12,0	191	D 2866 LUH22 <Euro 2>		07.98-09.01		6	<b>0 432 131 631</b> <sup>1</sup>		
			D 2866 LUH23 <Euro 3>		06.01-09.06		6	<b>0 432 191 417</b> <sup>1</sup>		
							6	<b>0 432 191 419</b>		
<b>18.280</b> HOCL-NL [A69]	6,9	206	D 0836 LOH02 <V4900, Euro 3>		04.01-09.06		6	<b>0 432 133 766</b>		
HOCL-R-CKD [A85]	6,9	206	D 0836 LOH02 <V4900, Euro 3>		04.02-08.08		6	<b>0 432 133 766</b>		
<b>18.282</b> FOC	7,0	206	D 0836 LFLO1		09.96-→		6	<b>0 432 133 766</b>		
							6	<b>0 432 133 797</b> <sup>1</sup>		
<b>18.310</b> HOCL [A51]	12,0	228	D 2866 LOH25 <Euro 2>		09.96-09.01		6	<b>0 432 131 633</b>		
			D 2866 LOH27 <V4800, Euro 3>		01.01-09.06		6	<b>0 432 191 417</b> <sup>1</sup>		
							6	<b>0 432 191 419</b>		
HOCL-NL [A69]	12,0	228	D 2866 LUH24 <Euro 3>		01.01-09.06		6	<b>0 432 191 417</b> <sup>1</sup>		
			D 2866 LUH26 <Euro 2>		07.98-09.06		6	<b>0 432 131 631</b> <sup>1</sup>		
							6	<b>0 432 131 633</b>		
HOCL-R-SKD [A55]	12,0	228	D 2866 LOH25 <Euro 2>		03.01-03.08		6	<b>0 432 131 633</b>		
		230	D 2866 LOH24 <V1500, Euro 2>		08.95-03.04		6	<b>0 430 133 994</b>		
<b>18.350</b> HOCL [A51]	12,0	257	D 2866 LOH26 <V1500, Euro 2>		09.96-09.01		6	<b>0 432 131 631</b> <sup>1</sup>		
							6	<b>0 432 131 633</b>		
HOCL-R-SKD [A55]	12,0	257	D 2866 LOH26 <V1500, Euro 2>		03.03-03.08		6	<b>0 432 131 631</b> <sup>1</sup>		
							6	<b>0 432 131 633</b>		
<b>18.360</b> HOCL [A51]	12,0	265	D 2866 LOH28 <V4800, Euro 3>		01.01-09.06		6	<b>0 432 191 417</b> <sup>1</sup>		
							6	<b>0 432 191 419</b>		
HOCLN [R33]	12,0	265	D 2866 LOH33 <Euro 3>		01.05-09.08		6	<b>0 432 191 417</b> <sup>1</sup>		
							6	<b>0 432 191 419</b>		
HOCL-R-LBC [A82]	12,0	265	D 2866 LOH28 <V4800, Euro 3>		01.03-05.09		6	<b>0 432 191 417</b> <sup>1</sup>		
							6	<b>0 432 191 419</b>		
<b>18.370</b> HOCL-R-SKD [A55]	12,0	272	D 2866 LOH22 <V1500, Euro 1>		02.95-03.04		6	<b>0 432 131 853</b>	<b>0 986 430 196</b>	
<b>18.400</b> HOCL [A51]	12,0	294	D 2866 LOH23 <Euro 2>		01.01-09.01		6	<b>0 432 131 734</b> <sup>1</sup>		
							6	<b>0 432 131 788</b>	<b>0 986 430 312</b>	
		309	D 2866 LOH20 <V1500, Euro 1>		09.96-12.00		6	<b>0 432 131 831</b>	<b>0 986 430 228</b>	
HOCL-R-LBC [A82]	12,0	294	D 2866 LOH23 <Euro 2>		07.02-05.09		6	<b>0 432 131 734</b> <sup>1</sup>		
							6	<b>0 432 131 788</b>	<b>0 986 430 312</b>	
HOCL-R-SKD [A55]	12,0	294	D 2866 LOH23 <Euro 2>		01.05-03.08		6	<b>0 432 131 734</b> <sup>1</sup>		
							6	<b>0 432 131 788</b>	<b>0 986 430 312</b>	
<b>18.410</b> HOC [A51]	12,0	301	D 2866 LOH29 <Euro 3>		09.02-09.06		6	<b>0 432 191 417</b> <sup>1</sup>		
							6	<b>0 432 191 419</b>		
HOCL [A51]	12,8	302	D 2876 LOH05 <V4500, Euro 2>		01.99-09.01		6	<b>0 432 191 415</b> <sup>1</sup>		
							6	<b>0 432 191 416</b>		













◀ MAN

<b>18.410</b> HOCLN [R33]	12,0	301	D 2866 LOH34 <Euro 3>	03.04-09.06	6	<b>0 432 191 417</b> <sup>1</sup>	
					6	<b>0 432 191 419</b>	
HOCL-R-LBC [A82]	12,0	301	D 2866 LOH29 <Euro 3>	01.03-05.09	6	<b>0 432 191 417</b> <sup>1</sup>	
					6	<b>0 432 191 419</b>	
<b>18.420</b> HOCL-R-SKD [A55]	12,0	309	D 2866 LOH20 <V1500, Euro 1>	02.95-04.04	6	<b>0 432 131 831</b>	<b>0 986 430 228</b>
<b>18.460</b> HOCL [A51]	12,8	338	D 2876 LOH02 <V4500, Euro 3>	01.01-09.06	6	<b>0 432 191 414</b> <sup>1</sup>	
					6	<b>0 432 191 416</b>	
<b>Bus 22t</b>							
<b>22.400</b> HOCLN	12,0	294	D 2866 LOH03 <Z7700, Euro 2>	09.96-12.00	6	<b>0 432 131 853</b>	<b>0 986 430 196</b>
<b>22.420</b> HOCLN	12,0	309	D 2866 LOH06 <Z7700, Euro 1>	11.95-12.00	6	<b>0 432 231 778</b>	<b>0 986 430 159</b>
<b>Bus 24t</b>							
<b>24.310</b> HOCLNL [A59]	12,0	228	D 2866 LOH25 <Euro 2>	07.98-09.01	6	<b>0 432 131 633</b>	
			D 2866 LOH27 <V4800, Euro 3>	01.01-09.02	6	<b>0 432 191 417</b> <sup>1</sup>	
					6	<b>0 432 191 419</b>	
<b>24.350</b> HOCLLN [427]	12,0	257	D 2866 LOH26 <V1500, Euro 2>	03.01-09.02	6	<b>0 432 131 631</b> <sup>1</sup>	
					6	<b>0 432 131 633</b>	
HOCLN [A54]	12,0	258	D 2866 LOH26 <V1500, Euro 2>	07.98-09.01	6	<b>0 432 131 631</b> <sup>1</sup>	
					6	<b>0 432 131 633</b>	
HOCLNL [A59]	12,0	258	D 2866 LOH26 <V1500, Euro 2>	07.98-09.01	6	<b>0 432 131 631</b> <sup>1</sup>	
					6	<b>0 432 131 633</b>	
<b>24.360</b> HOCLLN [474]	12,0	265	D 2866 LOH28 <V4800, Euro 3>	09.02-09.06	6	<b>0 432 191 417</b> <sup>1</sup>	
					6	<b>0 432 191 419</b>	
HOCLN [A54]	12,0	265	D 2866 LOH28 <Euro 3>	09.02-09.06	6	<b>0 432 191 417</b> <sup>1</sup>	
					6	<b>0 432 191 419</b>	
<b>24.370</b> HOCLN-R-SKD [A56]	12,0	272	D 2866 LOH22 <V1500, Euro 1>	08.95-04.00	6	<b>0 432 131 853</b>	<b>0 986 430 196</b>
<b>24.400</b> HOCLLN [474]	12,0	294	D 2866 LOH23 <Euro 2>	11.99-09.01	6	<b>0 432 131 734</b> <sup>1</sup>	
					6	<b>0 432 131 788</b>	<b>0 986 430 312</b>
HOCLN [A54]	12,0	294	D 2866 LOH23 <Euro 2>	07.98-09.01	6	<b>0 432 131 734</b> <sup>1</sup>	
					6	<b>0 432 131 788</b>	<b>0 986 430 312</b>
HOCLN [474]	12,0	294	D 2866 LOH24 <V1500, Euro 2>	07.96-12.00	6	<b>0 430 133 994</b>	
HOCLN-R-CKD [A81]	12,0	294	D 2866 LOH23 <Euro 2>	05.03-02.10	6	<b>0 432 131 734</b> <sup>1</sup>	
					6	<b>0 432 131 788</b>	<b>0 986 430 312</b>
<b>24.410</b> HOCLLN [474]	12,0	301	D 2866 LOH29 <Euro 3>	09.02-09.06	6	<b>0 432 191 417</b> <sup>1</sup>	
					6	<b>0 432 191 419</b>	
	12,8	301/302	D 2876 LOH05 <V4500, Euro 2>	01.99-09.01	6	<b>0 432 191 415</b> <sup>1</sup>	
					6	<b>0 432 191 416</b>	
HOCLN [A54]	12,0	301	D 2866 LOH29 <Euro 3>	09.02-09.06	6	<b>0 432 191 417</b> <sup>1</sup>	
					6	<b>0 432 191 419</b>	
	12,8	302	D 2876 LOH05 <V4500, Euro 2>	07.98-09.01	6	<b>0 432 191 415</b> <sup>1</sup>	
					6	<b>0 432 191 416</b>	
<b>24.420</b> HOCLLN [474]	12,0	309	D 2866 LOH20 <V1500, Euro 1>	02.95-09.02	6	<b>0 432 131 831</b>	<b>0 986 430 228</b>
HOCLN-R-SKD [A56]	12,0	309	D 2866 LOH20 <V1500, Euro 1>	08.95-04.00	6	<b>0 432 131 831</b>	<b>0 986 430 228</b>
<b>24.460</b> HOCLLN [474]	12,8	338	D 2876 LOH01 <V3300, Euro 2>	11.99-09.01	6	<b>0 432 131 733</b> <sup>1</sup>	
					6	<b>0 432 131 760</b>	<b>0 986 430 451</b>
		339	D 2876 LOH02 <V4500, Euro 3>	01.01-09.06	6	<b>0 432 191 414</b> <sup>1</sup>	
					6	<b>0 432 191 416</b>	
HOCLN [A54]	12,8	338	D 2876 LOH01 <V3300, Euro 2>	11.99-09.01	6	<b>0 432 131 733</b> <sup>1</sup>	
					6	<b>0 432 131 760</b>	<b>0 986 430 451</b>
		339	D 2876 LOH02 <V4500, Euro 3>	01.01-09.06	6	<b>0 432 191 414</b> <sup>1</sup>	
					6	<b>0 432 191 416</b>	
<b>EL / EM</b>							
<b>EL 202</b> F [A16,A17]	6,9		D 0826 LUH10	02.94-05.99	6	<b>0 432 131 820</b>	<b>0 986 430 257</b>
<b>EL 222</b> [A12]	6,9	162	D 0826 LUH12 <Euro 2>	11.95-09.01	6	<b>0 432 133 842</b> <sup>1</sup>	
					6	<b>0 432 133 855</b>	<b>0 986 430 313</b>
F [A16,A17]	6,9	162	D 0826 LUH12 <Euro 2>	06.97-05.99	6	<b>0 432 133 842</b> <sup>1</sup>	
					6	<b>0 432 133 855</b>	<b>0 986 430 313</b>
<b>EL 262</b> [A12]	6,9	191	D 0826 LUH13 <V0300, Euro 2>	02.96-09.01	6	<b>0 432 133 840</b>	
					6	<b>0 432 133 841</b> <sup>1</sup>	
	12,0	191	D 2866 LUH22 <Euro 2>	07.98-09.01	6	<b>0 432 131 631</b> <sup>1</sup>	
					6	<b>0 432 131 633</b>	
F [A16,A17]	6,9	191	D 0826 LUH13 <V0300, Euro 2>	06.97-05.99	6	<b>0 432 133 840</b>	
					6	<b>0 432 133 841</b> <sup>1</sup>	
<b>EM 11.222</b> [469]	6,9	162	D 0826 LOH15 <V2900,>	02.96-09.01	6	<b>0 432 133 855</b>	<b>0 986 430 313</b>



										
<b>EM 13.222</b> [A53]	6,9	162	D 0826 LUH12 <Euro 2>		06.97-09.01		6	<b>0 432 133 842</b> <sup>1</sup>		
							6	<b>0 432 133 855</b>	<b>0 986 430 313</b>	
[469]	6,9	162	D 0826 LUH12 <Euro 2>		06.97-09.01		6	<b>0 432 133 842</b> <sup>1</sup>		
							6	<b>0 432 133 855</b>	<b>0 986 430 313</b>	
<b>EM 220</b> [469]	6,9	162	D 0836 LOH03 <V4900, Euro 3>		11.99-05.01		6	<b>0 432 133 799</b> <sup>1</sup>		
					11.99-12.04		6	<b>0 432 133 765</b>		
<b>E2000</b>										
<b>19.293</b> FA, FL	10,0	213	D 2865 LF24 <V2500, Euro 2>		06.96-09.01		5	<b>0 432 131 633</b>		
<b>19.314</b> FALS/FALK, FL	12,0	228	D 2866 LF34 <V2600, Euro 2>		06.98-09.01		6	<b>0 432 131 631</b> <sup>1</sup>		
							6	<b>0 432 131 633</b>		
<b>19.343</b> FA, FL	10,0	250	D 2865 LF21 <V2500, Euro 2>		06.96-09.01		5	<b>0 432 131 734</b> <sup>1</sup>		
							5	<b>0 432 131 788</b>	<b>0 986 430 312</b>	
<b>19.364</b> FA, FLS/FLK	12,0	265	D 2866 LF35 <V2600, Euro 2>		06.98-09.01		6	<b>0 432 131 631</b> <sup>1</sup>		
							6	<b>0 432 131 633</b>		
<b>19.403</b> FA, FL	12,0	294	D 2866 LF20 <V2600, Euro 2>		06.96-09.01		6	<b>0 432 131 734</b> <sup>1</sup>		
							6	<b>0 432 131 788</b>	<b>0 986 430 312</b>	
<b>19.414</b> FA, FLS/FLK	12,0	301	D 2866 LF31 <V2600, Euro 2>		03.00-12.01		6	<b>0 432 191 416</b>		
					05.00-12.01		6	<b>0 432 191 415</b> <sup>1</sup>		
<b>19.463</b> FA, FL	12,8	338	D 2876 LF02 <V2400, Euro 2>		06.96-09.01		6	<b>0 432 131 733</b> <sup>1</sup>		
							6	<b>0 432 131 760</b>	<b>0 986 430 451</b>	
<b>19.464</b> FALS/FALK, FLS/FLK	12,8	338	D 2876 LF06 <V2400, Euro 2>		06.98-01.00		6	<b>0 432 191 483</b>		
					06.98-04.00		6	<b>0 432 191 482</b> <sup>1</sup>		
					02.00-09.01		6	<b>0 432 191 416</b>		
					05.00-09.01		6	<b>0 432 191 415</b> <sup>1</sup>		
<b>26.293</b> F, FA, FL	10,0	213	D 2865 LF24 <V2500, Euro 2>		09.96-09.01		5	<b>0 432 131 633</b>		
<b>26.314</b> FA	12,0	228	D 2866 LF34 <V2600, Euro 2>		07.99-09.01		6	<b>0 432 131 631</b> <sup>1</sup>		
							6	<b>0 432 131 633</b>		
<b>26.343</b> F, FA, FL	10,0	250	D 2865 LF21 <V2500, Euro 2>		09.96-09.01		5	<b>0 432 131 734</b> <sup>1</sup>		
							5	<b>0 432 131 788</b>	<b>0 986 430 312</b>	
<b>26.364</b> FAV	12,0	265	D 2866 LF35 <V2600, Euro 2>		07.99-09.01		6	<b>0 432 131 631</b> <sup>1</sup>		
							6	<b>0 432 131 633</b>		
<b>26.403</b> F, FA, FL	12,0	294	D 2866 LF20 <V2600, Euro 2>		09.96-09.01		6	<b>0 432 131 734</b> <sup>1</sup>		
							6	<b>0 432 131 788</b>	<b>0 986 430 312</b>	
<b>26.414</b> FAVL	12,0	301	D 2866 LF31 <V2600, Euro 2>		03.00-12.01		6	<b>0 432 191 416</b>		
					05.00-12.01		6	<b>0 432 191 415</b> <sup>1</sup>		
<b>26.463</b> F, FA, FL	12,8	338	D 2876 LF02 <V2400, Euro 2>		09.96-09.01		6	<b>0 432 131 733</b> <sup>1</sup>		
							6	<b>0 432 131 760</b>	<b>0 986 430 451</b>	
<b>26.464</b> FA	12,8	338	D 2876 LF06 <V2400, Euro 2>		07.99-01.00		6	<b>0 432 191 483</b>		
					07.99-04.00		6	<b>0 432 191 482</b> <sup>1</sup>		
					02.00-09.01		6	<b>0 432 191 416</b>		
					05.00-09.01		6	<b>0 432 191 415</b> <sup>1</sup>		
<b>28.293</b> FNL	10,0	213	D 2865 LF24 <V2500, Euro 2>		09.96-09.01		5	<b>0 432 131 633</b>		
<b>28.314</b> FNLC	12,0	228	D 2866 LF34 <V2600, Euro 2>		07.99-03.01		6	<b>0 432 131 631</b> <sup>1</sup>		
							6	<b>0 432 131 633</b>		
<b>28.343</b> FANL, FNL	10,0	250	D 2865 LF21 <V2500, Euro 2>		09.96-09.01		5	<b>0 432 131 734</b> <sup>1</sup>		
							5	<b>0 432 131 788</b>	<b>0 986 430 312</b>	
<b>28.364</b>	12,0	265	D 2866 LF35 <V2600, Euro 2>		07.99-09.01		6	<b>0 432 131 631</b> <sup>1</sup>		
							6	<b>0 432 131 633</b>		
<b>28.403</b> FANL, FNL	12,0	294	D 2866 LF20 <V2600, Euro 2>		09.96-09.01		6	<b>0 432 131 734</b> <sup>1</sup>		
							6	<b>0 432 131 788</b>	<b>0 986 430 312</b>	
<b>28.414</b> , FNLC	12,0	301	D 2866 LF31 <V2600, Euro 2>		03.00-12.01		6	<b>0 432 191 416</b>		
					05.00-12.01		6	<b>0 432 191 415</b> <sup>1</sup>		
<b>28.463</b> FANL, FNL	12,8	338	D 2876 LF02 <V2400, Euro 2>		09.96-09.01		6	<b>0 432 131 733</b> <sup>1</sup>		
							6	<b>0 432 131 760</b>	<b>0 986 430 451</b>	
<b>28.464</b> , FL	12,8	338	D 2876 LF06 <V2400, Euro 2>		07.99-01.00		6	<b>0 432 191 483</b>		
					07.99-04.00		6	<b>0 432 191 482</b> <sup>1</sup>		
					02.00-09.01		6	<b>0 432 191 416</b>		
					05.00-09.01		6	<b>0 432 191 415</b> <sup>1</sup>		
<b>30.293</b> FNL	10,0	213	D 2865 LF24 <V2500, Euro 2>		03.97-09.01		5	<b>0 432 131 633</b>		
<b>30.314</b> FNLC	12,0	228	D 2866 LF34 <V2600, Euro 2>		06.98-09.01		6	<b>0 432 131 631</b> <sup>1</sup>		
							6	<b>0 432 131 633</b>		
<b>30.343</b> FANL, FNL	10,0	250	D 2865 LF21 <V2500, Euro 2>		03.97-09.01		5	<b>0 432 131 734</b> <sup>1</sup>		
							5	<b>0 432 131 788</b>	<b>0 986 430 312</b>	















◀ MAN

<b>30.364</b> FANLC, FNLC	12,0	265	D 2866 LF35 <V2600, Euro 2>	06.98-09.01	6	<b>0 432 131 631</b> <sup>1</sup>
					6	<b>0 432 131 633</b>
FNLC	12,0	265	D 2866 LF24 <V2600, Euro 3>	01.00-09.02	6	<b>0 432 191 418</b> <sup>1</sup>
					6	<b>0 432 191 419</b>
<b>30.403</b> FANL, FNL	12,0	294	D 2866 LF20 <V2600, Euro 2>	03.97-09.01	6	<b>0 432 131 734</b> <sup>1</sup>
					6	<b>0 432 131 788 0 986 430 312</b>
<b>30.414</b> FANLC, FNLC	12,0	301	D 2866 LF31 <V2600, Euro 2>	03.00-12.01	6	<b>0 432 191 416</b>
				05.00-12.01	6	<b>0 432 191 415</b> <sup>1</sup>
<b>30.463</b> FANL, FNL	12,8	338	D 2876 LF02 <V2400, Euro 2>	03.97-09.01	6	<b>0 432 131 733</b> <sup>1</sup>
					6	<b>0 432 131 760 0 986 430 451</b>
<b>30.464</b> FANLC, FNLC	12,8	338	D 2876 LF06 <V2400, Euro 2>	06.98-01.00	6	<b>0 432 191 483</b>
				06.98-04.00	6	<b>0 432 191 482</b> <sup>1</sup>
				02.00-09.01	6	<b>0 432 191 416</b>
				05.00-09.01	6	<b>0 432 191 415</b> <sup>1</sup>
<b>32.293</b> VFL	10,0	213	D 2865 LF24 <V2500, Euro 2>	03.97-09.01	5	<b>0 432 131 633</b>
<b>32.314</b> VFNLC	12,0	228	D 2866 LF34 <V2600, Euro 2>	07.99-09.01	6	<b>0 432 131 631</b> <sup>1</sup>
					6	<b>0 432 131 633</b>
<b>32.343</b> VFL	10,0	250	D 2865 LF21 <V2500, Euro 2>	03.97-09.01	5	<b>0 432 131 734</b> <sup>1</sup>
					5	<b>0 432 131 788 0 986 430 312</b>
<b>32.364</b> VFNLC	12,0	265	D 2866 LF35 <V2600, Euro 2>	07.99-09.01	6	<b>0 432 131 631</b> <sup>1</sup>
					6	<b>0 432 131 633</b>
<b>32.403</b> VFL	12,0	294	D 2866 LF20 <V2600, Euro 2>	03.97-09.01	6	<b>0 432 131 734</b> <sup>1</sup>
					6	<b>0 432 131 788 0 986 430 312</b>
<b>32.414</b> VFLC	12,0	301	D 2866 LF31 <V2600, Euro 2>	03.00-12.01	6	<b>0 432 191 416</b>
				05.00-12.01	6	<b>0 432 191 415</b> <sup>1</sup>
<b>32.463</b> VFL	12,8	338	D 2876 LF02 <V2400, Euro 2>	03.97-09.01	6	<b>0 432 131 733</b> <sup>1</sup>
					6	<b>0 432 131 760 0 986 430 451</b>
<b>32.464</b> VFNLC	12,8	338	D 2876 LF06 <V2400, Euro 2>	07.99-01.00	6	<b>0 432 191 483</b>
				07.99-04.00	6	<b>0 432 191 482</b> <sup>1</sup>
				02.00-09.01	6	<b>0 432 191 416</b>
				05.00-09.01	6	<b>0 432 191 415</b> <sup>1</sup>
<b>33.293</b> DFL	10,0	213	D 2865 LF24 <V2500, Euro 2>	09.96-09.01	5	<b>0 432 131 633</b>
<b>33.343</b> DFAL, DFL	10,0	250	D 2865 LF21 <V2500, Euro 2>	09.96-09.01	5	<b>0 432 131 734</b> <sup>1</sup>
					5	<b>0 432 131 788 0 986 430 312</b>
<b>33.364</b> , DFAL, DFL	12,0	265	D 2866 LF35 <V2600, Euro 2>	10.97-09.01	6	<b>0 432 131 631</b> <sup>1</sup>
					6	<b>0 432 131 633</b>
<b>33.403</b> DFAL, DFL	12,0	294	D 2866 LF20 <V2600, Euro 2>	09.96-09.01	6	<b>0 432 131 734</b> <sup>1</sup>
					6	<b>0 432 131 788 0 986 430 312</b>
<b>33.414</b> , DFAL, DFL	12,0	301	D 2866 LF31 <V2600, Euro 2>	03.00-12.01	6	<b>0 432 191 416</b>
				05.00-12.01	6	<b>0 432 191 415</b> <sup>1</sup>
<b>33.463</b> DFAL, DFL	12,8	338	D 2876 LF02 <V2400, Euro 2>	09.96-09.01	6	<b>0 432 131 733</b> <sup>1</sup>
					6	<b>0 432 131 760 0 986 430 451</b>
<b>33.464</b>	12,8	338	D 2876 LF02 <V2400, Euro 2>	10.97-09.01	6	<b>0 432 131 733</b> <sup>1</sup>
					6	<b>0 432 131 760 0 986 430 451</b>
DFAL, DFL	12,8	301/338	D 2876 LF06 <V2400, Euro 2>	06.98-01.00	6	<b>0 432 191 483</b>
				06.98-04.00	6	<b>0 432 191 482</b> <sup>1</sup>
				02.00-09.01	6	<b>0 432 191 416</b>
				05.00-09.01	6	<b>0 432 191 415</b> <sup>1</sup>
<b>33.604</b> DFLS	18,3	441	D 2840 LF21 <V3400, Euro 2>	08.97-01.99	10	<b>0 432 133 819</b>
<b>35.343</b> VF, VFA	10,0	250	D 2865 LF21 <V2500, Euro 2>	06.96-09.01	5	<b>0 432 131 734</b> <sup>1</sup>
					5	<b>0 432 131 788 0 986 430 312</b>
<b>35.364</b> VF, VFA	12,0	265	D 2866 LF35 <V2600, Euro 2>	06.98-09.01	6	<b>0 432 131 631</b> <sup>1</sup>
					6	<b>0 432 131 633</b>
<b>35.403</b> FV, VF	12,0	294	D 2866 LF20 <V2600, Euro 2>	06.96-09.01	6	<b>0 432 131 734</b> <sup>1</sup>
					6	<b>0 432 131 788 0 986 430 312</b>
<b>35.414</b> FV	12,0	301	D 2866 LF31 <V2600, Euro 2>	07.99-12.01	6	<b>0 432 191 416</b>
				05.00-12.01	6	<b>0 432 191 415</b> <sup>1</sup>
VF, VFA	12,0	301	D 2866 LF31 <V2600, Euro 2>	03.00-12.01	6	<b>0 432 191 416</b>
				05.00-12.01	6	<b>0 432 191 415</b> <sup>1</sup>
<b>35.463</b> FV, VF, VFA	12,8	338	D 2876 LF02 <V2400, Euro 2>	06.96-09.01	6	<b>0 432 131 733</b> <sup>1</sup>
					6	<b>0 432 131 760 0 986 430 451</b>



									
<b>35.464</b> FV	12,8	338	D 2876 LF06 <V2400, Euro 2>		07.99-04.00		6	<b>0 432 191 482</b> <sup>1</sup>	
					02.00-09.01		6	<b>0 432 191 416</b>	
					05.00-09.01		6	<b>0 432 191 415</b> <sup>1</sup>	
VF, VFA	12,8	338	D 2876 LF06 <V2400, Euro 2>		06.98-01.00		6	<b>0 432 191 483</b>	
					06.98-04.00		6	<b>0 432 191 482</b> <sup>1</sup>	
					02.00-09.01		6	<b>0 432 191 416</b>	
					05.00-09.01		6	<b>0 432 191 415</b> <sup>1</sup>	
<b>40.604</b> DFAS	18,3	441	D 2840 LF21 <V3400, Euro 2>		09.98-01.99		10	<b>0 432 133 819</b>	
<b>41.343</b> VF, VFA	10,0	250	D 2865 LF21 <V2500, Euro 2>		06.96-09.01		5	<b>0 432 131 734</b> <sup>1</sup>	
							5	<b>0 432 131 788</b>	<b>0 986 430 312</b>
<b>41.364</b> VF, VFA	12,0	265	D 2866 LF35 <V2600, Euro 2>		06.98-09.01		6	<b>0 432 131 631</b> <sup>1</sup>	
							6	<b>0 432 131 633</b>	
<b>41.403</b> VF, VFA	12,0	294	D 2866 LF20 <V2600, Euro 2>		06.96-09.01		6	<b>0 432 131 734</b> <sup>1</sup>	
							6	<b>0 432 131 788</b>	<b>0 986 430 312</b>
<b>41.414</b> VF, VFA	12,0	301	D 2866 LF31 <V2600, Euro 2>		03.00-12.01		6	<b>0 432 191 416</b>	
					05.00-12.01		6	<b>0 432 191 415</b> <sup>1</sup>	
<b>41.463</b> DFVL, VF, VFA	12,8	338	D 2876 LF02 <V2400, Euro 2>		06.96-09.01		6	<b>0 432 131 733</b> <sup>1</sup>	
							6	<b>0 432 131 760</b>	<b>0 986 430 451</b>
<b>41.464</b> DFVL, VF, VFA	12,8	338	D 2876 LF06 <V2400, Euro 2>		06.98-01.00		6	<b>0 432 191 483</b>	
					06.98-04.00		6	<b>0 432 191 482</b> <sup>1</sup>	
					02.00-09.01		6	<b>0 432 191 416</b>	
					05.00-09.01		6	<b>0 432 191 415</b> <sup>1</sup>	
<b>41.604</b> DFVLS	18,3	441	D 2840 LF21 <V3400, Euro 2>		02.97-01.99		10	<b>0 432 133 819</b>	
<b>42.414</b> VFAK	12,0	301	D 2866 LF25 <V2600, Euro 3>		01.00-08.01		6	<b>0 432 191 418</b> <sup>1</sup>	
							6	<b>0 432 191 419</b>	
VFAK, VFK	12,0	301	D 2866 LF31 <V2600, Euro 2>		03.00-08.01		6	<b>0 432 191 416</b>	
					05.00-08.01		6	<b>0 432 191 415</b> <sup>1</sup>	
VFK	12,0	301	D 2866 LF25 <V2600, Euro 3>		01.00-08.01		6	<b>0 432 191 418</b> <sup>1</sup>	
<b>42.464</b> VFAK	12,8	338	D 2876 LF03 <V2400, Euro 3>		01.00-04.00		6	<b>0 432 191 482</b> <sup>1</sup>	
					01.00-08.01		6	<b>0 432 191 416</b>	
			D 2876 LF06 <V2400, Euro 2>		06.98-01.00		6	<b>0 432 191 483</b>	
					06.98-04.00		6	<b>0 432 191 482</b> <sup>1</sup>	
					02.00-08.01		6	<b>0 432 191 416</b>	
					05.00-08.01		6	<b>0 432 191 415</b> <sup>1</sup>	
<b>50.414</b> VF, VFA, VFAVK, VFK	12,0	301	D 2866 LF31 <V2600, Euro 2>		03.00-09.01		6	<b>0 432 191 416</b>	
					05.00-09.01		6	<b>0 432 191 415</b> <sup>1</sup>	
VFAVK	12,8	338	D 2876 LF06 <V2400, Euro 2>		06.98-01.00		6	<b>0 432 191 483</b>	
					06.98-04.00		6	<b>0 432 191 482</b> <sup>1</sup>	
					02.00-09.01		6	<b>0 432 191 416</b>	
					05.00-09.01		6	<b>0 432 191 415</b> <sup>1</sup>	
<b>50.464</b> VF, VFA, VFAVK, VFK	12,8	338	D 2876 LF06 <V2400, Euro 2>		06.98-01.00		6	<b>0 432 191 483</b>	
					06.98-04.00		6	<b>0 432 191 482</b> <sup>1</sup>	
					02.00-09.01		6	<b>0 432 191 416</b>	
					05.00-09.01		6	<b>0 432 191 415</b> <sup>1</sup>	
<b>E2000 Evol. (FE)</b>									
<b>19.310</b> F, FA	12,0	228	D 2866 LF23 <V2600, Euro 3>		09.02-06.03		6	<b>0 432 191 418</b> <sup>1</sup>	
							6	<b>0 432 191 419</b>	
<b>19.360</b> F, FA, F, FL	12,0	265	D 2866 LF24 <V2600, Euro 3>		09.02-06.03		6	<b>0 432 191 418</b> <sup>1</sup>	
							6	<b>0 432 191 419</b>	
<b>19.410</b> F, FA, F, FL	12,0	301	D 2866 LF25 <V2600, Euro 3>		09.02-06.03		6	<b>0 432 191 418</b> <sup>1</sup>	
							6	<b>0 432 191 419</b>	
<b>19.460</b> F, FA, F, FL	12,8	338	D 2876 LF03 <V2400, Euro 3>		09.01-06.03		6	<b>0 432 191 416</b>	
<b>26.360</b> DF	12,0	265	D 2866 LF24 <V2600, Euro 3>		09.02-10.03		6	<b>0 432 191 418</b> <sup>1</sup>	
							6	<b>0 432 191 419</b>	
<b>26.410</b> DF	12,0	301	D 2866 LF25 <V2600, Euro 3>		09.02-10.03		6	<b>0 432 191 418</b> <sup>1</sup>	
							6	<b>0 432 191 419</b>	
<b>26.460</b> DF	12,8	338	D 2876 LF03 <V2400, Euro 3>		09.02-10.03		6	<b>0 432 191 416</b>	
<b>28.310</b> DF	12,0	228	D 2866 LF23 <V2600, Euro 3>		09.02-12.03		6	<b>0 432 191 418</b> <sup>1</sup>	
							6	<b>0 432 191 419</b>	
<b>28.360</b> DA, DF	12,0	265	D 2866 LF24 <V2600, Euro 3>		09.02-11.03		6	<b>0 432 191 418</b> <sup>1</sup>	
							6	<b>0 432 191 419</b>	
<b>28.410</b> DA, DF	12,0	301	D 2866 LF25 <V2600, Euro 3>		08.02-11.03		6	<b>0 432 191 418</b> <sup>1</sup>	
							6	<b>0 432 191 419</b>	















◀ MAN

<b>28.460</b> DA, DF	12,8	338	D 2876 LF03 <V2400, Euro 3>	09.02-11.03	6	<b>0 432 191 416</b>
<b>30.360</b> DF	12,0	265	D 2866 LF24 <V2600, Euro 3>	09.02-06.03	6	<b>0 432 191 418</b> <sup>1</sup>
					6	<b>0 432 191 419</b>
<b>30.410</b> DF	12,0	301	D 2866 LF25 <V2600, Euro 3>	09.02-06.03	6	<b>0 432 191 418</b> <sup>1</sup>
					6	<b>0 432 191 419</b>
<b>30.460</b> DF	12,8	338	D 2876 LF03 <V2400, Euro 3>	09.02-06.03	6	<b>0 432 191 416</b>
<b>32.360</b> VF	12,0	265	D 2866 LF24 <V2600, Euro 3>	09.02-10.03	6	<b>0 432 191 418</b> <sup>1</sup>
					6	<b>0 432 191 419</b>
<b>32.410</b> VF	12,0	301	D 2866 LF25 <V2600, Euro 3>	09.02-10.03	6	<b>0 432 191 418</b> <sup>1</sup>
					6	<b>0 432 191 419</b>
<b>32.460</b> VF	12,8	338	D 2876 LF03 <V2400, Euro 3>	08.02-10.03	6	<b>0 432 191 416</b>
<b>33.360</b> DA, DF	12,0	265	D 2866 LF24 <V2600, Euro 3>	09.02-06.03	6	<b>0 432 191 418</b> <sup>1</sup>
					6	<b>0 432 191 419</b>
<b>33.410</b> DA, DF	12,0	301	D 2866 LF25 <V2600, Euro 3>	09.02-06.03	6	<b>0 432 191 418</b> <sup>1</sup>
					6	<b>0 432 191 419</b>
<b>33.460</b> DA, DF	12,8	338	D 2876 LF03 <V2400, Euro 3>	09.02-06.03	6	<b>0 432 191 416</b>
<b>35.360</b> VA, VF	12,0	265	D 2866 LF24 <V2600, Euro 3>	08.02-09.03	6	<b>0 432 191 418</b> <sup>1</sup>
					6	<b>0 432 191 419</b>
<b>35.410</b> VA, VF	12,0	301	D 2866 LF25 <V2600, Euro 3>	09.02-10.03	6	<b>0 432 191 418</b> <sup>1</sup>
					6	<b>0 432 191 419</b>
<b>35.460</b> VA, VF	12,8	338	D 2876 LF03 <V2400, Euro 3>	09.02-10.03	6	<b>0 432 191 416</b>
<b>41.410</b> VA, VF	12,0	301	D 2866 LF25 <V2600, Euro 3>	09.02-09.03	6	<b>0 432 191 418</b> <sup>1</sup>
					6	<b>0 432 191 419</b>
<b>41.460</b> VA, VF	12,8	338	D 2876 LF03 <V2400, Euro 3>	09.02-09.03	6	<b>0 432 191 416</b>
<b>50.410</b> FVN, VA, VF	12,0	301	D 2866 LF25 <V2600, Euro 3>	09.02-09.03	6	<b>0 432 191 418</b> <sup>1</sup>
					6	<b>0 432 191 419</b>
<b>50.460</b> FVN, VA, VF	12,8	338	D 2876 LF03 <V2400, Euro 3>	08.02-09.03	6	<b>0 432 191 416</b>
<b>310A</b> DF, F, FA, VF	12,0	228	D 2866 LF23 <V2600, Euro 3>	01.00-08.02	6	<b>0 432 191 418</b> <sup>1</sup>
					6	<b>0 432 191 419</b>
<b>360A</b> DA, DF, F, FA, F, FL, VA, VF	12,0	265	D 2866 LF24 <V2600, Euro 3>	01.00-09.02	6	<b>0 432 191 418</b> <sup>1</sup>
					6	<b>0 432 191 419</b>
<b>410A</b> DA, DF, F, FA, F, FL, FVA, FVF, FVN, VA, VF	12,0	301	D 2866 LF25 <V2600, Euro 3>	01.00-09.02	6	<b>0 432 191 418</b> <sup>1</sup>
					6	<b>0 432 191 419</b>
<b>460A</b> DA, DF	12,8	338	D 2876 LF03 <V2400, Euro 3>	01.00-04.00	6	<b>0 432 191 482</b> <sup>1</sup>
				01.00-09.02	6	<b>0 432 191 416</b>
F, FA, F, FL	12,8	338	D 2876 LF03 <V2400, Euro 3>	07.01-09.02	6	<b>0 432 191 416</b>
FVN, VA, VF	12,8	338	D 2876 LF03 <V2400, Euro 3>	01.00-04.00	6	<b>0 432 191 482</b> <sup>1</sup>
				01.00-09.02	6	<b>0 432 191 416</b>
<b>FR / FRH</b>						
<b>FRH 352</b> [A03]	12,0	257	D 2866 LOH26 <V1500, Euro 2>	09.95-11.99	6	<b>0 432 131 631</b> <sup>1</sup>
					6	<b>0 432 131 633</b>
F [A33]	12,0	257	D 2866 LOH26 <V1500, Euro 2>	07.98-09.01	6	<b>0 432 131 631</b> <sup>1</sup>
					6	<b>0 432 131 633</b>
			D 2866 LUH21 <V3200, Euro 2>	07.98-09.01	6	<b>0 432 131 631</b> <sup>1</sup>
					6	<b>0 432 131 633</b>
<b>FRH 402</b> [A03]	12,0	294	D 2866 LOH23 <Euro 2>	09.95-11.99	6	<b>0 432 131 734</b> <sup>1</sup>
					6	<b>0 432 131 788 0 986 430 312</b>
F [A33]	12,0	294	D 2866 LOH23 <Euro 2>	07.98-09.01	6	<b>0 432 131 734</b> <sup>1</sup>
					6	<b>0 432 131 788 0 986 430 312</b>
<b>F2000</b>						
<b>17.373</b> DF	12,0	272	D 2866 LF21 <V2600, Euro 1>	01.94-12.00	6	<b>0 432 131 853 0 986 430 196</b>
<b>19.293</b> F, FA, FL	10,0	213	D 2865 LF24 <V2500, Euro 2>	04.95-01.00	5	<b>0 432 131 633</b>
<b>19.314</b> F, FAS/FAC/FAK, FLL, FLLS/FLLC/FLCW, FLS/FLK/FLC	12,0	228	D 2866 LF34 <V2600, Euro 2>	06.98-12.01	6	<b>0 432 131 631</b> <sup>1</sup>
					6	<b>0 432 131 633</b>
<b>19.343</b> F, FA, FL	10,0	250	D 2865 LF21 <V2500, Euro 2>	01.94-01.00	5	<b>0 432 131 734</b> <sup>1</sup>
					5	<b>0 432 131 788 0 986 430 312</b>
<b>19.364</b> F, FA, FL, FLL	12,0	265	D 2866 LF35 <V2600, Euro 2>	06.98-12.01	6	<b>0 432 131 631</b> <sup>1</sup>
					6	<b>0 432 131 633</b>
<b>19.403</b> F, FA, FL	12,0	294	D 2866 LF20 <V2600, Euro 2>	01.94-12.01	6	<b>0 432 131 734</b> <sup>1</sup>
					6	<b>0 432 131 788 0 986 430 312</b>
<b>19.414</b> F, FA, FL, FLL	12,0	301	D 2866 LF31 <V2600, Euro 2>	03.00-12.01	6	<b>0 432 191 416</b>
				05.00-12.01	6	<b>0 432 191 415</b> <sup>1</sup>





									
<b>19.414</b> FLL	12,0	301	D 2866 LF25 <V2600, Euro 3>		01.00-12.01		6	<b>0 432 191 418</b> <sup>1</sup>	
							6	<b>0 432 191 419</b>	
<b>19.463</b> F, FA, FL	12,8	338	D 2876 LF02 <V2400, Euro 2>		01.94-12.01		6	<b>0 432 131 760</b>	<b>0 986 430 451</b>
					10.95-12.01		6	<b>0 432 131 733</b> <sup>1</sup>	
<b>19.464</b> F, FA, FL, FLL, FLL-P, FLLR-P	12,8	338	D 2876 LF06 <V2400, Euro 2>		06.98-01.00		6	<b>0 432 191 483</b>	
					06.98-04.00		6	<b>0 432 191 482</b> <sup>1</sup>	
					02.00-07.01		6	<b>0 432 191 416</b>	
					05.00-07.01		6	<b>0 432 191 415</b> <sup>1</sup>	
FLL, FLL-P, FLLR-P	12,8	338	D 2876 LF03 <V2400, Euro 3>		01.00-04.00		6	<b>0 432 191 482</b> <sup>1</sup>	
					01.00-12.02		6	<b>0 432 191 416</b>	
<b>19.603</b> FL	18,3	441	D 2840 LF20 <V3400, Euro 2>		04.96-02.99		10	<b>0 432 133 839</b>	
<b>23.293</b>	10,0	213	D 2865 LF24 <V2500, Euro 2>		04.95-01.00		5	<b>0 432 131 633</b>	
<b>23.314</b> FNLC	12,0	228	D 2866 LF34 <V2600, Euro 2>		07.99-09.01		6	<b>0 432 131 631</b> <sup>1</sup>	
							6	<b>0 432 131 633</b>	
FNLLC, FNLLC/L	12,0	228	D 2866 LF23 <V2600, Euro 3>		01.00-12.02		6	<b>0 432 191 418</b> <sup>1</sup>	
							6	<b>0 432 191 419</b>	
<b>23.343</b>	10,0	250	D 2865 LF21 <V2500, Euro 2>		01.94-01.00		5	<b>0 432 131 734</b> <sup>1</sup>	
							5	<b>0 432 131 788</b>	<b>0 986 430 312</b>
<b>23.364</b> FNLC	12,0	265	D 2866 LF35 <V2600, Euro 2>		07.99-09.01		6	<b>0 432 131 631</b> <sup>1</sup>	
							6	<b>0 432 131 633</b>	
FNLLC, FNLLC/L	12,0	265	D 2866 LF24 <V2600, Euro 3>		01.00-12.02		6	<b>0 432 191 418</b> <sup>1</sup>	
							6	<b>0 432 191 419</b>	
<b>23.403</b> FNL	12,0	294	D 2866 LF20 <V2600, Euro 2>		01.94-09.01		6	<b>0 432 131 734</b> <sup>1</sup>	
							6	<b>0 432 131 788</b>	<b>0 986 430 312</b>
<b>23.414</b> FNLC	12,0	301	D 2866 LF31 <V2600, Euro 2>		03.00-12.01		6	<b>0 432 191 416</b>	
					05.00-12.01		6	<b>0 432 191 415</b> <sup>1</sup>	
FNLLC, FNLLC/L	12,0	301	D 2866 LF25 <V2600, Euro 3>		01.00-12.02		6	<b>0 432 191 418</b> <sup>1</sup>	
							6	<b>0 432 191 419</b>	
<b>23.463</b> FNL	12,8	338	D 2876 LF02 <V2400, Euro 2>		01.94-09.01		6	<b>0 432 131 760</b>	<b>0 986 430 451</b>
					10.95-09.01		6	<b>0 432 131 733</b> <sup>1</sup>	
<b>23.464</b> FNLC	12,8	338	D 2876 LF06 <V2400, Euro 2>		07.99-01.00		6	<b>0 432 191 483</b>	
					07.99-04.00		6	<b>0 432 191 482</b> <sup>1</sup>	
					02.00-09.01		6	<b>0 432 191 416</b>	
					05.00-09.01		6	<b>0 432 191 415</b> <sup>1</sup>	
FNLLC, FNLLC/L	12,8	338	D 2876 LF03 <V2400, Euro 3>		01.00-04.00		6	<b>0 432 191 482</b> <sup>1</sup>	
					01.00-12.02		6	<b>0 432 191 416</b>	
<b>24.293</b> FNL	10,0	213	D 2865 LF24 <V2500, Euro 2>		01.94-01.00		5	<b>0 432 131 633</b>	
<b>24.314</b> FNLLRC	12,0	228	D 2866 LF23 <V2600, Euro 3>		01.00-08.02		6	<b>0 432 191 418</b> <sup>1</sup>	
							6	<b>0 432 191 419</b>	
			D 2866 LF34 <V2600, Euro 2>		07.99-09.01		6	<b>0 432 131 631</b> <sup>1</sup>	
							6	<b>0 432 131 633</b>	
<b>24.343</b> FNL	10,0	250	D 2865 LF21 <V2500, Euro 2>		01.94-01.00		5	<b>0 432 131 734</b> <sup>1</sup>	
							5	<b>0 432 131 788</b>	<b>0 986 430 312</b>
<b>24.364</b> FNLLRC	12,0	265	D 2866 LF35 <V2600, Euro 2>		07.99-09.01		6	<b>0 432 131 631</b> <sup>1</sup>	
							6	<b>0 432 131 633</b>	
<b>24.403</b> FNL	12,0	294	D 2866 LF20 <V2600, Euro 2>		01.94-09.01		6	<b>0 432 131 734</b> <sup>1</sup>	
							6	<b>0 432 131 788</b>	<b>0 986 430 312</b>
<b>24.414</b> FNLLRC	12,0	301	D 2866 LF31 <V2600, Euro 2>		03.00-12.01		6	<b>0 432 191 416</b>	
					05.00-12.01		6	<b>0 432 191 415</b> <sup>1</sup>	
<b>24.463</b> FNL	12,8	338	D 2876 LF02 <V2400, Euro 2>		01.94-09.01		6	<b>0 432 131 760</b>	<b>0 986 430 451</b>
					10.95-09.01		6	<b>0 432 131 733</b> <sup>1</sup>	
<b>24.464</b> FNLLRC	12,8	338	D 2876 LF06 <V2400, Euro 2>		07.99-01.00		6	<b>0 432 191 483</b>	
					07.99-04.00		6	<b>0 432 191 482</b> <sup>1</sup>	
					02.00-09.01		6	<b>0 432 191 416</b>	
					05.00-09.01		6	<b>0 432 191 415</b> <sup>1</sup>	
<b>26.293</b> DF, DFL, FNL, FVL	10,0	213	D 2865 LF24 <V2500, Euro 2>		04.95-01.00		5	<b>0 432 131 633</b>	
<b>26.314</b> DFL, DFS/DFK/DF-TM/DFC, FNLLC/FNLLW, FNLS/FNLC, FVL	12,0	228	D 2866 LF34 <V2600, Euro 2>		07.99-06.02		6	<b>0 432 131 631</b> <sup>1</sup>	
FNL	12,0	228	D 2866 LF23 <V2600, Euro 3>		12.00-06.02		6	<b>0 432 191 418</b> <sup>1</sup>	
							6	<b>0 432 191 419</b>	
<b>26.343</b> DF, DFL, FNL, FVL	10,0	250	D 2865 LF21 <V2500, Euro 2>		01.94-01.00		5	<b>0 432 131 734</b> <sup>1</sup>	
							5	<b>0 432 131 788</b>	<b>0 986 430 312</b>















◀ MAN

<b>26.364</b> DF, DFL, FNL, FNLL, FVL	12,0	265	D 2866 LF35 <V2600, Euro 2>	07.99-06.02	6	<b>0 432 131 631</b> <sup>1</sup>	
					6	<b>0 432 131 633</b>	
<b>26.403</b> DF, DFL, FNL, FVL	12,0	294	D 2866 LF20 <V2600, Euro 2>	01.94-09.01	6	<b>0 432 131 734</b> <sup>1</sup>	
					6	<b>0 432 131 788</b>	<b>0 986 430 312</b>
<b>26.414</b> DFL, DFS/DFK/DF-TM/DFC, FNL, FNLLC/FNLLW, FVL	12,0	301	D 2866 LF31 <V2600, Euro 2>	03.00-06.02	6	<b>0 432 191 416</b>	
				05.00-06.02	6	<b>0 432 191 415</b> <sup>1</sup>	
<b>26.463</b> DF, DFL, FNL, FVL	12,8	338	D 2876 LF02 <V2400, Euro 2>	01.94-09.01	6	<b>0 432 131 760</b>	<b>0 986 430 451</b>
				10.95-09.01	6	<b>0 432 131 733</b> <sup>1</sup>	
<b>26.464</b> DF, DFL, FNL, FNLL, FVL	12,8	338	D 2876 LF06 <V2400, Euro 2>	07.99-01.00	6	<b>0 432 191 483</b>	
				07.99-04.00	6	<b>0 432 191 482</b> <sup>1</sup>	
				02.00-06.02	6	<b>0 432 191 416</b>	
				05.00-06.02	6	<b>0 432 191 415</b> <sup>1</sup>	
<b>26.603</b> DFL	18,3	441	D 2840 LF20 <V3400, Euro 2>	06.96-02.99	10	<b>0 432 133 839</b>	
<b>27.293</b> DF, DFA	10,0	213	D 2865 LF24 <V2500, Euro 2>	04.95-01.00	5	<b>0 432 131 633</b>	
<b>27.314</b> DF, DFA	12,0	228	D 2866 LF34 <V2600, Euro 2>	07.99-09.01	6	<b>0 432 131 631</b> <sup>1</sup>	
					6	<b>0 432 131 633</b>	
<b>27.343</b> DF, DFA	10,0	250	D 2865 LF21 <V2500, Euro 2>	01.94-01.00	5	<b>0 432 131 734</b> <sup>1</sup>	
					5	<b>0 432 131 788</b>	<b>0 986 430 312</b>
<b>27.364</b> DF, DFA	12,0	265	D 2866 LF35 <V2600, Euro 2>	07.99-09.01	6	<b>0 432 131 631</b> <sup>1</sup>	
					6	<b>0 432 131 633</b>	
<b>27.403</b> DFA, DFC	12,0	294	D 2866 LF20 <V2600, Euro 2>	01.94-09.01	6	<b>0 432 131 734</b> <sup>1</sup>	
					6	<b>0 432 131 788</b>	<b>0 986 430 312</b>
<b>27.414</b> DF, DFA	12,0	301	D 2866 LF31 <V2600, Euro 2>	03.00-12.01	6	<b>0 432 191 416</b>	
				05.00-12.01	6	<b>0 432 191 415</b> <sup>1</sup>	
<b>27.463</b> DF, DFA	12,8	338	D 2876 LF02 <V2400, Euro 2>	01.94-09.01	6	<b>0 432 131 760</b>	<b>0 986 430 451</b>
				10.95-09.01	6	<b>0 432 131 733</b> <sup>1</sup>	
<b>27.464</b> DF, DFA	12,8	338	D 2876 LF06 <V2400, Euro 2>	07.99-01.00	6	<b>0 432 191 483</b>	
				07.99-04.00	6	<b>0 432 191 482</b> <sup>1</sup>	
				02.00-09.01	6	<b>0 432 191 416</b>	
				05.00-09.01	6	<b>0 432 191 415</b> <sup>1</sup>	
<b>27.603</b> DF, DFA	18,3	441	D 2840 LF20 <V3400, Euro 2>	06.96-02.99	10	<b>0 432 133 839</b>	
<b>32.293</b> VF	10,0	213	D 2865 LF24 <V2500, Euro 2>	08.95-01.00	5	<b>0 432 131 633</b>	
<b>32.314</b> VF-TM	12,0	228	D 2866 LF34 <V2600, Euro 2>	07.99-09.01	6	<b>0 432 131 631</b> <sup>1</sup>	
					6	<b>0 432 131 633</b>	
<b>32.343</b> VF	10,0	250	D 2865 LF21 <V2500, Euro 2>	08.95-01.00	5	<b>0 432 131 734</b> <sup>1</sup>	
					5	<b>0 432 131 788</b>	<b>0 986 430 312</b>
<b>32.364</b> VF	12,0	265	D 2866 LF35 <V2600, Euro 2>	07.99-09.01	6	<b>0 432 131 631</b> <sup>1</sup>	
					6	<b>0 432 131 633</b>	
<b>32.403</b> VF	12,0	294	D 2866 LF20 <V2600, Euro 2>	08.95-09.01	6	<b>0 432 131 734</b> <sup>1</sup>	
					6	<b>0 432 131 788</b>	<b>0 986 430 312</b>
<b>32.414</b> VF	12,0	301	D 2866 LF31 <V2600, Euro 2>	03.00-12.01	6	<b>0 432 191 416</b>	
				05.00-12.01	6	<b>0 432 191 415</b> <sup>1</sup>	
<b>32.463</b> VF	12,8	338	D 2876 LF02 <V2400, Euro 2>	08.95-09.01	6	<b>0 432 131 760</b>	<b>0 986 430 451</b>
				10.95-09.01	6	<b>0 432 131 733</b> <sup>1</sup>	
<b>32.464</b> VF	12,8	338	D 2876 LF06 <V2400, Euro 2>	07.99-01.00	6	<b>0 432 191 483</b>	
				07.99-04.00	6	<b>0 432 191 482</b> <sup>1</sup>	
				02.00-09.01	6	<b>0 432 191 416</b>	
				05.00-09.01	6	<b>0 432 191 415</b> <sup>1</sup>	
<b>33.343</b> DF, DFA	10,0	250	D 2865 LF21 <V2500, Euro 2>	01.94-01.00	5	<b>0 432 131 734</b> <sup>1</sup>	
					5	<b>0 432 131 788</b>	<b>0 986 430 312</b>
<b>33.364</b> DF, DFA	12,0	265	D 2866 LF35 <V2600, Euro 2>	07.99-09.01	6	<b>0 432 131 631</b> <sup>1</sup>	
					6	<b>0 432 131 633</b>	
<b>33.373</b>	12,0	272	D 2866 LF21 <V2600, Euro 1>	01.94-12.00	6	<b>0 432 131 853</b>	<b>0 986 430 196</b>
<b>33.374</b> K/L	12,0	272	D 2866 LF21 <V2600, Euro 1>	01.01-→	6	<b>0 432 131 853</b>	<b>0 986 430 196</b>
<b>33.403</b> DF, DFA	12,0	294	D 2866 LF20 <V2600, Euro 2>	01.94-09.01	6	<b>0 432 131 734</b> <sup>1</sup>	
					6	<b>0 432 131 788</b>	<b>0 986 430 312</b>
<b>33.414</b> DF	12,0	301	D 2866 LF31 <V2600, Euro 2>	03.00-12.01	6	<b>0 432 191 416</b>	
				05.00-12.01	6	<b>0 432 191 415</b> <sup>1</sup>	
<b>33.463</b> DF, DFA	12,8	338	D 2876 LF02 <V2400, Euro 2>	01.94-09.01	6	<b>0 432 131 760</b>	<b>0 986 430 451</b>
				10.95-09.01	6	<b>0 432 131 733</b> <sup>1</sup>	



									
33.464 DF	12,8	338	D 2876 LF06 <V2400, Euro 2>				6	0 432 191 483	
								0 432 191 482 <sup>1</sup>	
								0 432 191 416	
								0 432 191 415 <sup>1</sup>	
33.603 DF, DFA	18,3	441	D 2840 LF20 <V3400, Euro 2>				10	0 432 133 839	
35.343 VF	10,0	250	D 2865 LF21 <V2500, Euro 2>				5	0 432 131 734 <sup>1</sup>	
								0 432 131 788	0 986 430 312
35.364 VF	12,0	265	D 2866 LF35 <V2600, Euro 2>				6	0 432 131 631 <sup>1</sup>	
								0 432 131 633	
35.403 VF	12,0	294	D 2866 LF20 <V2600, Euro 2>				6	0 432 131 734 <sup>1</sup>	
								0 432 131 788	0 986 430 312
35.414 VF	12,0	301	D 2866 LF31 <V2600, Euro 2>				6	0 432 191 416	
								0 432 191 415 <sup>1</sup>	
35.463 VF	12,8	338	D 2876 LF02 <V2400, Euro 2>				6	0 432 131 760	0 986 430 451
								0 432 131 733 <sup>1</sup>	
								0 432 131 733 <sup>1</sup>	
35.464 VF	12,8	338	D 2876 LF06 <V2400, Euro 2>				6	0 432 191 483	
								0 432 191 482 <sup>1</sup>	
								0 432 191 416	
								0 432 191 415 <sup>1</sup>	
40.414 DFA, DFK	12,0	301	D 2866 LF31 <V2600, Euro 2>				6	0 432 191 416	
								0 432 191 415 <sup>1</sup>	
40.464 DFA, DFK	12,8	338	D 2876 LF06 <V2400, Euro 2>				6	0 432 191 483	
								0 432 191 482 <sup>1</sup>	
								0 432 191 416	
								0 432 191 415 <sup>1</sup>	
41.343 VF	10,0	250	D 2865 LF21 <V2500, Euro 2>				5	0 432 131 734 <sup>1</sup>	
								0 432 131 788	0 986 430 312
41.364 VF	12,0	265	D 2866 LF35 <V2600, Euro 2>				6	0 432 131 631 <sup>1</sup>	
								0 432 131 633	
41.403 VF	12,0	294	D 2866 LF20 <V2600, Euro 2>				6	0 432 131 734 <sup>1</sup>	
								0 432 131 788	0 986 430 312
41.414 VF	12,0	301	D 2866 LF31 <V2600, Euro 2>				6	0 432 191 416	
								0 432 191 415 <sup>1</sup>	
41.463 VF	12,8	338	D 2876 LF02 <V2400, Euro 2>				6	0 432 131 760	0 986 430 451
								0 432 131 733 <sup>1</sup>	
								0 432 131 733 <sup>1</sup>	
41.464 VF	12,8	338	D 2876 LF06 <V2400, Euro 2>				6	0 432 191 483	
								0 432 191 482 <sup>1</sup>	
								0 432 191 416	
								0 432 191 415 <sup>1</sup>	
<b>F2000 Evol. (FE)</b>									
26.310 DF	12,0	228	D 2866 LF23 <V2600, Euro 3>				6	0 432 191 418 <sup>1</sup>	
								0 432 191 419	
26.360 DF	12,0	265	D 2866 LF24 <V2600, Euro 3>				6	0 432 191 418 <sup>1</sup>	
								0 432 191 419	
35.310 VF	12,0	228	D 2866 LF23 <V2600, Euro 3>				6	0 432 191 418 <sup>1</sup>	
								0 432 191 419	
35.410 VF	12,0	301	D 2866 LF25 <V2600, Euro 3>				6	0 432 191 418 <sup>1</sup>	
								0 432 191 419	
310A DA, DF, F, FA, F, FL, VF	12,0	228	D 2866 LF23 <V2600, Euro 3>				6	0 432 191 418 <sup>1</sup>	
								0 432 191 419	
360A DA, DF, F, FA, F, FL, VF	12,0	265	D 2866 LF24 <V2600, Euro 3>				6	0 432 191 418 <sup>1</sup>	
								0 432 191 419	
410A DA, DF, F, FA, VF	12,0	301	D 2866 LF25 <V2600, Euro 3>				6	0 432 191 418 <sup>1</sup>	
								0 432 191 419	
460A DA, DF, F, FA, VF	12,8	338	D 2876 LF03 <V2400, Euro 3>				6	0 432 191 482 <sup>1</sup>	
								0 432 191 416	
<b>Lion's</b>									
6120 [A92]	12,0	257	D 2866 LOH26 <V1500, Euro 2>				6	0 432 131 631 <sup>1</sup>	
								0 432 131 633	
		265	D 2866 LOH28 <Euro 3>				6	0 432 191 417 <sup>1</sup>	
							6	0 432 191 419	















◀ MAN

Lion's City / NL							
NL 223 [A21]	6,9	162	D 0826 LUH12 <Euro 2>	07.98-09.01	6	0 432 133 842 <sup>1</sup>	
			D 0836 LUH02 <Euro 3>	01.01-06.05	6	0 432 133 855	0 986 430 313
NL 243 [A21]	12,0	191	D 2866 LUH23 <Euro 3>	01.02-09.06	6	0 432 191 417 <sup>1</sup>	
					6	0 432 191 419	
NL 283 [A21]	6,9	206	D 0836 LUH01 <Euro 3>	01.01-09.06	6	0 432 133 766	
NL 313 [A21]	12,0	228	D 2866 LUH24 <Euro 3>	01.01-09.06	6	0 432 191 417 <sup>1</sup>	
					6	0 432 191 419	
Lion's City DD / ND							
ND 313 [A39]	12,0	228	D 2866 LUH51 <Euro 4>	08.03-12.07	6	0 432 191 249 <sup>1</sup>	
					6	0 432 191 250	
					6	0 432 191 414 <sup>1</sup>	
Lion's City G / GL							
[A23]	12,0	228	D 2866 LOH27 <V4800, Euro 3>	06.06-08.09	6	0 432 191 417 <sup>1</sup>	
			D 2866 LUH28 <Euro 3>	06.06-08.09	6	0 432 191 417 <sup>1</sup>	
					6	0 432 191 419	
Lion's City G / NG							
NG 263 [A23]	12,0	191	D 2866 LUH22 <Euro 2>	07.98-09.01	6	0 432 131 631 <sup>1</sup>	
			D 2866 LUH23 <Euro 3>	01.01-09.06	6	0 432 131 633	
					6	0 432 191 417 <sup>1</sup>	
					6	0 432 191 419	
NG 313 [A23]	12,0	228	D 2866 LUH24 <Euro 3>	01.01-09.06	6	0 432 191 417 <sup>1</sup>	
			D 2866 LUH26 <Euro 2>	07.98-12.01	6	0 432 191 419	
					6	0 432 131 631 <sup>1</sup>	
					6	0 432 131 633	
NG 353 [A23]	12,0	258	D 2866 LUH21 <V3200, Euro 2>	01.01-12.01	6	0 432 131 631 <sup>1</sup>	
					6	0 432 131 633	
NG 363 [A23]	12,0	265	D 2866 LUH25 <Euro 3>	01.01-09.06	6	0 432 191 417 <sup>1</sup>	
					6	0 432 191 419	
Lion's City LL / NL							
NL 263 [A26]	12,0	191	D 2866 LUH22 <Euro 2>	08.98-09.01	6	0 432 131 631 <sup>1</sup>	
			D 2866 LUH23 <Euro 3>	01.01-09.02	6	0 432 131 633	
					6	0 432 191 417 <sup>1</sup>	
					6	0 432 191 419	
NL 313 [A26]	12,0	228	D 2866 LUH24 <Euro 3>	01.01-09.06	6	0 432 191 417 <sup>1</sup>	
			D 2866 LUH26 <Euro 2>	08.98-12.01	6	0 432 191 419	
					6	0 432 131 631 <sup>1</sup>	
					6	0 432 131 633	
NL 353 [A26]	12,0	257	D 2866 LUH21 <V3200, Euro 2>	08.98-12.01	6	0 432 131 631 <sup>1</sup>	
					6	0 432 131 633	
NL 363 [A26]	12,0	265	D 2866 LUH25 <Euro 3>	01.01-09.06	6	0 432 191 417 <sup>1</sup>	
					6	0 432 191 419	
Lion's City M / NM							
[A47]	6,9	162	D 0836 LOH03 <Euro 3>	04.04-09.06	6	0 432 133 765	
Lion's City T / TÜ / EL							
[A78]	6,9	162	D 0836 LOH03 <Euro 3>	06.04-09.06	6	0 432 133 765	
		206	D 0836 LOH02 <Euro 3>	06.04-09.06	6	0 432 133 766	
Lion's City Ü / NÜ							
[A20]	12,0	191	D 2866 LUH34 <Euro 3>	03.06→	6	0 432 191 417 <sup>1</sup>	
					6	0 432 191 419	
NÜ 263 [A20]	6,9	191	D 0826 LUH13 <V0300, Euro 2>	07.98-09.01	6	0 432 133 840	
					6	0 432 133 841 <sup>1</sup>	
	10,0	191	D 2865 LUH09 <V1400, Euro 2>	09.96-07.98	5	0 432 131 633	
	12,0	191	D 2866 LUH22 <Euro 2>	07.98-09.01	6	0 432 131 631 <sup>1</sup>	
					6	0 432 131 633	
			D 2866 LUH23 <Euro 3>	01.01-09.06	6	0 432 191 417 <sup>1</sup>	
					6	0 432 191 419	
NÜ 283 [A20]	6,9	206	D 0836 LUH01 <V4600, Euro 3>	01.01-09.06	6	0 432 133 766	
NÜ 313 [A20]	12,0	228	D 2866 LUH24 <Euro 3>	01.01-09.06	6	0 432 191 417 <sup>1</sup>	
					6	0 432 191 419	



										
<b>NÜ 313</b> [A20]	12,0	228	D 2866 LUH26 <Euro 2>		07.98-12.01		6	<b>0 432 131 631</b> <sup>1</sup>		
							6	<b>0 432 131 633</b>		
<b>Lion's City ÜLL / NÜ</b>										
<b>NÜ 313</b> [A25]	12,0	228	D 2866 LUH24 <Euro 3>		02.98-09.06		6	<b>0 432 191 417</b> <sup>1</sup>		
					03.00-09.06		6	<b>0 432 191 419</b>		
			D 2866 LUH26 <Euro 2>		02.98-12.01		6	<b>0 432 131 631</b> <sup>1</sup>		
							6	<b>0 432 131 633</b>		
<b>NÜ 353</b> [A25]	12,0	257	D 2866 LUH21 <V3200, Euro 2>		02.98-12.01		6	<b>0 432 131 631</b> <sup>1</sup>		
							6	<b>0 432 131 633</b>		
<b>NÜ 363</b> [A25]	12,0	265	D 2866 LUH25 <Euro 3>		01.01-09.06		6	<b>0 432 191 417</b> <sup>1</sup>		
							6	<b>0 432 191 419</b>		
<b>Lion's Classic G / SG</b>										
<b>SG 263</b> [A75]	12,0	191	D 2866 LUH23 <Euro 3>		06.03-09.06		6	<b>0 432 191 417</b> <sup>1</sup>		
							6	<b>0 432 191 419</b>		
<b>SG 313</b> [A75]	12,0	228	D 2866 LUH24 <Euro 3>		06.03-09.06		6	<b>0 432 191 417</b> <sup>1</sup>		
							6	<b>0 432 191 419</b>		
<b>Lion's Classic SL</b>										
<b>SL 223</b> [A74]	6,9	162	D 0836 LOH03 <Euro 3>		06.03-10.06		6	<b>0 432 133 765</b>		
<b>SL 283</b> [A74]	6,9	206	D 0836 LOH02 <Euro 3>		06.03-09.06		6	<b>0 432 133 766</b>		
<b>Lion's Classic Ü / SÜ</b>										
<b>SÜ 223</b> [A72]	6,9	162	D 0836 LOH03 <Euro 3>		06.04-09.06		6	<b>0 432 133 765</b>		
<b>SÜ 283</b> [A72]	6,9	206	D 0836 LOH02 <Euro 3>		06.04-09.06		6	<b>0 432 133 766</b>		
<b>SÜ 313</b> [A72]	12,0	228	D 2866 LUH24 <Euro 3>		06.04-09.06		6	<b>0 432 191 417</b> <sup>1</sup>		
							6	<b>0 432 191 419</b>		
<b>SÜ 363</b> [A72]	12,0	265	D 2866 LUH25 <Euro 3>		06.04-09.06		6	<b>0 432 191 417</b> <sup>1</sup>		
							6	<b>0 432 191 419</b>		
<b>Lion's Coach</b>										
<b>C,L</b> [R07,R08,R09]	12,0	301	D 2866 LOH34 <Euro 3>		09.02-09.06		6	<b>0 432 191 417</b> <sup>1</sup>		
							6	<b>0 432 191 419</b>		
	12,8	338	D 2876 LOH03 <Euro 3>		09.02-09.06		6	<b>0 432 191 414</b> <sup>1</sup>		
							6	<b>0 432 191 416</b>		
<b>Lion's Coach RHC</b>										
<b>RHC 414</b> [R07,R08,R09]	12,0	301	D 2866 LOH34 <Euro 3>		09.02-09.06		6	<b>0 432 191 417</b> <sup>1</sup>		
							6	<b>0 432 191 419</b>		
<b>RHC 464</b> [R07,R08,R09]	12,8	338	D 2876 LOH03 <Euro 3>		09.02-09.06		6	<b>0 432 191 414</b> <sup>1</sup>		
							6	<b>0 432 191 416</b>		
<b>Lion's Comfort</b>										
<b>R 313</b> [A01,A04]	12,0	228	D 2866 LUH26 <Euro 2>		01.98-12.01		6	<b>0 432 131 631</b> <sup>1</sup>		
							6	<b>0 432 131 633</b>		
<b>ÜL 313</b> [A01,A04]	12,0	228	D 2866 LUH26 <Euro 2>		05.99-12.01		6	<b>0 432 131 631</b> <sup>1</sup>		
							6	<b>0 432 131 633</b>		
<b>ÜL 353</b> [A01,A04]	12,0	257	D 2866 LUH21 <V3200, Euro 2>		01.98-12.01		6	<b>0 432 131 631</b> <sup>1</sup>		
							6	<b>0 432 131 633</b>		
<b>Lion's Regio</b>										
<b>ÜL 314</b> [R12,R13,R14]	12,0	228	D 2866 LUH24 <Euro 3>		06.04-09.06		6	<b>0 432 191 417</b> <sup>1</sup>		
							6	<b>0 432 191 419</b>		
<b>ÜL 364</b> [R12,R13,R14]	12,0	265	D 2866 LUH25 <Euro 3>		06.04-09.06		6	<b>0 432 191 417</b> <sup>1</sup>		
							6	<b>0 432 191 419</b>		
<b>Lion's Star</b>										
<b>RH 352</b> [A03]	12,0	257	D 2866 LOH26 <V1500, Euro 2>		07.98-09.01		6	<b>0 432 131 631</b> <sup>1</sup>		
							6	<b>0 432 131 633</b>		
<b>RH 402</b> [A03]	12,0	294	D 2866 LOH23 <Euro 2>		07.98-09.01		6	<b>0 432 131 734</b> <sup>1</sup>		
							6	<b>0 432 131 788 0 986 430 312</b>		
<b>RH 463</b> [A03]	12,8	338	D 2876 LOH01 <V3300, Euro 2>		06.99-09.01		6	<b>0 432 131 733</b> <sup>1</sup>		
							6	<b>0 432 131 760 0 986 430 451</b>		
<b>RHS 414</b> [R02,R03]	12,0	301	D 2866 LOH34 <Euro 3>		10.01-09.06		6	<b>0 432 191 417</b> <sup>1</sup>		
							6	<b>0 432 191 419</b>		
<b>RHS 464</b> [R02,R03]	12,0	338	D 2876 LOH03 <V4500, Euro 3>		10.01-09.06		6	<b>0 432 191 414</b> <sup>1</sup>		
							6	<b>0 432 191 416</b>		
<b>Lion's Star L</b>										
<b>RHS 414</b> [R02,R03]	12,0	301	D 2866 LOH34 <Euro 3>		10.01-09.06		6	<b>0 432 191 417</b> <sup>1</sup>		
							6	<b>0 432 191 419</b>		





◀ MAN

<b>RHS 464</b> [R02,R03]	12,0	338	D 2876 LOH03 <V4500, Euro 3>	10.01-09.06	6	<b>0 432 191 414</b> <sup>1</sup>	
					6	<b>0 432 191 416</b>	
<b>Lion's Top Coach</b>							
<b>RH 403</b> [A32]	12,0	294	D 2866 LOH23 <Euro 2>	06.99-01.04	6	<b>0 432 131 734</b> <sup>1</sup>	
					6	<b>0 432 131 788</b>	<b>0 986 430 312</b>
<b>RH 423</b> [A32]	12,0	309	D 2866 LOH20 <V1500, Euro 1>	04.00-01.04	6	<b>0 432 131 831</b>	<b>0 986 430 228</b>
<b>RH 463</b> [A32]	12,8	339	D 2876 LOH01 <V3300, Euro 2>	06.99-01.04	6	<b>0 432 131 733</b> <sup>1</sup>	
					6	<b>0 432 131 760</b>	<b>0 986 430 451</b>
<b>RHC 464</b> [R08]	12,8	339	D 2876 LOH03 <Euro 3>	01.08→	6	<b>0 432 191 414</b> <sup>1</sup>	
					6	<b>0 432 191 416</b>	
<b>Lion's Top Star</b>							
<b>RHS 414</b> [R03]	12,0	301	D 2866 LOH34 <Euro 3>	01.02-09.06	6	<b>0 432 191 417</b> <sup>1</sup>	
					6	<b>0 432 191 419</b>	
<b>RHS 464</b> [R03]	12,8	338	D 2876 LOH03 <Euro 3>	01.02-09.06	6	<b>0 432 191 414</b> <sup>1</sup>	
					6	<b>0 432 191 416</b>	
<b>L2000</b>							
<b>8.113 L</b> , LL	4,6	83	D 0824 LFL08 <V1700, Euro 2>	03.97-09.01	4	<b>0 432 131 702</b>	
<b>8.163 L</b> , LA, LL	4,6	114	D 0824 LFL09 <V1700, Euro 2>	03.97-03.01	4	<b>0 432 131 820</b>	<b>0 986 430 257</b>
				03.97-02.02	4	<b>0 432 131 820</b>	<b>0 986 430 257</b>
LL	4,6	104	D 0824 LFL07 <V1700, Euro 2>	03.97-03.01	4	<b>0 432 133 855</b>	<b>0 986 430 313</b>
<b>8.185 L</b> , LL	4,6	132	D 0834 LFL03 <V4400, Euro 3>	09.00-08.02	4	<b>0 432 133 765</b>	
					4	<b>0 432 133 799</b> <sup>1</sup>	
<b>8.224 L</b> , LA, LL	6,9	162	D 0826 LFL03 <V2300, Euro 2>	01.95-09.01	6	<b>0 432 133 855</b>	<b>0 986 430 313</b>
L, LC, LK, L-KI, LK-LV, LLC, LLS	6,9	162	D 0826 LFL10 <V2300, Euro 2>	07.94-09.01	6	<b>0 432 131 820</b>	<b>0 986 430 257</b>
<b>9.163 L</b> , LL	4,6	114	D 0824 LFL09 <V1700, Euro 2>	03.97-09.01	4	<b>0 432 131 820</b>	<b>0 986 430 257</b>
<b>9.185 L</b>	4,6	132	D 0834 LFL03 <V4400, Euro 3>	09.00-08.02	4	<b>0 432 133 765</b>	
					4	<b>0 432 133 799</b> <sup>1</sup>	
<b>9.224 L</b> , LL	6,9	162	D 0826 LFL03 <V2300, Euro 2>	01.95-09.01	6	<b>0 432 133 855</b>	<b>0 986 430 313</b>
LC, LK, L-KI, LK-LV, LLC, LLS	6,9	162	D 0826 LFL10 <V2300, Euro 2>	07.94-03.01	6	<b>0 432 131 820</b>	<b>0 986 430 257</b>
				07.94-09.01	6	<b>0 432 131 820</b>	<b>0 986 430 257</b>
<b>10.145 L</b>	4,6	103	D 0834 LFL02 <V4400, Euro 3>	07.01-06.02	4	<b>0 432 133 765</b>	
					4	<b>0 432 133 799</b> <sup>1</sup>	
<b>10.160 LA</b>	4,6	114	D 0824 LFL09 <V1700, Euro 2>	03.97-09.06	4	<b>0 432 131 820</b>	<b>0 986 430 257</b>
<b>10.163 L</b> , LA, LL	4,6	114	D 0824 LFL09 <V1700, Euro 2>	03.97→	4	<b>0 432 131 820</b>	<b>0 986 430 257</b>
<b>10.220 FOC</b> , FOCL	6,9	162	D 0826 LFL03 <V2300, Euro 2>	02.95-02.01	6	<b>0 432 133 855</b>	<b>0 986 430 313</b>
			D 0826 LFL10 <V2300, Euro 2>	07.98-09.01	6	<b>0 432 131 820</b>	<b>0 986 430 257</b>
<b>10.224 F</b> , FL, L, LA	6,9	162	D 0826 LFL03 <V2300, Euro 2>	01.95-09.01	6	<b>0 432 133 855</b>	<b>0 986 430 313</b>
F, FL, LA, LC, LK, LK-L	6,9	162	D 0826 LFL10 <V2300, Euro 2>	07.98-12.06	6	<b>0 432 131 820</b>	<b>0 986 430 257</b>
<b>12.163 L</b> , LL	4,6	114	D 0824 LFL09 <V1700, Euro 2>	03.97-08.01	4	<b>0 432 131 820</b>	<b>0 986 430 257</b>
<b>12.224 L</b> , LL	6,9	162	D 0826 LFL10 <V2300, Euro 2>	03.97-09.01	6	<b>0 432 131 820</b>	<b>0 986 430 257</b>
<b>14.163 L</b> , LL	4,6	114	D 0824 LFL09 <V1700, Euro 2>	03.97-08.01	4	<b>0 432 131 820</b>	<b>0 986 430 257</b>
<b>14.224 L</b> , LA, LL	6,9	162	D 0826 LFL10 <V2300, Euro 2>	03.97-09.01	6	<b>0 432 131 820</b>	<b>0 986 430 257</b>
<b>14.264 L</b> , LA, LL	6,9	191	D 0826 LFL09 <V2300, Euro 2>	08.95-09.01	6	<b>0 432 133 840</b>	
					6	<b>0 432 133 841</b> <sup>1</sup>	
<b>15.163 L</b> , LL	4,6	114	D 0824 LFL09 <V1700, Euro 2>	03.97-09.01	4	<b>0 432 131 820</b>	<b>0 986 430 257</b>
<b>15.224 L</b> , LL	6,9	162	D 0826 LFL10 <V2300, Euro 2>; D 0826 LFL10 <V2300, Euro 2>	03.97→	6	<b>0 432 131 820</b>	<b>0 986 430 257</b>
<b>15.264 L</b> , LL	6,9	191	D 0826 LFL09 <V2300, Euro 2>	08.95-09.01	6	<b>0 432 133 840</b>	
					6	<b>0 432 133 841</b> <sup>1</sup>	
<b>18.224 L</b> , LA, LL	6,9	162	D 0826 LFL10 <V2300, Euro 2>	03.97-09.01	6	<b>0 432 131 820</b>	<b>0 986 430 257</b>
<b>18.264 L</b> , LA, LL	6,9	191	D 0826 LFL09 <V2300, Euro 2>	08.95-09.01	6	<b>0 432 133 840</b>	
					6	<b>0 432 133 841</b> <sup>1</sup>	
<b>20.224 L</b> , LL	6,9	162	D 0826 LFL10 <V2300, Euro 2>	10.97-09.01	6	<b>0 432 131 820</b>	<b>0 986 430 257</b>
<b>20.264 L</b> , LL	6,9	191	D 0826 LFL09 <V2300, Euro 2>	10.97-09.01	6	<b>0 432 133 840</b>	
					6	<b>0 432 133 841</b> <sup>1</sup>	
<b>L2000 Evol. (LE)</b>							
<b>8.140 F</b> , FL	4,6	103	D 0834 LFL02 <V4400, Euro 3>	09.02-08.04	4	<b>0 432 133 765</b>	
					4	<b>0 432 133 799</b> <sup>1</sup>	
<b>8.150 F</b> , FL	4,6	110	D 0834 LFL04 <V4400, Euro 3>	06.04-12.05	4	<b>0 432 133 765</b>	
					4	<b>0 432 133 799</b> <sup>1</sup>	
<b>8.180 F</b> , FL	4,6	132	D 0834 LFL03 <V4400, Euro 3>	09.02-12.05	4	<b>0 432 133 765</b>	
					4	<b>0 432 133 799</b> <sup>1</sup>	
<b>8.220 F</b> , FL	6,9	162	D 0836 LFL02 <V3900, Euro 3>	09.02-12.05	6	<b>0 432 133 765</b>	







9.140 F, FL	4,6	103	D 0834 LFL02 <V4400, Euro 3>	09.02-08.04	4	0 432 133 765	
					4	0 432 133 799 <sup>1</sup>	
9.150 F, FL	4,6	110	D 0834 LFL04 <V4400, Euro 3>	06.04-06.05	4	0 432 133 765	
					4	0 432 133 799 <sup>1</sup>	
9.180 F, FL	4,6	132	D 0834 LFL03 <V4400, Euro 3>	09.02-06.05	4	0 432 133 765	
					4	0 432 133 799 <sup>1</sup>	
9.220 F, FL	6,9	162	D 0836 LFL02 <V3900, Euro 3>	09.02-06.05	6	0 432 133 765	
10.150 F, FL	4,6	110	D 0834 LFL04 <V4400, Euro 3>	06.04-06.05	4	0 432 133 765	
					4	0 432 133 799 <sup>1</sup>	
10.180 F, FA, F, FL	4,6	132	D 0834 LFL03 <V4400, Euro 3>	09.02-10.06	4	0 432 133 765	
					4	0 432 133 799 <sup>1</sup>	
10.220 F, FA, F, FL	6,9	162	D 0836 LFL02 <V3900, Euro 3>	09.02-12.06	6	0 432 133 765	
140C F, FL	4,6	103	D 0834 LFL02 <V4400, Euro 3>	07.01-08.02	4	0 432 133 765	
					4	0 432 133 799 <sup>1</sup>	
160B F, FL	4,6	114	D 0824 LFL06 <V1700, Euro 2>	09.00-09.01	4	0 432 133 855	0 986 430 313
160C F, FL	4,6	114	D 0824 LFL06 <V1700, Euro 2>	09.00-09.01	4	0 432 133 855	0 986 430 313
180C F, FA, F, FL	4,6	132	D 0834 LFL03 <V4400, Euro 3>	09.00-08.02	4	0 432 133 765	
					4	0 432 133 799 <sup>1</sup>	
220C F, FA, F, FL	6,9	162	D 0826 LFL10 <V2300, Euro 2>	09.00-01.02	6	0 432 131 820	0 986 430 257
			D 0836 LFL02 <V3900, Euro 3>	07.01-02.02	6	0 432 133 799 <sup>1</sup>	
				07.01-08.02	6	0 432 133 765	
<b>M2000</b>							
12.163 L	4,6	114	D 0824 LFL09 <V1700, Euro 2>	03.00-12.01	4	0 432 131 820	0 986 430 257
12.224 M, ML	6,9	162	D 0826 LF18 <V3000, Euro 2>	03.97-01.98	6	0 432 131 820	0 986 430 257
12.255 MC, MLS	6,9	180	D 0836 LF05 <V4000, Euro 3>	01.01-08.02	6	0 432 133 766	
					6	0 432 133 797 <sup>1</sup>	
12.264 M, ML	6,9	191	D 0826 LF17 <V3000, Euro 2>	03.97-09.01	6	0 432 133 840	
					6	0 432 133 841 <sup>1</sup>	
12.284 MC, MLC, MLS	6,9	206	D 0836 LF01 <V4000, Euro 2>	06.98-09.01	6	0 432 133 766	
					6	0 432 133 797 <sup>1</sup>	
12.285 MC	6,9	206	D 0836 LF03 <V4000, Euro 3>	01.01-09.01	6	0 432 133 766	
					6	0 432 133 797 <sup>1</sup>	
14.224 M, MA, ML	6,9	162	D 0826 LF18 <V3000, Euro 2>	03.97-01.98	6	0 432 131 820	0 986 430 257
14.264 M, MA, ML	6,9	191	D 0826 LF17 <V3000, Euro 2>	08.95-09.01	6	0 432 133 840	
					6	0 432 133 841 <sup>1</sup>	
14.284 LA-AF, LAC, LAK, LC, LRC, LK, LRK, LLC, LLLC	6,9	206	D 0836 LFL01 <V3900, Euro 2>	06.98-09.01	6	0 432 133 766	
MAK, MA-KO, MA-LF, MC, MLC, MLLC, MLS	6,9	206	D 0836 LF01 <V4000, Euro 2>	06.98-09.01	6	0 432 133 766	
					6	0 432 133 797 <sup>1</sup>	
15.284 LC, LK-LV, LLC, LLLC	6,9	206	D 0836 LFL01 <V3900, Euro 2>	06.98-09.01	6	0 432 133 766	
					6	0 432 133 797 <sup>1</sup>	
18.224 LS, AK, LA, MLLC	6,9	162	D 0826 LFL10 <V2300, Euro 2>	03.97→	6	0 432 131 820	0 986 430 257
M, MA, ML	6,9	162	D 0826 LF18 <V3000, Euro 2>	03.97-01.98	6	0 432 131 820	0 986 430 257
18.232 FOC/HOC	6,9	162	D 0826 LFL10 <V2300, Euro 2>	03.97→	6	0 432 131 820	0 986 430 257
18.264 M, MA, ML	6,9	191	D 0826 LF17 <V3000, Euro 2>	08.95-09.01	6	0 432 133 840	
					6	0 432 133 841 <sup>1</sup>	
18.282 FOC	6,9	206	D 0836 LF01 <V4000, Euro 2>	09.01→	6	0 432 133 766	
					6	0 432 133 797 <sup>1</sup>	
18.284 LAC, LAK-LV, LC, LK-LV, L-KO, LLC, LLK, LLLC	6,9	206	D 0836 LFL01 <V3900, Euro 2>	06.98-09.01	6	0 432 133 766	
LS, TSL, MAC, MAK, MAK-LV, MC, MK-LV, M-KO, MLK, MLLC, MLS	6,9	206	D 0836 LF01 <V4000, Euro 2>	06.98-09.01	6	0 432 133 766	
				06.98→	6	0 432 133 766	
					6	0 432 133 797 <sup>1</sup>	
18.292 FOC	6,9	206	D 0836 LF01 <V4000, Euro 2>	09.00→	6	0 432 133 766	
					6	0 432 133 797 <sup>1</sup>	
20.284 LNLC, LNLLC	6,9	206	D 0836 LFL01 <V3900, Euro 2>	05.99-09.01	6	0 432 133 766	
					6	0 432 133 797 <sup>1</sup>	
25.224 M, ML, MVL	6,9	162	D 0826 LF18 <V3000, Euro 2>	03.97-01.98	6	0 432 131 820	0 986 430 257
25.264 M, ML, MVL	6,9	191	D 0826 LF17 <V3000, Euro 2>	08.95-09.01	6	0 432 133 840	
					6	0 432 133 841 <sup>1</sup>	
25.284 LNLS, MNLC, MNLLC, MVL	6,9	206	D 0836 LF01 <V4000, Euro 2>	06.98→	6	0 432 133 766	
					6	0 432 133 797 <sup>1</sup>	

















◀ MAN

26.284 L, AK	6,9	206	D 0836 LF01 <V4000, Euro 2>	09.00→	6	0 432 133 766	
					6	0 432 133 797 <sup>1</sup>	
<b>M2000 Evol. (LE)</b>							
12.180 F, FL	4,6	132	D 0834 LFL03 <V4400, Euro 3>	09.02-12.05	4	0 432 133 765	
					4	0 432 133 799 <sup>1</sup>	
12.220 F, FL	6,9	162	D 0836 LFL02 <V3900, Euro 3>	09.02-06.06	6	0 432 133 765	
12.250 F, FL	6,9	180	D 0836 LFL05 <V3900, Euro 3>	09.02-06.06	6	0 432 133 766	
12.280 F, FL	6,9	206	D 0836 LFL03 <V3900, Euro 3>	09.02-06.06	6	0 432 133 766	
14.220 F, FL	6,9	162	D 0836 LFL02 <V3900, Euro 3>	09.02-06.06	6	0 432 133 765	
14.225 F, FA	6,9	162	D 0836 LFL02 <V3900, Euro 3>	09.02-09.06	6	0 432 133 765	
14.250 F, FL	6,9	180	D 0836 LFL05 <V3900, Euro 3>	09.02-06.06	6	0 432 133 766	
14.255 F, FA	6,9	180	D 0836 LFL05 <V3900, Euro 3>	09.02-09.06	6	0 432 133 766	
14.280 F, FL	6,9	206	D 0836 LFL03 <V3900, Euro 3>	09.02-06.06	6	0 432 133 766	
14.285 F, FA	6,9	206	D 0836 LFL03 <V3900, Euro 3>	09.02-09.06	6	0 432 133 766	
15.180 F, FL	4,6	132	D 0834 LFL03 <V4400, Euro 3>	09.02-03.05	4	0 432 133 765	
					4	0 432 133 799 <sup>1</sup>	
15.220 F, FL	6,9	162	D 0836 LFL02 <V3900, Euro 3>	09.02-09.06	6	0 432 133 765	
15.250 F, FL	6,9	180	D 0836 LFL05 <V3900, Euro 3>	09.02-09.06	6	0 432 133 766	
15.280 F, FL	6,9	206	D 0836 LFL03 <V3900, Euro 3>	09.02-09.06	6	0 432 133 766	
18.220 F, FA, F, FL	6,9	162	D 0836 LFL02 <V3900, Euro 3>	09.02-09.06	6	0 432 133 765	
18.250B F, FA	6,9	180	D 0836 LF05 <V4000, Euro 3>	09.02-09.06	6	0 432 133 766	
					6	0 432 133 797 <sup>1</sup>	
F, FL	6,9	180	D 0836 LFL05 <V3900, Euro 3>	09.02-09.06	6	0 432 133 766	
18.280 F, FA, F, FL	6,9	206	D 0836 LFL03 <V3900, Euro 3>	09.02-09.06	6	0 432 133 766	
20.220 DF	6,9	162	D 0836 LFL02 <V3900, Euro 3>	09.02-09.06	6	0 432 133 765	
20.250 DF	6,9	180	D 0836 LFL05 <V3900, Euro 3>	09.02-09.06	6	0 432 133 766	
20.280 DF	6,9	206	D 0836 LFL03 <V3900, Euro 3>	09.02-09.06	6	0 432 133 766	
160B F, FA, F, FL	4,6	114	D 0824 LFL06 <V1700, Euro 2>	09.00-09.01	4	0 432 133 855	0 986 430 313
180B F, FL	4,6	132	D 0834 LFL03 <V4400, Euro 3>	07.01-08.02	4	0 432 133 765	
					4	0 432 133 799 <sup>1</sup>	
180C F, FL	4,6	132	D 0834 LFL03 <V4400, Euro 3>	07.01-09.02	4	0 432 133 765	
					4	0 432 133 799 <sup>1</sup>	
220B DF, F, FA, F, FL	6,9	162	D 0836 LFL02 <V3900, Euro 3>	07.01-02.02	6	0 432 133 799 <sup>1</sup>	
				07.01-09.02	6	0 432 133 765	
DF, F, FL	6,9	162	D 0826 LFL10 <V2300, Euro 2>	08.00-09.01	6	0 432 131 820	0 986 430 257
220C F, FL	6,9	162	D 0836 LFL02 <V3900, Euro 3>	07.01-02.02	6	0 432 133 799 <sup>1</sup>	
				07.01-08.02	6	0 432 133 765	
250B DF, F, FA, F, FL	6,9	180	D 0836 LFL05 <V3900, Euro 3>	07.01-02.02	6	0 432 133 797 <sup>1</sup>	
				07.01-08.02	6	0 432 133 766	
				07.01-09.02	6	0 432 133 766	
F, FA	6,9	180	D 0836 LF05 <V4000, Euro 3>	07.01-08.02	6	0 432 133 766	
					6	0 432 133 797 <sup>1</sup>	
280B DF, F, FA, F, FL	6,9	206	D 0836 LFL03 <V3900, Euro 3>	07.01-02.02	6	0 432 133 797 <sup>1</sup>	
				07.01-09.02	6	0 432 133 766	
DF, F, FL	6,9	206	D 0836 LF01 <V4000, Euro 2>	09.00-09.01	6	0 432 133 766	
					6	0 432 133 797 <sup>1</sup>	
<b>M2000 Evol. (ME)</b>							
12.220 F, FL	6,9	162	D 0836 LF04 <V4000, Euro 3>	09.02-07.05	6	0 432 133 765	
					6	0 432 133 799 <sup>1</sup>	
12.250 F, FL	6,9	180	D 0836 LF05 <V4000, Euro 3>	09.02-07.05	6	0 432 133 766	
					6	0 432 133 797 <sup>1</sup>	
12.280 F, FL	6,9	206	D 0836 LF03 <V4000, Euro 3>	09.02-07.05	6	0 432 133 766	
14.220 F, FA, F, FL	6,9	162	D 0836 LF04 <V4000, Euro 3>	09.02-07.05	6	0 432 133 765	
					6	0 432 133 799 <sup>1</sup>	
14.250 F, FA	6,9	180	D 0836 LF05 <V4000, Euro 3>	09.02-07.05	6	0 432 133 766	
					6	0 432 133 797 <sup>1</sup>	
F, FL	6,9	180	D 0836 LFL05 <V3900, Euro 3>	09.02-07.05	6	0 432 133 766	
14.280 F, FA, F, FL	6,9	206	D 0836 LFL03 <V3900, Euro 3>	09.02-07.05	6	0 432 133 766	
18.220 F, FA, F, FL	6,9	162	D 0836 LF04 <V4000, Euro 3>	09.02-07.05	6	0 432 133 765	
					6	0 432 133 799 <sup>1</sup>	
18.250 F, FA, F, FL	6,9	180	D 0836 LFL05 <V3900, Euro 3>	09.02-07.05	6	0 432 133 766	
18.280 F, FA, F, FL	6,9	206	D 0836 LFL03 <V3900, Euro 3>	09.02-07.05	6	0 432 133 766	



										
<b>25.250 DF</b>	6,9	180	D 0836 LF05 <V4000, Euro 3>		09.02-07.05		6	<b>0 432 133 766</b>		
							6	<b>0 432 133 797<sup>1</sup></b>		
<b>25.280 DF</b>	6,9	206	D 0836 LF03 <V4000, Euro 3>		09.02-07.05		6	<b>0 432 133 766</b>		
<b>220B F, FA, F, FL</b>	6,9	162	D 0836 LF04 <V4000, Euro 3>		09.00-08.02		6	<b>0 432 133 765</b>		
							6	<b>0 432 133 799<sup>1</sup></b>		
<b>250B DF, F, FA</b>	6,9	180	D 0836 LF05 <V4000, Euro 3>		07.01-08.02		6	<b>0 432 133 766</b>		
							6	<b>0 432 133 797<sup>1</sup></b>		
F, FA, F, FL	6,9	180	D 0836 LFL05 <V3900, Euro 3>		06.01-02.02		6	<b>0 432 133 797<sup>1</sup></b>		
					06.01-08.02		6	<b>0 432 133 766</b>		
					06.01-09.02		6	<b>0 432 133 766</b>		
<b>280B DF</b>	6,9	206	D 0836 LF03 <V4000, Euro 3>		07.01-02.02		6	<b>0 432 133 797<sup>1</sup></b>		
					07.01-09.02		6	<b>0 432 133 766</b>		
DF, F, FA, F, FL	6,9	206	D 0836 LF01 <V4000, Euro 2>		08.00-09.01		6	<b>0 432 133 766</b>		
							6	<b>0 432 133 797<sup>1</sup></b>		
F, FA, F, FL	6,9	206	D 0836 LFL03 <V3900, Euro 3>		07.01-02.02		6	<b>0 432 133 797<sup>1</sup></b>		
					07.01-08.02		6	<b>0 432 133 766</b>		
<b>M2000 LE</b>										
<b>LE 232 FOC</b>	6,9	162	D 0826 LFL10 <V2300, Euro 2>		08.00→		6	<b>0 432 131 820</b>	<b>0 986 430 257</b>	
<b>LE 282 FOC</b>	6,9	206	D 0836 LF01 <V4000, Euro 2>		09.00-02.02		6	<b>0 432 133 797<sup>1</sup></b>		
					09.00→		6	<b>0 432 133 766</b>		
<b>M2000L</b>										
<b>26.225 DLK</b>	6,9	119	D 0836 LFL02 <V3900, Euro 3>		01.99-02.02		6	<b>0 432 133 799<sup>1</sup></b>		
					01.99-06.02		6	<b>0 432 133 765</b>		
<b>26.255 DLK</b>	6,9	180	D 0836 LFL05 <V3900, Euro 3>		01.99-02.02		6	<b>0 432 133 797<sup>1</sup></b>		
					01.99-06.02		6	<b>0 432 133 766</b>		
<b>26.284 DL</b>	6,9	206	D 0836 LFL01 <V3900, Euro 2>		01.99-09.01		6	<b>0 432 133 766</b>		
							6	<b>0 432 133 797<sup>1</sup></b>		
<b>26.285 DLK, DL-TM</b>	6,9	206	D 0836 LFL03 <V3900, Euro 3>		01.99-02.02		6	<b>0 432 133 797<sup>1</sup></b>		
					01.99-12.02		6	<b>0 432 133 766</b>		
<b>ND-Serie</b>										
<b>ND 222 F [A14]</b>	6,9	162	D 0826 LUH12 <Euro 2>		06.97-09.01		6	<b>0 432 133 842<sup>1</sup></b>		
							6	<b>0 432 133 855</b>	<b>0 986 430 313</b>	
<b>NG-Serie</b>										
<b>NG 262 [A11]</b>	6,9	191	D 0826 LUH13 <V0300, Euro 2>		06.97-07.98		6	<b>0 432 133 840</b>		
							6	<b>0 432 133 841<sup>1</sup></b>		
	10,0	191	D 2865 LUH09 <V1400, Euro 2>		06.97-07.98		5	<b>0 432 131 633</b>		
	12,0	191	D 2866 LUH22 <Euro 2>		07.98-11.99		6	<b>0 432 131 631<sup>1</sup></b>		
							6	<b>0 432 131 633</b>		
<b>NG 263 F [A24]</b>	12,0	191	D 2866 LUH22 <Euro 2>		07.98-12.01		6	<b>0 432 131 631<sup>1</sup></b>		
							6	<b>0 432 131 633</b>		
			D 2866 LUH23 <Euro 3>		01.01-09.06		6	<b>0 432 191 417<sup>1</sup></b>		
							6	<b>0 432 191 419</b>		
<b>NG 312 [A11]</b>	10,0	228	D 2865 LUH07 <V1400, Euro 2>		09.95-07.98		5	<b>0 432 131 733<sup>1</sup></b>		
							5	<b>0 432 131 760</b>	<b>0 986 430 451</b>	
	12,0	228	D 2866 LUH26 <Euro 2>		07.98-11.99		6	<b>0 432 131 631<sup>1</sup></b>		
							6	<b>0 432 131 633</b>		
<b>NG 313 F [A24]</b>	12,0	228	D 2866 LUH24 <Euro 3>		01.01-09.06		6	<b>0 432 191 417<sup>1</sup></b>		
							6	<b>0 432 191 419</b>		
			D 2866 LUH26 <Euro 2>		07.98-12.01		6	<b>0 432 131 631<sup>1</sup></b>		
							6	<b>0 432 131 633</b>		
<b>NG 363 F [A24]</b>	12,0	265	D 2866 LUH25 <Euro 3>		01.01-09.06		6	<b>0 432 191 417<sup>1</sup></b>		
							6	<b>0 432 191 419</b>		
<b>NL-Serie</b>										
<b>NL 222 [A10]</b>	6,9	162	D 0826 LUH12 <Euro 2>		11.95-11.99		6	<b>0 432 133 842<sup>1</sup></b>		
							6	<b>0 432 133 855</b>	<b>0 986 430 313</b>	
F [898]	6,9	162	D 0826 LUH12 <Euro 2>		02.96-09.01		6	<b>0 432 133 842<sup>1</sup></b>		
							6	<b>0 432 133 855</b>	<b>0 986 430 313</b>	
<b>NL 223 F [A22]</b>	6,9	162	D 0826 LUH12 <Euro 2>		02.96-09.01		6	<b>0 432 133 842<sup>1</sup></b>		
							6	<b>0 432 133 855</b>	<b>0 986 430 313</b>	
			D 0836 LUH02 <V4600, Euro 3>		01.01-09.06		6	<b>0 432 133 798</b>		
<b>NL 262 [A10]</b>	6,9	191	D 0826 LUH13 <V0300, Euro 2>		02.96-11.99		6	<b>0 432 133 840</b>		
							6	<b>0 432 133 841<sup>1</sup></b>		
	10,0	191	D 2865 LUH09 <V1400, Euro 2>		06.97-07.98		5	<b>0 432 131 633</b>		





◀ MAN

<b>NL 262</b> [A10]	12,0	191	D 2866 LUH22 <Euro 2>	07.98-11.99	6	<b>0 432 131 631</b> <sup>1</sup>
					6	<b>0 432 131 633</b>
F [898]	6,9	191	D 0826 LUH13 <V0300, Euro 2>	02.96-09.01	6	<b>0 432 133 840</b>
					6	<b>0 432 133 841</b> <sup>1</sup>
<b>NL 263</b> [A21]	6,9	191	D 0826 LUH13 <V0300, Euro 2>	07.98-09.01	6	<b>0 432 133 840</b>
					6	<b>0 432 133 841</b> <sup>1</sup>
	12,0	191	D 2866 LUH22 <Euro 2>	07.98-09.01	6	<b>0 432 131 631</b> <sup>1</sup>
					6	<b>0 432 131 633</b>
F [A22]	6,9	191	D 0826 LUH13 <V0300, Euro 2>	07.98-09.01	6	<b>0 432 133 840</b>
					6	<b>0 432 133 841</b> <sup>1</sup>
	12,0	191	D 2866 LUH22 <Euro 2>	07.98-09.01	6	<b>0 432 131 631</b> <sup>1</sup>
					6	<b>0 432 131 633</b>
			D 2866 LUH23 <Euro 3>	07.98-09.01	6	<b>0 432 191 417</b> <sup>1</sup>
				03.00-09.01	6	<b>0 432 191 419</b>
F [A30]	12,0	191	D 2866 LUH22 <Euro 2>	11.99-09.01	6	<b>0 432 131 631</b> <sup>1</sup>
					6	<b>0 432 131 633</b>
			D 2866 LUH23 <Euro 3>	01.01-09.02	6	<b>0 432 191 417</b> <sup>1</sup>
					6	<b>0 432 191 419</b>
<b>NL 283 F</b> [A22]	6,9	206	D 0836 LUH01 <V4600, Euro 3>	01.01-09.06	6	<b>0 432 133 766</b>
<b>NL 312</b> [A10]	10,0	228	D 2865 LUH07 <V1400, Euro 2>	11.95-07.98	5	<b>0 432 131 733</b> <sup>1</sup>
					5	<b>0 432 131 760 0 986 430 451</b>
F [898]	10,0	228	D 2865 LUH07 <V1400, Euro 2>	02.96-09.01	5	<b>0 432 131 733</b> <sup>1</sup>
					5	<b>0 432 131 760 0 986 430 451</b>
<b>NL 313</b> [A21]	12,0	228	D 2866 LUH26 <Euro 2>	07.98-12.01	6	<b>0 432 131 631</b> <sup>1</sup>
					6	<b>0 432 131 633</b>
F [A22]	12,0	228	D 2866 LUH24 <Euro 3>	01.01-09.06	6	<b>0 432 191 417</b> <sup>1</sup>
					6	<b>0 432 191 419</b>
			D 2866 LUH26 <Euro 2>	07.98-12.01	6	<b>0 432 131 631</b> <sup>1</sup>
					6	<b>0 432 131 633</b>
F [A30]	12,0	228	D 2866 LUH24 <Euro 3>	01.01-03.06	6	<b>0 432 191 417</b> <sup>1</sup>
					6	<b>0 432 191 419</b>
			D 2866 LUH26 <Euro 2>	11.99-09.02	6	<b>0 432 131 631</b> <sup>1</sup>
					6	<b>0 432 131 633</b>
<b>NL 353 F</b> [A30]	12,0	258	D 2866 LUH21 <V3200, Euro 2>	11.99-09.01	6	<b>0 432 131 631</b> <sup>1</sup>
					6	<b>0 432 131 633</b>
<b>NL 363 F</b> [A30]	12,0	265	D 2866 LUH25 <Euro 3>	01.01-03.06	6	<b>0 432 191 417</b> <sup>1</sup>
					6	<b>0 432 191 419</b>
<b>NM-Serie</b>						
<b>NM 222 F</b> [A35]	6,9	162	D 0826 LUH12 <Euro 2>	06.97-09.01	6	<b>0 432 133 842</b> <sup>1</sup>
					6	<b>0 432 133 855 0 986 430 313</b>
<b>NM 223 F</b> [A35]	6,9	162	D 0836 LOH03 <V4900, Euro 3>	01.00-05.01	6	<b>0 432 133 799</b> <sup>1</sup>
				01.00-09.06	6	<b>0 432 133 765</b>
<b>NM 283 F</b> [A35]	6,9	206	D 0836 LOH02 <V4900, Euro 3>	10.01-09.06	6	<b>0 432 133 766</b>
<b>11.222</b> [469]	6,9	162	D 0826 LOH15 <V2900,>	02.96-07.98	6	<b>0 432 133 855 0 986 430 313</b>
<b>11.223</b> [469]	6,9	162	D 0826 LOH15 <V2900,>	07.98-09.01	6	<b>0 432 133 855 0 986 430 313</b>
<b>RH</b>						
<b>352</b> [A13]	12,0	257	D 2866 LOH26 <V1500, Euro 2>	07.98-09.01	6	<b>0 432 131 631</b> <sup>1</sup>
					6	<b>0 432 131 633</b>
<b>402</b> [A13]	12,0	294	D 2866 LOH23 <Euro 2>	07.98-09.01	6	<b>0 432 131 734</b> <sup>1</sup>
					6	<b>0 432 131 788 0 986 430 312</b>
<b>403 F</b> [A33]	12,0	294	D 2866 LOH23 <Euro 2>	06.99-09.01	6	<b>0 432 131 734</b> <sup>1</sup>
					6	<b>0 432 131 788 0 986 430 312</b>
<b>422</b> [A13]	12,0	309	D 2866 LOH20 <V1500, Euro 1>	01.96-09.01	6	<b>0 432 131 831 0 986 430 228</b>
<b>RN</b>						
<b>313</b> [A02]	12,0	228	D 2866 LUH20 <Euro 2>	09.96-03.98	6	<b>0 432 131 633</b>
<b>353</b> [A02]	12,0	257	D 2866 LUH21 <V3200, Euro 2>	06.97-03.98	6	<b>0 432 131 631</b> <sup>1</sup>
					6	<b>0 432 131 633</b>
<b>SG</b>						
<b>263 F</b> [A90]	12,0	191	D 2866 LUH23 <Euro 3>	06.04-09.06	6	<b>0 432 191 417</b> <sup>1</sup>
					6	<b>0 432 191 419</b>
<b>313 F</b> [A90]	12,0	228	D 2866 LUH24 <Euro 3>	06.04-09.06	6	<b>0 432 191 417</b> <sup>1</sup>
					6	<b>0 432 191 419</b>





<b>SL</b>						
223 F [A89]	6,9	162	D 0836 LOH03 <Euro 3>	06.04-09.06	6	<b>0 432 133 765</b>
283 F [A89]	6,9	206	D 0836 LOH01 <Euro 2>; D 0836 LOH02 <Euro 3>	02.04-09.06	6	<b>0 432 133 766</b>
<b>SÜ</b>						
223 [A72]	6,9	162	D 0826 LOH19 <V2900, Euro 2>	11.99-09.01	6	<b>0 432 131 820 0 986 430 257</b>
F [A91]	6,9	162	D 0836 LOH03 <Euro 3>	06.04-09.06	6	<b>0 432 133 765</b>
263 [A72]	6,9	191	D 0826 LOH18 <V2900, Euro 2>	11.99-09.01	6	<b>0 432 133 840</b>
					6	<b>0 432 133 841<sup>1</sup></b>
283 [A72]	6,9	206	D 0836 LOH01 <Euro 2>	04.00-09.01	6	<b>0 432 133 766</b>
F [A91]	6,9	206	D 0836 LOH02 <Euro 3>	06.04-09.06	6	<b>0 432 133 766</b>
313 [A72]	12,0	228	D 2866 LUH26 <Euro 2>	11.99-06.01	6	<b>0 432 131 631<sup>1</sup></b>
					6	<b>0 432 131 633</b>
F [A91]	12,0	228	D 2866 LUH24 <Euro 3>	06.04-09.06	6	<b>0 432 191 417<sup>1</sup></b>
					6	<b>0 432 191 419</b>
363 F [A91]	12,0	265	D 2866 LUH25 <Euro 3>	06.04-09.06	6	<b>0 432 191 417<sup>1</sup></b>
					6	<b>0 432 191 419</b>
383 F [A91]	12,0	265	D 2866 LUH25 <Euro 3>	06.04-09.06	6	<b>0 432 191 417<sup>1</sup></b>
					6	<b>0 432 191 419</b>
<b>TGA</b>						
18.310 F, FA, FC, FK, FL	12,0	228	D 2866 LF26 <V4200, Euro 3>	09.02-12.05	6	<b>0 432 191 417<sup>1</sup></b>
					6	<b>0 432 191 419</b>
18.360 F, FA, FC, FK, FL	12,0	265	D 2866 LF27 <V4200, Euro 3>	09.02-12.05	6	<b>0 432 191 417<sup>1</sup></b>
					6	<b>0 432 191 419</b>
18.410 F, FA, FC, FK, FL	12,0	301	D 2866 LF28 <V4200, Euro 3>	09.02-12.05	6	<b>0 432 191 417<sup>1</sup></b>
					6	<b>0 432 191 419</b>
18.460 F, FL	12,8	338	D 2876 LF04 <V4300, Euro 3>	09.02-05.04	6	<b>0 432 191 414<sup>1</sup></b>
					6	<b>0 432 191 416</b>
18.510 FC, FK, FL	12,8	375	D 2876 LF05 <V4300, Euro 3>	09.02-06.03	6	<b>0 432 191 414<sup>1</sup></b>
					6	<b>0 432 191 416</b>
24.360 DF	12,0	265	D 2866 LF27 <V4200, Euro 3>	11.02-05.04	6	<b>0 432 191 417<sup>1</sup></b>
					6	<b>0 432 191 419</b>
24.410 DF	12,0	301	D 2866 LF28 <V4200, Euro 3>	11.02-05.04	6	<b>0 432 191 417<sup>1</sup></b>
					6	<b>0 432 191 419</b>
24.460 DF	12,8	338	D 2876 LF04 <V4300, Euro 3>	11.02-05.04	6	<b>0 432 191 414<sup>1</sup></b>
					6	<b>0 432 191 416</b>
24.510 DF	12,8	375	D 2876 LF05 <V4300, Euro 3>	11.02-06.03	6	<b>0 432 191 414<sup>1</sup></b>
					6	<b>0 432 191 416</b>
26.310 DA, FD, FN, FP, FV	12,0	228	D 2866 LF26 <V4200, Euro 3>	09.02-12.05	6	<b>0 432 191 417<sup>1</sup></b>
					6	<b>0 432 191 419</b>
26.360 DA, FD, FN, FP, FV	12,0	265	D 2866 LF27 <V4200, Euro 3>	09.02-12.05	6	<b>0 432 191 417<sup>1</sup></b>
					6	<b>0 432 191 419</b>
26.410 DA, FD, FN, FP, FV	12,0	301	D 2866 LF28 <V4200, Euro 3>	09.02-12.05	6	<b>0 432 191 417<sup>1</sup></b>
					6	<b>0 432 191 419</b>
26.460 FD, FN, FP, FV	12,8	338	D 2876 LF04 <V4300, Euro 3>	09.02-06.05	6	<b>0 432 191 414<sup>1</sup></b>
					6	<b>0 432 191 416</b>
26.510 FD, FN, FP, FV	12,8	375	D 2876 LF05 <V4300, Euro 3>	09.02-06.03	6	<b>0 432 191 414<sup>1</sup></b>
					6	<b>0 432 191 416</b>
28.310 DF	12,0	228	D 2866 LF26 <V4200, Euro 3>	09.02-06.05	6	<b>0 432 191 417<sup>1</sup></b>
					6	<b>0 432 191 419</b>
28.360 DF, L, FL	12,0	265	D 2866 LF27 <V4200, Euro 3>	09.02-06.05	6	<b>0 432 191 417<sup>1</sup></b>
					6	<b>0 432 191 419</b>
28.410 DF	12,0	301	D 2866 LF28 <V4200, Euro 3>	09.02-06.05	6	<b>0 432 191 417<sup>1</sup></b>
					6	<b>0 432 191 419</b>
28.460 DF	12,8	338	D 2876 LF04 <V4300, Euro 3>	09.02-05.04	6	<b>0 432 191 414<sup>1</sup></b>
					6	<b>0 432 191 416</b>
28.510 DF	12,8	375	D 2876 LF05 <V4300, Euro 3>	09.02-06.03	6	<b>0 432 191 414<sup>1</sup></b>
					6	<b>0 432 191 416</b>
32.310 FFD	12,0	228	D 2866 LF26 <V4200, Euro 3>	06.02-05.04	6	<b>0 432 191 417<sup>1</sup></b>
					6	<b>0 432 191 419</b>
32.360 DA, FFD, VF	12,0	265	D 2866 LF27 <V4200, Euro 3>	09.02-01.06	6	<b>0 432 191 417<sup>1</sup></b>
					6	<b>0 432 191 419</b>





◀ MAN

<b>32.410</b> DA, FFD, VF	12,0	301	D 2866 LF28 <V4200, Euro 3>	09.02-01.06	6	<b>0 432 191 417</b> <sup>1</sup>
					6	<b>0 432 191 419</b>
<b>32.460</b> FFD, VF	12,8	338	D 2876 LF04 <V4300, Euro 3>	09.02-01.06	6	<b>0 432 191 414</b> <sup>1</sup>
					6	<b>0 432 191 416</b>
<b>33.360</b> DF, FD	12,0	265	D 2866 LF27 <V4200, Euro 3>	06.01-02.08	6	<b>0 432 191 417</b> <sup>1</sup>
					6	<b>0 432 191 419</b>
<b>33.410</b> DA, DF	12,0	301	D 2866 LF28 <V4200, Euro 3>	06.01-12.05	6	<b>0 432 191 417</b> <sup>1</sup>
					6	<b>0 432 191 419</b>
<b>33.460</b> DF, FD-WW	12,8	338	D 2876 LF04 <V4300, Euro 3>; D 2876 LF07 <V4300, Euro 2>	06.01-06.07	6	<b>0 432 191 414</b> <sup>1</sup>
					6	<b>0 432 191 416</b>
<b>33.510</b> DF	12,8	375	D 2876 LF05 <V4300, Euro 3>	06.01-06.03	6	<b>0 432 191 414</b> <sup>1</sup>
					6	<b>0 432 191 416</b>
<b>35.310</b> FFD	12,0	228	D 2866 LF26 <V4200, Euro 3>	06.03-06.05	6	<b>0 432 191 417</b> <sup>1</sup>
					6	<b>0 432 191 419</b>
<b>35.360</b> FFDC, FFDK	12,0	265	D 2866 LF27 <V4200, Euro 3>	06.03-09.06	6	<b>0 432 191 417</b> <sup>1</sup>
					6	<b>0 432 191 419</b>
<b>35.410</b> FFD	12,0	301	D 2866 LF28 <V4200, Euro 3>	06.03-12.05	6	<b>0 432 191 417</b> <sup>1</sup>
					6	<b>0 432 191 419</b>
<b>35.460</b> FFD, VF	12,8	338	D 2876 LF04 <V4300, Euro 3>	06.03-06.05	6	<b>0 432 191 414</b> <sup>1</sup>
					6	<b>0 432 191 416</b>
<b>37.360</b> VF	12,0	265	D 2866 LF27 <V4200, Euro 3>	05.04-12.05	6	<b>0 432 191 417</b> <sup>1</sup>
					6	<b>0 432 191 419</b>
<b>37.410</b> VF	12,0	301	D 2866 LF28 <V4200, Euro 3>	05.04-12.05	6	<b>0 432 191 417</b> <sup>1</sup>
					6	<b>0 432 191 419</b>
<b>37.460</b> VF	12,8	338	D 2876 LF04 <V4300, Euro 3>	05.04-06.05	6	<b>0 432 191 414</b> <sup>1</sup>
					6	<b>0 432 191 416</b>
<b>40.410</b> , FD	12,0	301	D 2866 LF28 <V4200, Euro 3>	06.04-12.05	6	<b>0 432 191 417</b> <sup>1</sup>
					6	<b>0 432 191 419</b>
<b>41.360</b> FFD	12,0	265	D 2866 LF27 <V4200, Euro 3>	09.02-12.05	6	<b>0 432 191 417</b> <sup>1</sup>
					6	<b>0 432 191 419</b>
<b>41.410</b> FFD	12,0	301	D 2866 LF28 <V4200, Euro 3>	09.02-12.05	6	<b>0 432 191 417</b> <sup>1</sup>
					6	<b>0 432 191 419</b>
<b>41.460</b> F-, FL-WW, FV	12,8	338	D 2876 LF04 <V4300, Euro 3>; D 2876 LF07 <V4300, Euro 2>	09.02-05.10	6	<b>0 432 191 414</b> <sup>1</sup>
					6	<b>0 432 191 416</b>
<b>TGA 18t</b>						
<b>310</b> F, FL	12,0	228	D 2866 LF26 <V4200, Euro 3>	03.99-08.02	6	<b>0 432 191 417</b> <sup>1</sup>
			D 2866 LF36 <V4200, Euro 2>	03.99-09.01	6	<b>0 432 191 414</b> <sup>1</sup>
				03.00-09.01	6	<b>0 432 191 416</b>
<b>360</b> F, FL	12,0	265	D 2866 LF27 <V4200, Euro 3>	03.99-08.02	6	<b>0 432 191 417</b> <sup>1</sup>
			D 2866 LF37 <V4200, Euro 2>	03.99-09.01	6	<b>0 432 191 414</b> <sup>1</sup>
					6	<b>0 432 191 416</b>
<b>410</b> F, FL	12,0	301	D 2866 LF28 <V4200, Euro 3>	03.99-08.02	6	<b>0 432 191 417</b> <sup>1</sup>
			D 2866 LF32 <V4200, Euro 2>	03.99-08.02	6	<b>0 432 191 416</b>
				04.00-08.02	6	<b>0 432 191 414</b> <sup>1</sup>
<b>460</b> F, FL, F-, FL-WW	12,8	338	D 2876 LF04 <V4300, Euro 3>; D 2876 LF07 <V4300, Euro 2>	03.99-04.07	6	<b>0 432 191 414</b> <sup>1</sup>
					6	<b>0 432 191 416</b>
<b>510</b> F, FL	12,8	375	D 2876 LF05 <V4300, Euro 3>	04.00-08.02	6	<b>0 432 191 414</b> <sup>1</sup>
					6	<b>0 432 191 416</b>
<b>TGA 26t</b>						
<b>310</b> DF	12,0	228	D 2866 LF26 <V4200, Euro 3>	03.99-08.02	6	<b>0 432 191 417</b> <sup>1</sup>
			D 2866 LF36 <V4200, Euro 2>	03.99-09.01	6	<b>0 432 191 414</b> <sup>1</sup>
				03.00-09.01	6	<b>0 432 191 416</b>
<b>360</b> D	12,0	265	D 2866 LF37 <V4200, Euro 2>	03.99-09.01	6	<b>0 432 191 414</b> <sup>1</sup>
					6	<b>0 432 191 416</b>
D, DF	12,0	265	D 2866 LF27 <V4200, Euro 3>	03.99-08.02	6	<b>0 432 191 417</b> <sup>1</sup>
					6	<b>0 432 191 419</b>
<b>410</b> D, DF	12,0	301	D 2866 LF28 <V4200, Euro 3>	03.99-08.02	6	<b>0 432 191 417</b> <sup>1</sup>
					6	<b>0 432 191 419</b>





<b>410 DF</b>	12,0	301	D 2866 LF32 <V4200, Euro 2>	03.99-09.01		6	<b>0 432 191 416</b>
				04.00-09.01		6	<b>0 432 191 414<sup>1</sup></b>
<b>460 D, DF</b>	12,8	338	D 2876 LF04 <V4300, Euro 3>; D 2876 LF07 <V4300, Euro 2>	03.99-08.02		6	<b>0 432 191 414<sup>1</sup></b>
						6	<b>0 432 191 416</b>
<b>510 DF</b>	12,8	375	D 2876 LF05 <V4300, Euro 3>	03.99-08.02		6	<b>0 432 191 414<sup>1</sup></b>
						6	<b>0 432 191 416</b>
<b>ÜL</b>							
<b>313 [A01,A04]</b>	12,0	228	D 2866 LUH20 <Euro 2>	09.96-09.01		6	<b>0 432 131 633</b>
			D 2866 LUH24 <Euro 3>	05.99-09.06		6	<b>0 432 191 417<sup>1</sup></b>
				03.00-09.06		6	<b>0 432 191 419</b>
<b>353 [A01,A04]</b>	12,0	257	D 2866 LUH21 <V3200, Euro 2>	06.97-12.01		6	<b>0 432 131 631<sup>1</sup></b>
						6	<b>0 432 131 633</b>
<b>363 [A01,A04]</b>	12,0	265	D 2866 LUH25 <Euro 3>	01.01-09.06		6	<b>0 432 191 417<sup>1</sup></b>
						6	<b>0 432 191 419</b>

**MAZ MINSK**

**Serie 100**

<b>105</b>	6,4	205	OM 906 LA <Euro 3>				
			Komp.Nr. 505047/ 06	01.02→	TNK	6	<b>0 432 191 304</b>
			Komp.Nr. 505047/21	01.02→	TNK	6	<b>0 432 191 301</b>
			Komp.Nr. 505074/12	01.02→	TNK	6	<b>0 432 193 481</b>
			Komp.Nr. 505074/15				
<b>107</b>	6,4	205	OM 906 LA <Euro 3>				
			Komp.Nr. 505047/ 06	01.02→	TNK	6	<b>0 432 191 304</b>
			Komp.Nr. 505047/21	01.02→	TNK	6	<b>0 432 191 301</b>
			Komp.Nr. 505074/12	01.02→	TNK	6	<b>0 432 193 481</b>
			Komp.Nr. 505074/15				

**Serie 200**

<b>203</b>	6,4	170	OM 906 LA <Euro 3>				
			Komp.Nr. 505047/12	01.02→	TNK	6	<b>0 432 191 307</b>
			Komp.Nr. 505047/15				
		170/205	OM 906 LA <Euro 3>				
			Komp.Nr. 505047/ 06	01.02→	TNK	6	<b>0 432 191 304</b>
		205	OM 906 LA <Euro 3>				
			Komp.Nr. 505047/21	01.02→	TNK	6	<b>0 432 191 301</b>
			Komp.Nr. 505074/12	01.02→	TNK	6	<b>0 432 193 481</b>
			Komp.Nr. 505074/15				



**MERCEDES-BENZ**

**Actros**

<b>1831 , L [SKN]</b>	12,0	230	OM 541.920 <(501)LA Euro2>				
			Komp.Nr. 505126/01/02	09.96-09.03	TNK	6	<b>0 432 191 589</b>
			Komp.Nr. 505137/01/02				
			Komp.Nr. 505137/07	09.96-09.03	TNK	6	<b>0 432 191 437</b>
			Komp.Nr. 505137/08				
			Komp.Nr. 505137/18/19	09.96-09.03	TNK	6	<b>0 432 193 459</b>
			Komp.Nr. 505137/31	09.96-09.03	TNK	6	<b>0 432 193 459</b>
<b>AK [SKN]</b>	11,9	230	OM 541.941 <(501)LA Euro3>				
			Komp.Nr. 505126/ 01	04.97-09.03	TNK	6	<b>0 432 191 589</b>
			Komp.Nr. 505137/03	04.97-09.03	TNK	6	<b>0 432 191 446</b>
			Komp.Nr. 505137/05	04.97-09.03	TNK	6	<b>0 432 191 459</b>
			Komp.Nr. 505137/10	04.97-09.03	TNK	6	<b>0 432 191 384</b>
			Komp.Nr. 505137/25	04.97-09.03	TNK	6	<b>0 432 191 258</b>
			Komp.Nr. 505137/27	04.97-09.03	TNK	6	<b>0 432 191 348</b>





◀ MERCEDES-BENZ

<b>1831 AK [SKN]</b>	12,0	230	OM 541.926 <(501)LA Euro2>						
			Komp.Nr. 505126/01/02	04.97-09.03	TNK	6	<b>0 432 191 589</b>		
			Komp.Nr. 505137/01/02						
			Komp.Nr. 505137/07	04.97-09.03	TNK	6	<b>0 432 191 437</b>		
			Komp.Nr. 505137/08						
			Komp.Nr. 505137/18/19	04.97-09.03	TNK	6	<b>0 432 193 459</b>		
			Komp.Nr. 505137/31	04.97-09.03	TNK	6	<b>0 432 193 459</b>		
<b>L [SKN]</b>	12,0	230	OM 541.940 <501 LA Euro3>						
			Komp.Nr. 505126/ 01	09.96-09.03	TNK	6	<b>0 432 191 589</b>		
			Komp.Nr. 505137/03	09.96-09.03	TNK	6	<b>0 432 191 446</b>		
			Komp.Nr. 505137/05	09.96-09.03	TNK	6	<b>0 432 191 459</b>		
			Komp.Nr. 505137/10	09.96-09.03	TNK	6	<b>0 432 191 384</b>		
			Komp.Nr. 505137/25	09.96-09.03	TNK	6	<b>0 432 191 258</b>		
			Komp.Nr. 505137/27	09.96-09.03	TNK	6	<b>0 432 191 348</b>		
<b>1835 [SKN]</b>	12,0	260	OM 541.942 <501 LA Euro3>						
			Komp.Nr. 505126/ 01	09.96-09.03	TNK	6	<b>0 432 191 589</b>		
			Komp.Nr. 505137/03	09.96-09.03	TNK	6	<b>0 432 191 446</b>		
			Komp.Nr. 505137/05	09.96-09.03	TNK	6	<b>0 432 191 459</b>		
			Komp.Nr. 505137/10	09.96-09.03	TNK	6	<b>0 432 191 384</b>		
			Komp.Nr. 505137/25	09.96-09.03	TNK	6	<b>0 432 191 258</b>		
			Komp.Nr. 505137/27	09.96-09.03	TNK	6	<b>0 432 191 348</b>		
<b>, L [SKN]</b>	12,0	260	OM 541.922 <(501)LA Euro2>						
			Komp.Nr. 505126/01/02	09.96-09.03	TNK	6	<b>0 432 191 589</b>		
			Komp.Nr. 505137/01/02						
			Komp.Nr. 505137/07	09.96-09.03	TNK	6	<b>0 432 191 437</b>		
			Komp.Nr. 505137/08						
			Komp.Nr. 505137/18/19	09.96-09.03	TNK	6	<b>0 432 193 459</b>		
			Komp.Nr. 505137/31	09.96-09.03	TNK	6	<b>0 432 193 459</b>		
<b>AK [SKN]</b>	12,0	260	OM 541.927 <501 LA Euro3>						
			Komp.Nr. 505126/01/02	04.97-09.03	TNK	6	<b>0 432 191 589</b>		
			Komp.Nr. 505137/01/02						
			Komp.Nr. 505137/07	04.97-09.03	TNK	6	<b>0 432 191 437</b>		
			Komp.Nr. 505137/08						
			Komp.Nr. 505137/18/19	04.97-09.03	TNK	6	<b>0 432 193 459</b>		
			Komp.Nr. 505137/31	04.97-09.03	TNK	6	<b>0 432 193 459</b>		
			OM 541.943 <501 LA Euro3>						
			Komp.Nr. 505126/ 01	09.96-09.03	TNK	6	<b>0 432 191 589</b>		
			Komp.Nr. 505137/03	09.96-09.03	TNK	6	<b>0 432 191 446</b>		
			Komp.Nr. 505137/05	09.96-09.03	TNK	6	<b>0 432 191 459</b>		
			Komp.Nr. 505137/10	09.96-09.03	TNK	6	<b>0 432 191 384</b>		
			Komp.Nr. 505137/25	09.96-09.03	TNK	6	<b>0 432 191 258</b>		
			Komp.Nr. 505137/27	09.96-09.03	TNK	6	<b>0 432 191 348</b>		
<b>1840 [SKN]</b>	12,0	290	OM 541.944 <501 LA Euro3>						
			Komp.Nr. 505126/ 01	09.96-09.03	TNK	6	<b>0 432 191 589</b>		
			Komp.Nr. 505137/03	09.96-09.03	TNK	6	<b>0 432 191 446</b>		
			Komp.Nr. 505137/05	09.96-09.03	TNK	6	<b>0 432 191 459</b>		
			Komp.Nr. 505137/10	09.96-09.03	TNK	6	<b>0 432 191 384</b>		
			Komp.Nr. 505137/25	09.96-09.03	TNK	6	<b>0 432 191 258</b>		
			Komp.Nr. 505137/27	09.96-09.03	TNK	6	<b>0 432 191 348</b>		
<b>, L [SKN]</b>	12,0	290	OM 541.923 <(501)LA Euro2>						
			Komp.Nr. 505126/01/02	09.96-09.03	TNK	6	<b>0 432 191 589</b>		
			Komp.Nr. 505137/01/02						
			Komp.Nr. 505137/07	09.96-09.03	TNK	6	<b>0 432 191 437</b>		
			Komp.Nr. 505137/08						
			Komp.Nr. 505137/18/19	09.96-09.03	TNK	6	<b>0 432 193 459</b>		
			Komp.Nr. 505137/31	09.96-09.03	TNK	6	<b>0 432 193 459</b>		
<b>AK [SKN]</b>	11,9	290	OM 541.945 <(501)LA Euro3>						
			Komp.Nr. 505126/ 01	09.96-09.03	TNK	6	<b>0 432 191 589</b>		
			Komp.Nr. 505137/03	09.96-09.03	TNK	6	<b>0 432 191 446</b>		
			Komp.Nr. 505137/05	09.96-09.03	TNK	6	<b>0 432 191 459</b>		
			Komp.Nr. 505137/10	09.96-09.03	TNK	6	<b>0 432 191 384</b>		
			Komp.Nr. 505137/25	09.96-09.03	TNK	6	<b>0 432 191 258</b>		
			Komp.Nr. 505137/27	09.96-09.03	TNK	6	<b>0 432 191 348</b>		







<b>1840 AK</b> [SKN]	12,0	290	OM 541.924 <(501)LA Euro 2>					
			Komp.Nr. 505126/01/02	04.97-09.03	TNK	6	<b>0 432 191 589</b>	
			Komp.Nr. 505137/01/02					
			Komp.Nr. 505137/07	04.97-09.03	TNK	6	<b>0 432 191 437</b>	
			Komp.Nr. 505137/08					
<b>1843</b> [SKN]	12,0	315	OM 541.946 <501 LA Euro3>					
			Komp.Nr. 505126/01	09.96-09.03	TNK	6	<b>0 432 191 589</b>	
			Komp.Nr. 505137/03	09.96-09.03	TNK	6	<b>0 432 191 446</b>	
			Komp.Nr. 505137/05	09.96-09.03	TNK	6	<b>0 432 191 459</b>	
			Komp.Nr. 505137/10	09.96-09.03	TNK	6	<b>0 432 191 384</b>	
, L [SKN]	12,0	315	OM 541.925 <(501)LA Euro2>					
			Komp.Nr. 505126/01/02	09.96-09.03	TNK	6	<b>0 432 191 589</b>	
			Komp.Nr. 505137/01/02					
			Komp.Nr. 505137/07	09.96-09.03	TNK	6	<b>0 432 191 437</b>	
			Komp.Nr. 505137/08					
AK [SKN]	12,0	315	OM 541.921 <(501)LA Euro2>					
			Komp.Nr. 505126/01/02	04.97-09.03	TNK	6	<b>0 432 191 589</b>	
			Komp.Nr. 505137/01/02					
			Komp.Nr. 505137/07	04.97-09.03	TNK	6	<b>0 432 191 437</b>	
			Komp.Nr. 505137/08					
<b>1848</b> [SKN]	15,9	350	OM 542.940 <502 LA Euro3>					
			Komp.Nr. 505126/02	09.96-09.03	TNK	8	<b>0 432 191 589</b>	
			Komp.Nr. 505137/28	09.96-09.03		8	<b>0 432 191 348</b>	
			Komp.Nr. 505137/04	09.96-09.03	TNK	8	<b>0 432 191 446</b>	
			Komp.Nr. 505137/06	09.96-09.03	TNK	8	<b>0 432 191 459</b>	
, L [SKN]	16,0	350	OM 542.921 <(502)LA Euro2>					
			Komp.Nr. 505126/01/02	09.96-09.03	TNK	8	<b>0 432 191 589</b>	
			Komp.Nr. 505137/01/02					
			Komp.Nr. 505137/07	09.96-09.03	TNK	8	<b>0 432 191 437</b>	
			Komp.Nr. 505137/08					
AK [SKN]	15,9	350	OM 542.941 <502 LA Euro3>					
			Komp.Nr. 505126/02	09.96-09.03	TNK	8	<b>0 432 191 589</b>	
			Komp.Nr. 505137/28	09.96-09.03		8	<b>0 432 191 348</b>	
			Komp.Nr. 505137/04	09.96-09.03	TNK	8	<b>0 432 191 446</b>	
			Komp.Nr. 505137/06	09.96-09.03	TNK	8	<b>0 432 191 459</b>	
	16,0	350	OM 542.925 <(502)LA Euro2>					
			Komp.Nr. 505126/01/02	04.97-09.03	TNK	8	<b>0 432 191 589</b>	
			Komp.Nr. 505137/01/02					
			Komp.Nr. 505137/07	04.97-09.03	TNK	8	<b>0 432 191 437</b>	
			Komp.Nr. 505137/08					
<b>1853</b> [SKN]	15,9	390	OM 542.942 <502 LA Euro3>					
			Komp.Nr. 505126/02	09.96-09.03	TNK	8	<b>0 432 191 589</b>	
			Komp.Nr. 505137/28	09.96-09.03		8	<b>0 432 191 348</b>	
			Komp.Nr. 505137/04	09.96-09.03	TNK	8	<b>0 432 191 446</b>	
			Komp.Nr. 505137/06	09.96-09.03	TNK	8	<b>0 432 191 459</b>	
			Komp.Nr. 505137/11	09.96-09.03	TNK	8	<b>0 432 191 384</b>	
			Komp.Nr. 505137/26	09.96-09.03	TNK	8	<b>0 432 191 258</b>	
			Komp.Nr. 505137/11	09.96-09.03	TNK	8	<b>0 432 191 384</b>	
			Komp.Nr. 505137/26	09.96-09.03	TNK	8	<b>0 432 191 258</b>	
			Komp.Nr. 505137/11	09.96-09.03	TNK	8	<b>0 432 191 384</b>	
			Komp.Nr. 505137/26	09.96-09.03	TNK	8	<b>0 432 191 258</b>	





◀ MERCEDES-BENZ

<b>1853</b> , L [SKN]	16,0	390	OM 542.920 <(502)LA Euro2>					
			Komp.Nr. 505126/01/02	09.96-09.03	TNK	8	<b>0 432 191 589</b>	
			Komp.Nr. 505137/01/02					
			Komp.Nr. 505137/07	09.96-09.03	TNK	8	<b>0 432 191 437</b>	
			Komp.Nr. 505137/08					
AK [SKN]	15,9	390	OM 542.943 <(502)LA Euro2>					
			Komp.Nr. 505126/ 02	09.96-09.03	TNK	8	<b>0 432 191 589</b>	
			Komp.Nr. 505137 /28	09.96-09.03		8	<b>0 432 191 348</b>	
			Komp.Nr. 505137/04	09.96-09.03	TNK	8	<b>0 432 191 446</b>	
			Komp.Nr. 505137/06	09.96-09.03	TNK	8	<b>0 432 191 459</b>	
<b>1857</b> L [SKN]	15,9	420	OM 542.944 <502 LA Euro3>					
			Komp.Nr. 505126/ 02	09.96-09.03	TNK	8	<b>0 432 191 589</b>	
			Komp.Nr. 505137 /28	09.96-09.03		8	<b>0 432 191 348</b>	
			Komp.Nr. 505137/04	09.96-09.03	TNK	8	<b>0 432 191 446</b>	
			Komp.Nr. 505137/06	09.96-09.03	TNK	8	<b>0 432 191 459</b>	
	16,0	420	OM 542.922 <(502)LA Euro2>					
			Komp.Nr. 505126/01/02	04.97-09.03	TNK	8	<b>0 432 191 589</b>	
			Komp.Nr. 505137/01/02					
			Komp.Nr. 505137/07	04.97-09.03	TNK	8	<b>0 432 191 437</b>	
			Komp.Nr. 505137/08					
<b>2031</b> [SKN]	12,0	230	OM 541.920 <(501)LA Euro2>					
			Komp.Nr. 505126/01/02	09.96-09.03	TNK	6	<b>0 432 191 589</b>	
			Komp.Nr. 505137/01/02					
			Komp.Nr. 505137/07	09.96-09.03	TNK	6	<b>0 432 191 437</b>	
			Komp.Nr. 505137/08					
			Komp.Nr. 505137/18/19	09.96-09.03	TNK	6	<b>0 432 193 459</b>	
			Komp.Nr. 505137/31	09.96-09.03	TNK	6	<b>0 432 193 459</b>	
			OM 541.940 <501 LA Euro3>					
			Komp.Nr. 505126/ 01	09.96-09.03	TNK	6	<b>0 432 191 589</b>	
			Komp.Nr. 505137/03	09.96-09.03	TNK	6	<b>0 432 191 446</b>	
			Komp.Nr. 505137/05	09.96-09.03	TNK	6	<b>0 432 191 459</b>	
			Komp.Nr. 505137/10	09.96-09.03	TNK	6	<b>0 432 191 384</b>	
			Komp.Nr. 505137/25	09.96-09.03	TNK	6	<b>0 432 191 258</b>	
			Komp.Nr. 505137/27	09.96-09.03	TNK	6	<b>0 432 191 348</b>	
			A [SKN]	12,0	230	OM 541.926 <(501)LA Euro2>		
			Komp.Nr. 505126/01/02	09.96-09.03	TNK	6	<b>0 432 191 589</b>	
			Komp.Nr. 505137/01/02					
			Komp.Nr. 505137/07	09.96-09.03	TNK	6	<b>0 432 191 437</b>	
			Komp.Nr. 505137/08					
			Komp.Nr. 505137/18/19	09.96-09.03	TNK	6	<b>0 432 193 459</b>	
AK,AS [SKN]	11,9	230	OM 541.941 <(501)LA Euro3>					
			Komp.Nr. 505126/ 01	09.96-09.03	TNK	6	<b>0 432 191 589</b>	
			Komp.Nr. 505137/03	09.96-09.03	TNK	6	<b>0 432 191 446</b>	
			Komp.Nr. 505137/05	09.96-09.03	TNK	6	<b>0 432 191 459</b>	
			Komp.Nr. 505137/10	09.96-09.03	TNK	6	<b>0 432 191 384</b>	
<b>2035</b> [SKN]	12,0	260	OM 541.927 <501 LA Euro3>					
			Komp.Nr. 505126/01/02	04.97-09.03	TNK	6	<b>0 432 191 589</b>	
			Komp.Nr. 505137/01/02					
			Komp.Nr. 505137/07	04.97-09.03	TNK	6	<b>0 432 191 437</b>	
			Komp.Nr. 505137/08					
			Komp.Nr. 505137/18/19	04.97-09.03	TNK	6	<b>0 432 193 459</b>	
			Komp.Nr. 505137/31	04.97-09.03	TNK	6	<b>0 432 193 459</b>	





<b>2035</b> [SKN]	12,0	260	OM 541.942 <501 LA Euro3>				
			Komp.Nr. 505126/ 01	04.97-09.03	TNK	6	<b>0 432 191 589</b>
			Komp.Nr. 505137/03	04.97-09.03	TNK	6	<b>0 432 191 446</b>
			Komp.Nr. 505137/05	04.97-09.03	TNK	6	<b>0 432 191 459</b>
			Komp.Nr. 505137/10	04.97-09.03	TNK	6	<b>0 432 191 384</b>
			Komp.Nr. 505137/25	04.97-09.03	TNK	6	<b>0 432 191 258</b>
<b>2040</b> [SKN]	12,0	290	OM 541.923 <(501)LA Euro2>				
			Komp.Nr. 505126/01/02	09.96-09.03	TNK	6	<b>0 432 191 589</b>
			Komp.Nr. 505137/01/02				
			Komp.Nr. 505137/07	09.96-09.03	TNK	6	<b>0 432 191 437</b>
			Komp.Nr. 505137/08				
			Komp.Nr. 505137/18/19	09.96-09.03	TNK	6	<b>0 432 193 459</b>
<b>A</b> [SKN]	12,0	290	OM 541.924 <(501)LA Euro 2>				
			Komp.Nr. 505126/01/02	09.96-09.03	TNK	6	<b>0 432 191 589</b>
			Komp.Nr. 505137/01/02				
			Komp.Nr. 505137/07	09.96-09.03	TNK	6	<b>0 432 191 437</b>
			Komp.Nr. 505137/08				
			Komp.Nr. 505137/18/19	09.96-09.03	TNK	6	<b>0 432 193 459</b>
			Komp.Nr. 505137/31	09.96-09.03	TNK	6	<b>0 432 193 459</b>
			OM 541.944 <501 LA Euro3>				
			Komp.Nr. 505126/ 01	11.97-09.03	TNK	6	<b>0 432 191 589</b>
			Komp.Nr. 505137/03	11.97-09.03	TNK	6	<b>0 432 191 446</b>
			Komp.Nr. 505137/05	11.97-09.03	TNK	6	<b>0 432 191 459</b>
			Komp.Nr. 505137/10	11.97-09.03	TNK	6	<b>0 432 191 384</b>
Komp.Nr. 505137/25	11.97-09.03	TNK	6	<b>0 432 191 258</b>			
Komp.Nr. 505137/27	11.97-09.03	TNK	6	<b>0 432 191 348</b>			
<b>AK,AS</b> [SKN]	11,9	290	OM 541.945 <(501)LA Euro3>				
			Komp.Nr. 505126/ 01	11.97-09.03	TNK	6	<b>0 432 191 589</b>
			Komp.Nr. 505137/03	11.97-09.03	TNK	6	<b>0 432 191 446</b>
			Komp.Nr. 505137/05	11.97-09.03	TNK	6	<b>0 432 191 459</b>
			Komp.Nr. 505137/10	11.97-09.03	TNK	6	<b>0 432 191 384</b>
			Komp.Nr. 505137/25	11.97-09.03	TNK	6	<b>0 432 191 258</b>
<b>2043 AS</b> [SKN]	11,9	315	OM 541.947 <(501)LA Euro3>				
			Komp.Nr. 505126/ 01	09.98-09.03	TNK	6	<b>0 432 191 589</b>
			Komp.Nr. 505137/03	09.98-09.03	TNK	6	<b>0 432 191 446</b>
			Komp.Nr. 505137/05	09.98-09.03	TNK	6	<b>0 432 191 459</b>
			Komp.Nr. 505137/10	09.98-09.03	TNK	6	<b>0 432 191 384</b>
			Komp.Nr. 505137/25	09.98-09.03	TNK	6	<b>0 432 191 258</b>
	12,0	315	OM 541.921 <(501)LA Euro2>				
			Komp.Nr. 505126/01/02	09.96-09.03	TNK	6	<b>0 432 191 589</b>
			Komp.Nr. 505137/01/02				
			Komp.Nr. 505137/07	09.96-09.03	TNK	6	<b>0 432 191 437</b>
			Komp.Nr. 505137/08				
			Komp.Nr. 505137/18/19	09.96-09.03	TNK	6	<b>0 432 193 459</b>
<b>2048 AS</b> [SKN]	15,9	350	OM 542.941 <502 LA Euro3>				
			Komp.Nr. 505126/ 02	09.96-09.03	TNK	8	<b>0 432 191 589</b>
			Komp.Nr. 505137 /28	09.96-09.03		8	<b>0 432 191 348</b>
			Komp.Nr. 505137/04	09.96-09.03	TNK	8	<b>0 432 191 446</b>
			Komp.Nr. 505137/06	09.96-09.03	TNK	8	<b>0 432 191 459</b>
			Komp.Nr. 505137/11	09.96-09.03	TNK	8	<b>0 432 191 384</b>
	16,0	350	OM 542.925 <(502)LA Euro2>				
			Komp.Nr. 505126/01/02	09.96-09.03	TNK	8	<b>0 432 191 589</b>
			Komp.Nr. 505137/01/02				
			Komp.Nr. 505137/07	09.96-09.03	TNK	8	<b>0 432 191 437</b>
			Komp.Nr. 505137/08				
			Komp.Nr. 505137/18/19	09.96-09.03	TNK	8	<b>0 432 193 459</b>
Komp.Nr. 505137/31	09.96-09.03	TNK	8	<b>0 432 193 459</b>			





◀ MERCEDES-BENZ

<b>2053</b> [SKN]	12,0	390	OM 542.920 <(501)LA Euro2>						
			Komp.Nr. 505126/01/02	09.96-09.03	TNK	8	<b>0 432 191 589</b>		
			Komp.Nr. 505137/01/02						
			Komp.Nr. 505137/07	09.96-09.03	TNK	8	<b>0 432 191 437</b>		
			Komp.Nr. 505137/08						
			Komp.Nr. 505137/18/19	09.96-09.03	TNK	8	<b>0 432 193 459</b>		
			Komp.Nr. 505137/31	09.96-09.03	TNK	8	<b>0 432 193 459</b>		
<b>2531</b> [SKN]	12,0	230	OM 541.940 <501 LA Euro3>						
			Komp.Nr. 505126/ 01	09.96-09.03	TNK	6	<b>0 432 191 589</b>		
			Komp.Nr. 505137/03	09.96-09.03	TNK	6	<b>0 432 191 446</b>		
			Komp.Nr. 505137/05	09.96-09.03	TNK	6	<b>0 432 191 459</b>		
			Komp.Nr. 505137/10	09.96-09.03	TNK	6	<b>0 432 191 384</b>		
			Komp.Nr. 505137/25	09.96-09.03	TNK	6	<b>0 432 191 258</b>		
			Komp.Nr. 505137/27	09.96-09.03	TNK	6	<b>0 432 191 348</b>		
, L [SKN]	12,0	230	OM 541.920 <(501)LA Euro2>						
			Komp.Nr. 505126/01/02	09.96-09.03	TNK	6	<b>0 432 191 589</b>		
			Komp.Nr. 505137/01/02						
			Komp.Nr. 505137/07	09.96-09.03	TNK	6	<b>0 432 191 437</b>		
			Komp.Nr. 505137/08						
			Komp.Nr. 505137/18/19	09.96-09.03	TNK	6	<b>0 432 193 459</b>		
			Komp.Nr. 505137/31	09.96-09.03	TNK	6	<b>0 432 193 459</b>		
<b>2535</b> [SKN]	12,0	260	OM 541.942 <501 LA Euro3>						
			Komp.Nr. 505126/ 01	09.96-09.03	TNK	6	<b>0 432 191 589</b>		
			Komp.Nr. 505137/03	09.96-09.03	TNK	6	<b>0 432 191 446</b>		
			Komp.Nr. 505137/05	09.96-09.03	TNK	6	<b>0 432 191 459</b>		
			Komp.Nr. 505137/10	09.96-09.03	TNK	6	<b>0 432 191 384</b>		
			Komp.Nr. 505137/25	09.96-09.03	TNK	6	<b>0 432 191 258</b>		
			Komp.Nr. 505137/27	09.96-09.03	TNK	6	<b>0 432 191 348</b>		
L [SKN]	12,0	260	OM 541.922 <(501)LA Euro2>						
			Komp.Nr. 505126/01/02	09.96-09.03	TNK	6	<b>0 432 191 589</b>		
			Komp.Nr. 505137/01/02						
			Komp.Nr. 505137/07	09.96-09.03	TNK	6	<b>0 432 191 437</b>		
			Komp.Nr. 505137/08						
			Komp.Nr. 505137/18/19	09.96-09.03	TNK	6	<b>0 432 193 459</b>		
			Komp.Nr. 505137/31	09.96-09.03	TNK	6	<b>0 432 193 459</b>		
<b>2540</b> [SKN]	12,0	290	OM 541.944 <501 LA Euro3>						
			Komp.Nr. 505126/ 01	09.96-09.03	TNK	6	<b>0 432 191 589</b>		
			Komp.Nr. 505137/03	09.96-09.03	TNK	6	<b>0 432 191 446</b>		
			Komp.Nr. 505137/05	09.96-09.03	TNK	6	<b>0 432 191 459</b>		
			Komp.Nr. 505137/10	09.96-09.03	TNK	6	<b>0 432 191 384</b>		
			Komp.Nr. 505137/25	09.96-09.03	TNK	6	<b>0 432 191 258</b>		
			Komp.Nr. 505137/27	09.96-09.03	TNK	6	<b>0 432 191 348</b>		
, L [SKN]	12,0	290	OM 541.923 <(501)LA Euro2>						
			Komp.Nr. 505126/01/02	09.96-09.03	TNK	6	<b>0 432 191 589</b>		
			Komp.Nr. 505137/01/02						
			Komp.Nr. 505137/07	09.96-09.03	TNK	6	<b>0 432 191 437</b>		
			Komp.Nr. 505137/08						
			Komp.Nr. 505137/18/19	09.96-09.03	TNK	6	<b>0 432 193 459</b>		
			Komp.Nr. 505137/31	09.96-09.03	TNK	6	<b>0 432 193 459</b>		
<b>2543</b> [SKN]	12,0	315	OM 541.946 <501 LA Euro3>						
			Komp.Nr. 505126/ 01	09.96-09.03	TNK	6	<b>0 432 191 589</b>		
			Komp.Nr. 505137/03	09.96-09.03	TNK	6	<b>0 432 191 446</b>		
			Komp.Nr. 505137/05	09.96-09.03	TNK	6	<b>0 432 191 459</b>		
			Komp.Nr. 505137/10	09.96-09.03	TNK	6	<b>0 432 191 384</b>		
			Komp.Nr. 505137/25	09.96-09.03	TNK	6	<b>0 432 191 258</b>		
			Komp.Nr. 505137/27	09.96-09.03	TNK	6	<b>0 432 191 348</b>		
, L [SKN]	12,0	315	OM 541.925 <(501)LA Euro2>						
			Komp.Nr. 505126/01/02	09.96-09.03	TNK	6	<b>0 432 191 589</b>		
			Komp.Nr. 505137/01/02						
			Komp.Nr. 505137/07	09.96-09.03	TNK	6	<b>0 432 191 437</b>		
			Komp.Nr. 505137/08						
			Komp.Nr. 505137/18/19	09.96-09.03	TNK	6	<b>0 432 193 459</b>		
			Komp.Nr. 505137/31	09.96-09.03	TNK	6	<b>0 432 193 459</b>		





<b>2548</b> [SKN]	15,9	350	OM 542.940 <502 LA Euro3>					
			Komp.Nr. 505126/ 02	09.96-09.03	TNK	8	<b>0 432 191 589</b>	
			Komp.Nr. 505137 /28	09.96-09.03		8	<b>0 432 191 348</b>	
			Komp.Nr. 505137/04	09.96-09.03	TNK	8	<b>0 432 191 446</b>	
			Komp.Nr. 505137/06	09.96-09.03	TNK	8	<b>0 432 191 459</b>	
			Komp.Nr. 505137/11	09.96-09.03	TNK	8	<b>0 432 191 384</b>	
			Komp.Nr. 505137/26	09.96-09.03	TNK	8	<b>0 432 191 258</b>	
, L [SKN]	16,0	350	OM 542.921 <(502)LA Euro2>					
			Komp.Nr. 505126/01/02	09.96-09.03	TNK	8	<b>0 432 191 589</b>	
			Komp.Nr. 505137/01/02					
			Komp.Nr. 505137/07	09.96-09.03	TNK	8	<b>0 432 191 437</b>	
			Komp.Nr. 505137/08					
			Komp.Nr. 505137/18/19	09.96-09.03	TNK	8	<b>0 432 193 459</b>	
			Komp.Nr. 505137/31	09.96-09.03	TNK	8	<b>0 432 193 459</b>	
<b>2553</b> [SKN]	15,9	390	OM 542.942 <502 LA Euro3>					
			Komp.Nr. 505126/ 02	09.96-09.03	TNK	8	<b>0 432 191 589</b>	
			Komp.Nr. 505137 /28	09.96-09.03		8	<b>0 432 191 348</b>	
			Komp.Nr. 505137/04	09.96-09.03	TNK	8	<b>0 432 191 446</b>	
			Komp.Nr. 505137/06	09.96-09.03	TNK	8	<b>0 432 191 459</b>	
			Komp.Nr. 505137/11	09.96-09.03	TNK	8	<b>0 432 191 384</b>	
			Komp.Nr. 505137/26	09.96-09.03	TNK	8	<b>0 432 191 258</b>	
, L [SKN]	16,0	390	OM 542.920 <(502)LA Euro2>					
			Komp.Nr. 505126/01/02	09.96-09.03	TNK	8	<b>0 432 191 589</b>	
			Komp.Nr. 505137/01/02					
			Komp.Nr. 505137/07	09.96-09.03	TNK	8	<b>0 432 191 437</b>	
			Komp.Nr. 505137/08					
			Komp.Nr. 505137/18/19	09.96-09.03	TNK	8	<b>0 432 193 459</b>	
			Komp.Nr. 505137/31	09.96-09.03	TNK	8	<b>0 432 193 459</b>	
<b>2557</b> L [SKN]	15,9	420	OM 542.944 <502 LA Euro3>					
			Komp.Nr. 505126/ 02	09.96-09.03	TNK	8	<b>0 432 191 589</b>	
			Komp.Nr. 505137 /28	09.96-09.03		8	<b>0 432 191 348</b>	
			Komp.Nr. 505137/04	09.96-09.03	TNK	8	<b>0 432 191 446</b>	
			Komp.Nr. 505137/06	09.96-09.03	TNK	8	<b>0 432 191 459</b>	
			Komp.Nr. 505137/11	09.96-09.03	TNK	8	<b>0 432 191 384</b>	
			Komp.Nr. 505137/26	09.96-09.03	TNK	8	<b>0 432 191 258</b>	
			OM 542.922 <(502)LA Euro2>					
		16,0	420	Komp.Nr. 505126/01/02	04.97-09.03	TNK	8	<b>0 432 191 589</b>
			Komp.Nr. 505137/01/02					
			Komp.Nr. 505137/07	04.97-09.03	TNK	8	<b>0 432 191 437</b>	
			Komp.Nr. 505137/08					
			Komp.Nr. 505137/18/19	04.97-09.03	TNK	8	<b>0 432 193 459</b>	
			Komp.Nr. 505137/31	04.97-09.03	TNK	8	<b>0 432 193 459</b>	
<b>2631</b> [SKN]	12,0	230	OM 541.940 <501 LA Euro3>					
			Komp.Nr. 505126/ 01	04.97-09.03	TNK	6	<b>0 432 191 589</b>	
			Komp.Nr. 505137/03	04.97-09.03	TNK	6	<b>0 432 191 446</b>	
			Komp.Nr. 505137/05	04.97-09.03	TNK	6	<b>0 432 191 459</b>	
			Komp.Nr. 505137/10	04.97-09.03	TNK	6	<b>0 432 191 384</b>	
			Komp.Nr. 505137/25	04.97-09.03	TNK	6	<b>0 432 191 258</b>	
			Komp.Nr. 505137/27	04.97-09.03	TNK	6	<b>0 432 191 348</b>	
, L [SKN]	12,0	230	OM 541.920 <(501)LA Euro2>					
			Komp.Nr. 505126/01/02	04.97-09.03	TNK	6	<b>0 432 191 589</b>	
			Komp.Nr. 505137/01/02					
			Komp.Nr. 505137/07	04.97-09.03	TNK	6	<b>0 432 191 437</b>	
			Komp.Nr. 505137/08					
			Komp.Nr. 505137/18/19	04.97-09.03	TNK	6	<b>0 432 193 459</b>	
			Komp.Nr. 505137/31	04.97-09.03	TNK	6	<b>0 432 193 459</b>	
<b>2635</b> [SKN]	12,0	260	OM 541.942 <501 LA Euro3>					
			Komp.Nr. 505126/ 01	04.97-09.03	TNK	6	<b>0 432 191 589</b>	
			Komp.Nr. 505137/03	04.97-09.03	TNK	6	<b>0 432 191 446</b>	
			Komp.Nr. 505137/05	04.97-09.03	TNK	6	<b>0 432 191 459</b>	
			Komp.Nr. 505137/10	04.97-09.03	TNK	6	<b>0 432 191 384</b>	
			Komp.Nr. 505137/25	04.97-09.03	TNK	6	<b>0 432 191 258</b>	
			Komp.Nr. 505137/27	04.97-09.03	TNK	6	<b>0 432 191 348</b>	





◀ MERCEDES-BENZ

<b>2635</b> , L [SKN]	12,0	260	OM 541.922 <(501)LA Euro2>						
			Komp.Nr. 505126/01/02	04.97-09.03	TNK	6	<b>0 432 191 589</b>		
			Komp.Nr. 505137/01/02						
			Komp.Nr. 505137/07	04.97-09.03	TNK	6	<b>0 432 191 437</b>		
			Komp.Nr. 505137/08						
			Komp.Nr. 505137/18/19	04.97-09.03	TNK	6	<b>0 432 193 459</b>		
			Komp.Nr. 505137/31	04.97-09.03	TNK	6	<b>0 432 193 459</b>		
<b>2640</b> [SKN]	12,0	290	OM 541.944 <501 LA Euro3>						
			Komp.Nr. 505126/ 01	09.96-09.03	TNK	6	<b>0 432 191 589</b>		
			Komp.Nr. 505137/03	09.96-09.03	TNK	6	<b>0 432 191 446</b>		
			Komp.Nr. 505137/05	09.96-09.03	TNK	6	<b>0 432 191 459</b>		
			Komp.Nr. 505137/10	09.96-09.03	TNK	6	<b>0 432 191 384</b>		
			Komp.Nr. 505137/25	09.96-09.03	TNK	6	<b>0 432 191 258</b>		
			Komp.Nr. 505137/27	09.96-09.03	TNK	6	<b>0 432 191 348</b>		
, L [SKN]	12,0	290	OM 541.923 <(501)LA Euro2>						
			Komp.Nr. 505126/01/02	09.96-09.03	TNK	6	<b>0 432 191 589</b>		
			Komp.Nr. 505137/01/02						
			Komp.Nr. 505137/07	09.96-09.03	TNK	6	<b>0 432 191 437</b>		
			Komp.Nr. 505137/08						
			Komp.Nr. 505137/18/19	09.96-09.03	TNK	6	<b>0 432 193 459</b>		
			Komp.Nr. 505137/31	09.96-09.03	TNK	6	<b>0 432 193 459</b>		
<b>2643</b> [SKN]	12,0	315	OM 541.946 <501 LA Euro3>						
			Komp.Nr. 505126/ 01	09.96-09.03	TNK	6	<b>0 432 191 589</b>		
			Komp.Nr. 505137/03	09.96-09.03	TNK	6	<b>0 432 191 446</b>		
			Komp.Nr. 505137/05	09.96-09.03	TNK	6	<b>0 432 191 459</b>		
			Komp.Nr. 505137/10	09.96-09.03	TNK	6	<b>0 432 191 384</b>		
			Komp.Nr. 505137/25	09.96-09.03	TNK	6	<b>0 432 191 258</b>		
			Komp.Nr. 505137/27	09.96-09.03	TNK	6	<b>0 432 191 348</b>		
, L [SKN]	12,0	315	OM 541.925 <(501)LA Euro2>						
			Komp.Nr. 505126/01/02	09.96-09.03	TNK	6	<b>0 432 191 589</b>		
			Komp.Nr. 505137/01/02						
			Komp.Nr. 505137/07	09.96-09.03	TNK	6	<b>0 432 191 437</b>		
			Komp.Nr. 505137/08						
			Komp.Nr. 505137/18/19	09.96-09.03	TNK	6	<b>0 432 193 459</b>		
			Komp.Nr. 505137/31	09.96-09.03	TNK	6	<b>0 432 193 459</b>		
<b>2648</b> [SKN]	15,9	350	OM 542.940 <502 LA Euro3>						
			Komp.Nr. 505126/ 02	09.96-09.03	TNK	8	<b>0 432 191 589</b>		
			Komp.Nr. 505137 /28	09.96-09.03		8	<b>0 432 191 348</b>		
			Komp.Nr. 505137/04	09.96-09.03	TNK	8	<b>0 432 191 446</b>		
			Komp.Nr. 505137/06	09.96-09.03	TNK	8	<b>0 432 191 459</b>		
			Komp.Nr. 505137/11	09.96-09.03	TNK	8	<b>0 432 191 384</b>		
			Komp.Nr. 505137/26	09.96-09.03	TNK	8	<b>0 432 191 258</b>		
, L [SKN]	16,0	350	OM 542.921 <(502)LA Euro2>						
			Komp.Nr. 505126/01/02	09.96-09.03	TNK	8	<b>0 432 191 589</b>		
			Komp.Nr. 505137/01/02						
			Komp.Nr. 505137/07	09.96-09.03	TNK	8	<b>0 432 191 437</b>		
			Komp.Nr. 505137/08						
			Komp.Nr. 505137/18/19	09.96-09.03	TNK	8	<b>0 432 193 459</b>		
			Komp.Nr. 505137/31	09.96-09.03	TNK	8	<b>0 432 193 459</b>		
<b>2653</b> [SKN]	15,9	390	OM 542.942 <502 LA Euro3>						
			Komp.Nr. 505126/ 02	09.96-09.03	TNK	8	<b>0 432 191 589</b>		
			Komp.Nr. 505137 /28	09.96-09.03		8	<b>0 432 191 348</b>		
			Komp.Nr. 505137/04	09.96-09.03	TNK	8	<b>0 432 191 446</b>		
			Komp.Nr. 505137/06	09.96-09.03	TNK	8	<b>0 432 191 459</b>		
			Komp.Nr. 505137/11	09.96-09.03	TNK	8	<b>0 432 191 384</b>		
			Komp.Nr. 505137/26	09.96-09.03	TNK	8	<b>0 432 191 258</b>		
, L [SKN]	16,0	390	OM 542.920 <(502)LA Euro2>						
			Komp.Nr. 505126/01/02	09.96-09.03	TNK	8	<b>0 432 191 589</b>		
			Komp.Nr. 505137/01/02						
			Komp.Nr. 505137/07	09.96-09.03	TNK	8	<b>0 432 191 437</b>		
			Komp.Nr. 505137/08						
			Komp.Nr. 505137/18/19	09.96-09.03	TNK	8	<b>0 432 193 459</b>		
			Komp.Nr. 505137/31	09.96-09.03	TNK	8	<b>0 432 193 459</b>		







<b>2657</b> [SKN]	15,9	420	OM 542.944 <502 LA Euro3>				
			Komp.Nr. 505126/02	09.96-09.03	TNK	8	<b>0 432 191 589</b>
			Komp.Nr. 505137/28	09.96-09.03		8	<b>0 432 191 348</b>
			Komp.Nr. 505137/04	09.96-09.03	TNK	8	<b>0 432 191 446</b>
			Komp.Nr. 505137/06	09.96-09.03	TNK	8	<b>0 432 191 459</b>
			Komp.Nr. 505137/11	09.96-09.03	TNK	8	<b>0 432 191 384</b>
, L [SKN]	16,0	420	OM 542.922 <(502) LA Euro2>				
			Komp.Nr. 505126/01/02	04.97-09.03	TNK	8	<b>0 432 191 589</b>
			Komp.Nr. 505137/01/02				
			Komp.Nr. 505137/07	04.97-09.03	TNK	8	<b>0 432 191 437</b>
			Komp.Nr. 505137/08				
			Komp.Nr. 505137/18/19	04.97-09.03	TNK	8	<b>0 432 193 459</b>
<b>3231</b> [SKN]	12,0	230	OM 541.920 <(501) LA Euro2>				
			Komp.Nr. 505126/01/02	04.97-09.03	TNK	6	<b>0 432 191 589</b>
			Komp.Nr. 505137/01/02				
			Komp.Nr. 505137/07	04.97-09.03	TNK	6	<b>0 432 191 437</b>
			Komp.Nr. 505137/08				
			Komp.Nr. 505137/18/19	04.97-09.03	TNK	6	<b>0 432 193 459</b>
<b>3235</b> [SKN]	12,0	260	OM 541.922 <(501) LA Euro2>				
			Komp.Nr. 505126/01/02	04.97-09.03	TNK	6	<b>0 432 191 589</b>
			Komp.Nr. 505137/01/02				
			Komp.Nr. 505137/07	04.97-09.03	TNK	6	<b>0 432 191 437</b>
			Komp.Nr. 505137/08				
			Komp.Nr. 505137/18/19	04.97-09.03	TNK	6	<b>0 432 193 459</b>
<b>3240</b> [SKN]	12,0	290	OM 541.923 <(501) LA Euro2>				
			Komp.Nr. 505126/01/02	04.97-09.03	TNK	6	<b>0 432 191 589</b>
			Komp.Nr. 505137/01/02				
			Komp.Nr. 505137/07	04.97-09.03	TNK	6	<b>0 432 191 437</b>
			Komp.Nr. 505137/08				
			Komp.Nr. 505137/18/19	04.97-09.03	TNK	6	<b>0 432 193 459</b>
<b>3243</b> [SKN]	12,0	315	OM 541.925 <(501) LA Euro2>				
			Komp.Nr. 505126/01/02	04.97-09.03	TNK	6	<b>0 432 191 589</b>
			Komp.Nr. 505137/01/02				
			Komp.Nr. 505137/07	04.97-09.03	TNK	6	<b>0 432 191 437</b>
			Komp.Nr. 505137/08				
			Komp.Nr. 505137/18/19	04.97-09.03	TNK	6	<b>0 432 193 459</b>
<b>3331</b> [SKN]	12,0	230	OM 541.920 <(501) LA Euro2>				
			Komp.Nr. 505126/01/02	04.97-09.03	TNK	6	<b>0 432 191 589</b>
			Komp.Nr. 505137/01/02				
			Komp.Nr. 505137/07	04.97-09.03	TNK	6	<b>0 432 191 437</b>
			Komp.Nr. 505137/08				
			Komp.Nr. 505137/18/19	04.97-09.03	TNK	6	<b>0 432 193 459</b>
A [SKN]	12,0	230	OM 541.926 <(501) LA Euro2>				
			Komp.Nr. 505126/01/02	04.97-09.03	TNK	6	<b>0 432 191 589</b>
			Komp.Nr. 505137/01/02				
			Komp.Nr. 505137/07	04.97-09.03	TNK	6	<b>0 432 191 437</b>
			Komp.Nr. 505137/08				
			Komp.Nr. 505137/18/19	04.97-09.03	TNK	6	<b>0 432 193 459</b>
<b>3335</b> [SKN]	12,0	260	OM 541.922 <(501) LA Euro2>				
			Komp.Nr. 505126/01/02	04.97-09.03	TNK	6	<b>0 432 191 589</b>
			Komp.Nr. 505137/01/02				
			Komp.Nr. 505137/07	04.97-09.03	TNK	6	<b>0 432 191 437</b>
			Komp.Nr. 505137/08				
			Komp.Nr. 505137/18/19	04.97-09.03	TNK	6	<b>0 432 193 459</b>
			Komp.Nr. 505137/31	04.97-09.03	TNK	6	<b>0 432 193 459</b>
			Komp.Nr. 505137/31	04.97-09.03	TNK	6	<b>0 432 193 459</b>
			Komp.Nr. 505137/31	04.97-09.03	TNK	6	<b>0 432 193 459</b>
			Komp.Nr. 505137/31	04.97-09.03	TNK	6	<b>0 432 193 459</b>
			Komp.Nr. 505137/31	04.97-09.03	TNK	6	<b>0 432 193 459</b>
			Komp.Nr. 505137/31	04.97-09.03	TNK	6	<b>0 432 193 459</b>







◀ MERCEDES-BENZ

3340 [SKN]	12,0	290	OM 541.923 <(501)LA Euro2>					
			Komp.Nr. 505126/01/02	04.97-09.03	TNK	6	<b>0 432 191 589</b>	
			Komp.Nr. 505137/01/02					
			Komp.Nr. 505137/07	04.97-09.03	TNK	6	<b>0 432 191 437</b>	
			Komp.Nr. 505137/08					
A [SKN]	12,0	290	OM 541.924 <(501)LA Euro 2>					
			Komp.Nr. 505126/01/02	04.97-09.03	TNK	6	<b>0 432 191 589</b>	
			Komp.Nr. 505137/01/02					
			Komp.Nr. 505137/07	04.97-09.03	TNK	6	<b>0 432 191 437</b>	
			Komp.Nr. 505137/08					
3343 [SKN]	12,0	315	OM 541.925 <(501)LA Euro2>					
			Komp.Nr. 505126/01/02	04.97-09.03	TNK	6	<b>0 432 191 589</b>	
			Komp.Nr. 505137/01/02					
			Komp.Nr. 505137/07	04.97-09.03	TNK	6	<b>0 432 191 437</b>	
			Komp.Nr. 505137/08					
A [SKN]	12,0	315	OM 541.921 <(501)LA Euro2>					
			Komp.Nr. 505126/01/02	04.97-09.03	TNK	6	<b>0 432 191 589</b>	
			Komp.Nr. 505137/01/02					
			Komp.Nr. 505137/07	04.97-09.03	TNK	6	<b>0 432 191 437</b>	
			Komp.Nr. 505137/08					
3348 [SKN]	16,0	350	OM 542.921 <(502)LA Euro2>					
			Komp.Nr. 505126/01/02	04.97-09.03	TNK	8	<b>0 432 191 589</b>	
			Komp.Nr. 505137/01/02					
			Komp.Nr. 505137/07	04.97-09.03	TNK	8	<b>0 432 191 437</b>	
			Komp.Nr. 505137/08					
A [SKN]	16,0	350	OM 542.925 <(502)LA Euro2>					
			Komp.Nr. 505126/01/02	04.97-09.03	TNK	8	<b>0 432 191 589</b>	
			Komp.Nr. 505137/01/02					
			Komp.Nr. 505137/07	04.97-09.03	TNK	8	<b>0 432 191 437</b>	
			Komp.Nr. 505137/08					
3353 [SKN]	16,0	390	OM 542... <(502)LA>					
			Komp.Nr. 505126/01/02	09.96-09.03	TNK	8	<b>0 432 191 589</b>	
			Komp.Nr. 505137/01/02					
			Mot.-Typ 542.920					
			Mot.-Typ 542.926					
A [SKN]	16,0	390	OM 542... <(502)LA>					
			Komp.Nr. 505134/04	09.96-09.03	TNK	8	<b>0 432 191 446</b>	
			Mot.-Typ 542.943					
			Komp.Nr. 505137 /28	09.96-09.03	TNK	8	<b>0 432 191 348</b>	
			Mot.-Typ 542.943					
A [SKN]	16,0	390	OM 542... <(502)LA>					
			Komp.Nr. 505137/06	09.96-09.03	TNK	8	<b>0 432 191 459</b>	
			Mot.-Typ 542.943					
			Komp.Nr. 505137/07/08	09.96-09.03	TNK	8	<b>0 432 191 437</b>	
			Mot.-Typ 542.920					
A [SKN]	16,0	390	OM 542... <(502)LA>					
			Mot.-Typ 542.926					
			Komp.Nr. 505137/11	09.96-09.03	TNK	8	<b>0 432 191 384</b>	
			Mot.-Typ 542.943					
			Komp.Nr. 505137/18/19	09.96-09.03	TNK	8	<b>0 432 193 459</b>	
A [SKN]	16,0	390	OM 542... <(502)LA>					
			Mot.-Typ 542.920					
			Mot.-Typ 542.926					
			Mot.-Typ 542.920					
			Mot.-Typ 542.926					





<b>3357</b> [SKN]	16,0	420	OM 542.922 <(502)LA Euro2>				
			Komp.Nr. 505126/01/02	04.97-09.03	TNK	8	<b>0 432 191 589</b>
			Komp.Nr. 505137/01/02				
			Komp.Nr. 505137/07	04.97-09.03	TNK	8	<b>0 432 191 437</b>
			Komp.Nr. 505137/08				
<b>4140</b> [SKN]	12,0	290	OM 541.923 <(501)LA Euro2>				
			Komp.Nr. 505126/01/02	04.97-09.03	TNK	6	<b>0 432 191 589</b>
			Komp.Nr. 505137/01/02				
			Komp.Nr. 505137/07	04.97-09.03	TNK	6	<b>0 432 191 437</b>
			Komp.Nr. 505137/08				
A [SKN]	12,0	290	OM 541.924 <(501)LA Euro 2>				
			Komp.Nr. 505126/01/02	04.97-09.03	TNK	6	<b>0 432 191 589</b>
			Komp.Nr. 505137/01/02				
			Komp.Nr. 505137/07	04.97-09.03	TNK	6	<b>0 432 191 437</b>
			Komp.Nr. 505137/08				
<b>4143</b> [SKN]	12,0	315	OM 541.925 <(501)LA Euro2>				
			Komp.Nr. 505126/01/02	04.97-09.03	TNK	6	<b>0 432 191 589</b>
			Komp.Nr. 505137/01/02				
			Komp.Nr. 505137/07	04.97-09.03	TNK	6	<b>0 432 191 437</b>
			Komp.Nr. 505137/08				
A [SKN]	12,0	315	OM 541.921 <(501)LA Euro2>				
			Komp.Nr. 505126/01/02	04.97-09.03	TNK	6	<b>0 432 191 589</b>
			Komp.Nr. 505137/01/02				
			Komp.Nr. 505137/07	04.97-09.03	TNK	6	<b>0 432 191 437</b>
			Komp.Nr. 505137/08				
<b>4148</b> [SKN]	16,0	350	OM 542.921 <(502)LA Euro2>				
			Komp.Nr. 505126/01/02	04.97-09.03	TNK	8	<b>0 432 191 589</b>
			Komp.Nr. 505137/01/02				
			Komp.Nr. 505137/07	04.97-09.03	TNK	8	<b>0 432 191 437</b>
			Komp.Nr. 505137/08				
			OM 542.925 <(502)LA Euro2>				
			Komp.Nr. 505126/01/02	04.97-09.03	TNK	8	<b>0 432 191 589</b>
			Komp.Nr. 505137/01/02				
			Komp.Nr. 505137/07	04.97-09.03	TNK	8	<b>0 432 191 437</b>
			Komp.Nr. 505137/08				
			OM 542.925 <(502)LA Euro2>				
			Komp.Nr. 505126/01/02	04.97-09.03	TNK	8	<b>0 432 191 589</b>
			Komp.Nr. 505137/01/02				
			Komp.Nr. 505137/07	04.97-09.03	TNK	8	<b>0 432 191 437</b>
			Komp.Nr. 505137/08				
<b>Actros II</b>			OM 541.940 <501 LA Euro3>				
			Fg.-Nr. 505137/25	04.03-12.08	TNK	6	<b>0 432 191 347</b>
			Komp.Nr. 505126/01/02	04.03-12.08	TNK	6	<b>0 432 191 589</b>
			Komp.Nr. 505137/03	04.03-12.08	TNK	6	<b>0 432 191 446</b>
			Komp.Nr. 505137/05	04.03-12.08	TNK	6	<b>0 432 191 459</b>
<b>1832</b> [MP2]	12,0	235	OM 541.940 <501 LA Euro3>				
			Komp.Nr. 505126/01/02	04.03-12.08	TNK	6	<b>0 432 191 589</b>
			Komp.Nr. 505137/03	04.03-12.08	TNK	6	<b>0 432 191 446</b>
			Komp.Nr. 505137/05	04.03-12.08	TNK	6	<b>0 432 191 459</b>
			Komp.Nr. 505137/10	04.03-12.08	TNK	6	<b>0 432 191 384</b>
			Komp.Nr. 505137/31	04.03-12.08	TNK	6	<b>0 432 193 459</b>





◀ MERCEDES-BENZ

<b>1836</b> [MP2]	12,0	265	OM 541.942 <501 LA Euro3>					
			Fg.-Nr. 505137 /25	04.03-12.08	TNK	6	<b>0 432 191 347</b>	
			Komp.Nr. 505126/ 01	04.03-12.08	TNK	6	<b>0 432 191 589</b>	
			Komp.Nr. 505137 /03	04.03-12.08	TNK	6	<b>0 432 191 446</b>	
			Komp.Nr. 505137/03	04.03-12.08	TNK	6	<b>0 432 191 446</b>	
			Komp.Nr. 505137/05	04.03-12.08	TNK	6	<b>0 432 191 459</b>	
			Komp.Nr. 505137/10	04.03-12.08	TNK	6	<b>0 432 191 384</b>	
Komp.Nr. 505137/31	04.03-12.08	TNK	6	<b>0 432 193 459</b>				
<b>1841</b> [MP2]	12,0	300	OM 541.944 <501 LA Euro3>					
			Komp.Nr. 505126/ 01	04.03-12.08	TNK	6	<b>0 432 191 589</b>	
			Komp.Nr. 505137 /03	04.03-12.08	TNK	6	<b>0 432 191 446</b>	
			Komp.Nr. 505137/03	04.03-12.08	TNK	6	<b>0 432 191 446</b>	
			Komp.Nr. 505137/10	04.03-12.08	TNK	6	<b>0 432 191 384</b>	
			Komp.Nr. 505137/27	04.03-12.08	TNK	6	<b>0 432 191 348</b>	
Komp.Nr. 505137/31	04.03-12.08	TNK	6	<b>0 432 193 459</b>				
<b>1844</b> [MP2]	12,0	320	OM 541.946 <501 LA Euro3>					
			Komp.Nr. 505126/ 01	04.03-12.08	TNK	6	<b>0 432 191 589</b>	
			Komp.Nr. 505137/03	04.03-12.08	TNK	6	<b>0 432 191 446</b>	
			Komp.Nr. 505137/10	04.03-12.08	TNK	6	<b>0 432 191 384</b>	
			Komp.Nr. 505137/27	04.03-12.08	TNK	6	<b>0 432 191 348</b>	
Komp.Nr. 505137/31	04.03-12.08	TNK	6	<b>0 432 193 459</b>				
<b>1846</b> [MP2]	12,0	335	OM 541... <501 LA Euro3>					
			Komp.Nr. 505137/27	04.03-12.08	TNK	6	<b>0 432 191 348</b>	
<b>1850</b> [MP2]	15,9	370	OM 542.940 <502 LA Euro3>					
			Fg.-Nr. 505137 /26	04.03-12.08	TNK	8	<b>0 432 191 347</b>	
			Komp.Nr. 505126/ 02	04.03-12.08	TNK	8	<b>0 432 191 589</b>	
			Komp.Nr. 505134/04	04.03-12.08	TNK	8	<b>0 432 191 446</b>	
			Komp.Nr. 505137 /28	04.03-12.08		8	<b>0 432 191 348</b>	
			Komp.Nr. 505137/06	04.03-12.08	TNK	8	<b>0 432 191 459</b>	
Komp.Nr. 505137/11	04.03-12.08	TNK	8	<b>0 432 191 384</b>				
<b>1854</b> [MP2]	15,9	395	OM 542.942 <502 LA Euro3>					
			Komp.Nr. 505126/ 02	04.03-12.08	TNK	8	<b>0 432 191 589</b>	
			Komp.Nr. 505137/04	04.03-12.08	TNK	8	<b>0 432 191 446</b>	
			Komp.Nr. 505137/06	04.03-12.08	TNK	8	<b>0 432 191 459</b>	
Komp.Nr. 505137/11	04.03-12.08	TNK	8	<b>0 432 191 384</b>				
<b>1858</b> [MP2]	15,9	425	OM 542.944 <502 LA Euro3>					
			Komp.Nr. 505126/ 02	04.03-12.08	TNK	8	<b>0 432 191 589</b>	
			Komp.Nr. 505137 /28	04.03-12.08		8	<b>0 432 191 348</b>	
			Komp.Nr. 505137/04	04.03-12.08	TNK	8	<b>0 432 191 446</b>	
			Komp.Nr. 505137/06	04.03-12.08	TNK	8	<b>0 432 191 459</b>	
Komp.Nr. 505137/11	04.03-12.08	TNK	8	<b>0 432 191 384</b>				
<b>1861</b> Black Edition [MP2]	15,9	450	OM 542.958 <502 LA Euro3>					
			Komp.Nr. 505137 /28	09.04-12.08		8	<b>0 432 191 348</b>	
<b>2032</b> [MP2]	12,0	235	OM 541.940,941 <501 LA Euro3>					
			Fg.-Nr. 505137 /25	04.03-12.08	TNK	6	<b>0 432 191 347</b>	
			Komp.Nr. 505126 /01/02	04.03-12.08	TNK	6	<b>0 432 191 589</b>	
			Komp.Nr. 505137/03	04.03-12.08	TNK	6	<b>0 432 191 446</b>	
			Komp.Nr. 505137/05	04.03-12.08	TNK	6	<b>0 432 191 459</b>	
			Komp.Nr. 505137/10	04.03-12.08	TNK	6	<b>0 432 191 384</b>	
Komp.Nr. 505137/31	04.03-12.08	TNK	6	<b>0 432 193 459</b>				
<b>2036</b> [MP2]	12,0	265	OM 541... <501 LA Euro3>					
			Fg.-Nr. 505137 /25	04.03-12.08	TNK	6	<b>0 432 191 347</b>	
			Komp.Nr. 505126/ 01	04.03-12.08	TNK	6	<b>0 432 191 589</b>	
			Komp.Nr. 505137 /03	04.03-12.08	TNK	6	<b>0 432 191 446</b>	
			Komp.Nr. 505137/03	04.03-12.08	TNK	6	<b>0 432 191 446</b>	
			Komp.Nr. 505137/05	04.03-12.08	TNK	6	<b>0 432 191 459</b>	
			Komp.Nr. 505137/10	04.03-12.08	TNK	6	<b>0 432 191 384</b>	
Komp.Nr. 505137/31	04.03-12.08	TNK	6	<b>0 432 193 459</b>				





<b>2041</b> [MP2]	12,0	300	OM 541.944 <501 LA Euro3>					
			Komp.Nr. 505126/ 01	04.03-12.08	TNK	6	<b>0 432 191 589</b>	
			Komp.Nr. 505137 /03	04.03-12.08	TNK	6	<b>0 432 191 446</b>	
			Komp.Nr. 505137 /28	04.03-12.08	TNK	6	<b>0 432 191 348</b>	
			Mot.-Typ 542.943					
			Komp.Nr. 505137/03	04.03-12.08	TNK	6	<b>0 432 191 446</b>	
			Komp.Nr. 505137/10	04.03-12.08	TNK	6	<b>0 432 191 384</b>	
<b>2044</b> [MP2]	12,0	320	OM 541... <501 LA Euro3>					
			Komp.Nr. 505126/ 01	04.03-12.08	TNK	6	<b>0 432 191 589</b>	
			Komp.Nr. 505137/03	04.03-12.08	TNK	6	<b>0 432 191 446</b>	
			Komp.Nr. 505137/10	04.03-12.08	TNK	6	<b>0 432 191 384</b>	
			Komp.Nr. 505137/27	04.03-12.08	TNK	6	<b>0 432 191 348</b>	
			Komp.Nr. 505137/31	04.03-12.08	TNK	6	<b>0 432 193 459</b>	
			<b>2046</b> [MP2]	12,0	335	OM 541... <501 LA Euro3>		
Komp.Nr. 505137/27	04.03-12.08	TNK				6	<b>0 432 191 348</b>	
<b>2050</b> [MP2]	15,9	370	OM 542.940 <502 LA Euro3>					
			Fg.-Nr. 505137 /26	04.03-12.08	TNK	8	<b>0 432 191 347</b>	
			Komp.Nr. 505126/ 02	04.03-12.08	TNK	8	<b>0 432 191 589</b>	
			Komp.Nr. 505134/04	04.03-12.08	TNK	8	<b>0 432 191 446</b>	
			Komp.Nr. 505137 /28	04.03-12.08		8	<b>0 432 191 348</b>	
			Komp.Nr. 505137/06	04.03-12.08	TNK	8	<b>0 432 191 459</b>	
			Komp.Nr. 505137/11	04.03-12.08	TNK	8	<b>0 432 191 384</b>	
<b>2054</b> [MP2]	15,9	395	OM 542.942 <502 LA Euro3>					
			Komp.Nr. 505126/ 02	04.03-12.08	TNK	8	<b>0 432 191 589</b>	
			Komp.Nr. 505137/04	04.03-12.08	TNK	8	<b>0 432 191 446</b>	
			Komp.Nr. 505137/06	04.03-12.08	TNK	8	<b>0 432 191 459</b>	
			Komp.Nr. 505137/11	04.03-12.08	TNK	8	<b>0 432 191 384</b>	
<b>2532</b> [MP2]	12,0	235	OM 541.940 <501 LA Euro3>					
			Fg.-Nr. 505137 /25	04.03-12.08	TNK	6	<b>0 432 191 347</b>	
			Komp.Nr. 505126 /01/02	04.03-12.08	TNK	6	<b>0 432 191 589</b>	
			Komp.Nr. 505137/03	04.03-12.08	TNK	6	<b>0 432 191 446</b>	
			Komp.Nr. 505137/05	04.03-12.08	TNK	6	<b>0 432 191 459</b>	
			Komp.Nr. 505137/10	04.03-12.08	TNK	6	<b>0 432 191 384</b>	
			Komp.Nr. 505137/31	04.03-12.08	TNK	6	<b>0 432 193 459</b>	
<b>2536</b> [MP2]	12,0	265	OM 541.942 <501 LA Euro3>					
			Fg.-Nr. 505137 /25	04.03-12.08	TNK	6	<b>0 432 191 347</b>	
			Komp.Nr. 505126/ 01	04.03-12.08	TNK	6	<b>0 432 191 589</b>	
			Komp.Nr. 505137 /03	04.03-12.08	TNK	6	<b>0 432 191 446</b>	
			Komp.Nr. 505137/03	04.03-12.08	TNK	6	<b>0 432 191 446</b>	
			Komp.Nr. 505137/05	04.03-12.08	TNK	6	<b>0 432 191 459</b>	
			Komp.Nr. 505137/10	04.03-12.08	TNK	6	<b>0 432 191 384</b>	
<b>2541</b> [MP2]	12,0	300	OM 541.944 <501 LA Euro3>					
			Komp.Nr. 505126/ 01	04.03-12.08	TNK	6	<b>0 432 191 589</b>	
			Komp.Nr. 505137 /03	04.03-12.08	TNK	6	<b>0 432 191 446</b>	
			Komp.Nr. 505137/03	04.03-12.08	TNK	6	<b>0 432 191 446</b>	
			Komp.Nr. 505137/10	04.03-12.08	TNK	6	<b>0 432 191 384</b>	
			Komp.Nr. 505137/27	04.03-12.08	TNK	6	<b>0 432 191 348</b>	
			Komp.Nr. 505137/31	04.03-12.08	TNK	6	<b>0 432 193 459</b>	
<b>2544</b> [MP2]	12,0	320	OM 541.946 <501 LA Euro3>					
			Komp.Nr. 505126/ 01	04.03-12.08	TNK	6	<b>0 432 191 589</b>	
			Komp.Nr. 505137/03	04.03-12.08	TNK	6	<b>0 432 191 446</b>	
			Komp.Nr. 505137/10	04.03-12.08	TNK	6	<b>0 432 191 384</b>	
			Komp.Nr. 505137/27	04.03-12.08	TNK	6	<b>0 432 191 348</b>	
<b>2546</b> [MP2]	12,0	335	OM 541.948 <501 LA Euro3>					
			Komp.Nr. 505137/27	04.03-12.08	TNK	6	<b>0 432 191 348</b>	





◀ MERCEDES-BENZ

<b>2550</b> [MP2]	15,9	370	OM 542.940 <502 LA Euro3>					
			Fg.-Nr. 505137 /26	04.03-12.08	TNK	8	<b>0 432 191 347</b>	
			Komp.Nr. 505126/ 02	04.03-12.08	TNK	8	<b>0 432 191 589</b>	
			Komp.Nr. 505134/04	04.03-12.08	TNK	8	<b>0 432 191 446</b>	
			Komp.Nr. 505137 /28	04.03-12.08		8	<b>0 432 191 348</b>	
			Komp.Nr. 505137/06	04.03-12.08	TNK	8	<b>0 432 191 459</b>	
<b>2554</b> [MP2]	15,9	395	OM 542.942 <502 LA Euro3>					
			Komp.Nr. 505126/ 02	04.03-12.08	TNK	8	<b>0 432 191 589</b>	
			Komp.Nr. 505137/04	04.03-12.08	TNK	8	<b>0 432 191 446</b>	
			Komp.Nr. 505137/06	04.03-12.08	TNK	8	<b>0 432 191 459</b>	
			Komp.Nr. 505137/11	04.03-12.08	TNK	8	<b>0 432 191 384</b>	
			<b>2558</b> [MP2]	15,9	425	OM 542.944 <502 LA Euro3>		
Komp.Nr. 505126/ 02	04.03-12.08	TNK				8	<b>0 432 191 589</b>	
Komp.Nr. 505137 /28	04.03-12.08					8	<b>0 432 191 348</b>	
Komp.Nr. 505137/04	04.03-12.08	TNK				8	<b>0 432 191 446</b>	
Komp.Nr. 505137/06	04.03-12.08	TNK				8	<b>0 432 191 459</b>	
Komp.Nr. 505137/11	04.03-12.08	TNK				8	<b>0 432 191 384</b>	
<b>2632</b> [MP2]	12,0	235	OM 541.940 <501 LA Euro3>					
			Fg.-Nr. 505137 /25	04.03-12.08	TNK	6	<b>0 432 191 347</b>	
			Komp.Nr. 505126 /01/02	04.03-12.08	TNK	6	<b>0 432 191 589</b>	
			Komp.Nr. 505137/03	04.03-12.08	TNK	6	<b>0 432 191 446</b>	
			Komp.Nr. 505137/05	04.03-12.08	TNK	6	<b>0 432 191 459</b>	
			Komp.Nr. 505137/10	04.03-12.08	TNK	6	<b>0 432 191 384</b>	
<b>2636</b> [MP2]	12,0	265	OM 541.942 <501 LA Euro3>					
			Fg.-Nr. 505137 /25	04.03-12.08	TNK	6	<b>0 432 191 347</b>	
			Komp.Nr. 505126/ 01	04.03-12.08	TNK	6	<b>0 432 191 589</b>	
			Komp.Nr. 505137 /03	04.03-12.08	TNK	6	<b>0 432 191 446</b>	
			Komp.Nr. 505137/03	04.03-12.08	TNK	6	<b>0 432 191 446</b>	
			Komp.Nr. 505137/05	04.03-12.08	TNK	6	<b>0 432 191 459</b>	
<b>2641</b> [MP2]	12,0	300	OM 541.944 <501 LA Euro3>					
			Komp.Nr. 505126/ 01	06.03-12.08	TNK	6	<b>0 432 191 589</b>	
			Komp.Nr. 505137 /03	06.03-12.08	TNK	6	<b>0 432 191 446</b>	
			Komp.Nr. 505137/03	06.03-12.08	TNK	6	<b>0 432 191 446</b>	
			Komp.Nr. 505137/10	06.03-12.08	TNK	6	<b>0 432 191 384</b>	
			Komp.Nr. 505137/27	06.03-12.08	TNK	6	<b>0 432 191 348</b>	
<b>2644</b> [MP2]	12,0	320	OM 541.946 <501 LA Euro3>					
			Komp.Nr. 505126/ 01	06.03-12.08	TNK	6	<b>0 432 191 589</b>	
			Komp.Nr. 505137/03	06.03-12.08	TNK	6	<b>0 432 191 446</b>	
			Komp.Nr. 505137/10	06.03-12.08	TNK	6	<b>0 432 191 384</b>	
			Komp.Nr. 505137/27	06.03-12.08	TNK	6	<b>0 432 191 348</b>	
			Komp.Nr. 505137/31	06.03-12.08	TNK	6	<b>0 432 193 459</b>	
<b>2646</b> [MP2]	12,0	335	OM 541.948 <501 LA Euro3>					
			Komp.Nr. 505137/27	06.03-12.08	TNK	6	<b>0 432 191 348</b>	
<b>2650</b> [MP2]	15,9	370	OM 542.940 <502 LA Euro3>					
			Fg.-Nr. 505137 /26	04.03-12.08	TNK	8	<b>0 432 191 347</b>	
			Komp.Nr. 505126/ 02	04.03-12.08	TNK	8	<b>0 432 191 589</b>	
			Komp.Nr. 505134/04	04.03-12.08	TNK	8	<b>0 432 191 446</b>	
			Komp.Nr. 505137 /28	04.03-12.08		8	<b>0 432 191 348</b>	
			Komp.Nr. 505137/06	04.03-12.08	TNK	8	<b>0 432 191 459</b>	
<b>2654</b> [MP2]	15,9	395	OM 542.942 <502 LA Euro3>					
			Komp.Nr. 505126/ 02	04.03-12.08	TNK	8	<b>0 432 191 589</b>	
			Komp.Nr. 505137/04	04.03-12.08	TNK	8	<b>0 432 191 446</b>	
			Komp.Nr. 505137/06	04.03-12.08	TNK	8	<b>0 432 191 459</b>	
			Komp.Nr. 505137/11	04.03-12.08	TNK	8	<b>0 432 191 384</b>	





2658 [MP2]	15,9	425	OM 542.944 <502 LA Euro3>					
			Komp.Nr. 505126/ 02	04.03-12.08	TNK	8	<b>0 432 191 589</b>	
			Komp.Nr. 505137 /28	04.03-12.08		8	<b>0 432 191 348</b>	
			Komp.Nr. 505137/04	04.03-12.08	TNK	8	<b>0 432 191 446</b>	
			Komp.Nr. 505137/06	04.03-12.08	TNK	8	<b>0 432 191 459</b>	
			Komp.Nr. 505137/11	04.03-12.08	TNK	8	<b>0 432 191 384</b>	
3232 [MP2]	12,0	235	OM 541.940 <501 LA Euro3>					
			Fg.-Nr. 505137 /25	04.03-12.08	TNK	6	<b>0 432 191 347</b>	
			Komp.Nr. 505126 /01/02	04.03-12.08	TNK	6	<b>0 432 191 589</b>	
			Komp.Nr. 505137/03	04.03-12.08	TNK	6	<b>0 432 191 446</b>	
			Komp.Nr. 505137/05	04.03-12.08	TNK	6	<b>0 432 191 459</b>	
			Komp.Nr. 505137/10	04.03-12.08	TNK	6	<b>0 432 191 384</b>	
			Komp.Nr. 505137/31	04.03-12.08	TNK	6	<b>0 432 193 459</b>	
3236 [MP2]	12,0	265	OM 541.942 <501 LA Euro3>					
			Fg.-Nr. 505137 /25	04.03-12.08	TNK	6	<b>0 432 191 347</b>	
			Komp.Nr. 505126/ 01	04.03-12.08	TNK	6	<b>0 432 191 589</b>	
			Komp.Nr. 505137 /03	04.03-12.08	TNK	6	<b>0 432 191 446</b>	
			Komp.Nr. 505137/03	04.03-12.08	TNK	6	<b>0 432 191 446</b>	
			Komp.Nr. 505137/05	04.03-12.08	TNK	6	<b>0 432 191 459</b>	
			Komp.Nr. 505137/10	04.03-12.08	TNK	6	<b>0 432 191 384</b>	
			Komp.Nr. 505137/31	04.03-12.08	TNK	6	<b>0 432 193 459</b>	
3241 [MP2]	12,0	300	OM 541.944 <501 LA Euro3>					
			Komp.Nr. 505126/ 01	04.03-12.08	TNK	6	<b>0 432 191 589</b>	
			Komp.Nr. 505137 /03	04.03-12.08	TNK	6	<b>0 432 191 446</b>	
			Komp.Nr. 505137/03	04.03-12.08	TNK	6	<b>0 432 191 446</b>	
			Komp.Nr. 505137/10	04.03-12.08	TNK	6	<b>0 432 191 384</b>	
			Komp.Nr. 505137/27	04.03-12.08	TNK	6	<b>0 432 191 348</b>	
			Komp.Nr. 505137/31	04.03-12.08	TNK	6	<b>0 432 193 459</b>	
3246 [MP2]	12,0	335	OM 541.948 <501 LA Euro3>					
			Komp.Nr. 505137/27	04.03-12.08	TNK	6	<b>0 432 191 348</b>	
3332 [MP2]	12,0	235	OM 541.940 <501 LA Euro3>					
			Fg.-Nr. 505137 /25	04.03-12.08	TNK	6	<b>0 432 191 347</b>	
			Komp.Nr. 505126 /01/02	04.03-12.08	TNK	6	<b>0 432 191 589</b>	
			Komp.Nr. 505137/03	04.03-12.08	TNK	6	<b>0 432 191 446</b>	
			Komp.Nr. 505137/05	04.03-12.08	TNK	6	<b>0 432 191 459</b>	
			Komp.Nr. 505137/10	04.03-12.08	TNK	6	<b>0 432 191 384</b>	
			Komp.Nr. 505137/31	04.03-12.08	TNK	6	<b>0 432 193 459</b>	
3336 [MP2]	12,0	265	OM 541.942 <501 LA Euro3>					
			Fg.-Nr. 505137 /25	04.03-12.08	TNK	6	<b>0 432 191 347</b>	
			Komp.Nr. 505126/ 01	04.03-12.08	TNK	6	<b>0 432 191 589</b>	
			Komp.Nr. 505137 /03	04.03-12.08	TNK	6	<b>0 432 191 446</b>	
			Komp.Nr. 505137/03	04.03-12.08	TNK	6	<b>0 432 191 446</b>	
			Komp.Nr. 505137/05	04.03-12.08	TNK	6	<b>0 432 191 459</b>	
			Komp.Nr. 505137/10	04.03-12.08	TNK	6	<b>0 432 191 384</b>	
			Komp.Nr. 505137/31	04.03-12.08	TNK	6	<b>0 432 193 459</b>	
3341 [MP2]	12,0	300	OM 541.944 <501 LA Euro3>					
			Komp.Nr. 505126/ 01	04.03-12.08	TNK	6	<b>0 432 191 589</b>	
			Komp.Nr. 505137 /03	04.03-12.08	TNK	6	<b>0 432 191 446</b>	
			Komp.Nr. 505137/03	04.03-12.08	TNK	6	<b>0 432 191 446</b>	
			Komp.Nr. 505137/10	04.03-12.08	TNK	6	<b>0 432 191 384</b>	
			Komp.Nr. 505137/27	04.03-12.08	TNK	6	<b>0 432 191 348</b>	
			Komp.Nr. 505137/31	04.03-12.08	TNK	6	<b>0 432 193 459</b>	
3344 [MP2]	12,0	320	OM 541.946 <501 LA Euro3>					
			Komp.Nr. 505126/ 01	06.03-12.08	TNK	6	<b>0 432 191 589</b>	
			Komp.Nr. 505137/03	06.03-12.08	TNK	6	<b>0 432 191 446</b>	
			Komp.Nr. 505137/10	06.03-12.08	TNK	6	<b>0 432 191 384</b>	
			Komp.Nr. 505137/27	06.03-12.08	TNK	6	<b>0 432 191 348</b>	
			Komp.Nr. 505137/31	06.03-12.08	TNK	6	<b>0 432 193 459</b>	
3346 [MP2]	12,0	335	OM 541... <501 LA Euro3>					
			Komp.Nr. 505137/27	06.03-12.08	TNK	6	<b>0 432 191 348</b>	







◀ MERCEDES-BENZ

<b>3350</b> [MP2]	15,9	370	OM 542.940 <502 LA Euro3>					
			Fg.-Nr. 505137 /26	04.03-12.08	TNK	8	<b>0 432 191 347</b>	
			Komp.Nr. 505126/ 02	04.03-12.08	TNK	8	<b>0 432 191 589</b>	
			Komp.Nr. 505134/04	04.03-12.08	TNK	8	<b>0 432 191 446</b>	
			Komp.Nr. 505137 /28	04.03-12.08		8	<b>0 432 191 348</b>	
			Komp.Nr. 505137/06	04.03-12.08	TNK	8	<b>0 432 191 459</b>	
			Komp.Nr. 505137/11	04.03-12.08	TNK	8	<b>0 432 191 384</b>	
			OM 542.941 <502 LA Euro3>					
			Fg.-Nr. 505137 /26	04.03-12.08	TNK	8	<b>0 432 191 347</b>	
			Komp.Nr. 505126/ 02	04.03-12.08	TNK	8	<b>0 432 191 589</b>	
Komp.Nr. 505137 /28	04.03-12.08		8	<b>0 432 191 348</b>				
Komp.Nr. 505137/04	04.03-12.08	TNK	8	<b>0 432 191 446</b>				
Komp.Nr. 505137/06	04.03-12.08	TNK	8	<b>0 432 191 459</b>				
Komp.Nr. 505137/11	04.03-12.08	TNK	8	<b>0 432 191 384</b>				
<b>3354</b> [MP2]	15,9	395	OM 542.942 <502 LA Euro3>					
			Komp.Nr. 505126/ 02	04.03-12.08	TNK	8	<b>0 432 191 589</b>	
			Komp.Nr. 505137/04	04.03-12.08	TNK	8	<b>0 432 191 446</b>	
			Komp.Nr. 505137/06	04.03-12.08	TNK	8	<b>0 432 191 459</b>	
Komp.Nr. 505137/11	04.03-12.08	TNK	8	<b>0 432 191 384</b>				
<b>3358</b> [MP2]	15,9	425	OM 542.944 <502 LA Euro3>					
			Komp.Nr. 505126/ 02	04.03-12.08	TNK	8	<b>0 432 191 589</b>	
			Komp.Nr. 505137 /28	04.03-12.08		8	<b>0 432 191 348</b>	
			Komp.Nr. 505137/04	04.03-12.08	TNK	8	<b>0 432 191 446</b>	
			Komp.Nr. 505137/06	04.03-12.08	TNK	8	<b>0 432 191 459</b>	
Komp.Nr. 505137/11	04.03-12.08	TNK	8	<b>0 432 191 384</b>				
<b>4141</b> [MP2]	12,0	300	OM 541.944 <501 LA Euro3>					
			Komp.Nr. 505126/ 01	04.03-12.08	TNK	6	<b>0 432 191 589</b>	
			Komp.Nr. 505137 /03	04.03-12.08	TNK	6	<b>0 432 191 446</b>	
			Komp.Nr. 505137/03	04.03-12.08	TNK	6	<b>0 432 191 446</b>	
			Komp.Nr. 505137/10	04.03-12.08	TNK	6	<b>0 432 191 384</b>	
			Komp.Nr. 505137/27	04.03-12.08	TNK	6	<b>0 432 191 348</b>	
Komp.Nr. 505137/31	04.03-12.08	TNK	6	<b>0 432 193 459</b>				
<b>4144</b> [MP2]	12,0	320	OM 541.946 <501 LA Euro3>					
			Komp.Nr. 505126/ 01	06.03-12.08	TNK	6	<b>0 432 191 589</b>	
			Komp.Nr. 505137/03	06.03-12.08	TNK	6	<b>0 432 191 446</b>	
			Komp.Nr. 505137/10	06.03-12.08	TNK	6	<b>0 432 191 384</b>	
			Komp.Nr. 505137/27	06.03-12.08	TNK	6	<b>0 432 191 348</b>	
Komp.Nr. 505137/31	06.03-12.08	TNK	6	<b>0 432 193 459</b>				
<b>4146</b> [MP2]	12,0	335	OM 541... <501 LA Euro3>					
Komp.Nr. 505137/27	04.03-12.08	TNK	6	<b>0 432 191 348</b>				
<b>4150</b> [MP2]	15,9	370	OM 542.94... <502 LA Euro3>					
			Fg.-Nr. 505137 /26	04.03-12.08	TNK	8	<b>0 432 191 347</b>	
			Komp.Nr. 505126/ 02	04.03-12.08	TNK	8	<b>0 432 191 589</b>	
			Komp.Nr. 505134/04	04.03-12.08	TNK	8	<b>0 432 191 446</b>	
			Komp.Nr. 505137 /28	04.03-12.08		8	<b>0 432 191 348</b>	
			Komp.Nr. 505137/06	04.03-12.08	TNK	8	<b>0 432 191 459</b>	
Komp.Nr. 505137/11	04.03-12.08	TNK	8	<b>0 432 191 384</b>				
<b>Actros III</b>								
<b>2031</b> [MP3]	12,0	230	OM 541.920 <(501)LA Euro2>					
			Komp.Nr. 505126/01/02	09.08→	TNK	6	<b>0 432 191 589</b>	
			Komp.Nr. 505137/01/02					
Komp.Nr. 505137/31	09.08→	TNK	6	<b>0 432 193 459</b>				
<b>2040 S</b> [MP3]	12,0	290	OM 541.923 <(501)LA Euro2>					
			Komp.Nr. 505126/01/02	09.08→	TNK	6	<b>0 432 191 589</b>	
			Komp.Nr. 505137/01/02					
			Komp.Nr. 505137/07/18	09.08→	TNK	6	<b>0 432 193 459</b>	
Komp.Nr. 505137/31								
<b>3340 S</b> [MP3]	12,0	290	OM 541.923 <(501)LA Euro2>					
			Komp.Nr. 505126/01/02	09.08→	TNK	6	<b>0 432 191 589</b>	
			Komp.Nr. 505137/01/02					
			Komp.Nr. 505137/07/18	09.08→	TNK	6	<b>0 432 193 459</b>	
Komp.Nr. 505137/31								







<b>4040 K</b> [MP3]	12,0	290	OM 541.923 <(501)LA Euro2>					
			Komp.Nr. 505126/01/02	09.08→	TNK	6	<b>0 432 191 589</b>	
			Komp.Nr. 505137/01/02					
			Komp.Nr. 505137/07/18	09.08→	TNK	6	<b>0 432 193 459</b>	
<b>4140 B</b> [MP3]	12,0	290	OM 541.923 <(501)LA Euro2>					
			Komp.Nr. 505126/01/02	09.08→	TNK	6	<b>0 432 191 589</b>	
			Komp.Nr. 505137/01/02					
			Komp.Nr. 505137/07/18	09.08→	TNK	6	<b>0 432 193 459</b>	
<b>4440 B</b> [MP3]	12,0	290	OM 541.923 <(501)LA Euro2>					
			Komp.Nr. 505126/01/02	09.08→	TNK	6	<b>0 432 191 589</b>	
			Komp.Nr. 505137/01/02					
			Komp.Nr. 505137/07/18	09.08→	TNK	6	<b>0 432 193 459</b>	
<b>Atego</b>								
<b>712</b> [LKN]	4,3	90	OM 904.909 LA <Euro2>					
			Mot.-Nr. →..022247	01.98-09.04		4	<b>0 432 193 480</b>	
			Mot.-Nr. ..022248→	01.98-09.04		4	<b>0 432 191 526</b>	
			OM 904.915 LA <Euro 3>					
			Komp.Nr. 505047/20	09.00-09.04	TNK	4	<b>0 432 191 394</b>	
			Mot.-Nr. →..022247	09.00-09.04	TNK	4	<b>0 432 193 480</b>	
			Komp.Nr. 505047 05/09/11					
			Mot.-Nr. ..022248→	09.00-09.04	TNK	4	<b>0 432 191 526</b>	
<b>714</b> [LKN]	4,3	100	OM 904.916 LA <Euro 3>					
			Komp.Nr. 505047/05	09.00-09.04	TNK	4	<b>0 432 193 480</b>	
			Komp.Nr. 505047/09					
			Komp.Nr. 505047/10					
			Komp.Nr. 505047/09	09.00-09.04	TNK	4	<b>0 432 191 526</b>	
			Komp.Nr. 505047/11					
, L [LKN]	4,3	100	OM 904.910 LA <Euro2>					
			Mot.-Nr. →..022247	01.98-09.04		4	<b>0 432 193 480</b>	
			Mot.-Nr. ..022248→	01.98-09.04		4	<b>0 432 191 526</b>	
<b>715</b> [LKN]	4,3	110	OM 904.950 LA <Euro 3>					
			Mot.-Nr. →..022247	09.00-09.04	TNK	4	<b>0 432 191 394</b>	
			Komp.Nr. 505047 05/09/11					
			Mot.-Nr. ..022248→	09.00-09.04	TNK	4	<b>0 432 191 526</b>	
			Komp.Nr. 505047 05/09/11					
, L [LKN]	4,3	112	OM 904.922 LA <Euro2>					
			Mot.-Nr. →..022247	01.98-09.04		4	<b>0 432 193 480</b>	
			Mot.-Nr. ..022248→	01.98-09.04		4	<b>0 432 191 526</b>	
<b>717</b> [LKN]	4,3	125	OM 904.917 LA <Euro 3>					
			Komp.Nr. 505047/20	09.00-09.04	TNK	4	<b>0 432 191 394</b>	
			Mot.-Nr. →..022247	09.00-09.04	TNK	4	<b>0 432 193 480</b>	
			Komp.Nr. 505047 05/09/11					
			Mot.-Nr. ..022248→	09.00-09.04	TNK	4	<b>0 432 191 526</b>	
, L [LKN]	4,3	125	OM 904.911 LA <Euro2>					
			Mot.-Nr. →..022247	01.98-09.04		4	<b>0 432 193 480</b>	
			Mot.-Nr. ..022248→	01.98-09.04		4	<b>0 432 191 526</b>	
<b>812</b> [LKN]	4,3	90	OM 904.909 LA <Euro2>					
			Mot.-Nr. →..022247	01.98-10.04		4	<b>0 432 193 480</b>	
			Mot.-Nr. ..022248→	01.98-10.04		4	<b>0 432 191 526</b>	
<b>814</b> [LKN]	4,3	100	OM 904.916 LA <Euro 3>					
			Komp.Nr. 505047/05	09.00-09.04	TNK	4	<b>0 432 193 480</b>	
			Komp.Nr. 505047/09					
			Komp.Nr. 505047/10					
			Komp.Nr. 505047/09	09.00-09.04	TNK	4	<b>0 432 191 526</b>	
			Komp.Nr. 505047/11					
	4,3	100	Komp.Nr. 505047/20	09.00-09.04	TNK	4	<b>0 432 191 394</b>	





◀ MERCEDES-BENZ

<b>814</b> , L [LKN]	4,3	100	OM 904.910 LA <Euro2> Mot.-Nr. →..022247 Mot.-Nr. ..022248→	01.98-09.04 01.98-09.04	4 4	<b>0 432 193 480</b> <b>0 432 191 526</b>
<b>815</b> [LKN]	4,3	110	OM 904.950 LA <Euro 3> Mot.-Nr. →..022247 Komp.Nr. 505047 05/09/11 Mot.-Nr. ..022248→ Komp.Nr. 505047 05/09/11	09.00-09.04 09.00-09.04 TNK 09.00-09.04 TNK	4 4 4	<b>0 432 191 394</b> <b>0 432 193 480</b> <b>0 432 191 526</b>
, F, L [LKN]	4,3	112	OM 904.922 LA <Euro2> Mot.-Nr. →..022247 Mot.-Nr. ..022248→	01.98-09.04 01.98-09.04	4 4	<b>0 432 193 480</b> <b>0 432 191 526</b>
<b>817</b> [LKN]	4,3	125	OM 904.917 LA <Euro 3> Komp.Nr. 505047/ 16 Mot.-Nr. →..022247 Komp.Nr. 505047 05/09/11 Mot.-Nr. ..022248→ Komp.Nr. 505047 05/09/11	01.98-09.04 TNK 01.98-09.04 TNK 01.98-09.04 TNK	4 4 4	<b>0 432 193 438</b> <b>0 432 193 480</b> <b>0 432 191 526</b>
, L [LKN]	4,3	125	OM 904.911 LA <Euro2> Mot.-Nr. →..022247 Mot.-Nr. ..022248→	01.98-09.04 01.98-09.04	4 4	<b>0 432 193 480</b> <b>0 432 191 526</b>
F [LKN]	4,3	112	OM 904.922 LA <Euro2> Mot.-Nr. →..022247 Mot.-Nr. ..022248→	01.98-09.04 01.98-09.04	4 4	<b>0 432 193 480</b> <b>0 432 191 526</b>
<b>818</b> [LKN]	4,3	130	OM 904.951 LA <Euro 3>	09.00-09.04	4	<b>0 432 193 438</b>
<b>823</b> [LKN]	6,4	170	OM 906.925 LA <Euro 3> Komp.Nr. 505047/21 Komp.Nr. 505074 /12/15 Mot.-Nr. →..022247 Mot.-Nr. ..022248→..056812 Mot.-Nr. ..056813→	09.00-09.04 TNK 09.00-09.04 TNK 09.00-09.04 09.00-09.04 09.00-09.04	6 6 6 6 6	<b>0 432 191 301</b> <b>0 432 193 481</b> <b>0 432 193 480</b> <b>0 432 191 526</b> <b>0 432 191 278</b>
, L [LKN]	6,4	170	OM 906.910 LA <Euro2> Komp.Nr. 505074 /12/15 Mot.-Nr. →..022247 Mot.-Nr. ..022248→..056812 Mot.-Nr. ..056813→	01.98-09.04 TNK 01.98-09.04 01.98-09.04 01.98-09.04	6 6 6 6	<b>0 432 193 481</b> <b>0 432 193 480</b> <b>0 432 191 526</b> <b>0 432 191 278</b>
<b>915</b> [LKN]	4,3	110	OM 904.950 LA <Euro 3> Mot.-Nr. →..022247 Komp.Nr. 505047 05/09/11 Mot.-Nr. ..022248→ Komp.Nr. 505047 05/09/11	09.00-09.04 09.00-09.04 TNK 09.00-09.04 TNK	4 4 4	<b>0 432 191 394</b> <b>0 432 193 480</b> <b>0 432 191 526</b>
<b>917</b> [LKN]	4,3	125-128	OM 904... <Euro 3>	01.98-09.04 TW	4 4 4	<b>0 432 191 526</b> <b>0 432 193 438</b> <b>0 432 193 480</b>
, AF, KO, L [LKN]	4,3	125	OM 904.911 LA <Euro2> Mot.-Nr. →..022247 Mot.-Nr. ..022248→	01.98-09.04 01.98-09.04	4 4	<b>0 432 193 480</b> <b>0 432 191 526</b>
<b>918</b> [LKN]	4,3	130	OM 904.951 LA <Euro 3>	09.00-09.04	4	<b>0 432 193 438</b>
<b>923</b> [LKN]	6,4	170	OM 906.925 LA <Euro 3> Komp.Nr. 505047/21 Komp.Nr. 505074 /12/15 Mot.-Nr. →..022247 Mot.-Nr. ..022248→..056812 Mot.-Nr. ..056813→	09.00-09.04 TNK 09.00-09.04 TNK 09.00-09.04 09.00-09.04 09.00-09.04	6 6 6 6 6	<b>0 432 191 301</b> <b>0 432 193 481</b> <b>0 432 193 480</b> <b>0 432 191 526</b> <b>0 432 191 278</b>
, L [LKN]	6,4	170	OM 906.910 LA <Euro2> Komp.Nr. 505074 /12/15 Mot.-Nr. →..022247 Mot.-Nr. ..022248→..056812 Mot.-Nr. ..056813→	01.98-09.04 TNK 01.98-09.04 01.98-09.04 01.98-09.04	6 6 6 6	<b>0 432 193 481</b> <b>0 432 193 480</b> <b>0 432 191 526</b> <b>0 432 191 278</b>





<b>925 AF</b> [LKN]	6,4	180	OM 906... <Euro 2/3> Komp.Nr. 505074 /12/15 Mot.-Typ 906.919	01.98-09.04	TNK	6	<b>0 432 193 481</b>
			Mot.-Nr. →..022247 Mot.-Typ 906.919	01.98-09.04		6	<b>0 432 193 480</b>
			Mot.-Nr. ..022248→..056812 Mot.-Typ 906.919	01.98-09.04		6	<b>0 432 191 526</b>
			Mot.-Nr. ..056813→ Mot.-Typ 906.919 Mot.-Typ 906.939	01.98-09.04		6	<b>0 432 191 278</b> <b>0 432 191 301</b>
<b>1015</b> [LKN]	4,3	110	OM 904.950 LA <Euro 3> Mot.-Nr. →..022247 Komp.Nr. 505047 05/09/11	09.00-09.04	TNK	4	<b>0 432 191 394</b> <b>0 432 193 480</b>
			Mot.-Nr. ..022248→ Komp.Nr. 505047 05/09/11	09.00-09.04	TNK	4	<b>0 432 191 526</b>
<b>1017</b>	4,3	125	OM 904.951 LA <Euro 3>	09.00→		4	<b>0 432 191 396</b>
[LKN]	4,3	125	OM 904.917 LA <Euro 3> Komp.Nr. 505047/ 16 Mot.-Nr. →..022247 Komp.Nr. 505047 05/09/11	01.98-09.04	TNK	4	<b>0 432 193 438</b> <b>0 432 193 480</b>
			Mot.-Nr. ..022248→ Komp.Nr. 505047 05/09/11	01.98-09.04	TNK	4	<b>0 432 191 526</b>
, A, AK, KO, L [LKN]	4,3	125	OM 904.911 LA <Euro2> Mot.-Nr. →..022247 Mot.-Nr. ..022248→	01.98-09.04		4	<b>0 432 193 480</b> <b>0 432 191 526</b>
<b>1018</b> [LKN]	4,3	130	OM 904.951 LA <Euro 3>	09.00-09.04		4	<b>0 432 193 438</b>
<b>1023</b> [LKN]	6,4	170	OM 906.925 LA <Euro 3> Komp.Nr. 505047/21 Komp.Nr. 505074 /12/15 Mot.-Nr. →..022247 Mot.-Nr. ..022248→..056812 Mot.-Nr. ..056813→	09.00-09.04	TNK	6	<b>0 432 191 301</b> <b>0 432 193 481</b> <b>0 432 193 480</b> <b>0 432 191 526</b> <b>0 432 191 278</b>
, L [LKN]	6,4	170	OM 906.910 LA <Euro2> Komp.Nr. 505074 /12/15 Mot.-Nr. →..022247 Mot.-Nr. ..022248→..056812 Mot.-Nr. ..056813→	01.98-09.04	TNK	6	<b>0 432 193 481</b> <b>0 432 193 480</b> <b>0 432 191 526</b> <b>0 432 191 278</b>
<b>1214</b> , L [LKN]	4,3	100	OM 904.910 LA <Euro2> Mot.-Nr. →..022247 Mot.-Nr. ..022248→	01.98-09.04		4	<b>0 432 193 480</b> <b>0 432 191 526</b>
<b>1215</b> [LKN]	4,3	110	OM 904.950 LA <Euro 3> Mot.-Nr. →..022247 Komp.Nr. 505047 05/09/11 Mot.-Nr. ..022248→ Komp.Nr. 505047 05/09/11	09.00-09.04	TNK	4	<b>0 432 191 394</b> <b>0 432 193 480</b> <b>0 432 191 526</b> <b>0 432 191 526</b>
, L [LKN]	4,3	112	OM 904.922 LA <Euro2> Mot.-Nr. →..022247 Mot.-Nr. ..022248→	01.98-09.04		4	<b>0 432 193 480</b> <b>0 432 191 526</b>
<b>1217</b> [LKN]	4,3	125	OM 904.917 LA <Euro 3> Komp.Nr. 505047/ 16 Mot.-Nr. →..022247 Komp.Nr. 505047 05/09/11 Mot.-Nr. ..022248→ Komp.Nr. 505047 05/09/11	01.98-09.04	TNK	4	<b>0 432 193 438</b> <b>0 432 193 480</b> <b>0 432 191 526</b> <b>0 432 191 526</b>
, KO, L [LKN]	4,3	125	OM 904.911 LA <Euro2> Mot.-Nr. →..022247 Mot.-Nr. ..022248→	01.98-09.04		4	<b>0 432 193 480</b> <b>0 432 191 526</b>
<b>1218</b> [LKN]	4,3	130	OM 904.951 LA <Euro 3>	09.00-09.04		4	<b>0 432 193 438</b>
<b>1223</b> [LKN]	6,4	170	OM 906.925 LA <Euro 3> Komp.Nr. 505047/21 Komp.Nr. 505074 /12/15 Mot.-Nr. →..022247 Mot.-Nr. ..022248→..056812 Mot.-Nr. ..056813→	09.00-09.04	TNK	6	<b>0 432 191 301</b> <b>0 432 193 481</b> <b>0 432 193 480</b> <b>0 432 191 526</b> <b>0 432 191 278</b>





◀ MERCEDES-BENZ

<b>1223</b> , L [LKN]	6,4	170	OM 906.910 LA <Euro2>				
			Komp.Nr. 505074/12/15	01.98-09.04	TNK	6	<b>0 432 193 481</b>
			Mot.-Nr. →..022247	01.98-09.04		6	<b>0 432 193 480</b>
			Mot.-Nr. ..022248→..056812	01.98-09.04		6	<b>0 432 191 526</b>
			Mot.-Nr. ..056813→	01.98-09.04		6	<b>0 432 191 278</b>
<b>1225</b> AF, F [LKN]	6,4	180	OM 906... <Euro 2/3>				
			Komp.Nr. 505074/12/15	01.98-09.04	TNK	6	<b>0 432 193 481</b>
			Mot.-Typ 906.919				
			Mot.-Nr. →..022247	01.98-09.04	TW	6	<b>0 432 191 554</b>
			Mot.-Nr. →..022247	01.98-09.04		6	<b>0 432 193 480</b>
			Mot.-Typ 906.919				
			Mot.-Nr. ..022248→..056812	01.98-09.04		6	<b>0 432 191 526</b>
			Mot.-Typ 906.919				
<b>1228</b> [LKN]	6,4	205	OM 906.926 LA <Euro3>				
			Komp.Nr. 505047/17	09.00-10.04	TNK	6	<b>0 432 191 302</b>
			Komp.Nr. 505047/21	09.00-10.04	TNK	6	<b>0 432 191 301</b>
			Komp.Nr. 505074/12/15	09.00-10.04	TNK	6	<b>0 432 193 481</b>
			Mot.-Nr. →..022247	09.00-10.04		6	<b>0 432 193 480</b>
			Mot.-Nr. ..022248→..056812	09.00-10.04		6	<b>0 432 191 526</b>
			Mot.-Nr. ..056813→	09.00-10.04		6	<b>0 432 191 278</b>
, L [LKN]	6,4	205	OM 906.911 LA <Euro2>				
			Komp.Nr. 505074/12/15	01.98-09.04	TNK	6	<b>0 432 193 481</b>
			Mot.-Nr. →..022247	01.98-09.04		6	<b>0 432 193 480</b>
			Mot.-Nr. ..022248→..056812	01.98-09.04		6	<b>0 432 191 526</b>
			Mot.-Nr. ..056813→	01.98-09.04		6	<b>0 432 191 278</b>
<b>1317</b> [LKN]	4,3	125	OM 904.917 LA <Euro 3>				
			Komp.Nr. 505047/16	01.98-09.04	TNK	4	<b>0 432 193 438</b>
			Mot.-Nr. →..022247	01.98-09.04	TNK	4	<b>0 432 193 480</b>
			Komp.Nr. 505047 05/09/11				
			Mot.-Nr. ..022248→	01.98-09.04	TNK	4	<b>0 432 191 526</b>
, A, AK, KO, L [LKN]	4,3	125	OM 904.911 LA <Euro2>				
			Mot.-Nr. →..022247	01.98→		4	<b>0 432 193 480</b>
			Mot.-Nr. ..022248→	01.98-09.04		4	<b>0 432 191 526</b>
<b>1318</b> [LKN]	4,3	130	OM 904.951 LA <Euro 3>	09.00-09.04		4	<b>0 432 193 438</b>
<b>1323</b> , L, LKO [LKN]	6,4	170	OM 906.910 LA <Euro2>				
			Komp.Nr. 505074/12/15	01.98-09.04	TNK	6	<b>0 432 193 481</b>
			Mot.-Nr. →..022247	01.98-09.04		6	<b>0 432 193 480</b>
			Mot.-Nr. ..022248→..056812	01.98-09.04		6	<b>0 432 191 526</b>
			Mot.-Nr. ..056813→	01.98-09.04		6	<b>0 432 191 278</b>
<b>1325</b> AF, F [LKN]	6,4	180	OM 906... <Euro 2/3>				
			Komp.Nr. 505074/12/15	01.98-09.04	TNK	6	<b>0 432 193 481</b>
			Mot.-Typ 906.919				
			Mot.-Nr. →..022247	01.98-09.04	TW	6	<b>0 432 191 554</b>
			Mot.-Nr. →..022247	01.98-09.04		6	<b>0 432 193 480</b>
			Mot.-Typ 906.919				
			Mot.-Nr. ..022248→..056812	01.98-09.04		6	<b>0 432 191 526</b>
			Mot.-Typ 906.919				
<b>1328</b> [LKN]	6,4	205	OM 906.926 LA <Euro3>				
			Komp.Nr. 505047/17	09.00-09.04	TNK	6	<b>0 432 191 302</b>
			Komp.Nr. 505047/21	09.00-09.04	TNK	6	<b>0 432 191 301</b>
			Komp.Nr. 505074/12/15	09.00-09.04	TNK	6	<b>0 432 193 481</b>
			Mot.-Nr. →..022247	09.00-09.04		6	<b>0 432 193 480</b>
			Mot.-Nr. ..022248→..056812	09.00-09.04		6	<b>0 432 191 526</b>
			Mot.-Nr. ..056813→	09.00-09.04		6	<b>0 432 191 278</b>





<b>1328</b> , AF, F, L [LKN]	6,4	205	OM 906.911 LA <Euro2>					
			Komp.Nr. 505074 /12/15	01.98-09.04	TNK	6	<b>0 432 193 481</b>	
			Mot.-Nr. →..022247	01.98-09.04		6	<b>0 432 193 480</b>	
			Mot.-Nr. ..022248→..056812	01.98-09.04		6	<b>0 432 191 526</b>	
			Mot.-Nr. ..056813→	01.98-09.04		6	<b>0 432 191 278</b>	
<b>1517</b> [LKN]	4,3	125	OM 904.917 LA <Euro 3>					
			Komp.Nr. 505047/ 16	01.98-09.04	TNK	4	<b>0 432 193 438</b>	
			Mot.-Nr. →..022247	01.98-09.04	TNK	4	<b>0 432 193 480</b>	
			Komp.Nr. 505047 05/09/11					
			Mot.-Nr. ..022248→	01.98-09.04	TNK	4	<b>0 432 191 526</b>	
			Komp.Nr. 505047 05/09/11					
, L [LKN]	4,3	125	OM 904.911 LA <Euro2>					
			Mot.-Nr. →..022247	01.98-09.04		4	<b>0 432 193 480</b>	
			Mot.-Nr. ..022248→	01.98-09.04		4	<b>0 432 191 526</b>	
<b>1518</b> [LKN]	4,3	130	OM 904.951 LA <Euro 3>	09.00-09.04		4	<b>0 432 193 438</b>	
<b>1523</b> [LKN]	6,4	170	OM 906.925 LA <Euro 3>					
			Komp.Nr. 505047/21	09.00-10.04	TNK	6	<b>0 432 191 301</b>	
			Komp.Nr. 505074 /12/15	09.00-10.04	TNK	6	<b>0 432 193 481</b>	
			Mot.-Nr. →..022247	09.00-10.04		6	<b>0 432 193 480</b>	
			Mot.-Nr. ..022248→..056812	09.00-10.04		6	<b>0 432 191 526</b>	
			Mot.-Nr. ..056813→	09.00-10.04		6	<b>0 432 191 278</b>	
, A, AK, KO, L [LKN]	6,4	170	OM 906.910 LA <Euro2>					
			Komp.Nr. 505074 /12/15	01.98-09.04	TNK	6	<b>0 432 193 481</b>	
			Mot.-Nr. →..022247	01.98-09.04		6	<b>0 432 193 480</b>	
			Mot.-Nr. ..022248→..056812	01.98-09.04		6	<b>0 432 191 526</b>	
			Mot.-Nr. ..056813→	01.98-09.04		6	<b>0 432 191 278</b>	
<b>1525</b> AF [LKN]	6,4	180	OM 906... <Euro 2/3>					
			Komp.Nr. 505074 /12/15	01.98-09.04	TNK	6	<b>0 432 193 481</b>	
			Mot.-Typ 906.919					
			Mot.-Nr. →..022247	01.98-09.04		6	<b>0 432 193 480</b>	
			Mot.-Typ 906.919					
			Mot.-Nr. ..022248→..056812	01.98-09.04		6	<b>0 432 191 526</b>	
			Mot.-Typ 906.919					
			Mot.-Nr. ..056813→	01.98-09.04		6	<b>0 432 191 278</b>	
			Mot.-Typ 906.919					
			Mot.-Typ 906.939	01.98-09.04		6	<b>0 432 191 301</b>	
<b>1528</b> [LKN]	6,4	205	OM 906.926 LA <Euro3>					
			Komp.Nr. 505047/17	09.00-09.04	TNK	6	<b>0 432 191 302</b>	
			Komp.Nr. 505047/21	09.00-09.04	TNK	6	<b>0 432 191 301</b>	
			Komp.Nr. 505074 /12/15	09.00-09.04	TNK	6	<b>0 432 193 481</b>	
			Mot.-Nr. →..022247	09.00-09.04		6	<b>0 432 193 480</b>	
			Mot.-Nr. ..022248→..056812	09.00-09.04		6	<b>0 432 191 526</b>	
			Mot.-Nr. ..056813→	09.00-09.04		6	<b>0 432 191 278</b>	
, AF, F, L [LKN]	6,4	205	OM 906.911 LA <Euro2>					
			Komp.Nr. 505074 /12/15	01.98-09.04	TNK	6	<b>0 432 193 481</b>	
			Mot.-Nr. →..022247	01.98-09.04		6	<b>0 432 193 480</b>	
			Mot.-Nr. ..022248→..056812	01.98-09.04		6	<b>0 432 191 526</b>	
			Mot.-Nr. ..056813→	01.98-09.04		6	<b>0 432 191 278</b>	
<b>1823</b> [LKN]	6,4	170	OM 906.925 LA <Euro 3>					
			Komp.Nr. 505047/21	09.00-09.04	TNK	6	<b>0 432 191 301</b>	
			Komp.Nr. 505074 /12/15	09.00-09.04	TNK	6	<b>0 432 193 481</b>	
			Mot.-Nr. →..022247	09.00-09.04		6	<b>0 432 193 480</b>	
			Mot.-Nr. ..022248→..056812	09.00-09.04		6	<b>0 432 191 526</b>	
			Mot.-Nr. ..056813→	09.00-09.04		6	<b>0 432 191 278</b>	
, K, L, LS [LKN]	6,4	170	OM 906.920 LA <Euro2>					
			Komp.Nr. 505074 /12/15	05.98-09.04	TNK	6	<b>0 432 193 481</b>	
			Mot.-Nr. →..022247	05.98-09.04		6	<b>0 432 193 480</b>	
			Mot.-Nr. ..022248→..056812	05.98-09.04		6	<b>0 432 191 526</b>	
			Mot.-Nr. ..056813→	05.98-09.04		6	<b>0 432 191 278</b>	





◀ MERCEDES-BENZ

<b>1823 AK</b> [LKN]	6,4	170	OM 906.922 LA <Euro2>					
			Komp.Nr. 505074/12/15	05.98-09.04	TNK	6	<b>0 432 193 481</b>	
			Mot.-Nr. →..022247	05.98-09.04		6	<b>0 432 193 480</b>	
			Mot.-Nr. ..022248→..056812	05.98-09.04		6	<b>0 432 191 526</b>	
			Mot.-Nr. ..056813→	05.98-09.04		6	<b>0 432 191 278</b>	
<b>1828</b> [LKN]	6,4	205	OM 906.926 LA <Euro3>					
			Komp.Nr. 505047/17	09.00-09.04	TNK	6	<b>0 432 191 302</b>	
			Komp.Nr. 505047/21	09.00-09.04	TNK	6	<b>0 432 191 301</b>	
			Komp.Nr. 505074/12/15	09.00-09.04	TNK	6	<b>0 432 193 481</b>	
			Mot.-Nr. →..022247	09.00-09.04		6	<b>0 432 193 480</b>	
			Mot.-Nr. ..022248→..056812	09.00-09.04		6	<b>0 432 191 526</b>	
			Mot.-Nr. ..056813→	09.00-09.04		6	<b>0 432 191 278</b>	
, K, L, LS [LKN]	6,4	205	OM 906.921 LA <Euro2>					
			Komp.Nr. 505074/12/15	05.98-09.04	TNK	6	<b>0 432 193 481</b>	
			Mot.-Nr. →..022247	05.98-09.04		6	<b>0 432 193 480</b>	
			Mot.-Nr. ..022248→..056812	05.98-09.04		6	<b>0 432 191 526</b>	
			Mot.-Nr. ..056813→	05.98-09.04		6	<b>0 432 191 278</b>	
A, AK [LKN]	6,4	205	OM 906.923 LA <Euro2>					
			Komp.Nr. 505074/12	05.98-09.04	TNK	6	<b>0 432 193 481</b>	
			Komp.Nr. 505074/15					
			Komp.Nr. 505047/06					
			Mot.-Nr. →..022247	05.98-09.04		6	<b>0 432 193 480</b>	
			Mot.-Nr. ..022248→..056812	05.98-09.04		6	<b>0 432 191 526</b>	
			Mot.-Nr. ..056813→	05.98-09.04		6	<b>0 432 191 278</b>	
<b>1833</b> [LKN]	7,2	240	OM 926.913 LA <Euro3>	09.00-09.04		6	<b>0 432 191 303</b>	
<b>2523 L</b> [LKN]	6,4	170	OM 906.920 LA <Euro2>					
			Komp.Nr. 505074/12/15	05.98-09.04	TNK	6	<b>0 432 193 481</b>	
			Mot.-Nr. →..022247	05.98-09.04		6	<b>0 432 193 480</b>	
			Mot.-Nr. ..022248→..056812	05.98-09.04		6	<b>0 432 191 526</b>	
			Mot.-Nr. ..056813→	05.98-09.04		6	<b>0 432 191 278</b>	
<b>2528</b> [LKN]	6,4	205	OM 906.926 LA <Euro3>					
			Komp.Nr. 505047/17	09.00-09.04	TNK	6	<b>0 432 191 302</b>	
			Komp.Nr. 505047/21	09.00-09.04	TNK	6	<b>0 432 191 301</b>	
			Komp.Nr. 505074/12/15	09.00-09.04	TNK	6	<b>0 432 193 481</b>	
			Mot.-Nr. →..022247	09.00-09.04		6	<b>0 432 193 480</b>	
			Mot.-Nr. ..022248→..056812	09.00-09.04		6	<b>0 432 191 526</b>	
			Mot.-Nr. ..056813→	09.00-09.04		6	<b>0 432 191 278</b>	
L [LKN]	6,4	205	OM 906.921 LA <Euro2>					
			Komp.Nr. 505074/12/15	05.98-09.04	TNK	6	<b>0 432 193 481</b>	
			Mot.-Nr. →..022247	05.98-09.04		6	<b>0 432 193 480</b>	
			Mot.-Nr. ..022248→..056812	05.98-09.04		6	<b>0 432 191 526</b>	
			Mot.-Nr. ..056813→	05.98-09.04		6	<b>0 432 191 278</b>	
<b>2533</b> [LKN]	7,2	240	OM 926.913 LA <Euro3>	09.00-09.04		6	<b>0 432 191 303</b>	
<b>2628</b> [LKN]	6,4	205	OM 906.926 LA <Euro3>					
			Komp.Nr. 505047/17	09.00-09.04	TNK	6	<b>0 432 191 302</b>	
			Komp.Nr. 505047/21	09.00-09.04	TNK	6	<b>0 432 191 301</b>	
			Komp.Nr. 505074/12/15	09.00-09.04	TNK	6	<b>0 432 193 481</b>	
			Mot.-Nr. →..022247	09.00-09.04		6	<b>0 432 193 480</b>	
			Mot.-Nr. ..022248→..056812	09.00-09.04		6	<b>0 432 191 526</b>	
			Mot.-Nr. ..056813→	09.00-09.04		6	<b>0 432 191 278</b>	
, B, K [LKN]	6,4	205	OM 906.921 LA <Euro2>					
			Komp.Nr. 505074/12/15	05.98-09.04	TNK	6	<b>0 432 193 481</b>	
			Mot.-Nr. →..022247	05.98-09.04		6	<b>0 432 193 480</b>	
			Mot.-Nr. ..022248→..056812	05.98-09.04		6	<b>0 432 191 526</b>	
			Mot.-Nr. ..056813→	05.98-09.04		6	<b>0 432 191 278</b>	
<b>2633</b> [LKN]	7,2	240	OM 926.913 LA <Euro3>	09.00-09.04		6	<b>0 432 191 303</b>	





Atego II							
712	4,3	90	OM 904.9... <Euro2>				
			Mot.-Nr. →..022247	10.04→	TW	4	0 432 193 480
			Mot.-Typ 904.909				
			Mot.-Typ 904.915				
715	4,3	112	OM 904.922 LA <Euro2>	10.04→	TW	4	0 432 191 526
			Mot.-Nr. →..022248→	10.04→	TW	4	0 432 191 526
			Mot.-Typ 904.909				
			Mot.-Typ 904.915	10.04→	TW	4	0 432 191 394
812	4,3	90	OM 904.9... <Euro 3>				
			Mot.-Nr. →..022247	10.04→	TW	4	0 432 193 480
			Mot.-Typ 904.909				
			Mot.-Typ 904.915				
815	4,3	112	OM 904.922 LA <Euro2>	10.04→	TW	4	0 432 191 526
			Mot.-Nr. →..022248→	10.04→	TW	4	0 432 191 526
			Mot.-Typ 904.909				
			Mot.-Typ 904.915	10.04→	TW	4	0 432 191 394
818	4,3	130	OM 904.917 LA <Euro 3>	09.04→	TW	4	0 432 191 526
			Mot.-Nr. →..022247	10.04→	TW	4	0 432 193 480
			Mot.-Typ 904.909				
			Mot.-Typ 904.915	10.04→	TW	4	0 432 191 394
822	4,8	160	OM 924.920 <Euro 3>	09.04→		4	0 432 191 303
			BlueTec				
823	4,8	160	OM 924.930 LA <Euro 5/EEV>	06.06→		4	0 432 193 421
			BlueTec				
823	6,4	170	OM 906.915 <Euro 3>	09.04→	TW	6	0 432 191 278
			Mot.-Nr. →..022247	10.04→	TW	6	0 432 191 301
			Mot.-Typ 904.909				
			Mot.-Typ 904.915	10.04→	TW	6	0 432 191 526
824 BlueTec	7,2	175	OM 925.920 <(926 LA) EU 4/5/EEV>	10.10→	TW	6	0 432 193 416
			Mot.-Nr. →..022247	10.04→	TW	6	0 432 193 480
			Mot.-Typ 904.909				
			Mot.-Typ 904.915	10.04→	TW	6	0 432 191 526
826 BlueTec	7,2	188	OM 925.920 <(926 LA) EU 4/5/EEV>	09.05→	TW	6	0 432 193 416
			Mot.-Nr. →..022247	10.04→	TW	6	0 432 193 480
			Mot.-Typ 904.909				
			Mot.-Typ 904.915	10.04→	TW	6	0 432 191 526
829	7,2	210	OM 925.920 <(926 LA) EU 4/5/EEV>	09.05→	TW	6	0 432 193 416
			Mot.-Nr. →..022247	10.04→	TW	6	0 432 193 480
			Mot.-Typ 904.909				
			Mot.-Typ 904.915	10.04→	TW	6	0 432 191 526
915	4,3	112	OM 904.922 LA <Euro2>	10.04→	TW	4	0 432 191 526
			Mot.-Nr. →..022247	10.04→	TW	4	0 432 193 480
			Mot.-Typ 904.909				
			Mot.-Typ 904.915	10.04→	TW	4	0 432 191 394
922	4,8	160	OM 924.920 <Euro 3>	09.04→		4	0 432 191 303
			BlueTec				
923	4,8	160	OM 924.930 LA <Euro 5/EEV>	06.06→		4	0 432 193 421
			BlueTec				
923	6,4	170	OM 906.915 <Euro 3>	09.04→	TW	6	0 432 191 278
			Mot.-Nr. →..022247	10.04→	TW	6	0 432 191 301
			Mot.-Typ 904.909				
			Mot.-Typ 904.915	10.04→	TW	6	0 432 191 526
924 BlueTec	7,2	175	OM 925.920 <(926 LA) EU 4/5/EEV>	09.05→	TW	6	0 432 193 416
			Mot.-Nr. →..022247	10.04→	TW	6	0 432 193 480
			Mot.-Typ 904.909				
			Mot.-Typ 904.915	10.04→	TW	6	0 432 191 526
926 BlueTec	7,2	188	OM 925.920 <(926 LA) EU 4/5/EEV>	09.05→	TW	6	0 432 193 416
			Mot.-Nr. →..022247	10.04→	TW	6	0 432 193 480
			Mot.-Typ 904.909				
			Mot.-Typ 904.915	10.04→	TW	6	0 432 191 526
929 BlueTec	7,2	210	OM 925.920 <(926 LA) EU 4/5/EEV>	09.05→	TW	6	0 432 193 416
			Mot.-Nr. →..022247	10.04→	TW	6	0 432 193 480
			Mot.-Typ 904.909				
			Mot.-Typ 904.915	10.04→	TW	6	0 432 191 526
1015	4,3	112	OM 904.922 LA <Euro2>	10.04→	TW	4	0 432 191 526
			Mot.-Nr. →..022247	10.04→	TW	4	0 432 193 480
			Mot.-Typ 904.909				
			Mot.-Typ 904.915	10.04→	TW	4	0 432 191 394
1017	4,3	125	OM 904.91... <Euro 3>	10.04→	TW	4	0 432 191 526
			Mot.-Nr. →..022247	10.04→	TW	4	0 432 193 480
			Mot.-Typ 904.909				
			Mot.-Typ 904.915	10.04→	TW	4	0 432 191 394
1022	4,8	160	OM 924.920 <Euro 3>	09.04→		4	0 432 191 303
			BlueTec				
1023	4,8	160	OM 924.930 LA <Euro 5/EEV>	06.06→		4	0 432 193 421
			BlueTec				







◀ MERCEDES-BENZ

<b>1023</b>	6,4	170	OM 906.915 <Euro 3>	09.04→	TW	6	<b>0 432 191 278</b>
						6	<b>0 432 191 301</b>
						6	<b>0 432 191 526</b>
						6	<b>0 432 193 480</b>
						6	<b>0 432 193 481</b>
<b>1024</b> BlueTec	7,2	175	OM 925.920 <(926 LA) EU 4/5/EEV>	09.05→	TW	6	<b>0 432 193 416</b>
						6	<b>0 432 193 421</b>
<b>1026</b> BlueTec	7,2	188	OM 925.920 <(926 LA) EU 4/5/EEV>	09.05→	TW	6	<b>0 432 193 416</b>
						6	<b>0 432 193 421</b>
<b>1029</b> BlueTec	7,2	210	OM 925.920 <(926 LA) EU 4/5/EEV>	09.05→	TW	6	<b>0 432 193 416</b>
						6	<b>0 432 193 421</b>
<b>1215</b>	4,3	112	OM 904.922 LA <Euro 2>	10.04→	TW	4	<b>0 432 191 526</b>
						4	<b>0 432 193 480</b>
<b>1222</b>	4,8	160	OM 924.920 <Euro 3>	09.04→		4	<b>0 432 191 303</b>
BlueTec	4,8	160	OM 924.930 LA <Euro 5/EEV>	06.06→		4	<b>0 432 193 421</b>
<b>1223</b>	6,4	170	OM 906.915 <Euro 3>	09.04→	TW	6	<b>0 432 191 278</b>
						6	<b>0 432 191 301</b>
						6	<b>0 432 191 526</b>
						6	<b>0 432 193 480</b>
						6	<b>0 432 193 481</b>
<b>1224</b> BlueTec	7,2	175	OM 925.920 <(926 LA) EU 4/5/EEV>	03.10→	TW	6	<b>0 432 193 416</b>
						6	<b>0 432 193 421</b>
<b>1226</b> BlueTec	7,2	188	OM 925.920 <(926 LA) EU 4/5/EEV>	03.10→	TW	6	<b>0 432 193 416</b>
						6	<b>0 432 193 421</b>
<b>1228</b>	6,4	205	OM 906.916 <(906) Euro 3>	09.04→	TW	6	<b>0 432 191 278</b>
						6	<b>0 432 191 302</b>
						6	<b>0 432 191 526</b>
						6	<b>0 432 193 480</b>
						6	<b>0 432 193 481</b>
<b>1229</b> BlueTec	7,2	210	OM 925.920 <(926 LA) EU 4/5/EEV>	03.10→	TW	6	<b>0 432 193 416</b>
						6	<b>0 432 193 421</b>
<b>1317</b>	4,3	125	OM 904.91... <Euro 3>	10.04→	TW	4	<b>0 432 191 526</b>
						4	<b>0 432 193 438</b>
						4	<b>0 432 193 480</b>
<b>1322</b>	4,8	160	OM 924.920 <Euro 3>	09.04→		4	<b>0 432 191 303</b>
BlueTec	4,8	160	OM 924.930 LA <Euro 5/EEV>	06.06→		4	<b>0 432 193 421</b>
<b>1323</b>	6,4	170	OM 906.915 <Euro 3>	09.04→	TW	6	<b>0 432 191 278</b>
						6	<b>0 432 191 301</b>
						6	<b>0 432 191 526</b>
						6	<b>0 432 193 480</b>
						6	<b>0 432 193 481</b>
<b>1324</b> BlueTec	7,2	175	OM 925.920 <(926 LA) EU 4/5/EEV>	03.10→	TW	6	<b>0 432 193 416</b>
						6	<b>0 432 193 421</b>
<b>1326</b> BlueTec	7,2	188	OM 925.920 <(926 LA) EU 4/5/EEV>	03.10→	TW	6	<b>0 432 193 416</b>
						6	<b>0 432 193 421</b>
<b>1328</b>	6,4	205	OM 906.916 <(906) Euro 3>	09.04→	TW	6	<b>0 432 191 278</b>
						6	<b>0 432 191 302</b>
						6	<b>0 432 191 526</b>
						6	<b>0 432 193 480</b>
						6	<b>0 432 193 481</b>
<b>1329</b> BlueTec	7,2	210	OM 925.920 <(926 LA) EU 4/5/EEV>	03.10→	TW	6	<b>0 432 193 416</b>
						6	<b>0 432 193 421</b>
<b>1422</b> F BlueTec	4,8	160	OM 924.930 LA <Euro 5/EEV>	03.10→		4	<b>0 432 193 421</b>
<b>1425</b> F	6,4	180	OM 906.939 LA <Euro 2/3>	10.04→		6	<b>0 432 191 301</b>
<b>1426</b> F BlueTec	7,2	188	OM 925.920 <(926 LA) EU 4/5/EEV>	03.10→	TW	6	<b>0 432 193 416</b>
						6	<b>0 432 193 421</b>
<b>1428</b> F	6,4	205	OM 906.916 <(906) Euro 3>	10.04→	TW	6	<b>0 432 191 278</b>
						6	<b>0 432 191 302</b>
						6	<b>0 432 191 526</b>
						6	<b>0 432 193 480</b>
						6	<b>0 432 193 481</b>
<b>1429</b> F BlueTec	7,2	210	OM 925.920 <(926 LA) EU 4/5/EEV>	03.10→	TW	6	<b>0 432 193 416</b>
						6	<b>0 432 193 421</b>





<b>1522</b>	4,8	160	OM 924.920 <Euro 3>	09.04→		4	<b>0 432 191 303</b>
BlueTec	4,8	160	OM 924.930 LA <Euro 5/EEV>	06.06→		4	<b>0 432 193 421</b>
<b>1523</b>	6,4	170	OM 906.915 <Euro 3>	09.04→	TW	6	<b>0 432 191 278</b>
						6	<b>0 432 191 301</b>
						6	<b>0 432 191 526</b>
						6	<b>0 432 193 480</b>
						6	<b>0 432 193 481</b>
<b>1524</b> BlueTec	7,2	175	OM 925.920 <(926 LA) EU 4/5/EEV>	03.10→	TW	6	<b>0 432 193 416</b>
						6	<b>0 432 193 421</b>
<b>1526</b> BlueTec	7,2	188	OM 925.920 <(926 LA) EU 4/5/EEV>	03.10→	TW	6	<b>0 432 193 416</b>
						6	<b>0 432 193 421</b>
<b>1528</b>	6,4	205	OM 906.916 <(906) Euro 3>	09.04→	TW	6	<b>0 432 191 278</b>
						6	<b>0 432 191 302</b>
						6	<b>0 432 191 526</b>
						6	<b>0 432 193 480</b>
						6	<b>0 432 193 481</b>
<b>1529</b> BlueTec	7,2	210	OM 925.920 <(926 LA) EU 4/5/EEV>	03.10→	TW	6	<b>0 432 193 416</b>
						6	<b>0 432 193 421</b>
<b>Axor</b>							
<b>1823</b>	6,4	170	OM 906... <Euro2>				
			Komp.Nr. 505047/ 21	01.02-08.06	TNK	6	<b>0 432 191 301</b>
			Komp.Nr. 505074 /12/15	01.02-08.06	TNK	6	<b>0 432 193 481</b>
			Mot.-Nr. →..022247	01.02-08.06	TNK	6	<b>0 432 193 480</b>
			Komp.Nr. 505047/ 06				
			Mot.-Nr. ..022248→..056812	01.02-08.06	TNK	6	<b>0 432 191 526</b>
			Komp.Nr. 505047/ 06				
			Mot.-Nr. ..056813→	01.02-08.06	TNK	6	<b>0 432 191 278</b>
			Komp.Nr. 505047 /06				
<b>1828</b>	6,4	205	OM 906... <Euro2>				
			Komp.Nr. 505047 /17	01.02-08.06	TNK	6	<b>0 432 191 302</b>
			Komp.Nr. 505074 /12/15	01.02-08.06	TNK	6	<b>0 432 193 481</b>
			Mot.-Nr. →..022247	01.02-08.06	TNK	6	<b>0 432 193 480</b>
			Komp.Nr. 505047/ 06				
			Mot.-Nr. ..022248→..056812	01.02-08.06	TNK	6	<b>0 432 191 526</b>
			Komp.Nr. 505047/ 06				
			Mot.-Nr. ..056813→	01.02-08.06	TNK	6	<b>0 432 191 278</b>
			Komp.Nr. 505047 /06				
<b>1835</b> LS	12,0	260	OM 457.937 LA				
			Komp.Nr. 522003/01	01.02-08.06	TNK	6	<b>0 432 191 551</b>
			Komp.Nr. 522003/02/09	01.02-08.06	TNK	6	<b>0 432 191 263</b>
			Komp.Nr. 522003/08	01.02-08.06	TNK	6	<b>0 432 191 258</b>
			Komp.Nr. 505137/25/26				
			Komp.Nr. 522003/18	01.02-08.06	TNK	6	<b>0 432 193 449</b>
<b>1840</b> LS	12,0	295	OM 457.937 LA				
			Komp.Nr. 522003/01	01.02-08.06	TNK	6	<b>0 432 191 551</b>
			Komp.Nr. 522003/02/09	01.02-08.06	TNK	6	<b>0 432 191 263</b>
			Komp.Nr. 522003/08	01.02-08.06	TNK	6	<b>0 432 191 258</b>
			Komp.Nr. 505137/25/26				
			Komp.Nr. 522003/18	01.02-08.06	TNK	6	<b>0 432 193 449</b>
<b>1843</b> LS	12,0	315	OM 457.937 LA				
			Komp.Nr. 522003/01	01.02-08.06	TNK	6	<b>0 432 191 551</b>
			Komp.Nr. 522003/02/09	01.02-08.06	TNK	6	<b>0 432 191 263</b>
			Komp.Nr. 522003/08	01.02-08.06	TNK	6	<b>0 432 191 258</b>
			Komp.Nr. 505137/25/26				
			Komp.Nr. 522003/18	01.02-08.06	TNK	6	<b>0 432 193 449</b>
<b>2523</b>	6,4	170	OM 906.920 LA <Euro2>				
			Komp.Nr. 505074 /12/15	01.02-08.06	TNK	6	<b>0 432 193 481</b>
			Mot.-Nr. →..022247	01.02-08.06		6	<b>0 432 193 480</b>
			Mot.-Nr. ..022248→..056812	01.02-08.06		6	<b>0 432 191 526</b>
			Mot.-Nr. ..056813→	01.02-08.06		6	<b>0 432 191 278</b>





◀ MERCEDES-BENZ

<b>2528</b>	6,4	205	OM 906.921 LA <Euro2>					
			Komp.Nr. 505074/12/15	01.02-08.06	TNK	6	<b>0 432 193 481</b>	
			Mot.-Nr. →..022247	01.02-08.06		6	<b>0 432 193 480</b>	
			Mot.-Nr. ..022248→..056812	01.02-08.06		6	<b>0 432 191 526</b>	
			Mot.-Nr. ..056813→	01.02-08.06		6	<b>0 432 191 278</b>	
<b>2535 LS</b>	12,0	260	OM 457.937 LA					
			Komp.Nr. 522003/01	01.02-08.06	TNK	6	<b>0 432 191 551</b>	
			Komp.Nr. 522003/02/09	01.02-08.06	TNK	6	<b>0 432 191 263</b>	
			Komp.Nr. 522003/08	01.02-08.06	TNK	6	<b>0 432 191 258</b>	
			Komp.Nr. 505137/25/26					
			Komp.Nr. 522003/18	01.02-08.06	TNK	6	<b>0 432 193 449</b>	
<b>2540 LS</b>	12,0	295	OM 457.937 LA					
			Komp.Nr. 522003/01	01.02-08.06	TNK	6	<b>0 432 191 551</b>	
			Komp.Nr. 522003/02/09	01.02-08.06	TNK	6	<b>0 432 191 263</b>	
			Komp.Nr. 522003/08	01.02-08.06	TNK	6	<b>0 432 191 258</b>	
			Komp.Nr. 505137/25/26					
			Komp.Nr. 522003/18	01.02-08.06	TNK	6	<b>0 432 193 449</b>	
<b>2543 LS</b>	12,0	315	OM 457.937 LA					
			Komp.Nr. 522003/01	01.02-08.06	TNK	6	<b>0 432 191 551</b>	
			Komp.Nr. 522003/02/09	01.02-08.06	TNK	6	<b>0 432 191 263</b>	
			Komp.Nr. 522003/08	01.02-08.06	TNK	6	<b>0 432 191 258</b>	
			Komp.Nr. 505137/25/26					
			Komp.Nr. 522003/18	01.02-08.06	TNK	6	<b>0 432 193 449</b>	
<b>2628</b>	6,4	205	OM 906.921 LA <Euro2>					
			Komp.Nr. 505074/12/15	01.02-08.06	TNK	6	<b>0 432 193 481</b>	
			Mot.-Nr. →..022247	01.02-08.06		6	<b>0 432 193 480</b>	
			Mot.-Nr. ..022248→..056812	01.02-08.06		6	<b>0 432 191 526</b>	
			Mot.-Nr. ..056813→	01.02-08.06		6	<b>0 432 191 278</b>	
<b>3028</b>	6,4	205	OM 906.921 <OM 906 LA>					
			Komp.Nr. 505074/12/15	03.03→	TNK	6	<b>0 432 193 481</b>	
			Mot.-Nr. →..022247	03.03→	TNK	6	<b>0 432 193 480</b>	
			Komp.Nr. 505047/06					
			Mot.-Nr. ..022248→..056812	03.03→	TNK	6	<b>0 432 191 526</b>	
			Komp.Nr. 505047/06					
			Mot.-Nr. ..056813→	03.03→	TNK	6	<b>0 432 191 278</b>	
			Komp.Nr. 505047/06					
<b>Axor II</b>								
<b>1833</b>	7,2	240	OM 926... <Euro3>	09.04-08.06		6	<b>0 432 191 303</b>	
			OM 926.945 LA <Euro 5/EEV (BlueTec)>	12.09→		6	<b>0 432 193 421</b>	
<b>1836</b>	12,0	265	OM 457.948 LA <Euro 4/5 (BlueTec)>	09.06→		6	<b>0 432 193 419</b>	
<b>1840</b>	12,0	295	OM 457.948 LA <Euro 4/5 (BlueTec)>	09.06→		6	<b>0 432 193 419</b>	
<b>1843</b>	12,0	315	OM 457.948 LA <Euro 4/5 (BlueTec)>	09.06→		6	<b>0 432 193 419</b>	
<b>2533</b>	7,2	240	OM 926.913 LA <Euro3>					
			Komp.Nr. 505047/28	09.04-08.06	TNK	6	<b>0 432 191 303</b>	
			OM 926.945 LA <Euro 5/EEV (BlueTec)>	12.09→		6	<b>0 432 193 421</b>	
<b>2536</b>	12,0	265	OM 457.948 LA <Euro 4/5 (BlueTec)>	09.06→		6	<b>0 432 193 419</b>	
<b>2540</b>	12,0	295	OM 457.948 LA <Euro 4/5 (BlueTec)>	09.06→		6	<b>0 432 193 419</b>	
<b>2543</b>	12,0	315	OM 457.948 LA <Euro 4/5 (BlueTec)>	09.06→		6	<b>0 432 193 419</b>	
<b>2623 L</b>	6,4	170	OM 906.92... <Euro2>					
			Komp.Nr. 505047/06	09.05→	TNK	6	<b>0 432 193 480</b>	
			Mot.-Nr. →..022247					
			Komp.Nr. 505074/12/15	09.05→	TNK	6	<b>0 432 193 481</b>	
			Mot.-Nr. ..022248→..056812	09.05→		6	<b>0 432 191 526</b>	
			Komp.Nr. 505047/06					
			Mot.-Nr. ..056813→	09.05→	TNK	6	<b>0 432 191 278</b>	
			Komp.Nr. 505047/06					
<b>2633</b>	7,2	240	OM 926.913 LA <Euro3>					
			Komp.Nr. 505047/28	09.04-08.06	TNK	6	<b>0 432 191 303</b>	
			OM 926.945 LA <Euro 5/EEV (BlueTec)>	12.09→		6	<b>0 432 193 421</b>	
<b>2635</b>	12,0	260	OM 457.956 <(457 LA) Euro 3>	09.04→	TW	6	<b>0 432 191 258</b>	
						6	<b>0 432 191 446</b>	
						6	<b>0 432 191 459</b>	
						6	<b>0 432 193 449</b>	





2636	12,0	265	OM 457... <Euro 4/5 (BlueTec)>	09.06→		6	0 432 193 419
2640	12,0	295	OM 457... <Euro 4/5 (BlueTec)>	09.06→		6	0 432 193 419
2643	12,0	315	OM 457... <Euro 4/5 (BlueTec)>	09.06→		6	0 432 193 419
3236	12,0	265	OM 457... <Euro 4/5 (BlueTec)>	09.06→		6	0 432 193 419
3240	12,0	295	OM 457... <Euro 4/5 (BlueTec)>	09.06→		6	0 432 193 419
3243	12,0	315	OM 457... <Euro 4/5 (BlueTec)>	09.06→		6	0 432 193 419
3335	12,0	260	OM 457.956 LA <Euro 3>	09.04→	TW	6	0 432 191 258
						6	0 432 191 446
						6	0 432 191 459
						6	0 432 193 449
3340	12,0	295	OM 457.956 LA <Euro 3>	09.04→	TW	6	0 432 191 258
						6	0 432 191 446
						6	0 432 191 459
						6	0 432 193 449
3343	12,0	315	OM 457.956 LA <Euro 3>	09.04→	TW	6	0 432 191 258
						6	0 432 191 446
						6	0 432 191 459
						6	0 432 193 449
4135	12,0	260	OM 457.956 <(457 LA) Euro 3>	09.04→	TW	6	0 432 191 258
						6	0 432 191 446
						6	0 432 191 459
						6	0 432 193 449
4140	12,0	295	OM 457.956 <(457 LA) Euro 3>	09.04→	TW	6	0 432 191 258
						6	0 432 191 446
						6	0 432 191 459
						6	0 432 193 449
4143	12,0	315	OM 457.956 <(457 LA) Euro 3>	09.04→	TW	6	0 432 191 258
						6	0 432 191 446
						6	0 432 191 459
						6	0 432 193 449
			OM 457.957 <Euro 4/5 (BlueTec)>	09.06→		6	0 432 193 419
<b>Citaro</b>							
0 530	7,2	210	OM 926... <Euro 4/5>				
			Mot.-Typ 926.949	10.06→		6	0 432 193 421
	12,0	220	OM 457.9... <Euro 4/5 (BlueTec)>				
			Mot.-Typ 457.950 Mot.-Typ 457.959	11.11→	TW	6	0 432 191 219
						6	0 432 193 419
, G	12,0	260	OM 457.9... <Euro 4/5 (BlueTec)>				
			Mot.-Typ 457.951 Mot.-Typ 457.967	10.06→	TW	6	0 432 191 219
						6	0 432 193 419
, G, GL CapaCity, GUE, L, Low Entry UE, MUE, UE	12,0	220-260	OM 457.9... <Euro 4/5 (BlueTec)>				
			Mot.-Typ 457.950,959	10.06→	TW	6	0 432 191 219
						6	0 432 193 419
G/GÜ	12,0	220-260	OM 457.9... <Euro 4/5 (BlueTec)>				
			Mot.-Typ 457.950 Mot.-Typ 457.959	11.11→	TW	6	0 432 191 219
						6	0 432 193 419
GNUE3, GN3, GN3 UESTRA, N3	12,0	185	OM 457.935 HLA <Euro 2>	01.98-09.04		6	0 432 191 400
			Komp.Nr. 505137 /03	01.98-09.04	TNK	6	0 432 191 446
			Komp.Nr. 505137/05	01.98-09.04	TNK	6	0 432 191 459
			Komp.Nr. 505137/06				
			Komp.Nr. 522003/03				
			Komp.Nr. 505137/10	01.98-09.04	TNK	6	0 432 191 384
			Komp.Nr. 505137/11				
			Komp.Nr. 522003/01	01.98-09.04	TNK	6	0 432 191 551
			Komp.Nr. 522006/06	01.98-09.04	KOC,TNK	6	0 432 191 407





◀ MERCEDES-BENZ

0 530	GNUE3, GN3, GN3 UESTRA, N3	12,0	220	OM 457.934 HLA <Euro 2>	Komp.Nr. 505137/05	01.98-09.04	TNK	6	<b>0 432 191 459</b>	
					Komp.Nr. 505137/06					
					Komp.Nr. 522003/03					
					Komp.Nr. 505137/10	01.98-09.04	TNK	6	<b>0 432 191 384</b>	
					Komp.Nr. 505137/11					
					Komp.Nr. 522003/01	01.98-09.04	TNK	6	<b>0 432 191 551</b>	
					Komp.Nr. 522003/07	01.98-09.04	TNK	6	<b>0 432 191 400</b>	
				Komp.Nr. 522006/06	01.98-09.04	KOC,TNK	6	<b>0 432 191 407</b>		
GNUE3, GN3, GN3 UESTRA, N3 UESTRA, N3/NUE3	6,4	205	OM 909.901 LA <Euro 2>	Komp.Nr. 505074/12/15	01.99-09.04	TNK	6	<b>0 432 193 481</b>		
				Mot.-Nr. →..022247	01.99-09.04		6	<b>0 432 193 480</b>		
				Mot.-Nr. ..022248→..056812	01.99-09.04		6	<b>0 432 191 526</b>		
				Mot.-Nr. ..056813→	01.99-09.04		6	<b>0 432 191 278</b>		
GNUE3, GN3, N3	12,0	260	OM 457.933 HLA <Euro 2>	Komp.Nr. 505137/03	01.98-09.04	TNK	6	<b>0 432 191 446</b>		
				Komp.Nr. 505137/05	01.98-09.04	TNK	6	<b>0 432 191 459</b>		
				Komp.Nr. 505137/06						
				Komp.Nr. 522003/03						
				Komp.Nr. 505137/10	01.98-09.04	TNK	6	<b>0 432 191 384</b>		
				Komp.Nr. 505137/11						
				Komp.Nr. 522003/01	01.98-09.04	TNK	6	<b>0 432 191 551</b>		
				Komp.Nr. 522003/07	01.98-09.04	TNK	6	<b>0 432 191 400</b>		
				Komp.Nr. 522006/06	01.98-09.04	KOC,TNK	6	<b>0 432 191 407</b>		
GNUE3, GN3, N3/NUE3	0,0	205	OM 909.921 LA <Euro 2>	Komp.Nr. 505074/12/15	01.99-09.04	TNK	6	<b>0 432 193 481</b>		
				Mot.-Nr. →..022247	01.99-09.04		6	<b>0 432 193 480</b>		
				Mot.-Nr. ..022248→..056812	01.99-09.04		6	<b>0 432 191 526</b>		
				Mot.-Nr. ..056813→	01.99-09.04		6	<b>0 432 191 278</b>		
GN3, NUE3, N3	6,4	205	OM 906.960 LA <Euro 3>	Komp.Nr. 505047/17	04.99-09.06	TNK	6	<b>0 432 191 302</b>		
				Komp.Nr. 505047/39	04.99-09.06	TNK	6	<b>0 432 193 438</b>		
				Komp.Nr. 505074/12/15	04.99-09.06	TNK	6	<b>0 432 193 481</b>		
	12,0	185-260	OM 457.942 HLA <Euro 3>	Komp.Nr. 505137/03	04.99-10.06	TNK	6	<b>0 432 191 446</b>		
				Komp.Nr. 505137/05	04.99-10.06	TNK	6	<b>0 432 191 459</b>		
				Komp.Nr. 505137/06						
				Komp.Nr. 522003/03						
				Komp.Nr. 522003/02/09	04.99-10.06	TNK	6	<b>0 432 191 263</b>		
				Komp.Nr. 522003/08	04.99-10.06	TNK	6	<b>0 432 191 258</b>		
				Komp.Nr. 505137/25/26						
Komp.Nr. 522003/18	04.99-10.06	TNK	6	<b>0 432 193 449</b>						
GN3, NUE3, N3, N3 UESTRA	6,4	205	OM 906.930 HLA <Euro 2>	Komp.Nr. 505074/12/15	01.98-09.04	TNK	6	<b>0 432 193 481</b>		
				Mot.-Nr. →..022247	01.98-09.04		6	<b>0 432 193 480</b>		
				Mot.-Nr. ..022248→..056812	01.98-09.04		6	<b>0 432 191 526</b>		
				Mot.-Nr. ..056813→	01.98-09.04		6	<b>0 432 191 278</b>		
GN3, N3	6,4	205	OM 906.961 <Euro 3>	Komp.Nr. 505047/17	04.00-09.06	TNK	6	<b>0 432 191 302</b>		
				Komp.Nr. 505047/39	04.00-09.06	TNK	6	<b>0 432 193 438</b>		
Low Entry	12,0	220-260	OM 457.941 HLA <Euro 3>	Komp.Nr. 522003/02/09	09.05-09.06	TNK	6	<b>0 432 191 263</b>		
				Komp.Nr. 522003/08	09.05-09.06	TNK	6	<b>0 432 191 258</b>		
				Komp.Nr. 505137/25/26						
				Komp.Nr. 522003/18	09.05-09.06	TNK	6	<b>0 432 193 449</b>		
N3	6,4	180	OM 906.962 <Euro 3>	Komp.Nr. 505047/21	04.00-09.06	TNK	6	<b>0 432 191 301</b>		
				Komp.Nr. 505047/40	04.00-09.06	TNK	6	<b>0 432 191 394</b>		
			OM 906.963 HLA <Euro 3>	Komp.Nr. 505047/21	04.99-09.06	TNK	6	<b>0 432 191 301</b>		
				Komp.Nr. 505047/40	04.99-09.06	TNK	6	<b>0 432 191 394</b>		







◀ MERCEDES-BENZ

<b>7.2</b> [628]	7,2	210	OM 926... <Euro 4/5> Mot.-Typ 926.949	09.07→		6	<b>0 432 193 421</b>
<b>12.0</b> [628]	12,0	260	OM 457.9... <Euro 4/5 (BlueTec)> Mot.-Typ 457.951 Mot.-Typ 457.967	09.07→	TW	6	<b>0 432 191 219</b>
[671]	12,0	185-260	OM 457.94... <Euro 3> Komp.Nr. 505137/03	10.01-08.07	TNK	6	<b>0 432 191 446</b>
			Komp.Nr. 505137/05	10.01-08.07	TNK	6	<b>0 432 191 459</b>
			Komp.Nr. 522003/02/09	10.01-08.07	TNK	6	<b>0 432 191 263</b>
			Komp.Nr. 522003/08	10.01-08.07	TNK	6	<b>0 432 191 258</b>
			Komp.Nr. 505137/25/26				
			Komp.Nr. 522003/18	10.01-08.07	TNK	6	<b>0 432 193 449</b>
<b>Econic</b>							
<b>1823 L</b> [957]	6,4	170	OM 906... Komp.Nr. 505074/12/15	03.98-03.01	TNK	6	<b>0 432 193 481</b>
			Mot.-Nr. →.022247	03.98-03.01		6	<b>0 432 193 480</b>
			Mot.-Nr. ..022248→..056812	03.98-03.01		6	<b>0 432 191 526</b>
			Mot.-Nr. ..056813→	03.98-03.01		6	<b>0 432 191 278</b>
			OM 906.951 LA <Euro 3>	03.00-09.06		6	<b>0 432 191 301</b>
<b>1828 L</b> [957]	6,4	205	OM 906.941 LA <Euro 2> Komp.Nr. 505074/12/15	03.98-03.01	TNK	6	<b>0 432 193 481</b>
			Mot.-Nr. →.022247	03.98-03.01		6	<b>0 432 193 480</b>
			Mot.-Nr. ..022248→..056812	03.98-03.01		6	<b>0 432 191 526</b>
			Mot.-Nr. ..056813→	03.98-03.01		6	<b>0 432 191 278</b>
			OM 906.950 LA <Euro 3>; OM 906.952 LA <Euro 3>	07.98-09.06		6	<b>0 432 191 302</b>
<b>2628 L</b> [957]	6,4	205	OM 906.941 LA <Euro 2> Komp.Nr. 505074/12/15	03.98-03.01	TNK	6	<b>0 432 193 481</b>
			Mot.-Nr. →.022247	03.98-03.01		6	<b>0 432 193 480</b>
			Mot.-Nr. ..022248→..056812	03.98-03.01		6	<b>0 432 191 526</b>
			Mot.-Nr. ..056813→	03.98-03.01		6	<b>0 432 191 278</b>
			OM 906.952 LA <Euro 3>	03.00-09.06		6	<b>0 432 191 302</b>
<b>Integro I</b>							
<b>0 550 Ü, ÜH</b>	12,0	184-260	OM 447 HLA Euro 2 <447.903>	09.99-09.06	X10	6	<b>0 432 131 780<sup>1</sup></b>
					X56	6	<b>0 432 131 781 0 986 430 361</b>
<b>Integro II</b>							
	12,0	220-300	OM 457... <Euro 4/5 (BlueTec)> Mot.-Typ 457.952/964/965	09.06→	TW	6	<b>0 432 191 219</b>
						6	<b>0 432 193 419</b>
<b>L</b>	12,0	220-300	OM 457... <Euro 4/5 (BlueTec)> Mot.-Typ 457.952/964/965	09.06→	TW	6	<b>0 432 191 219</b>
						6	<b>0 432 193 419</b>
<b>M</b>	12,0	220-300	OM 457... <Euro 4/5 (BlueTec)> Mot.-Typ 457.952/964/965	09.06→	TW	6	<b>0 432 191 219</b>
						6	<b>0 432 193 419</b>
<b>Intouro</b>							
	7,2	210	OM 926... <Euro 4/5> Mot.-Typ 926.949	03.07→		6	<b>0 432 193 421</b>
	12,0	220/260/300	OM 457.9... <Euro 4/5 (BlueTec)> Mot.-Typ 457.965	03.07→	TW	6	<b>0 432 191 219</b>
						6	<b>0 432 193 419</b>
<b>0 560</b>	11,0	250	OM 441 LA Euro 2	01.00-03.07		6	<b>0 432 131 726 0 986 430 326</b>
					X10	6	<b>0 432 131 730<sup>1</sup></b>
<b>MB</b>							
<b>100 2.3D</b>	2,3	58	OM 661.911	01.96→		4	<b>0 432 217 157 0 986 430 197</b>
2.9D	2,9	69-70	OM 662.911	01.96→		5	<b>0 432 217 157 0 986 430 197</b>
<b>800</b>	4,0	85	380.94... <OM 364 A>	07.96-09.06		4	<b>0 432 231 823 0 986 430 045</b>
<b>Medio</b>							
<b>4.2</b>	4,2	110	OM 904.936 LA <Euro 2>	01.01-09.06		4	<b>0 432 191 394</b>
<b>O 301</b>							
<b>F</b>	6,0	100	OM 366.917	08.88-02.01		6	<b>0 432 231 736 0 986 430 178</b>
		125	OM 366.965 A	06.86-02.01		6	<b>0 432 231 823 0 986 430 045</b>







O 345									
	6,4	205	OM 906.960 (906 LA) <Euro 2>						
			Komp.Nr. 505047 /17	10.01-08.07	TNK	6	<b>0 432 191 302</b>		
			Komp.Nr. 505047/ 39	10.01-08.07	TNK	6	<b>0 432 193 438</b>		
			Komp.Nr. 505074 /12/15	10.01-08.07	TNK	6	<b>0 432 193 481</b>		
	10,0	155	OM 489.960 (449 HLA) <Euro 2>	10.95-08.07		5	<b>9 430 082 768</b>		
	12,0	157	OM 447.949 (447 HLA) <Euro 2>	12.96-08.07		6	<b>0 432 131 780<sup>1</sup></b>		
						6	<b>0 432 131 781</b>	<b>0 986 430 361</b>	
		184	OM 447.960 (447 HLA) <Euro 1>	05.97-08.07		6	<b>0 432 231 676</b>	<b>0 986 430 360</b>	
<b>G</b>	10,0	184	OM 489.961 (449 HLA) <Euro 1>	10.95-08.07		5	<b>9 430 082 768</b>		
	12,0	185-260	OM 457.942 (457 HLA) <Euro 3>						
			Komp.Nr. 505137/03	10.01-08.07	TNK	6	<b>0 432 191 446</b>		
			Komp.Nr. 505137/05	10.01-08.07	TNK	6	<b>0 432 191 459</b>		
			Komp.Nr. 522003/02/09	10.01-08.07	TNK	6	<b>0 432 191 263</b>		
			Komp.Nr. 522003/08	10.01-08.07	TNK	6	<b>0 432 191 258</b>		
			Komp.Nr. 505137/25/26						
			Komp.Nr. 522003/18	10.01-08.07		6	<b>0 432 193 449</b>		
<b>K</b>	12,0	220	OM 447.947 (447 HLA) <Euro 1>	05.97-08.07		6	<b>0 432 231 676</b>	<b>0 986 430 360</b>	
			OM 447.948 (447 HLA) <Euro 2>	05.97-08.07	X10	6	<b>0 432 131 780<sup>1</sup></b>		
					X56	6	<b>0 432 131 781</b>	<b>0 986 430 361</b>	
O 402									
	6,0	100	OM 366.917	08.88-02.01		6	<b>0 432 231 736</b>	<b>0 986 430 178</b>	
		125	OM 366.965 A	06.86-02.01		6	<b>0 432 231 823</b>	<b>0 986 430 045</b>	
<b>F</b>	6,0	100	OM 366.917	08.88-02.01		6	<b>0 432 231 736</b>	<b>0 986 430 178</b>	
		125	OM 366.965 A	06.86-02.01		6	<b>0 432 231 823</b>	<b>0 986 430 045</b>	
O 404									
	9,6	200/213	OM 401.970 LA <Euro 1>; OM 401.974 LA <Euro 1>	10.93-05.98		6	<b>0 432 231 665</b>	<b>0 986 430 205</b>	
	11,0	213	OM 445.935 (441) LA <Euro 2>						
			Mot.-Nr. →..859984	01.95-10.99		6	<b>0 432 131 800</b>	<b>0 986 430 264</b>	
						6	<b>0 432 131 803<sup>1</sup></b>		
			Mot.-Nr. ..859985→	01.95-10.99		6	<b>0 432 131 728</b>	<b>0 986 430 327</b>	
						6	<b>0 432 131 729<sup>1</sup></b>		
		250	OM 441.980 LA <Euro 1>	09.91-10.99		6	<b>0 432 231 677</b>	<b>0 986 430 211</b>	
			OM 445.934 (441) LA <Euro 2>						
			Mot.-Nr. →..859979	01.95-10.99		6	<b>0 432 131 801</b>	<b>0 986 430 265</b>	
						6	<b>0 432 131 804<sup>1</sup></b>		
			Mot.-Nr. ..859980→	01.95-10.99		6	<b>0 432 131 726</b>	<b>0 986 430 326</b>	
						6	<b>0 432 131 730<sup>1</sup></b>		
	12,8	280	OM 402.970 LA <Euro 1>	10.93-05.98		8	<b>0 432 231 665</b>	<b>0 986 430 205</b>	
		280-295	OM 402.974 LA <Euro 1>	09.91-10.99		8	<b>0 432 231 665</b>	<b>0 986 430 205</b>	
	15,0	280	OM 446.934 (442) LA <Euro 2>						
			Mot.-Nr. →..860029	01.95-10.99		8	<b>0 432 131 800</b>	<b>0 986 430 264</b>	
						8	<b>0 432 131 803<sup>1</sup></b>		
			Mot.-Nr. ..860030→	01.95-10.99		8	<b>0 432 131 728</b>	<b>0 986 430 327</b>	
						8	<b>0 432 131 729<sup>1</sup></b>		
			OM 446.938 (442) LA <Euro 2>						
			Mot.-Nr. →..860029	01.95-10.99		8	<b>0 432 131 800</b>	<b>0 986 430 264</b>	
						8	<b>0 432 131 803<sup>1</sup></b>		
			Mot.-Nr. ..860030→	01.95-10.99		8	<b>0 432 131 728</b>	<b>0 986 430 327</b>	
						8	<b>0 432 131 729<sup>1</sup></b>		
O 405									
	12,0	150/177	OM 447.905 h; OM 447.906,907,908 h	11.86-02.01		6	<b>0 432 231 681</b>		
		157	OM 447.913 h <Euro 1>	10.93-05.98		6	<b>0 432 231 665</b>	<b>0 986 430 205</b>	
		184	OM 447.956 hA <Euro 1>	10.93-02.01		6	<b>0 432 231 676</b>	<b>0 986 430 360</b>	
		206	OM 447.950,951 hA	11.86-02.01		6	<b>0 432 231 663</b>	<b>0 986 430 093</b>	
<b>G</b>	12,0	177	OM 447.907 h	11.86-02.01		6	<b>0 432 231 681</b>		
		206	OM 447.950 hA	11.86-02.01		6	<b>0 432 231 663</b>	<b>0 986 430 093</b>	
		220	OM 447.980 <Euro 1>	11.86-02.01		6	<b>0 432 231 676</b>	<b>0 986 430 360</b>	
<b>GTD</b>	0,0	184	OM 447.955 ha <Euro 1>	11.86-02.01		6	<b>0 432 231 676</b>	<b>0 986 430 360</b>	
<b>GTZ</b>	0,0	63	OM 602.990	11.86-02.01		5	<b>0 432 217 157</b>	<b>0 986 430 197</b>	
	2,9	72	OM 602.994	11.86-02.01		5	<b>0 432 217 157</b>	<b>0 986 430 197</b>	
<b>N</b>	12,0	150/177	OM 447.910 h; OM 447.911 hla	10.93-02.01		6	<b>0 432 231 681</b>		





◀ MERCEDES-BENZ

O 407							
	12,0	177	OM 447.906,907,908 h	03.87-02.01	6	0 432 231 681	
			OM 447.908 h	03.87-02.01	0	0 432 231 681	
	184		OM 447.990 Hla <Euro 2>	02.91-02.01	X10	6	0 432 131 780 <sup>1</sup>
					X56	6	0 432 131 781 0 986 430 361
	220		OM 447.985 Hla <Euro 1>	02.91-02.01		6	0 432 231 676 0 986 430 360
			OM 447.991 Hla <Euro 2>	02.91-02.01	X10	6	0 432 131 780 <sup>1</sup>
					X56	6	0 432 131 781 0 986 430 361
O 408							
	12,0	184	OM 447.912 h	10.93-02.01	6	0 432 231 681	
	184-220		OM 447.992,993 HLA <Euro 2>	08.92-12.01	X10	6	0 432 131 780 <sup>1</sup>
					X56	6	0 432 131 781 0 986 430 361
	184/220		OM 447.958 hA <Euro 1>; OM 447.987 hLA <Euro 1>	10.93-12.01		6	0 432 231 676 0 986 430 360
OF							
<b>1113</b>	6,0	125	OM 366 A	03.95-01.98	6	9 430 082 334	
Serie V							
<b>230 TD [638]</b>	2,3	72	OM 601.970				
			Mot.-Nr. →..518371	04.96-09.03	4	0 432 217 290 0 986 430 505	
			Mot.-Nr. ...518372→	04.96-09.03	4	0 432 217 266 0 986 430 247	
Sprinter							
<b>208 D [T1N]</b>	2,3	58-60	OM 601.943	02.95-03.00	4	0 432 217 157 0 986 430 197	
<b>210 D [T1N]</b>	2,9	75	OM 602.980 DLA	01.97-03.00	FE2	5	0 432 193 623 <sup>1</sup>
						5	0 432 193 625
			Mot.-Nr. →..000136	01.97-03.00	AG	5	0 432 193 557
						5	0 432 193 558 <sup>1</sup>
			Mot.-Nr. →..009849	01.97-03.00	GS	5	0 432 193 557
						5	0 432 193 558 <sup>1</sup>
			Mot.-Nr. ...000137→..009698	01.97-03.00	AG	5	0 432 193 758
						5	0 432 193 768 <sup>1</sup>
			Mot.-Nr. ...009699→	01.97-03.00	AG,FE2	5	0 432 193 637 <sup>1</sup>
						5	0 432 193 639
			Mot.-Nr. ...009850→..182045	01.97-03.00	GS	5	0 432 193 758
						5	0 432 193 768 <sup>1</sup>
			Mot.-Nr. ...182046→	01.97-03.00	FE2,GS	5	0 432 193 637 <sup>1</sup>
						5	0 432 193 639
<b>212 D [T1N]</b>	2,9	90	OM 602.980 DLA	02.95-03.00	FE2	5	0 432 193 623 <sup>1</sup>
						5	0 432 193 625
			Mot.-Nr. →..000136	02.95-03.00	AG	5	0 432 193 557
						5	0 432 193 558 <sup>1</sup>
			Mot.-Nr. →..009849	02.95-03.00	GS	5	0 432 193 557
						5	0 432 193 558 <sup>1</sup>
			Mot.-Nr. ...000137→..009698	02.95-03.00	AG	5	0 432 193 758
						5	0 432 193 768 <sup>1</sup>
			Mot.-Nr. ...009699→	02.95-03.00	AG,FE2	5	0 432 193 637 <sup>1</sup>
						5	0 432 193 639
			Mot.-Nr. ...009850→..182045	02.95-03.00	GS	5	0 432 193 758
						5	0 432 193 768 <sup>1</sup>
			Mot.-Nr. ...182046→	02.95-03.00	FE2,GS	5	0 432 193 637 <sup>1</sup>
						5	0 432 193 639
<b>308 D [T1N]</b>	2,3	58	OM 601.943	02.95-03.00	4	0 432 217 157 0 986 430 197	
<b>310 D</b>	2,5	70	OM 014 A <(632.999)>	09.96-05.01	4	0 432 193 766	





<b>310 D [T1N]</b>	2,9	75	OM 602.980 D LA	01.97-03.00	FE2	5	<b>0 432 193 623</b> <sup>1</sup>	
						5	<b>0 432 193 625</b>	
			Mot.-Nr. →..000136	01.97-03.00	AG	5	<b>0 432 193 557</b>	
						5	<b>0 432 193 558</b> <sup>1</sup>	
			Mot.-Nr. →..009849	01.97-03.00	GS	5	<b>0 432 193 557</b>	
						5	<b>0 432 193 558</b> <sup>1</sup>	
			Mot.-Nr. ..000137→..009698	01.97-03.00	AG	5	<b>0 432 193 758</b>	
						5	<b>0 432 193 768</b> <sup>1</sup>	
			Mot.-Nr. ..009699→	01.97-03.00	AG,FE2	5	<b>0 432 193 637</b> <sup>1</sup>	
						5	<b>0 432 193 639</b>	
			Mot.-Nr. ..009850→..182045	01.97-03.00	GS	5	<b>0 432 193 758</b>	
						5	<b>0 432 193 768</b> <sup>1</sup>	
			Mot.-Nr. ..182046→	01.97-03.00	FE2,GS	5	<b>0 432 193 637</b> <sup>1</sup>	
						5	<b>0 432 193 639</b>	
<b>312 D</b>	2,5	77	OM 014 LA <Euro 2 (632.997)>	10.99-05.01		4	<b>0 432 193 582</b>	
		85	OM 014 LA <Euro 2 (632.998)>	08.99-05.01		4	<b>0 432 193 583</b>	
<b>D [T1N]</b>	2,9	90	OM 602.980 D LA	02.95-03.00	FE2	5	<b>0 432 193 623</b> <sup>1</sup>	
						5	<b>0 432 193 625</b>	
			Mot.-Nr. →..000136	02.95-03.00	AG	5	<b>0 432 193 557</b>	
						5	<b>0 432 193 558</b> <sup>1</sup>	
			Mot.-Nr. →..009849	02.95-03.00	GS	5	<b>0 432 193 557</b>	
						5	<b>0 432 193 558</b> <sup>1</sup>	
			Mot.-Nr. ..000137→..009698	02.95-03.00	AG	5	<b>0 432 193 758</b>	
						5	<b>0 432 193 768</b> <sup>1</sup>	
			Mot.-Nr. ..009699→	02.95-03.00	AG,FE2	5	<b>0 432 193 637</b> <sup>1</sup>	
						5	<b>0 432 193 639</b>	
			Mot.-Nr. ..009850→..182045	02.95-03.00	GS	5	<b>0 432 193 758</b>	
						5	<b>0 432 193 768</b> <sup>1</sup>	
			Mot.-Nr. ..182046→	02.95-03.00	FE2,GS	5	<b>0 432 193 637</b> <sup>1</sup>	
						5	<b>0 432 193 639</b>	
<b>408 D [T1N]</b>	2,3	58	OM 601.943	02.95-03.00		4	<b>0 432 217 157</b>	<b>0 986 430 197</b>
<b>410 D [T1N]</b>	2,9	75	OM 602.980 D LA	01.97-03.00	FE2	5	<b>0 432 193 623</b> <sup>1</sup>	
						5	<b>0 432 193 625</b>	
			Mot.-Nr. →..000136	01.97-03.00	AG	5	<b>0 432 193 557</b>	
						5	<b>0 432 193 558</b> <sup>1</sup>	
			Mot.-Nr. →..009849	01.97-03.00	GS	5	<b>0 432 193 557</b>	
						5	<b>0 432 193 558</b> <sup>1</sup>	
			Mot.-Nr. ..000137→..009698	01.97-03.00	AG	5	<b>0 432 193 758</b>	
						5	<b>0 432 193 768</b> <sup>1</sup>	
			Mot.-Nr. ..009699→	01.97-03.00	AG,FE2	5	<b>0 432 193 637</b> <sup>1</sup>	
						5	<b>0 432 193 639</b>	
			Mot.-Nr. ..009850→..182045	01.97-03.00	GS	5	<b>0 432 193 758</b>	
						5	<b>0 432 193 768</b> <sup>1</sup>	
			Mot.-Nr. ..182046→	01.97-03.00	FE2,GS	5	<b>0 432 193 637</b> <sup>1</sup>	
						5	<b>0 432 193 639</b>	
<b>412 D</b>	2,5	85	OM 014 LA <Euro 2>	10.99-05.01		4	<b>0 432 193 583</b>	
<b>D [T1N]</b>	2,9	90	OM 602.980 D LA	02.95-03.00	FE2	5	<b>0 432 193 623</b> <sup>1</sup>	
						5	<b>0 432 193 625</b>	
			Mot.-Nr. →..000136	02.95-03.00	AG	5	<b>0 432 193 557</b>	
						5	<b>0 432 193 558</b> <sup>1</sup>	
			Mot.-Nr. →..009849	02.95-03.00	GS	5	<b>0 432 193 557</b>	
						5	<b>0 432 193 558</b> <sup>1</sup>	
			Mot.-Nr. ..000137→..009698	02.95-03.00	AG	5	<b>0 432 193 758</b>	
						5	<b>0 432 193 768</b> <sup>1</sup>	
			Mot.-Nr. ..009699→	02.95-03.00	AG,FE2	5	<b>0 432 193 637</b> <sup>1</sup>	
						5	<b>0 432 193 639</b>	
			Mot.-Nr. ..009850→..182045	02.95-03.00	GS	5	<b>0 432 193 758</b>	
						5	<b>0 432 193 768</b> <sup>1</sup>	
			Mot.-Nr. ..182046→	02.95-03.00	FE2,GS	5	<b>0 432 193 637</b> <sup>1</sup>	
						5	<b>0 432 193 639</b>	





◀ MERCEDES-BENZ

Sprinter (James Cook)										
308 D [T1N]	2,3	58	OM 601.943	02.95-03.00		4	0 432 217 157	0 986 430 197		
310 D [T1N]	2,9	75	OM 602.980 DLA	01.97-03.00	FE2	5	0 432 193 623 <sup>1</sup>			
			Mot.-Nr. →..000136	01.97-03.00	AG	5	0 432 193 625			
			Mot.-Nr. →..009849	01.97-03.00	GS	5	0 432 193 557			
			Mot.-Nr...000137→..009698	01.97-03.00	AG	5	0 432 193 558 <sup>1</sup>			
			Mot.-Nr...009699→	01.97-03.00	AG,FE2	5	0 432 193 758			
			Mot.-Nr...009850→..182045	01.97-03.00	GS	5	0 432 193 768 <sup>1</sup>			
			Mot.-Nr...182046→	01.97-03.00	FE2,GS	5	0 432 193 637 <sup>1</sup>			
						5	0 432 193 639			
312 D [T1N]	2,9	90	OM 602.980 DLA	02.95-03.00	FE2	5	0 432 193 623 <sup>1</sup>			
			Mot.-Nr. →..000136	02.95-03.00	AG	5	0 432 193 625			
			Mot.-Nr. →..009849	02.95-03.00	GS	5	0 432 193 557			
			Mot.-Nr...000137→..009698	02.95-03.00	AG	5	0 432 193 558 <sup>1</sup>			
			Mot.-Nr...009699→	02.95-03.00	AG,FE2	5	0 432 193 758			
			Mot.-Nr...009850→..182045	02.95-03.00	GS	5	0 432 193 768 <sup>1</sup>			
			Mot.-Nr...182046→	02.95-03.00	FE2,GS	5	0 432 193 637 <sup>1</sup>			
						5	0 432 193 639			
Tourino										
0 510	6,4	180-205	OM 906... <Euro 3>							
			Mot.-Typ 906.961	01.04→	TW	6	0 432 191 302			
			Mot.-Typ 906.962	01.04→	TW	6	0 432 193 438			
						6	0 432 191 301			
						6	0 432 191 394			
	7,2	210	OM 926... <Euro 4/5>							
			Mot.-Typ 926.949	09.06→		6	0 432 193 421			
Tourismo										
	12,0	260-300	OM 457... <Euro 4/5 (BlueTec)>							
			Mot.-Typ 457.952/965	10.06→	TW	6	0 432 191 219			
						6	0 432 193 419			
M, L	12,0	315	OM 457... <Euro 4/5 (BlueTec)>							
			Mot.-Typ 457.953 Mot.-Typ 457.961	10.06→	TW	6	0 432 191 219			
						6	0 432 193 419			
0 350	11,0	250	OM 441.980 LA <Euro 1>	10.95-09.06		6	0 432 231 677	0 986 430 211		
			OM 445.934 LA <Euro 2>							
			Mot.-Nr. →..859979	10.95-09.06		6	0 432 131 801	0 986 430 265		
			Mot.-Nr...859980→	10.95-09.06		6	0 432 131 804 <sup>1</sup>			
						6	0 432 131 726	0 986 430 326		
						6	0 432 131 730 <sup>1</sup>			
	12,8	280	OM 402.970 LA <Euro 1>	10.95-09.06		8	0 432 231 665	0 986 430 205		
	14,6	280	OM 446.938 LA <Euro 2>							
			Mot.-Nr. →..860029	10.95-09.06		8	0 432 131 800	0 986 430 264		
			Mot.-Nr...860030→	10.95-09.06		8	0 432 131 803 <sup>1</sup>			
						8	0 432 131 728	0 986 430 327		
						8	0 432 131 729 <sup>1</sup>			
RH	12,0	260-300	OM 457... <Euro 4/5 (BlueTec)>							
			Mot.-Typ 457.965	09.09→	TW	6	0 432 191 219			
						6	0 432 193 419			
RH-M	12,0	260-300	OM 457... <Euro 4/5 (BlueTec)>							
			Mot.-Typ 457.965	09.09→	TW	6	0 432 191 219			
						6	0 432 193 419			





<b>15 RHD/SHD</b>	12,0	260-310	OM 457.944 LA <Euro 3>					
			Komp.Nr. 522003/02/09	10.99-09.04	TNK	6	<b>0 432 191 263</b>	
			Komp.Nr. 522003/08	10.99-09.04	TNK	6	<b>0 432 191 258</b>	
			Komp.Nr. 505137/25/26					
		310	OM 457.944 HLA <Euro 3>					
			Komp.Nr. 522003/18	10.99-09.04	TNK	6	<b>0 432 193 449</b>	
<b>Touro</b>								
<b>OC 500</b>	12,0	260-310	OM 457.944 LA <Euro 3>					
			Komp.Nr. 522003/02/09	10.02-08.08	TNK	6	<b>0 432 191 263</b>	
			Komp.Nr. 522003/08	10.02-08.08		6	<b>0 432 191 258</b>	
			Komp.Nr. 505137/10					
			Komp.Nr. 522003/18	10.02-08.08	TNK	6	<b>0 432 193 449</b>	
<b>Travego</b>								
<b>O 580</b>	12,0	260-355	OM 457.9... <(OM 457 LA) Euro 4>					
			Komp.Nr. 522003/13	02.06→	TNK	6	<b>0 432 191 219</b>	
				Komp.Nr. 522003/20	02.06→	TNK	6	<b>0 432 193 419</b>
	15,9	320-350	OM 542.948 <(OM 502 LA)>					
			Komp.Nr. 505134/04	02.06→	TNK	8	<b>0 432 191 446</b>	
			Komp.Nr. 505137/11	02.06→	TNK	8	<b>0 432 191 384</b>	
RHD, RHD-L, RHD-M	12,0	315	OM 457.9... <Euro 4/5 (BlueTec)>					
			Mot.-Typ 457.961	09.09→	TW	6	<b>0 432 191 219</b>	
						6	<b>0 432 193 419</b>	
RHD-15	12,0	185-310	OM 457.9... <Euro 3>					
			Komp.Nr. 505137/03	10.99-02.06	TNK	6	<b>0 432 191 446</b>	
			Komp.Nr. 505137/10	10.99-02.06	TNK	6	<b>0 432 191 384</b>	
			Komp.Nr. 522003/01	10.99-02.06	TNK	6	<b>0 432 191 551</b>	
			Komp.Nr. 522003/07	10.99-02.06	TNK	6	<b>0 432 191 400</b>	
	15,9	300-350	OM 942.900 LA <(OM 502 LA) Euro 3>					
			Komp.Nr. 505126/01/02	02.01-02.06	TNK	8	<b>0 432 191 589</b>	
			Komp.Nr. 505137/01/02					
RHD-16/17	12,0	310	OM 457.944 LA <Euro 3>					
			Komp.Nr. 505137/10	10.99-02.06	TNK	6	<b>0 432 191 384</b>	
			Komp.Nr. 522003/02/09	10.99-02.06	TNK	6	<b>0 432 191 263</b>	
			Komp.Nr. 522003/08	10.99-02.06		6	<b>0 432 191 258</b>	
			Komp.Nr. 522003/18	10.99-02.06		6	<b>0 432 193 449</b>	
<b>Unimog</b>								
<b>U 90 [408]</b>	2,9	90	OM 602.98... <DE 29 LA>					
			Mot.-Nr. →..044623	07.96-09.01	ATW	5	<b>0 432 193 768<sup>1</sup></b>	
					TW	5	<b>0 432 193 758</b>	
			Mot.-Nr. ..044122→..045360..044336→	07.96-09.01	ATW	5	<b>0 432 193 623<sup>1</sup></b>	
			..044336..045371→					
			Mot.-Nr. ..044624→..045121	07.96-09.01	ATW	5	<b>0 432 193 637<sup>1</sup></b>	
		TW	5	<b>0 432 193 639</b>				
			Mot.-Nr. ..045122→..045360..044336→	07.96-09.01	TW	5	<b>0 432 193 625</b>	
			..044336..045371→					
<b>U 100 L [408]</b>	2,9	90	OM 602.98... <DE 29 LA>					
			Mot.-Nr. →..044623	07.96-09.01	ATW	5	<b>0 432 193 768<sup>1</sup></b>	
					TW	5	<b>0 432 193 758</b>	
			Mot.-Nr. ..044122→..045360..044336→	07.96-09.01	ATW	5	<b>0 432 193 623<sup>1</sup></b>	
			..044336..045371→					
			Mot.-Nr. ..044624→..045121	07.96-09.01	ATW	5	<b>0 432 193 637<sup>1</sup></b>	
		TW	5	<b>0 432 193 639</b>				
			Mot.-Nr. ..045122→..045360..044336→	07.96-09.01	TW	5	<b>0 432 193 625</b>	
			..044336..045371→					
<b>U 130 , T [418]</b>	4,0	98	OM 364.982 LA <Euro 1>	07.92-09.98		4	<b>0 432 231 688</b>	<b>0 986 430 221</b>
		103	OM 354.926 LA <Euro 2>	09.95-09.98		4	<b>0 432 131 794</b>	<b>0 986 430 252</b>
<b>U 140 , L [418]</b>	4,0	98/100	OM 364.982 LA <Euro 1>; OM 364.985 LA <Euro 1>; OM 364.989 LA <Euro 1>	07.92-09.98		4	<b>0 432 231 688</b>	<b>0 986 430 221</b>
<b>, T [418]</b>	4,0	103	OM 354.926 LA <Euro 2>	09.95-09.98		4	<b>0 432 131 794</b>	<b>0 986 430 252</b>
<b>U 300 [405]</b>	4,3	100	OM 904.927 LA <Euro 3>					
			Komp.Nr. 505047/10	04.00→	TNK	4	<b>0 432 193 480</b>	
			Komp.Nr. 505047/20	04.00→	TNK	4	<b>0 432 191 394</b>	





◀ MERCEDES-BENZ

<b>U 300</b> [405]	4,3	125	OM 904.928 LA <Euro3> Komp.Nr. 505047/ 16	04.00→	TNK	4	<b>0 432 193 438</b>	
			Komp.Nr. 505047/10	04.00→	TNK	4	<b>0 432 193 480</b>	
<b>U 400</b> [405]	4,3	125	OM 904.928 LA <Euro3> Komp.Nr. 505047/ 16	04.00→	TNK	4	<b>0 432 193 438</b>	
			Komp.Nr. 505047/10	04.00→	TNK	4	<b>0 432 193 480</b>	
	6,4	170	OM 906.935 LA <Euro 3>	04.00→		6	<b>0 432 191 301</b>	
<b>U 500</b> [405]	6,4	170	OM 906.935 LA <Euro 3>	02.01→		6	<b>0 432 191 301</b>	
		205	OM 906.955 LA <Euro3>	02.01→		6	<b>0 432 191 302</b>	
<b>U 600</b> [407]	2,4	38/44	OM 616.942; OM 616.943	05.88-02.01	KOC	4	<b>0 432 217 143</b>	
<b>U 650</b> [407]	2,4	44	OM 616.943	05.88-02.01	KOC	4	<b>0 432 217 143</b>	
<b>U 900</b> [417]	5,7	62	OM 353.902					
			Mot.-Nr. →..899556	05.88-02.01		6	<b>0 432 231 887</b>	<b>0 986 430 056</b>
			Mot.-Nr. ..899557→	05.88-02.01		6	<b>0 432 231 824</b>	<b>0 986 430 046</b>
	6,0	81	OM 366.939					
			Mot.-Nr. ..910817→	11.88-02.01		6	<b>0 432 231 736</b>	<b>0 986 430 178</b>
<b>U 1100 T</b>	5,7	81	OM 353.940	03.89-02.01		6	<b>0 432 231 824</b>	<b>0 986 430 046</b>
<b>U 1150 , L</b>	5,7	81	OM 353.940	05.88-02.01		6	<b>0 432 231 824</b>	<b>0 986 430 046</b>
<b>U 1200 , T</b>	6,0	92	OM 366.949 A	01.88-02.01		6	<b>0 432 231 736</b>	<b>0 986 430 178</b>
<b>U 1250</b>	6,0	92	OM 366.949 A					
			Mot.-Nr. →..910816	01.88-02.01		6	<b>0 432 231 824</b>	<b>0 986 430 046</b>
			Mot.-Nr. ..910817→	01.88-02.01		6	<b>0 432 231 736</b>	<b>0 986 430 178</b>
, L	6,0	100	OM 356.955 (366) A <Euro 1>	01.88-01.01		6	<b>0 432 231 722</b>	<b>0 986 430 214</b>
				01.88-02.01		6	<b>0 432 231 722</b>	<b>0 986 430 214</b>
L	6,0	92	OM 356.950 (366) A <Euro 1>	01.92-01.01		6	<b>0 432 231 824</b>	<b>0 986 430 046</b>
			OM 356.954 (366) A <Euro 1>	09.91-01.01		6	<b>0 432 231 722</b>	<b>0 986 430 214</b>
			OM 366.949 A	01.88-02.01		6	<b>0 432 231 736</b>	<b>0 986 430 178</b>
		100	OM 357.912 (366) LA <EURO 2>	09.91-01.01		6	<b>0 432 131 768</b>	
		120	OM 357.913 (366) LA <EURO 2>	09.91-01.01		6	<b>0 432 131 793</b>	
<b>U 1300 L</b>	6,0	100	OM 356.955 (366) A <Euro 1>	01.92-02.01		6	<b>0 432 231 722</b>	<b>0 986 430 214</b>
			OM 366.955 A					
			Mot.-Nr. ..910817→	11.86-02.01		6	<b>0 432 231 736</b>	<b>0 986 430 178</b>
		110-115	OM 366.956 A					
			Mot.-Nr. →..910816	11.86-02.01		6	<b>0 432 231 824</b>	<b>0 986 430 046</b>
			Mot.-Nr. ..910817→	11.86-02.01		6	<b>0 432 231 736</b>	<b>0 986 430 178</b>
<b>U 1350 L</b>	6,0	100	OM 356.955 <(366)A Euro1>	09.91-08.02		6	<b>0 432 231 722</b>	<b>0 986 430 214</b>
			OM 366.955 A	05.88-02.01		6	<b>0 432 231 736</b>	<b>0 986 430 178</b>
<b>U 1400</b>	6,0	100	OM 366...					
			Mot.-Nr. →..910816	01.88-04.00		6	<b>0 432 231 824</b>	<b>0 986 430 046</b>
			Mot.-Nr. ..910817→	01.88-04.00		6	<b>0 432 231 736</b>	<b>0 986 430 178</b>
		115	OM 356.956 (366) A <Euro 1>	01.88-04.00		6	<b>0 432 231 722</b>	<b>0 986 430 214</b>
, T	6,0	100	OM 356.955 (366) A <Euro 1>	09.91-04.00		6	<b>0 432 231 722</b>	<b>0 986 430 214</b>
				09.91-09.01		6	<b>0 432 231 722</b>	<b>0 986 430 214</b>
			OM 357.912 (366) LA <EURO 2>	01.92-04.00		6	<b>0 432 131 768</b>	
				01.92-09.01		6	<b>0 432 131 768</b>	
T	6,0	92	OM 356.954 (366) A <Euro 1>	01.92-09.01		6	<b>0 432 231 722</b>	<b>0 986 430 214</b>
<b>U 1450</b>	6,0	100	OM 357.912 (366) LA <EURO 2>	07.94-04.00		6	<b>0 432 131 768</b>	
			OM 366.947 A					
			Mot.-Nr. →..910816	01.88-04.00		6	<b>0 432 231 824</b>	<b>0 986 430 046</b>
			Mot.-Nr. ..910817→	01.88-04.00		6	<b>0 432 231 736</b>	<b>0 986 430 178</b>
		115	OM 356.956 (366) A <Euro 1>	01.88-04.00		6	<b>0 432 231 722</b>	<b>0 986 430 214</b>
, L	6,0	100	OM 356.955 (366) A <Euro 1>	01.92-04.00		6	<b>0 432 231 722</b>	<b>0 986 430 214</b>
				01.92-09.01		6	<b>0 432 231 722</b>	<b>0 986 430 214</b>
L	6,0	92	OM 356.950 A (366) <Euro 1>	01.94-09.01		6	<b>0 432 231 824</b>	<b>0 986 430 046</b>
			OM 356.954 A (366) <Euro 1>	01.94-09.01		6	<b>0 432 231 722</b>	<b>0 986 430 214</b>
		92/100	OM 366.947 A (366); OM 366.949 A (366); OM 366.955 A (366)	01.94-09.01		6	<b>0 432 231 736</b>	<b>0 986 430 178</b>
		100	OM 357.912 LA (366) <Euro 2>	01.94-09.01		6	<b>0 432 131 768</b>	
		120	OM 357.913 (366) LA <EURO 2>	09.91-09.01		6	<b>0 432 131 793</b>	
<b>U 1550 L</b>	6,0	100	OM 356.955 <(366)A Euro1>	09.91-08.02		6	<b>0 432 231 722</b>	<b>0 986 430 214</b>
			OM 357.912 LA	05.88-04.00		6	<b>0 432 131 768</b>	
		115	OM 356.956 <Euro1>	01.92-04.00		6	<b>0 432 231 722</b>	<b>0 986 430 214</b>







<b>U 1550 L</b>	6,0	115	OM 366.956 A							
			Mot.-Nr. →..910816	05.88-04.00	6	<b>0 432 231 824</b>	<b>0 986 430 046</b>			
			Mot.-Nr. ...910817→	05.88-04.00	6	<b>0 432 231 736</b>	<b>0 986 430 178</b>			
			120 OM 357.913 LA	05.88-04.00	6	<b>0 432 131 793</b>				
			125 OM 366.963 A	01.90-04.00	6	<b>0 432 231 823</b>	<b>0 986 430 045</b>			
			155 OM 357.924 LA <Euro 2>	05.88-04.00	6	<b>0 432 131 794</b>	<b>0 986 430 252</b>			
			157 OM 356... <Euro1>	01.92-04.00	6	<b>0 432 231 688</b>	<b>0 986 430 221</b>			
			OM 366.984 LA	05.88-04.00	6	<b>0 432 231 770</b>				
			177 OM 356.980 <(366)LA Euro1>	03.90-04.00	6	<b>0 432 231 688</b>	<b>0 986 430 221</b>			
<b>U 1600</b>	6,0	92/100	OM 356.954 A (366) <Euro 1>;	01.88-02.01	6	<b>0 432 231 722</b>	<b>0 986 430 214</b>			
			OM 356.955 (366) A <Euro 1>							
			92-115 OM 366.947,948,949 A							
			Mot.-Nr. →..910816	01.88-04.00	6	<b>0 432 231 824</b>	<b>0 986 430 046</b>			
			Mot.-Nr. ...910817→	01.88-04.00	6	<b>0 432 231 736</b>	<b>0 986 430 178</b>			
			100 OM 357.912 LA (366) <Euro 2>	11.92-09.02	6	<b>0 432 131 768</b>				
			115 OM 356.956 (366) A <Euro 1>	09.91-04.00	6	<b>0 432 231 722</b>	<b>0 986 430 214</b>			
			132/157 OM 356.997 LA (366) <Euro 1>;	11.92-09.02	6	<b>0 432 231 688</b>	<b>0 986 430 221</b>			
			OM 356.998 LA (366) <Euro 1>							
			155 OM 357.924 (366) LA <Euro 2>	11.92-09.02	6	<b>0 432 131 794</b>	<b>0 986 430 252</b>			
177 OM 356.980 LA (366) <Euro 1>	05.91-09.02	6	<b>0 432 231 688</b>	<b>0 986 430 221</b>						
<b>U 1650 , L</b>	6,0	92/100/114/115	OM 356.954 (366) A <Euro 1>;	01.92-04.00	6	<b>0 432 231 722</b>	<b>0 986 430 214</b>			
			OM 356.955 (366) A <Euro 1>;							
			OM 356.956 (366) A <Euro 1>							
			115 OM 366.948 A							
			Mot.-Nr. →..910816	01.88-04.00	6	<b>0 432 231 824</b>	<b>0 986 430 046</b>			
			Mot.-Nr. ...910817→	01.88-04.00	6	<b>0 432 231 736</b>	<b>0 986 430 178</b>			
<b>U 1700 , T</b>	6,0	122	OM 356.957 (366) A <Euro1>	01.92-08.02	6	<b>0 432 231 722</b>	<b>0 986 430 214</b>			
			125 OM 366.963 A	09.88-02.01	6	<b>0 432 231 823</b>	<b>0 986 430 045</b>			
<b>U 1750 , L</b>	6,0	122	OM 356.957 (366) A <Euro1>	01.92-08.02	6	<b>0 432 231 722</b>	<b>0 986 430 214</b>			
			125 OM 366.963 A	09.88-02.01	6	<b>0 432 231 823</b>	<b>0 986 430 045</b>			
			127 OM 356.981 (366) LA	05.91-08.02	KOC	6	<b>0 432 231 732</b>			
<b>L</b>	6,0	150	OM 366.984 LA	09.88-02.01	6	<b>0 432 231 770</b>				
<b>U 1800 , T</b>	6,0	132	OM 356.998 (366) LA <Euro1>	04.92-08.02	6	<b>0 432 231 688</b>	<b>0 986 430 221</b>			
<b>U 1850 , L</b>	6,0	132	OM 356.998 (366) LA <Euro1>	04.92-08.02	6	<b>0 432 231 688</b>	<b>0 986 430 221</b>			
<b>U 2100</b>	6,0	155	OM 357.924 (366) LA <Euro 2>	09.89-02.01	6	<b>0 432 131 794</b>	<b>0 986 430 252</b>			
			OM 357.924 <(366)LA Euro2>	05.91-08.02	6	<b>0 432 131 794</b>	<b>0 986 430 252</b>			
<b>, L</b>	6,0	157	OM 366.984 LA	09.89-02.01	6	<b>0 432 231 770</b>				
		157/177	OM 356.980 (366) LA; OM 356.997 (366) LA	05.91-08.02	6	<b>0 432 231 688</b>	<b>0 986 430 221</b>			
			<Euro1>							
<b>U 2150 , L</b>	6,0	155	OM 357.924 <(366)LA Euro2>	05.91-08.02	6	<b>0 432 131 794</b>	<b>0 986 430 252</b>			
			157 OM 366.984 LA	09.89-02.01	6	<b>0 432 231 770</b>				
			157/177 OM 356.980 <(366)LA Euro1>; OM 356.997	05.91-08.02	6	<b>0 432 231 688</b>	<b>0 986 430 221</b>			
			<(366)LA Euro1>							
<b>U 2400 , TG</b>	6,0	177	OM 356.980 LA (366) <Euro 1>; OM 356.980	05.91-08.02	6	<b>0 432 231 688</b>	<b>0 986 430 221</b>			
			<(366)LA Euro1>							
<b>U 2450</b>	6,0	177	OM 356.980 <(366)LA Euro1>	07.93-08.02	6	<b>0 432 231 688</b>	<b>0 986 430 221</b>			
<b>U 3000/4000 [437]</b>	4,3	110	OM 904.953 LA <Euro3>	09.02→	4	<b>0 432 191 394</b>				
			130 OM 904.952 LA <Euro3>	09.02→	4	<b>0 432 193 438</b>				
<b>U 4000 [437]</b>	4,8	160	OM 924.931 <OM 924 LA (Euro 5)>	04.09→	4	<b>0 432 193 421</b>				
<b>U 5000 [437]</b>	4,3	160	OM 924.916 <Euro 3>	03.03→	4	<b>0 432 191 303</b>				
			4,8 160 OM 924.931 <OM 924 LA (Euro 5)>	04.09→	4	<b>0 432 193 421</b>				
			6,4 170 OM 906.935 LA <Euro 3>	03.03→	6	<b>0 432 191 301</b>				
<b>UX</b>										
<b>100</b>	2,9	85-90	OM 602.989 <DE 29 LA>	08.96-09.01	5	<b>0 432 193 758</b>				
						5	<b>0 432 193 768<sup>1</sup></b>			
<b>Vario</b>										
<b>512 D [T2W]</b>	2,9	90	OM 602.984 LA <Euro 2>	09.96-01.01	FE2	5	<b>0 432 193 623<sup>1</sup></b>			
						5	<b>0 432 193 625</b>			
						Mot.-Nr. →..044623	09.96-01.01	5	<b>0 432 193 758</b>	
								ATW	5	<b>0 432 193 768<sup>1</sup></b>
			Mot.-Nr. ...044624→	09.96-01.01	5	<b>0 432 193 637<sup>1</sup></b>				
					5	<b>0 432 193 639</b>				







◀ MERCEDES-BENZ

<b>612 D [T2W]</b>	2,9	90	OM 602.984,985 LA <Euro 2>	09.96-01.01	FE2	5	<b>0 432 193 623</b> <sup>1</sup>			
						5	<b>0 432 193 625</b>			
								5	<b>0 432 193 758</b>	
								5	<b>0 432 193 768</b> <sup>1</sup>	
								5	<b>0 432 193 637</b> <sup>1</sup>	
			Mot.-Nr. →..044623	09.96-01.01		5	<b>0 432 193 758</b>			
			Mot.-Nr. ..044624→	09.96-01.01	ATW	5	<b>0 432 193 637</b> <sup>1</sup>			
						5	<b>0 432 193 639</b>			
<b>614 D [T2W]</b>	4,2	100	OM 904.914 LA <Euro 3>	01.01-09.06		4	<b>0 432 193 480</b>			
						4	<b>0 432 191 526</b>			
	4,3	100	OM 904.908 LA <Euro 2>	09.96-01.01		4	<b>0 432 193 480</b>			
						4	<b>0 432 191 526</b>			
<b>615 D [T2W]</b>	4,2	110	OM 904.936 LA <Euro 2>	01.01-09.06		4	<b>0 432 193 480</b>			
						4	<b>0 432 191 526</b>			
	4,3	112	OM 904.923 LA <Euro 2>	10.98-01.01		4	<b>0 432 193 480</b>			
						4	<b>0 432 191 526</b>			
<b>618 D [T2W]</b>	4,2	130	OM 904.964 LA <Euro 3>	06.03-09.06		4	<b>0 432 191 396</b>			
						4	<b>0 432 193 438</b>			
<b>810, DT [T2W]</b>	4,2	75	OM 904.904 LA <Euro 2>	09.96-09.06		4	<b>0 432 193 480</b>			
						4	<b>0 432 191 526</b>			
<b>812 [T2W]</b>	2,9	90	OM 602... <Euro 2>	09.96-01.01	FE2	5	<b>0 432 193 623</b> <sup>1</sup>			
						5	<b>0 432 193 625</b>			
								5	<b>0 432 193 758</b>	
								5	<b>0 432 193 768</b> <sup>1</sup>	
								5	<b>0 432 193 637</b> <sup>1</sup>	
			Mot.-Nr. →..044623	09.96-01.01		5	<b>0 432 193 758</b>			
			Mot.-Nr. ..044624→	09.96-01.01	ATW	5	<b>0 432 193 637</b> <sup>1</sup>			
						5	<b>0 432 193 639</b>			
<b>D [T2W]</b>	2,9	90	OM 602.984,985 LA <Euro 2>	09.96-09.06	FE2	5	<b>0 432 193 623</b> <sup>1</sup>			
						5	<b>0 432 193 625</b>			
								5	<b>0 432 193 758</b>	
								5	<b>0 432 193 768</b> <sup>1</sup>	
								5	<b>0 432 193 637</b> <sup>1</sup>	
			Mot.-Nr. →..044623	09.96-09.06		5	<b>0 432 193 758</b>			
			Mot.-Nr. ..044624→	09.96-09.06	ATW	5	<b>0 432 193 637</b> <sup>1</sup>			
						5	<b>0 432 193 639</b>			
<b>814, D [T2W]</b>	4,3	100	OM 904.908 LA <Euro 2>	09.96-01.01		4	<b>0 432 193 480</b>			
						4	<b>0 432 191 526</b>			
<b>D [T2W]</b>	4,2	100	OM 904.914 LA <Euro 3>	01.01-09.06		4	<b>0 432 193 480</b>			
						4	<b>0 432 191 526</b>			
<b>DA [T2W]</b>	4,3	100	OM 904... <Euro 2>	09.96-01.01		4	<b>0 432 193 480</b>			
						4	<b>0 432 191 526</b>			
<b>815 [T2W]</b>	4,3	112	OM 904.923 LA <Euro 2>	09.96-01.01		4	<b>0 432 193 480</b>			
						4	<b>0 432 191 526</b>			
<b>D [T2W]</b>	4,2	110	OM 904.936 LA <Euro 2>	01.01-09.06		4	<b>0 432 193 480</b>			
						4	<b>0 432 191 526</b>			
<b>D, DA [T2W]</b>	4,3	110-112	OM 904... <Euro 2>	01.96-01.01		4	<b>0 432 193 480</b>			
						4	<b>0 432 191 526</b>			
<b>818 D [T2W]</b>	4,2	130	OM 904.964 LA <Euro 3>	06.03-09.06		4	<b>0 432 191 396</b>			
						4	<b>0 432 193 438</b>			
<b>D/DA [T2W]</b>	4,2	130	OM 904.964 (904 LA)	09.06-03.09		4	<b>0 432 193 438</b>			
<b>Vito</b>										
<b>108 D [638]</b>	2,3	60	OM 601.942	11.95-09.03		4	<b>0 432 217 157</b>	<b>0 986 430 197</b>		
<b>110 D [638]</b>	2,3	72	OM 601.970	11.95-09.03		4	<b>0 432 217 290</b>	<b>0 986 430 505</b>		
						4	<b>0 432 217 266</b>	<b>0 986 430 247</b>		
<b>Zetros</b>										
<b>1833</b>	7,2	240	OM 926.935 <(926 LA) Euro 3>	09.08→		6	<b>0 432 191 303</b>			
						6	<b>0 432 193 421</b>			





<b>2733</b>	7,2	240	OM 926.935 <(926 LA) Euro 3> OM 926.947 <(926 LA) Euro 5>	09.08→ 09.09→	6 6	<b>0 432 191 303</b> <b>0 432 193 421</b>
<b>5t</b>						
<b>508 D</b>	2,3	58	OM 601.941	03.89-02.01	4	<b>0 432 217 161 0 986 430 172</b>
<b>6t</b>						
<b>609 D</b>	4,0	63	OM 364.919 <Euro 1> OM 364.906	02.92-09.01 04.86-02.01	4 4	<b>0 432 231 713 0 986 430 210</b> <b>0 432 231 736 0 986 430 178</b>
<b>611 D</b>	4,0	77	OM 354.902 (364) LA <Euro 2> Mot.-Nr. →..379673 Mot.-Nr. →..379674→	06.94-09.01 TW 06.94-09.01 TW	4 4	<b>0 432 131 794 0 986 430 252</b> <b>0 432 131 793</b>
<b>7t</b>						
<b>709</b>	4,0	66	OM 364	04.91-03.98	4	<b>9 430 082 311</b>
[LK]	4,0	63	OM 364.918 <Euro 1>	02.92-12.99	4	<b>0 432 231 713 0 986 430 210</b>
D	4,0	63	OM 364.919,921 <Euro 1> OM 364.906,912	02.92-02.01 04.86-02.01	4 4	<b>0 432 231 713 0 986 430 210</b> <b>0 432 231 736 0 986 430 178</b>
<b>711 [LK]</b>	4,0	77	OM 354.900 (364) LA <Euro 2> Mot.-Nr. →..379673 Mot.-Nr. →..559756	03.94-12.99 03.94-12.99	4 4	<b>0 432 131 794 0 986 430 252</b> <b>0 432 131 793</b>
	4,3	90	OM 904.905 LA <Euro 2> Komp.Nr. 505047/10	03.96-12.99 TNK	4	<b>0 432 193 480</b>
D	4,0	77	OM 354.90... <Euro 2> Mot.-Nr. →..379673 Mot.-Nr. →..379674→ OM 364.957 A <Euro 1>	06.94-02.01 06.94-02.01 02.92-02.01	4 4 4	<b>0 432 131 794 0 986 430 252</b> <b>0 432 131 793</b> <b>0 432 231 722 0 986 430 214</b>
		85	OM 364.950,952 A	04.86-02.01	4	<b>0 432 231 823 0 986 430 045</b>
<b>714 D</b>	4,0	103	OM 354... <Euro 2>	06.94-02.01	4	<b>0 432 131 794 0 986 430 252</b>
<b>8t</b>						
<b>809 [LK]</b>	4,0	63	OM 364.918 <Euro 1>	02.92-12.99	4	<b>0 432 231 713 0 986 430 210</b>
D, DT	4,0	63	OM 364.920 <Euro 1>; OM 364.921 <Euro 1>	02.92-02.01	4	<b>0 432 231 713 0 986 430 210</b>
		66	OM 364.906; OM 364.911; OM 364.912	04.86-02.01	4	<b>0 432 231 736 0 986 430 178</b>
<b>810 D</b>	4,0	77	OM 354.903 (364) LA <Euro 2> Mot.-Nr. →..379673 Mot.-Nr. →..379674→	06.94-02.01 06.94-02.01	4 4	<b>0 432 131 794 0 986 430 252</b> <b>0 432 131 793</b>
<b>811 [LK]</b>	4,0	77	OM 354.900 (364) LA <Euro 2> Mot.-Nr. →..379673 Mot.-Nr. →..559756	03.94-12.99 03.94-12.99	4 4	<b>0 432 131 794 0 986 430 252</b> <b>0 432 131 793</b>
	4,3	90	OM 904.905 LA <Euro 2> Komp.Nr. 505047/10	03.96-12.99 TNK	4	<b>0 432 193 480</b>
D	4,0	77	OM 364.958 A <Euro 1>	02.92-02.01	4	<b>0 432 231 722 0 986 430 214</b>
		85	OM 364.950,952 A; OM 364.954 A	04.86-02.01	4	<b>0 432 231 823 0 986 430 045</b>
DT	4,0	77	OM 354.901 (364) LA <Euro 2> Mot.-Nr. →..379673 Mot.-Nr. →..379674→	06.94-02.01 06.94-02.01	4 4	<b>0 432 131 794 0 986 430 252</b> <b>0 432 131 793</b>
<b>814 , F, KO, L, LO, O [LK]</b>	6,0	95	OM 356.901 (366) <Euro 1>; OM 356.902 (366) <Euro 1>; OM 356.905 <Euro 1>; OM 356.906 (366) <Euro 1>; OM 356.911 <Euro 1>	02.92-12.99	6	<b>0 432 231 713 0 986 430 210</b>
, F, L, LO [LK]	4,3	100	OM 904.906 LA <Euro 2>	03.96-12.99	4	<b>0 432 193 480</b>
, F, L, LO, O [LK]	4,0	103	OM 354.920 (364) LA <Euro 2>; OM 354.921 (364) LA <Euro 2>; OM 354.922 (364) LA <Euro 2>	03.94-12.99	4	<b>0 432 131 794 0 986 430 252</b>
D, DA	4,0	100	OM 364.981 LA; OM 364.984 LA OM 364.986 LA <Euro 1>; OM 364.987 LA <Euro 1>	11.87-02.01 02.92-02.01	4 4	<b>0 432 231 770</b> <b>0 432 231 688 0 986 430 221</b>
		103	OM 354.924 (364) LA <Euro 2>; OM 354.925 (364) LA <Euro 2>	06.94-02.01	4	<b>0 432 131 794 0 986 430 252</b>
<b>817 [LK]</b>	6,0	125	OM 357.900 (366) LA <Euro 2> Mot.-Nr. →..406924 Mot.-Nr. →..406925→	03.94-12.99 03.94-12.99	6 6	<b>0 432 131 794 0 986 430 252</b> <b>0 432 131 793</b>
, F, L, LO [LK]	4,3	125	OM 904.907 LA <Euro 2> Mot.-Nr. →..018752→..022247 Mot.-Nr. →..022248→	03.96-12.99 03.96-12.99	4 4	<b>0 432 193 480</b> <b>0 432 191 526</b>





◀ MERCEDES-BENZ

<b>817</b> , F, L, LO, O [LK]	6,0	116/121	OM 356.948 (366) A <Euro 1>; OM 356.951 (366) A <Euro 1>; OM 366.942 (366) A <Euro 1>; OM 366.943 (366) A <Euro 1>	02.92-12.99	6	<b>0 432 231 722</b>	<b>0 986 430 214</b>	
F [LK]	6,0	125	OM 357.908 (366) LA <Euro 2> Mot.-Nr. →..406924 Mot.-Nr. ...406925→	03.94-12.99 03.94-12.99	6 6	<b>0 432 131 794</b> <b>0 432 131 793</b>	<b>0 986 430 252</b>	
L [LK]	6,0	125	OM 357... <Euro 2> Mot.-Nr. →..406924 Mot.-Nr. ...406925→	03.94-12.99 03.94-12.99	6 6	<b>0 432 131 794</b> <b>0 432 131 793</b>	<b>0 986 430 252</b>	
LO [LK]	6,0	125	OM 357.917 (366) LA <Euro 2> Mot.-Nr. →..406924 Mot.-Nr. ...406925→	03.94-12.99 03.94-12.99	6 6	<b>0 432 131 794</b> <b>0 432 131 793</b>	<b>0 986 430 252</b>	
<b>9t</b>								
<b>L 911 B</b>	5,7	81/96 124	OM 352.906,990; OM 352.969 OM 353.911 A	10.68-02.01 01.72-02.01	6 6	<b>0 432 231 887</b> <b>0 432 231 870</b>	<b>0 986 430 056</b>	
<b>LA 911 B</b>	5,7	81/96 124	OM 352.906,990; OM 352.969 OM 353.911 A	10.68-02.01 01.72-02.01	6 6	<b>0 432 231 887</b> <b>0 432 231 870</b>	<b>0 986 430 056</b>	
<b>914</b> , AK, KO [LK]	6,0	95	OM 356.901 (366) <Euro 1>; OM 356.901,911 (366) <Euro 1>; OM 356.903 (366) <Euro 1>	02.92-12.99	6	<b>0 432 231 713</b>	<b>0 986 430 210</b>	
<b>917</b> [LK]	6,0	125	OM 357.900 (366) LA <Euro 2> Mot.-Nr. →..406924 Mot.-Nr. ...406925→	03.94-12.99 03.94-12.99	6 6	<b>0 432 131 794</b> <b>0 432 131 793</b>	<b>0 986 430 252</b>	
, KO [LK]	4,3	125	OM 904.907 LA <Euro 2> Mot.-Nr. ...018752→..022247 Mot.-Nr. ...022248→	03.96-12.99 03.96-12.99	4 4	<b>0 432 193 480</b> <b>0 432 191 526</b>		
AF [LK]	6,0	116 125	OM 356... <Euro 1> OM 357.909,910 LA <Euro 2> Mot.-Nr. →..406924 Mot.-Nr. ...406925→	12.92-12.99 03.94-12.99 03.94-12.99	6 6 6	<b>0 432 231 722</b> <b>0 432 131 794</b> <b>0 432 131 793</b>	<b>0 986 430 214</b> <b>0 986 430 252</b>	
AK [LK]	6,0	125	OM 357.906 (366) LA <Euro 2> Mot.-Nr. →..406924 Mot.-Nr. ...406925→	03.94-12.99 03.94-12.99	6 6	<b>0 432 131 794</b> <b>0 432 131 793</b>	<b>0 986 430 252</b>	
KO [LK]	6,0	125	OM 357... <Euro 2> Mot.-Nr. →..406924 Mot.-Nr. ...406925→	03.94-12.99 03.94-12.99	6 6	<b>0 432 131 794</b> <b>0 432 131 793</b>	<b>0 986 430 252</b>	
<b>11t</b>								
<b>L 1113 B</b>	5,7	96 124	OM 352.908 OM 353.913 A (352)	10.69-02.01 01.72-02.01	6 6	<b>0 432 231 887</b> <b>0 432 231 870</b>	<b>0 986 430 056</b>	
<b>L 1117</b>	5,7	124	OM 352 A	03.95-08.98	6	<b>9 430 082 334</b>		
<b>LA 1113 B</b>	5,7	96 124-130	OM 352.908 OM 353.913 A (352)	10.69-02.01 01.72-02.01	6 6	<b>0 432 231 887</b> <b>0 432 231 870</b>	<b>0 986 430 056</b>	
<b>LKO 1113 B</b>	5,7	96	OM 352.908	10.69-02.01	6	<b>0 432 231 887</b>	<b>0 986 430 056</b>	
<b>O 1114 L</b> [LK]	6,0	95	OM 356.907 (366) <Euro 1>	02.92-12.99	6	<b>0 432 231 713</b>	<b>0 986 430 210</b>	
<b>1114</b> , AK, L, O [LK]	6,0	95	OM 356.903 (366) <Euro 1>; OM 356.904 (366) <Euro 1>; OM 356.907 (366) <Euro 1>	02.92-12.99	6	<b>0 432 231 713</b>	<b>0 986 430 210</b>	
<b>1117</b> [LK]	6,0	125	OM 357.902 (366) LA <Euro 2> Mot.-Nr. →..406924 Mot.-Nr. ...406925→	03.94-12.99 03.94-12.99	6 6	<b>0 432 131 794</b> <b>0 432 131 793</b>	<b>0 986 430 252</b>	
, A, L, LO, O [LK]	6,0	116	OM 356.947 (366) A <Euro 1>; OM 356.949 (366) A <Euro 1>; OM 366.941 A <Euro 1>	02.92-12.99	6	<b>0 432 231 722</b>	<b>0 986 430 214</b>	
, L [LK]	6,0	125	OM 357.901 (366) LA <Euro 2> Mot.-Nr. →..406924 Mot.-Nr. ...406925→	03.94-12.99 03.94-12.99	6 6	<b>0 432 131 794</b> <b>0 432 131 793</b>	<b>0 986 430 252</b>	
, L, LO [LK]	4,3	125	OM 904.907 LA <Euro 2> Mot.-Nr. ...018752→..022247 Mot.-Nr. ...022248→	03.96-12.99 03.96-12.99	4 4	<b>0 432 193 480</b> <b>0 432 191 526</b>		
A [LK]	6,0	125	OM 357.906 (366) LA <Euro 2> Mot.-Nr. →..406924 Mot.-Nr. ...406925→	03.94-12.99 03.94-12.99	6 6	<b>0 432 131 794</b> <b>0 432 131 793</b>	<b>0 986 430 252</b>	





<b>1117 L [LK]</b>	6,0	125	OM 357.918 (366) LA <Euro 2>					
			Mot.-Nr. →..406924	03.94-12.99	6	<b>0 432 131 794</b>	<b>0 986 430 252</b>	
			Mot.-Nr. ...406925→	03.94-12.99	6	<b>0 432 131 793</b>		
<b>LO [LK]</b>	6,0	125	OM 357.919 (366) LA <Euro 2>					
			Mot.-Nr. →..406924	03.94-12.99	6	<b>0 432 131 794</b>	<b>0 986 430 252</b>	
			Mot.-Nr. ...406925→	03.94-12.99	6	<b>0 432 131 793</b>		
<b>O [LK]</b>	6,0	125	OM 366.971 A	03.93-12.99	6	<b>0 432 231 823</b>	<b>0 986 430 045</b>	
<b>1120 , L, LO [LK]</b>	6,0	155	OM 357... <Euro 2>; OM 357.929 (366) LA <Euro 2>; OM 357.932 (366) LA <Euro 2>	06.94-12.99	6	<b>0 432 131 794</b>	<b>0 986 430 252</b>	
<b>, L, LO, O [LK]</b>	6,0	155	OM 356... <(366 LA) Euro 1>; OM 356.993 (366) LA <Euro 1>	02.92-12.99	6	<b>0 432 231 688</b>	<b>0 986 430 221</b>	
<b>AF, F [LK]</b>	6,0	155	OM 356... <Euro 1>; OM 356.996 (366) LA <Euro 1>	10.92-12.99	6	<b>0 432 231 688</b>	<b>0 986 430 221</b>	
<b>LO [LK]</b>	6,0	150	OM 366.993 LA	02.92-12.99	6	<b>0 432 231 770</b>		
<b>1124 AF, F [LK]</b>	6,0	177	OM 356... <Euro 1>	03.92-12.99	6	<b>0 432 231 688</b>	<b>0 986 430 221</b>	
<b>12t</b>								
<b>1217 KO [LK]</b>	6,0	125	OM 357... <Euro 2>					
			Mot.-Nr. →..406924	03.94-12.99	6	<b>0 432 131 794</b>	<b>0 986 430 252</b>	
			Mot.-Nr. ...406925→	03.94-12.99	6	<b>0 432 131 793</b>		
<b>13t</b>								
<b>L 1313</b>	5,7	96	OM 352.938,963 (352)	01.67-02.01	6	<b>0 432 231 887</b>	<b>0 986 430 056</b>	
		124	OM 353.913 A (352)	01.72-02.01	6	<b>0 432 231 870</b>		
<b>L 1319</b>	6,0	142	OM 366 LA <376.981,88, 98>	12.85-12.01	6	<b>9 430 082 291</b>		
<b>LA 1313</b>	5,7	96	OM 352.938,963 (352)	01.67-02.01	6	<b>0 432 231 887</b>	<b>0 986 430 056</b>	
		124	OM 353.913 A (352)	01.72-02.01	6	<b>0 432 231 870</b>		
<b>LF 1313</b>	5,7	115	OM 352.968 (352)	01.67-02.01	6	<b>0 432 231 887</b>	<b>0 986 430 056</b>	
<b>1314 , AK [LK]</b>	6,0	95	OM 356.909 (366) <Euro 1>; OM 356.910 (366) <Euro 1>	12.92-12.99	6	<b>0 432 231 713</b>	<b>0 986 430 210</b>	
<b>1317 , AK, L [LK]</b>	6,0	116	OM 356.944 (366) A <Euro 1>; OM 356.945 (366) A <Euro 1>	12.92-12.99	6	<b>0 432 231 722</b>	<b>0 986 430 214</b>	
<b>, KO, L [LK]</b>	4,3	125	OM 904.907 LA <Euro 2>					
			Mot.-Nr. ...018752→..022247	03.96-12.99	4	<b>0 432 193 480</b>		
			Mot.-Nr. ...022248→	03.96-12.99	4	<b>0 432 191 526</b>		
	6,0	125	OM 357... <Euro 2>					
			Mot.-Nr. →..406924	03.94-12.99	6	<b>0 432 131 794</b>	<b>0 986 430 252</b>	
			Mot.-Nr. ...406925→	03.94-12.99	6	<b>0 432 131 793</b>		
<b>AK [LK]</b>	6,0	125	OM 357.907 (366) LA <Euro 2>					
			Mot.-Nr. →..406924	03.94-12.99	6	<b>0 432 131 794</b>	<b>0 986 430 252</b>	
			Mot.-Nr. ...406925→	03.94-12.99	6	<b>0 432 131 793</b>		
		155	OM 356.995 (366) LA <Euro 1>	12.92-12.99	6	<b>0 432 231 688</b>	<b>0 986 430 221</b>	
<b>1320 , L [LK]</b>	6,0	155	OM 357... <Euro 2>; OM 357.932 (366) LA <Euro 2>	03.94-12.99	6	<b>0 432 131 794</b>	<b>0 986 430 252</b>	
		155/177	OM 356... <(366 LA) Euro 1>; OM 356.983 (366) LA <Euro 1>; OM 356.992 (366) LA <Euro 1>	12.92-12.99	6	<b>0 432 231 688</b>	<b>0 986 430 221</b>	
<b>1324 [LK]</b>	6,0	177	OM 357.94... <Euro 2>					
			Mot.-Typ 357.948	03.94-12.99	6	<b>0 432 131 794</b>	<b>0 986 430 252</b>	
<b>, L [LK]</b>	6,0	170/177	OM 356.983 (366) LA <Euro 1>; OM 366.999 LA <Euro 1>	01.91-02.01	6	<b>0 432 231 688</b>	<b>0 986 430 221</b>	
<b>L [LK]</b>	6,0	150	OM 366.997 LA <Euro 1>	01.91-02.01	6	<b>0 432 231 770</b>		
		177	OM 357.948 (366) LA <Euro 2>	03.94-12.98	6	<b>0 432 131 794</b>	<b>0 986 430 252</b>	
<b>14t</b>								
<b>L 1414</b>	6,0	100	OM 366					
			Mot.-Nr. →..088396	04.89-04.99	6	<b>0 432 231 824</b>	<b>0 986 430 046</b>	
			Mot.-Nr. ...088397→	04.89-04.99	6	<b>9 430 082 311</b>		
<b>15t</b>								
<b>L 1513</b>	5,7	96/110	OM 352.936; OM 352.937	10.69-02.01	6	<b>0 432 231 887</b>	<b>0 986 430 056</b>	
		124	OM 353.912 A	01.72-02.01	6	<b>0 432 231 870</b>		
<b>LA 1513</b>	5,7	96/110	OM 352.936; OM 352.937	10.69-02.01	6	<b>0 432 231 887</b>	<b>0 986 430 056</b>	
		124	OM 353.912 A	01.72-02.01	6	<b>0 432 231 870</b>		
<b>LPS 1525</b>	10,0	175/186	OM 429.951 LA; OM 429.953,955 LA	01.85-12.01	5	<b>0 432 231 766</b>	<b>0 986 430 133</b>	
<b>1514 , L [LK]</b>	6,0	95	OM 356.908 (366) <Euro 1>	12.92-12.99	6	<b>0 432 231 713</b>	<b>0 986 430 210</b>	





◀ MERCEDES-BENZ

<b>1517</b> [LK]	6,0	125	OM 357... <Euro 2> Mot.-Nr. →..406924 Mot.-Nr. ..406925→	03.94-12.99 03.94-12.99	6 6	<b>0 432 131 794</b> <b>0 986 430 252</b>	<b>0 432 131 793</b>
, L [LK]	4,3	125	OM 904.907 LA <Euro 2> Mot.-Nr. ..018752→..022247 Mot.-Nr. ..022248→	03.96-12.99 03.96-12.99	4 4	<b>0 432 193 480</b> <b>0 432 191 526</b>	
	6,0	116	OM 356... <Euro 1>; OM 356.953 (366) A <Euro 1>	12.92-12.99	6	<b>0 432 231 722</b>	<b>0 986 430 214</b>
L [LK]	6,0	125	OM 357.962 (366) LA <Euro 2>	03.94-12.99	6	<b>0 432 131 794</b>	<b>0 986 430 252</b>
<b>1520</b> , L [LK]	6,0	155	OM 356.990 (366) LA <Euro 1> OM 357.922 (366) LA <Euro 2>; OM 357.930 (366) LA <Euro 2>	12.92-12.99 03.94-12.99	6 6	<b>0 432 231 688</b> <b>0 432 131 794</b>	<b>0 986 430 221</b> <b>0 986 430 252</b>
<b>1524</b> , L [LK]	6,0	170/177	OM 356.999 (366) LA <Euro 1>; OM 366.999 LA <Euro 1>	02.91-02.01	6	<b>0 432 231 688</b>	<b>0 986 430 221</b>
<b>17t</b>							
<b>1720</b> [LK]	6,0	150	OM 366.995 LA	01.84-12.98	6	<b>0 432 231 770</b>	
[MK]	6,0	150	OM 356.985 (366) LA	01.91-02.01	6	<b>0 432 231 770</b>	
<b>1724</b> [LK]	6,0	170	OM 366.999 LA <Euro 1>	01.91-02.01	6	<b>0 432 231 688</b>	<b>0 986 430 221</b>
<b>18t</b>							
<b>1820</b> , L [MK]	6,0	155	OM 356.984 (366) LA	01.91-02.01	6	<b>0 432 231 770</b>	
<b>1827</b> L [MK]	9,6	200	OM 401.973,77,91 LA <Euro 1>	02.91-02.01	6	<b>0 432 231 665</b>	<b>0 986 430 205</b>
<b>1831</b> [MK]	12,8	280	OM 402.987 <Euro 1>	12.90-02.01	8	<b>0 432 231 665</b>	<b>0 986 430 205</b>
, L [MK]	9,6	230	OM 401... <Euro 1>; OM 401.972,79,93 LA <Euro 1>	12.90-02.01	6	<b>0 432 231 665</b>	<b>0 986 430 205</b>
<b>1834</b> , L [MK]	11,0	250	OM 441... <Euro 1> OM 445... <(441 LA) Euro 2> Mot.-Nr. →..859979 Mot.-Nr. ..859980→	01.91-02.01 01.94-02.01 01.94-02.01	6 6 6	<b>0 432 231 677</b> <b>0 432 131 801</b> <b>0 432 131 804</b> <sup>1</sup>	<b>0 986 430 211</b> <b>0 986 430 265</b> <b>0 986 430 326</b>
					6	<b>0 432 131 730</b> <sup>1</sup>	
<b>1838</b> , L [SK]	12,8	280	OM 402... <Euro 1>; OM 402.972,986 LA <Euro 1>	12.90-02.01	8	<b>0 432 231 665</b>	<b>0 986 430 205</b>
	14,6	320	OM 440... <Euro 1>; OM 440.978 LA <(442 LA) Euro 1>	12.90-02.01	8	<b>0 432 231 677</b>	<b>0 986 430 211</b>
<b>1850</b> , L [SK]	14,6	362	OM 442...	12.90-02.01	8	<b>0 432 231 663</b>	<b>0 986 430 093</b>
		370	OM 440... <Euro 1>; OM 440.973 (442) LA <Euro 1>	01.91-02.01	8	<b>0 432 231 677</b>	<b>0 986 430 211</b>
	15,0	370	OM 442.997 LA <Euro 1>	01.91-02.01	8	<b>0 432 231 677</b>	<b>0 986 430 211</b>
<b>19t</b>							
<b>L 1924</b>	11,6	177	OM 355.983 Mot.-Nr. →..527878 Mot.-Nr. ..527879→	05.79-02.01 07.84-02.01	6 6	<b>0 432 231 886</b> <b>0 432 231 775</b>	
<b>L 1928</b>	11,6	206	OM 355.969 A	05.79-02.01 KOC	6	<b>0 432 231 827</b>	
<b>20t</b>							
<b>2020</b> [LK]	6,0	150	OM 366.995 LA	01.84-12.98	6	<b>0 432 231 770</b>	
<b>2050</b> [SK]	14,6	362	OM 442...	01.91-02.01	8	<b>0 432 231 663</b>	<b>0 986 430 093</b>
	15,0	370	OM 442.997 LA <Euro 1>	01.91-02.01	8	<b>0 432 231 677</b>	<b>0 986 430 211</b>
S [SK]	14,6	370	OM 440.976 (422) LA <Euro 1>	01.91-02.01	8	<b>0 432 231 677</b>	<b>0 986 430 211</b>
<b>2055</b> [SK]	15,0	370	OM 442.997 LA <Euro 1>	01.91-02.01	8	<b>0 432 231 677</b>	<b>0 986 430 211</b>
<b>25t</b>							
<b>2534</b> , L [MK]	11,0	250	OM 441... <Euro 1>; OM 441.986 LA <Euro 1>	01.91-02.01	6	<b>0 432 231 677</b>	<b>0 986 430 211</b>
<b>26t</b>							
<b>L 2624</b>	11,6	177	OM 355.983,984 Mot.-Nr. →..527878 Mot.-Nr. ..527879→	01.78-02.01 01.78-02.01	6 6	<b>0 432 231 886</b> <b>0 432 231 775</b>	
<b>L 2628</b>	11,6	206	OM 355.969 A	11.78-02.01 KOC	6	<b>0 432 231 827</b>	
<b>30t</b>							
<b>3050</b> [SK]	15,0	370	OM 442.997 LA <Euro 1>	02.91-02.01	8	<b>0 432 231 677</b>	<b>0 986 430 211</b>
<b>32t</b>							
<b>3238</b> [SK]	12,8	280	OM 402... <Euro 1>	10.90-02.01	8	<b>0 432 231 665</b>	<b>0 986 430 205</b>
<b>3244</b> [SK]	14,6	320	OM 440... <Euro 1>	10.90-02.01	8	<b>0 432 231 677</b>	<b>0 986 430 211</b>
<b>44t</b>							
<b>4435</b> K [SK]	15,0	260	OM 442.959 A	10.89-02.01	8	<b>0 432 231 663</b>	<b>0 986 430 093</b>





## MITSUBISHI

Canter 35							
2.8 D Turbo [FB]	2,8	85	4M40	05.98-10.00	ZDA	4	9 430 610 435
D Turbo Interc. [FE]	2,8	85	4M40	05.98-10.00	ZDA	4	9 430 610 435
3C11 [FB]							
3C11 [FB]	3,0	81	4M42 <Euro 3>	01.05-03.06	ZDA	4	9 430 613 739
3S11 [FE]							
3S11 [FE]	3,0	81	4M42 <Euro 3>	01.05-03.06	ZDA	4	9 430 613 739
3.0 D Turbo [FB]							
3.0 D Turbo [FB]	3,0	92	4M42	08.01-02.05	ZDA	4	9 430 613 739
D Turbo Interc. [FE]	3,0	92	4M42-OAT	11.00-02.05	ZDA	4	9 430 613 739
Canter 55							
3.0 D Turbo Interc. [FE]	3,0	92	4M42-OAT	11.00-02.05	ZDA	4	9 430 613 739
5S13 [FE]							
5S13 [FE]	3,0	92	4M42-3A T1 <Euro 3>	01.05-03.06	ZDA	4	9 430 613 739
Fuso							
D	16,0	236	8DC91A	04.86-03.99	ZDA	8	9 430 613 766
L 200							
2.5 D Turbo	2,5	64	4D56	08.97-12.03	ZDA	4	9 430 610 179
L 300							
2.5 D Turbo	2,5	73-74	4D56	08.98-12.03	ZDA	4	9 430 610 420
L 300 Truck							
2.5 D Turbo [P]	2,5	64	4D56	06.94-12.01	ZDA	4	9 430 610 179
L 300 Van							
2.5 D Turbo 4WD, D 2WD [P]	2,5	51-53/ 62-64	4D56	06.94-12.01	ZDA	4	9 430 610 179

## MULTICAR

UX100							
2.9 TD, TD 4x4	2,9	85	OM 602.98... <DE 29 LA>				
			Mot.-Nr. 044336 045122→045360 045371→	01.99-08.10		5	0 432 193 623 <sup>1</sup>
			Mot.-Nr. → 044623	01.99-08.10		5	0 432 193 758
			Mot.-Nr. → 045121	01.99-08.10		5	0 432 193 637 <sup>1</sup>
			Mot.-Nr. 044336 045122→045360 045371→	01.99-08.10		5	0 432 193 625
			Mot.-Nr. 044624→045121	01.99-08.10		5	0 432 193 639

## NEFAZ NEFTEKAMSK

Serie 50000							
52996	9,2	265	PE265C <Euro 3>	01.08→		6	0 432 191 382
52997	9,2	228	PE228C <Euro 3>	01.08→		6	0 432 191 382
52999	12,6	315	XE315C <Euro 3>	12.06→		6	0 432 191 381

## NEOPLAN

Tourline							
2216 SHD, /3 SHD-L	12,0	301	D 2866 LOH34 <Euro 3>	11.03→		6	0 432 191 417 <sup>1</sup>
						6	0 432 191 419
	12,8	338	D2876 LOH03 <Euro 3>	11.03→		6	0 432 191 414 <sup>1</sup>
						6	0 432 191 416





**NISSAN**

<b>Atleon</b>							
110 3.0	3,0	81	BD-30Ti	09.99-05.01	4	0 432 193 727	
				06.01-01.04	4	0 432 193 533	
				02.04-10.06	4	0 432 193 487	
120 3.0	3,0	88	BD-30Ti	09.00-05.01	4	0 432 193 727	
				06.01-01.04	4	0 432 193 533	
				02.04-10.06	4	0 432 193 487	
165 6.0	6,0	120	B6-60TiL	06.01-08.06	6	0 432 193 548	
<b>Cabstar</b>							
3.5	3,5	87	FD35T	11.96-12.99 ZDA	4	9 430 611 356	
<b>Cabstar ZZ</b>							
4.6	4,6	90	FD46	11.99→ ZDA	4	9 432 610 995	
<b>Cabstar 20</b>							
3.2	3,2	70	QD32	10.99-12.00 ZDA	4	9 430 610 135	
				01.01→	4	9 430 613 540	
				ZDA	4	9 430 610 135	
<b>Civilian</b>							
4.2 D [W40]	4,2	99	TD42	03.91-03.01	0	9 430 610 065	
<b>Frontier</b>							
2.7 D [D22]	2,7	65-66	TD27	05.00-08.01	4	9 430 613 540	
				09.01→	4	9 430 613 540	
<b>L50</b>							
4.0 D	4,0	66	B4II	06.94-12.04	4	0 432 191 674	
<b>L60</b>							
4.0 D	4,0	66	B4II	06.94-12.04	4	0 432 191 674	
<b>M</b>							
5.9 D	5,9	110	B660TII	03.93-12.08	0	0 432 191 675	
<b>Trade</b>							
2.0 D	2,0	41/46	LD20E; LD20IE	10.90-12.98	4	0 432 217 230	
3.0 D	3,0	63	BD30	04.93-12.98 ZDA	4	9 430 610 116	
			BD30II	02.94-12.98 KOC	4	0 432 193 814	
<b>Urvan Bus</b>							
2.5 D [E25]	3,0	77-78	ZD30DD	07.01-11.12 ZDA	4	9 430 613 873	
<b>Vanette Cargo</b>							
2.3 D [C23M]	2,3	55	LD23	09.94-11.01	4	0 432 117 001	

**PAZ PAVLOVO**

<b>Serie 3000</b>							
3205	3,9	103	EQB-140-20 <Euro 2>	01.00→	4	0 432 193 549	

**PEGASO (ENASA)**

<b>Serie 1200</b>							
1236 .38 R, T, Troner	12,0	265	96R1EX	04.87→	KOC	6	0 432 291 615
<b>Serie 6000</b>							
6424	12,0	177	T3/00061	01.85→		6	0 432 291 607

**PEUGEOT**

<b>Boxer</b>							
1.9 D [U3]	1,9	50/51	DJY <XUD9>; D9B <XUD9A>	02.94-02.02	4	0 432 217 248 0 986 430 244	
				D Turbo [U3]	02.94-02.02	4	0 432 217 245
2.5 D [U3]	2,5	63	T9A <DJ5>	02.94-02.02	4	0 432 217 268 0 986 430 381	
				TDi [U3]	10.96-02.02	4	0 432 193 728
2.8 D	2,8	66	8140 63 <SOFIM 2800>	03.02-08.05	4	0 432 117 002	
				D [U3]	01.99-02.02	4	0 432 117 002





## RENAULT

RENAULT							
<b>Agora</b>							
Citybus	9,9	220	MIDR 06.20.45 J41	09.94-12.02	6	0 432 191 616	0 986 430 348
<b>Ares</b>							
300	9,8	221	MIDR 06.20.45 R41 <Euro2>	04.98-12.02	6	0 432 191 616	0 986 430 348
340	9,8	250	MIDR 06.20.45 M41 <Euro2>	04.98-12.02	6	0 432 191 630	0 986 430 349
<b>C</b>							
230 6.2 [Ligne 3]	6,2	166	MIDR 06.02.26 X <Euro 1>	05.92-10.98	6	0 432 131 823	
300 9.8 [Ligne 3]	9,8	222	MIDR 06.20.45 D/3 <Euro 1>	03.93-10.98 TW	6	0 432 291 672	0 986 430 336
				05.93-10.98 TW	6	0 432 291 558	0 986 430 337
340 9.8 ti [Ligne 3]	9,8	249	MIDR 06.20.45 E <Euro 1>	02.92-10.98 KOC	6	0 432 291 557	
<b>CBH</b>							
320 6x4, 6x4T, 6x6, 6x6T	12,0	236	MIDR 06.35.40 M3 <Euro 1>	10.92-10.98	6	0 432 231 702	
385 6x4, 6x4T, 6x6, 6x6T	12,0	283	MIDR 06.35.40 N3 <Euro 1>	10.92-10.98	6	0 432 231 667	0 986 430 330
<b>CLM</b>							
320 , TR	12,0	236	MIDR 06.35.40 M3 <Euro 1>	10.92-10.98	6	0 432 231 702	
385 , TR	12,0	283	MIDR 06.35.40 N3 <Euro 1>	10.92-10.98	6	0 432 231 667	0 986 430 330
<b>Iliade</b>							
GT, GTC, GTE	9,9	222	MIDR 06.20.45 R41 <Euro 2>	10.96-09.01	6	0 432 191 616	0 986 430 348
		250	MIDR 06.20.45 M41 <Euro 2>	10.96-09.01	6	0 432 191 630	0 986 430 349
GTX, GTXE, RTX, TEX	9,9	222	MIDR 06.20.45 R41 <Euro 2>	10.96-09.01	6	0 432 191 616	0 986 430 348
		250	MIDR 06.20.45 M41 <Euro 2>	10.96-09.01	6	0 432 191 630	0 986 430 349
RT, RTC, TE, TEC	9,9	222	MIDR 06.20.45 R41 <Euro 2>	10.96-09.01	6	0 432 191 616	0 986 430 348
		250	MIDR 06.20.45 M41 <Euro 2>	10.96-09.01	6	0 432 191 630	0 986 430 349
<b>Kerax</b>							
260	9,8	188	MIDR 06.20.45 C/4 <Euro 2>	06.97-12.02	6	0 432 191 616	0 986 430 348
300	9,8	219	MIDR 06.20.45 D/41 <Euro 2>	06.97-12.02	6	0 432 191 616	0 986 430 348
340	9,8	249	MIDR 06.20.45 E/41 <Euro 2>	06.97-12.02	6	0 432 191 630	0 986 430 349
<b>Magnum</b>							
390 AE	12,0	287	MIDR 06.24.65 A42 <Euro 2, V-Mac>	09.96-05.00	6	0 432 193 833	
400 E. TECH	12,0	294	MACK E-TECH A <Euro 3>	03.01-09.04	6	0 432 193 534	
		295	MIDR 06.24.65 A46 <Euro 2>	11.99-03.01	6	0 432 193 528	
430 AE	12,0	316	MIDR 06.24.65 B42 <Euro 2, V-Mac>	09.96-05.00	6	0 432 193 833	
440 E. TECH	12,0	324	MACK E-TECH B <Euro 3>	03.01-09.04	6	0 432 193 534	
			MIDR 06.24.65 B46 <Euro 2>	11.99-03.01	6	0 432 193 528	
470 AE	12,0	346	MIDR 06.24.65 C42 <Euro 2, V-Mac>	11.96-05.00	6	0 432 193 796	
480 E. TECH	12,0	347	MIDR 06.24.65 C46 <Euro 2>	11.99-03.01	6	0 432 193 528	
		353	MACK E-TECH C <Euro 3>	03.01-01.05	6	0 432 193 534	
560 AE	16,5	412	V-Mack-EE9-560 <Euro 2>	04.96-05.00	8	0 432 191 757	
<b>Mascott</b>							
90	2,8	63	8140.63.2585; 8140.63.2586	01.99-06.04	4	0 432 117 002	
<b>Master II</b>							
1.9 dTi 80	1,9	58	F9Q 770	01.00-09.03	4	0 432 193 610 <sup>1</sup>	
					4	0 432 193 611	
2.5 D	2,5	60	S8U 770 <8140.67.2620/29>; S8U 772	10.97-09.03	4	0 432 297 057	0 986 430 532
2.8 D	2,8	86	S8W 700	05.01-10.04	4	0 432 117 002	
dTi 110, dTi 120	2,8	81/84	S9W 700 <Sofim8140.43,2609/39>; S9W 702 <Sofim8140.43,2620/29>	10.97-09.03	4	0 432 193 757	0 986 430 522
<b>Midliner</b>							
CE 160	5,5	117	MIDS 06.02.12 B	10.86-12.01	6	0 432 281 695	0 986 430 342
M 150	6,2	110	MIDR 06.02.26 U4 <Euro 2>	05.96-12.00	6	0 432 131 742	
M 180	6,2	132	MIDR 06.02.26 V4(1) <Euro 2>	05.96-01.00	6	0 432 131 771	
M 250	6,2	184	MIDR 06.02.26 Y4(1) <Euro 2>	01.97-01.00	6	0 432 131 714	0 986 430 511
ME 160	5,5	117	MIDS 06.02.12 B	01.90-12.01	6	0 432 281 695	0 986 430 342
ME 210	6,2	154	MIDR 06.02.26 W4 <Euro 2>	03.99-12.01	6	0 432 131 767	0 986 430 347
SE 160	5,5	117	MIDS 06.02.12 B	01.86-12.01	6	0 432 281 695	0 986 430 342
<b>Midlum</b>							
210	6,2	154	MIDR 06.02.26 W/4 <Euro 2>	02.00-06.01	6	0 432 131 767	0 986 430 347
250	6,2	184	MIDR 06.02.26 Y/41 <Euro 2>	02.00-06.01	6	0 432 131 714	0 986 430 511
<b>Premium</b>							
210 Distribution	6,2	154	MIDR 06.02.26 W4 <Euro 2>	04.96-09.01	6	0 432 131 767	0 986 430 347





◀ RENAULT

<b>250</b> Distribution	6,2	184	MIDR 06.02.26 Y41 <Euro 2>	01.97-09.01	6	<b>0 432 131 714</b>	<b>0 986 430 511</b>	
<b>260</b> Distribution, SP	9,8	188	MIDR 06.20.45 C/4 <Euro 2>	04.96-12.01	6	<b>0 432 191 616</b>	<b>0 986 430 348</b>	
<b>300</b> Distribution, Route	9,8	219	MIDR 06.20.45 D/41 <Euro 2>	02.96-09.01	6	<b>0 432 191 616</b>	<b>0 986 430 348</b>	
<b>340</b> Distribution, Route	9,8	249	MIDR 06.20.45 E/41 <Euro 2>	04.96-03.01	6	<b>0 432 191 630</b>	<b>0 986 430 349</b>	
<b>R</b>								
<b>312</b>	9,8	129/144	MIDS 06.20.45 D; MIDS 06.20.45 F	11.86-12.03	6	<b>0 432 291 672</b>	<b>0 986 430 336</b>	
		152	MIDR 06.20.45 F3 <Euro 1>	10.92-12.03	KOC	6	<b>0 432 291 548</b>	
<b>332</b>	9,8	185	MIHS 06.20.45 A	06.89-12.03	6	<b>0 432 291 672</b>	<b>0 986 430 336</b>	
		186-191	MIHR 06.20.45 A3 <Euro 1>	09.92-12.03	6	<b>0 432 291 558</b>	<b>0 986 430 337</b>	
<b>S</b>								
<b>135</b> Midliner	4,1	100	MIDR 04.02.26 A/4 <Euro 2>	05.96-01.00	4	<b>0 432 131 732</b>		
<b>150</b> Midliner	6,2	110	MIDR 06.02.26 U4 <Euro 2>	05.96-01.00	6	<b>0 432 131 742</b>		
<b>180</b> Midliner	6,2	132	MIDR 06.02.26 V4 <Euro 2>	05.96-01.00	6	<b>0 432 131 771</b>		
<b>Traffic</b>								
<b>2.5</b> D 4x4	2,5	55	S8U 780	11.97-05.01	4	<b>0 432 297 057</b>	<b>0 986 430 532</b>	
<b>Traffic I</b>								
<b>2.5</b> D, D 4x4	2,5	55	S8U 782	11.97-05.01	BO	4	<b>0 432 297 057</b>	<b>0 986 430 532</b>
D 4x4	2,5	55	S8U 758; S8U 780	11.97-05.01	4	<b>0 432 297 057</b>	<b>0 986 430 532</b>	

**ROAZ**

<b>Serie 5000</b>							
<b>5236</b>	7,1	210	BF 6 M 1013 FC	12.09→	6	<b>0 432 191 326</b>	

**SCANIA**

<b>Serie 86</b>								
<b>BF</b> [BUS]	7,8	114	D 8.01 B09, .02 B09	06.82-01.99	KOC	6	<b>0 432 292 886</b>	
S [BUS]	7,8	155	DS 8.01 B10	06.82-01.99		6	<b>0 432 292 887</b>	
<b>Serie 93</b>								
<b>F</b> HL/HR [BUS]	8,5	127/167	DN 9.01; DS 9.06	06.90-01.98		6	<b>0 432 131 850</b>	<b>0 986 430 031</b>
<b>K</b> CL [BUS]	8,5	208	DSC 9.08 <Euro 1>	01.91-12.01		6	<b>0 432 131 850</b>	<b>0 986 430 031</b>
<b>Serie 94</b>								
<b>K</b> E, IB [BUS]	9,0	228	DSC 9.15 <Euro 2>	09.97-10.00		6	<b>0 432 131 692</b>	
<b>L</b> IB, UB [BUS]	9,0	162	DSC 9.11 <Euro 2>	03.97-08.02		6	<b>0 432 131 684</b>	
		169	DC 9.01 <Euro 3>; DC 9.04 <Euro 3>	04.99→		6	<b>0 432 191 494<sup>1</sup></b>	
						6	<b>0 432 191 495</b>	
		191	DC 9.02 <Euro 3>; DC 9.05 <Euro 3>	02.00→		6	<b>0 432 191 494<sup>1</sup></b>	
						6	<b>0 432 191 495</b>	
			DSC 9.12 <Euro 2>	03.97-10.01		6	<b>0 432 131 616</b>	
		221	DC 9.03 <Euro 3>	02.00→		6	<b>0 432 191 464<sup>1</sup></b>	
						6	<b>0 432 191 465</b>	
		228	DSC 9.13 <Euro 2>	03.97-08.02		6	<b>0 432 131 692</b>	
			DSC 9.15 <Euro 2>	03.97-10.00		6	<b>0 432 131 692</b>	
<b>N</b> UB [BUS]	9,0	162	DSC 9.11 <Euro 2>	09.97-08.02		6	<b>0 432 131 684</b>	
<b>P,R</b> 220	9,0	162	DSC 9.11 <Euro 2>	08.96-08.02		6	<b>0 432 131 684</b>	
230	9,0	169	DC 9.01 <Euro 3>; DC 9.04 <Euro 3>	04.99-09.04		6	<b>0 432 191 494<sup>1</sup></b>	
						6	<b>0 432 191 495</b>	
260	9,0	191	DC 9.02 <Euro 3>	02.00-09.04		6	<b>0 432 191 494<sup>1</sup></b>	
						6	<b>0 432 191 495</b>	
			DC 9.05 <Euro 3>	09.01-09.04		6	<b>0 432 191 494<sup>1</sup></b>	
						6	<b>0 432 191 495</b>	
			DSC 9.12 <Euro 2>					
			Mot.-Nr. →4026981 SNL →5123774 SSS	08.96-10.01		6	<b>0 432 131 616</b>	
			Mot.-Nr. 4026982 SNL → 5123775 SSS→	08.96-10.01		6	<b>0 432 131 616</b>	
300	9,0	221	DC 9.03 <Euro 3>	02.00-09.04		6	<b>0 432 191 464<sup>1</sup></b>	
						6	<b>0 432 191 465</b>	
			DC 9.06 <Euro 3>	09.00-09.04		6	<b>0 432 191 464<sup>1</sup></b>	
						6	<b>0 432 191 465</b>	
310	9,0	228	DSC 9.13 <Euro 2>	08.96-08.02		6	<b>0 432 131 692</b>	
			DSC 9.15 <Euro 2>	08.96-10.00		6	<b>0 432 131 692</b>	





T	220	9,0	162	DSC 9.11 <Euro 2>	08.96-08.02	6	0 432 131 684	
	230	9,0	169	DC 9.01 <Euro 3>; DC 9.04 <Euro 3>	04.99-09.04	6	0 432 191 494 <sup>1</sup>	
						6	0 432 191 495	
	260	9,0	191	DC 9.02 <Euro 3>	02.00-09.04	6	0 432 191 494 <sup>1</sup>	
						6	0 432 191 495	
				DC 9.05 <Euro 3>	09.01-09.04	6	0 432 191 494 <sup>1</sup>	
						6	0 432 191 495	
				DSC 9.12 <Euro 2>				
				Mot.-Nr. →4026981 SNL →5123774 SSS	08.96-10.01	6	0 432 131 616	
				Mot.-Nr. 4026982 SNL → 5123775 SSS →	08.96-10.01	6	0 432 131 616	
	300	9,0	221	DC 9.03 <Euro 3>	02.00-09.04	6	0 432 191 464 <sup>1</sup>	
						6	0 432 191 465	
				DC 9.06 <Euro 3>	09.00-09.04	6	0 432 191 464 <sup>1</sup>	
						6	0 432 191 465	
	310	9,0	228	DSC 9.13 <Euro 2>	08.96-08.02	6	0 432 131 692	
				DSC 9.15 <Euro 2>	08.96-10.00	6	0 432 131 692	
<b>Serie 111</b>								
B	[BUS]	11,0		DN 11.01 B10..04 B10	06.90-01.99	KOC	6	0 432 281 748
BF	, CKD [BUS]	11,0		DS 11.01 B 06	01.99-01.99	KOC	6	0 432 281 748
<b>Serie 112</b>								
BK	CLB [BUS]	11,0	143	DN 11.06 B	05.82-11.99		6	0 432 292 880
			224	DS 11.15 B	05.82-11.99		6	0 432 292 881 0 986 430 074
N	CLB [BUS]	11,0	158	DN 11.01 C 09; DN 11.04 C 01	01.90-12.00		6	0 432 292 880
<b>Serie 113</b>								
BN	ALB [BUS]	11,0	228	DS 11.34; DSC 11.08 C	05.90-08.98		6	0 432 131 871 0 986 430 120
	CLB [BUS]	11,0	134	DN 11.06 C	05.90-08.98		6	0 432 292 880
			189	DS 11.71	05.90-08.98		6	0 432 131 825 0 986 430 213
				DSC 11.04	05.90-08.98		6	0 432 131 859
CN	[BUS]	11,0	189	DSC 11.04	01.90-08.98		6	0 432 131 859
	, A [BUS]	11,0	189/228	DS 11.34; DS 11.74; DSC 11.08	01.90-08.98		6	0 432 131 871 0 986 430 120
F	HL/HR [BUS]	11,0	228	DS 11.34	06.90-08.98		6	0 432 131 871 0 986 430 120
K	CLA/CRA, CLB, TLA/TRA, TLB [BUS]	11,0		DSC 11.35	07.90-08.98		6	0 432 131 846 0 986 430 274
				DSC 11.36	07.90-08.98		6	0 432 131 846 0 986 430 274
			235	DSC 11.21 <Euro 1>				
				Mot.-Nr. →5333533 SSS	07.90-08.98		6	0 432 131 846 0 986 430 274
				Mot.-Nr. 5333534 SSS →	07.90-08.98		6	0 432 131 825 0 986 430 213
			266	DSC 11.23 <Euro 1>	07.90-08.98		6	0 432 131 846 0 986 430 274
			280	DSC 11.22 <Euro 1>	07.90-08.98		6	0 432 131 825 0 986 430 213
	CLB [BUS]	11,0		DS 11.78	07.90-08.98		6	0 432 131 825 0 986 430 213
	CLB, TLA/TRA [BUS]	11,0	305	DSC 11.81	05.82-08.98		6	0 432 131 744
	CLB, TLA/TRA, TLB [BUS]	11,0	267	DSC 11.18	07.90-08.98		6	0 432 131 871 0 986 430 120
			280	DSC 11.70 <Euro 2>	05.82-08.98		6	0 432 131 825 0 986 430 213
	CLB, TLB [BUS]	11,0	189/228/235	DS 11.74; DSC 11.08; DSC 11.17	07.90-08.98		6	0 432 131 871 0 986 430 120
			228	DS 11.34	07.90-08.98		6	0 432 131 871 0 986 430 120
			265	DS 11.75	07.90-08.98		6	0 432 131 825 0 986 430 213
	TLA/TRA, TLB [BUS]	11,0	267	DSC 11.13 B	07.90-08.98		6	0 432 192 881 0 986 430 034
	TLB [BUS]	11,0	228	DSC 11.08 B	01.91-08.98		6	0 432 131 871 0 986 430 120
			230	DS 11.73	07.90-08.98		6	0 432 292 881 0 986 430 074
			239	DSC 11.16 B				
				Mot.-Nr. →5307828	01.91-08.98		6	0 432 192 881 0 986 430 034
	203	11,0	149	DSC 11.01	01.90-12.99		6	0 432 131 871 0 986 430 120
L	CLB [BUS]	11,0	180	DSC 11.27 <EDC>	01.92-08.98		6	0 432 131 825 0 986 430 213
			189/228	DS 11.34; DS 11.74; DSC 11.08	01.90-08.98		6	0 432 131 871 0 986 430 120
	CLB, CLL [BUS]	11,0		DS 11.78; DSC 11.71	12.94-08.98		6	0 432 131 825 0 986 430 213
			191-193	DSC 11.24 <EDC>	11.93-08.98		6	0 432 131 789
			235	DSC 11.21 <Euro 1>				
				Mot.-Nr. →5333533 SSS	01.90-08.98		6	0 432 131 846 0 986 430 274
				Mot.-Nr. 5333534 SSS →	01.90-08.98		6	0 432 131 825 0 986 430 213
N	ALB [BUS]	11,0	228	DSC 11.08	09.91-08.98		6	0 432 131 871 0 986 430 120
	ALB, CLB [BUS]	11,0	191	DSI 11 EO 1	03.92-08.98		6	0 432 231 691





◀ SCANIA

<b>N</b>	ALB, CLB [BUS]	11,0	235	DSC 11.21 <Euro 1>					
				Mot.-Nr. →5333533 SSS	09.91-08.98	6	0 432 131 846	0 986 430 274	
				Mot.-Nr. 5333534 SSS→	09.91-08.98	6	0 432 131 825	0 986 430 213	
	CLB [BUS]	11,0		DS 11.77					
				Mot.-Nr. →5333533 SSS	04.95-08.98	6	0 432 131 846	0 986 430 274	
				Mot.-Nr. 5333534 SSS→	04.95-08.98	6	0 432 131 825	0 986 430 213	
			189	DSC 11.04	09.91-08.98	6	0 432 131 859		
	CLB, CLL/CRL [BUS]	11,0		DSC 11.71	04.95-08.98	6	0 432 131 825	0 986 430 213	
				DSC 11.27 <EDC>	04.91-08.98	6	0 432 131 825	0 986 430 213	
				DS 11.74	04.91-08.98	6	0 432 131 871	0 986 430 120	
	CLB, CLL/CRL, DRB [BUS]	11,0		DS 11.78	04.91-08.98	6	0 432 131 825	0 986 430 213	
			191-193	DSC 11.24 <EDC>	04.91-08.98	6	0 432 131 789		
	CLB, DRB [BUS]	11,0	134	DN 11.06 C	04.91-08.98	6	0 432 292 880		
			189	DS 11.71	09.91-08.98	6	0 432 192 876		
	CLL/CRL [BUS]	11,0	191	DSI 11 E 01	09.91-08.98	6	0 432 231 691		
	CR [BUS]	11,0	189	DSC 11.04 C	12.88-08.98	6	0 432 131 859		
	DRB [BUS]	11,0	189	DS 11.74 C	04.91-08.98	6	0 432 131 871	0 986 430 120	
<b>P</b>		11,0	229/254	DSC 11.03; DSC 11.06	05.88-12.00	6	0 432 192 881	0 986 430 034	
			230	DS 11.73	06.88-12.00	6	0 432 292 881	0 986 430 074	
<b>R</b>	203	11,0	149	DN 11.08	10.91-12.98	6	0 432 131 871	0 986 430 120	
<b>T</b>		11,0	230	DS 11.73	05.88-05.00	6	0 432 292 881	0 986 430 074	
	215	11,0	158	DN 11.01	05.88-05.00	6	0 432 292 880		
	320	11,0	235	DSC 11.21 <Euro 1>					
				Mot.-Nr. →5333533 SSS	11.91-05.00	6	0 432 131 846	0 986 430 274	
				Mot.-Nr. 5333534 SSS→	11.91-05.00	6	0 432 131 825	0 986 430 213	
	320, 360	11,0	235/267	DSC 11.13; DSC 11.16	05.88-05.00	6	0 432 192 881	0 986 430 034	
			236/265	DSC 11.35; DSC 11.36	06.88-05.00	6	0 432 131 846	0 986 430 274	
	360	11,0	265	DSC 11.18	01.90-05.00	6	0 432 131 871	0 986 430 120	
				DSC 11.23 <Euro 1>	11.91-05.00	6	0 432 131 846	0 986 430 274	
	384	11,0	280	DSC 11.22 <Euro 1>	01.91-05.00	6	0 432 131 825	0 986 430 213	
<b>Serie 114</b>									
<b>K</b>	EB, IB [BUS]	11,0	265	DC 11.07 <Euro 2>	08.97-12.03	6	F 000 439 012		
<b>P,R</b>	320, 360	11,0	235/265	DSC 11.74 <Euro 1>; DSC 11.75 <Euro 1>					
				Mot.-Nr. →4119161 SNL	05.96-05.99	6	0 432 131 825	0 986 430 213	
	340	11,0	250	DSC 11.79 <Euro 2>	05.96-05.99	6	0 432 131 744		
<b>T</b>	320, 360	11,0	235/265	DSC 11.74 <Euro 1>; DSC 11.75 <Euro 1>					
				Mot.-Nr. →4119161 SNL	04.97-05.99	6	0 432 131 825	0 986 430 213	
	340	11,0	250	DSC 11.79 <Euro 2>	04.97-05.99	6	0 432 131 744		
<b>Serie 124</b>									
<b>K</b>	EB, IB [BUS]	12,0	265	DSC 12.02 <Euro 2>					
				Mot.-Nr. →5707809 SSS	08.97-02.02	6	0 432 131 758	0 986 430 382	
				Mot.-Nr. 5707810 SSS→	08.97-02.02	6	0 432 131 703	0 986 430 390	
<b>P,R</b>	360	12,0	265	DSC 12.02 <Euro 2>					
				Mot.-Nr. →5707809 SSS	09.95-02.02	6	0 432 131 758	0 986 430 382	
				Mot.-Nr. 5707810 SSS→	09.95-02.02	6	0 432 131 703	0 986 430 390	
	400	12,0	294	DSC 12.01 <Euro 2>					
				Mot.-Nr. →5707809 SSS	09.95-01.00	6	0 432 131 758	0 986 430 382	
				Mot.-Nr. 5707810 SSS→	09.95-01.00	6	0 432 131 703	0 986 430 390	
<b>T</b>	360	12,0	265	DSC 12.02 <Euro 2>					
				Mot.-Nr. →5707809 SSS	09.95-02.02	6	0 432 131 758	0 986 430 382	
				Mot.-Nr. 5707810 SSS→	09.95-02.02	6	0 432 131 703	0 986 430 390	
	400	12,0	294	DSC 12.01 <Euro 2>					
				Mot.-Nr. →5707809 SSS	03.95-01.00	6	0 432 131 758	0 986 430 382	
				Mot.-Nr. 5707810 SSS→	03.95-01.00	6	0 432 131 703	0 986 430 390	
<b>Serie 143</b>									
<b>R</b>	450	14,2	331	DSC 14.03	10.96-06.98	8	0 432 131 873	0 986 430 030	
<b>Serie 144</b>									
<b>R</b>	460	14,2	338	DSC 14.15 <Euro 2>	09.96-08.01	8	0 432 131 751	0 986 430 387	
				Mot.-Nr. →5563229 SSS	09.96-08.01	8	0 432 131 712 <sup>1</sup>		
				Mot.-Nr. 5563230 SSS→	09.96-08.01	8	0 432 131 712 <sup>1</sup>		
	530	14,2	389	DSC 14.13 <Euro 2>	01.96-08.01	8	0 432 131 773	0 986 430 385	
				Mot.-Nr. →5563229 SSS	01.96-08.01	8	0 432 131 713 <sup>1</sup>		
				Mot.-Nr. 55632230 SSS→	01.96-08.01	8	0 432 131 713 <sup>1</sup>		



T	460	14,2	338	DSC 14.15 <Euro 2>	02.97-08.01	8	<b>0 432 131 751</b>	<b>0 986 430 387</b>
				Mot.-Nr. →5563229 SSS	02.97-08.01	8	<b>0 432 131 712</b> <sup>1</sup>	
				Mot.-Nr. 5563230 SSS→	02.97-08.01	8	<b>0 432 131 712</b> <sup>1</sup>	
530	14,2	390	DSC 14.13 <Euro 2>	02.97-08.01	8	<b>0 432 131 773</b>	<b>0 986 430 385</b>	
			Mot.-Nr. →5563229 SSS	02.97-08.01	8	<b>0 432 131 713</b> <sup>1</sup>		
			Mot.-Nr. 55632230 SSS→	02.97-08.01	8	<b>0 432 131 713</b> <sup>1</sup>		

**SETRA**

**Serie 200**

215 HD	14,6	280	OM 442 LA					
			Mot.-Nr. →860061	06.96-06.01	8	<b>0 432 131 800</b>	<b>0 986 430 264</b>	
			Mot.-Nr. 860062→	06.96-06.01	8	<b>0 432 131 803</b> <sup>1</sup>		
HDH	14,6	320	OM 442 LA					
			Mot.-Nr. →860061	06.96-06.01	8	<b>0 432 131 801</b>	<b>0 986 430 265</b>	
			Mot.-Nr. 860062→	06.96-06.01	8	<b>0 432 131 804</b> <sup>1</sup>		
						8	<b>0 432 131 726</b>	<b>0 986 430 326</b>
						8	<b>0 432 131 730</b> <sup>1</sup>	
						8	<b>0 432 131 729</b> <sup>1</sup>	

**Serie 300**

S 313 UL	12,0	184/220	OM 447 hLA <Euro 2>	03.95-09.05	6	<b>0 432 131 780</b> <sup>1</sup>		
					6	<b>0 432 131 781</b>	<b>0 986 430 361</b>	
					6	<b>0 432 191 384</b>		
S 315 GT	14,6	280	OM 442 LA <Euro 2>					
			Mot.-Nr. →860061	03.95-03.05	6	<b>0 432 131 800</b>	<b>0 986 430 264</b>	
			Mot.-Nr. 860062→	03.95-03.05	6	<b>0 432 131 803</b> <sup>1</sup>		
GT-HD	11,0	320	OM 442 LA <Euro 2>					
			Mot.-Nr. →860061	07.96-03.05	8	<b>0 432 131 728</b>	<b>0 986 430 327</b>	
			Mot.-Nr. 860062→	07.96-03.05	8	<b>0 432 131 729</b> <sup>1</sup>		
GT-HD, HD, HDH	14,6	280	OM 442 LA <Euro 2>					
			Mot.-Nr. →860061	03.95-03.05	8	<b>0 432 131 726</b>	<b>0 986 430 326</b>	
			Mot.-Nr. 860062→	03.95-03.05	8	<b>0 432 131 730</b> <sup>1</sup>		
H, NF, UL	12,0	185/220	OM 457 HLA <Euro 3>	07.01-09.05	6	<b>0 432 131 780</b> <sup>1</sup>		
					8	<b>0 432 131 781</b>	<b>0 986 430 361</b>	
					6	<b>0 432 191 384</b>		
HD, HDH	14,6	320	OM 442 LA <Euro 2>					
			Mot.-Nr. →860061	03.95-07.01	8	<b>0 432 131 800</b>	<b>0 986 430 264</b>	
			Mot.-Nr. 860062→	03.95-07.01	8	<b>0 432 131 803</b> <sup>1</sup>		
NF, UL	12,0	184/220	OM 447 hLA <Euro 2>	03.95-03.05	6	<b>0 432 131 728</b>	<b>0 986 430 327</b>	
					8	<b>0 432 131 729</b> <sup>1</sup>		
					6	<b>0 432 131 730</b> <sup>1</sup>		
S 316 HDS	14,6	280	OM 442 LA <Euro 2>					
			Mot.-Nr. →860061	01.97-03.05	8	<b>0 432 131 801</b>	<b>0 986 430 265</b>	
			Mot.-Nr. 860062→	01.97-03.05	8	<b>0 432 131 804</b> <sup>1</sup>		
UL	12,0	185	OM 457 HLA <Euro 3>	07.01-09.05	6	<b>0 432 131 726</b>	<b>0 986 430 326</b>	
					8	<b>0 432 131 730</b> <sup>1</sup>		
					6	<b>0 432 191 384</b>		
S 317 HDH	14,6	280	OM 442 LA <Euro 2>					
			Mot.-Nr. →860061	10.97-03.05	8	<b>0 432 131 800</b>	<b>0 986 430 264</b>	
			Mot.-Nr. 860062→	10.97-03.05	8	<b>0 432 131 803</b> <sup>1</sup>		
						8	<b>0 432 131 728</b>	<b>0 986 430 327</b>
						8	<b>0 432 131 729</b> <sup>1</sup>	
						8	<b>0 432 131 730</b> <sup>1</sup>	





◀ SETRA

<b>S 317</b> HDH	14,6	320	OM 442 LA <Euro 2> Mot.-Nr. →860061	10.97-03.05	8	<b>0 432 131 801</b>	<b>0 986 430 265</b>
			Mot.-Nr. 860062→	10.97-03.05	8	<b>0 432 131 804</b> <sup>1</sup>	
					8	<b>0 432 131 726</b>	<b>0 986 430 326</b>
					8	<b>0 432 131 730</b> <sup>1</sup>	
UL	12,0	185	OM 457 HLA <Euro 3>	07.01-09.05	6	<b>0 432 191 384</b>	
<b>S 319</b> GT-HD	11,0	320	OM 442 LA <Euro 2> Mot.-Nr. →860061	07.98-03.05	8	<b>0 432 131 801</b>	<b>0 986 430 265</b>
			Mot.-Nr. 860062→	07.98-03.05	8	<b>0 432 131 804</b> <sup>1</sup>	
					8	<b>0 432 131 726</b>	<b>0 986 430 326</b>
					8	<b>0 432 131 730</b> <sup>1</sup>	
NF, UL	12,0	184/220	OM 447 hLA <Euro 2>; OM 457 hLA <Euro 3>	03.95-03.05	6	<b>0 432 131 780</b> <sup>1</sup>	
					6	<b>0 432 131 781</b>	<b>0 986 430 361</b>
		185	OM 457 HLA <Euro 3>	07.01-09.05	6	<b>0 432 191 384</b>	
<b>S 328</b> DT	14,6	280	OM 442 LA <Euro 2> Mot.-Nr. →860061	03.95-03.05	8	<b>0 432 131 800</b>	<b>0 986 430 264</b>
			Mot.-Nr. 860062→	03.95-03.05	8	<b>0 432 131 803</b> <sup>1</sup>	
					8	<b>0 432 131 728</b>	<b>0 986 430 327</b>
					8	<b>0 432 131 729</b> <sup>1</sup>	
		320	OM 442 LA <Euro 2> Mot.-Nr. →860061	03.95-02.03	8	<b>0 432 131 801</b>	<b>0 986 430 265</b>
			Mot.-Nr. 860062→	03.95-02.03	8	<b>0 432 131 804</b> <sup>1</sup>	
					8	<b>0 432 131 726</b>	<b>0 986 430 326</b>
					8	<b>0 432 131 730</b> <sup>1</sup>	
		385	OM 442 LA <Euro 2> Mot.-Nr. →860061	03.95-03.05	8	<b>0 432 131 805</b> <sup>1</sup>	
			Mot.-Nr. 860062→	03.95-03.05	8	<b>0 432 131 727</b>	<b>0 986 430 325</b>
					8	<b>0 432 131 731</b> <sup>1</sup>	
<b>SG 321</b> UL	12,0	184/220	OM 447 hLA <Euro 2>	03.95-09.05	6	<b>0 432 131 780</b> <sup>1</sup>	
					6	<b>0 432 131 781</b>	<b>0 986 430 361</b>
		220	OM 457 HLA <Euro 3>	07.01-09.05	6	<b>0 432 191 384</b>	
<b>Serie 400</b>							
<b>S 415 ComfortClass</b> GT	12,0	185-300	OM 457.941 hLA <Euro 3> Komp.Nr. 522003/02	02.03→	TNK	6	<b>0 432 191 263</b>
			Komp.Nr. 522003/09	02.03→	TNK	6	<b>0 432 191 347</b>
			Komp.Nr. 522003/08	02.03→	TNK	6	<b>0 432 191 347</b>
GT-HD	12,0	260-310	OM 457.944 hLA <Euro 3> Komp.Nr. 522003/02	02.03→	TNK	6	<b>0 432 191 263</b>
			Komp.Nr. 522003/09	02.03→	TNK	6	<b>0 432 191 347</b>
			Komp.Nr. 522003/08	02.03→	TNK	6	<b>0 432 191 347</b>
<b>S 416 ComfortClass</b> GT-HD	12,0	310	OM 457.944 hLA <Euro 3> Komp.Nr. 522003/02	02.03→	TNK	6	<b>0 432 191 263</b>
			Komp.Nr. 522003/09	02.03→	TNK	6	<b>0 432 191 347</b>
			Komp.Nr. 522003/08	02.03→	TNK	6	<b>0 432 191 347</b>
<b>S 417 ComfortClass</b> GT-HD	12,0	260-310	OM 457.944 hLA <Euro 3> Komp.Nr. 522003/02	02.03→	TNK	6	<b>0 432 191 263</b>
			Komp.Nr. 522003/09	02.03→	TNK	6	<b>0 432 191 347</b>
			Komp.Nr. 522003/08	02.03→	TNK	6	<b>0 432 191 347</b>



**SSANGYONG**

<b>Istana Van</b>							
<b>2.9 D</b>	2,9	70	OM 662	01.95-03.03	5	<b>0 432 217 157</b>	<b>0 986 430 197</b>
<b>Truck</b>							
<b>Cargo Truck</b>	14,6	250	OM 442 A	10.93→	8	<b>0 432 231 678</b>	<b>0 986 430 205</b>
<b>Concrete Mixer 69T</b>	14,6	250	OM 442 A	10.93→	8	<b>0 432 231 678</b>	<b>0 986 430 205</b>
<b>Dump Truck 15T</b>	14,6	250	OM 442 A	10.93→	8	<b>0 432 231 678</b>	<b>0 986 430 205</b>
<b>Traktor 6M</b>	14,6	250	OM 442 A	10.93→	8	<b>0 432 231 678</b>	<b>0 986 430 205</b>





## STEYR (STEYR-DAIMLER-PUCH AG)

Serie 11-18 HU						
SFL 11 HUA 280	11,0	206	9 FUA	10.87→	6	0 432 231 029
SG 18 HUA 280	11,0	206	9 FUA	07.87→	6	0 432 231 029
SL 11 HU 250, 11 HUA 280	11,0	184/206	9 FUA	01.84→	6	0 432 231 029
SS 11 HU 200, 11 HUA 280	11,0	147/206	9 FUA	06.84→	6	0 432 231 029
<b>8 S</b>						
14	6,6	100	WD 612.61	05.89-12.98 KOC	6	0 432 291 649
18	6,6	130	WD 612.63	05.89-12.98	6	0 432 291 617
<b>9 S</b>						
14	6,6	100	WD 612.61	06.86-12.98 KOC	6	0 432 291 649
18	6,6	130	WD 612.63,73	02.88-12.98	6	0 432 291 617
<b>10 S</b>						
14	6,6	100	WD 612.61	06.86-12.98 KOC	6	0 432 291 649
18	6,6	130	WD 612.63,73	02.88-12.98	6	0 432 291 617
<b>11 S</b>						
14	6,6	100	WD 612.61	07.89-12.98 KOC	6	0 432 291 649
18	6,6	130	WD 612.63	07.89-12.98	6	0 432 291 617
<b>12 M</b>						
18	6,6	130	WD 612.74	02.88-12.03	6	0 432 291 617
21	0,0		WD 612.76	01.90-12.98	0	0 432 291 617
<b>12 S</b>						
14	6,6	100	WD 612.61	06.86-12.98 KOC	6	0 432 291 649
18	6,6	130	WD 612.63,73	02.88-12.03	6	0 432 291 617
21	6,6	155	WD 612.65,75	02.88-12.98	6	0 432 291 617
<b>13 S</b>						
14	6,6	100	WD 612.61	09.88-12.98 KOC	6	0 432 291 649
18	6,6	130	WD 612.63	09.88-12.98	6	0 432 291 617
21	6,6	155	WD 612.65,75	07.89-12.98	6	0 432 291 617
23	6,6	171	WD 612.66	01.91-12.98	6	0 432 291 617
<b>14 S</b>						
14	6,6	100	WD 612.61	06.86-12.98 KOC	6	0 432 291 649
			WD 612.92	02.88-12.98	6	0 432 291 617
18	6,6	130	WD 612.63,73	02.88-12.98	6	0 432 291 617
21	6,6	155	WD 612.65,75	02.88-12.98	6	0 432 291 617
<b>15 S</b>						
14	6,6	100	WD 612.92	02.88-12.98	6	0 432 291 617
18	6,6	130	WD 612.63; WD 612.63,73	02.88-12.98	6	0 432 291 617
21	6,6	155	WD 612.65,75	02.88-12.98	6	0 432 291 617
23	6,6	165	WD 612.93	02.88-12.98	6	0 432 291 617
		170	WD 612.66	01.91-12.98	6	0 432 291 617
<b>16 S</b>						
18	6,6	130	WD 612.63; WD 612.63,73	02.88-12.98	6	0 432 291 617
21	6,6	155	WD 612.65; WD 612.65,75	02.88-12.98	6	0 432 291 617
23	6,6	171	WD 612.93	02.88-12.98	6	0 432 291 617
			Mot.-Nr. 09637→	02.88-12.98	6	0 432 291 617
<b>17 S</b>						
18	6,6	130	WD 612.63	09.88-12.98	6	0 432 291 617
21	6,6	155	WD 612.65	09.88-12.98	6	0 432 291 617
23	6,6	169	WD 612.66	01.91-12.98	6	0 432 291 617
<b>19 S</b>						
24	9,7	175	WD 615.64; WD 615.74	01.88-12.98	6	0 432 191 773
28	9,7	204	WD 615.63; WD 615.73	01.88-12.98	6	0 432 191 773
31	9,7	225-228	WD 615.68,98; WD 615.78,98	10.87-12.98	6	0 432 191 817
<b>22 S</b>						
28	9,7	204	WD 615.63	01.88-12.98	6	0 432 191 773
31	9,7	225-228	WD 615.68; WD 615.78	10.87-12.98	6	0 432 191 817
<b>26 S</b>						
28	9,7	204	WD 615.63; WD 615.73	01.88-12.98	6	0 432 191 773
31	9,7	225-228	WD 615.68; WD 615.78	10.87-12.98	6	0 432 191 817







## ◀ STEYR

32 S						
28	9,7	204	WD 615.63; WD 615.73	01.88-12.98	6	0 432 191 773
31	9,7	225-228	WD 615.68; WD 615.78	10.87-12.98	6	0 432 191 817
33 S						
31	9,7	225-228	WD 615.68	10.87-12.98	6	0 432 191 817
40 S						
31	9,7	225-228	WD 615.68	01.88-12.98	6	0 432 191 817

## TATA (TELCO)

407						
3.0 D	3,0	48	497 SP	01.86-01.03	4	F 002 C8Z 859
613						
LPT 5.7 DT	5,7	95	697 TCIC <Euro 2>	10.04→	6	F 002 C8Z 860
5.7 TCI	5,7	96	697 TCIC <Euro 3>	01.08→	6	0 432 193 458 <sup>1</sup>
709						
SFC 3.8 D	3,8	66	497 TC DI	11.03-03.05	4	F 002 C8Z 203
1510						
LP	5,7	77	697D NA CMVR 2000	09.00→	6	F 002 C8Z 851
1613						
SE	5,7	96	697 TC CMVR 2000	06.99-06.03	6	F 002 C8Z 205
TC SE	5,9	92	6BT	06.97→	6	F 002 C8Z 201

## TATRA

Serie 815						
T815 2 NT 4x4	12,8	243	BF8L 513 LC <Euro I>	01.92→	8	0 432 291 553

## TEMSA

Diamant						
13,14	12,8	339	D2876 LOH 02 <Euro 3>	09.04→	X10 X56	6 0 432 191 414 <sup>1</sup> 6 0 432 191 416
Metropol						
	4,6	132	D0834 LOH03 <Euro 3>	10.06-10.07		4 0 432 133 798
Opalin						
8	4,6	132	D 0834 LFL 03 <Euro 3>	05.03→		4 0 432 133 798
Opalin ,						
9	6,9	162	D 0836 LOH02 <Euro 3>	01.05→		6 0 432 133 798
Powerbus						
	4,6	132	D0834 LOH03 <Euro 3>	02.04→		4 0 432 133 798
Safari						
10,12,13	12,0	265	D 2866 LOH 28 <Euro 3>	08.02→	X10 X56	6 0 432 191 417 <sup>1</sup> 6 0 432 191 419
12,13	12,0	302	D 2866 LOH29 <Euro 3>	08.02→	X10 X56	6 0 432 191 417 <sup>1</sup> 6 0 432 191 419
Safir						
	11,9	258	6D24	01.99-08.09	ZDA	6 9 430 613 898
Samba						
	4,6	132	D 0834 LFL 03 <Euro 3>	01.01→	X10 24Z	4 0 432 133 799 4 0 432 133 798
Tourmalin						
12,13	9,2	228	PR228S1 <Euro 3>	08.05→		6 0 432 191 254
13	12,0	228	D 2866 LUH24 <Euro 3>	01.05→	X10 X56	6 0 432 191 417 <sup>1</sup> 6 0 432 191 419



## URAL AUTOMOBIL PLANT

33t						
6329	13,8	272	8210.42K <Euro 2>	01.03→	6	0 432 291 516
6529	13,8	272	8210.42K <Euro 2>	01.03→	6	0 432 291 516
88t						
632911	13,8	272	8210.42K <Euro 2>	01.03→	6	0 432 291 516

## VOLVO

B						
7 F	6,7	210	D7A285	01.99→	6	0 432 191 634 0 986 430 368
L	7,0	158/184/ 202/213/ 228	D7C	05.99-09.06	EC9	6 0 432 193 536 <sup>1</sup>
					EC9,KOC	6 0 432 191 537
					E96	6 0 432 191 466 <sup>1</sup>
						6 0 432 191 506 0 986 430 591
					SFZ	6 0 432 193 572 <sup>1</sup>
						6 0 432 193 676
10 L, M	9,6	180/210	DH 10 A; DH 10A245; DH 10A285	05.94-09.05	6	0 432 191 611 0 986 430 370
M	9,6		THD 104 KB; THD 104 KF	01.94-09.01	6	0 432 191 635
		250/257	DH 10A340; DH 10A350	01.95-09.01	6	0 432 191 612 0 986 430 369
		265	DH 10A360	01.95-09.01	6	0 432 191 612 0 986 430 369
R	9,6	265	DH 10A360	01.02→	6	0 432 191 612 0 986 430 369
FH						
16 470, 520	16,0	346/382	D 16A470; D 16A520 <Euro 2>; D 16B470; D 16B520 <Euro 2>	08.93-12.02	6	0 432 291 534 0 986 430 301
FL						
6 180, 220	5,5	132/162	D6B180; D6B220	05.00-05.06	6	0 432 191 405
250	5,5	184	D6B250	05.00-05.06	6	0 432 191 460 0 986 430 592
7	6,7	169	D 7 B230 <Euro 2>			
			Mot.-Nr. →77798	10.94-10.99	6	0 432 191 634 0 986 430 368
			Mot.-Nr. 77799→	10.94-10.99	6	0 432 191 634 0 986 430 368
		191/210	D 7 A285 <Euro 2>; D 7 B260 <Euro 2>	12.93-10.99	6	0 432 191 634 0 986 430 368
		7,0	160/184 TD 73 EA; TD 73 EB	10.90-10.99	6	0 432 191 736 0 986 430 363
10	9,6	228/235/ 258/265 350	D 10 A 360; D 10A 310; D 10A 320; D 10A	02.95-12.01	6	0 432 191 612 0 986 430 369
		230-234	TD 102 F	09.85-12.99	6	0 432 191 771 0 986 430 166
FM						
7 250	7,3	184	D 7C250	09.98-12.01	EC9	6 0 432 193 572 <sup>1</sup>
						6 0 432 193 676
					E96	6 0 432 191 466 <sup>1</sup>
						6 0 432 191 506 0 986 430 591
290	7,3	210	D 7C290	03.99-05.01	EC9	6 0 432 193 572 <sup>1</sup>
						6 0 432 193 676
					E96	6 0 432 191 466 <sup>1</sup>
						6 0 432 191 506 0 986 430 591
310	7,3	228	D 7C310	09.98-12.01	EC9	6 0 432 193 572 <sup>1</sup>
						6 0 432 193 676
					E96	6 0 432 191 466 <sup>1</sup>
						6 0 432 191 506 0 986 430 591
10 320, 360	9,6	236/265	D 10B320; D 10B360	04.99-12.05	6	0 432 191 612 0 986 430 369
N						
12 280, 315, 350, 370, 380	12,0	206/210/ 232/257/ 272/280	TD 121 FA; TD 121 FB; TD 121 FC; TD 121 FE; TD 121 FF; TD 121 FG	01.86-01.98	6	0 432 191 863 0 986 430 032
NL						
10 275	9,6	202	TD 101 G	05.91-09.01	6	0 432 191 848 0 986 430 000
			TD 102 F	05.91-09.01	6	0 432 191 771 0 986 430 166
285, 320	9,6	210/234	TD 102 FH; TD 102 FL	05.91-09.01	6	0 432 191 770 0 986 430 165
320	9,6	236	TD 103 ES	05.91-09.01	6	0 432 191 730 0 986 430 263
12 320	12,0	235-243	TD 121 G	05.91-09.01	6	0 432 191 863 0 986 430 032





◀ VOLVO

12 350, 360, 390, 400	12,0	257-262/ 287-291	TD 122 F; TD 122 FH; TD 122 FL; TD 122 FS	05.91-09.01	6	0 432 191 788	0 986 430 167
360, 400	12,0	262/298	TD 123 E; TD 123 ES	05.91-09.01	6	0 432 191 721	0 986 430 250

**VOLZHANIN**

**Serie 6000**

6270	9,0	221	DC 9 03 <Euro 3>	01.10→	6	0 432 191 464 <sup>1</sup>	
					6	0 432 191 465	

**Serie 32000**

32901	5,7	96	697 TC65 <Euro 3>	01.10→	6	F 002 C7Z 261	
					6	0 432 193 458 <sup>1</sup>	

**VW (VOLKSWAGEN)**

**California T4**

1.9 D Turbo [70, 7D]	1,9	50	ABL	10.92-06.03	4	0 432 217 242	0 986 430 188
2.4 D, D Syncro [70, 7D]	2,4	55/57	AAB; AJA	09.90-06.03	5	0 432 217 207	0 986 430 189
2.5 TDI [70, 7D]	2,5	65	AYY	10.01-06.03	5	0 432 193 619 <sup>1</sup>	
					5	0 432 193 662	
		75	AUF	05.99-06.03	AG	5	0 432 193 619 <sup>1</sup>
					GS	5	0 432 193 621 <sup>1</sup>
			Fg.-Nr. →70..2..075 000	05.99-10.01		5	0 432 193 823
			Fg.-Nr. 70..2..075 000→	11.01-06.03		5	0 432 193 662
			AYC	04.01-06.03	AG	5	0 432 193 619 <sup>1</sup>
					GS	5	0 432 193 621 <sup>1</sup>
			Fg.-Nr. →70..2..075 000	04.01-10.01		5	0 432 193 823
			Fg.-Nr. 70..2..075 000→	11.01-06.03		5	0 432 193 662
		111	AHY	05.98-09.00		5	0 432 193 608 <sup>1</sup>
						5	0 432 193 669
			AXG	09.00-06.03		5	0 432 193 550 <sup>1</sup>
						5	0 432 193 552
TDI Syncro [70, 7D]	2,5	75	AXL	04.01-06.03		5	0 432 193 621 <sup>1</sup>
						5	0 432 193 823
TDI, TDI Syncro [70, 7D]	2,5	75	ACV	07.95-06.03	AG	5	0 432 193 619 <sup>1</sup>
					GS	5	0 432 193 621 <sup>1</sup>
			Fg.-Nr. →70..2..075 000	07.95-10.01	AG	5	0 432 193 662
					GS	5	0 432 193 823
			Fg.-Nr. 70..2..075 000→	11.01-06.03		5	0 432 193 662

**Caravelle T4**

1.9 D Turbo [70, 7D]	1,9	50	ABL	10.92-06.03	4	0 432 217 242	0 986 430 188
2.4 D, D Syncro [70, 7D]	2,4	55/57	AAB; AJA	09.90-06.03	5	0 432 217 207	0 986 430 189
2.5 TDI [70, 7D]	2,5	65	AYY	10.01-06.03	5	0 432 193 619 <sup>1</sup>	
					5	0 432 193 662	
		75	AUF	05.99-06.03	AG	5	0 432 193 619 <sup>1</sup>
					GS	5	0 432 193 621 <sup>1</sup>
			Fg.-Nr. →70..2..075 000	05.99-10.01		5	0 432 193 823
			Fg.-Nr. 70..2..075 000→	11.01-06.03		5	0 432 193 662
			AYC	04.01-06.03	AG	5	0 432 193 619 <sup>1</sup>
					GS	5	0 432 193 621 <sup>1</sup>
			Fg.-Nr. →70..2..075 000	04.01-10.01		5	0 432 193 823
			Fg.-Nr. 70..2..075 000→	11.01-06.03		5	0 432 193 662
		111	AHY	05.98-09.00		5	0 432 193 608 <sup>1</sup>
						5	0 432 193 669
			AXG	09.00-06.03		5	0 432 193 550 <sup>1</sup>
						5	0 432 193 552
TDI Syncro [70, 7D]	2,5	75	AXL	04.01-06.03		5	0 432 193 621 <sup>1</sup>
						5	0 432 193 823





<b>2.5</b> TDI, TDI Syncro [70, 7D]	2,5	75	ACV	07.95-06.03	AG	5	<b>0 432 193 619</b> <sup>1</sup>		
					GS	5	<b>0 432 193 621</b> <sup>1</sup>		
				Fg.-Nr. →70..2..075 000	07.95-10.01	AG	5	<b>0 432 193 662</b>	
					GS	5	<b>0 432 193 823</b>		
			Fg.-Nr. 70..2..075 000→	11.01-06.03		5	<b>0 432 193 662</b>		
<b>LT</b>									
<b>28</b> 2.5 SDI [2D, 2H]	2,5	55	AGX	05.96-01.99		5	<b>0 432 193 617</b> <sup>1</sup>		
						5	<b>0 432 193 716</b>		
				Fg.-Nr. →2D..X..027 000	02.99-04.01	5	<b>0 432 193 621</b> <sup>1</sup>		
			Fg.-Nr. 2D..X..027 001→			5	<b>0 432 193 823</b>		
2.5 TDI [2D, 2H]	2,5	61	BBE	04.01-04.06		5	<b>0 432 193 621</b> <sup>1</sup>		
						5	<b>0 432 193 823</b>		
				66/75	AHD; APA	05.96-04.01	5	<b>0 432 193 621</b> <sup>1</sup>	
						5	<b>0 432 193 823</b>		
				70	BBF	04.01-04.06	5	<b>0 432 193 621</b> <sup>1</sup>	
						5	<b>0 432 193 823</b>		
				80	ANJ	05.99-04.06	5	<b>0 432 193 619</b> <sup>1</sup>	
	AVR	12.02-04.06	5	<b>0 432 193 508</b> <sup>1</sup>					
				5	<b>0 432 193 510</b>				
2.8 D Turbo [2D, 2H]	2,8	92/96	AGK; ATA	07.97-01.02		4	<b>0 432 193 731</b>		
<b>35</b> 2.5 SDI [2D, 2H]	2,5	55	AGX	05.96-01.99		5	<b>0 432 193 617</b> <sup>1</sup>		
						5	<b>0 432 193 716</b>		
				Fg.-Nr. →2D..X..027 000	02.99-04.01	5	<b>0 432 193 621</b> <sup>1</sup>		
			Fg.-Nr. 2D..X..027 001→			5	<b>0 432 193 823</b>		
2.5 TDI [2D, 2H]	2,5	61	BBE	04.01-04.06		5	<b>0 432 193 621</b> <sup>1</sup>		
						5	<b>0 432 193 823</b>		
				66/75	AHD; APA	05.96-04.01	5	<b>0 432 193 621</b> <sup>1</sup>	
						5	<b>0 432 193 823</b>		
				70	BBF	04.01-04.06	5	<b>0 432 193 621</b> <sup>1</sup>	
						5	<b>0 432 193 823</b>		
				80	ANJ	05.99-04.06	5	<b>0 432 193 619</b> <sup>1</sup>	
	AVR	12.02-04.06	5	<b>0 432 193 508</b> <sup>1</sup>					
				5	<b>0 432 193 510</b>				
2.8 D Turbo [2D, 2H]	2,8	92/96	AGK; ATA	07.97-01.02		4	<b>0 432 193 731</b>		
<b>46</b> 2.5 SDI [2D, 2H]	2,5	55	AGX	05.96-01.99		5	<b>0 432 193 617</b> <sup>1</sup>		
						5	<b>0 432 193 716</b>		
				Fg.-Nr. →2D..X..027 000	02.99-04.01	5	<b>0 432 193 621</b> <sup>1</sup>		
			Fg.-Nr. 2D..X..027 001→			5	<b>0 432 193 823</b>		
2.5 TDI [2D, 2H]	2,5	61	BBE	04.01-04.06		5	<b>0 432 193 621</b> <sup>1</sup>		
						5	<b>0 432 193 823</b>		
				66/75	AHD; APA	05.96-04.01	5	<b>0 432 193 621</b> <sup>1</sup>	
						5	<b>0 432 193 823</b>		
				70	BBF	04.01-04.06	5	<b>0 432 193 621</b> <sup>1</sup>	
						5	<b>0 432 193 823</b>		
				80	ANJ	05.99-04.06	5	<b>0 432 193 619</b> <sup>1</sup>	
	AVR	12.02-04.06	5	<b>0 432 193 508</b> <sup>1</sup>					
				5	<b>0 432 193 510</b>				
2.8 D Turbo [2D, 2H]	2,8	92/96	AGK; ATA	07.97-01.02		4	<b>0 432 193 731</b>		
<b>L80</b>									
[2V]	4,3	103	AGF	01.95-12.99		4	<b>9 430 082 759</b>		
<b>Multivan T4</b>									
<b>1.9</b> D Turbo [70, 7D]	1,9	50	ABL	10.92-06.03		4	<b>0 432 217 242</b>	<b>0 986 430 188</b>	
<b>2.4</b> D, D Syncro [70, 7D]	2,4	55/57	AAB; AJA	09.90-06.03		5	<b>0 432 217 207</b>	<b>0 986 430 189</b>	
<b>2.5</b> TDI [70, 7D]	2,5	65	AYY	10.01-06.03		5	<b>0 432 193 619</b> <sup>1</sup>		
						5	<b>0 432 193 662</b>		





◀ VW

2.5 TDI [70, 7D]	2,5	75	AUF	05.99-06.03	AG	5	0 432 193 619 <sup>1</sup>		
					GS	5	0 432 193 621 <sup>1</sup>		
				Fg.-Nr. →70..2..075 000	05.99-10.01		5	0 432 193 823	
				Fg.-Nr. 70..2..075 000→	11.01-06.03		5	0 432 193 662	
				AYC	04.01-06.03	AG	5	0 432 193 619 <sup>1</sup>	
						GS	5	0 432 193 621 <sup>1</sup>	
				Fg.-Nr. →70..2..075 000	04.01-10.01		5	0 432 193 823	
				Fg.-Nr. 70..2..075 000→	11.01-06.03		5	0 432 193 662	
				111	AHY	05.98-09.00		5	0 432 193 608 <sup>1</sup>
								5	0 432 193 669
AXG	09.00-06.03		5			0 432 193 550 <sup>1</sup>			
			5			0 432 193 552			
TDI Syncro [70, 7D]	2,5	75	AXL	04.01-06.03		5	0 432 193 621 <sup>1</sup>		
						5	0 432 193 823		
TDI, TDI Syncro [70, 7D]	2,5	75	ACV	07.95-06.03	AG	5	0 432 193 619 <sup>1</sup>		
					GS	5	0 432 193 621 <sup>1</sup>		
				Fg.-Nr. →70..2..075 000	07.95-10.01	AG	5	0 432 193 662	
					GS	5	0 432 193 823		
			Fg.-Nr. 70..2..075 000→	11.01-06.03		5	0 432 193 662		

**Transporter T4**

1.9 D Turbo [70, 7D]	1,9	50	ABL	10.92-06.03		4	0 432 217 242	0 986 430 188		
2.4 D, D Syncro [70, 7D]	2,4	55/57	AAB; AJA	09.90-06.03		5	0 432 217 207	0 986 430 189		
2.5 TDI [70, 7D]	2,5	65	AYY	10.01-06.03		5	0 432 193 619 <sup>1</sup>			
						5	0 432 193 662			
			75	AUF	05.99-06.03	AG	5	0 432 193 619 <sup>1</sup>		
						GS	5	0 432 193 621 <sup>1</sup>		
					Fg.-Nr. →70..2..075 000	05.99-10.01		5	0 432 193 823	
					Fg.-Nr. 70..2..075 000→	11.01-06.03		5	0 432 193 662	
			AYC	04.01-06.03	AG	5	0 432 193 619 <sup>1</sup>			
					GS	5	0 432 193 621 <sup>1</sup>			
				Fg.-Nr. →70..2..075 000	04.01-10.01		5	0 432 193 823		
				Fg.-Nr. 70..2..075 000→	11.01-06.03		5	0 432 193 662		
			111	AHY	05.98-09.00		5	0 432 193 608 <sup>1</sup>		
							5	0 432 193 669		
			AXG	09.00-06.03		5	0 432 193 550 <sup>1</sup>			
						5	0 432 193 552			
			TDI Syncro [70, 7D]	2,5	75	AXL	04.01-06.03		5	0 432 193 621 <sup>1</sup>
									5	0 432 193 823
TDI, TDI Syncro [70, 7D]	2,5	75	ACV	07.95-06.03	AG	5	0 432 193 619 <sup>1</sup>			
					GS	5	0 432 193 621 <sup>1</sup>			
				Fg.-Nr. →70..2..075 000	07.95-10.01	AG	5	0 432 193 662		
					GS	5	0 432 193 823			
			Fg.-Nr. 70..2..075 000→	11.01-06.03		5	0 432 193 662			

**12t**

12 .140 H	5,9	99	D 229-6	03.94-02.00		6	9 430 082 289
-----------	-----	----	---------	-------------	--	---	---------------

**14t**

14 .150	6,5	105	6.10	11.95-02.00		6	9 430 082 767
.170	8,3	121	6 CTAA	02.88-02.98		6	0 432 191 812
.170 BT	5,8	116	6 BTAA	04.97-02.00		6	0 432 133 838
.210	8,3	157	6 CT	02.88-02.98		6	0 432 191 799
.220	8,3	157	6 CT	11.95-02.00		6	9 430 082 762

**16t**

16 .210	8,3	160	6 CT	01.95-02.00		6	9 430 082 762
.220	8,3	160	6 CT	11.95-02.00		6	9 430 082 762

**24t**

24 .220	8,3	158	6 CT	11.95-03.06		6	9 430 082 753
.250	8,3	184	6CTAA	05.92-01.02		6	9 430 082 753

**35t**

35 .300	8,3	214	6 CTAA	04.91-02.00		6	9 430 082 753
---------	-----	-----	--------	-------------	--	---	---------------





**WHITE**

Serie WLC										
WCL 12.0	12,0	232	TD 121 FC		04.85→	6	0 432 191 863	0 986 430 032		





## BENFRA

<b>Serie 9</b>						
9.32	5,9	96	8361 SI 10.00		01.90-01.05	6 0432 281 704

## CASE

<b>N</b>						
580	4,5	59	445T/M3		03.12→	4 0432 133 761
<b>Serie 400</b>						
430	4,5		445T/M3		02.05-12.08	4 0432 133 771
440/440CT 3	4,5	65	445T/M3		01.08→	4 0432 133 761
445/445CT	3,2		432T/M		01.05-12.07	4 0432 133 771
450/450CT Serie3	4,5	65	445T/M3		01.08→	4 0432 133 761
<b>TX</b>						
130-30	4,5		445M2		03.05-12.08 TW	4 0432 133 761
						4 0432 133 771
130-33	4,5		445M2		03.05-12.14 TW	4 0432 133 761
						4 0432 133 771
<b>WX</b>						
95	4,5	74	F4GE9484 <Tier 3>		01.08-12.12	4 0432 133 761
125	4,5		F4GE9484 <Tier 3>		07.07-12.12	4 0432 133 764
145	4,5		F4GE9484 <Tier 3>		06.07-12.10	4 0432 133 764
148	4,5		F4GE9484 <Tier 3>		06.10→	4 0432 133 764
165	6,7		F4GE9684 <Tier 3>		06.07-12.10	6 0432 133 764
168	6,7		F4GE9684 <Tier 3>		06.10→	6 0432 133 764
185	6,7		F4GE9684 <Tier 3>		06.07-12.10	6 0432 133 764
188	6,7		F4GE9684 <Tier 3>		07.11-01.18	6 0432 133 764
210	6,7		F4GE9684 <Tier 3>		01.07-12.10	6 0432 133 764
240	6,7		F4GE9684 <Tier 3>		06.07-12.10	6 0432 133 764

## CASE IH (CASE INTERNATIONAL)

<b>Farmall</b>						
55 C	3,2	43	F5AE9454J <Tier 3>		09.11→	4 0432 193 433
65 C	3,2	48	F5AE9454L <Tier 3>		09.11→	4 0432 193 433
75 C	3,2	55	F5AE9454K <Tier 3>		09.11→	4 0432 193 433
<b>Maxxum</b>						
110 12X12	4,5	66			01.07-12.13	4 0432 133 761
115 Multicontroller, 12X12	6,7	70/86	NEF <Tier 3>		03.07-12.13	6 0432 133 764
125 Multicontroller, 12X12	6,7	77/93	NEF <Tier 3>		03.07-12.13	6 0432 133 764
140 Multicontroller	6,7	104	NEF <Tier 3>		03.07-12.13	6 0432 133 764
<b>Maxxum MXM</b>						
120	7,5	89			09.02→	6 0432 193 524
130	7,5	96			09.02→	6 0432 193 524
140	7,5	106			09.02→	6 0432 193 524
155	7,5	114			09.02→	6 0432 193 524
175	7,5	130				
			Mot.-Typ D4874→		09.02→	6 0432 191 351
			Mot.-Typ →C4874		09.02→	6 0432 193 524
190	7,5	144				
			Mot.-Typ D4874→		09.02→	6 0432 191 351
			Mot.-Typ →C4874		09.02→	6 0432 193 524
<b>Quantum</b>						
65 V	3,2	48			01.12→	4 0432 193 433
75 C, V/N/F	3,2	57	F5AE9454K <Tier 3>		04.08→	4 0432 193 433
85 V/N/F	3,2	65			01.12→	4 0432 193 433
95 C	4,5	71			01.07-12.14	4 0432 133 761
V/N/F	4,4	71	NEF <Tier 3>		01.12→	4 0432 133 761





Serie E						
21E	3,2	38	432T/M3		11.07-12.14	4 0 432 193 447
Serie JX						
60	3,2	44	NEF 3200 TCI		09.08-12.13	4 0 432 193 433
70	3,2	53	NEF 3200 TCI		09.08-12.13	4 0 432 193 433
80	3,2	60	NEF 3200 TCI		09.08-12.13	4 0 432 193 433
90	4,5	65/66	F4CE9484 <Tier 3>		01.07-12.13	4 0 432 133 761
95	4,5	70	F4CE9484 <Tier 3>		01.07-12.14	4 0 432 133 761
Serie JXC						
1085	4,5	60	445M2		01.05-12.08	4 0 432 133 771
Serie JXU						
75	4,5	56			01.08-12.14	4 0 432 133 761
85	4,5	63			01.08-12.14	4 0 432 133 761
95	4,5	71			01.08-12.14	4 0 432 133 761
105	4,5	78			01.08-12.14	4 0 432 133 761
115	4,5	83			01.08-12.14	4 0 432 133 761
Serie 7000						
7130	8,3	149	6CT		01.88-01.03	6 0 432 191 812
7140	8,3	169	6CTA		01.88-01.03	6 0 432 191 796

## DEUTZ-FAHR

Agrotron						
200 MK3	7,1	147	BF 6M 1013 EC		01.01-12.03	6 0 432 191 327
230 MK3	7,1	169	BF 6M 1013 EC		01.01-12.03	6 0 432 191 327
260 MK3	7,1	191	BF 6M 1013 EC		01.01-12.03	6 0 432 191 327
Agrotron TTV						
1130	7,1	92	BF 6M 1013 E		01.01-12.03	6 0 432 191 327
1145	7,1	103	BF 6M 1013 E		01.01-12.03	6 0 432 191 327
1160	7,1	110	BF 6M 1013 E		01.01-12.03	6 0 432 191 327
D 07						
2807	1,9	21	F 2 L 912		06.86-06.01	2 0 432 291 753 0 986 430 067
3607	1,9	25	F 2 L 912		06.86-06.01	2 0 432 291 753 0 986 430 067
6807	3,8	49	F4L 912		06.86-06.01	4 0 432 291 753 0 986 430 067
7007	3,8	51	F4L 912		06.86-06.01	4 0 432 291 753 0 986 430 067
DX						
3 .10 A, .10 F/V, .30 A, .30 F/V	2,8	34/40	F 3 L 912		06.86-06.01	3 0 432 291 753 0 986 430 067
.50 A, .50 F/V	3,1	40/44	F3L 913		06.86-06.01	3 0 432 291 753 0 986 430 067
.60, .70 A, .70 F/V	3,8	48-51	F4L 912		06.86-06.01	4 0 432 291 753 0 986 430 067
.80, .90 A, .90 F/V	4,1	55	F 4 L 913		06.86-06.01	4 0 432 291 753 0 986 430 067
4 .10	3,8	51	F4L 912		06.86-06.01	4 0 432 291 753 0 986 430 067
.30 A, .50 A, .51, .70 A	4,1	55-66	BF4L 913; BF4L 913 T; F 4 L 913		06.86-01.05	4 0 432 291 753 0 986 430 067
6 .05/.10 A	5,7	72-74	F6L 912		06.86-06.01	6 0 432 291 753 0 986 430 067
.30 A	6,1	85	F 6 L 913		06.86-06.01	6 0 432 291 753 0 986 430 067
.50 A, .60	6,1	101/110	BF6L 913		06.86-06.01	6 0 432 291 669
					06.86-10.03	6 0 432 291 669
7 .10 A	6,1	117	BF6L 913		06.86-06.01	6 0 432 291 669
Intrac						
6 .30 turbo	6,0	93	BF6L 913 T		01.89-01.04	6 0 432 291 669
.60 turbo	6,1	110	BF6L 913		01.88-01.03	6 0 432 291 669
M						
3610	6,0	141	BF6L 913 C		03.87-03.02	6 0 432 291 752
3630	6,0	141	BF6L 913 C		03.87-03.02	6 0 432 291 752

## EICHER

Serie 635-680						
635 K, KA	2,0	25,7	EDL 2-2		01.86-01.01 KOC	2 0 432 291 695
642 K, KA	1,9	31	EDL 2-4		01.86-01.01 KOC	2 0 432 291 695
645 K, KA	2,9	31	EDL 3-6		01.86-01.01 KOC	3 0 432 291 695
648 V, VA	2,9	35	EDL 3-7.2		01.87-01.02 KOC	3 0 432 291 695





## ◀ EICHER

666 P, PA, V, VA	2,9	49	EDL 3-9.1	01.86-01.02	KOC	3	<b>0 432 291 695</b>
680 P, PA	3,9	59	EDL 4-5.1	01.87-01.02	KOC	4	<b>0 432 291 695</b>
<b>Serie 3000</b>							
3028	5,9	82	EDL 6-5	09.83-09.98	KOC	6	<b>0 432 291 695</b>
3030	5,9	107	EDL 6-6	09.83-09.98	KOC	6	<b>0 432 291 695</b>
<b>Serie 3500</b>							
3559	3,9	53	EDL 4-4	01.84-01.99	KOC	4	<b>0 432 291 695</b>
3560	3,9	53	EDL 4-4	01.84-01.99	KOC	4	<b>0 432 291 695</b>

## FIAT-ALLIS

<b>FA</b>							
150	8,1	122	8365.25.542	03.84-03.99		6	<b>0 432 281 704</b>
<b>FR</b>							
130	5,9	107	8065.25.094	04.90-04.05		6	<b>0 432 291 655</b>

## FORD NEW HOLLAND

<b>TF</b>							
42	7,8	151	Ford-678 HTA	12.86-12.01		6	<b>9 430 082 711</b>
<b>TR</b>							
86	7,8	177	Ford-678 HTA	01.89-01.04		6	<b>9 430 082 711</b>
<b>TX</b>							
30	6,6	103	Ford-666 HT	01.86-01.01		6	<b>9 430 082 714</b>
32	6,6	114	Ford-666 HT	01.86-01.01		6	<b>9 430 082 714</b>
34	7,8	135	Ford-678 HT	04.87-04.02	TW	6	<b>0 432 191 667</b>
						6	<b>9 430 082 708</b>
		151	Ford-678 HTA	06.86-06.01	TW	6	<b>0 432 191 667</b>
						6	<b>9 430 082 711</b>
36	7,8	176	Ford-678 HTA	12.86-12.01		6	<b>9 430 082 711</b>

## HÜRLIMANN (SLH)

<b>H</b>							
468 ,.4	4,0	51	1000.4 W	06.86-06.01		4	<b>0 432 291 685</b>
478 ,.4	4,0	58,8	1000.4 W	06.86-06.01		4	<b>0 432 291 685</b>
488 T	4,0	65	1000.4 WT	06.86-06.01		4	<b>0 432 291 685</b>

## JOHN DEERE

<b>Serie 4000</b>							
4320	2,4	36	4024T				
			Mot.-Nr. 285856→	01.05→		4	<b>0 432 221 856</b>
4850	7,6	175	6076 HRW-01	03.89-03.04		6	<b>0 432 131 865</b>
<b>Serie 5000</b>							
5830	10,0	212	6619 AE-03	10.89-10.04		6	<b>9 430 233 003</b>

## KÄSSBOHRER

<b>FM-Serie</b>							
23.150 K	6,1	112	BF 6 L 913	01.88-01.03		6	<b>0 432 291 752</b>

## KOMATSU

<b>BA-Serie</b>							
100-1	3,3		4D95L-1				
			Fg.-Nr. 1003→Mot.-Nr. 100005→	08.04→	ZDA	4	<b>9 430 613 527</b>



BR-Serie							
<b>100JG-2</b>	3,3	40	4D95L-1 Fg.-Nr. 1301→ Mot.-Nr. 100005→	08.04→	ZDA	4	<b>9 430 613 527</b>
<b>200T-1</b>	11,0	228	SA6D125 Fg.-Nr. 1101→ Mot.-Nr. 60721→	08.04→	ZDA	6	<b>9 430 612 114</b>
<b>500JG-1</b>	11,0	228	SA6D125 Fg.-Nr. 1002→ Mot.-Nr. 60721→	08.04→	ZDA	6	<b>9 430 612 114</b>
D-Serie							
<b>20</b>	3,3	30	4D95S Fg.-Nr. 60001→ Mot.-Nr. 23318→	08.04→	ZDA	4	<b>9 430 610 358</b>
<b>21</b>	3,3	30	4D95S Fg.-Nr. 60001→ Mot.-Nr. 23318→	08.04→	ZDA	4	<b>9 430 610 358</b>
<b>85EX-15</b>	11,0	197-199	SAA6D125E-5	03.13→	ZDA	6	<b>9 430 612 115</b>
<b>85-21</b>	11,0	170	S6D125	05.12→	TW,ZDA	6	<b>9 430 610 110</b>
						6	<b>9 430 612 115</b>
						6	<b>9 430 615 249</b>
<b>155-3</b>	15,2	225-231	SA6D140 Fg.-Nr. 60001→ Mot.-Nr. 22537→	03.08→	ZDA	6	<b>9 430 612 124</b>
<b>155-5</b>	15,2	225-231	SA6D140 Fg.-Nr. 60001→ Mot.-Nr. 22537→	03.08→	ZDA	6	<b>9 430 612 124</b>
<b>275A-2</b>	23,2	301	SA6D170 Fg.-Nr. 10001→ Mot.-Nr. 17001→	05.13→	ZDA	6	<b>9 430 613 556</b>
<b>375A-3</b>	23,2	391	SA6D170 Fg.-Nr. 10001→ Mot.-Nr. 17001→ 17353→	08.12→	ZDA	6	<b>9 430 613 556</b>
<b>375A-5D</b>	23,2	391	SA6D170 Fg.-Nr. 17743→ Mot.-Nr. 17001→	07.13→	ZDA	6	<b>9 430 613 556</b>
EC-Serie							
<b>50Z</b>	3,3		4D95S Fg.-Nr. 1001→ 20001→ Mot.-Nr. 17743→ 39040→	05.12→	ZDA	4	<b>9 430 610 358</b>
EG-Serie							
<b>33</b>	3,3		4D95L-1 Fg.-Nr. 4001→ 4501→ Mot.-Nr. 19772→ 19778→	05.12→	ZDA	4	<b>9 430 610 358</b>
<b>400</b>	15,2		SA6D140 Fg.-Nr. 1001→ Mot.-Nr. 19107→	05.12→	ZDA	6	<b>9 430 612 146</b>
EGS-Serie							
<b>45-5</b>	3,1	32	4D94LE-2	12.05→	ZDA	4	<b>9 430 613 527</b>
HD-Serie							
<b>255-5</b>	11,0	235-241	SA6D125 Fg.-Nr. 1001→ Mot.-Nr. 60721→	10.04→	ZDA	6	<b>9 430 612 114</b>
<b>325-6</b>	15,2	364-379	SAA6D140	12.04→	TW,ZDA	6	<b>9 430 612 125</b>
<b>465-5</b>	23,2	533-551	SAA6D170	08.04→	TW	6	<b>9 430 612 128</b>
					TW,ZDA	6	<b>9 430 613 791</b>
<b>785-5</b>	30,5	753-783	SA12V140	08.04→	TW	12	<b>9 430 615 876</b>
					TW,ZDA	12	<b>9 430 614 012</b>
						12	<b>9 430 615 155</b>
						12	<b>9 430 615 875</b>





◀ KOMATSU

PC-Serie							
60-7	3,3	40,5	4D95L-1 Fg.-Nr. 45001→ Mot.-Nr. 100005→	02.03→	ZDA	4	9 430 613 527
70-7	3,3	50	4D95L-1 Fg.-Nr. 45001→ Mot.-Nr. 100005→	08.04→	ZDA	4	9 430 613 527
75UU-3	3,3	50	4D95L-1 Fg.-Nr. 15001→ Mot.-Nr. 100005→	08.04→	ZDA	4	9 430 613 527
78US-5	3,3		4D95L-1 Fg.-Nr. 1001→ Mot.-Nr. 100005→	08.04→	ZDA	4	9 430 613 527
100-1	4,3	60	S4D105-5	05.12→	ZDA	4	9 430 610 097
100-2	4,3		S4D105-5	08.04→	ZDA	4	9 430 610 775
100-3	4,9		S6D95	05.12→		6	9 430 612 390
100-5	3,3	42-55	S4D95L-1	08.04→	TW,ZDA	4	9 430 610 068
						4	9 430 612 474
200-5	4,9		S6D95	05.12→	TW,ZDA	6	9 430 610 068
						6	9 430 612 474
200-6	4,9		S6D95	08.04→	ZDA	6	9 430 612 496
200-7	4,9	107	S6D95	08.13→	ZDA	6	9 430 612 496
200-8	4,9		S6D95	08.04→	ZDA	6	9 430 612 496
400-6	11,0	228	SA6D125 Fg.-Nr. 10001→ Mot.-Nr. 60721→ Fg.-Nr. 30001→	09.04→	ZDA	6	9 430 612 114
450-6	11,0	228-241	SA6D125 Fg.-Nr. 10001→ Mot.-Nr. 60721→ Fg.-Nr. 32106→K30001→	09.01→	ZDA	6	9 430 612 114
1000	23,2		SA6D170 Fg.-Nr. 10001→ Mot.-Nr. 17001→17353→	05.13→	ZDA	6	9 430 613 556
WA-Serie							
40-1	3,3		4D95L-1 Fg.-Nr. 1001→ Mot.-Nr. 10001→	08.04→	ZDA	4	9 430 610 358
70-1	3,3		4D95L-1 Fg.-Nr. 1001→ Mot.-Nr. 11437→ Fg.-Nr. 10001→	08.04→	ZDA	4	9 430 610 358
350-3	7,2		SA6D108 Fg.-Nr. 60001→62999 Mot.-Nr. 19030→ Fg.-Nr. 63001→	08.04→	ZDA	6	9 430 612 636
400-3	7,2		SA6D108 Fg.-Nr. 60001→62999 Mot.-Nr. 19030→ Fg.-Nr. 63001→53001→50001→52999	08.04→	ZDA	6	9 430 612 636
450-3	11,0	194-202	SA6D125 Fg.-Nr. 53001→ Mot.-Nr. 60721→ Fg.-Nr. 50001→52999 63001→ 60001→62999	10.96→	ZDA	6	9 430 612 114
600-3	23,2	357-389	SAA6D170 Fg.-Nr. 50001→ Mot.-Nr. 17001→17353→	02.09→	ZDA	6	9 430 613 556
WD-Serie							
600-1	23,2	393-396	SA6D170 Fg.-Nr. 10001→Mot.-Nr. 21546→	05.09→	ZDA	6	9 430 613 556





WF-Serie							
450-3	7,2	194	SA6D108		07.13→	ZDA	6 9 430 612 114
			Fg.-Nr. 53001→				
			Mot.-Nr. 60721→				
			Fg.-Nr. 54001→				
650T-3	23,2		SA6D170		05.13→	ZDA	6 9 430 613 556
			Fg.-Nr. 50001→				
			Mot.-Nr. 17001→				
WR-Serie							
8-1	3,3	55	4D95L-1		08.04→	ZDA	4 9 430 610 358
			Fg.-Nr. 19001→				
			Mot.-Nr. 11437→				

## LAMBORGHINI

C-Serie							
554 Compact, Ergomatic	2,8	39	100.3 P		06.87-12.00		3 0 432 281 705
664 Compact HD, Ergomatic	3,1	46	103.5 P; 105.3 P		06.87-12.00		3 0 432 281 705
774 .80	4,0	59	1000.4 W		06.86-12.00		4 0 432 291 685
100-Serie							
105 Formula	4,0	75	1000.4 WTI		03.89-12.99		4 0 432 291 685
600-Serie							
660	3,1	44	105.3 P		01.87-12.99		3 0 432 281 705
F	3,0	44	1000.3 A		06.87-12.99		3 0 432 291 685
674 -70	4,0	54	1000.4 W		06.86-12.99		4 0 432 291 685
700-Serie							
774 -80, -80 DT, -80 N	4,0	54	1000.4 W		06.86-12.99		4 0 432 291 685
775	4,0	54	1000.4 W		06.87-12.99		4 0 432 291 685
800-Serie							
874 .90	4,0	65	1000.4 WT		06.86-12.99		4 0 432 291 685
900-Serie							
956 DT, 2 RM	5,5	70	916.6 W 1		01.84-12.99		6 0 432 291 737
1000-Serie							
1106 DT, 2 RM	5,5	81	916.6 W 2		01.84-12.99		6 0 432 291 685
1306 Turbo DT	5,5	92	916/6 WT		01.84-12.99		6 0 432 291 685
1506 Turbo	6,8	107	1106 HT		01.84-12.99		6 0 432 291 737
1706 Turbo	6,8	121	1106 AT		01.84-12.99		6 0 432 291 737

## LINDE

H							
20	3,1	35	F 3 L 913 G		01.87-11.99		3 0 432 191 712
25	3,1	35	F 3 L 913 G		01.87-11.99		3 0 432 191 712
30	3,1	35	F 3 L 913 G		01.87-11.99		3 0 432 191 712
70	5,7	74	F 6 L 912		06.81→		6 0 432 291 753 0 986 430 067

## MASSEY FERGUSON (MF)

3600-Serie							
3625	3,3	51	33 DT		05.11→		3 0 460 423 028

## NEW HOLLAND

C							
190	4,5	59	445M2		01.06-12.07		4 0 432 133 771
L							
190	4,5	59	445M2		01.06-12.07		4 0 432 133 771
LM							
415 A	4,5	71	F4CE0454 <NEF 45>		11.03-12.07		4 0 432 133 779
		82	F4CE0454 <NEF 45>		11.03-12.07		4 0 432 133 775















◀ NEW HOLLAND

435 A	4,5	71	F4CE0454 <NEF 45>	11.03-12.07	4	0 432 133 779
		82	F4CE0454 <NEF 45>	11.03-12.07	4	0 432 133 775
445 A	4,5	71	F4CE0454 <NEF 45>	11.03-12.07	4	0 432 133 779
		82	F4CE0454 <NEF 45>	11.03-12.07	4	0 432 133 775
5040	4,5	88	F4BE0484F <Tier 2>	06.07-12.13	4	0 432 133 761
5060	4,5	88	F4BE0484F <Tier 2>	06.07-12.13	4	0 432 133 761
5080	4,5	88	F4BE0484F <Tier 2>	06.07-12.13	4	0 432 133 761
<b>LT</b>						
190 .B	4,5	59	445M2	03.05-12.06	4	0 432 133 771
<b>Serie LB</b>						
90 .B	4,5	71-74	F4GE0454C <Tier 2>	04.03-12.06	4	0 432 133 779
95 .B	4,5	71-74	F4GE0454C <Tier 2>	04.03-12.06	4	0 432 133 779
<b>Serie TM</b>						
115	7,5	88		11.99-06.02	6	0 432 191 650
120	7,5	82/91	Genesis	01.02-12.07	6	0 432 193 524
125	7,5	93	Genesis	09.00-12.07	6	0 432 191 650
130	7,5	86	Genesis	01.02-12.07	6	0 432 193 524
135	7,5	101	Genesis	09.00-12.07	6	0 432 191 650
140	7,5	106	Genesis	12.02-12.07	6	0 432 193 524
150	7,5	110	GSD675T	11.99-01.08	6	0 432 191 650
		115	Genesis	01.02-12.07	6	0 432 193 524
165	7,5	119	GSD675T	11.99-01.08	6	0 432 191 650
175	7,5	130	Genesis			
			Fg.-Nr. D4874→	06.02-12.07	6	0 432 191 351
			Fg.-Nr. →C4874	06.02-12.07	6	0 432 193 524
180	7,5	130	Genesis	07.04-01.08	6	0 432 191 650
190	7,5	142	Genesis			
			Fg.-Nr. D4874→	06.02-12.07	6	0 432 191 351
			Fg.-Nr. →C4874	06.02-12.07	6	0 432 193 524
<b>Serie 60</b>						
M 100	7,5	74	TC456	09.95-12.99	6	0 432 191 650
M 115	7,5	85	TD456	09.95-12.99	6	0 432 191 641
M 135	7,5	99	WL456	09.95-12.99	6	0 432 191 650
M 160	7,5	118	WM456	09.95-12.99	6	0 432 191 650
8160	7,5	74	TC456	02.96-01.00	6	0 432 191 650
8260	7,5	85	TD456	02.96-01.00	6	0 432 191 641
8360	7,5	100	WL456	02.96-01.00	6	0 432 191 650
8560	7,5	118	WM456	02.96-01.00	6	0 432 191 650
<b>T</b>						
4020 Deluxe, V	3,2	48		04.08→	4	0 432 193 433
4030 Deluxe, F, N, V	3,2	57		04.08→	4	0 432 193 433
4040 Deluxe	4,5	63	F4CE0454 <NEF 45>	12.07-12.14	4	0 432 133 761
F, N, V	3,2	65		06.08→	4	0 432 193 433
4050 Deluxe, F, N, V	4,5	71	F4CE0454 <NEF 45>	12.07→	4	0 432 133 761
4060 F, N, V	4,5	78	F4CE9484L	02.12→	4	0 432 133 761
5030	4,5	56	F4CE0454 <NEF 45>	12.07-12.14	4	0 432 133 761
5040	4,5	63	F4CE0454 <NEF 45>	01.07-12.14	4	0 432 133 761
5050	4,5	71	F4CE0454 <NEF 45>	01.07-12.14	4	0 432 133 761
5060	4,5	78	F4CE0454 <NEF 45>	01.07-12.14	4	0 432 133 761
5070	4,5	83	F4CE0454 <NEF 45>	01.08-12.14	4	0 432 133 761
<b>TD</b>						
60	2,9	44		01.06→	TIE	3 0 432 291 495
			Mot.-Nr. 5096705	01.06→	X96	3 0 432 191 231
			Mot.-Nr. 47125223	01.06→	X96	3 0 432 291 492
			Mot.-Nr. 47125224			
80	2,9	59		01.06→	TIE	3 0 432 291 495
					X96	3 0 432 191 231
	3,9	59	8045.06.260			
			Mot.-Nr. 47125297	01.06→		4 0 432 291 492
			Mot.-Nr. 87521995			
90	2,9	66		01.06→		3 0 432 291 494
	3,9	66	84527375	01.06→		4 0 432 291 509



										
95		2,9	72			01.06→		3	0 432 291 494	
		3,9	72	84527375		01.06→		4	0 432 291 509	
<b>TDD</b>										
TD75D		3,6	54	8045.06 <Tier 2>		01.06-12.09		4	0 432 291 492	
<b>TD3</b>										
.50		2,9	36	47636590		02.15→		3	F 002 C7Z 377	
<b>TD5</b>										
5040		4,5	65,6	F4CE0454 <NEF 45>		12.07-12.14		4	0 432 133 761	
.100		3,9	73	845273...		11.12→		4	F 002 C7Z 377	
.105		4,5	78	F4CE9484L		12.12-12.15		4	0 432 133 761	
.110		3,9	81	8453464...		11.12→		4	F 002 C7Z 397	
.115		4,5	83	F4CE9484C		12.12-12.15		4	0 432 133 761	
.65		2,9	48	8452738...		11.12→		3	F 002 C7Z 377	
.75		2,9	53	84560055		12.12-12.15		3	F 002 C7Z 377	
		3,9	56	8452737...		11.12→		4	F 002 C7Z 377	
.80		2,9	60	84527383		11.12→		3	F 002 C7Z 378	
.85		3,2	60	F5AE9484L		12.12-12.15		4	0 432 193 433	
.90		3,9	66	8452737...		11.12→		4	F 002 C7Z 377	
.95		4,5	70	F4CE9487N		12.12-12.15		4	0 432 133 761	
<b>TD4000F</b>										
4.70		3,2	48	F5AE9484A		07.15→		4	0 432 193 433	
4.80		3,2	57	F5AE9484B		07.15→		4	0 432 193 433	
4.90		3,2	65	F5AE9484G		07.15→		4	0 432 193 433	
4020		3,2	48	F5AE9484A		09.09-12.15		4	0 432 193 433	
4030		3,2	57	F5AE9484B		09.09-12.15		4	0 432 193 433	
4040		3,2	65	F5AE9484G		09.09-12.15		4	0 432 193 433	
<b>TK</b>										
80 A, MA		3,9	57	8045.25 <Tier 2>		02.04-12.09		4	0 432 291 492	
4020		3,2	48			03.09→		4	0 432 193 433	
4030		3,2	57			03.09→		4	0 432 193 433	
4040		3,2	65			03.09→		4	0 432 193 433	
4050		4,5	70			03.09→		4	0 432 133 761	
4060		4,5	74			03.09→		4	0 432 133 761	
<b>TL</b>										
70 A		4,5	53	4B		01.04-12.07		4	0 432 131 626	
80		4,5	60	4B						
				Fg.-Nr. 776979→		10.98-01.04		4	0 432 291 509	
				Mot.-Nr. →776978		10.98-01.04 TW		4	0 432 291 655	
A		4,5	60	4B		01.04-12.08		4	0 432 131 626	
90		4,5	67	4B						
				Fg.-Nr. →776978		10.98-01.04 TW		4	0 432 291 605	
				Fg.-Nr. 776979→		10.98-01.04		4	0 432 291 509	
A		4,5	67			01.04-12.07		4	0 432 133 780	
100		4,5	74	4B						
				Fg.-Nr. →776978		10.98-01.04		4	0 432 291 559	
				Fg.-Nr. 776979→		10.98-01.04		4	0 432 291 509	
A		4,5	73			01.04-12.08		4	0 432 133 780	
<b>TN</b>										
60 A, DA		2,9	44	8035.05 <Tier 2>		12.03-12.08		3	0 432 291 492	
SA, VA		2,9	44			12.03-12.08 TW		3	0 432 291 492	
65		2,9	44	8035.05		09.99-12.03		3	0 432 291 509	
70 A		2,9	53	8035.05 <Tier 2>		12.03-12.08		3	0 432 291 509	
SA		2,9	53	8035.05 <Tier 2>		12.03-12.08 TW		3	0 432 291 509	
75 A		2,9	55	8035.05 <Tier 2>		12.03-12.08		3	0 432 291 509	
SA		2,9	55	8035.05 <Tier 2>		12.03-12.08 TW		3	0 432 291 509	
85 A, DA, SA		4,5	62,6	4B		01.04-12.08		4	0 432 133 771	
90 F		3,9	66	8045.25 <Tier 2>		09.97-10.01		4	0 432 291 509	
95 DA		4,5	66			10.05-12.07		4	0 432 133 780	
F		3,9	68	8045.25 <Tier 2>		10.01-01.04		4	0 432 291 509	
VA		4,5	66			12.04-12.08 TW		4	0 432 291 509	
<b>TS</b>										
100A 12x12		4,5	75	F4CE9484C		10.03-12.07		4	0 432 133 780	
115A 12x12		6,7	86			07.03-12.07		6	0 432 133 779	







## ◀ NEW HOLLAND

T3						
.50F	2,9	37	47375489	01.14-12.15	3	F 002 C7Z 377
.55F	2,9	40,4	47375488	01.14-12.15	3	F 002 C7Z 377
.65F	2,9	48	47375487	01.14-12.15	3	F 002 C7Z 377
.75F	2,9	55	47375485	01.14-12.15	3	F 002 C7Z 377
T4						
.105 F	4,5	78	F4CE9484L	07.13→	4	0 432 133 761
.105 LP	4,5	78	F4CE9484L	01.15→	4	0 432 133 761
.105 N	4,5	78	F4CE9484L	07.13→	4	0 432 133 761
.105 V	4,5	78	F4CE9484L	07.13→	4	0 432 133 761
.65 V	3,2	48		07.13→	4	0 432 193 433
.75 F	3,2	57	F5AE9484G	07.13→	4	0 432 193 433
.75 LP	3,2	57	F5AE9484G	01.15→	4	0 432 193 433
.75 N	3,2	57	F5AE9484G	07.13→	4	0 432 193 433
.75 V	3,2	57	F5AE9484G	07.13→	4	0 432 193 433
.85	3,2	65	F5AE9484G	01.15→	4	0 432 193 433
.85 F	3,2	65		07.13→	4	0 432 193 433
.85 N	3,2	65		07.13→	4	0 432 193 433
.85 V	3,2	65		07.13→	4	0 432 193 433
.95	4,5	71	F4CE0454 <NEF 45>	07.13→	4	0 432 133 761
.95 F	4,5	71	F4CE0454 <NEF 45>	07.13→	4	0 432 133 761
.95 LP	4,5	71	F4CE9484L	01.15→	4	0 432 133 761
.95 V	4,5	71	F4CE0454 <NEF 45>	07.13→	4	0 432 133 761
T4 Powerstar						
.55	3,2	41	F5AE9454J <Tier 3>	09.11→	4	0 432 193 447
.65	3,2	48	F5AE9454L <Tier 3>	09.11→	4	0 432 193 433
.75	3,2	55	F5AE9454K <Tier 3>	09.11→	4	0 432 193 433
T6000						
6020 12x12	4,5	82	N45MNT	01.07→	4	0 432 133 761
6030 12x12, 16x16	6,7	86	N67ENT <6.7LI6DTA>; N67MNT	01.07-09.13	6	0 432 133 764
6050 12x12, 16x16	6,7	93	N67ENT <6.7LI6DTA>; N67MNT	01.07→	6	0 432 133 764
6070 16x16, 24x24	6,7	104	N67ENT <6.7LI6DTA>; N67MNT	01.07→	6	0 432 133 764
VL-Serie						
5060	4,5	94	F4GE9484A	01.07-12.16	4	0 432 133 764
5080	4,5	94	F4GE9484A	01.07-12.15	4	0 432 133 764
5090	4,5	94	F4GE9484A	01.07-12.15	4	0 432 133 764
VM-Serie						
3080	4,5	94	F4GE9484A	01.07-12.15	4	0 432 133 764
3090	4,5	94	F4GE9484A	01.07-12.15	4	0 432 133 764
4090	4,5	94	F4GE9484A	01.07-12.11	4	0 432 133 764
VN-Serie						
2090	4,5	94	F4GE9484A	01.07-12.14	4	0 432 133 764
Workmaster						
65	3,2	49		11.10-12.15	4	0 432 193 433
75	3,2	56		06.10-03.18	4	0 432 193 433

## POCLAIN

Serie 90						
90 P	5,7	78	F 6 L 912	01.76-01.01	6	0 432 291 753 0 986 430 067

## SAME (SLH)

Antares						
110	6,0	81	1000.6 A	12.89-12.04	6	0 432 291 685
130	6,0	96	1000.6 AT	12.89-12.04	6	0 432 291 685
Explorer						
60 Export, Special	3,0	44	100.3 A	06.86-06.01	3	0 432 291 685
70 C, Export, Special	4,0	51	1000.4 A	07.86-10.01	4	0 432 291 685
80 C, Export, Special	4,0	59	1000.4 A	07.86-10.01	4	0 432 291 685
90 Export	4,0	65	1000.4 AT	06.86-06.01	4	0 432 291 685



Frutteto						
60	3,0	44	1000.3 A	04.87-04.02	3	0 432 291 685
75	4,0	55	1000.4 A	04.87-04.02	4	0 432 291 685
Galaxy						
170	6,2	121	105.6 PTI	06.83-06.98	6	0 432 291 721
Laser						
100	5,2	72	105.5 P	03.84-03.99	5	0 432 281 705
110	5,7	81	100.6 P	05.83-03.98	6	0 432 281 705
130	6,2	92	1056 P	04.83-04.98	6	0 432 281 705
150	6,2	107	105.6 PS	03.83-03.98	6	0 432 291 721
Solar						
50	2,7	37	983 L	06.86-06.01	3	0 432 281 705
55 C	2,8	40	100.3 P	06.87-06.02	3	0 432 281 705
Titan						
160	6,0	117	1000.6 ATI	05.91-12.00	6	0 432 291 584
190	6,0	139-141	1000.6 WTRI	01.92-12.01	6	0 432 291 584
Transporter						
85	4,2	63	1054 P	01.91→	4	0 432 281 705

## STEYR (STEYR-DAIMLER-PUCH AG)

Serie Kompakt S						
4055 , Ecotech	3,2	41	F5	09.10→	4	0 432 193 433
4065 , Ecotech	3,2	48	F5	09.10→	4	0 432 193 433
Serie 8000						
8055	2,6	35	WD 311.46	09.86-09.01	3	0 432 292 873
a	2,6	35	WD 311.47	03.87-09.01	3	0 432 292 873
8065 , a	2,6	41	WD 311.85	09.86-09.01	3	0 432 291 623
8070 , a	3,5	47	WD 411.43, 44	10.84-10.99 KOC	4	0 432 291 622
8075 , a	3,5	47	WD 411.45, 46	01.84-01.99 KOC	4	0 432 291 622
8080 , a	3,5	53	WD 411.89, 90	06.84-06.99	4	0 432 291 623
8090 , a	3,5	59	WD 411.87, 88	01.84-01.99	4	0 432 291 623
8130 , a	5,2	81	WD 611.87, 88	07.84-07.99	6	0 432 291 623

## VOLVO BM

A						
20	6,7	137	TD 71 G	08.86-08.01	6	0 432 191 824
28	9,6		TD 102	04.87-04.03	6	0 432 191 788 0 986 430 167
30	9,6	200	TD 102 KF	01.91→	6	0 432 191 788 0 986 430 167
L						
50	4,5		TD 45 B	11.91→	4	0 432 191 841
70	4,5	85	TD 45 B	11.91→	4	0 432 191 800
90	5,5	115	TD 61 GB	11.91→	6	0 432 191 801 0 986 430 494
120	6,7	148	TD 71 G-285	01.87-01.02	6	0 432 191 802
LM 600						
622	0,0		D 45 B <LM 622>	03.85-03.00	4	0 432 191 841
642	0,0		D 45 B <LM 622>	03.85-03.00	4	0 432 191 841
LM 4000						
4200 B	0,0		D 45 B <LM 622>	03.85-03.00	4	0 432 191 841
4300	0,0		TD 45 B EM; TJD 45 B	03.85-03.00 KOC	4	0 432 191 813
			TD 45; TD 45 B	03.85-03.00 KOC	4	0 432 191 842
4500 B	0,0	147	TD 71 G	01.86-01.01	6	0 432 191 802
Serie 6000						
6300	4,5	84	TD 45 E	10.92→ KOC	4	0 432 191 722





**IVECO**

<b>8000</b>							
8061 .25.000, .25.010 [Aifo]	5,9	96/107-129	8061.25.000 <SI 25, SI 25.00>; 8061.25.010 <I 15>; 8061.25.010 <SI 05, SI 05.00>	01.90-12.00		6	<b>0 432 291 655</b>

<b>8300</b>							
8361 .25.510, .25.511 [Aifo]	8,1	154/184	8361.25.510 <SRI 15.25>; 8361.25.511 <SI 11>	04.86-12.99		6	<b>0 432 281 704</b>

**MAN**

<b>Serie D 0200</b>							
0226 MCE 51, MTE 51	5,7		D 0226 MCE 51 <Schlüter>; D 0226 MTE 51 <Schlüter>	06.84-12.00		6	<b>0 432 231 774</b>
ME 74	5,7	74	D 0226 ME 74 <Schlüter>	02.83-12.00	KOC	6	<b>0 432 231 820</b>

**MERCEDES-BENZ**

<b>OM</b>							
OM 366 LA	6,0	155	OM 366 LA	09.90→	KOC	6	<b>0 432 231 724 0 986 430 221</b>
OM 441	11,0	160	OM 441	02.91→		6	<b>0 432 231 709</b>
OM 442	15,0	206	OM 442	02.91→		8	<b>0 432 231 709</b>
OM 447 h	12,0	132	OM 447 h <Dänische, Privatbahn>	10.93→		6	<b>0 432 231 681</b>
OM 449 hLA	10,0	185	OM 449 hLA	05.96-12.05		5	<b>9 430 082 768</b>
OM 603 A	3,0	105	OM 603 A <Hägglunds>	09.89→		6	<b>0 432 217 266 0 986 430 247</b>
OM 904	4,3	125	OM 904.911 <OM 904 LA> Mot.-Nr. →..022247	01.97→		4	<b>0 432 193 480</b>
			Mot.-Nr. ..022248→	01.97→		4	<b>0 432 191 526</b>
OM 906	6,4	170	OM 906.910 <OM 906 LA> Komp.Nr. 505047/06	01.98→	TNK	6	<b>0 432 193 480</b>
			Mot.-Nr. →..022247				
			Komp.Nr. 505074/12/15	01.98→	TNK	6	<b>0 432 193 481</b>
			Mot.-Nr. ..022248→..056812	01.98→		6	<b>0 432 191 526</b>
			Komp.Nr. 505047/06				
			Mot.-Nr. ..056813→	01.98→	TNK	6	<b>0 432 191 278</b>
			Komp.Nr. 505047/06				

**VALMET**

<b>612</b>							
DSJ	7,4	165	612 DSJ <TD 170>	06.90-12.99		6	<b>0 432 292 866</b>
					TW	6	<b>0 432 292 867</b>



## ALFA ROMEO

ALFA ROMEO											
<b>Brera</b>											
2.0 JTDM [939]	2,0	120/125	844 A2.000; 939 B3.000 <M120>	02.09-12.10	4	DBJ	0 445 110 299	0 986 435 230	F 00V C17 504		
2.4 JTDM 20V [939]	2,4	147	939 A3.000 <M95>	04.06-12.10	5	DBJ	0 445 110 213	0 986 435 162			
		154	939 A9.000	05.07-12.10	5	DBJ	0 445 110 308	0 986 435 197			
<b>Giulia</b>											
2.2 Multijet [952]	2,1	100	55266388	02.16→	4	DBJ	0 445 110 673		F 00V C17 504		
		110/132	5526...	02.16→	4	DBJ	0 445 110 673		F 00V C17 504		
Multijet Q4 [952]	2,1	132/154	55268818	02.16→	4	DBJ	0 445 110 673		F 00V C17 504		
<b>Giulietta</b>											
1.6 JTDM [940]	1,6	77	940 A3.000	05.10-12.15	4	DBJ	0 445 110 524	0 986 435 280	F 00V C17 504		
		85/88	940 C1.000; 940 C5.000	01.14-12.15	4	DBJ	0 445 110 524	0 986 435 280	F 00V C17 504		
2.0 JTDM [940]	2,0	100	940 C4.000	04.15→	4	DBJ,TW	0 445 110 524	0 986 435 280	F 00V C17 504		
				04.15→	4	DBJ,TW	0 445 110 680		F 00V C17 504		
				04.15-03.16	4	DBJ	0 445 110 299	0 986 435 230	F 00V C17 504		
				04.15→	4	DBJ	0 445 110 299	0 986 435 230	F 00V C17 504		
		100/120	940...; 940 A7.000	04.10-12.15	4	DBJ,EU5	0 445 110 299	0 986 435 230	F 00V C17 504		
					4	DBJ,EU6	0 445 110 419	0 986 435 213	F 00V C17 504		
		103	940 A5.000	05.10-12.14	4	DBJ,EU5	0 445 110 299	0 986 435 230	F 00V C17 504		
					4	DBJ,EU6	0 445 110 419	0 986 435 213	F 00V C17 504		
		110	940 B5.000	08.13-12.15	4	DBJ,EU5	0 445 110 299	0 986 435 230	F 00V C17 504		
					4	DBJ,EU6	0 445 110 419	0 986 435 213	F 00V C17 504		
		120	940 B9.000	940 C3.000	04.15-03.16	4	DBJ,TW	0 445 110 419	0 986 435 213	F 00V C17 504	
					04.15→	4	DBJ,TW	0 445 110 419	0 986 435 213	F 00V C17 504	
						4	DBJ,TW	0 445 110 682	0 986 435 289	F 00V C17 504	
					04.16→	4	DBJ,TW	0 445 110 419	0 986 435 213	F 00V C17 504	
125	940 A4.000	940 B4.000	02.14→	4	DBJ,EU5	0 445 110 299	0 986 435 230	F 00V C17 504			
				4	DBJ,EU6	0 445 110 419	0 986 435 213	F 00V C17 504			
129	940 A4.000	940 B4.000	05.10-12.14	4	DBJ,EU5	0 445 110 299	0 986 435 230	F 00V C17 504			
				4	DBJ,EU6	0 445 110 419	0 986 435 213	F 00V C17 504			
129	940 B4.000	940 B4.000	12.13-03.16	4	DBJ,TW	0 445 110 419	0 986 435 213	F 00V C17 504			
			12.13→	4	DBJ,TW	0 445 110 299	0 986 435 230	F 00V C17 504			
				4	DBJ,TW	0 445 110 419	0 986 435 213	F 00V C17 504			
				4	DBJ,TW	0 445 110 682	0 986 435 289	F 00V C17 504			
			04.16→	4	DBJ,TW	0 445 110 419	0 986 435 213	F 00V C17 504			
<b>GT</b>											
1.9 JTD 16V [937]	1,9	110	937 A5.000 <M15>	10.03-12.10	4	DBB	0 445 110 111	0 986 435 081	F 00V C17 504		
		110/125	937 A5.000 <M92>; 937 A.6000 <M94>	01.04-12.10	4	DBB	0 445 110 243	0 986 435 104	F 00V C17 504		
<b>MiTo</b>											
1.3 JTD [955]	1,2	62	199 B4.000	03.11-12.15	4	DBB,EU6	0 445 110 614	0 986 435 249			
				10.14-12.15	4	DBB,EU5	0 445 110 351	0 986 435 204			
	1,3	66	...	10.08-12.11	4	DBB	0 445 110 183	0 986 435 102			
				10.15→	4	DBB	0 445 110 351	0 986 435 204			
JTDM [955]	1,3	59	199 B8.000	10.08-12.15	4	DBB,EU6	0 445 110 614	0 986 435 249			
				10.14-12.15	4	DBB,EU5	0 445 110 351	0 986 435 204			
				12.13-12.15	4	DBB,EU6	0 445 110 614	0 986 435 249			
				10.14-12.15	4	DBB,EU5	0 445 110 351	0 986 435 204			
SDE [955]	1,3	70	330 A1.000	05.16→	4	DBB,EU5	0 445 110 351	0 986 435 204			
					4	DBB,EU6	0 445 110 614	0 986 435 249			
1.6 JTD [955]	1,6	85	955 A4.000 <M87>	09.08-12.15	4	5PL,DBJ	0 445 110 524	0 986 435 280	F 00V C17 504		
				10.14-12.15	4	DBJ,N5P	0 445 110 300	0 986 435 171	F 00V C17 504		
		88	955 A3.000 <M88>	08.08-12.15	4	5PL,DBJ	0 445 110 524	0 986 435 280	F 00V C17 504		
				10.14-12.15	4	DBJ,N5P	0 445 110 300	0 986 435 171	F 00V C17 504		
<b>Spider</b>											
2.0 JTDM [939]	2,0	120/125	844 A2.000; 939 B3.000 <M120>	04.09-12.10	4	DBJ	0 445 110 299	0 986 435 230	F 00V C17 504		
2.4 JTDM 20V [939]	2,4	147	939 A3.000 <M95>	03.07-12.10	5	DBJ	0 445 110 213	0 986 435 162			
		154	939 A9.000	03.08-12.10	5	DBJ	0 445 110 308	0 986 435 197			
<b>Stelvio</b>											
2.2 Multijet	2,1	110/132	552...	11.16→	4	DBJ	0 445 110 673		F 00V C17 504		





◀ ALFA ROMEO

<b>2.2</b>	Multijet Q4	2,1	154	55271838	11.16→	4	DBJ	<b>0 445 110 673</b>		<b>F 00V C17 504</b>
<b>145</b>										
<b>1.9</b>	JTD [930 MY97]	1,9	76	AR 32302 <M20>	05.98-02.99	4	DBB	<b>0 445 110 002</b>	<b>0 986 435 001</b>	<b>F 00V C17 504</b>
	JTD [930 MY99]	1,9	76	AR 32302 <M20>	02.99-12.00	4	DBB	<b>0 445 110 002</b>	<b>0 986 435 001</b>	<b>F 00V C17 504</b>
<b>146</b>										
<b>1.9</b>	JTD [930 MY97]	1,9	77	AR 32302 <M13>	05.98-02.99	4	DBB	<b>0 445 110 002</b>	<b>0 986 435 001</b>	<b>F 00V C17 504</b>
	JTD [930 MY99]	1,9	77	AR 32302 <W4 M20>	02.99-12.00	4	DBB	<b>0 445 110 002</b>	<b>0 986 435 001</b>	<b>F 00V C17 504</b>
<b>147</b>										
<b>1.9</b>	JTD [937]	1,9	74	182B9000 <M14>	06.03-10.06	4	DBB	<b>0 445 110 119</b>	<b>0 986 435 083</b>	<b>F 00V C17 504</b>
			81-85	937 A.2000 <M15>	11.00-03.05	4	DBB	<b>0 445 110 119</b>	<b>0 986 435 083</b>	<b>F 00V C17 504</b>
	JTDM [937]	1,9	85	939 A7.000 <M87>	01.06-12.10	4	DBJ	<b>0 445 110 276</b>	<b>0 986 435 148</b>	
			88	937 A.3000 <M88>	04.05-12.10	4	DBJ	<b>0 445 110 276</b>	<b>0 986 435 148</b>	
	JTDM 16V [937]	1,9	93/103	192A5000 <M17>; 937 A.4000 <M16>	10.02-09.06	4	DBB	<b>0 445 110 111</b>	<b>0 986 435 081</b>	<b>F 00V C17 504</b>
			100	192 B1.000 <M91>	01.06-12.10	4	DBB	<b>0 445 110 243</b>	<b>0 986 435 104</b>	<b>F 00V C17 504</b>
			100/110	192 B1.000 <M18>; 937 A5.000 <M19>	02.04-02.06	4	DBB	<b>0 445 110 111</b>	<b>0 986 435 081</b>	<b>F 00V C17 504</b>
			110	937 A5.000 <M92>	03.06-12.10	4	DBB	<b>0 445 110 243</b>	<b>0 986 435 104</b>	<b>F 00V C17 504</b>
			125	937 A.6000 <M94>	10.07-12.10	4	DBJ	<b>0 445 110 341</b>		
<b>156 Berlina</b>										
<b>1.9</b>	JTD [932]	1,9	74	182 B9.000 <M24>	06.03-12.04	4	DBB	<b>0 445 110 119</b>	<b>0 986 435 083</b>	<b>F 00V C17 504</b>
			76	AR32302 <M1>	09.97-09.00	4	DBB	<b>0 445 110 002</b>	<b>0 986 435 001</b>	<b>F 00V C17 504</b>
			81-85	AR37101 / 937A2.000 <M3/M5>	09.00-12.01	4				<b>F 00V C17 504</b>
				Mot.-Nr. 2760402→	09.00-12.01	4	DBB	<b>0 445 110 119</b>	<b>0 986 435 083</b>	
			85	937 A2.000 <M25>	01.02-10.05	4	DBB	<b>0 445 110 119</b>	<b>0 986 435 083</b>	<b>F 00V C17 504</b>
	JTD 16V [932]	1,9	93	937 A4.000 <M26>	06.03-10.05	4	DBB	<b>0 445 110 111</b>	<b>0 986 435 081</b>	<b>F 00V C17 504</b>
			100	192 B1.000 <M29>	10.04-10.05	4	DBB	<b>0 445 110 111</b>	<b>0 986 435 081</b>	<b>F 00V C17 504</b>
			103	192 A5.000 <M27>	10.02-10.05	4	DBB	<b>0 445 110 111</b>	<b>0 986 435 081</b>	<b>F 00V C17 504</b>
			110	937 A5.000 <M82>	07.04-12.05	4	DBB	<b>0 445 110 243</b>	<b>0 986 435 104</b>	<b>F 00V C17 504</b>
<b>2.4</b>	JTD [932]	2,4	100	AR32501 <M2>	09.97-09.00	5	DBB	<b>0 445 110 002</b>	<b>0 986 435 001</b>	<b>F 00V C17 504</b>
				839 A6.000 <M4>	09.00-12.01	5				<b>F 00V C17 504</b>
				Mot.-Nr. 2760402→	09.00-12.01	5	DBB	<b>0 445 110 119</b>	<b>0 986 435 083</b>	
			110	841 C.000 <M30>	01.02-10.05	5	DBB	<b>0 445 110 119</b>	<b>0 986 435 083</b>	<b>F 00V C17 504</b>
	JTD, JTD 20V [932]	2,4	120/129	841 G.000 <M31>; 841 M.000 <M33>	06.03-10.05	5	DBB	<b>0 445 110 111</b>	<b>0 986 435 081</b>	<b>F 00V C17 504</b>
<b>156 Sportwagon</b>										
<b>1.9</b>	JTD [932]	1,9	74	182 B9.000 <M24>	06.03-12.04	4	DBB	<b>0 445 110 119</b>	<b>0 986 435 083</b>	<b>F 00V C17 504</b>
			76	AR32302 CF2 <M1>	05.00-09.00	4	DBB	<b>0 445 110 002</b>	<b>0 986 435 001</b>	<b>F 00V C17 504</b>
			80-85	AR37101 / 937A2.000 <M3/M5 CF3>	09.00-12.01	4				<b>F 00V C17 504</b>
				Mot.-Nr. →2760401	09.00-12.01	4	DBB	<b>0 445 110 068</b>	<b>0 986 435 083</b>	
				Mot.-Nr. 2760401→	10.01-12.01	4	DBB	<b>0 445 110 119</b>	<b>0 986 435 083</b>	
			85	937 A2.000 <M25>	01.02-12.05	4	DBB	<b>0 445 110 119</b>	<b>0 986 435 083</b>	<b>F 00V C17 504</b>
			93	937 A4.000 <M26/M90>	06.03-10.05	4	DBB	<b>0 445 110 111</b>	<b>0 986 435 081</b>	<b>F 00V C17 504</b>
				937 A4.000 <M90>	10.03-12.05	4	DBB	<b>0 445 110 243</b>	<b>0 986 435 104</b>	<b>F 00V C17 504</b>
			100	192 B1.000 <M29>	10.04-10.05	4	DBB	<b>0 445 110 111</b>	<b>0 986 435 081</b>	<b>F 00V C17 504</b>
			103	192 A5.000 <M27>	10.02-12.05	4	DBB	<b>0 445 110 111</b>	<b>0 986 435 081</b>	<b>F 00V C17 504</b>
			110	937 A5.000 <M82>	10.03-12.05	4	DBB	<b>0 445 110 243</b>	<b>0 986 435 104</b>	<b>F 00V C17 504</b>
	JTD Q4 [932]	1,9	110	937 A5.000 <M28/M92>	07.04-12.05	4	DBB,EU3	<b>0 445 110 111</b>	<b>0 986 435 081</b>	<b>F 00V C17 504</b>
					06.05-12.05	4	DBB,EU4	<b>0 445 110 243</b>	<b>0 986 435 104</b>	<b>F 00V C17 504</b>
<b>2.4</b>	JTD [932]	2,4	100	AR32501 CF2 <M2>	05.00-09.00	5	DBB	<b>0 445 110 002</b>	<b>0 986 435 001</b>	<b>F 00V C17 504</b>
				839 A6.000 <M4, CF3>	09.00-12.01	5				<b>F 00V C17 504</b>
				Mot.-Nr. →2760401	09.00-12.01	5	DBB	<b>0 445 110 068</b>	<b>0 986 435 083</b>	
				Mot.-Nr. 2760401→	10.01-12.01	5	DBB	<b>0 445 110 119</b>	<b>0 986 435 083</b>	
			110	841 C.000 <M30>	01.02-10.05	5	DBB	<b>0 445 110 119</b>	<b>0 986 435 083</b>	<b>F 00V C17 504</b>
			120/129	841 G.000 <M31>; 841 M.000 <M33>	06.03-12.05	5	DBB	<b>0 445 110 111</b>	<b>0 986 435 081</b>	<b>F 00V C17 504</b>
<b>159 Berlina</b>										
<b>1.9</b>	JTDM 8V [939]	1,9	85	939 A7.000 <M87>	01.06-12.08	4	DBB	<b>0 445 110 244</b>	<b>0 986 435 161</b>	<b>F 00V C17 504</b>
			88	939 A1.000 <M88>	06.05-12.08	4	DBB	<b>0 445 110 244</b>	<b>0 986 435 161</b>	<b>F 00V C17 504</b>
	JTDM 16V [939]	1,9	100	937 A8.000 <M91>	01.06-12.08	4	DBB	<b>0 445 110 243</b>	<b>0 986 435 104</b>	<b>F 00V C17 504</b>
			110	939 A2.000 <M92>	06.05-12.08	4	DBB	<b>0 445 110 243</b>	<b>0 986 435 104</b>	<b>F 00V C17 504</b>





2.0 JTDM [939]	2,0	100/120/125	844 A2.000; 939 B3.000 <M120>; 939 B4.000	05.09-12.11	4	DBJ	0 445 110 299	0 986 435 230	F 00V C17 504
2.4 JTD, JTD Q4 [939]	2,4	154	939 A9.000	09.06-12.08	5	DBJ	0 445 110 308	0 986 435 197	
JTDM [939]	2,4	147	939 A3.000 <M95>	06.05-12.08	5	DBJ	0 445 110 213	0 986 435 162	
<b>159 Sportwagon</b>									
1.9 JTDM [939]	1,9	85	939 A7.000 <M87>	03.06-12.08	4	DBB	0 445 110 244	0 986 435 161	F 00V C17 504
		88	939 A1.000 <M88>	03.06-12.08	4	DBB	0 445 110 244	0 986 435 161	F 00V C17 504
		100	937 A8.000 <M91>	03.06-12.08	4	DBB	0 445 110 243	0 986 435 104	F 00V C17 504
		110	939 A2.000 <M92>	03.06-12.08	4	DBB	0 445 110 243	0 986 435 104	F 00V C17 504
2.0 JTDM [939]	2,0	100/120/125	844 A2.000; 939 B3.000 <M120>; 939 B4.000	05.09-12.11	4	DBJ	0 445 110 299	0 986 435 230	F 00V C17 504
2.4 JTD, JTD Q4 [939]	2,4	154	939 A9.000	09.06-12.08	5	DBJ	0 445 110 308	0 986 435 197	
JTDM [939]	2,4	147	939 A3.000 <M95>	03.06-12.08	5	DBJ	0 445 110 213	0 986 435 162	
<b>166</b>									
2.4 JTD [936]	2,4	100	AR 34202 <M20>	09.98-09.00	5	DBB	0 445 110 002	0 986 435 001	F 00V C17 504
		100-110	839 A6.000/841 C.000 <M21/M22>	09.00-10.07	5				F 00V C17 504
			Mot.-Nr. →2760400	09.00-09.01	5	DBB	0 445 110 068	0 986 435 083	
			Mot.-Nr. 2760401→	10.01-10.07	5	DBB	0 445 110 119	0 986 435 083	
JTD 20V [936]	2,4	120	841 M.000 <M27>	10.04-10.07	5	DBB	0 445 110 111	0 986 435 081	
		128	841 N.000 <M28>	10.04-10.07	5	DBB	0 445 110 111	0 986 435 081	F 00V C17 504
		129	841 G.000/841 H.000 <M25/M26>	06.03-10.07	5	DBB	0 445 110 111	0 986 435 081	F 00V C17 504
JTDM 20V [936]	2,4	132-136	936 B.000 <M99>	10.05-10.07	5	DBJ	0 445 110 213	0 986 435 162	

AUDI



**A1**

1.6 TDI [8X]	1,6	85	CXMA <DK8>	11.14→	4	DBJ	0 445 110 472	0 986 435 259	F 00V P01 004
2.0 TDI [8X]	2,0	100	CFHB <D94>	09.11-04.15	4	DBJ	0 445 110 646	0 986 435 166	F 00V P01 004
		105	CFHD <D92>	09.11-04.15	4	DBJ	0 445 110 646	0 986 435 166	F 00V P01 004
								0 986 435 167	

**A1 Sportback**

1.6 TDI [8X]	1,6	85	CXMA <DK8>	11.14→	4	DBJ	0 445 110 472	0 986 435 259	F 00V P01 004
2.0 TDI [8X]	2,0	100/105	CFHB <D94>; CFHD <D92>	09.11-04.15	4	DBJ	0 445 110 646	0 986 435 166	F 00V P01 004
								0 986 435 167	

**A3**

1.6 TDI [8V1]	1,6	81	CRKB <DK5>	09.13-05.15	4	DBJ	0 445 110 472	0 986 435 259	F 00V P01 004
			CXXB <DK5>	05.15-03.17	4	DBJ,ULT	0 445 110 472	0 986 435 259	F 00V P01 004
			DBKA <DK5>	05.15-03.17	4	DBJ,ULT	0 445 110 472	0 986 435 259	F 00V P01 004
		85	DDYA <DK8>	03.17-07.18	4	DBJ,ULT	0 445 110 472	0 986 435 259	F 00V P01 004
				03.17→	4	DBJ,ULT	0 445 110 472	0 986 435 259	F 00V P01 004
			DGTE <DK8>	07.18→	4				F 00V P01 004
2.0 TDI [8P1]	2,0	100	CBAA <D94>	07.08-05.10	4	DBJ	0 445 116 029	0 986 435 360	F 00V P01 004
TDI [8V1]	1,6	77	CLHA <D38>	09.12-05.15	4	DBJ	0 445 110 476	0 986 435 241	F 00V P01 004
	2,0	81	CRFA <DN1>	01.13→	4	DBJ	0 445 110 474	0 986 435 242	F 00V P01 004
		100	CRBD <DE9>	05.13-05.14	4	DBJ	0 445 110 474	0 986 435 242	F 00V P01 004
			CRLC <DE9>	05.13-08.16	4	DBJ	0 445 110 468	0 986 435 258	F 00V P01 004
		105	CRFC <DN6>	01.13→	4	DBJ	0 445 110 474	0 986 435 242	F 00V P01 004
		110	CRUA <DN4>	05.14-05.15	4	DBJ	0 445 110 468	0 986 435 258	F 00V P01 004
			DCYA <DN4>	05.17→	4	DBJ	0 445 110 468	0 986 435 258	F 00V P01 004
			DFGA <DN4>	07.18→	4	DBJ	0 445 110 468	0 986 435 258	F 00V P01 004
TDI, TDI quattro [8P1]	2,0	100/103/125	CFFA <D94>; CFFB <D91>; CFGB <D93>; CLJA <D91>	11.09-03.13	4	DBJ	0 445 110 646	0 986 435 166	0 986 435 167
		103	CBAB <D91>	07.08-05.10	4	DBJ	0 445 116 029	0 986 435 360	F 00V P01 004
		125	CBBB <D93>	07.08-05.10	4	DBJ	0 445 116 029	0 986 435 360	F 00V P01 004
TDI, TDI quattro [8V1]	2,0	110	CRBC <DN4>	04.12-05.15	4	DBJ	0 445 110 474	0 986 435 242	F 00V P01 004
			CRLB <DN4>	10.12-08.16	4	DBJ	0 445 110 468	0 986 435 258	F 00V P01 004
			DBG A <DN4>	05.15-08.16	4	DBJ	0 445 110 638		F 00V P01 004
			DEJA <DN4>	05.15→	4	DBJ	0 445 110 468	0 986 435 258	F 00V P01 004
		135	CUNA <DK7>	05.13-05.17	4	DBJ	0 445 110 470	0 986 435 257	F 00V P01 004





◀ AUDI

2.0 TDI, TDI quattro [8V1]	2,0	135	DGCA <DK7>	05.17→	4	DBJ	0 445 110 470	0 986 435 257	F 00V P01 004		
			DJGA <DK7>	07.18→	4	DBJ	0 445 110 468	0 986 435 258	F 00V P01 004		
<b>A3 Cabriolet</b>											
1.6 TDI [8V7]	1,6	81	CRKB <DK5>; CXXB <DK5>	02.14-04.16	4	DBJ	0 445 110 472	0 986 435 259	F 00V P01 004		
2.0 TDI [8P7]	2,0	100	CBAA <D94>	04.08-05.10	4	DBJ	0 445 116 029	0 986 435 360	F 00V P01 004		
		100/103	CFFA <D94>; CFFB <D91>	11.09-05.13	4	DBJ	0 445 110 646	0 986 435 166			
								0 986 435 167			
		103	CBAB <D91>	04.08-05.10	4	DBJ	0 445 116 029	0 986 435 360	F 00V P01 004		
TDI [8V7]	2,0	100	CRLC <DE9>	10.13-07.16	4	DBJ	0 445 110 468	0 986 435 258	F 00V P01 004		
TDI, TDI quattro [8V7]	2,0	110	CRLB <DN4>	10.13-05.17	4	DBJ	0 445 110 468	0 986 435 258	F 00V P01 004		
			DCYA <DN4>	05.17→	4	DBJ	0 445 110 468	0 986 435 258	F 00V P01 004		
		135	CUNA <DK7>	03.14-05.17	4	DBJ	0 445 110 470	0 986 435 257	F 00V P01 004		
			DGCA <DK7>	05.17→	4	DBJ	0 445 110 470	0 986 435 257	F 00V P01 004		
<b>A3 Limousine</b>											
1.6 TDI [8VS]	1,6	77	CLHA <D38>	09.13-05.15	4	DBJ	0 445 110 476	0 986 435 241	F 00V P01 004		
		81	CRKB <DK5>	05.14-05.15	4	DBJ	0 445 110 472	0 986 435 259	F 00V P01 004		
			DBKA <DK5>	05.15-03.17	4	DBJ,ULT	0 445 110 472	0 986 435 259	F 00V P01 004		
		85	DDYA <DK8>	03.17-07.18	4	DBJ,ULT	0 445 110 472	0 986 435 259	F 00V P01 004		
				03.17→	4	DBJ,ULT	0 445 110 472	0 986 435 259	F 00V P01 004		
			DGTE <DK8>	07.18→	4				F 00V P01 004		
TDI, TDI quattro [8VS]	1,6	81	CXXB <DK5>	05.15-03.17	4	DBJ,ULT	0 445 110 472	0 986 435 259	F 00V P01 004		
2.0 TDI [8VS]	2,0	100	CRBD <DE9>	05.13-05.14	4	DBJ	0 445 110 474	0 986 435 242	F 00V P01 004		
			CRLC <DE9>	05.13-08.16	4	DBJ	0 445 110 468	0 986 435 258	F 00V P01 004		
		105	CRFC <DN6>	10.13→	4	DBJ	0 445 110 474	0 986 435 242	F 00V P01 004		
		110	CRUA <DN4>	05.14-05.15	4				F 00V P01 004		
			DCYA <DN4>	05.17→	4	DBJ	0 445 110 468	0 986 435 258	F 00V P01 004		
			DFGA <DN4>	07.18→	4	DBJ	0 445 110 468	0 986 435 258	F 00V P01 004		
		TDI, TDI quattro [8VS]	2,0	81/110	CRBC <DN4>; CRFA <DN1>	05.13→	4	DBJ	0 445 110 474	0 986 435 242	F 00V P01 004
				110	CRLB <DN4>	05.13-08.16	4	DBJ	0 445 110 468	0 986 435 258	F 00V P01 004
					DBGA <DN4>	05.15-08.16	4	DBJ	0 445 110 638		F 00V P01 004
					DEJA <DN4>	05.15→	4	DBJ	0 445 110 468	0 986 435 258	F 00V P01 004
	135	CUNA <DK7>	05.14-05.17	4	DBJ	0 445 110 470	0 986 435 257	F 00V P01 004			
			DGCA <DK7>	05.17→	4	DBJ	0 445 110 470	0 986 435 257	F 00V P01 004		
			DJGA <DK7>	07.18→	4	DBJ	0 445 110 468	0 986 435 258	F 00V P01 004		
<b>A3 Sportback</b>											
1.6 TDI [8VA]	1,6	77	CLHA <D38>	01.13-05.15	4	DBJ	0 445 110 476	0 986 435 241	F 00V P01 004		
		81	CRKB <DK5>	09.13-05.15	4	DBJ	0 445 110 472	0 986 435 259	F 00V P01 004		
			DBKA <DK5>	05.15-03.17	4	DBJ,ULT	0 445 110 472	0 986 435 259	F 00V P01 004		
		85	DDYA <DK8>	03.17-07.18	4	DBJ,ULT	0 445 110 472	0 986 435 259	F 00V P01 004		
				03.17→	4	DBJ,ULT	0 445 110 472	0 986 435 259	F 00V P01 004		
			DGTE <DK8>	07.18→	4				F 00V P01 004		
TDI, TDI quattro [8VA]	1,6	81	CXXB <DK5>	05.15-03.17	4	DBJ,ULT	0 445 110 472	0 986 435 259	F 00V P01 004		
2.0 TDI [8PA]	2,0	100	CBAA <D94>	07.08-05.10	4	DBJ	0 445 116 029	0 986 435 360	F 00V P01 004		
		103	CBAB <D91>	07.08-05.10	4	DBJ	0 445 116 029	0 986 435 360	F 00V P01 004		
TDI [8VA]	2,0	81	CRFA <DN1>	03.13→	4	DBJ	0 445 110 474	0 986 435 242	F 00V P01 004		
		100	CRBD <DE9>	05.13-05.14	4	DBJ	0 445 110 474	0 986 435 242	F 00V P01 004		
			CRLC <DE9>	05.13-08.16	4	DBJ	0 445 110 468	0 986 435 258	F 00V P01 004		
		105	CRFC <DN6>	03.13→	4	DBJ	0 445 110 474	0 986 435 242	F 00V P01 004		
		110	CRUA <DN4>	05.14-05.15	4	DBJ	0 445 110 468	0 986 435 258	F 00V P01 004		
			DCYA <DN4>	05.17→	4	DBJ	0 445 110 468	0 986 435 258	F 00V P01 004		
			DFGA <DN4>	07.18→	4	DBJ	0 445 110 468	0 986 435 258	F 00V P01 004		
TDI quattro [8PA]	2,0	103	CBAB <D91>	07.08-05.10	4	DBJ	0 445 116 029	0 986 435 360			
TDI, TDI quattro [8PA]	2,0	100/103/125	CFFA <D94>; CFFB <D91>; CFGB <D93>; CLJA <D91>	11.09-03.13	4	DBJ	0 445 110 646	0 986 435 166			
		125	CBBB <D93>	07.08-05.10	4	DBJ	0 445 116 029	0 986 435 360			
TDI, TDI quattro [8VA]	2,0	110	CRBC <DN4>	09.12-05.15	4	DBJ	0 445 110 474	0 986 435 242	F 00V P01 004		
			CRLB <DN4>	10.12-08.16	4	DBJ	0 445 110 468	0 986 435 258	F 00V P01 004		
			DBGA <DN4>	05.15-08.16	4	DBJ	0 445 110 638		F 00V P01 004		
			DEJA <DN4>	05.15→	4	DBJ	0 445 110 468	0 986 435 258	F 00V P01 004		
		135	CUNA <DK7>	05.13-05.17	4	DBJ	0 445 110 470	0 986 435 257	F 00V P01 004		
			DGCA <DK7>	05.17→	4	DBJ	0 445 110 470	0 986 435 257	F 00V P01 004		







2.0 TDI, TDI quattro [8VA]	2,0	135	DJGA <DK7>	07.18→	4	DBJ	0 445 110 468	0 986 435 258	F 00V P01 004										
<b>A4</b>																			
2.0 TDI [8K2; B8]	2,0	88	CAGC <D90>	06.08-03.12	4	DBJ	0 445 116 029	0 986 435 360	F 00V P01 004										
			CAGB <D94>	11.07-03.12	4	DBJ	0 445 116 029	0 986 435 360	F 00V P01 004										
			CJCB <D94>	11.10-12.15	4	DBJ	0 445 110 646	0 986 435 166	F 00V P01 004										
	105	CSUB <D94>	04.14-12.15	4	DBJ	0 445 110 468	0 986 435 258	F 00V P01 004											
			CMEA <D92>	05.10-03.12	4	DBJ	0 445 116 029	0 986 435 360	F 00V P01 004										
		CMFA <D92>	11.11-07.13	4	DBJ	0 445 110 646	0 986 435 166	F 00V P01 004											
		110	CMFB <DN4>	05.13-12.15	4	DBJ	0 445 110 646	0 986 435 166	F 00V P01 004										
				01.08-03.12	4	DBJ	0 445 116 029	0 986 435 360	F 00V P01 004										
			CAHB <D95>	09.13-12.15	4	DBJ	0 445 110 470	0 986 435 257	F 00V P01 004										
		TDI [8W2; B9]	2,0	90	DEUC <D45>	05.16→	4	DBJ,X10	0 445 110 553		F 00V P01 004								
4	24Z,DBJ						0 445 110 468	0 986 435 258	F 00V P01 004										
100	DEUB <D94>		05.15→	4	DBJ,X10	0 445 110 553		F 00V P01 004											
				4	24Z,DBJ	0 445 110 468	0 986 435 258	F 00V P01 004											
110	CZHA <DN4>		08.15→	4	X10	0 445 110 702		F 00V P01 004											
				4	24Z,DBJ	0 445 110 704		F 00V P01 004											
TDI quattro [8W2; B9]	2,0	120	DETB <DE5>	09.16→	4	DBJ,X10	0 445 110 555		F 00V P01 004										
					4	24Z,DBJ	0 445 110 470	0 986 435 257	F 00V P01 004										
TDI, TDI quattro [8K2; B8]	2,0	88/120/130	CGLC <DE2>; CGLD <D95>; CJCC <D90>	11.11-12.15	4	DBJ	0 445 110 646	0 986 435 166	F 00V P01 004										
										105	CAGA <D92>	11.07-03.12	4	DBJ	0 445 116 029	0 986 435 360	F 00V P01 004		
	110	CJCA <D92>	11.11-07.13	4	DBJ	0 445 110 646	0 986 435 166	0 986 435 167	F 00V P01 004										
										CJCD <DN4>	05.13-12.15	4	DBJ	0 445 110 646	0 986 435 166	F 00V P01 004			
		CSUA <DN4>	04.14-12.15	4	DBJ	0 445 110 468	0 986 435 258	F 00V P01 004											
			125	CAHA <D93>	01.08-03.12	4	DBJ	0 445 116 029	0 986 435 360	F 00V P01 004									
TDI, TDI quattro [8W2; B9]	2,0	110	DEUA <DN4>	05.15→	4	DBJ,X10	0 445 110 553		F 00V P01 004										
					4	24Z,DBJ	0 445 110 468	0 986 435 258	F 00V P01 004										
					140	DESA <DE5>	05.15→	4	DBJ,X10	0 445 110 644		F 00V P01 004							
					4	24Z,DBJ	0 445 110 641		F 00V P01 004										
					4	DBJ,X10	0 445 110 555		F 00V P01 004										
4	24Z,DBJ	0 445 110 470	0 986 435 257	F 00V P01 004															
2.7 TDI [8EC; B7]	2,7	120	BSG <D1W>	11.05-06.08	6	DBJ	0 445 115 080	0 986 435 353	F 00V P01 004										
								0 986 435 388											
	132	BPP <D1N>	11.05-06.08	6	DBJ	0 445 115 080	0 986 435 353	0 986 435 388	F 00V P01 004										
										TDI [8K2; B8]	2,7	120	CAMB <D1W>	11.07-05.08	6	DBJ	0 445 116 022	0 986 435 357	F 00V P01 004
										140	CGKB <D1W>	06.08-03.12	6	DBJ	0 445 116 022	0 986 435 357	0 986 435 379	F 00V P01 004	
0 986 435 379																			
3.0 TDI [8K2; B8]	3,0	150	CLAB <D1Q>	11.11-12.15	6	DBJ	0 445 117 021	0 986 435 413	F 00V P01 009										
										150/171	ASB <D1D>; BKN	01.05-06.08	6	DBJ	0 445 115 078	0 986 435 358	F 00V P01 004		
	176	155/176	CCWA <D50>; CCWB <D1V>	06.08-03.12	6	DBJ	0 445 116 022	0 986 435 357	0 986 435 379	F 00V P01 004									
											CAPA <D50>	11.07-05.08	6			F 00V P01 004			
												Fg.-Nr. →8K..8A040 000 →8K..8N015 000	11.07-03.08	6	DBJ	0 445 115 085	0 986 435 364	0 986 435 374	
													Fg.-Nr. 8E..8A040 001→ 8K..8N015 001→	04.08-05.08	6	DBJ	0 445 116 022	0 986 435 357	0 986 435 379
											CCLA <D50>	11.09-03.12	6	DBJ	0 445 117 002	0 986 435 380	F 00V P01 004		
											180	CDUC <D43>	11.11-12.15	6	DBJ	0 445 116 039	0 986 435 422	F 00V P01 009	
CKVB <D43>; CKVC <D43>	01.12-12.15	6	DBJ	0 445 117 026	0 986 435 453	F 00V P01 009													





◀ AUDI

3.0 TDI, TDI quattro [8W2; B9]	3,0	160/200	CRTC <DJ3>; CSWB <DD5>	05.15→	6	DBJ	0 445 117 041	0 986 435 441	F 00V P01 009
<b>A4 Allroad</b>									
2.0 TDI [8KH]	2,0	100	CAGB <D94>	09.09-01.12	4	DBJ	0 445 116 029	0 986 435 360	F 00V P01 004
			CSUB <D94>	05.14-04.16	4	DBJ	0 445 110 468	0 986 435 258	F 00V P01 004
		100/105/110/120/130	CGLC <DE2>; CGLD <D95>; CJCA <D92>; CJCB <D94>; CJCD <DN4>	11.11-04.16	4	DBJ	0 445 110 646	0 986 435 166	F 00V P01 004
								0 986 435 167	
		105	CAGA <D92>	09.09-01.12	4	DBJ	0 445 116 029	0 986 435 360	F 00V P01 004
		110	CSUA <DN4>	05.14-04.16	4	DBJ	0 445 110 468	0 986 435 258	F 00V P01 004
		120	CAHB <D95>	04.09-01.12	4	DBJ	0 445 116 029	0 986 435 360	F 00V P01 004
		120/140	CNHA <DE5>; CNHC <D95>	09.13-05.16	4	DBJ	0 445 110 470	0 986 435 257	F 00V P01 004
		125	CAHA <D93>	04.09-01.12	4	DBJ	0 445 116 029	0 986 435 360	F 00V P01 004
TDI [8WH]	2,0	100	DEUB <D94>	11.16→	4	DBJ,X10	0 445 110 553		F 00V P01 004
					4	24Z,DBJ	0 445 110 468	0 986 435 258	F 00V P01 004
		110	CZHA <DN4>	11.16→	4	X10	0 445 110 702		F 00V P01 004
					4	24Z,DBJ	0 445 110 704		F 00V P01 004
			DEUA <DN4>	11.16→	4	DBJ,X10	0 445 110 553		F 00V P01 004
					4	24Z,DBJ	0 445 110 468	0 986 435 258	F 00V P01 004
		120	DETB <DE5>	05.16→	4	DBJ,X10	0 445 110 555		F 00V P01 004
					4	24Z,DBJ	0 445 110 470	0 986 435 257	F 00V P01 004
		140	DESA <DE5>	01.16→	4	DBJ,X10	0 445 110 644		F 00V P01 004
					4	24Z,DBJ	0 445 110 641		F 00V P01 004
			DETA <DE5>	01.16→	4	DBJ,X10	0 445 110 555		F 00V P01 004
					4	24Z,DBJ	0 445 110 470	0 986 435 257	F 00V P01 004
			DFVA <DE5>	01.16→	4	DBJ,X10	0 445 110 555		F 00V P01 004
					4	24Z,DBJ	0 445 110 470	0 986 435 257	F 00V P01 004
3.0 TDI [8KH]	3,0	176	CCWA <D50>	04.09-01.12	6	DBJ	0 445 116 022	0 986 435 357	F 00V P01 004
								0 986 435 379	
		180	CDUC <D43>	01.12-04.16	6	DBJ	0 445 116 039	0 986 435 422	F 00V P01 009
			CKVB <D43>	01.12-05.13	6	DBJ	0 445 117 026	0 986 435 453	F 00V P01 009
			CKVC <D43>	05.13-04.16	6	DBJ	0 445 117 026	0 986 435 453	F 00V P01 009
TDI [8WH]	3,0	160	CSWB <DD5>	01.16→	6	DBJ	0 445 117 041	0 986 435 441	F 00V P01 009
		200	CRTC <DJ3>	01.16→	6	DBJ	0 445 117 041	0 986 435 441	F 00V P01 009
<b>A4 Avant</b>									
2.0 TDI [8K5; B8]	2,0	88	CAGC <D90>	06.08-03.12	4	DBJ	0 445 116 029	0 986 435 360	F 00V P01 004
		100	CAGB <D94>	04.08-03.12	4	DBJ	0 445 116 029	0 986 435 360	F 00V P01 004
			CJCB <D94>	11.10-12.15	4	DBJ	0 445 110 646	0 986 435 166	F 00V P01 004
								0 986 435 167	
		105	CMEA <D92>	05.10-03.12	4	DBJ	0 445 116 029	0 986 435 360	F 00V P01 004
			CMFA <D92>	11.11-07.13	4	DBJ	0 445 110 646	0 986 435 166	F 00V P01 004
								0 986 435 167	
		110	CMFB <DN4>	05.13-12.15	4	DBJ	0 445 110 646	0 986 435 166	F 00V P01 004
								0 986 435 167	
		120	CAHB <D95>	04.08-03.12	4	DBJ	0 445 116 029	0 986 435 360	F 00V P01 004
			CNHC <D95>	09.13-12.15	4	DBJ	0 445 110 470	0 986 435 257	F 00V P01 004
TDI [8W5; B9]	2,0	90	DEUC <D45>	05.16→	4	DBJ,X10	0 445 110 553		F 00V P01 004
					4	24Z,DBJ	0 445 110 468	0 986 435 258	F 00V P01 004
		100	DEUB <D94>	05.15→	4	DBJ,X10	0 445 110 553		F 00V P01 004
					4	24Z,DBJ	0 445 110 468	0 986 435 258	F 00V P01 004
		110	CZHA <DN4>	05.15→	4	X10	0 445 110 702		F 00V P01 004
					4	24Z,DBJ	0 445 110 704		F 00V P01 004
TDI quattro [8W5; B9]	2,0	120	DETB <DE5>	09.16→	4	DBJ,X10	0 445 110 555		F 00V P01 004
					4	24Z,DBJ	0 445 110 470	0 986 435 257	F 00V P01 004
TDI, TDI quattro [8K5; B8]	2,0	88/120/130	CGLC <DE2>; CGLD <D95>; CJCC <D90>	11.11-12.15	4	DBJ	0 445 110 646	0 986 435 166	F 00V P01 004
								0 986 435 167	
		100	CSUB <D94>	04.14-12.15	4	DBJ	0 445 110 468	0 986 435 258	F 00V P01 004
		105	CAGA <D92>	04.08-03.12	4	DBJ	0 445 116 029	0 986 435 360	F 00V P01 004
			CJCA <D92>	11.11-07.13	4	DBJ	0 445 110 646	0 986 435 166	F 00V P01 004
								0 986 435 167	
		110	CJCD <DN4>	05.13-12.15	4	DBJ	0 445 110 646	0 986 435 166	F 00V P01 004
								0 986 435 167	
			CSUA <DN4>	04.14-12.15	4	DBJ	0 445 110 468	0 986 435 258	F 00V P01 004



<b>2.0</b>	TDI, TDI quattro [8K5; B8]	2,0	125	CAHA <D93>	04.08-03.12	4	DBJ	<b>0 445 116 029</b>	<b>0 986 435 360</b>	<b>F 00V P01 004</b>		
			140	CNHA <DE5>	09.13-12.15	4	DBJ	<b>0 445 110 470</b>	<b>0 986 435 257</b>	<b>F 00V P01 004</b>		
	TDI, TDI quattro [8W5; B9]	2,0	110	DEUA <DN4>	05.15→	4	DBJ,X10	<b>0 445 110 553</b>		<b>F 00V P01 004</b>		
						4	24Z,DBJ	<b>0 445 110 468</b>	<b>0 986 435 258</b>	<b>F 00V P01 004</b>		
			140	DESA <DE5>	05.15→	4	DBJ,X10	<b>0 445 110 644</b>		<b>F 00V P01 004</b>		
					4	24Z,DBJ	<b>0 445 110 641</b>		<b>F 00V P01 004</b>			
			DETA <DE5>	05.15→	4	DBJ,X10	<b>0 445 110 555</b>		<b>F 00V P01 004</b>			
					4	24Z,DBJ	<b>0 445 110 470</b>	<b>0 986 435 257</b>	<b>F 00V P01 004</b>			
<b>2.7</b>	TDI [8ED; B7]	2,7	132	BPP <D1N>	11.05-06.08	6	DBJ	<b>0 445 115 080</b>	<b>0 986 435 353</b>	<b>F 00V P01 004</b>		
												<b>0 986 435 388</b>
	TDI [8ED; B7]	2,7	120	BSG <D1W>	11.05-06.08	6	DBJ	<b>0 445 115 080</b>	<b>0 986 435 353</b>	<b>F 00V P01 004</b>		
												<b>0 986 435 388</b>
	TDI [8K5; B8]	2,7	120	CAMB <D1W>	04.08-05.08	6	DBJ	<b>0 445 116 022</b>	<b>0 986 435 357</b>	<b>F 00V P01 004</b>		
								<b>0 986 435 379</b>				
		140	CGKB <D1W>	06.08-03.12	6	DBJ	<b>0 445 116 022</b>	<b>0 986 435 357</b>	<b>F 00V P01 004</b>			
						<b>0 986 435 379</b>						
			CAMA <D4V>	04.08-05.08	6	DBJ	<b>0 445 116 022</b>	<b>0 986 435 357</b>	<b>F 00V P01 004</b>			
			CGKA <D4V>	06.08-03.12	6	DBJ	<b>0 445 116 022</b>	<b>0 986 435 357</b>	<b>F 00V P01 004</b>			
							<b>0 986 435 379</b>					
<b>3.0</b>	TDI [8K5; B8]	3,0	150	CLAB <D1Q>	11.11-12.15	6	DBJ	<b>0 445 117 021</b>	<b>0 986 435 413</b>			
	TDI quattro [8ED; B7]	3,0	150/171	ASB <D1D>; BKN	01.05-06.08	6	DBJ	<b>0 445 115 078</b>	<b>0 986 435 358</b>			
	TDI quattro [8K5; B8]	3,0	155/176	CAPA <D50>; CCWA <D50>; CCWB <D1V>	04.08-03.12	6	DBJ	<b>0 445 116 022</b>	<b>0 986 435 357</b>	<b>F 00V P01 004</b>		
								<b>0 986 435 379</b>				
			176	CCLA <D50>	11.09-03.12	6	DBJ	<b>0 445 117 002</b>	<b>0 986 435 380</b>	<b>F 00V P01 004</b>		
	180	CDUC <D43>	11.11-12.15	6	DBJ	<b>0 445 116 039</b>	<b>0 986 435 422</b>	<b>F 00V P01 009</b>				
			CKVB <D43>; CKVC <D43>	01.12-12.15	6	DBJ	<b>0 445 117 026</b>	<b>0 986 435 453</b>	<b>F 00V P01 009</b>			
TDI, TDI quattro [8W5; B9]	3,0	160/200	CRTC <DJ3>; CSWB <DD5>	05.15→	6	DBJ	<b>0 445 117 041</b>	<b>0 986 435 441</b>	<b>F 00V P01 009</b>			
<b>A4 Cabriolet</b>												
<b>2.7</b>	TDI [8HE; B7]	2,7	132	BPP <D1N>	11.05-03.09	6	DBJ	<b>0 445 115 080</b>	<b>0 986 435 353</b>	<b>F 00V P01 004</b>		
												<b>0 986 435 388</b>
<b>3.0</b>	TDI quattro [8HE; B7]	3,0	150/171	ASB <D1D>; BKN	01.06-03.09	6	DBJ	<b>0 445 115 078</b>	<b>0 986 435 358</b>			
<b>A4 Sportback</b>												
<b>2.0</b>	TDI quattro [8TA]	2,0	130	CGLC <DE2>	01.12-01.17	4	DBJ	<b>0 445 110 646</b>	<b>0 986 435 166</b>	<b>F 00V P01 004</b>		
									<b>0 986 435 167</b>			
<b>A5 Cabriolet</b>												
<b>2.0</b>	TDI [F57]	2,0	140	DETA <DE5>	03.17→	4	DBJ,X10	<b>0 445 110 555</b>		<b>F 00V P01 004</b>		
							24Z,DBJ	<b>0 445 110 470</b>	<b>0 986 435 257</b>	<b>F 00V P01 004</b>		
	TDI [8F7]	2,0	110	CSUA <DN4>	05.14-01.17	4	DBJ	<b>0 445 110 468</b>	<b>0 986 435 258</b>	<b>F 00V P01 004</b>		
					120	CAHB <D95>	05.09-03.12	4	DBJ	<b>0 445 116 029</b>	<b>0 986 435 360</b>	<b>F 00V P01 004</b>
					125	CAHA <D93>	05.09-03.12	4	DBJ	<b>0 445 116 029</b>	<b>0 986 435 360</b>	<b>F 00V P01 004</b>
	TDI quattro [A57]	2,0	140	DETA <DE5>	03.17→	4	DBJ,X10	<b>0 445 110 555</b>		<b>F 00V P01 004</b>		
					4	24Z,DBJ	<b>0 445 110 470</b>	<b>0 986 435 257</b>	<b>F 00V P01 004</b>			
TDI, TDI quattro [F57]	2,0	140	DESA <DE5>	03.17→	4	DBJ,X10	<b>0 445 110 644</b>		<b>F 00V P01 004</b>			
					4	24Z,DBJ	<b>0 445 110 641</b>		<b>F 00V P01 004</b>			
TDI, TDI quattro [8F7]	2,0	105/110/120/130	CGLC <DE2>; CGLD <D95>; CJCA <D92>; CJCD <DN4>	10.11-01.17	4	DBJ	<b>0 445 110 646</b>	<b>0 986 435 166</b>	<b>F 00V P01 004</b>			
							<b>0 986 435 167</b>					
			140	CNHA <DE5>	09.13-01.17	4	DBJ	<b>0 445 110 470</b>	<b>0 986 435 257</b>	<b>F 00V P01 004</b>		
<b>2.7</b>	TDI [8F7]	2,7	120/140	CGKA <D4V>; CGKB <D1W>	03.09-03.12	6	DBJ	<b>0 445 116 022</b>	<b>0 986 435 357</b>	<b>F 00V P01 004</b>		
												<b>0 986 435 379</b>
<b>3.0</b>	TDI [8F7]	3,0	150	CLAB <D1Q>	09.11-01.17	6	DBJ	<b>0 445 117 021</b>	<b>0 986 435 413</b>	<b>F 00V P01 009</b>		
	TDI quattro [F57]	3,0	210	DCPC <DV8>	11.16→	6	DBJ	<b>0 445 117 071</b>		<b>F 00V P01 009</b>		
	TDI quattro [8F7]	3,0	160/180	CKVC <D43>; CKVD <DD5>	06.13-01.17	6	DBJ	<b>0 445 117 021</b>	<b>0 986 435 413</b>	<b>F 00V P01 009</b>		
					176	CCWA <D50>	03.09-03.12	6	DBJ	<b>0 445 116 022</b>	<b>0 986 435 357</b>	<b>F 00V P01 004</b>
								<b>0 986 435 379</b>				
			180	CDUC <D43>	10.11-01.17	6	DBJ	<b>0 445 116 039</b>	<b>0 986 435 422</b>	<b>F 00V P01 009</b>		
TDI, TDI quattro [F57]	3,0	160	CSWB <DD5>	12.16→	6	DBJ	<b>0 445 117 041</b>	<b>0 986 435 441</b>	<b>F 00V P01 009</b>			
<b>A5 Coupé</b>												
<b>2.0</b>	TDI [F53]	2,0	100	DEUB <D94>	05.17→	4	DBJ,X10	<b>0 445 110 553</b>		<b>F 00V P01 004</b>		
							24Z,DBJ	<b>0 445 110 468</b>	<b>0 986 435 258</b>	<b>F 00V P01 004</b>		





◀ AUDI

2.0 TDI [F53]	2,0	110	CZHA <DN4>	05.17→	4	X10	0 445 110 702		F 00V P01 004
					4	24Z,DBJ	0 445 110 704		F 00V P01 004
			DEUA <DN4>	05.17→	4	DBJ,X10	0 445 110 553		F 00V P01 004
					4	24Z,DBJ	0 445 110 468	0 986 435 258	F 00V P01 004
TDI [8T3]	2,0	120	CAHB <D95>	01.08-03.12	4	DBJ	0 445 116 029	0 986 435 360	F 00V P01 004
			CNHC <D95>	09.13-01.17	4	DBJ	0 445 110 470	0 986 435 257	F 00V P01 004
TDI, TDI quattro [F53]	2,0	140	DESA <DE5>	06.16→	4	DBJ,X10	0 445 110 644		F 00V P01 004
					4	24Z,DBJ	0 445 110 641		F 00V P01 004
			DETA <DE5>; DFVA <DE5>	09.16→	4	DBJ,X10	0 445 110 555		F 00V P01 004
					4	24Z,DBJ	0 445 110 470	0 986 435 257	F 00V P01 004
TDI, TDI quattro [8T3]	2,0	120/130	CGLC <DE2>; CGLD <D95>	08.11-01.17	4	DBJ	0 445 110 646	0 986 435 166	F 00V P01 004
								0 986 435 167	
		125	CAHA <D93>	01.08-03.12	4	DBJ	0 445 116 029	0 986 435 360	F 00V P01 004
		140	CNHA <DE5>	09.13-01.17	4	DBJ	0 445 110 470	0 986 435 257	F 00V P01 004
2.7 TDI [8T3]	2,7	120/140	CAMA <D4V>; CAMB <D1W>; CGKA <D4V>; CGKB <D1W>	07.07-03.12	6	DBJ	0 445 116 022	0 986 435 357	F 00V P01 004
							0 986 435 379		
3.0 TDI quattro [F53]	3,0	200	CRTC <DJ3>	02.17→	6	DBJ	0 445 117 041	0 986 435 441	F 00V P01 009
			DCPC <DV8>	10.16→	6	DBJ	0 445 117 071		F 00V P01 009
TDI quattro [8T3]	3,0	155	CCWB <D1V>	03.08-05.10	6	DBJ	0 445 116 022	0 986 435 357	F 00V P01 004
								0 986 435 379	
			PR-Code 7MB	03.08-05.10	6	DBJ	0 445 115 085	0 986 435 364	
							0 986 435 374		
		160	CKVD <DD5>	05.15-01.17	6	DBJ	0 445 117 026	0 986 435 453	F 00V P01 009
		176	CAPA <D50>	06.07-03.12	6	DBJ	0 445 115 085	0 986 435 364	F 00V P01 004
							0 986 435 374		
			CCWA <D50>	03.08-03.12	6	DBJ	0 445 116 022	0 986 435 357	F 00V P01 004
							0 986 435 379		
			PR-Code 7MB	03.08-03.12	6	DBJ	0 445 115 085	0 986 435 364	
							0 986 435 374		
		180	CDUC <D43>	08.11-01.17	6	DBJ	0 445 116 039	0 986 435 422	F 00V P01 009
			CKVB <D43>	08.11-12.15	6	DBJ	0 445 117 026	0 986 435 453	F 00V P01 009
TDI, TDI quattro [F53]	3,0	160	CSWB <DD5>	06.16→	6	DBJ	0 445 117 041	0 986 435 441	F 00V P01 009
TDI, TDI quattro [8T3]	3,0	150/180	CKVC <D43>; CLAB <D1Q>	10.11-01.17	6	DBJ	0 445 117 021	0 986 435 413	F 00V P01 009
<b>A5 Sportback</b>									
2.0 TDI [F5A]	2,0	100	DEUB <D94>	05.17→	4	DBJ,X10	0 445 110 553		F 00V P01 004
					4	24Z,DBJ	0 445 110 468	0 986 435 258	F 00V P01 004
TDI [8TA]	2,0	100	CAGB <D94>	09.09-03.12	4	DBJ	0 445 116 029	0 986 435 360	F 00V P01 004
			CSUB <D94>	04.14-01.17	4	DBJ	0 445 110 468	0 986 435 258	F 00V P01 004
		100/110	CJCB <D94>; CJCD <DN4>	11.11-01.17	4	DBJ	0 445 110 646	0 986 435 166	F 00V P01 004
							0 986 435 167		
		105	CAGA <D92>	09.09-03.12	4	DBJ	0 445 116 029	0 986 435 360	F 00V P01 004
			CJCA <D92>	11.11-05.13	4	DBJ	0 445 110 646	0 986 435 166	F 00V P01 004
							0 986 435 167		
			CMEA <D92>	05.10-03.12	4	DBJ	0 445 116 029	0 986 435 360	F 00V P01 004
			CMFA <D92>	11.11-05.13	4	DBJ	0 445 110 646	0 986 435 166	F 00V P01 004
							0 986 435 167		
		110	CMFB <DN4>	09.13-01.17	4	DBJ	0 445 110 646	0 986 435 166	F 00V P01 004
							0 986 435 167		
			CSUA <DN4>	04.14-01.17	4	DBJ	0 445 110 468	0 986 435 258	F 00V P01 004
		120	CAHB <D95>	09.09-03.12	4	DBJ	0 445 116 029	0 986 435 360	F 00V P01 004
			CNHC <D95>	09.13-01.17	4	DBJ	0 445 110 470	0 986 435 257	F 00V P01 004
		120/130	CGLC <DE2>; CGLD <D95>	08.11-01.17	4	DBJ	0 445 110 646	0 986 435 166	F 00V P01 004
							0 986 435 167		
TDI, TDI quattro [F5A]	2,0	110	CZHA <DN4>	01.17→	4	X10	0 445 110 702		F 00V P01 004
					4	24Z,DBJ	0 445 110 704		F 00V P01 004
			DEUA <DN4>	05.17→	4	DBJ,X10	0 445 110 553		F 00V P01 004
					4	24Z,DBJ	0 445 110 468	0 986 435 258	F 00V P01 004
		140	DESA <DE5>	06.16→	4	DBJ,X10	0 445 110 644		F 00V P01 004
					4	24Z,DBJ	0 445 110 641		F 00V P01 004
			DETA <DE5>	09.16→	4	DBJ,X10	0 445 110 555		F 00V P01 004
					4	24Z,DBJ	0 445 110 470	0 986 435 257	F 00V P01 004





<b>2.0</b> TDI, TDI quattro [F5A]	2,0	140	DFVA <DE5>	11.16→	4							<b>F 00V P01 004</b>
TDI, TDI quattro [8TA]	2,0	125	CAHA <D93>	09.09-03.12	4	DBJ	<b>0 445 116 029</b>	<b>0 986 435 360</b>				<b>F 00V P01 004</b>
		140	CNHA <DE5>	09.13-01.17	4	DBJ	<b>0 445 110 470</b>	<b>0 986 435 257</b>				<b>F 00V P01 004</b>
<b>2.7</b> TDI [8TA]	2,7	120	CGKB <D1W>	09.09-03.12	6	DBJ	<b>0 445 116 022</b>	<b>0 986 435 357</b>				<b>F 00V P01 004</b>
								<b>0 986 435 379</b>				
		140	CAMA <D4V>	09.09-03.12	6	DBJ	<b>0 445 116 022</b>	<b>0 986 435 357</b>				<b>F 00V P01 004</b>
								<b>0 986 435 379</b>				
			CGKA <D4V>	09.09-03.12	6	DBJ	<b>0 445 116 022</b>	<b>0 986 435 357</b>				<b>F 00V P01 004</b>
								<b>0 986 435 379</b>				
TDI [8T3]	2,7	120	CAMB <D1W>	09.09-03.12	6	DBJ	<b>0 445 116 022</b>	<b>0 986 435 357</b>				<b>F 00V P01 004</b>
								<b>0 986 435 379</b>				
<b>3.0</b> TDI quattro [F5A]	3,0	200	CRTC <DJ3>	02.17→	6	DBJ	<b>0 445 117 041</b>	<b>0 986 435 441</b>				<b>F 00V P01 009</b>
		210	DCPC <DV8>	10.16→	6	DBJ	<b>0 445 117 071</b>					<b>F 00V P01 009</b>
TDI quattro [8F7]	3,0	160	CKVD <DD5>	05.15-01.17	6	DBJ	<b>0 445 117 026</b>	<b>0 986 435 453</b>				<b>F 00V P01 009</b>
TDI quattro [8TA]	3,0	155	CCWB <D1V>	05.09-05.10	6	DBJ	<b>0 445 116 022</b>	<b>0 986 435 357</b>				<b>F 00V P01 004</b>
								<b>0 986 435 379</b>				
		176	CAPA <D50>	05.09-03.12	6	DBJ	<b>0 445 115 085</b>	<b>0 986 435 364</b>				<b>F 00V P01 004</b>
								<b>0 986 435 374</b>				
			CCWA <D50>	09.09-03.12	6	DBJ	<b>0 445 116 022</b>	<b>0 986 435 357</b>				<b>F 00V P01 004</b>
								<b>0 986 435 379</b>				
		180	CDUC <D43>	08.11-01.17	6	DBJ	<b>0 445 116 039</b>	<b>0 986 435 422</b>				<b>F 00V P01 009</b>
			CKVB <D43>	08.11-06.14	6	DBJ	<b>0 445 117 026</b>	<b>0 986 435 453</b>				<b>F 00V P01 009</b>
TDI, TDI quattro [F5A]	3,0	160	CSWB <DD5>	02.17→	6	DBJ	<b>0 445 117 041</b>	<b>0 986 435 441</b>				<b>F 00V P01 009</b>
TDI, TDI quattro [8TA]	3,0	150/180	CKVC <D43>; CLAB <D1Q>	10.11-01.17	6	DBJ	<b>0 445 117 021</b>	<b>0 986 435 413</b>				<b>F 00V P01 009</b>
<b>A6</b>												
<b>2.0</b> TDI [4G; C7]	2,0	100	CSUE <D94>	09.14-09.16	4	DBJ	<b>0 445 110 468</b>	<b>0 986 435 258</b>				<b>F 00V P01 004</b>
			DDCA <D94>	05.16→	4	DBJ	<b>0 445 110 468</b>	<b>0 986 435 258</b>				<b>F 00V P01 004</b>
		100/130	CGLE <D94>; CMGB <DE2>	05.11-04.15	4	DBJ	<b>0 445 110 646</b>	<b>0 986 435 166</b>				<b>F 00V P01 004</b>
								<b>0 986 435 167</b>				
		110	CSUD <DN4>	09.14-09.16	4	DBJ	<b>0 445 110 468</b>	<b>0 986 435 258</b>				<b>F 00V P01 004</b>
			DDCB <DN4>	05.16→	4	DBJ	<b>0 445 110 468</b>	<b>0 986 435 258</b>				<b>F 00V P01 004</b>
		120	CGLD <D95>	02.11-04.15	4	DBJ	<b>0 445 110 646</b>	<b>0 986 435 166</b>				<b>F 00V P01 004</b>
								<b>0 986 435 167</b>				
		130	CGLC <DE2>	02.11-04.15	4	DBJ	<b>0 445 110 646</b>	<b>0 986 435 166</b>				<b>F 00V P01 004</b>
								<b>0 986 435 167</b>				
		140	CZJA <DE5>	05.15→	4	DBJ	<b>0 445 110 641</b>					<b>F 00V P01 004</b>
			DDDA <DE5>	05.16→	4	DBJ	<b>0 445 110 470</b>	<b>0 986 435 257</b>				<b>F 00V P01 004</b>
TDI quattro [4G; C7]	2,0	140	DDDA <DE5>	05.16→	4	DBJ	<b>0 445 110 468</b>	<b>0 986 435 258</b>				<b>F 00V P01 004</b>
TDI, TDI e [4F2; C6]	2,0	100/120/125	CAGB <D94>; CAHA <D93>; CAHB <D95>	10.08-08.11	4	DBJ	<b>0 445 116 029</b>	<b>0 986 435 360</b>				<b>F 00V P01 004</b>
TDI, TDI quattro [4G; C7]	2,0	140	CNHA <DE5>	11.13→	4	DBJ	<b>0 445 110 470</b>	<b>0 986 435 257</b>				<b>F 00V P01 004</b>
<b>2.7</b> TDI [4F2; C6]	2,7	120	CANB	10.08-05.09	6	DBJ	<b>0 445 116 022</b>	<b>0 986 435 357</b>				<b>F 00V P01 004</b>
								<b>0 986 435 379</b>				
		140	CANA <D4V>	10.08-08.11	6	DBJ	<b>0 445 116 022</b>	<b>0 986 435 357</b>				<b>F 00V P01 004</b>
								<b>0 986 435 379</b>				
TDI quattro [4F2; C6]	2,7	120	CAND <D1W>	10.08-08.11	6	DBJ	<b>0 445 116 022</b>	<b>0 986 435 357</b>				<b>F 00V P01 004</b>
								<b>0 986 435 379</b>				
		140	CANC <D4V>	10.08-08.11	6	DBJ	<b>0 445 116 022</b>	<b>0 986 435 357</b>				<b>F 00V P01 004</b>
								<b>0 986 435 379</b>				
TDI, TDI quattro [4F2; C6]	2,7	120	BSG <D1W>	11.04-10.08	6	DBJ	<b>0 445 115 080</b>	<b>0 986 435 353</b>				<b>F 00V P01 004</b>
								<b>0 986 435 388</b>				
		132	BPP <D1N>	11.04-10.08	6	DBJ	<b>0 445 115 080</b>	<b>0 986 435 353</b>				<b>F 00V P01 004</b>
								<b>0 986 435 388</b>				
<b>3.0</b> TDI [4G; C7]	3,0	155	CTCB <TH1>	09.14-07.15	6	DBJ	<b>0 445 117 026</b>	<b>0 986 435 453</b>				<b>F 00V P01 009</b>
			CZVD <D1V>	08.15→	6	DBJ	<b>0 445 117 041</b>	<b>0 986 435 441</b>				<b>F 00V P01 009</b>
		160	CTCC <TH1>	09.14-07.15	6	DBJ	<b>0 445 117 026</b>	<b>0 986 435 453</b>				<b>F 00V P01 009</b>
			CZVB <DD5>	08.15→	6	DBJ	<b>0 445 117 041</b>	<b>0 986 435 441</b>				<b>F 00V P01 009</b>
TDI quattro [4F2; C6]	3,0	155	CDYB <D1V>	10.08-08.11	6	DBJ	<b>0 445 116 022</b>	<b>0 986 435 357</b>				<b>F 00V P01 004</b>
								<b>0 986 435 379</b>				







◀ AUDI

3.0 TDI quattro [4F2; C6]	3,0	155/165/171	ASB <D1D>; BMK; BNG <D1V>	04.04-10.08	6	DBJ	0 445 115 078	0 986 435 358			
		176	CDYA <D50>	10.08-08.11	6	DBJ	0 445 116 022	0 986 435 357	F 00V P01 004		
			CDYC <D50>	10.08-08.11	6	DBJ	0 445 116 022	0 986 435 357	F 00V P01 004		
							0 986 435 379				
TDI quattro [4G; C7]	3,0	155	CRTF <D1V>	09.14-11.15	6	DBJ	0 445 117 041	0 986 435 441	F 00V P01 009		
		160	CRTE <DD5>	09.14-11.15	6	DBJ	0 445 117 041	0 986 435 441	F 00V P01 009		
			CZVA <DD5>	11.15→	6	DBJ	0 445 117 041	0 986 435 441	F 00V P01 009		
		176	CPNB <D50>	05.13-04.15	6	DBJ	0 445 117 032	0 986 435 432	F 00V P01 009		
				05.13→	6	DBJ	0 445 117 032	0 986 435 432	F 00V P01 009		
				05.15-05.16	6	DBJ	0 445 117 026	0 986 435 453	F 00V P01 009		
				06.16→	6	DBJ	0 445 117 026	0 986 435 453	F 00V P01 009		
		180	CDUC <D43>	11.10-05.12	6	DBJ	0 445 116 039	0 986 435 422	F 00V P01 009		
			CDUD <D43>	04.12-06.16	6	DBJ	0 445 116 039	0 986 435 422	F 00V P01 009		
			CKVB <D43>	11.11-05.12	6	DBJ	0 445 117 026	0 986 435 453	F 00V P01 009		
			CKVC <D43>	04.12-04.15	6	DBJ	0 445 117 026	0 986 435 453	F 00V P01 009		
		200	CRTD <DJ3>	09.14→	6	DBJ	0 445 117 041	0 986 435 441	F 00V P01 009		
		230	CGQB <DD3>	12.11-04.15	6	DBJ	0 445 117 028	0 986 435 431	F 00V P01 009		
		235	CVUA <TG1>	09.14→	6	DBJ	0 445 117 044	0 986 435 455	F 00V P01 009		
240	CVUB <DD6>	10.14→	6	DBJ	0 445 117 044	0 986 435 455	F 00V P01 009				
TDI, TDI quattro [4G; C7]	3,0	150	CLAA <D1Q>; CLAB <D1Q>	11.10-04.15	6	DBJ	0 445 117 021	0 986 435 413	F 00V P01 009		
		155	CZVC <D1V>	11.15→	6	DBJ	0 445 117 041	0 986 435 441			
<b>A6 Allroad</b>											
2.7 TDI [4FH; C6]	2,7	120	BSG <D1W>	05.06-10.08	6	DBJ	0 445 115 080	0 986 435 353	F 00V P01 004		
			CAND <D1W>	10.08-08.11	6	DBJ	0 445 116 022	0 986 435 357	F 00V P01 004		
				132	BPP <D1N>	05.06-10.08	6	DBJ	0 445 115 080	0 986 435 353	F 00V P01 004
				140	CANC <D4V>	10.08-08.11	6	DBJ	0 445 116 022	0 986 435 357	F 00V P01 004
							0 986 435 379				
3.0 TDI [4FH; C6]	3,0	155	CDYB <D1V>	10.08-08.11	6	DBJ	0 445 116 022	0 986 435 357	F 00V P01 004		
								0 986 435 379			
			155/171	ASB <D1D>; BNG <D1V>	05.06-10.08	6	DBJ	0 445 115 078	0 986 435 358	F 00V P01 004	
			176	CDYA <D50>	10.08-08.11	6	DBJ	0 445 116 022	0 986 435 357	F 00V P01 004	
									0 986 435 379		
					CDYC <D50>	10.08-08.11	6	DBJ	0 445 116 022	0 986 435 357	F 00V P01 004
									0 986 435 379		
		TDI [4G; C7]	3,0	140	CZVF <DJ0>	11.15→	6	DBJ	0 445 117 041	0 986 435 441	F 00V P01 009
				150	CLAA <D1Q>	01.12-12.14	6	DBJ	0 445 117 021	0 986 435 413	F 00V P01 009
				155	CRTF <D1V>	09.14→	6	DBJ	0 445 117 041	0 986 435 441	F 00V P01 009
CZVC <D1V>	11.15→				6	DBJ	0 445 117 041	0 986 435 441	F 00V P01 009		
160	CRTE <DD5>			09.14→	6	DBJ	0 445 117 041	0 986 435 441	F 00V P01 009		
	CZVA <DD5>			11.15→	6	DBJ	0 445 117 041	0 986 435 441	F 00V P01 009		
180	CDUD <D43>			01.12-06.16	6	DBJ	0 445 116 039	0 986 435 422	F 00V P01 009		
	CKVC <D43>			01.12-12.14	6	DBJ	0 445 117 026	0 986 435 453	F 00V P01 009		
200	CRTD <DJ3>	09.14→	6	DBJ	0 445 117 041	0 986 435 441	F 00V P01 009				
230	CGQB <DD3>	01.12-12.14	6	DBJ	0 445 117 028	0 986 435 431	F 00V P01 009				
235	CVUA <TG1>	09.14→	6	DBJ	0 445 117 028	0 986 435 431	F 00V P01 009				
<b>A6 Avant</b>											
2.0 TDI [4G; C7]	2,0	100	CGLE <D94>	01.12-04.15	4	DBJ	0 445 110 646	0 986 435 166	F 00V P01 004		
								0 986 435 167			
					09.14-09.16	4	DBJ	0 445 110 468	0 986 435 258	F 00V P01 004	
					05.16→	4	DBJ	0 445 110 468	0 986 435 258	F 00V P01 004	
		110	CSUD <DN4>	09.14-09.16	4	DBJ	0 445 110 468	0 986 435 258	F 00V P01 004		
			DDCB <DN4>	05.16→	4	DBJ	0 445 110 468	0 986 435 258	F 00V P01 004		
		120	CGLD <D95>	05.11-04.15	4	DBJ	0 445 110 646	0 986 435 166	F 00V P01 004		
								0 986 435 167			
		130	CGLC <DE2>	05.11-04.15	4	DBJ	0 445 110 646	0 986 435 166	F 00V P01 004		
								0 986 435 167			
		CMGB <DE2>	05.11-04.15	4	DBJ	0 445 110 646	0 986 435 166	F 00V P01 004			
							0 986 435 167				





2.0 TDI [4G; C7]	2,0	140	CZJA <DE5>	05.15→	4	DBJ	0 445 110 641		F 00V P01 004
			DDDA <DE5>	05.16→	4	DBJ	0 445 110 470	0 986 435 257	F 00V P01 004
TDI quattro [4G; C7]	2,0	140	DDDA <DE5>	05.16→	4	DBJ	0 445 110 468	0 986 435 258	F 00V P01 004
TDI, TDI e [4F5; C6]	2,0	100/120/125	CAGB <D94>; CAHA <D93>; CAHB <D95>	10.08-08.11	4	DBJ	0 445 116 029	0 986 435 360	F 00V P01 004
TDI, TDI quattro [4G; C7]	2,0	140	CNHA <DE5>	11.13→	4	DBJ	0 445 110 470	0 986 435 257	F 00V P01 004
2.7 TDI [4F5; C6]	2,7	120	CANB	10.08-05.09	6	DBJ	0 445 116 022	0 986 435 357	
			BPP <D1N>	11.04-10.08	6	DBJ	0 445 115 080	0 986 435 353	F 00V P01 004
			CANA <D4V>	10.08-08.11	6	DBJ	0 445 116 022	0 986 435 357	F 00V P01 004
TDI quattro [4F5; C6]	2,7	120	CAND <D1W>	10.08-08.11	6	DBJ	0 445 116 022	0 986 435 357	F 00V P01 004
			BPP <D1N>	11.04-10.08	6	DBJ	0 445 115 080	0 986 435 353	F 00V P01 004
				01.09-06.11	6				F 00V P01 004
			CANC <D4V>	10.08-08.11	6	DBJ	0 445 116 022	0 986 435 357	F 00V P01 004
TDI, TDI quattro [4F5; C6]	2,7	120	BSG <D1W>	03.05-10.08	6	DBJ	0 445 115 080	0 986 435 353	
							0 986 435 388		
3.0 TDI [4G; C7]	3,0	150	CLAB <D1Q>	05.11-04.15	6	DBJ	0 445 117 021	0 986 435 413	F 00V P01 009
			CTCB <TH1>	09.14-07.15	6	DBJ	0 445 117 026	0 986 435 453	F 00V P01 009
			CZVD <D1V>	08.15→	6	DBJ	0 445 117 041	0 986 435 441	F 00V P01 009
			CTCC <TH1>	09.14-07.15	6	DBJ	0 445 117 026	0 986 435 453	F 00V P01 009
TDI quattro [4F5; C6]	3,0	155	CDYB <D1V>	10.08-08.11	6	DBJ	0 445 116 022	0 986 435 357	F 00V P01 004
			ASB <D1D>; BMK; BNG <D1V>	03.05-10.08	6	DBJ	0 445 115 078	0 986 435 358	
			CDYA <D50>	10.08-08.11	6	DBJ	0 445 116 022	0 986 435 357	F 00V P01 004
			CDYC <D50>	10.08-08.11	6	DBJ	0 445 116 022	0 986 435 357	F 00V P01 004
TDI quattro [4G; C7]	3,0	150	CLAA <D1Q>	05.11-04.15	6	DBJ	0 445 117 021	0 986 435 413	F 00V P01 009
			CRTF <D1V>	09.14-11.15	6	DBJ	0 445 117 041	0 986 435 441	F 00V P01 009
			CRTE <DD5>	09.14-11.15	6	DBJ	0 445 117 041	0 986 435 441	F 00V P01 009
			CZVA <DD5>	11.15→	6	DBJ	0 445 117 041	0 986 435 441	F 00V P01 009
			CDUC <D43>	05.11-05.12	6	DBJ	0 445 116 039	0 986 435 422	F 00V P01 009
			CDUD <D43>	04.12-06.16	6	DBJ	0 445 116 039	0 986 435 422	F 00V P01 009
			CKVB <D43>	11.11-05.12	6	DBJ	0 445 117 026	0 986 435 453	F 00V P01 009
			CKVC <D43>	04.12-04.15	6	DBJ	0 445 117 026	0 986 435 453	F 00V P01 009
			CRTD <DJ3>	09.14→	6	DBJ	0 445 117 041	0 986 435 441	F 00V P01 009
			CGQB <DD3>	12.11-04.15	6	DBJ	0 445 117 028	0 986 435 431	F 00V P01 009
			CVUA <TG1>	09.14→	6	DBJ	0 445 117 044	0 986 435 455	F 00V P01 009
			CVUB <DD6>	10.14→	6	DBJ	0 445 117 044	0 986 435 455	F 00V P01 009
TDI, TDI quattro [4G; C7]	3,0	155	CZVC <D1V>	11.15→	6	DBJ	0 445 117 041	0 986 435 441	
			CZVB <DD5>	08.15→	6	DBJ	0 445 117 041	0 986 435 441	F 00V P01 009
<b>A7 Sportback</b>									
3.0 TDI [4G; C7]	3,0	160	CTCC <TH1>	07.14-11.15	6	DBJ	0 445 117 026	0 986 435 453	F 00V P01 009
TDI quattro [4G; C7]	3,0	155	CRTF <D1V>	07.14-11.15	6	DBJ	0 445 117 041	0 986 435 441	F 00V P01 009
			CTCB <TH1>	07.14-11.15	6	DBJ	0 445 117 026	0 986 435 453	F 00V P01 009
			CZVC <D1V>	11.15-05.18	6	DBJ	0 445 117 041	0 986 435 441	F 00V P01 009
			CRTE <DD5>	07.14-11.15	6	DBJ	0 445 117 041	0 986 435 441	F 00V P01 009
			CZVA <DD5>	11.15-05.18	6	DBJ	0 445 117 041	0 986 435 441	F 00V P01 009
			CPNB <D50>	05.13-06.17	6	DBJ	0 445 117 032	0 986 435 432	F 00V P01 009
			CDUC <D43>	07.10-05.12	6	DBJ	0 445 116 039	0 986 435 422	F 00V P01 009
			CDUD <D43>	05.12-05.16	6	DBJ	0 445 116 039	0 986 435 422	F 00V P01 009
			CKVB <D43>	11.11-05.12	6	DBJ	0 445 117 026	0 986 435 453	F 00V P01 009
			CKVC <D43>	05.12-03.15	6	DBJ	0 445 117 026	0 986 435 453	F 00V P01 009
			CRTD <DJ3>	05.14-05.18	6	DBJ	0 445 117 041	0 986 435 441	F 00V P01 009
			CGQB <DD3>	11.11-03.15	6	DBJ	0 445 117 028	0 986 435 431	F 00V P01 009
			CVUA <TG1>	05.14-05.18	6	DBJ	0 445 117 044	0 986 435 455	F 00V P01 009







◀ AUDI

3.0	TDI quattro [4G, C7]	3,0	240	CVUB <DD6>	09.14-05.18	6	DBJ	0 445 117 044	0 986 435 455	F 00V P01 009
	TDI, TDI quattro [4G, C7]	3,0	140	CZVE <DJ0>	11.15-05.18	6	DBJ	0 445 117 041	0 986 435 441	F 00V P01 009
				CZVF <DJ0>	11.15-05.18	6	DBJ	0 445 117 041	0 986 435 441	F 00V P01 009
			150	CLAA <D1Q>; CLAB <D1Q>	11.10-03.15	6	DBJ	0 445 117 021	0 986 435 413	F 00V P01 009
			155	CZVD <D1V>	08.15-05.18	6	DBJ	0 445 117 041	0 986 435 441	F 00V P01 009
		160	CZVB <DD5>	08.15-05.18	6	DBJ	0 445 117 041	0 986 435 441	F 00V P01 009	
<b>A8</b>										
3.0	TDI quattro [4E; D3]	3,0	155/171	ASB <D1D>; BNG <D1V>	11.03-07.10	6	DBJ	0 445 115 078	0 986 435 358	
	TDI quattro [4H; D4]	3,0	150/176/184	CLAB <D1Q>; CMHA <D13>; CPNA <TH1>	09.11-04.14	6	DBJ	0 445 117 021	0 986 435 413	F 00V P01 009
			155	CTBB <TH1>	09.13-01.18	6	DBJ	0 445 117 026	0 986 435 453	F 00V P01 009
			155/184	CDTA <D51>; CDTB <D1V>	07.10-04.14	6	DBJ	0 445 116 039	0 986 435 422	F 00V P01 009
			176	CPNB <D50>	09.13-06.16	6	DBJ	0 445 117 032	0 986 435 432	F 00V P01 009
			184	CDTC <TF1>	09.13-01.18	6	DBJ	0 445 116 039	0 986 435 422	F 00V P01 009
3.3	TDI quattro [4D2; D2]	3,3	165	AKF	10.13-01.18	6	DBJ	0 445 117 026	0 986 435 453	F 00V P01 009
				CTBA <DD7>; CTBD <DV7>	12.99-08.02	8	DBJ	0 445 110 113		
4.0	TDI quattro [4E; D3]	4,0	202	ASE	05.03-07.05	8	DBJ	0 445 110 158	0 986 435 169	
4.2	TDI quattro [4E; D3]	4,2	235/240	BMC; BVN	01.05-07.10	8	DBJ	0 445 115 085	0 986 435 364	
								0 986 435 374		
	TDI quattro [4H; D4]	4,2	258	CDSB <DD2>	11.09-04.14	8	DBJ	0 445 117 019	0 986 435 412	F 00V P01 009
			283	CTEC <TE5>	10.13-01.18	8	DBJ	0 445 117 038		F 00V P01 009
<b>Q2</b>										
2.0	TDI [GAB]	2,0	105	CRFC <DN6>	09.16-06.17	4	DBJ	0 445 110 474	0 986 435 242	F 00V P01 004
					09.16→	4	DBJ	0 445 110 474	0 986 435 242	F 00V P01 004
					07.17→	4	DBJ	0 445 110 638		F 00V P01 004
	TDI quattro [GAB]	2,0	140	DFHA <DE5>	07.16→	4	DBJ	0 445 110 470	0 986 435 257	F 00V P01 004
2.0	TDI, TDI quattro [GAB]	2,0	110	DCYA <DN4>	09.16→	4	DBJ	0 445 110 468	0 986 435 258	F 00V P01 004
				DFGA <DN4>	09.16→	4	DBJ	0 445 110 468	0 986 435 258	F 00V P01 004
<b>Q3</b>										
2.0	TDI [8U]	2,0	88	DFTC <D90>	11.15→	4	DBJ	0 445 110 468	0 986 435 258	F 00V P01 004
			100	CFFA <D94>	09.11-04.15	4	DBJ	0 445 110 646	0 986 435 166	F 00V P01 004
								0 986 435 167		
				CUVB <TL4>	11.14-11.15	4	DBJ	0 445 110 470	0 986 435 257	F 00V P01 004
				DFTB <DE9>	11.15→	4	DBJ	0 445 110 468	0 986 435 258	F 00V P01 004
			103	CLJA <D91>	05.13-04.15	4	DBJ	0 445 110 646	0 986 435 166	F 00V P01 004
								0 986 435 167		
			110	DBBA <DN4>	11.15→	4	DBJ	0 445 110 468	0 986 435 258	F 00V P01 004
	TDI quattro [8U]	2,0	88	CUVD <D90>	02.15-11.15	4	DBJ	0 445 110 470	0 986 435 257	F 00V P01 004
			120	CFGD <D95>	06.11-04.15	4	DBJ	0 445 110 646	0 986 435 166	F 00V P01 004
							0 986 435 167			
		130	CLLB <DE2>	06.11-04.15	4	DBJ	0 445 110 646	0 986 435 166	F 00V P01 004	
							0 986 435 167			
		135	CYLA <DK7>	05.15→	4	DBJ	0 445 110 641		F 00V P01 004	
TDI, TDI quattro [8U]	2,0	103	CFFB <D91>	09.11-04.15	4	DBJ	0 445 110 646	0 986 435 166	F 00V P01 004	
							0 986 435 167			
		110	CUVC <DN4>	11.14-11.15	4	DBJ	0 445 110 470	0 986 435 257	F 00V P01 004	
			DFTA <DN4>	11.15→	4	DBJ	0 445 110 468	0 986 435 258	F 00V P01 004	
		130	CFGC <DE2>	06.11-04.15	4	DBJ	0 445 110 646	0 986 435 166	F 00V P01 004	
							0 986 435 167			
		135	CUWA <DK7>	11.14-11.15	4	DBJ	0 445 110 470	0 986 435 257	F 00V P01 004	
			DFUA <DK7>	11.15→	4	DBJ	0 445 110 470	0 986 435 257	F 00V P01 004	
<b>Q5</b>										
2.0	TDI [FYB]	2,0	100	DEUB <D94>	01.17→	4	DBJ,X10	0 445 110 553		F 00V P01 004
						4	24Z,DBJ	0 445 110 468	0 986 435 258	F 00V P01 004
			110	DEUA <DN4>	01.17→	4	DBJ,X10	0 445 110 553		F 00V P01 004
						4	24Z,DBJ	0 445 110 468	0 986 435 258	F 00V P01 004
2.0	TDI quattro [FYB]	2,0	120	DETB <DE5>	05.16→	4	DBJ,X10	0 445 110 555		F 00V P01 004
						4	24Z,DBJ	0 445 110 470	0 986 435 257	F 00V P01 004
			140	DESA <DE5>	05.16→	4	DBJ,X10	0 445 110 644		F 00V P01 004
						4	24Z,DBJ	0 445 110 641		F 00V P01 004
				DETA <DE5>	05.16→	4	DBJ,X10	0 445 110 555		F 00V P01 004
						4	24Z,DBJ	0 445 110 470	0 986 435 257	F 00V P01 004





2.0 TDI quattro [8RB]	2,0	100	CAGB <D94>	08.09-05.10	4	DBJ	0 445 116 029	0 986 435 360	F 00V P01 004		
		105	CAGA <D92>	08.09-05.10	4	DBJ	0 445 116 029	0 986 435 360	F 00V P01 004		
		120	CAHB <D95>	11.08-09.10	4	DBJ	0 445 116 029	0 986 435 360	F 00V P01 004		
			CGLA <D95>	05.10-09.12	4	DBJ	0 445 110 646	0 986 435 166	F 00V P01 004		
								0 986 435 167			
					CNHC <D95>	04.14-05.17	4	DBJ	0 445 110 470	0 986 435 257	F 00V P01 004
		125	CAHA <D93>	11.08-09.10	4	DBJ	0 445 116 029	0 986 435 360	F 00V P01 004		
			CGLB <D93>	05.10-09.12	4	DBJ	0 445 110 646	0 986 435 166	F 00V P01 004		
								0 986 435 167			
		130	CGLC <DE2>	06.12-05.17	4	DBJ	0 445 110 646	0 986 435 166	F 00V P01 004		
			CMGB <DE2>	06.12-05.17	4	DBJ	0 445 110 646	0 986 435 166	F 00V P01 004		
								0 986 435 167			
		TDI, TDI quattro [8RB]	2,0	100	CSUB <D94>	05.14-05.17	4	DBJ	0 445 110 468	0 986 435 258	F 00V P01 004
				100/105/ 120/125	CGLD <D95>; CJCA <D92>; CJCB <D94>; CMGA <D93>	05.10-06.14	4	DBJ	0 445 110 646	0 986 435 166	F 00V P01 004
							0 986 435 167				
110	CJCD <DN4>			05.13-06.16	4	DBJ	0 445 110 646	0 986 435 166	F 00V P01 004		
								0 986 435 167			
			CSUA <DN4>	05.14-05.17	4	DBJ	0 445 110 468	0 986 435 258	F 00V P01 004		
			CNHA <DE5>	04.14-05.17	4	DBJ	0 445 110 470	0 986 435 257	F 00V P01 004		
3.0 TDI quattro [8RB]	3,0	155	CCWB <D1V>	11.08-09.12	6	DBJ	0 445 116 022	0 986 435 357	F 00V P01 004		
							0 986 435 379				
		176	CCWA <D50>	11.08-09.12	6	DBJ	0 445 116 022	0 986 435 357	F 00V P01 004		
			CPNB <D50>	09.13-05.17	6	DBJ	0 445 117 032	0 986 435 432	F 00V P01 009		
		180	CDUD <D43>	06.12-05.17	6	DBJ	0 445 116 039	0 986 435 422	F 00V P01 009		
		184/190	CTBA <DD7>; CTBC <D51>	11.13-05.17	6	DBJ	0 445 117 026	0 986 435 453	F 00V P01 009		
<b>Q7</b>											
3.0 TDI [4LB]	3,0	150/176	CJGA <D50>; CJGC <D1Q>; CJMA <D1Q>	05.10-08.15	6	DBJ	0 445 117 021	0 986 435 413	F 00V P01 009		
		155/171	BUG <D1D>; BUN <D1V>	03.06-05.08	6	DBJ	0 445 115 078	0 986 435 358	F 00V P01 004		
		155/176	CASA <D50>; CASB <D1V>	09.07-05.10	6	DBJ	0 445 116 022	0 986 435 357	F 00V P01 004		
								0 986 435 379			
		165	CATA <D1T>	11.08-05.12	6	DBJ	0 445 117 004	0 986 435 382	F 00V P01 004		
		176	CCMA <D50>	06.09-05.11	6	DBJ	0 445 117 002	0 986 435 380	F 00V P01 004		
			CNRB <D50>	05.12-08.15	6	DBJ	0 445 117 032	0 986 435 432	F 00V P01 009		
		180	CJGD <D43>	05.11-08.15	6	DBJ	0 445 117 021	0 986 435 413	F 00V P01 009		
			CLZB <D43>	05.11-08.15	6	DBJ	0 445 117 021	0 986 435 413	F 00V P01 009		
			CRCA <D43>	05.11-08.15	6	DBJ	0 445 117 021	0 986 435 413	F 00V P01 009		
		TDI [4MB]	3,0	155	CZZB <D1V>	08.15→	6	DBJ	0 445 117 041	0 986 435 441	F 00V P01 009
				160	CRTE <DD5>	08.15→	6	DBJ	0 445 117 041	0 986 435 441	F 00V P01 009
					CZZA <DD5>	08.15→	6	DBJ	0 445 117 041	0 986 435 441	F 00V P01 009
				183/200	CRTC <DJ3>; CVMD <DD9>	01.15→	6	DBJ	0 445 117 041	0 986 435 441	F 00V P01 009
190	CUEA <DD7>			08.15-05.16	6	DBJ	0 445 117 049	0 986 435 432	F 00V P01 009		
					08.15→	6	DBJ	0 445 117 049	0 986 435 432	F 00V P01 009	
			06.16→	6	DBJ	0 445 117 049	0 986 435 432	F 00V P01 009			
4.2 TDI [4LB]	4,1 4,2	250	CCFC <D57>	05.10-08.15	8	DBJ	0 445 117 019	0 986 435 412	F 00V P01 004		
		240	BTR <D1S>	03.07-06.09	8	DBJ	0 445 115 085	0 986 435 364	F 00V P01 004		
								0 986 435 374			
		250	CCFA <D57>	06.09-05.10	8	DBJ	0 445 117 019	0 986 435 412	F 00V P01 004		
6.0 TDI [4LB]	6,0	368	CCGA <D56>	09.08-04.12	12	DBJ	0 445 117 011	0 986 435 384	F 00V P01 009		
<b>SQ5</b>											
3.0 TDI quattro [8RB]	3,0	230	CGQB <DD3>	12.12-05.15	6	DBJ	0 445 117 028	0 986 435 431	F 00V P01 009		
		230/240	CVUB <DD6>; CVUC <DD3>	05.15-05.17	6	DBJ	0 445 117 044	0 986 435 455	F 00V P01 009		
		250	DEHA <DD4>	11.15-05.17	6	DBJ	0 445 117 054	0 986 435 455	F 00V P01 009		
<b>SQ7</b>											
4.0 TDI quattro [4MB]	4,0	310/320	CZAC <DK4>; DCDB <DJ7>	04.16→	8				F 00V P01 009		
<b>TT Coupé</b>											
2.0 TDI quattro [8J3]	2,0	125	CBBB <D93>	06.08-06.10	4	DBJ	0 445 116 029	0 986 435 360	F 00V P01 004		
			CFGB <D93>	05.10-06.14	4	DBJ	0 445 110 646	0 986 435 166	F 00V P01 004		
							0 986 435 167				
TDI, TDI quattro [FV3]	2,0	135	CUNA <DK7>	07.14→	4	DBJ	0 445 110 470	0 986 435 257	F 00V P01 004		





◀ AUDI

TT Roadster										
2.0 TDI quattro [8J9]	2,0	125	CBBB <D93>	06.08-06.10	4	DBJ	<b>0 445 116 029</b>	<b>0 986 435 360</b>	<b>F 00V P01 004</b>	
			CFGB <D93>	05.10-06.14	4	DBJ	<b>0 445 110 646</b>	<b>0 986 435 166</b>	<b>F 00V P01 004</b>	
							<b>0 986 435 167</b>			
TDI, TDI quattro [FV9]	2,0	135	CUNA <DK7>	11.14→	4	DBJ	<b>0 445 110 470</b>	<b>0 986 435 257</b>	<b>F 00V P01 004</b>	

**BENTLEY**

Bentayga										
4.0 TDI	4,0	310/320	CZAA; CZAC <DK4>	11.16→	8				<b>F 00V P01 009</b>	

**BMW**

Serie M										
M 550 d xDrive [F 10]	3,0	280	N57 D30C	03.12-10.16	6	DBJ	<b>0 445 118 001</b>			
M 550 Touring d xDrive [F 11]	3,0	280	N57 D30C	03.12-02.17	6	DBJ	<b>0 445 118 001</b>			
X 5 M 50 d xDrive [E 70]	3,0	280	N57 D30C	04.12-06.13	6	DBJ	<b>0 445 118 001</b>			
50 d xDrive [F 15]	3,0	280	N57 D30C	11.13→	6	DBJ	<b>0 445 118 001</b>			
X 6 M 50 d [F 16]	3,0	280	N57 D30C	11.14→	6	DBJ	<b>0 445 118 001</b>			
50 d xDrive [E 71]	3,0	280	N57 D30C	04.12-06.14	6	DBJ	<b>0 445 118 001</b>			
Serie M5										
550 d xDrive [G 30]	3,0	294	B57 D30C	06.17→	6	DBJ	<b>0 445 118 010</b>			
Serie X1										
16 d sDrive [E 84]	2,0	85	N47 D20C	07.12-06.15	4	DBJ	<b>0 445 110 289</b>	<b>0 986 435 179</b>	<b>0 986 435 245</b>	
d sDrive [F 48]	1,5	85	B37 C15A	11.15→	3	DBJ	<b>0 445 110 598</b>			
			B37 C15A <B37B>	02.18→	3	DBJ	<b>0 445 110 819</b>			
18 d sDrive, d xDrive [E 84]	2,0	100-105	N47 D20C; N47 D20C <N47N>	11.09-06.15	4	DBJ	<b>0 445 110 289</b>	<b>0 986 435 179</b>	<b>0 986 435 245</b>	
d sDrive, d xDrive [F 48]	2,0	100-110	B47 C20A	10.15→	4	DBJ	<b>0 445 110 613</b>	<b>0 986 435 268</b>		
		110	B47 C20B <B47B>	02.18→	4	DBJ	<b>0 445 110 818</b>			
20 d sDrive, d xDrive [E 84]	2,0	120-130	N47 D20C	10.09-06.12	4	DBJ	<b>0 445 116 024</b>	<b>0 986 435 394</b>		
d sDrive, d xDrive [F 48]	2,0	120-140	B47 C20A	10.15→	4	DBJ	<b>0 445 110 570</b>	<b>0 986 435 269</b>		
		140	B47 C20B <B47D>	11.17→	4	DBJ	<b>0 445 110 814</b>			
d sDrive, ed sDrive, s xDrive [E 84]	2,0	120/135	N47 D20C <N47N>	09.11-06.15	4	DBJ	<b>0 445 110 595</b>	<b>0 986 435 244</b>		
23 d xDrive [E 84]	2,0	150	N47 D20D	10.09-06.12	4	DBJ	<b>0 445 117 017</b>	<b>0 986 435 411</b>		
25 d xDrive [E 84]	2,0	160	N47 D20D	07.12-06.15	4	DBJ	<b>0 445 117 030</b>	<b>0 986 435 425</b>		
d xDrive [F 48]	2,0	170	B47 C20B <B47>	10.15→	4	DBJ	<b>0 445 118 004</b>			
Serie X2										
18 d sDrive [F 39]	2,0	110	B47 C20A	01.18→	4	DBJ	<b>0 445 110 613</b>	<b>0 986 435 268</b>		
d sDrive, d xDrive [F 39]	2,0	110	B47 C20B <B47B>	01.18→	4	DBJ	<b>0 445 110 818</b>			
20 d xDrive [F 39]	2,0	140	B47 C20A	01.18→	4	DBJ	<b>0 445 110 570</b>	<b>0 986 435 269</b>		
			B47 C20B <B47D>	01.18→	4	DBJ	<b>0 445 110 814</b>			
25 d xDrive [F 39]	2,0	170	B47 C20B <B47>	01.18→	4	DBJ	<b>0 445 118 004</b>			
Serie X3										
2.0 d [E 83]	2,0	110	20 4D 4 <M 47N>	10.04-09.07	4	DBJ	<b>0 445 110 216</b>	<b>0 986 435 091</b>		
		130	N47 D20A	09.07-08.08	4	DBJ	<b>0 445 116 001</b>	<b>0 986 435 363</b>		
3.0 d [E 83]	3,0	150	30 6D 2 <M 57N>	01.04-09.05	6	DBJ	<b>0 445 110 216</b>	<b>0 986 435 091</b>		
		160	30 6D 3 <M 57N2>	09.05-09.07	6	DBJ	<b>0 445 115 070</b>	<b>0 986 435 354</b>		
								<b>0 986 435 359</b>		
sd [E 83]	3,0	210	30 6D 5	10.07-08.08	6	DBJ	<b>0 445 115 077</b>	<b>0 986 435 359</b>		
				09.06-05.07	6	DBJ	<b>0 445 115 050</b>	<b>0 986 435 359</b>		
				06.07-08.08	6	DBJ	<b>0 445 115 077</b>	<b>0 986 435 359</b>		
18 d sDrive [F 25]	2,0	105/110	N47 D20C	10.12-11.14	4	DBJ	<b>0 445 110 595</b>	<b>0 986 435 244</b>		
		110	B47 D20A	11.14-08.17	4	DBJ	<b>0 445 110 570</b>	<b>0 986 435 269</b>		
d sDrive [G 01]	2,0	110	B47 D20A	03.18→	4	DBJ	<b>0 445 110 570</b>	<b>0 986 435 269</b>		





18	d xDrive [E 83]	2,0	105	N47 D20C	05.09-08.10	4	DBJ	0 445 116 024	0 986 435 394	
20	d xDrive [E 83]	2,0	120-130	N47 D20...	09.08-08.10	4	DBJ	0 445 116 001	0 986 435 363	
	d xDrive [F 25]	2,0	120-135	N47 D20C	10.10-08.17	4	DBJ	0 445 110 595	0 986 435 244	
			120-155	B47 D20A	04.14-08.17	4	DBJ	0 445 110 570	0 986 435 269	
	d xDrive [G 01]	2,0	140	B47 D20A	11.17→	4	DBJ	0 445 110 570	0 986 435 269	
25	d xDrive [G 01]	2,0	170	B47 D20B <B47>	03.18→	4	DBJ	0 445 118 004		
30	d xDrive [E 83]	3,0	155-160	30 6D 3 <M 57N2>	09.08-08.10	6	DBJ	0 445 115 077	0 986 435 359	
	d xDrive [F 25]	3,0	155-210	N57 D30A	04.11-08.17	6	DBJ	0 445 110 595	0 986 435 244	
	d xDrive [G 01]	3,0	195	B57 D30A	11.17→	6	DBJ	0 445 118 023		
35	d xDrive [E 83]	3,0	210	30 6D 5	09.08-08.10	6	DBJ	0 445 115 077	0 986 435 359	
	d xDrive [F 25]	3,0	230	N57 D30B <N57Z>	09.11-08.17	6	DBJ	0 445 117 030	0 986 435 425	
<b>Serie X4</b>										
20	d xDrive [F 26]	2,0	120-140	B47 D20A	06.14→	4	DBJ	0 445 110 570	0 986 435 269	
	d xDrive [G 02]	2,0	140	B47 D20A	06.18→	4	DBJ	0 445 110 570	0 986 435 269	
25	d xDrive [G 02]	2,0	170	B47 D20B <B47>	06.18→	4	DBJ	0 445 118 004		
30	d xDrive [F 26]	3,0	155-210	N57 D30A	06.14→	6	DBJ	0 445 110 595	0 986 435 244	
35	d xDrive [F 26]	3,0	230	N57 D30B	06.14→	6	DBJ	0 445 117 030	0 986 435 425	
<b>Serie X4 M</b>										
40	d xDrive [G 02]	3,0	240	B57 D30B	06.18→	6	DBJ	0 445 118 004		
<b>Serie X5</b>										
3.0	d [E 53]	3,0	135	30 6D 1 <M 57 D 30>	03.01-09.03	6	DBJ	0 445 110 266	0 986 435 022	F 00V C17 504
			155-160	30 6D 2 <M 57N>	10.03-10.06	6	DBJ,EU3	0 445 110 131	0 986 435 084	
						6	DBJ,EU4	0 445 110 216	0 986 435 091	
	d xDrive [E 70]	3,0	155-173	30 6D 3 <M 57N2>	03.07-09.07	6	DBJ	0 445 115 070	0 986 435 354	
									0 986 435 359	
	sd xDrive [E 70]	3,0	210	30 6D 5	10.07-09.08	6	DBJ	0 445 115 077	0 986 435 359	
25	d sDrive, d xDrive [F 15]	2,0	160	N47 D20D	12.13-07.15	4	DBJ	0 445 117 030	0 986 435 425	
			170	B47 D20B <B47>	07.15→	4	DBJ	0 445 118 004		
	d xDrive [F 15]	3,0	160	N57 D30A <N57>	07.15→	6	DBJ	0 445 110 595	0 986 435 244	
30	d xDrive [E 70]	3,0	155-190	N57 D30A	04.10-06.13	6	DBJ	0 445 116 024	0 986 435 394	
			173	30 6D 3 <M 57N2>	10.08-03.10	6	DBJ	0 445 115 077	0 986 435 359	
	d xDrive [F 15]	3,0	190-210	N57 D30A <N57>	11.13→	6	DBJ	0 445 110 595	0 986 435 244	
35	d xDrive [E 70]	3,0	210	30 6D 5	10.08-03.10	6	DBJ	0 445 115 077	0 986 435 359	
40	d xDrive [E 70]	3,0	225	N57 D30B <N57Z>	04.10-06.13	6	DBJ	0 445 117 017	0 986 435 411	
	d xDrive [F 15]	3,0	230	N57 D30B	03.14→	6	DBJ	0 445 117 030	0 986 435 425	
<b>Serie X6</b>										
30	d xDrive [E 71]	3,0	155-180	N57 D30A	04.10-06.14	6	DBJ	0 445 116 024	0 986 435 394	
			173	30 6D 3 <M 57N2>	05.08-03.10	6	DBJ	0 445 115 077	0 986 435 359	
	d xDrive [F 16]	3,0	155-210	N57 D30A	11.14→	6	DBJ	0 445 110 595	0 986 435 244	
35	d xDrive [E 71]	3,0	210	30 6D 5	05.08-03.10	6	DBJ	0 445 115 077	0 986 435 359	
40	d xDrive [E 71]	3,0	225	N57 D30B <N57Z>	04.10-06.14	6	DBJ	0 445 117 017	0 986 435 411	
	d xDrive [F 16]	3,0	230	N57 D30B	12.14→	6	DBJ	0 445 117 030	0 986 435 425	
<b>Serie 1</b>										
114	d [F 20]	1,5	70	B37 D15A	07.15→	3	DBJ	0 445 110 598		
		1,6	70	N47 D16A	11.12-05.15	4	DBJ	0 445 110 599	0 986 435 253	
	d [F 21]	1,5	70	B37 D15A	07.15→	3	DBJ	0 445 110 598		
		1,6	70	N47 D16A	11.12-05.15	4	DBJ	0 445 110 599	0 986 435 253	
116	d [E 81]	2,0	66-85	N47 D20...	03.09-12.11	4	DBJ	0 445 110 289	0 986 435 179	
									0 986 435 245	
	d [E 87]	2,0	66-85	N47 D20...	03.09-06.11	4	DBJ	0 445 110 289	0 986 435 179	
									0 986 435 245	
	d [F 20]	2,0	85	N47 D20C	09.11-02.15	4	DBJ	0 445 110 289	0 986 435 179	
									0 986 435 245	
	d [F 21]	2,0	85	N47 D20C	09.12-02.15	4	DBJ	0 445 110 289	0 986 435 179	
									0 986 435 245	
	d, d ed [F 20]	1,5	85	B37 D15A	03.15→	3	DBJ	0 445 110 598		
	d, d ed [F 21]	1,5	85	B37 D15A	03.15→	3	DBJ	0 445 110 598		
	d ed [F 20]	1,6	85	N47 D16A	03.12-02.15	4	DBJ	0 445 110 599	0 986 435 253	
	d ed [F 21]	1,6	85	N47 D16A	09.12-02.15	4	DBJ	0 445 110 599	0 986 435 253	
118	d [E 81]	2,0	100-105	N47 D20...	05.07-12.11	4	DBJ	0 445 110 289	0 986 435 179	
									0 986 435 245	
	d [E 87]	2,0	90	20 4D 4 <M 47N>	09.04-03.07	4	DBJ	0 445 110 209	0 986 435 144	





◀ BMW

<b>118 d [E 87]</b>	2,0	100-105	N47 D20...	03.07-06.11	4	DBJ	<b>0 445 110 289</b>	<b>0 986 435 179</b>
								<b>0 986 435 245</b>
d [F 21]	2,0	110	B47 D20A	03.15→	4	DBJ	<b>0 445 110 613</b>	<b>0 986 435 268</b>
d, d xDrive [F 20]	2,0	105	N47 D20C	09.11-02.15	4	DBJ	<b>0 445 110 289</b>	<b>0 986 435 179</b>
								<b>0 986 435 245</b>
		110	B47 D20A	03.15→	4	DBJ	<b>0 445 110 613</b>	<b>0 986 435 268</b>
d, d xDrive [F 21]	2,0	105	N47 D20C	09.12-02.15	4	DBJ	<b>0 445 110 289</b>	<b>0 986 435 179</b>
								<b>0 986 435 245</b>
<b>120 d [E 81]</b>	2,0	120-130	N47 D20...	05.07-08.08	4	DBJ	<b>0 445 116 001</b>	<b>0 986 435 363</b>
				09.08-12.11	4	DBJ,EU3	<b>0 445 116 001</b>	<b>0 986 435 363</b>
					4	DBJ,EU4	<b>0 445 116 024</b>	<b>0 986 435 394</b>
d [E 87]	2,0	120	20 4D 4 <M 47N>	09.04-03.07	4	DBJ	<b>0 445 110 216</b>	<b>0 986 435 091</b>
		120-130	N47 D20...	03.07-08.08	4	DBJ	<b>0 445 116 001</b>	<b>0 986 435 363</b>
				09.08-06.11	4	DBJ,EU3	<b>0 445 116 001</b>	<b>0 986 435 363</b>
					4	DBJ,EU4	<b>0 445 116 024</b>	<b>0 986 435 394</b>
d, d xDrive [F 20]	2,0	135-147	N47 D20C	09.11-02.15	4	DBJ	<b>0 445 110 595</b>	<b>0 986 435 244</b>
		140-151	B47 D20A	03.15→	4	DBJ	<b>0 445 110 570</b>	<b>0 986 435 269</b>
d, d xDrive [F 21]	2,0	135-147	N47 D20C	11.12-02.15	4	DBJ	<b>0 445 110 595</b>	<b>0 986 435 244</b>
		140-151	B47 D20A	03.15→	4	DBJ	<b>0 445 110 570</b>	<b>0 986 435 269</b>
<b>123 d [E 81]</b>	2,0	150	N47 D20...	09.07-12.11	4	DBJ	<b>0 445 117 017</b>	<b>0 986 435 411</b>
d [E 87]	2,0	150	N47 D20...	09.07-06.11	4	DBJ	<b>0 445 117 017</b>	<b>0 986 435 411</b>
<b>125 d [F 20]</b>	2,0	155-160	N47 D20D	03.12-02.15	4	DBJ	<b>0 445 117 030</b>	<b>0 986 435 425</b>
		165	B47 D20B <B47>	03.15→	4	DBJ	<b>0 445 118 004</b>	
d [F 21]	2,0	155-160	N47 D20D	09.12-02.15	4	DBJ	<b>0 445 117 030</b>	<b>0 986 435 425</b>
		165	B47 D20B <B47>	03.15→	4	DBJ	<b>0 445 118 004</b>	
<b>Serie 1 Cabrio</b>								
<b>118 d [E 88]</b>	2,0	100-105	N47 D20...	09.08-10.13	4	DBJ	<b>0 445 110 289</b>	<b>0 986 435 179</b>
								<b>0 986 435 245</b>
<b>120 d [E 88]</b>	2,0	120-130	N47 D20...	03.08-08.08	4	DBJ	<b>0 445 116 001</b>	<b>0 986 435 363</b>
				09.08-10.13	4	DBJ,EU3	<b>0 445 116 001</b>	<b>0 986 435 363</b>
					4	DBJ,EU4	<b>0 445 116 024</b>	<b>0 986 435 394</b>
<b>123 d [E 88]</b>	2,0	150	N47 D20...	09.08-09.13	4	DBJ	<b>0 445 117 017</b>	<b>0 986 435 411</b>
<b>Serie 1 Coupé</b>								
<b>118 d [E 82]</b>	2,0	100-105	N47 D20C	09.09-10.13	4	DBJ	<b>0 445 110 289</b>	<b>0 986 435 179</b>
								<b>0 986 435 245</b>
<b>120 d [E 82]</b>	2,0	120-130	N47 D20...	10.07-08.08	4	DBJ	<b>0 445 116 001</b>	<b>0 986 435 363</b>
				09.08-10.13	4	DBJ,EU3	<b>0 445 116 001</b>	<b>0 986 435 363</b>
					4	DBJ,EU4	<b>0 445 116 024</b>	<b>0 986 435 394</b>
<b>123 d [E 82]</b>	2,0	150	N47 D20...	10.07-09.13	4	DBJ	<b>0 445 117 017</b>	<b>0 986 435 411</b>
<b>Serie 2 Active Tourer</b>								
<b>214 d [F 45]</b>	1,5	70	B37 C15A	03.15→	3	DBJ	<b>0 445 110 598</b>	
<b>216 d [F 45]</b>	1,5	85	B37 C15A	11.14→	3	DBJ	<b>0 445 110 598</b>	
			B37 C15A <B37B>	02.18→	3	DBJ	<b>0 445 110 819</b>	
<b>218 d [F 45]</b>	2,0	100-110	B47 C20A	09.14-02.17	4	DBJ	<b>0 445 110 570</b>	<b>0 986 435 269</b>
				03.17→	4	DBJ	<b>0 445 110 613</b>	<b>0 986 435 268</b>
d, d xDrive [F 45]	2,0	110	B47 C20B <B47B>	02.18→	4	DBJ	<b>0 445 110 818</b>	
<b>220 d, d xDrive [F 45]</b>	2,0	120-140	B47 C20A	11.14→	4	DBJ	<b>0 445 110 570</b>	<b>0 986 435 269</b>
		140	B47 C20B <B47D>	02.18→	4	DBJ	<b>0 445 110 814</b>	
<b>Serie 2 Cabrio</b>								
<b>218 d [F 23]</b>	2,0	100-110	B47 D20A	07.15→	4	DBJ	<b>0 445 110 613</b>	<b>0 986 435 268</b>
<b>220 d [F 23]</b>	2,0	120-155	B47 D20A	11.14→	4	DBJ	<b>0 445 110 570</b>	<b>0 986 435 269</b>
<b>225 d [F 23]</b>	2,0	165	B47 D20B <B47>	07.15→	4	DBJ	<b>0 445 118 004</b>	
<b>Serie 2 Coupé</b>								
<b>218 d [F 22]</b>	2,0	100-110	B47 D20A	07.15→	4	DBJ	<b>0 445 110 613</b>	<b>0 986 435 268</b>
		105	N47 D20C	03.14-06.15	4	DBJ	<b>0 445 110 289</b>	<b>0 986 435 179</b>
								<b>0 986 435 245</b>
<b>220 d [F 22]</b>	2,0	120-147	N47 D20C	03.14-10.14	4	DBJ	<b>0 445 110 595</b>	<b>0 986 435 244</b>
d, d xDrive [F 22]	2,0	120-155	B47 D20A	11.14→	4	DBJ	<b>0 445 110 570</b>	<b>0 986 435 269</b>
<b>225 d [F 22]</b>	2,0	160	N47 D20D	03.14-06.15	4	DBJ	<b>0 445 117 030</b>	<b>0 986 435 425</b>
		165	B47 D20B <B47>	07.15→	4	DBJ	<b>0 445 118 004</b>	
<b>Serie 2 Grand Tourer</b>								
<b>214 d [F 46]</b>	1,5	70	B37 C15A	07.15→	3	DBJ	<b>0 445 110 598</b>	
<b>215 d [F 46]</b>	1,5	85	B37 C15A	06.15→	3	DBJ	<b>0 445 110 598</b>	







216 d [F 46]	1,5	85	B37 C15A <B37B>	02.18→	3	DBJ	0 445 110 819			
218 d, d xDrive [F 46]	2,0	100-110	B47 C20A	06.15→	4	DBJ	0 445 110 613	0 986 435 268		
		110	B47 C20B <B47B>	02.18→	4	DBJ	0 445 110 818			
220 d, d xDrive [F 46]	2,0	120-140	B47 C20A	06.15→	4	DBJ	0 445 110 570	0 986 435 269		
		140	B47 C20B <B47D>	02.18→	4	DBJ	0 445 110 814			
<b>Serie 3</b>										
316 d [E 90]	2,0	85	N47 D20C	09.09-10.11	4	DBJ	0 445 110 289	0 986 435 179		
								0 986 435 245		
				d [F 30]						
			B47 D20A	03.15→	4	DBJ	0 445 110 613	0 986 435 268		
			N47 D20C	03.12-02.15	4	DBJ	0 445 110 289	0 986 435 179		
								0 986 435 245		
318 d [E 46]	2,0	85	20 4D 4 <M 47N>	03.03-03.05	4	DBJ	0 445 110 149	0 986 435 157		
d [E 90]	2,0	90	20 4D 4 <M 47N>	09.05-09.07	4	DBJ	0 445 110 209	0 986 435 144		
		100-105	N47 D20...	09.07-10.11	4	DBJ	0 445 110 289	0 986 435 179		
								0 986 435 245		
d, d xDrive [F 30]	2,0	105	N47 D20C	03.12-06.15	4	DBJ	0 445 110 289	0 986 435 179		
								0 986 435 245		
		110	B47 D20A	07.15→	4	DBJ	0 445 110 613	0 986 435 268		
320 d [E 46]	2,0	110	20 4D 4 <M 47N>	09.01-03.05	4	DBJ,EU3	0 445 110 131	0 986 435 084		
							4	DBJ,EU4	0 445 110 216	0 986 435 091
d [E 90]	2,0	110/120	20 4D 4 <M 47N>	03.05-09.07	4	DBJ	0 445 110 216	0 986 435 091		
		130	N47 D20...	09.07-08.08	4	DBJ	0 445 116 001	0 986 435 363		
				09.08-03.10	4	DBJ,EU3	0 445 116 001	0 986 435 363		
					4	DBJ,EU4	0 445 116 024	0 986 435 394		
d, d ed, d xDrive [E 90]	2,0	120-135	N47 D20C <N47N>	03.10-12.11	4	DBJ	0 445 110 595	0 986 435 244		
d, d ed, d xDrive [F 30]	2,0	120/135-147	N47 D20C	02.12-03.16	4	DBJ	0 445 110 595	0 986 435 244		
		120/140	B47 D20A	07.15→	4	DBJ	0 445 110 570	0 986 435 269		
d xDrive [E 90]	2,0	120-130	N47 D20C	09.08-02.10	4	DBJ	0 445 116 024	0 986 435 394		
323 d [F 30]	2,0	160	N47 D20D	03.13-02.16	4	DBJ	0 445 117 030	0 986 435 425		
325 d [E 90]	3,0	145	30 6D 3 <M 57N2>	09.06-02.10	6	DBJ	0 445 110 209	0 986 435 144		
		150	N57 D30A	03.10-10.11	6	DBJ	0 445 116 024	0 986 435 394		
D [F 30]	2,0	165	B47 D20B <B47>	03.16→	4	DBJ	0 445 118 004			
330 d [E 46]	3,0	150	30 6D 2 <M 57N>	03.03-03.05	6	DBJ,EU3	0 445 110 131	0 986 435 084		
							6	DBJ,EU4	0 445 110 216	0 986 435 091
d [F 30]	3,0	190-210	N57 D30A	07.12→	6	DBJ	0 445 110 595	0 986 435 244		
d, d xDrive [E 90]	3,0	180	N57 D30A	09.08-12.11	6	DBJ	0 445 116 024	0 986 435 394		
d, xd [E 46]	3,0	135	30 6D 1 <M 57 D 30>	10.99-04.03	6	DBJ	0 445 110 266	0 986 435 022		
d, xd [E 90]	3,0	170	30 6D 3 <M 57N2>	09.05-09.07	6	DBJ	0 445 115 070	0 986 435 354		
										0 986 435 359
				10.07-08.08	6	DBJ	0 445 115 077	0 986 435 359		
xd [E 46]	3,0	150	30 6D 2 <M 57N>	03.03-03.05	6	DBJ	0 445 110 131	0 986 435 084		
335 d [E 90]	3,0	210	30 6D 5	09.06-05.07	6	DBJ	0 445 115 050	0 986 435 359		
				06.07-10.11	6	DBJ	0 445 115 077	0 986 435 359		
d xDrive [F 30]	3,0	230	N57 D30B <N57Z>	07.13→	6	DBJ	0 445 117 030	0 986 435 425		
<b>Serie 3 Cabrio</b>										
320 d [E 46]	2,0	110	20 4D 4 <M 47N>	01.05-08.06	4	DBJ,EU3	0 445 110 131	0 986 435 084		
							4	DBJ,EU4	0 445 110 216	0 986 435 091
d [E 93]	2,0	120-135	N47 D20C <N47N>	03.10-10.13	4	DBJ	0 445 110 595	0 986 435 244		
		130	N47 D20...	03.08-08.08	4	DBJ	0 445 116 001	0 986 435 363		
				09.08-02.10	4	DBJ,EU3	0 445 116 001	0 986 435 363		
					4	DBJ,EU4	0 445 116 024	0 986 435 394		
325 d [E 93]	3,0	145	30 6D 3 <M 57N2>	09.07-02.10	6	DBJ	0 445 110 209	0 986 435 144		
		150	N57 D30A	03.10-09.13	6	DBJ	0 445 116 024	0 986 435 394		
330 d [E 46]	3,0	150	30 6D 2 <M 57N>	04.05-08.06	6	DBJ,EU3	0 445 110 131	0 986 435 084		
							6	DBJ,EU4	0 445 110 216	0 986 435 091
d [E 93]	3,0	170	30 6D 3 <M 57N2>	03.07-09.07	6	DBJ	0 445 115 070	0 986 435 354		
										0 986 435 359
				10.07-02.09	6	DBJ	0 445 115 077	0 986 435 359		
		180	N57 D30A	03.09-09.13	6	DBJ	0 445 116 024	0 986 435 394		
<b>Serie 3 Compact</b>										
318 td [E 46]	2,0	85	20 4D 4 <M 47N>	03.03-12.04	4	DBJ	0 445 110 149	0 986 435 157		





◀ BMW

<b>320 td</b> [E 46]	2,0	110	20 4D 4 <M 47N>	09.01-12.04	4	DBJ,EU3	<b>0 445 110 131</b>	<b>0 986 435 084</b>
					4	DBJ,EU4	<b>0 445 110 216</b>	<b>0 986 435 091</b>
<b>Serie 3 Coupé</b>								
<b>320 d</b> [E 46]	2,0	110	20 4D 4 <M 47N>	09.03-05.06	4	DBJ,EU3	<b>0 445 110 131</b>	<b>0 986 435 084</b>
					4	DBJ,EU4	<b>0 445 110 216</b>	<b>0 986 435 091</b>
d [E 92]	2,0	130	N47 D20...	03.07-08.08	4	DBJ	<b>0 445 116 001</b>	<b>0 986 435 363</b>
				09.08-02.10	4	DBJ,EU3	<b>0 445 116 001</b>	<b>0 986 435 363</b>
					4	DBJ,EU4	<b>0 445 116 024</b>	<b>0 986 435 394</b>
d, d xDrive [E 92]	2,0	120-135	N47 D20C <N47N>	03.10-06.13	4	DBJ	<b>0 445 110 595</b>	<b>0 986 435 244</b>
d xDrive [E 92]	2,0	130	N47 D20C	09.08-02.10	4	DBJ	<b>0 445 116 024</b>	<b>0 986 435 394</b>
<b>325 d</b> [E 92]	3,0	145	30 6D 3 <M 57N2>	03.07-02.10	6	DBJ	<b>0 445 110 209</b>	<b>0 986 435 144</b>
		150	N57 D30A	03.10-06.13	6	DBJ	<b>0 445 116 024</b>	<b>0 986 435 394</b>
<b>330 d</b> [E 46]	3,0	150	30 6D 2 <M 57N>	03.03-05.06	6	DBJ,EU3	<b>0 445 110 131</b>	<b>0 986 435 084</b>
					6	DBJ,EU4	<b>0 445 110 216</b>	<b>0 986 435 091</b>
d, d xDrive [E 92]	3,0	180	N57 D30A	09.08-06.13	6	DBJ	<b>0 445 116 024</b>	<b>0 986 435 394</b>
d, xd [E 92]	3,0	170	30 6D 3 <M 57N2>	09.06-09.07	6	DBJ	<b>0 445 115 070</b>	<b>0 986 435 354</b>
								<b>0 986 435 359</b>
				10.07-08.08	6	DBJ	<b>0 445 115 077</b>	<b>0 986 435 359</b>
<b>335 d</b> [E 92]	3,0	210	30 6D 5	09.06-05.07	6	DBJ	<b>0 445 115 050</b>	<b>0 986 435 359</b>
				06.07-03.13	6	DBJ	<b>0 445 115 077</b>	<b>0 986 435 359</b>
<b>Serie 3 GT</b>								
<b>318 d</b> [F 34]	2,0	105	N47 D20C	06.13-06.15	4	DBJ	<b>0 445 110 289</b>	<b>0 986 435 179</b>
								<b>0 986 435 245</b>
		110	B47 D20A	07.15-02.17	4	DBJ	<b>0 445 110 570</b>	<b>0 986 435 269</b>
				03.17→	4	DBJ	<b>0 445 110 613</b>	<b>0 986 435 268</b>
<b>320 d, d xDrive</b> [F 34]	2,0	120-135	N47 D20C	06.13-06.15	4	DBJ	<b>0 445 110 595</b>	<b>0 986 435 244</b>
		120-140	B47 D20A	07.15→	4	DBJ	<b>0 445 110 570</b>	<b>0 986 435 269</b>
<b>325 d</b> [F 34]	2,0	160	N47 D20D	07.13-06.16	4	DBJ	<b>0 445 117 030</b>	<b>0 986 435 425</b>
		165	B47 D20B <B47>	07.16→	4	DBJ	<b>0 445 118 004</b>	
<b>330 d, d xDrive</b> [F 34]	3,0	190-210	N57 D30A <N57>	03.14→	6	DBJ	<b>0 445 110 595</b>	<b>0 986 435 244</b>
<b>335 d xDrive</b> [F 34]	3,0	230	N57 D30B	03.14→	6	DBJ	<b>0 445 117 030</b>	<b>0 986 435 425</b>
<b>Serie 3 Touring</b>								
<b>316 d</b> [E 91]	2,0	85	N47 D20C <N47N>	03.10-05.12	4	DBJ	<b>0 445 110 289</b>	<b>0 986 435 179</b>
								<b>0 986 435 245</b>
d [F 31]	2,0	85	B47 D20A	03.15→	4	DBJ	<b>0 445 110 613</b>	<b>0 986 435 268</b>
			N47 D20C	11.12-02.15	4	DBJ	<b>0 445 110 289</b>	<b>0 986 435 179</b>
								<b>0 986 435 245</b>
<b>318 d</b> [E 46]	2,0	85	20 4D 4 <M 47N>	03.03-09.05	4	DBJ	<b>0 445 110 149</b>	<b>0 986 435 157</b>
d [E 91]	2,0	90	20 4D 4 <M 47N>	03.06-09.07	4	DBJ	<b>0 445 110 209</b>	<b>0 986 435 144</b>
		100-105	N47 D20...	09.07-05.12	4	DBJ	<b>0 445 110 289</b>	<b>0 986 435 179</b>
								<b>0 986 435 245</b>
d, d xDrive [F 31]	2,0	105	N47 D20C	11.12-06.15	4	DBJ	<b>0 445 110 289</b>	<b>0 986 435 179</b>
								<b>0 986 435 245</b>
		110	B47 D20A	07.15→	4	DBJ	<b>0 445 110 613</b>	<b>0 986 435 268</b>
<b>320 d</b> [E 46]	2,0	110	20 4D 4 <M 47N>	09.01-09.05	4	DBJ,EU3	<b>0 445 110 131</b>	<b>0 986 435 084</b>
					4	DBJ,EU4	<b>0 445 110 216</b>	<b>0 986 435 091</b>
d [E 91]	2,0	110/120	20 4D 4 <M 47N>	09.05-08.07	4	DBJ	<b>0 445 110 216</b>	<b>0 986 435 091</b>
		130	N47 D20...	09.07-08.08	4	DBJ	<b>0 445 116 001</b>	<b>0 986 435 363</b>
				09.08-02.10	4	DBJ,EU3	<b>0 445 116 001</b>	<b>0 986 435 363</b>
					4	DBJ,EU4	<b>0 445 116 024</b>	<b>0 986 435 394</b>
d, d ed, d xDrive [E 91]	2,0	120-135	N47 D20C <N47N>	03.10-05.12	4	DBJ	<b>0 445 110 595</b>	<b>0 986 435 244</b>
d, d ed, d xDrive [F 31]	2,0	120/135-147	N47 D20C	09.12-02.16	4	DBJ	<b>0 445 110 595</b>	<b>0 986 435 244</b>
		120/140	B47 D20A	07.15→	4	DBJ	<b>0 445 110 570</b>	<b>0 986 435 269</b>
d xDrive [E 91]	2,0	120-130	N47 D20C	09.08-02.10	4	DBJ	<b>0 445 116 024</b>	<b>0 986 435 394</b>
<b>325 d</b> [E 91]	3,0	145	30 6D 3 <M 57N2>	09.06-02.10	6	DBJ	<b>0 445 110 209</b>	<b>0 986 435 144</b>
		150	N57 D30A	03.10-05.12	6	DBJ	<b>0 445 116 024</b>	<b>0 986 435 394</b>
d [F 31]	2,0	160	N47 D20D	03.13-02.16	4	DBJ	<b>0 445 117 030</b>	<b>0 986 435 425</b>
		165	B47 D20B <B47>	03.16→	4	DBJ	<b>0 445 118 004</b>	
<b>330 d</b> [E 46]	3,0	150	30 6D 2 <M 57N>	03.03-09.05	6	DBJ,EU3	<b>0 445 110 131</b>	<b>0 986 435 084</b>
					6	DBJ,EU4	<b>0 445 110 216</b>	<b>0 986 435 091</b>
d, d xDrive [E 91]	3,0	180	N57 D30A	09.08-05.12	6	DBJ	<b>0 445 116 024</b>	<b>0 986 435 394</b>







330 d, d xDrive [F 31]	3,0	190-210	N57 D30A	09.12→	6	DBJ	0 445 110 595	0 986 435 244	
d, xd [E 46]	3,0	135	30 6D 1 <M 57 D 30>	10.99-03.03	6	DBJ	0 445 110 266	0 986 435 022	F 00V C17 504
d, xd [E 91]	3,0	170	30 6D 3 <M 57N2>	09.05-09.07	6	DBJ	0 445 115 070	0 986 435 354	
								0 986 435 359	
				10.07-08.08	6	DBJ	0 445 115 077	0 986 435 359	
xd [E 46]	3,0	150	30 6D 2 <M 57N>	03.03-09.05	6	DBJ	0 445 110 131	0 986 435 084	
335 d [E 91]	3,0	210	30 6D 5	09.06-05.07	6	DBJ	0 445 115 050	0 986 435 359	
				06.07-05.12	6	DBJ	0 445 115 077	0 986 435 359	
d xDrive [F 31]	3,0	230	N57 D30B	11.13→	6	DBJ	0 445 117 030	0 986 435 425	
<b>Serie 4 Cabrio</b>									
420 d [F 33]	2,0	120-135	N47 D20C	03.14-06.15	4	DBJ	0 445 110 595	0 986 435 244	
		120-140	B47 D20A	07.15→	4	DBJ	0 445 110 570	0 986 435 269	
425 d [F 33]	2,0	160	N47 D20D	06.14-02.16	4	DBJ	0 445 117 030	0 986 435 425	
		165	B47 D20B <B47>	03.16→	4	DBJ	0 445 118 004		
430 d [F 33]	3,0	190-210	N57 D30A	06.14→	6	DBJ	0 445 110 595	0 986 435 244	
435 d [F 33]	3,0	230	N57 D30B	06.14→	6	DBJ	0 445 117 030	0 986 435 425	
<b>Serie 4 Coupé</b>									
418 d [F 32]	2,0	100-110	B47 D20A	03.15→	4	DBJ	0 445 110 613	0 986 435 268	
420 d [F 32]	2,0	120-140	B47 D20A	03.15-02.17	4	DBJ	0 445 110 570	0 986 435 269	
				03.17→	4	DBJ	0 445 110 613	0 986 435 268	
d, d xDrive [F 32]	2,0	120-135	N47 D20C	09.13-02.15	4	DBJ	0 445 110 595	0 986 435 244	
425 d [F 32]	2,0	160	N47 D20D	03.14-02.16	4	DBJ	0 445 117 030	0 986 435 425	
		165	B47 D20B <B47>	03.16→	4	DBJ	0 445 118 004		
430 d, d xDrive [F 32]	3,0	190-210	N57 D30A; N57 D30A <N57>	11.13→	6	DBJ	0 445 110 595	0 986 435 244	
435 d xDrive [F 32]	3,0	230	N57 D30B <N57Z>	11.13→	6	DBJ	0 445 117 030	0 986 435 425	
<b>Serie 4 GC</b>									
418 d [F 36]	2,0	100-105	N47 D20C	05.14-06.15	4	DBJ	0 445 110 289	0 986 435 179	
		100-110	B47 D20A	07.15→	4	DBJ	0 445 110 613	0 986 435 268	
420 d, d xDrive [F 36]	2,0	120-135	N47 D20C	05.14-03.15	4	DBJ	0 445 110 595	0 986 435 244	
		120-140	B47 D20A	03.15→	4	DBJ	0 445 110 570	0 986 435 269	
425 d [F 36]	2,0	165	B47 D20B <B47>	03.16→	4	DBJ	0 445 118 004		
430 d [F 36]	3,0	190-210	N57 D30A	06.14→	6	DBJ	0 445 110 595	0 986 435 244	
d xDrive [E 36]	3,0	190-210	N57 D30A	06.14→	6	DBJ	0 445 110 595	0 986 435 244	
435 d xDrive [F 36]	3,0	230	N57 D30B	06.14→	6	DBJ	0 445 117 030	0 986 435 425	
<b>Serie 5</b>									
518 d [F 10]	2,0	100-105	N47 D20C <N47N>	07.13-06.14	4	DBJ	0 445 110 595	0 986 435 244	
		100-110	B47 D20A	06.14-10.16	4	DBJ	0 445 110 570	0 986 435 269	
d [G 30]	2,0	140	B47 D20B <B47D>	06.18→	4	DBJ	0 445 110 818		
520 d [E 60]	2,0	110/120	20 4D 4 <M 47N>	09.05-02.08	4	DBJ	0 445 110 216	0 986 435 091	
		120-130	N47 D20...	09.07-08.08	4	DBJ	0 445 116 001	0 986 435 363	
				09.08-02.10	4	DBJ,EU3	0 445 116 001	0 986 435 363	
					4	DBJ,EU4	0 445 116 024	0 986 435 394	
d, d ed, d xDrive [F 10]	2,0	135	N47 D20C <N47N>	05.10-10.16	4	DBJ	0 445 110 595	0 986 435 244	
d, d ed, d xDrive [G 30]	2,0	140	B47 D20A	02.17→	4	DBJ	0 445 110 570	0 986 435 269	
d, d xDrive [F 10]	2,0	120-155	B47 D20A	06.14-10.16	4	DBJ	0 445 110 570	0 986 435 269	
d, d xDrive [G 30]	2,0	140	B47 D20B <B47D>	06.18→	4	DBJ	0 445 110 814		
525 d [E 39]	2,5	120	25 6D 1	04.00-07.03	6	DBJ	0 445 110 048	0 986 435 094	F 00V C17 504
d [E 60]	2,5	120/130	25 6D 2	05.04-03.07	6	DBB	0 445 110 212	0 986 435 151	
d [F 10]	3,0	150	N57 D30A	03.10-08.11	6	DBJ	0 445 116 024	0 986 435 394	
d [G 30]	2,0	170	B47 D20B <B47>	06.17→	4	DBJ	0 445 118 004		
d, d xDrive [F 10]	2,0	160	N47 D20D <N47S1>	09.11-10.16	4	DBJ	0 445 117 030	0 986 435 425	
d, d xDrive, xd [E 60]	3,0	145	30 6D 3 <M 57N2>	03.07-02.10	6	DBJ	0 445 110 209	0 986 435 144	
530 d [E 39]	3,0	135-142	30 6D 1 <M 57 D 30>	08.98-09.99	6	DBJ,GS	0 445 110 029	0 986 435 010	GS F 00V C17 504
				08.98-03.00	6	AG,DBJ	0 445 110 029	0 986 435 010	GS F 00V C17 504
				09.99-07.03	6	DBJ,GS	0 445 110 029	0 986 435 010	GS F 00V C17 504
				10.99-07.03	6	DBJ,GS	0 445 110 266	0 986 435 022	GS F 00V C17 504
				03.00-07.03	6	DBJ,GS	0 445 110 029	0 986 435 010	AG F 00V C17 504
				04.00-07.03	6	AG,DBJ	0 445 110 266	0 986 435 022	GS F 00V C17 504
d [E 60]	3,0	155-160	30 6D 2 <M 57N>	07.03-09.05	6	DBJ,EU3	0 445 110 131	0 986 435 084	
					6	DBJ,EU4	0 445 110 216	0 986 435 091	





◀ BMW

<b>530 d</b> [F 10]	3,0	180	N57 D30A <N57>	03.10-08.11	6	DBJ	<b>0 445 116 024</b>	<b>0 986 435 394</b>	
d, d xDrive [F 10]	3,0	190-210	N57 D30A	03.11-10.16	6	DBJ	<b>0 445 110 595</b>	<b>0 986 435 244</b>	
d, d xDrive [G 30]	3,0	195	B57 D30A	02.17→	6	DBJ	<b>0 445 118 023</b>		
d, d xDrive, xd [E 60]	3,0	173	30 6D 3 <M 57N2>	03.07-02.10	6	DBJ	<b>0 445 115 050</b>	<b>0 986 435 359</b>	
d, xd [E 60]	3,0	170	30 6D 3 <M 57N2>	09.05-03.07	6	DBJ	<b>0 445 115 070</b>	<b>0 986 435 354</b>	
								<b>0 986 435 359</b>	
<b>535 d</b> [E 60]	3,0	200	30 6D 4	09.04-03.07	6	DBJ	<b>0 445 110 219</b>	<b>0 986 435 092</b>	
		210	30 6D 5	03.07-02.10	6	DBJ	<b>0 445 115 050</b>	<b>0 986 435 359</b>	
d [F 10]	3,0	220	N57 D30B <N57S>	09.10-08.11	6	DBJ	<b>0 445 117 017</b>	<b>0 986 435 411</b>	
d, d xDrive [F 10]	3,0	230	N57 D30B <N57Z>	09.11-10.16	6	DBJ	<b>0 445 117 030</b>	<b>0 986 435 425</b>	
<b>540 d xDrive</b> [G 30]	3,0	235	B57 D30B	06.17→	6	DBJ	<b>0 445 118 004</b>		
<b>Serie 5 GT</b>									
<b>520 d</b> [F 07]	2,0	120-135	N47 D20C	07.12-02.17	4	DBJ	<b>0 445 110 595</b>	<b>0 986 435 244</b>	
<b>530 d</b> [F 07]	3,0	155	N57 D30A	09.10-06.12	6	DBJ	<b>0 445 116 024</b>	<b>0 986 435 394</b>	
d, d xDrive [F 07]	3,0	180	N57 D30A <N57>	10.09-06.12	6	DBJ	<b>0 445 116 024</b>	<b>0 986 435 394</b>	
		190	N57 D30A	07.12-02.17	6	DBJ	<b>0 445 110 595</b>	<b>0 986 435 244</b>	
<b>535 d, d xDrive</b> [F 07]	3,0	220	N57 D30B <N57S>	03.10-06.12	6	DBJ	<b>0 445 117 017</b>	<b>0 986 435 411</b>	
		230	N57 D30B <N57Z>	07.12-02.17	6	DBJ	<b>0 445 117 030</b>	<b>0 986 435 425</b>	
<b>Serie 5 Touring</b>									
<b>M 550 d xDrive</b> [G 31]	3,0	294	B57 D30C	11.17→	6	DBJ	<b>0 445 118 010</b>		
<b>518 d</b> [F 11]	2,0	100-105	N47 D20C <N47N>	07.13-06.14	4	DBJ	<b>0 445 110 595</b>	<b>0 986 435 244</b>	
		100-110	B47 D20A	06.14-02.17	4	DBJ	<b>0 445 110 570</b>	<b>0 986 435 269</b>	
d [G 31]	2,0	140	B47 D20B <B47D>	06.18→	4	DBJ	<b>0 445 110 818</b>		
<b>520 d</b> [E 61]	2,0	110/120	20 4D 4 <M 47N>	09.05-02.08	4	DBJ	<b>0 445 110 216</b>	<b>0 986 435 091</b>	
		120-130	N47 D20...	09.07-08.08	4	DBJ	<b>0 445 116 001</b>	<b>0 986 435 363</b>	
				09.08-08.10	4	DBJ,EU3	<b>0 445 116 001</b>	<b>0 986 435 363</b>	
					4	DBJ,EU4	<b>0 445 116 024</b>	<b>0 986 435 394</b>	
d, d xDrive [F 11]	2,0	120-140	B47 D20A	06.14-02.17	4	DBJ	<b>0 445 110 570</b>	<b>0 986 435 269</b>	
		135	N47 D20C <N47N>	09.10-10.16	4	DBJ	<b>0 445 110 595</b>	<b>0 986 435 244</b>	
d, d xDrive [G 31]	2,0	140	B47 D20A	06.17→	4	DBJ	<b>0 445 110 570</b>	<b>0 986 435 269</b>	
			B47 D20B <B47D>	06.18→	4	DBJ	<b>0 445 110 814</b>		
<b>525 d</b> [E 39]	2,5	120	25 6D 1	04.00-05.04	6	DBJ	<b>0 445 110 048</b>	<b>0 986 435 094</b>	<b>F 00V C17 504</b>
d [E 61]	2,5	120/130	25 6D 2	05.04-03.07	6	DBB	<b>0 445 110 212</b>	<b>0 986 435 151</b>	
d [F 11]	3,0	150	N57 D30A	09.10-08.11	6	DBJ	<b>0 445 116 024</b>	<b>0 986 435 394</b>	
d, d xDrive [F 11]	2,0	155-160	N47 D20D <N47S1>	09.11-02.17	4	DBJ	<b>0 445 117 030</b>	<b>0 986 435 425</b>	
d, d xDrive, xd [E 61]	3,0	145	30 6D 3 <M 57N2>	03.07-08.10	6	DBJ	<b>0 445 110 209</b>	<b>0 986 435 144</b>	
<b>528 d</b> [G 31]	2,0	170	B47 D20B <B47>	06.17→	4	DBJ	<b>0 445 118 004</b>		
<b>530 d</b> [E 39]	3,0	135-142	30 6D 1 <M 57 D 30>	08.98-09.99	6	DBJ,GS	<b>0 445 110 029</b>	<b>0 986 435 010</b>	GS <b>F 00V C17 504</b>
				08.98-03.00	6	AG,DBJ	<b>0 445 110 029</b>	<b>0 986 435 010</b>	GS <b>F 00V C17 504</b>
				09.99-05.04	6	DBJ,GS	<b>0 445 110 029</b>	<b>0 986 435 010</b>	GS <b>F 00V C17 504</b>
				10.99-05.04	6	DBJ,GS	<b>0 445 110 266</b>	<b>0 986 435 022</b>	GS <b>F 00V C17 504</b>
				03.00-05.04	6	DBJ,GS	<b>0 445 110 029</b>	<b>0 986 435 010</b>	AG <b>F 00V C17 504</b>
				04.00-05.04	6	AG,DBJ	<b>0 445 110 266</b>	<b>0 986 435 022</b>	GS <b>F 00V C17 504</b>
d [E 61]	3,0	160	30 6D 2 <M 57N>	05.04-09.05	6	DBJ,EU3	<b>0 445 110 131</b>	<b>0 986 435 084</b>	
					6	DBJ,EU4	<b>0 445 110 216</b>	<b>0 986 435 091</b>	
d [F 11]	3,0	180	N57 D30A <N57>	09.10-08.11	6	DBJ	<b>0 445 116 024</b>	<b>0 986 435 394</b>	
d, d xDrive [F 11]	3,0	190-210	N57 D30A	03.11-02.17	6	DBJ	<b>0 445 110 595</b>	<b>0 986 435 244</b>	
d, d xDrive [G 31]	3,0	195	B57 D30A	06.17→	6	DBJ	<b>0 445 118 023</b>		
d, d xDrive, xd [E 61]	3,0	173	30 6D 3 <M 57N2>	03.07-08.10	6	DBJ	<b>0 445 115 050</b>	<b>0 986 435 359</b>	
d, xd [E 61]	3,0	155-170	30 6D 3 <M 57N2>	09.05-03.07	6	DBJ	<b>0 445 115 070</b>	<b>0 986 435 354</b>	
								<b>0 986 435 359</b>	
<b>535 d</b> [E 61]	3,0	200	30 6D 4	09.04-03.07	6	DBJ	<b>0 445 110 219</b>	<b>0 986 435 092</b>	
		210	30 6D 5	03.07-08.10	6	DBJ	<b>0 445 115 050</b>	<b>0 986 435 359</b>	
d [F 11]	3,0	220	N57 D30B <N57S>	09.10-08.11	6	DBJ	<b>0 445 117 017</b>	<b>0 986 435 411</b>	
d, d xDrive [F 11]	3,0	230	N57 D30B <N57Z>	09.11-02.17	6	DBJ	<b>0 445 117 030</b>	<b>0 986 435 425</b>	
<b>540 d</b> [G 31]	3,0	235	B57 D30B	06.17→	6	DBJ	<b>0 445 118 004</b>		
<b>Serie 6</b>									
<b>635 d</b> [E 63]	3,0	210	30 6D 5	09.07-07.10	6	DBJ	<b>0 445 115 050</b>	<b>0 986 435 359</b>	
<b>Serie 6 Cabrio</b>									
<b>635 d</b> [E 64]	3,0	210	30 6D 5	09.07-07.10	6	DBJ	<b>0 445 115 050</b>	<b>0 986 435 359</b>	
<b>640 d, d xDrive</b> [F 12]	3,0	230	N57 D30B <N57Z>	09.11→	6	DBJ	<b>0 445 117 030</b>	<b>0 986 435 425</b>	
<b>Serie 6 Coupé</b>									
<b>640 d, d xDrive</b> [F 13]	3,0	230	N57 D30B <N57Z>	10.11→	6	DBJ	<b>0 445 117 030</b>	<b>0 986 435 425</b>	





Serie 6 GC									
640 d, d xDrive [F 06]	3,0	230	N57 D30B <N57Z>	05.12→	6	DBJ	0 445 117 030	0 986 435 425	
Serie 6 GT									
620 d, d xDrive [G 32]	2,0	140	B47 D20B <B47D>	06.18→	4	DBJ	0 445 110 814		
630 d xDrive [G 32]	3,0	195	B57 D30A	10.17→	6	DBJ	0 445 118 023		
640 d xDrive [G 32]	3,0	235	B57 D30B	10.17→	6	DBJ	0 445 118 004		
Serie 7									
725 d [G 11]	2,0	170	B47 D20B <B47>	06.17→	4	DBJ	0 445 118 004		
Ld [G 12]	2,0	170	B47 D20B <B47>	06.17→	4	DBJ	0 445 118 004		
730 d [E 38]	3,0	135-142	30 6D 1 <M 57 D 30>	08.98-03.00	6	DBJ	0 445 110 029	0 986 435 010	F 00V C17 504
				03.00-12.01	6	DBJ	0 445 110 029	0 986 435 010	F 00V C17 504
				04.00-12.01	6	DBJ	0 445 110 266	0 986 435 022	F 00V C17 504
d [E 65]	3,0	160	30 6D 2 <M 57N>	10.02-03.05	6	DBJ	0 445 110 131	0 986 435 084	
		170	30 6D 3 <M 57N2>	04.05-10.08	6	DBJ	0 445 115 070	0 986 435 354	
								0 986 435 359	
d [F 01]	3,0	155-180	N57 D30A	11.08-06.12	6	DBJ	0 445 116 024	0 986 435 394	
d, d xDrive [F 01]	3,0	155-190	N57 D30A	07.12-05.15	6	DBJ	0 445 110 595	0 986 435 244	
d, d xDrive [G 11]	3,0	155-195	B57 D30A	09.15→	6	DBJ	0 445 118 023		
Ld [E 66]	3,0	170	30 6D 3 <M 57N2>	09.05-10.08	6	DBJ	0 445 115 070	0 986 435 354	
								0 986 435 359	
Ld [F 02]	3,0	180	N57 D30A	03.09-06.12	6	DBJ	0 445 116 024	0 986 435 394	
		180-190	N57 D30A	07.12-05.15	6	DBJ	0 445 110 595	0 986 435 244	
Ld, Ld xDrive [G 12]	3,0	155-195	B57 D30A	09.15→	6	DBJ	0 445 118 023		
740 d [E 38]	3,9	180	39 8D 1 <M 67>	10.98-12.01	8	DBJ	0 445 110 028	0 986 435 009	
d [E 65]	3,9	190	39 8D 1 <M 67>	10.02-03.05	8	DBJ	0 445 110 122		
d, d xDrive [F 01]	3,0	225	N57 D30B <N57Z>	09.09-06.12	6	DBJ	0 445 117 017	0 986 435 411	
		230	N57 D30B <N57Z>	07.12-05.15	6	DBJ	0 445 117 030	0 986 435 425	
d xDrive [G 11]	3,0	235	B57 D30B	11.15→	6	DBJ	0 445 118 004		
Ld xDrive [G 12]	3,0	235	B57 D30B	11.15→	6	DBJ	0 445 118 004		
745 d [E 65]	4,4	220/242	44 8D 1	03.05-10.08	8	DBJ	0 445 115 009	0 986 435 421	
750 d xDrive [F 01]	3,0	280	N57 D30C	07.12-05.15	6	DBJ	0 445 118 001		
d xDrive [G 11]	3,0	294	B57 D30C	07.16→	6	DBJ	0 445 118 010		
Ld xDrive [F 02]	3,0	280	N57 D30C	07.12-05.15	6	DBJ	0 445 118 001		
Ld xDrive [G 12]	3,0	294	B57 D30C	07.16→	6	DBJ	0 445 118 010		

## CHEVROLET

Aveo									
1.3 D [T300]	1,2	55	A 13 DTC <LDV>	09.11-12.17	4	DBJ,EU4	0 445 110 325	0 986 435 199	
					4	DBJ,EU5	0 445 110 326	0 986 435 200	
		70	A 13 DT... <LSF>	09.11-12.17	4	DBJ	0 445 110 326	0 986 435 200	
Aveo Hatchback									
1.3 D [T300]	1,2	55	A 13 DTC <LDV>	09.11-12.17	4	DBJ,EU4	0 445 110 325	0 986 435 199	
					4	DBJ,EU5	0 445 110 326	0 986 435 200	
		70	A 13 DT... <LSF>	09.11-12.17	4	DBJ	0 445 110 326	0 986 435 200	
Blazer									
2.8 D Electronic	2,8	103	4.07 TCE <Sprint Euro 3>	08.05-05.09	4	DBB	0 445 110 231		
Captiva									
2.0 CDRI, CDRI 4x4 [C100]	2,0	93/110	Z20S	10.06-02.11	4	DBJ	0 445 110 269	0 986 435 153	
								0 986 435 238	
CRDi 4x4 [GMT193]	2,0	110	RA420	01.09→	4	DBJ	0 445 110 269	0 986 435 153	
								0 986 435 238	
Cruze									
2.0 CDI [J300]	2,0	110	Z20S1	05.09-12.11	4	DBJ	0 445 110 269	0 986 435 153	
								0 986 435 238	
Epica									
2.0 CDRI [V250]	2,0	110	Z20S	09.06-12.11	4	DBJ	0 445 110 269	0 986 435 153	
								0 986 435 238	



◀ CHEVROLET

Lacetti										
2.0 D [J200]	2,0	89	Z20S	09.06-04.13	4	DBJ	0 445 110 269	0 986 435 153		
								0 986 435 238		
Malibu										
2.0 CDRI [V300]	2,0	118	LBS <Euro 5>	06.12-12.15	4	DBB	0 445 110 327	0 986 435 201	F 00V C17 504	
Nubira										
2.0 D [J200]	2,0	89	Z20S	09.06-04.13	4	DBJ	0 445 110 269	0 986 435 153		
								0 986 435 238		
Nubira Wagon										
2.0 D [J200]	2,0	89	Z20S	09.06-04.13	4	DBJ	0 445 110 269	0 986 435 153		
								0 986 435 238		
Silverado 3500										
6.6	6,6	224-231	LB7	09.00-08.04	8	DBJ	0 445 120 008	0 986 435 502		
4x4	6,6	269	LBZ	09.06-08.07	8	DBJ	0 445 120 082	0 986 435 520		

**CHRYSLER**

Grand Voyager										
2.8 [RS]	2,8	120	ENS	09.08→	4	DBJ	0 445 115 067	0 986 435 402		
PT Cruiser										
2.2 CRD [PT]	2,2	89	EDJ	09.02-12.05	4				1 987 972 076	
Voyager										
2.5 CRD, CRD 4x4 [RG]	2,5	105	ENC; ENJ	09.00-08.07	4	DBJ	0 445 110 059	0 986 435 149		
2.8 CRD [RT]	2,8	120	ENS	09.08→	4	DBJ	0 445 115 067	0 986 435 402		
CRD, CRD 4x4 [RG]	2,8	110	ENR	08.04-12.07	4	DBJ	0 445 110 059	0 986 435 149		
300C										
3.0 CRD [LE]	3,0	160	EXL	09.08-08.09	6	DBB	0 445 115 063	0 986 435 355		
300C Touring										
3.0 CRD [LE]	3,0	160	EXL	09.08-08.09	6	DBB	0 445 115 063	0 986 435 355		

**CITROEN**

Berlingo										
1.6 BlueHDi [B9]	1,6	55	BHW <DV6FE>	03.15→	4	DBJ	0 445 110 565		F 00V C17 504	
		73	BHY <DV6FD>	12.14→	4	DBJ	0 445 110 565		F 00V C17 504	
		88	BHZ <DV6FC>	12.14→	4	DBJ	0 445 110 565		F 00V C17 504	
Hdi [B9]	1,6	55	9HT <DV6B/DV6BUTED4>	05.08-11.11	4	DBJ	0 445 110 311	0 986 435 146	F 00V C17 504	
		55-66	9HX <DV6ATED4/DV6AUTED4>	05.08-11.11	4	DBJ	0 445 110 311	0 986 435 146	F 00V C17 504	
		55/66/68	9HF <DV6DTE4>; 9HJ <DV6DTE4 M>; 9HK <DV6ETED M>; 9HN <DV6ETED4>; 9HP <DV6DTE4>	07.10-12.16	4	DBJ	0 445 110 340	0 986 435 203	F 00V C17 504	
		66	9HS <DV6TED4BU/FAP>; 9HV <DV6TED4/FAP>	10.08-11.11	4	DBJ	0 445 110 297	0 986 435 150	F 00V C17 504	
		80	9HZ <DV6TED4>	05.08-11.11	4	DBJ	0 445 110 297	0 986 435 150	F 00V C17 504	
Hdi [M59]	1,6	55/66	9HW <DV6B>; 9HX <DV6ATED4>	07.05-10.11	4	DBJ	0 445 110 239	0 986 435 122	F 00V C17 504	
2.0 Hdi [M49]	2,0	66	RHY <DW10TD>							
			Org.-Nr. →8728	12.99-10.00	4	DBB,I2G	0 445 110 044	0 986 435 003		
					4	DBJ,I1B	0 445 110 008	0 986 435 003		
			Org.-Nr. 8729→	11.00-11.02	4	DBB,I1B, I2G	0 445 110 062	0 986 435 077		
HDI	2,0	66	DW10TD	10.00→	4	DBB	0 445 110 044	0 986 435 003		
C-Crosser										
2.2 Hdi 4x4 [I4]	2,2	115	4HK <DW12ME5>; 4HN <DW12METED4/FAP>	09.07-01.13	4	DBB	0 445 115 025	0 986 435 450		
C-Elysee										
1.5 Blue HDi	1,5	75	YHY <DV5RD>	04.18→	4	DBJ	0 445 110 749		F 00V C17 504	
1.6 BlueHDi	1,6	73	BHY <DV6FD>	04.15→	4	DBJ	0 445 110 565		F 00V C17 504	
		68	9HJ <DV6DTE4 M>; 9HP <DV6DTE4>	09.12→	4	DBJ	0 445 110 340	0 986 435 203	F 00V C17 504	
				09.12→	4	DBJ	0 445 110 340	0 986 435 203	F 00V C17 504	



C2										
1.4 HDi [A6]	1,4	50	8H... <DV4TD>	09.03-12.09	4	BO,DBJ, FL5	0 445 110 252	0 986 435 143		
					4	BO,DBJ, N14	0 445 110 135	0 986 435 085		
1.6 HDi [A6]	1,6	80	9HZ <DV6TED4>	07.07-05.09	4	DBJ	0 445 110 297	0 986 435 150	F 00V C17 504	
C3										
1.4 HDi	1,4	52	8HW <DV4TD>	07.03-07.12	4	BO,DBJ, N14	0 445 110 135	0 986 435 085		
HDi [A8]	1,4	50	8H... <DV4TD>	01.02-08.05	4	BO,DBJ	0 445 110 135	0 986 435 085		
HDi [A31]	1,4	50	8HZ <DV4TD>	09.05-09.09	4	BO,DBJ, FL5	0 445 110 252	0 986 435 143		
									4	BO,DBJ, N14
HDi [A51]	1,4	50	8H... <DV4C>	06.10-12.15	4	DBJ	0 445 110 339	0 986 435 172	F 00V C17 504	
			8HZ <DV4TD>	09.09-12.15	4	DBJ	0 445 110 252	0 986 435 143		
1.5 Blue HDi [B618]	1,5	75	YHY <DV5RD>	04.18→	4	DBJ	0 445 110 749	F 00V C17 504		
1.6 BlueHDi [A51]	1,6	55/73	BHW <DV6FE>; BHY <DV6FD>	04.14-12.16	4	DBJ	0 445 110 565	F 00V C17 504		
BlueHDi [B618]	1,6	55	BHW <DV6FE>	07.16→	4	DBJ	0 445 110 565	F 00V C17 504		
HDi [A31]	1,6	66	9HX <DV6ATED4>	09.05-12.09	4			F 00V C17 504		
			Org.-Nr. →11143	09.05-05.07	4	DBJ	0 445 110 239	0 986 435 122		
			Org.-Nr. 11144→	06.07-12.09	4	DBJ	0 445 110 311	0 986 435 146		
		80	9HZ <DV6TED4>	09.05-05.09	4			F 00V C17 504		
			Org.-Nr. →11143	09.05-05.07	4	DBJ	0 445 110 259	0 986 435 126		
			Org.-Nr. 11144→	06.07-05.09	4	DBJ	0 445 110 297	0 986 435 150		
HDi [A51]	1,6	55	9HK <DV6ETED M>	01.12-12.15	4	DBJ	0 445 110 340	0 986 435 203	F 00V C17 504	
			9HX <DV6ATED4>	09.09-12.14	4	DBJ	0 445 110 311	0 986 435 146	F 00V C17 504	
			9HJ <DV6DTED M>	01.12-12.15	4	DBJ	0 445 110 340	0 986 435 203	F 00V C17 504	
			9HP <DV6DTED>	01.10-12.15	4	DBJ	0 445 110 340	0 986 435 203	F 00V C17 504	
HDi [B618]	1,6	66	9HJ <DV6DTED M>	09.16→	4	DBJ	0 445 110 340	0 986 435 203	F 00V C17 504	
C3 Aircross										
1.6 BlueHDi [A88]	1,6	73	BHY <DV6FD>	06.17→	4	DBJ	0 445 110 565	F 00V C17 504		
			BHX <DV6FC>	06.17→	4	DBJ	0 445 110 565	F 00V C17 504		
			BHZ <DV6FC>	06.17→	4	DBJ	0 445 110 565	F 00V C17 504		
HDi [A88]	1,6	68	9HP <DV6DTED>	10.17→	4	DBJ	0 445 110 340	0 986 435 203	F 00V C17 504	
C3 Picasso										
1.6 BlueHDi [A58]	1,6	73	BHY <DV6FD>	01.15→	4	DBJ	0 445 110 565	F 00V C17 504		
HDi [A58]	1,6	66	9HX <DV6ATED4>	02.09-12.11	4	DBJ	0 445 110 311	0 986 435 146	F 00V C17 504	
			9HP <DV6DTED>	03.10→	4	DBJ	0 445 110 340	0 986 435 203	F 00V C17 504	
			9HZ <DV6TED4 FAP>	02.09-12.11	4	DBJ	0 445 110 297	0 986 435 150	F 00V C17 504	
C3-Pluriel										
1.4 HDi [A42]	1,4	50	8H... <DV4TD>	10.03-01.10	4	BO,DBJ	0 445 110 252	0 986 435 143		
C4										
1.6 BlueHDi [B71]	1,6	73	BHY <DV6FD>	04.14→	4	DBJ	0 445 110 565	F 00V C17 504		
			BHX <DV6FC>	04.14→	4	DBJ	0 445 110 565	F 00V C17 504		
			BHZ <DV6FC>	04.14→	4	DBJ	0 445 110 565	F 00V C17 504		
HDi [B5]	1,6	66	9HV <DV6TED4/FAP>	05.07-07.09	4	DBJ	0 445 110 297	0 986 435 150	F 00V C17 504	
			9HX <DV6ATED4>	11.04-07.10	4	DBJ	0 445 110 239	0 986 435 122	F 00V C17 504	
		80	9H... <DV6TED4>	11.04-09.10	4			F 00V C17 504		
			Org.-Nr. →10373	11.04-04.05	4	DBJ	0 445 110 188	0 986 435 090		
			Org.-Nr. 10374→11059	05.05-02.07	4	DBJ	0 445 110 259	0 986 435 126		
			Org.-Nr. 11060→	03.07-09.10	4	DBJ	0 445 110 297	0 986 435 150		
			9HZ <DV6TED4 FAP>	07.06-12.10	4			F 00V C17 504		
			Org.-Nr. →11059	07.06-02.07	4	DBJ	0 445 110 259	0 986 435 126		
			Org.-Nr. 11060→	03.07-12.10	4	DBJ	0 445 110 297	0 986 435 150		
HDi [B71]	1,6	68	9HJ <DV6DTED M>; 9HP <DV6DTED>	09.10→	4	DBJ	0 445 110 340	0 986 435 203	F 00V C17 504	
2.0 HDi [B5]	2,0	80	RHZ <DW10ATED>	07.06-12.10	4	DBB	0 445 110 076	0 986 435 077		
C4 Cactus										
1.5 Blue HDi [E3]	1,5	75	YHY <DV5RD>	04.18→	4	DBJ	0 445 110 749			
1.6 Blue HDi [E3]	1,6	73	BHY <DV6FD>	02.14→	4	DBJ	0 445 110 565	F 00V C17 504		
HDi [E3]	1,6	68	9HP <DV6DTED>	02.14→	4	DBJ	0 445 110 340	0 986 435 203	F 00V C17 504	







◀ CITROEN

C4 Coupé											
1.6 HDi [B5]	1,6	66	9HV <DV6TED4/FAP>	05.07-07.09	4	DBJ	0 445 110 297	0 986 435 150	F 00V C17 504		
			9HX <DV6ATED4>	11.04-07.10	4	DBJ	0 445 110 239	0 986 435 122	F 00V C17 504		
	80	9H... <DV6TED4>	11.04-07.10	4				F 00V C17 504			
		Org.-Nr. →10373	11.04-04.05	4	DBJ	0 445 110 188	0 986 435 090				
		Org.-Nr. 10374→11059	05.05-02.07	4	DBJ	0 445 110 259	0 986 435 126				
Org.-Nr. 11060→	03.07-07.10	4	DBJ	0 445 110 297	0 986 435 150						
C4 Grand Picasso											
1.6 BlueHdi [B78]	1,6	73	BHY <DV6FD>	01.15→	4	DBJ	0 445 110 565		F 00V C17 504		
			85	BHX <DV6FC>	04.14→	4	DBJ	0 445 110 565		F 00V C17 504	
			88	BHZ <DV6FC>	04.14→	4	DBJ	0 445 110 565		F 00V C17 504	
Hdi [B58]	1,6	80	9H... <DV6TED4>	10.06-12.11	4	DBJ,MPR	0 445 110 259	0 986 435 126	F 00V C17 504		
			Org.-Nr. →11438	10.06-03.08	4	DBJ,MPR	0 445 110 259	0 986 435 126			
			Org.-Nr. 11439→	04.08-12.11	4	DBJ,MPR	0 445 110 297	0 986 435 150			
Hdi [B78]	1,6	68	9HP <DV6DTEd>	07.13→	4	DBJ	0 445 110 340	0 986 435 203	F 00V C17 504		
C4 Picasso											
1.6 BlueHdi [B78]	1,6	73	BHY <DV6FD>	01.15→	4	DBJ	0 445 110 565		F 00V C17 504		
			85	BHX <DV6FC>	04.14→	4	DBJ	0 445 110 565		F 00V C17 504	
			88	BHZ <DV6FC>	04.14→	4	DBJ	0 445 110 565		F 00V C17 504	
Hdi [B58]	1,6	80	9H... <DV6TED4>	02.07-12.11	4	DBJ,MPR	0 445 110 259	0 986 435 126	F 00V C17 504		
			Org.-Nr. →11438	02.07-03.08	4	DBJ,MPR	0 445 110 259	0 986 435 126			
			Org.-Nr. 11439→	04.08-12.11	4	DBJ,MPR	0 445 110 297	0 986 435 150			
Hdi [B78]	1,6	68	9HP <DV6DTEd>	02.13→	4	DBJ	0 445 110 340	0 986 435 203	F 00V C17 504		
C4 Spacetourer											
1.6 BlueHdi [B78]	1,6	73	BHY <DV6FD>	04.18→	4	DBJ	0 445 110 565		F 00V C17 504		
			85	BHX <DV6FC>	04.18→	4	DBJ	0 445 110 565		F 00V C17 504	
			88	BHZ <DV6FC>	04.18→	4	DBJ	0 445 110 565		F 00V C17 504	
C5											
1.6 HDi [X3]	1,6	80	9H... <DV6TED4>	10.04-03.08	4	DBJ,MPR	0 445 110 259	0 986 435 126			
			Org.-Nr. →10373	10.04-04.05	4	DBJ,MPR	0 445 110 188	0 986 435 090			
			Org.-Nr. 10374→11073	05.05-03.07	4	DBJ,MPR	0 445 110 259	0 986 435 126			
			Org.-Nr. 11074→	04.07-03.08	4	DBJ,MPR	0 445 110 297	0 986 435 150			
Hdi [X7]	1,6	80	9HZ <DV6TED4>	04.08-07.10	4	DBJ	0 445 110 297	0 986 435 150	F 00V C17 504		
2.0 HDi [X4]	2,0	66	RHY <DW10TD>	03.01-09.04	4	BO,DBB	0 445 110 076	0 986 435 077			
			79	RHS <DW10ATED/FAP>	03.01-09.04	4	DBB	0 445 110 076	0 986 435 077		
		80	RHZ <DW10ATED>	04.01-09.04	4	DBB	0 445 110 076	0 986 435 077			
			Org.-Nr. →8903	03.01-03.01	4	DBB,GS, I1B,I2G	0 445 110 062	0 986 435 077			
2.2 HDi [X3]	2,2	98	4HX <DW12TED4>	10.04-09.05	4	DBB	0 445 110 036	0 986 435 013	0 986 435 014 0 986 435 015		
			120-125	4H... <DW12BTED4>	03.06-03.08	4	DBB	0 445 115 025	0 986 435 450		
			Hdi [X4]	2,2	98	4HX <DW12TED4>	03.01-09.04	4	DBB,I1B, I2G	0 445 110 036	0 986 435 013
		4				I3K	0 986 436 015				
Hdi [X7]	2,2	120-125	4H... <DW12BTED4>	04.08-09.09	4	DBB	0 445 115 025	0 986 435 450			
		150	4HL <DW12C>	07.10-05.15	4	DBJ	0 445 115 087	0 986 435 392	0 986 435 434		
3.0 HDi 24V [X7]	3,0	177	X8Z <DT20C>	07.09-04.14	6	DBJ	0 445 116 012	0 986 435 403			
C5 Break											
1.6 HDi [X3]	1,6	80	9H... <DV6TED4>	10.04-03.08	4	DBJ,MPR	0 445 110 259	0 986 435 126			
			Org.-Nr. →10373	10.04-04.05	4	DBJ,MPR	0 445 110 188	0 986 435 090			
			Org.-Nr. 10374→11073	05.05-03.07	4	DBJ,MPR	0 445 110 259	0 986 435 126			
			Org.-Nr. 11074→	04.07-03.08	4	DBJ,MPR	0 445 110 297	0 986 435 150			
2.0 HDi [X4]	2,0	66	RHY <DW10TD>	06.01-09.04	4	BO,DBB	0 445 110 076	0 986 435 077			
			79/80	RHS <DW10ATED/FAP>; RHZ <DW10ATED>	06.01-09.04	4	DBB	0 445 110 076	0 986 435 077		
2.2 HDi [X3]	2,2	98	4HX <DW12TED4>	10.04-09.05	4	DBB	0 445 110 036	0 986 435 013	0 986 435 014 0 986 435 015		
			120-125	4H... <DW12BTED4>	04.06-03.08	4	DBB	0 445 115 025	0 986 435 450		





2.2 HDi [X4]	2,2	98	4HX <DW12TED4>	06.01-09.04	4	DBB,11B, I2G	0 445 110 036	0 986 435 013	
								0 986 435 014	
								0 986 435 015	
					4	I3K	0 986 436 015		
<b>C5 Tourer</b>									
1.6 HDi [X7]	1,6	80	9HZ <DV6TED4>	04.08-07.10	4	DBJ	0 445 110 297	0 986 435 150	F 00V C17 504
2.2 HDi [X7]	2,2	120-125	4H... <DW12BTED4>	04.08-09.09	4	DBB	0 445 115 025	0 986 435 450	
		150	4HL <DW12C>	07.10-05.15	4	DBJ	0 445 115 087	0 986 435 392	
								0 986 435 434	
3.0 HDi 24V [X7]	3,0	177	X8Z <DT20C>	07.09-04.14	6	DBJ	0 445 116 012	0 986 435 403	
<b>C6</b>									
2.2 HDi [X6]	2,2	120-125	4H... <DW12BTED4>	06.06-07.10	4	DBB	0 445 115 025	0 986 435 450	
3.0 HDi 24V [X6]	3,0	177	X8Z <DT20C>	07.09-12.12	6	DBJ	0 445 116 012	0 986 435 403	
<b>C8</b>									
2.0 HDi [V3]	2,0	81	RH... <DW10ATED4/FAP>; RHW <DW10ATED4>	06.02-12.06	4	DBB	0 445 110 057	0 986 435 093	
2.2 HDi [V3]	2,2	94	4HW <DW12TED4/FAP>	06.02-07.06	4	DBB,11B, I2G	0 445 110 036	0 986 435 013	
								0 986 435 014	
								0 986 435 015	
		120-125	4H... <DW12BTED4>	09.07-05.10	4	DBB	0 445 115 025	0 986 435 450	
<b>DS3</b>									
1.4 HDi 8V [A55]	1,4	50	8H... <DV4C>	03.10-04.15	4	DBJ	0 445 110 339	0 986 435 172	F 00V C17 504
1.6 BlueHDi [A55]	1,6	55/73	BHW <DV6FE>; BHY <DV6FD>	02.14-04.15	4	DBJ	0 445 110 565		F 00V C17 504
		85	BHX <DV6FC>	10.13-04.15	4	DBJ	0 445 110 565		F 00V C17 504
		88	BHZ <DV6FC>	10.13-04.15	4	DBJ	0 445 110 565		F 00V C17 504
HDi [A55]	1,6	68	9HP <DV6DTE>	01.10-04.15	4	DBJ	0 445 110 340	0 986 435 203	F 00V C17 504
<b>DS3 Cabrio</b>									
1.6 BlueHDi [A56]	1,6	73	BHY <DV6FD>	01.14-04.15	4	DBJ	0 445 110 565		F 00V C17 504
		85	BHX <DV6FC>	10.13-04.15	4	DBJ	0 445 110 565		F 00V C17 504
		88	BHZ <DV6FC>	01.14-04.15	4	DBJ	0 445 110 565		F 00V C17 504
HDi [A56]	1,6	68	9HP <DV6DTE>	07.12-04.15	4	DBJ	0 445 110 340	0 986 435 203	F 00V C17 504
<b>DS4</b>									
1.6 BlueHDi [B75]	1,6	73	BHY <DV6FD>	05.15-09.15	4	DBJ	0 445 110 565		F 00V C17 504
		88	BHZ <DV6FC>	04.14-09.15	4	DBJ	0 445 110 565		F 00V C17 504
HDi [B75]	1,6	85	BHX <DV6FC>	04.14-09.15	4	DBJ	0 445 110 565		F 00V C17 504
HDi 16V [B75]	1,6	68	9HP <DV6DTE>	03.11-09.15	4	DBJ	0 445 110 340	0 986 435 203	F 00V C17 504
<b>DS5</b>									
1.6 BlueHDi [B81]	1,6	85	BHX <DV6FC>	09.13-04.15	4	DBJ	0 445 110 565		F 00V C17 504
		88	BHZ <DV6FC>	09.13-04.15	4	DBJ	0 445 110 565		F 00V C17 504
<b>Evasion</b>									
2.0 HDi [U60]	2,0	80	RHZ <DW10ATED>	01.99-07.02	4	DBB, I2G	0 445 110 044	0 986 435 003	
					4	DBB, 11B	0 445 110 008	0 986 435 003	
		81	RHW <DW10ATED4/L4>	06.00-07.02	4	DBB	0 445 110 057	0 986 435 093	
<b>Grand C4 Spacetourer</b>									
1.6 BlueHDi [B78]	1,6	73	BHY <DV6FD>	04.18→	4	DBJ	0 445 110 565		F 00V C17 504
		85	BHX <DV6FC>	04.18→	4	DBJ	0 445 110 565		F 00V C17 504
		88	BHZ <DV6FC>	04.18→	4	DBJ	0 445 110 565		F 00V C17 504
<b>Jumpy</b>									
1.6 BlueHDi [K0]	1,6	70	BHS <DV6FDU>	03.16→	4	DBJ	0 445 110 565		F 00V C17 504
			BHV <DV6FDU>	03.16→	4	DBJ	0 445 110 565		F 00V C17 504
		85	BHX <DV6FCU>	03.16→	4	DBJ	0 445 110 565		F 00V C17 504
HDi [G9]	1,6	66	9HH <DV6DU M>; 9HM <DV6U C>	12.10-12.16	4	DBJ	0 445 110 340	0 986 435 203	F 00V C17 504
			9HU <DV6UTED4>	02.07-12.16	4	DBJ	0 445 110 239	0 986 435 122	F 00V C17 504
2.0 HDi [U64]	2,0	70	RHX <DW10BTED>						
			Org.-Nr. →8763	10.99-11.00	4	DBB	0 445 110 044	0 986 435 003	
			Org.-Nr. 8764→	12.00-01.07	4	DBB	0 445 110 076	0 986 435 077	
		80	RHZ <DW10ATED>	10.99-01.07	4	DBB, I2G	0 445 110 044	0 986 435 003	
					4	DBB, 11B	0 445 110 008	0 986 435 003	
		81	RHW <DW10ATED4>	06.00-01.07	4	DBB	0 445 110 057	0 986 435 093	
<b>Nemo</b>									
1.3 HDi [A9]	1,3	55	FHZ <F13DTE5>	08.10→	4	DBB	0 445 110 351	0 986 435 204	
		59	FHY <F 13DTE6>	09.15→	4	DBB	0 445 110 614	0 986 435 249	
1.4 HDi [A9]	1,4	50	8HS <DV4TED>	02.08→	4	DBJ	0 445 110 252	0 986 435 143	







◀ CITROEN

SpaceTourer										
1.6 BlueHDi [K0]	1,6	70	BHS <DV6FDU>	03.16→	4	DBJ	0 445 110 565		F 00V C17 504	
			BHV <DV6FDU>	04.16→	4	DBJ	0 445 110 565		F 00V C17 504	
	85	BHX <DV6FCU>	03.16→	4	DBJ	0 445 110 565		F 00V C17 504		
Xantia										
2.0 HDi [X2]	2,0	66	RHY <DW10TD>	03.99-12.01	4	DBB,I2G	0 445 110 044	0 986 435 003		
					4	DBB,I1B	0 445 110 008	0 986 435 003		
	81	RHZ <DW10ATED>	10.98-12.01	4	DBB	0 445 110 044	0 986 435 003			
Xantia Break										
2.0 HDi [X2]	2,0	66	RHY <DW10TD>	03.99-12.01	4	DBB,I2G	0 445 110 044	0 986 435 003		
					4	DBB,I1B	0 445 110 008	0 986 435 003		
	81	RHZ <DW10ATED>	10.98-12.01	4	DBB	0 445 110 044	0 986 435 003			
Xsara										
1.4 HDi [N7]	1,4	50	8HZ <DV4TD>	01.03-12.05	4	DBJ	0 445 110 135	0 986 435 085		
2.0 HDi [N6]	2,0	66	RHY <DW10TD>							
			Org.-Nr. →8574	02.99-05.00	4	DBB	0 445 110 044	0 986 435 003		
			Org.-Nr. 8575→	06.00-08.00	4	DBB	0 445 110 076	0 986 435 077		
HDi [N7]	2,0	66	RHY <DW10TD>	09.00-12.05	4	BO,DBB	0 445 110 076	0 986 435 077		
			80	RHZ <DW10ATED>	09.00-12.05	4	DBB	0 445 110 076	0 986 435 077	
Xsara Break										
1.4 HDi [N7]	1,4	50	8HZ <DV4TD>	01.03-12.05	4	DBJ	0 445 110 135	0 986 435 085		
2.0 HDi [N6]	2,0	66	RHY <DW10TD>							
			Org.-Nr. →8574	02.99-05.00	4	DBB	0 445 110 044	0 986 435 003		
			Org.-Nr. 8575→	06.00-08.00	4	DBB	0 445 110 076	0 986 435 077		
HDi [N7]	2,0	66	RHY <DW10TD>	09.00-03.10	4	BO,DBB	0 445 110 076	0 986 435 077		
			80	RHZ <DW10ATED>	09.00-03.10	4	DBB	0 445 110 076	0 986 435 077	
Xsara Coupé										
1.4 HDi [N7]	1,4	50	8H... <DV4TD>	01.03-12.05	4	DBJ	0 445 110 135	0 986 435 085		
2.0 HDi [N6]	2,0	66	RHY <DW10TD>							
			Org.-Nr. →8574	02.99-05.00	4	DBB	0 445 110 044	0 986 435 003		
			Org.-Nr. 8575→	06.00-08.00	4	DBB	0 445 110 076	0 986 435 077		
HDi [N7]	2,0	66	RHY <DW10TD>	09.00-12.05	4	BO,DBB	0 445 110 076	0 986 435 077		
			80	RHZ <DW10ATED>	09.00-12.05	4	DBB	0 445 110 076	0 986 435 077	
Xsara Picasso										
1.6 HDi [N68]	1,6	66	9HX <DV6ATED4>	09.05-04.10	4	DBJ	0 445 110 239	0 986 435 122	F 00V C17 504	
			9H... <DV6TED4>	05.04-04.10	4				F 00V C17 504	
				Org.-Nr. →10338	05.04-03.05	4	DBJ	0 445 110 188	0 986 435 090	
				Org.-Nr. 10339→	04.05-04.10	4	DBJ	0 445 110 259	0 986 435 126	
2.0 HDi [N68]	2,0	66	RHY <DW10TD>	01.00-04.10	4	DBB,I2G	0 445 110 044	0 986 435 003		
					4	DBB,KKX, KKY,KKZ	0 445 110 076	0 986 435 077		
					4	DBB,I1B	0 445 110 008	0 986 435 003		



**DACIA**

Dokker										
1.5 dCi [FE/FK]	1,5	55/66	K9K 612	07.12→	4	DBB	0 445 110 485	0 986 435 240	1 987 972 077	
			dCi [FE/KE]	05.15→	4	DBB	0 445 110 652		1 987 972 077	
			63	K9K 830	11.12→	4				1 987 972 077
Duster										
1.5 dCi [HS]	1,5	66	K9K 612	09.13-05.18	4	DBB	0 445 110 485	0 986 435 240	1 987 972 077	
			K9K 626	05.15-05.18	4	DBB	0 445 110 652		1 987 972 077	
			80	K9K 6...	05.15-05.18	4				1 987 972 077
				K9K 658	05.15-05.18	4				1 987 972 077
			dCi, dCi 4x4 [HS]	63/66/79/80/81	K9K 85...; K9K 796; K9K 884; K9K 892; K9K 894; K9K 896; K9K 898	10.09-05.18	4			
dCi 4x4 [HS]	1,5	80	K9K 858	09.13-05.18	4			1 987 972 077		
DCi 90, DCi 110, DCi 110 4WD [HM]	1,5	66/80	K9K...; K9K 830	01.18→	4			1 987 972 077		
Lodgy										
1.5 dCi [JS]	1,5	66	K9K 612	03.12→	4	DBB	0 445 110 485	0 986 435 240	1 987 972 077	



1.5 dCi [JS]	1,5	66	K9K 626	05.15→	4	DBB	0 445 110 652	1987 972 077	
		79	K9K 846	03.12→	4				
		81	K9K 666	11.16→	4				
<b>Logan</b>									
1.5 dCi [LS]	1,5	48/50/55/63/65	K9K 790; K9K 792; K9K 796; K9K 892	06.05-12.15	4			1987 972 077	
dCi [L8]	1,5	55/66	K9K 612	08.12→	4	DBB	0 445 110 485 0 986 435 240	1987 972 077	
<b>Logan MCV</b>									
1.5 dCi [KS/FS]	1,5	48/50/55/63/65	K9K 792; K9K 794; K9K 796; K9K 892	01.07-12.15	4			1987 972 077	
dCi [K8]	1,5	55	K9K 612	03.13→	4	DBB	0 445 110 485 0 986 435 240	1987 972 077	
		62	K9K 838	06.13→	4				
		66	K9K 6...	03.13→	4				
			Mot.-Nr. K9K 612	03.13→	4	DBB			0 445 110 485 0 986 435 240
		Mot.-Nr. K9K 626	03.13→	4	DBB	0 445 110 652			
<b>Sandero</b>									
1.5 dCi [BS]	1,5	48/50/55/63/65	K9K 790; K9K 792; K9K 796; K9K 892	06.08-12.15	4			1987 972 077	
dCi [B8]	1,5	55/66	K9K 612	08.12→	4	DBB	0 445 110 485 0 986 435 240	1987 972 077	
		63	K9K 830	08.12→	4				

## DODGE

<b>Grand Caravan</b>									
2.8 CRD [RT]	2,8	110	ENS	09.08-08.11	4	DBJ	0 445 115 067 0 986 435 402		
<b>Nitro</b>									
2.8 CRD, CRD 4x4 [KA]	2,8	130	EN...	09.08-08.09	4	DBJ	0 445 115 067 0 986 435 402		
<b>Ram 2500 Pickup</b>									
5.9 , 4x4	5,9	239/242		09.02-08.04	6	DBJ	0 445 120 113 0 986 435 503		
<b>Ram 3500 Pickup</b>									
5.9 , 4x4	5,9	242	ETH	09.03-08.04	6	DBJ	0 445 120 113 0 986 435 503		
		160-175		09.02-08.04	6	DBJ			
				09.03-12.03	6	DBJ			
6.7	6,7	261		09.06-08.07	6	DBJ	0 445 120 050 0 986 435 518		
				09.06-08.08	6	DBJ, EQ0, SDK, YE8			
					6	DBJ, V86			0 445 120 204 0 986 435 519

## DS (CITROEN)

<b>DS</b>									
1.6 BlueHDi [B81]	1,6	85	BHX <DV6FC>	05.15→	4	DBJ	0 445 110 565	F 00V C17 504	
<b>DS3</b>									
1.4 HDi 8V [A55]	1,4	50	8H... <DV4C>	05.15-12.15	4	DBJ	0 445 110 339 0 986 435 172	F 00V C17 504	
1.6 BlueHDi [A55]	1,6	55	BHW <DV6FE>	05.15→	4	DBJ	0 445 110 565	F 00V C17 504	
		73	BHY <DV6FD>	05.15→	4	DBJ			
		85	BHX <DV6FC>	05.15→	4	DBJ			
		88	BHZ <DV6FC>	05.15→	4	DBJ			
			HDi [A55]	1,6	68	9HP <DV6DTED>			05.15-12.15
<b>DS3 Cabrio</b>									
1.6 BlueHDi [A56]	1,6	73	BHY <DV6FD>	05.15→	4	DBJ	0 445 110 565	F 00V C17 504	
		85	BHX <DV6FC>	05.15→	4	DBJ			
		88	BHZ <DV6FC>	05.15→	4	DBJ			
	HDi [A56]	1,6	68	9HP <DV6DTED>	05.15-12.15	4	DBJ	0 445 110 340 0 986 435 203	
<b>DS4</b>									
1.6 BlueHDi [B75]	1,6	73	BHY <DV6FD>	10.15→	4	DBJ	0 445 110 565	F 00V C17 504	
		85	BHX <DV6FC>	10.15→	4	DBJ			
		88	BHZ <DV6FC>	10.15→	4	DBJ			
<b>DS5</b>									
1.6 BlueHDi [B81]	1,6	88	BHZ <DV6FC>	05.15→	4	DBJ	0 445 110 565	F 00V C17 504	



◀ DS

<b>DS7</b>										
21.5 BlueHDi	1,5	96	YHZ <DV5RC>	09.17→	4	DBJ	0 445 110 749			F 00V C17 504

**FIAT**

<b>Albea</b>										
1.3 JTD 16V [172]	1,3	52	188 A9.000 <M40>	07.03-12.12	4	DBB	0 445 110 083	0 986 435 078		

<b>Brava</b>										
1.9 JTD [182]	1,9	74	182 B9.000 <M26>	08.00-09.01	4	DBB	0 445 110 068	0 986 435 083		F 00V C17 504
		77	182 B4.000 <M25>	11.98-09.01	4	DBB	0 445 110 002	0 986 435 001		F 00V C17 504

<b>Bravo</b>												
1.6 Multijet [198]	1,6	66	198 A6.000	02.09-12.09	4	DBJ	0 445 110 300	0 986 435 171		F 00V C17 504		
				03.10-12.14	4	DBJ,N5P	0 445 110 300	0 986 435 171		F 00V C17 504		
					4	5PL,DBJ	0 445 110 524	0 986 435 280		F 00V C17 504		
				77	198 A3.000	01.10-09.13	4	DBJ	0 445 110 300	0 986 435 171		F 00V C17 504
					844 A3.000	10.13-12.14	4	DBJ	0 445 110 524	0 986 435 280		F 00V C17 504
				77/88	198 A2.000 <M78>; 198 A3.000 <M76>	10.07-12.09	4	DBJ	0 445 110 300	0 986 435 171		
				85	955 A4.000	11.08-12.09	4	DBJ	0 445 110 300	0 986 435 171		F 00V C17 504
				88	198 A2.000	03.10-12.14	4	DBJ,N5P	0 445 110 300	0 986 435 171		F 00V C17 504

1.9 JTD [182]	1,9	74	182 B9.000 <M26>	08.00-09.01	4	DBB	0 445 110 068	0 986 435 083		F 00V C17 504
		77	182 B4.000 <M25>	11.98-09.01	4	DBB	0 445 110 002	0 986 435 001		F 00V C17 504

Multijet [198]	1,9	66/85	192 B4.000 <M87>; 192 B5.000 <M83>	03.07-12.09	4	DBJ	0 445 110 276	0 986 435 148				
				88	192 A8.000 <M88>	03.07-12.09	4	DBJ	0 445 110 276	0 986 435 148		F 00V C17 504
				110	937 A5.000 <M92>	04.07-12.09	4	DBB	0 445 110 243	0 986 435 104		F 00V C17 504
				2.0 Multijet [198]	2,0	120	844 A2.000	10.08-12.09	4	DBJ	0 445 110 299	0 986 435 230

<b>Croma</b>													
1.9 JTD 8V [194]	1,9	85	939 A7.000 <M87>	06.05-09.06	4	DBB	0 445 110 244	0 986 435 161					
				10.06-12.10	4	DBJ	0 445 110 276	0 986 435 148					
							06.05-12.10	4					F 00V C17 504
				88	939 A1.000 <M88>	06.05-09.06	4	DBB	0 445 110 244	0 986 435 161			
							10.06-12.10	4	DBJ	0 445 110 276	0 986 435 148		
							06.05-12.10	4					F 00V C17 504

JTD 16V [194]	1,9	100	939 A8.000 <M91>	12.06-12.10	4	DBB	0 445 110 243	0 986 435 104		F 00V C17 504
		110	939 A2.000 <M92>	06.05-12.10	4	DBB	0 445 110 243	0 986 435 104		F 00V C17 504

2.4 JTD [194]	2,4	147	939 A3.000 <M95>	06.05-08.07	5	DBJ	0 445 110 213	0 986 435 162		
---------------	-----	-----	------------------	-------------	---	-----	---------------	---------------	--	--

<b>Doblo</b>										
1.3 JTD 16V [223]	1,3	51	188 A9.000 <M20>	02.04-09.05	4	DBB	0 445 110 083	0 986 435 078		

Multijet [223]	1,3	55/62	199 A2.000 <M73>; 223 A9.000 <M71>	10.05-08.16	4	DBB	0 445 110 183	0 986 435 102		

Multijet [263]	1,3	66	199 A3.000 <M72 (ECOCF4)>	02.10→	4	DBB,SSJ	0 445 110 183	0 986 435 102		
				07.15→	4	DBB,SSJ	0 445 110 351	0 986 435 204		
							07.15→	4	DBB	0 445 110 351

MultiJet [263]	1,3	70	330 A1.000	04.16→	4	DBB	0 445 110 614	0 986 435 249		
----------------	-----	----	------------	--------	---	-----	---------------	---------------	--	--

1.6 Multijet [263]	1,6	66	263 A...	02.10→	4	DBJ,N5P	0 445 110 300	0 986 435 171		F 00V C17 504			
					4	5PL,DBJ	0 445 110 524	0 986 435 280		F 00V C17 504			
				70	263 A7.000	04.15→	4	DBJ	0 445 110 524	0 986 435 280		F 00V C17 504	
				74	263 A3.000 <M76>	02.10→	4	DBJ,N5P	0 445 110 300	0 986 435 171		F 00V C17 504	
							4	5PL,DBJ	0 445 110 524	0 986 435 280		F 00V C17 504	
				77	198 A3.000 <M76>	02.10→	4	DBJ,N5P	0 445 110 300	0 986 435 171		F 00V C17 504	
							4	5PL,DBJ	0 445 110 524	0 986 435 280		F 00V C17 504	
							04.15→	4	DBJ	0 445 110 524	0 986 435 280		F 00V C17 504
				88	940 C1.000	04.15→	4	DBJ	0 445 110 524	0 986 435 280		F 00V C17 504	
				MultiJet [263]	1,6	74	263 A9.000	06.17→	4	DBJ	0 445 110 524	0 986 435 280	

1.9 JTD [223]	1,9	74	182 B9.000 <M15>	10.01-01.04	4					F 00V C17 504		
							10.01-10.01	4	DBB	0 445 110 068	0 986 435 083	
							11.01-01.04	4	DBB	0 445 110 119	0 986 435 083	



<b>1.9</b> JTD [223]	1,9	77	223 A7.000 <M16/M30>	11.02-09.05	4	DBB	<b>0 445 110 119</b>	<b>0 986 435 083</b>	<b>F 00V C17 504</b>
Multijet [223]	1,9	74	223 B2.000 <M86>	10.05-12.10	4	DBJ	<b>0 445 110 187</b>	<b>0 986 435 099</b>	
		77	223 B1.000 <M84>	10.05-12.10	4	DBJ	<b>0 445 110 187</b>	<b>0 986 435 099</b>	<b>F 00V C17 504</b>
		88	186 A9.000 <M88>	10.05-12.10	4	DBJ	<b>0 445 110 276</b>	<b>0 986 435 148</b>	
<b>2.0</b> Multijet [263]	2,0	99	263 A1.000 <M120>	02.10-03.16	4	DBJ,N5P	<b>0 445 110 299</b>	<b>0 986 435 230</b>	<b>F 00V C17 504</b>
					4	5PL,DBJ	<b>0 445 110 419</b>	<b>0 986 435 213</b>	<b>F 00V C17 504</b>
				02.10→	4	DBJ,N5P	<b>0 445 110 299</b>	<b>0 986 435 230</b>	<b>F 00V C17 504</b>
				04.16→	4	DBJ,N5P	<b>0 445 110 299</b>	<b>0 986 435 230</b>	<b>F 00V C17 504</b>
					4	5PL,DBJ	<b>0 445 110 419</b>	<b>0 986 435 213</b>	<b>F 00V C17 504</b>

**Doblo Cargo**

<b>1.3</b> JTD 16V [223]	1,3	51	188 A9.000 <M20>	02.04-09.05	4	DBB	<b>0 445 110 083</b>	<b>0 986 435 078</b>	
Multijet [223]	1,3	55/62	199 A2.000 <M73>; 223 A9.000 <M71>	10.05-08.16	4	DBB	<b>0 445 110 183</b>	<b>0 986 435 102</b>	
MultiJet [263]	1,3	55/66	263 A2.000 <M72>; 263 A6.000	07.15→	4	DBB	<b>0 445 110 351</b>	<b>0 986 435 204</b>	
		59/70	225 A2.000; 330 A1.000	04.16→	4	DBB	<b>0 445 110 614</b>	<b>0 986 435 249</b>	
		66	199 A3.000 <M72 (ECOFC4)>	02.10→	4	DBB,SSJ	<b>0 445 110 183</b>	<b>0 986 435 102</b>	
				07.15→	4	DBB,SSJ	<b>0 445 110 351</b>	<b>0 986 435 204</b>	
<b>1.6</b> MultiJet [263]	1,6	66	263 A...	02.10→	4	DBJ,N5P	<b>0 445 110 300</b>	<b>0 986 435 171</b>	<b>F 00V C17 504</b>
					4	5PL,DBJ	<b>0 445 110 524</b>	<b>0 986 435 280</b>	<b>F 00V C17 504</b>
		74	263 A3.000 <M76>	02.10→	4	DBJ,N5P	<b>0 445 110 300</b>	<b>0 986 435 171</b>	<b>F 00V C17 504</b>
					4	5PL,DBJ	<b>0 445 110 524</b>	<b>0 986 435 280</b>	<b>F 00V C17 504</b>
			263 A9.000	06.17→	4	DBJ	<b>0 445 110 524</b>	<b>0 986 435 280</b>	<b>F 00V C17 504</b>
		77	198 A3.000 <M76>	02.10→	4	DBJ,N5P	<b>0 445 110 300</b>	<b>0 986 435 171</b>	<b>F 00V C17 504</b>
					4	5PL,DBJ	<b>0 445 110 524</b>	<b>0 986 435 280</b>	<b>F 00V C17 504</b>
			263 A8.000	04.15→	4	DBJ	<b>0 445 110 524</b>	<b>0 986 435 280</b>	<b>F 00V C17 504</b>
	88	940 C1.000	04.15→	4	DBJ	<b>0 445 110 524</b>	<b>0 986 435 280</b>	<b>F 00V C17 504</b>	

<b>1.9</b> JTD [223]	1,9	74/77	182 B9.000 <M15>; 223 A7.000 <M16/M30>	10.01-09.05	4	DBB	<b>0 445 110 119</b>	<b>0 986 435 083</b>	<b>F 00V C17 504</b>
Multijet [223]	1,9	74	223 B2.000 <M86>	10.05-12.10	4	DBJ	<b>0 445 110 187</b>	<b>0 986 435 099</b>	
		77	223 B1.000 <M84>	10.05-12.10	4	DBJ	<b>0 445 110 187</b>	<b>0 986 435 099</b>	<b>F 00V C17 504</b>
		88	186 A9.000 <M88>	10.05-12.10	4	DBJ	<b>0 445 110 276</b>	<b>0 986 435 148</b>	
<b>2.0</b> MultiJet [263]	2,0	99	263 A1.000 <M120>	02.10-03.16	4	DBJ,N5P	<b>0 445 110 299</b>	<b>0 986 435 230</b>	<b>F 00V C17 504</b>
					4	5PL,DBJ	<b>0 445 110 419</b>	<b>0 986 435 213</b>	<b>F 00V C17 504</b>
				02.10→	4	DBJ,N5P	<b>0 445 110 299</b>	<b>0 986 435 230</b>	<b>F 00V C17 504</b>
				04.16→	4	DBJ,N5P	<b>0 445 110 299</b>	<b>0 986 435 230</b>	<b>F 00V C17 504</b>
					4	5PL,DBJ	<b>0 445 110 419</b>	<b>0 986 435 213</b>	<b>F 00V C17 504</b>

**Fiorino**

<b>1.3</b> Multijet [225]	1,3	55	199 A2.000 <M73>	12.07→	4	DBB	<b>0 445 110 183</b>	<b>0 986 435 102</b>	
		55/70	199 A9.000 <ECOFC5>; 199 B1.000	04.16→	4	DBB	<b>0 445 110 351</b>	<b>0 986 435 204</b>	
		59/70	225 A2.000; 330 A1.000	03.15→	4	DBB	<b>0 445 110 614</b>	<b>0 986 435 249</b>	

**Freemont**

<b>2.0</b> Multijet, Multijet 4x4 [345]	2,0	100-103/120-125	939 B5.000	06.11-12.15	4	DBJ	<b>0 445 110 419</b>	<b>0 986 435 213</b>	<b>F 00V C17 504</b>
---	-----	-----------------	------------	-------------	---	-----	----------------------	----------------------	----------------------

**Grande Punto**

<b>1.3</b> MultiJet [199]	1,3	51/55/66	199 A2.000 <M73>; 199 A3.000 <M72 (ECOFC4)>; 199 B2.000 <ECOFC4>	10.05-12.11	4	DBB	<b>0 445 110 183</b>	<b>0 986 435 102</b>	
		55/62	199 A9.000 <ECOFC5>; 199 B4.000 <ECOFC5>	09.08-12.11	4	DBB	<b>0 445 110 351</b>	<b>0 986 435 204</b>	
<b>1.6</b> MultiJet [199]	1,6	88	955 A3.000 <M78>	08.08-12.09	4	DBJ	<b>0 445 110 300</b>	<b>0 986 435 171</b>	<b>F 00V C17 504</b>
<b>1.9</b> MultiJet [199]	1,9	85/88/96	199 A5.000 <M89>; 939 A1.000 <M88>; 939 A7.000 <M87>	10.05-12.09	4	DBJ	<b>0 445 110 276</b>	<b>0 986 435 148</b>	<b>F 00V C17 504</b>

**Idea**

<b>1.3</b> MultiJet [350]	1,3	51	188 A9.000 <M30>	01.04-11.10	4	DBB	<b>0 445 110 083</b>	<b>0 986 435 078</b>	
		66	199 A3.000 <M72 (ECOFC4)>	11.04-11.10	4	DBB	<b>0 445 110 183</b>	<b>0 986 435 102</b>	
		70	199 B1.000	05.08-12.12	4	DBB	<b>0 445 110 351</b>	<b>0 986 435 204</b>	
<b>1.6</b> MultiJet [350]	1,6	85-88	350 A...	04.08-12.12	4	DBJ	<b>0 445 110 300</b>	<b>0 986 435 171</b>	<b>F 00V C17 504</b>
<b>1.9</b> MultiJet [350]	1,9	74	188 B2.000 <M40>	01.04-12.12	4	DBB,EU3	<b>0 445 110 112</b>	<b>0 986 435 101</b>	<b>F 00V C17 504</b>
					4	DBJ,EU3	<b>0 445 110 187</b>	<b>0 986 435 099</b>	<b>F 00V C17 504</b>

**Linea**

<b>1.2</b> TD [110]	1,3	67	199 A3.000	01.09→	4	DBJ	<b>0 445 110 331</b>	<b>0 986 435 298</b>	
<b>1.3</b> MultiJet [323]	1,3	66	199 A3.000 <M72 (ECOFC4)>	03.07→	4	DBB	<b>0 445 110 183</b>	<b>0 986 435 102</b>	





◀ FIAT

1.3 MultiJet [323]	1,3	70	199 B1.000	07.15→	4	DBB	0 445 110 351	0 986 435 204	
1.6 MultiJet [323]	1,6	77	198 A3.000 <M76>	10.08→	4	DBJ	0 445 110 300	0 986 435 171	F 00V C17 504
<b>Marea</b>									
1.9 JTD [185]	1,9	77	182 B4.000 <M1>	03.99-09.02	4	DBB	0 445 110 002	0 986 435 001	F 00V C17 504
		81	186 A6.000 <M4>	08.00-09.02	4				F 00V C17 504
			Mot.-Nr. →2805542	08.00-10.01	4	DBB	0 445 110 068	0 986 435 083	
			Mot.-Nr. 2805543→	11.01-09.02	4	DBB	0 445 110 119	0 986 435 083	
JTD S.W. [185]	1,9	74	182 B9.000 <M5>	10.01-09.02	4				F 00V C17 504
			Mot.-Nr. →2805542	10.01-10.01	4	DBB	0 445 110 068	0 986 435 083	
			Mot.-Nr. 2805543→	11.01-09.02	4	DBB	0 445 110 119	0 986 435 083	
2.4 JTD [185]	2,4	100	185 A6.000 <M3>	03.99-09.02	5	DBB	0 445 110 002	0 986 435 001	F 00V C17 504
<b>Marengo</b>									
1.9 JTD [285]	1,9	77	182 B4.000 <M1>	03.99-09.02	4	DBB	0 445 110 002	0 986 435 001	F 00V C17 504
		81	186 A6.000 <M4>	08.00-09.02	4				F 00V C17 504
			Mot.-Nr. →2805542	08.00-10.01	4	DBB	0 445 110 068	0 986 435 083	
			Mot.-Nr. 2805543→	11.01-09.02	4	DBB	0 445 110 119	0 986 435 083	
<b>Multipla</b>									
1.9 JTD [186]	1,9	77	182 B4.000 <M5>	01.99-12.00	4	DBB	0 445 110 002	0 986 435 001	F 00V C17 504
		81	186 A6.000 <M6>	08.00-03.02	4				F 00V C17 504
			Mot.-Nr. →2805542	08.00-10.01	4	DBB	0 445 110 068	0 986 435 083	
			Mot.-Nr. 2805543→	11.01-03.02	4	DBB	0 445 110 119	0 986 435 083	
		85	186 A8.000 <M7/EU3>	04.02-06.10	4	DBB	0 445 110 119	0 986 435 083	F 00V C17 504
			186 A8.000 <M87/EU4>	10.03-12.10	4	DBJ	0 445 110 276	0 986 435 148	
		88	186 A9.000 <M88>	10.05-12.10	4	DBJ	0 445 110 276	0 986 435 148	F 00V C17 504
<b>Palio</b>									
1.3 JTD 16V [178]	1,3	52	188 A9.000 <M40>	07.03-12.11	4	DBB	0 445 110 083	0 986 435 078	
<b>Palio Weekend</b>									
1.9 JTD [178]	1,9	57/80	188 A2.000 <M30>	10.01-12.08	4	DBB	0 445 110 019	0 986 435 006	F 00V C17 504
<b>Panda</b>									
1.3 JTD [169]	1,3	55	169 A1.000 <M73>	05.06-12.09	4	DBB	0 445 110 183	0 986 435 102	
JTD, JTD 4x4 [169]	1,3	52	188 A8.000 <ECOCF4>	01.09-09.10	4	DBB	0 445 110 083	0 986 435 078	
			188 A8.000 <M10>	01.04-12.09	4	DBB	0 445 110 083	0 986 435 078	
Multijet, Multijet 4x4 [169]	1,3	55	169 A5.000 <ECOCF5>	03.10-12.12	4	DBB	0 445 110 351	0 986 435 204	
MultiJet, MultiJet 4x4 [312]	1,3	55/59	199 A9.000 <ECOCF5>; 312 A8.000	01.15-08.16	4	DBB	0 445 110 351	0 986 435 204	
		59/70	225 A2.000; 312 B1.000; 312 B2.000; 330 A1.000	05.15→	4	DBB	0 445 110 614	0 986 435 249	
<b>Punto</b>									
1.3 JTD 16V [188]	1,3	51-52	188 A9.000 <M20>	06.03-12.10	4	DBB	0 445 110 083	0 986 435 078	
MultiJet [199]	1,3	55	199 A2.000 <ECOCF4>	01.12-08.13	4	DBB	0 445 110 183	0 986 435 102	
		55/59/62/ 70	199 A9.000 <ECOCF5>; 199 B1.000; 199 B4.000 <ECOCF5>; 199 B8.000	01.12-12.16	4	DBB	0 445 110 351	0 986 435 204	
		66/70	330 A1.000; 955 B2.000	05.16→	4	DBB	0 445 110 614	0 986 435 249	
1.9 JTD [188]	1,9	59/63	188 A2.000 <M5>; 188 A7.000 <M6>	07.99-06.03	4	DBB	0 445 110 019	0 986 435 006	F 00V C17 504
JTD 8V [188]	1,9	63	188 A7.000 <M25>	07.03-12.10	4	DBB	0 445 110 019	0 986 435 006	F 00V C17 504
		74	188 B2.000 <M30>	06.03-12.10	4	DBB	0 445 110 112	0 986 435 101	F 00V C17 504
<b>Punto Evo</b>									
1.3 MultiJet [199]	1,3	51/55-56/ 66	199 A2.000 <ECOCF4>; 199 A3.000 <M72 (ECOCF4)>; 199 B2.000 <ECOCF4>	10.09-12.11	4	DBB	0 445 110 183	0 986 435 102	
		55-56/62/ 68-70	199 A9.000 <ECOCF5>; 199 B1.000; 199 B4.000 <ECOCF5>	10.09-12.11	4	DBB	0 445 110 351	0 986 435 204	
1.6 MultiJet [199]	1,6	88	955 A3.000 <M78>	10.09-12.11	4	DBJ	0 445 110 300	0 986 435 171	F 00V C17 504
<b>Punto Van</b>									
1.3 JTD 16V [288]	1,3	51	188 A9.000 <M20>	07.03-12.10	4	DBB	0 445 110 083	0 986 435 078	
1.9 JTD, JTD 8V [288]	1,9	63	188 A7.000 <M6>; 188 A7.000 <M25>	05.99-12.10	4	DBB	0 445 110 019	0 986 435 006	F 00V C17 504
<b>Qubo</b>									
1.3 Multijet [300]	1,3	55	199 A2.000 <M73>	09.08→	4	DBB	0 445 110 183	0 986 435 102	





1.3 Multijet [300]	1,3	55/70	199 A9.000 <ECOFC5>; 199 B1.000	04.16→	4	DBB	0 445 110 351	0 986 435 204		
		59/70	225 A2.000; 330 A1.000	03.15→	4	DBB	0 445 110 614	0 986 435 249		
<b>Scudo</b>										
1.6 Multijet [270]	1,6	66	9HU <M1 - Euro 4>	01.07-04.16	4	DBJ	0 445 110 239	0 986 435 122	DW2	F 00V C17 504
MultiJet [270]	1,6	66	9H07 <M2 - Euro 5>	03.12-04.16	4	DBJ	0 445 110 340	0 986 435 203		
2.0 8V JTD [220]	2,0	70	RHX <M7/M14>	10.99-05.04	4				DW9	F 00V C17 504
			Ricam.Nr →8764	10.99-11.00	4	DBB,I1B	0 445 110 044	0 986 435 003		
					4	DBB,I2G	0 445 110 044	0 986 435 003		
			Ricam.Nr 8765→9065	12.00-09.01	4	DBB,I1B	0 445 110 076	0 986 435 077		
			Ricam.Nr 9066→	10.01-05.04	4	DBB,KKY	0 445 110 076	0 986 435 077		
		81	RHZ <M6/M13>	10.99-05.04	4	DBB,I1B	0 445 110 044	0 986 435 003	DW9	F 00V C17 504
					4	DBB,KKY	0 445 110 076	0 986 435 077	DW9	F 00V C17 504
8V JTD [222]	2,0	70	RHX <M7/M14>	06.04-01.07	4	DBB,KKY	0 445 110 076	0 986 435 077	DW9	F 00V C17 504
		81	RHZ <M13>	06.04-01.07	4	DBB,KKY	0 445 110 076	0 986 435 077	DW9	F 00V C17 504
16V JTD [220]	2,0	81	RHW <M11>	09.00-05.04	4				DW9	F 00V C17 504
<b>Sedici</b>										
1.9 JTD, JTD 4x4 [189]	1,9	88	D19AA <M88>	05.06-09.09	4	DBJ	0 445 110 276	0 986 435 148		F 00V C17 504
2.0 JTD, JTD 4x4 [189]	2,0	99	D20AA <M120>	08.09-12.14	4	DBJ	0 445 110 299	0 986 435 230		F 00V C17 504
<b>Stilo</b>										
1.9 JTD	1,9	85		06.02-12.07	4	DBB	0 445 110 119	0 986 435 083		F 00V C17 504
JTD 8V [192]	1,9	59	192 A3.000 <M40>	10.01-12.03	4					F 00V C17 504
				10.01-12.07	4	DBB	0 445 110 119	0 986 435 083		F 00V C17 504
				01.04-12.07	4	DBB	0 445 110 119	0 986 435 083		F 00V C17 504
			Mot.-Nr. 2805543→	11.01-12.03	4	DBB	0 445 110 119	0 986 435 083		
		66/85/88	192 A8.000 <M88>; 192 B5.000 <M83>; 937 A7.000 <M87>	07.05-12.07	4	DBJ	0 445 110 276	0 986 435 148		
		74	192 A9.000 <M45>	01.04-12.07	4	DBB	0 445 110 119	0 986 435 083		F 00V C17 504
		85	192 A1.000 <M50>	10.01-12.03	4					F 00V C17 504
				10.01-12.07	4	DBB	0 445 110 119	0 986 435 083		F 00V C17 504
				01.04-12.07	4	DBB	0 445 110 119	0 986 435 083		F 00V C17 504
			Mot.-Nr. 2805543→	11.01-12.03	4	DBB	0 445 110 119	0 986 435 083		
JTD 16V [192]	1,9	93	937 A4.000 <M61>	01.04-12.07	4	DBB	0 445 110 111	0 986 435 081		F 00V C17 504
		100	192 B1.000 <M62>	01.04-12.07	4	DBB	0 445 110 111	0 986 435 081		F 00V C17 504
		103	192 A5.000 <M60>	01.04-12.07	4	DBB	0 445 110 111	0 986 435 081		F 00V C17 504
		110	937 A5.000 <M92>	07.05-12.07	4	DBB	0 445 110 243	0 986 435 104		F 00V C17 504
<b>Stilo Multi Wagon</b>										
1.9 JTD 8V [192]	1,9	59	192 A3.000 <M40>	10.02-12.07	4	DBB	0 445 110 119	0 986 435 083		F 00V C17 504
		66/85/88	192 A8.000 <M88>; 192 B5.000 <M83>; 937 A7.000 <M87>	07.05-12.07	4	DBJ	0 445 110 276	0 986 435 148		
		74	192 A9.000 <M45>	09.04-12.07	4	DBB	0 445 110 119	0 986 435 083		F 00V C17 504
		85	192 A1.000 <M50>	10.02-12.07	4	DBB	0 445 110 119	0 986 435 083		F 00V C17 504
JTD 16V [192]	1,9	93	937 A4.000 <M61>	09.04-12.07	4	DBB	0 445 110 111	0 986 435 081		F 00V C17 504
		100	192 B1.000 <M62>	09.04-12.07	4	DBB	0 445 110 111	0 986 435 081		F 00V C17 504
		103	192 A5.000 <M60>	01.04-12.07	4	DBB	0 445 110 111	0 986 435 081		F 00V C17 504
		110	937 A5.000 <M92>	07.05-12.07	4	DBB	0 445 110 243	0 986 435 104		F 00V C17 504
<b>Strada</b>										
1.3 JTD [278]	1,3	63	223 A9.000 <M71>	07.05-12.11	4	DBB	0 445 110 183	0 986 435 102		
MultiJet [278]	1,3	70	199 B1.000	12.11-12.14	4	DBB,TW	0 445 110 351	0 986 435 204		
1.9 JTD [278]	1,9	59	188 A2.000 <M50>	04.03-06.05	4	DBB	0 445 110 019	0 986 435 006		F 00V C17 504
<b>Tipo</b>										
1.3 MultiJet [356]	1,3	70	199 B1.000	11.15→	4	DBB,TW	0 445 110 351	0 986 435 204		
					4	DBB,TW	0 445 110 813			
			55266963	11.15→	4	DBB	0 445 110 614	0 986 435 249		
1.6 MultiJet [356]	1,6	88	940 C1.000	11.15→	4	DBJ,TW	0 445 110 524	0 986 435 280		F 00V C17 504
					4	DBJ,TW	0 445 110 680			F 00V C17 504
<b>Tipo Hatchback</b>										
1.3 MultiJet [356]	1,3	70	55266963	05.16→	4	DBB	0 445 110 614	0 986 435 249		
1.6 MultiJet [356]	1,6	88	55260384	05.16→	4	DBJ,TW	0 445 110 524	0 986 435 280		F 00V C17 504
					4	DBJ,TW	0 445 110 680			F 00V C17 504
<b>Tipo Station Wagon</b>										
1.3 MultiJet [356]	1,3	70	55266963	06.16→	4	DBB	0 445 110 614	0 986 435 249		







◀ FIAT

1.6 MultiJet [356]	1,6	88	55260384	06.16→	4	DBJ,TW	0 445 110 524	0 986 435 280	F 00V C17 504
					4	DBJ,TW	0 445 110 680		F 00V C17 504
<b>Ulysse</b>									
2.0 JTD 8V [220]	2,0	80	RHZ <M9>	07.99-09.02	4	DBB,KZB, KZG	0 445 110 044	0 986 435 003	DW9 F 00V C17 504
JTD 16V [220]	2,0	80	RHW <M11>	11.00-09.02	4				DW9 F 00V C17 504
16V JTD [179]	2,0	79/80	RHM <M7>; RHW <M5>	10.02-01.06	4				DW9 F 00V C17 504
2.2 16V JTD [179]	2,2	94	4HW <M10>	10.02-09.07	4	DBB	0 445 110 036	0 986 435 013	
								0 986 435 014	
								0 986 435 015	
		120	4H... <DW12BTED4>	10.07-12.10	4	DBB	0 445 115 025	0 986 435 450	DW9 F 00V C17 504
		125	4HT <M11,M12,M13>	10.07-12.10	4	DBB	0 445 115 025	0 986 435 450	DW9 F 00V C17 504
<b>500</b>									
1.3 MultiJet [312]	1,3	55	169 A1.000 <M73>	07.07-12.12	4	DBB	0 445 110 183	0 986 435 102	
		57/70	312 B1.000; 312 B5.000	01.16→	4	DBB	0 445 110 614	0 986 435 249	
		70	199 B1.000 <M95>	07.14-12.15	4	DBB	0 445 110 351	0 986 435 204	
<b>500C</b>									
1.3 Multijet [312]	1,3	55	169 A1.000	07.09-12.12	4	DBB	0 445 110 183	0 986 435 102	
		70	199 B1.000	07.14-12.15	4	DBB	0 445 110 351	0 986 435 204	
MultiJet [312]	1,3	57/70	312 B1.000; 312 B5.000	01.16→	4	DBB	0 445 110 614	0 986 435 249	
<b>500L</b>									
1.3 MultiJet [199]	1,3	62	199 B4.000 <ECOCF5>	04.16→	4	DBB	0 445 110 351	0 986 435 204	
		70	330 A1.000	04.15→	4	DBB	0 445 110 614	0 986 435 249	
1.6 Multijet, MultiJet [199]	1,6	77/88	199 B5.000; 940 C1.000; 955 A3.000	03.13→	4	DBJ	0 445 110 524	0 986 435 280	F 00V C17 504
<b>500X</b>									
1.3 Multijet [334]	1,3	70	55266963	07.15→	4	DBB	0 445 110 614	0 986 435 249	
1.6 Multijet [334]	1,6	84-88	55260384	11.14→	4	DBJ	0 445 110 524	0 986 435 280	F 00V C17 504
2.0 Multijet 4x4 [334]	2,0	100-103	5526308...	11.14→	4	DBJ	0 445 110 419	0 986 435 213	F 00V C17 504



**FORD**

<b>B-MAX</b>									
1.5 TDCi [12]	1,5	55	UGJC <Euro5>	08.12-06.15	4	DBJ	0 445 110 488	0 986 435 288	F 00V C17 504
			XUJ... <Euro 6>	05.15→	4	DBJ	0 445 110 488	0 986 435 288	F 00V C17 504
		70	XVJ... <Euro 6>	05.15→	4	DBJ	0 445 110 488	0 986 435 288	F 00V C17 504
1.6 TDCi [12]	1,6	70	T3J... <Euro5>	08.12-06.15	4	DBJ	0 445 110 488	0 986 435 288	F 00V C17 504
<b>C-MAX</b>									
1.5 TDCi [15]	1,5	70	XXD... <Euro 6>	04.15→	4	DBJ	0 445 110 488	0 986 435 288	F 00V C17 504
		88	XWD... <Euro 6>	04.15→	4	DBJ	0 445 110 488	0 986 435 288	F 00V C17 504
TDCi Econetic [15]	1,5	77	AEDA <Euro 6>	04.15→	4	DBJ	0 445 110 488	0 986 435 288	F 00V C17 504
1.6 TDCi [07]	1,6	66	HHD... <Euro4>	03.07-07.10	4	DBJ	0 445 110 239	0 986 435 122	F 00V C17 504
		74-80	G8D... <Euro4>	03.07-07.10	4	DBJ	0 445 110 259	0 986 435 126	F 00V C17 504
<b>EcoSport</b>									
1.5 TDCi [14]	1,5	67/70	UGJE <Euro 5>; XVJD <Euro 6>	10.13-10.17	4	DBJ	0 445 110 488	0 986 435 288	F 00V C17 504
		74	XUJH <Euro 6>	11.17→	4	DBJ	0 445 110 488	0 986 435 288	F 00V C17 504
TDCi EcoBlue 4x4 [14]	1,5	92	ZTJA <Euro 6>	11.17→	4	DBJ	0 445 110 488	0 986 435 288	F 00V C17 504
<b>Fiesta</b>									
1.5 TD	1,5	66	Duratorq VDI	06.11→	4	DBJ	0 445 110 489	0 986 435 288	
<b>Fiesta V</b>									
1.6 TDCi [02]	1,6	66	HHJ... <Euro3/Euro4>	11.04-09.08	4	DBJ	0 445 110 239	0 986 435 122	F 00V C17 504
<b>Fiesta VI</b>									
1.4 TDCi [08]	1,4	51	KVJA <Euro5>	09.10-11.12	4	DBJ	0 445 110 339	0 986 435 172	F 00V C17 504
1.6 TDCi [08]	1,6	55/66	HHJ... <Euro4>; HHJF <Euro4>	07.08-11.12	4	DBJ	0 445 110 239	0 986 435 122	F 00V C17 504
		55/70	TZJ... <Euro5>; UBJA <Euro5>	03.10-11.12	4	DBJ	0 445 110 340	0 986 435 203	F 00V C17 504
		70	T3JA <Euro5>	02.12-11.12	4	DBJ	0 445 110 488	0 986 435 288	F 00V C17 504
<b>Fiesta VII</b>									
1.5 TDCi [13]	1,5	55	UGJ... <Euro4>	11.12→	4	DBJ	0 445 110 488	0 986 435 288	F 00V C17 504
			XUJ... <Euro 6>	02.15→	4	DBJ	0 445 110 488	0 986 435 288	F 00V C17 504
		70	XVJ... <Euro 6>	02.15→	4	DBJ	0 445 110 488	0 986 435 288	F 00V C17 504
1.6 TDCi [13]	1,6	70	TZJ... <Euro5>	11.12→	4	DBJ	0 445 110 488	0 986 435 288	F 00V C17 504



<b>1.6 TDCi ECOnetic [13]</b>	1,6	70	T3JA <Euro5>	11.12→	4	DBJ	<b>0 445 110 488</b>	<b>0 986 435 288</b>	<b>F 00V C17 504</b>
<b>Fiesta VIII</b>									
<b>1.5 TDCi [17]</b>	1,5	63/88	XUJ... <Euro 6>; XWJ... <Euro 6>	05.17→	4				<b>F 00V C17 504</b>
<b>Focus C-MAX</b>									
<b>1.6 TDCi [04]</b>	1,6	66	... <Euro3>	11.04-10.05	4	DBJ	<b>0 445 110 239</b>	<b>0 986 435 122</b>	<b>F 00V C17 504</b>
		80	G8D... <Euro3>	06.03-10.03	4	DBJ	<b>0 445 110 136</b>	<b>0 986 435 090</b>	<b>F 00V C17 504</b>
				06.03-03.07	4	CVT,DBJ	<b>0 445 110 285</b>		<b>F 00V C17 504</b>
					4	DBJ	<b>0 445 110 136</b>	<b>0 986 435 090</b>	<b>F 00V C17 504</b>
				11.03-10.05	4	CVT,DBJ	<b>0 445 110 188</b>	<b>0 986 435 090</b>	<b>F 00V C17 504</b>
				11.05-03.07	4	CVT,DBJ,	<b>0 445 110 259</b>	<b>0 986 435 126</b>	<b>F 00V C17 504</b>
						EU4			
					4	CVT,DBJ,	<b>0 445 110 188</b>	<b>0 986 435 090</b>	<b>F 00V C17 504</b>
						EU4			
<b>Focus II</b>									
<b>1.6 TDCi [04]</b>	1,6	66	HHD... <Euro3>	07.04-10.05	4	DBJ	<b>0 445 110 239</b>	<b>0 986 435 122</b>	<b>F 00V C17 504</b>
		74-80	G8D... <Euro3>	07.04-10.05	4	CVT,DBJ	<b>0 445 110 188</b>	<b>0 986 435 090</b>	<b>F 00V C17 504</b>
				07.04-01.08	4	CVT,DBJ	<b>0 445 110 285</b>		<b>F 00V C17 504</b>
					4	CVT,DBJ	<b>0 445 110 188</b>	<b>0 986 435 090</b>	<b>F 00V C17 504</b>
				11.05-01.08	4	CVT,DBJ,	<b>0 445 110 259</b>	<b>0 986 435 126</b>	<b>F 00V C17 504</b>
						EU4			
					4	CVT,DBJ,	<b>0 445 110 188</b>	<b>0 986 435 090</b>	<b>F 00V C17 504</b>
						EU4			
<b>TDCi [08]</b>	1,6	66	GPD... <Euro4/Euro5>	12.07-12.11	4	DBJ,EU5	<b>0 445 110 352</b>	<b>0 986 435 233</b>	<b>F 00V C17 504</b>
					4	DBJ,EU5	<b>0 445 110 239</b>	<b>0 986 435 122</b>	<b>F 00V C17 504</b>
			HHD... <Euro3>	12.07-12.11	4	DBJ	<b>0 445 110 239</b>	<b>0 986 435 122</b>	<b>F 00V C17 504</b>
		74-80	G8D... <Euro4>	12.07-12.11	4	DBJ,EU4	<b>0 445 110 259</b>	<b>0 986 435 126</b>	<b>F 00V C17 504</b>
					4	DBJ,EU5	<b>0 445 110 352</b>	<b>0 986 435 233</b>	<b>F 00V C17 504</b>
			G8D... <Euro4/Euro5>	12.07-12.11	4	DBJ,EU4	<b>0 445 110 259</b>	<b>0 986 435 126</b>	<b>F 00V C17 504</b>
					4	DBJ,EU5	<b>0 445 110 352</b>	<b>0 986 435 233</b>	<b>F 00V C17 504</b>
<b>Focus II Turnier</b>									
<b>1.6 TDCi [04]</b>	1,6	66	HHD... <Euro4>	07.04-10.05	4	DBJ	<b>0 445 110 239</b>	<b>0 986 435 122</b>	<b>F 00V C17 504</b>
		80	G8D... <Euro3>	07.04-10.05	4	CVT,DBJ	<b>0 445 110 188</b>	<b>0 986 435 090</b>	<b>F 00V C17 504</b>
				07.04-01.08	4	CVT,DBJ	<b>0 445 110 285</b>		<b>F 00V C17 504</b>
					4	CVT,DBJ	<b>0 445 110 188</b>	<b>0 986 435 090</b>	<b>F 00V C17 504</b>
				11.05-01.08	4	CVT,DBJ,	<b>0 445 110 259</b>	<b>0 986 435 126</b>	<b>F 00V C17 504</b>
						EU4			
					4	CVT,DBJ,	<b>0 445 110 188</b>	<b>0 986 435 090</b>	<b>F 00V C17 504</b>
						EU4			
<b>TDCi [08]</b>	1,6	66	GPD... <Euro4/Euro5>	12.07-12.11	4	DBJ,EU5	<b>0 445 110 352</b>	<b>0 986 435 233</b>	<b>F 00V C17 504</b>
					4	DBJ,EU5	<b>0 445 110 239</b>	<b>0 986 435 122</b>	<b>F 00V C17 504</b>
			HHD... <Euro3>	12.07-12.11	4	DBJ	<b>0 445 110 239</b>	<b>0 986 435 122</b>	<b>F 00V C17 504</b>
		74-80	G8D... <Euro3/Euro4/Euro5>	12.07-12.11	4	DBJ,EU4	<b>0 445 110 259</b>	<b>0 986 435 126</b>	<b>F 00V C17 504</b>
					4	DBJ,EU5	<b>0 445 110 352</b>	<b>0 986 435 233</b>	<b>F 00V C17 504</b>
<b>Focus III</b>									
<b>1.6 TDCi ECOnetic [11]</b>	1,6	77	NGD... <Euro5>	06.12-12.14	4	DBJ	<b>0 445 110 488</b>	<b>0 986 435 288</b>	<b>F 00V C17 504</b>
<b>Focus III Turnier</b>									
<b>1.6 TDCi ECOnetic [11]</b>	1,6	77	NGD... <Euro5>	06.12-12.14	4	DBJ	<b>0 445 110 488</b>	<b>0 986 435 288</b>	<b>F 00V C17 504</b>
<b>Focus IV</b>									
<b>1.5 TDCi [15]</b>	1,5	70	XXD... <Euro 6>	10.14→	4	DBJ	<b>0 445 110 488</b>	<b>0 986 435 288</b>	<b>F 00V C17 504</b>
		88	XWD... <Euro 6>	10.14→	4	DBJ	<b>0 445 110 488</b>	<b>0 986 435 288</b>	<b>F 00V C17 504</b>
<b>TDCi ECOnetic [15]</b>	1,5	77	AEDA <Euro 6>	10.14→	4	DBJ	<b>0 445 110 488</b>	<b>0 986 435 288</b>	<b>F 00V C17 504</b>
<b>Focus IV Turnier</b>									
<b>1.5 TDCi [15]</b>	1,5	70	XXD... <Euro 6>	10.14→	4	DBJ	<b>0 445 110 488</b>	<b>0 986 435 288</b>	<b>F 00V C17 504</b>
		88	XWD... <Euro 6>	10.14→	4	DBJ	<b>0 445 110 488</b>	<b>0 986 435 288</b>	<b>F 00V C17 504</b>
<b>TDCi ECOnetic [15]</b>	1,5	77	AEDA <Euro 6>	10.14→	4	DBJ	<b>0 445 110 488</b>	<b>0 986 435 288</b>	<b>F 00V C17 504</b>
<b>Fusion</b>									
<b>1.6 TDCi [02]</b>	1,6	66	HHJ... <Euro3/Euro4>	11.04-06.12	4	DBJ,EE2	<b>0 445 110 188</b>	<b>0 986 435 090</b>	<b>F 00V C17 504</b>
					4	DBJ,EU4	<b>0 445 110 239</b>	<b>0 986 435 122</b>	<b>F 00V C17 504</b>
<b>Galaxy</b>									
<b>2.2 TDCi [06]</b>	2,2	129	Q4WA <Euro4>	03.08-10.10	4	DBB	<b>0 445 115 025</b>	<b>0 986 435 450</b>	
		147	KNW... <Euro5>	11.10-12.14	4	DBJ	<b>0 445 115 088</b>	<b>0 986 435 434</b>	





◀ FORD

Ka										
1.3 TDCi [08]	1,3	55	169 A... <Euro4/Euro5>	09.08-10.10	4	DBB	0 445 110 183	0 986 435 102		
				11.10-12.14	4	DBB	0 445 110 351	0 986 435 204		
Kuga										
1.5 TDCi [13]	1,5	88	XWM... <Euro 6>	09.16→	4	DBJ	0 445 110 488	0 986 435 288	F 00V C17 504	
Mondeo IV										
2.2 TDCi [07]	2,2	129	Q4BA <Euro4>	03.08-11.10	4	DBB	0 445 115 025	0 986 435 450		
		147	KNB... <Euro 5>	11.10-12.14	4	DBJ	0 445 115 088	0 986 435 434		
Mondeo IV Turnier										
2.2 TDCi [07]	2,2	129	Q4BA <Euro4>	03.08-11.10	4	DBB	0 445 115 025	0 986 435 450		
		147	KNB... <Euro 5>	11.10-12.14	4	DBJ	0 445 115 088	0 986 435 434		
Mondeo V										
1.5 TDCi [15]	1,5	88	UGCC <Euro 6>	05.15→	4	DBJ	0 445 110 488	0 986 435 288	F 00V C17 504	
			TDCi ECOnetic [15]	XUCA <Euro 6>	05.15→	4	DBJ	0 445 110 488	0 986 435 288	F 00V C17 504
1.6 TDCi [15]	1,6	85	U3CA <Euro 5>	09.14→	4	DBJ	0 445 110 488	0 986 435 288	F 00V C17 504	
			TDCi ECOnetic [15]	NGCA <Euro 5>	09.14→	4	DBJ	0 445 110 488	0 986 435 288	F 00V C17 504
Mondeo V Turnier										
1.5 TDCi [15]	1,5	88	UGCC <Euro 6>	05.15→	4	DBJ	0 445 110 488	0 986 435 288	F 00V C17 504	
			TDCi ECOnetic [15]	XUCA <Euro 6>	05.15→	4	DBJ	0 445 110 488	0 986 435 288	F 00V C17 504
1.6 TDCi [15]	1,6	85	U3CA <Euro 5>	09.14→	4	DBJ	0 445 110 488	0 986 435 288	F 00V C17 504	
			TDCi ECOnetic [15]	NGCA <Euro 5>	09.14→	4	DBJ	0 445 110 488	0 986 435 288	F 00V C17 504
S-MAX										
2.2 TDCi [06]	2,2	129	Q4WA <Euro4>	03.08-10.10	4	DBB	0 445 115 025	0 986 435 450		
		147	KNW... <Euro5>	11.10-12.14	4	DBJ	0 445 115 088	0 986 435 434		
Tourneo Connect										
1.5 TDCi [13]	1,5	55	XUGA <Euro 6>	06.15→	4	DBJ	0 445 110 488	0 986 435 288	F 00V C17 504	
		74	XVG... <Euro 6>	06.15→	4	DBJ	0 445 110 488	0 986 435 288	F 00V C17 504	
		88	XWG... <Euro 6>	06.15→	4	DBJ	0 445 110 488	0 986 435 288	F 00V C17 504	
Tourneo Courier										
1.5 TDCi [14]	1,5	55	UGC... <Euro 5>	04.14-12.17	4	DBJ	0 445 110 488	0 986 435 288	F 00V C17 504	
			XUC... <Euro 6>	06.15→	4	DBJ	0 445 110 488	0 986 435 288	F 00V C17 504	
		70	XVC... <Euro 6>	06.15→	4	DBJ	0 445 110 488	0 986 435 288	F 00V C17 504	
1.6 TDCi [14]	1,6	70	T3C... <Euro 5>	04.14-12.17	4	DBJ	0 445 110 488	0 986 435 288	F 00V C17 504	



**GMC (GENERAL MOTORS CORP.)**

Sierra 2500 HD										
6.6	6,6	231	LLY	09.04-08.05	8	DBJ	0 445 120 027	0 986 435 504		

**GREAT WALL**

Hover CUV										
2.8 T	2,8	85	GW2.8TCI_EU3	01.04-02.11	4	DBJ	0 445 110 293			

**HONDA**

Accord Sedan											
2.2 CTDI [CN1]	2,2	103	N22A1	01.04-12.05	4	DBJ	0 445 110 172	0 986 435 145			
				Fg.-Nr. →3009347	01.04-06.08	4	DBJ	0 445 110 236	0 986 435 145		
				Fg.-Nr. 3009348→	01.04-06.08	4	DBJ	0 445 110 296	0 986 435 194		
i-DTEC, i-DTEC Type S [CU3]	2,2	110/132	N22B1; N22B2	07.08-12.15	4	DBJ	0 445 116 056	0 986 435 443			
Accord Tourer											
2.2 CTDI [CN2]	2,2	103	N22A1	01.04-12.05	4	DBJ	0 445 110 172	0 986 435 145			
				Fg.-Nr. →3103966	01.06-08.08	4	DBJ	0 445 110 236	0 986 435 145		
				Fg.-Nr. 3103967→	01.06-08.08	4	DBJ	0 445 110 296	0 986 435 194		
i-DTEC, i-DTEC Type S [CW3]	2,2	110/132	N22B1; N22B2	09.08-12.15	4	DBJ	0 445 116 056	0 986 435 443			
Civic Hatchback											
1.6 i-DTEC [FC/FK]	1,6	88	N16A1	02.18→	4	DBJ	0 445 110 532				



1.6 i-DTEC [FK/FN]	1,6	88	N16A1	12.12-02.17	4	DBJ	0 445 110 532	
2.2 CTDi [FK/FN]	2,2	103	N22A2	09.05-08.06	4	DBJ	0 445 110 236	0 986 435 145
				09.06-08.08	4	DBJ	0 445 110 288	
				09.08-12.11	4	DBJ	0 445 110 296	0 986 435 194
				09.11-12.13	4	DBJ	0 445 116 056	0 986 435 443
<b>Civic Sedan</b>								
1.6 i-DTEC [FC]	1,6	88	N16A1	02.18→	4	DBJ	0 445 110 532	
<b>Civic Tourer</b>								
1.6 i-DTEC [FK]	1,6	88	N16A1	12.13→	4	DBJ	0 445 110 532	
<b>CR-V</b>								
1.6 i-DTEC, i-DTEC 4WD [RE]	1,6	88/118	N16A2; N16A4	09.13→	4	DBJ	0 445 110 532	
2.2 CTDi 4x4 [RD]	2,2	103	N22A2	02.05-09.06	4	DBJ	0 445 110 236	0 986 435 145
				01.07-12.09	4	DBJ	0 445 110 288	
				01.10-12.14	4	DBJ	0 445 116 056	0 986 435 443
<b>FR-V</b>								
2.2 CTDi [BE]	2,2	103	N22A1					
			Fg.-Nr. →1513057	07.05-06.09	4	DBJ	0 445 110 236	0 986 435 145
			Fg.-Nr. 1513058→	07.05-06.09	4	DBJ	0 445 110 296	0 986 435 194
<b>HR-V</b>								
1.6 i-DTEC [RU]	1,6	88	N16A3	08.15→	4	DBJ	0 445 110 532	
								<b>HYUNDAI</b>
<b>Accent</b>								
1.5 CRDi [LC]	1,5	57-60	D3-EA	01.02-06.06	3	DBJ,KKA	0 445 110 101	0 986 435 147
					3	DBJ,KKY	0 445 110 101	0 986 435 147
				02.04→	3	DBJ	0 445 110 101	0 986 435 147
CRDi [MC, MCT]	1,5	81	D4FA <(1B) U15>	04.06-02.12	4	DBJ	0 445 110 255	0 986 435 152
<b>Accent blue</b>								
1.6 CRDi [RB]	1,6	94	D4FB <(1E) U162>	01.11-09.14	4	DBJ	0 445 110 319	0 986 435 186
				10.14→	4	DBJ	0 445 110 588	
<b>Accent Hatchback</b>								
1.5 CRDi [LC]	1,5	57-60	D3-EA	01.02-06.06	3	DBJ	0 445 110 101	0 986 435 147
CRDi [MC, MCT]	1,5	81	D4FA <(1B) U15>	04.06-02.12	4	DBJ	0 445 110 255	0 986 435 152
<b>Elantra</b>								
1.6 CRDi [AD]	1,6	100	D4FB <(1E) U162>	03.16→	4	DBJ	0 445 110 588	
CRDi [HD]	1,6	85	D4FB <(1C) U16>	08.06-06.11	4	DBJ	0 445 110 255	0 986 435 152
CRDi [MD, UD]	1,6	94	D4FB <(1E) U162>	01.14-11.15	4	DBJ	0 445 110 319	0 986 435 186
2.0 CRDi	2,0	83	D4EA	04.04-12.08	4	DBJ	0 445 110 255	0 986 435 152
				06.01-08.06	4	DBJ,KKA	0 445 110 101	0 986 435 147
					4	DBJ,KKY	0 445 110 101	0 986 435 147
<b>Elantra Hatchback</b>								
2.0 CRDi [XD]	2,0	83	D4EA <(2B) D20>	06.01-08.06	4	DBJ,KKA	0 445 110 101	0 986 435 147
					4	DBJ,KKY	0 445 110 101	0 986 435 147
<b>Getz</b>								
1.5 CRDi [TB]	1,5	60	D3-EA <TCI>	05.03-08.05	3	DBJ,KKY	0 445 110 290	0 986 435 174
		65/81	D4FA <TDI>; D4FA-L <TDI>	09.05-06.09	4	DBJ	0 445 110 255	0 986 435 152
<b>Grand Santa Fe</b>								
2.2 CRDi 4WD [NC]	2,2	145-147	D4HB <(2F) R22>	08.13→	4	DBJ,EU6, TW	0 445 110 584	
					4	DBJ,TW	0 445 116 017	0 986 435 420
<b>Grandeur</b>								
2.2 CRDi [TG]	2,2	110-114	D4EB <(2D) D22>	07.06-11.10	4	DBJ	0 445 110 253	0 986 435 155
<b>ix20</b>								
1.4 CRDi [JC]	1,4	57/66	D4FC <(1G) U142>; D4FC-M <(1G) U142>	03.15→	4	DBJ	0 445 110 586	
1.6 CRDi [JC]	1,6	85/94	D4FB <(1E) U162>	05.11-02.15	4	DBJ	0 445 110 319	0 986 435 186
				03.15→	4	DBJ	0 445 110 588	
<b>ix35</b>								
1.7 CRDi [LM, EL]	1,7	85	D4FD <(1F) U172>	09.10-07.15	4	DBJ	0 445 110 410	0 986 435 279





◀ HYUNDAI

2.0 CRDi, CRDi 4x4 [LM, EL]	2,0	100 129-135	D4HA <(2E) R20> D4HA <(2E) R20>	01.10-07.15 01.10-07.15	4 4	DBJ DBJ	0 445 110 373 0 445 116 017	0 986 435 243 0 986 435 420
<b>ix55</b>								
3.0 V6 CRDi 4x4 [EN]	3,0	176 184	D6EA <(9B) S30> D6EB <(9C) S32>	04.09-12.12 07.11-12.12	6 6	DBJ DBJ	0 445 115 045 0 445 116 048	0 986 435 391
<b>i10</b>								
1.1 CRDi [PA]	1,1	55	D3FA <(1A) U11>	03.08-12.10	3	DBJ	0 445 110 255	0 986 435 152
<b>i20</b>								
1.1 CRDi [GB]	1,1	55	D3FA <1H U2>	11.14→	3	DBJ	0 445 110 589	
1.4 [GB]	1,4	66	D4FC <1G U2>	11.14→	4	DBJ	0 445 110 586	
CRDi [PB/PBT]	1,4	55/66	D4FC <(1D) U14/(1G) U142>	10.08-12.14	4	DBJ,EU4	0 445 110 319	0 986 435 186
1.6 CRDi [PB/PBT]	1,6	85/94	D4FB <(1E) U162>	01.09-03.12	4	DBJ	0 445 110 319	0 986 435 186
<b>i20 Active</b>								
1.4 CRDi [GB]	1,4	66	D4FC <1G U2>	01.16→	4	DBJ	0 445 110 586	
<b>i20 Coupé</b>								
1.1 CRDi [GB]	1,1	55	D3FA <1H U2>	04.15→	3	DBJ	0 445 110 589	
1.4 [GB]	1,4	66	D4FC <1G U2>	04.15→	4	DBJ	0 445 110 586	
<b>i30</b>								
1.4 CRDi [GD]	1,4	66	D4FC <(1G) U142>	03.15→	4	DBJ	0 445 110 586	
1.6 CRDi [FD/FDH]	1,6	66/81-85	D4FB <(1C) U16/(1E) U162>	09.07-08.12	4	DBJ,TW	0 445 110 255	0 986 435 152
					4	DBJ,TW	0 445 110 319	0 986 435 186
		94	D4FB <(1E) U162>	11.08-12.11	4	DBJ	0 445 110 319	0 986 435 186
CRDi [GD]	1,6	81/94-100	D4FB <(1E) U162>	12.11-02.15	4	DBJ	0 445 110 319	0 986 435 186
				03.15→	4	DBJ	0 445 110 588	
CRDi [PD]	1,6	70/81/100	D4FB <1600 U2>	12.16→	4	DBJ	0 445 110 588	
CRDi [GD]	1,6	100	D4FB <(1E) U162>	02.16→	4	DBJ	0 445 110 588	
2.0 CRDi [FD/FDH]	2,0	100-103	D4EA <(2B) D20>	09.07-03.11	4	DBJ	0 445 110 257	0 986 435 156
<b>i30 Coupé</b>								
1.4 CRDi [GD]	1,4	66	D4FC <(1G) U142>	03.15→	4	DBJ	0 445 110 586	
1.6 CRDi [GD]	1,6	81/94	D4FB <(1E) U162>	02.13-02.15	4	DBJ	0 445 110 319	0 986 435 186
				03.15→	4	DBJ	0 445 110 588	
CRDi [GD]	1,6	100	D4FB	11.15→	4	DBJ	0 445 110 588	
<b>i30 CW</b>								
1.4 CRDi [GD]	1,4	66	D4FC <(1G) U142>	03.15→	4	DBJ	0 445 110 586	
1.6 CRDi [FD/FDH]	1,6	66/85	D4FB <(1C) U16/(1E) U162>	02.08-09.12	4	DBJ,TW	0 445 110 255	0 986 435 152
					4	DBJ,TW	0 445 110 319	0 986 435 186
		94	D4FB <(1E) U162>	11.08-09.12	4	DBJ	0 445 110 319	0 986 435 186
CRDi [GD]	1,6	81/94	D4FB <(1E) U162>	03.12-02.15	4	DBJ	0 445 110 319	0 986 435 186
				03.15→	4	DBJ	0 445 110 588	
CRDi [PD]	1,6	81/100	D4FB <1600 U2>	03.17→	4	DBJ	0 445 110 588	
CRDi [GD]	1,6	100	D4FB <(1E) U162>	02.16→	4	DBJ	0 445 110 588	
2.0 CRDi [FD/FDH]	2,0	100-103	D4EA <(2B) D20>	03.08-03.11	4	DBJ	0 445 110 257	0 986 435 156
<b>i40</b>								
1.7 CRDi [VF]	1,7	85/100-104	D4FD <(1F) U172>	04.11-02.15	4	DBJ	0 445 110 410	0 986 435 279
				03.15→	4	DBJ	0 445 110 588	
<b>i40 CW</b>								
1.7 CRDi [VF]	1,7	85/100-104	D4FD <(1F) U172>	04.11-02.15	4	DBJ	0 445 110 410	0 986 435 279
				03.15→	4	DBJ	0 445 110 588	
<b>Matrix</b>								
1.5 CRDi [FC]	1,5	60	D3-EA <TCI>	07.01-11.03	3	DBJ	0 445 110 101	0 986 435 147
				12.03-01.06	3	DBJ,KKY	0 445 110 290	0 986 435 174
		75	D4FA <TDI>	02.05-08.06	4	DBJ,EE2, I1B	0 445 110 222	0 986 435 160
					4	DBJ,EE2, I2G	0 445 110 222	0 986 435 160
					4	DBJ,EE2, I3K	0 445 110 222	0 986 435 160
					4	DBJ,N25	0 445 110 255	0 986 435 152





1.5 CRDi [FC]	1,5	81	D4FA-G <TDI>	09.06-10.06	4	DBJ,EE2, I1B	0 445 110 222	0 986 435 160
					4	DBJ,EE2, I2G	0 445 110 222	0 986 435 160
					4	DBJ,EE2, I3K	0 445 110 222	0 986 435 160
					4	DBJ,N25	0 445 110 255	0 986 435 152
				11.06-04.10	4	DBJ	0 445 110 255	0 986 435 152

**Santa Fe**

2.0 CRDi [DM]	2,0	83	D4EA	04.01-12.05	4	DBJ	0 445 110 101	0 986 435 147
CRDi, CRDi 4WD [DM]	2,0	110	D4HA <(2E) R20>	09.12-04.15	4	DBJ	0 445 110 373	0 986 435 243
				05.15→	4	DBJ	0 445 110 582	
CRDi, CRDi 4x4 [CM]	2,0	110	D4HA <(2E) R20>	09.10-12.12	4	DBJ	0 445 110 373	0 986 435 243
CRDi, CRDi 4x4 [SM]	2,0	83	<DOHC>; D4EA <(2B) D20>	06.00-12.05	4	DBJ	0 445 110 101	0 986 435 147
CRDi 4WD [DM]	2,0	135	D4HA <(2E) R20>	07.13-04.15	4	DBJ	0 445 116 017	0 986 435 420
				05.15→	4	DBJ	0 445 110 582	
CRDi-VGT 4x4 [SM]	2,0	92-107	D4EA-V	08.03-12.05	4	DBJ,KKY	0 445 110 101	0 986 435 147
2.2 CRDi, CRDi 4WD [DM]	2,2	145-147	D4HB <(2F) R22>	09.12-04.15	4	DBJ	0 445 116 017	0 986 435 420
				05.15→	4	DBJ	0 445 110 584	
CRDi, CRDi 4x4 [CM]	2,2	110-114	D4EB <(2D) D22>	03.06-11.09	4	DBJ	0 445 110 253	0 986 435 155
		145	D4HB <(2F) R22>	11.09-12.12	4	DBJ	0 445 116 017	0 986 435 420
VGT CRDi	2,2	153	HTI	11.05-12.12	4	DBJ	0 445 110 253	0 986 435 155

**Sante Fe**

2.0 CRDi [DM]	2,0	135	D4HA <(2E) R20>	07.13-04.15	4	DBJ	0 445 116 017	0 986 435 420
				05.15→	4	DBJ	0 445 110 582	

**Sonata**

2.0 CRDi [NF]	2,0	100-105/110	D4EA <(2B) D20>	01.06-12.07	4	DBJ	0 445 110 257	0 986 435 156
		110		01.06-12.10	4	DBJ	0 445 110 257	0 986 435 156
		105-110		01.07-12.11	4	DBJ	0 445 116 017	0 986 435 420

**Trajt**

2.0 CRDi [FO]	2,0	83-92	D4EA <(2B) D20>	01.01-06.07	4	DBJ	0 445 110 101	0 986 435 147
---------------	-----	-------	-----------------	-------------	---	-----	---------------	---------------

**Trajt XG**

2.0 CRDi	2,0	85	D4EA <(2B) D20>	12.00-12.03	4	DBJ	0 445 110 101	0 986 435 147
----------	-----	----	-----------------	-------------	---	-----	---------------	---------------

**Tucson**

1.7 CRDi [TL]	1,7	104	D4FD	03.16→	4	DBJ	0 445 110 588	
2.0 CRDi, CRDi 4x4 [JM]	2,0	83	D4EA <(2B) D20>	08.04-12.06	4	DBJ,KKY, N25	0 445 110 290	0 986 435 174
					4	DBJ,N25	0 445 110 257	0 986 435 156
		100-103	D4EA...	09.05-03.10	4	DBJ,N25	0 445 110 257	0 986 435 156
		110	D4EA <(2B) D20>	01.09-03.10	4	DBJ,N25	0 445 110 257	0 986 435 156
VGT CRDi [JM]	2,0	115		12.05→	4	DBJ	0 445 110 257	0 986 435 156

**Tuscon**

1.7 CRDi [TL]	1,7	85	D4FD	06.15→	4	DBJ	0 445 110 588	
2.0 CRDi, CRDi 4WD [TL]	2,0	100/136	D4HA <(2E) R20>	06.15→	4	DBJ	0 445 110 582	

**Verna**

1.5 CRDi [MC]	1,5	82	D4FA	09.05-05.11	4	DBJ	0 445 110 255	0 986 435 152
---------------	-----	----	------	-------------	---	-----	---------------	---------------

**INFINITI**

<b>EX 30</b>								
3.0 d 4x4 [J50]	3,0	175	V9X	04.10-06.14	6			2 430 105 043
<b>FX 30</b>								
3.0 d 4x4 [S51]	3,0	175	V9X	03.10-12.13	6			2 430 105 043
<b>M 30</b>								
3.0 d [Y51]	3,0	175	V9X	07.10-12.13	6			2 430 105 043
<b>Q 30</b>								
1.5 [H15E]	1,5	80	K9K	11.15→	4			2 430 105 043
<b>Q 70</b>								
3.0 CDi [Y51]	3,0	175	V9X	10.13-12.15	6			2 430 105 043
<b>QX 50</b>								
3.0 4x4	3,0	175	V9X	10.13→	6		TW	2 430 105 043







◀ INFINITI

<b>QX 70</b>										
3.0 CDiAWD [S51]	3,0	175	V9X		11.13-12.16	6				2 430 105 043

**IVECO**

<b>Massif</b>										
3.0 D	3,0	107/130	F1CE0481F*.; F1CE0481H*..		06.08-12.12	4	DBJ	0 445 110 248	0 986 435 163	

**JAGUAR**

<b>E-Pace</b>										
D150 , AWD [X540]	2,0	110	204DTD		09.17→	4	DBJ	0 445 110 653		F 00V P01 004
D180 AWD [X540]	2,0	132	204DTD		09.17→	4	DBJ	0 445 110 653		F 00V P01 004
D240 AWD [X540]	2,0	177	204DTA		09.17→	4	DBJ	0 445 110 700		F 00V P01 004

<b>F-Pace</b>										
E-Performance [X761]	2,0	120	204DTD		02.17→	4	DBJ	0 445 110 653		F 00V P01 004
2.0 D AWD [X761]	2,0	132	204DTD		04.16→	4	DBJ	0 445 110 653		F 00V P01 004
3.0 TDV6 AWD [X761]	3,0	221	306DT		04.16→	6	DBJ	0 445 116 012	0 986 435 403	

<b>XE</b>										
2.0 E-performance	2,0	120	204PT		06.15→	4	DBJ	0 445 110 663		F 00V P01 004
20d , AWD	2,0	132	204DTD; 204PT		06.15→	4	DBJ	0 445 110 653		F 00V P01 004

<b>XF</b>										
2.0 E-Performance [X260]	2,0	120	204PT		10.15→	4	DBJ	0 445 110 663		F 00V P01 004

2.2 D [X250]	2,2	120-147	224DT							
				Fg.-Nr. U09026→	09.11-10.15	4	DBJ,ERL	0 445 116 073	0 986 435 423	
						4	DBJ,LET	0 445 116 070		

			Fg.-Nr. →U09025	09.11-10.15	4	DBJ	0 445 115 088	0 986 435 434		
--	--	--	-----------------	-------------	---	-----	---------------	---------------	--	--

3.0 D, D V6, D V6S [X250]	3,0	155/177/202	AJV6D		03.09-10.15	6	DBJ	0 445 116 012	0 986 435 403	
---------------------------	-----	-------------	-------	--	-------------	---	-----	---------------	---------------	--

20d , AWD [X260]	2,0	132-177	204DTD		10.15→	4	DBJ	0 445 110 653		F 00V P01 004
------------------	-----	---------	--------	--	--------	---	-----	---------------	--	---------------

30d [X260]	3,0	221	306DT		10.15→	6	DBJ	0 445 116 012	0 986 435 403	
------------	-----	-----	-------	--	--------	---	-----	---------------	---------------	--

<b>XF Sportbrake</b>										
2.2 D	2,2	120-147	224DT							
				Fg.-Nr. U09026→	09.12-04.14	4	DBJ,ERL	0 445 116 073	0 986 435 423	
						4	DBJ,LET	0 445 116 070		

			Fg.-Nr. →U09025	09.12-04.14	4	DBJ	0 445 115 088	0 986 435 434		
--	--	--	-----------------	-------------	---	-----	---------------	---------------	--	--

3.0 D	3,0	177/202	AJV6D		09.12-04.14	6	DBJ	0 445 116 012	0 986 435 403	
-------	-----	---------	-------	--	-------------	---	-----	---------------	---------------	--

20d [X260]	2,0	132	204DTD		07.17→	4	DBJ	0 445 110 653		F 00V P01 004
------------	-----	-----	--------	--	--------	---	-----	---------------	--	---------------

<b>XJ</b>										
3.0 D V6, D V6 S [X351]	3,0	202/221	AJV6D; 306DT		08.10→	6	DBJ	0 445 116 012	0 986 435 403	

**JEEP**

<b>Cherokee</b>										
2.5 CRD 4x4 [KJ]	2,5	105	ENJ, ENO		03.01-12.04	4	DBJ	0 445 110 059	0 986 435 149	
2.8 CRD 4x4 [KJ]	2,8	112-120	ENR		03.03-12.04	4	DBJ	0 445 110 059	0 986 435 149	
					01.05-12.07	4	DBJ	0 445 110 218	0 986 435 128	

<b>Commander</b>										
3.0 CRD 4x4 [XH]	3,0	160-165	EXL		01.08-12.09	6	DBB	0 445 115 063	0 986 435 355	
					01.10-08.11	6	DBJ	0 445 115 064	0 986 435 355	

<b>Grand Cherokee</b>										
2.7 CRD [WG]	2,7	120	ENF		10.01-12.04	5	DBB	0 445 110 203	0 986 435 065	
3.0 CRD [WH]	3,0	160-165	EXL		09.07-08.09	6	DBB	0 445 115 063	0 986 435 355	
					09.09-10.11	6	DBJ	0 445 115 064	0 986 435 355	
				CRDi 4x4 [WK2]	3,0	140/177/184	...; VM--23D	01.14→	6	DBJ

<b>Liberty</b>										
2.8 CRD 4x4 [KJ]	2,8	112-120	ENR		08.05-08.06	4	DBJ	0 445 110 217	F 00E 200 440	0 986 435 263



<b>2.8 CRD 4x4 [KK]</b>	2,8	130/147	ENS		09.08-12.13	4	DBJ	<b>0 445 115 067</b>	<b>0 986 435 402</b>	
<b>Renegade</b>										
<b>1.6 MultiJet</b>	1,6	70-77/84-88	55260384		07.14→	4	DBJ	<b>0 445 110 524</b>	<b>0 986 435 280</b>	<b>F 00V C17 504</b>
<b>2.0 MultiJet 4x4</b>	2,0	88	55263087		07.14→	4	DBJ	<b>0 445 110 419</b>	<b>0 986 435 213</b>	<b>F 00V C17 504</b>
					04.15→	4	DBJ	<b>0 445 110 419</b>	<b>0 986 435 213</b>	<b>F 00V C17 504</b>
			103	5526308...	07.14→	4	DBJ	<b>0 445 110 419</b>	<b>0 986 435 213</b>	<b>F 00V C17 504</b>
					04.15→	4	DBJ	<b>0 445 110 419</b>	<b>0 986 435 213</b>	<b>F 00V C17 504</b>
			125	55263088	07.14→	4	DBJ	<b>0 445 110 419</b>	<b>0 986 435 213</b>	<b>F 00V C17 504</b>
		04.15→	4	DBJ	<b>0 445 110 419</b>	<b>0 986 435 213</b>	<b>F 00V C17 504</b>			
4x4	2,0	125	ECD		04.15→	4	DBJ	<b>0 445 110 682</b>	<b>0 986 435 289</b>	
<b>Wrangler</b>										
<b>2.8 CRD [JK]</b>	2,8	130-147	ENS		01.07-12.10	4	DBJ	<b>0 445 115 067</b>	<b>0 986 435 402</b>	

**KIA**

<b>Carens</b>													
<b>1.6 CRDi [UN]</b>	1,6	85/94	D4FB <1600 U2>		09.10→	4	DBJ	<b>0 445 110 319</b>	<b>0 986 435 186</b>	<b>F 00V P01 004</b>			
					11.11→	4	DBJ	<b>0 445 110 319</b>	<b>0 986 435 186</b>	<b>F 00V P01 004</b>			
<b>1.7 CRDi [RP]</b>	1,7	85/100-103	D4FD		01.13-07.16	4	DBJ	<b>0 445 110 410</b>	<b>0 986 435 279</b>	<b>F 00V P01 004</b>			
					01.13→	4	DBJ	<b>0 445 110 410</b>	<b>0 986 435 279</b>	<b>F 00V P01 004</b>			
					08.16→	4	DBJ	<b>0 445 110 588</b>		<b>F 00V P01 004</b>			
<b>2.0 CRDi, CRDi VGT [FJ]</b>	2,0	83/85/103	D4EA		02.02-08.06	4	DBJ	<b>0 445 110 101</b>	<b>0 986 435 147</b>				
				CRDi, CRDi VGT [UN]	2,0	85/100/103	D4EA; D4EA-L; D4EA-W	09.06→	4	DBJ	<b>0 445 110 257</b>	<b>0 986 435 156</b>	
<b>Carnival</b>													
<b>2.2 CRDi [MB]</b>	2,2	110/143	D4HB <2.2L-R>		10.09-12.12	4	DBJ	<b>0 445 116 017</b>	<b>0 986 435 420</b>	<b>F 00V P01 004</b>			
<b>Cee'd</b>													
<b>1.4 CRDi [JD]</b>	1,4	66	D4FC <1G U2>		06.15→	4	DBJ	<b>0 445 110 586</b>		<b>F 00V P01 004</b>			
<b>1.6 CRDi [ED/FF2]</b>	1,6	66	D4FB-L		11.06-01.09	4	DBJ	<b>0 445 110 255</b>	<b>0 986 435 152</b>	<b>F 00V P01 004</b>			
					02.09-12.12	4	DBJ	<b>0 445 110 319</b>	<b>0 986 435 186</b>	<b>F 00V P01 004</b>			
					11.11-12.12	4	DBJ	<b>0 445 110 255</b>	<b>0 986 435 152</b>	<b>F 00V P01 004</b>			
				85	D4FB <1600 U2>		11.06-01.09	4	DBJ	<b>0 445 110 255</b>	<b>0 986 435 152</b>	<b>F 00V P01 004</b>	
						02.09-12.12	4	DBJ	<b>0 445 110 319</b>	<b>0 986 435 186</b>	<b>F 00V P01 004</b>		
						11.11-12.12	4	DBJ	<b>0 445 110 255</b>	<b>0 986 435 152</b>	<b>F 00V P01 004</b>		
				94	D4FB <1600 U2>		09.10-12.12	4	DBJ	<b>0 445 110 319</b>	<b>0 986 435 186</b>	<b>F 00V P01 004</b>	
						11.11-12.12	4	DBJ	<b>0 445 110 319</b>	<b>0 986 435 186</b>	<b>F 00V P01 004</b>		
			CRDi [JD]	1,6	81	D4FB <1600 U2>		05.12-05.15	4	DBJ	<b>0 445 110 319</b>	<b>0 986 435 186</b>	<b>F 00V P01 004</b>
								05.12→	4	DBJ	<b>0 445 110 319</b>	<b>0 986 435 186</b>	<b>F 00V P01 004</b>
	06.15→	4					DBJ	<b>0 445 110 588</b>		<b>F 00V P01 004</b>			
	94	D4FB <1600 U2>						05.12→	4	DBJ	<b>0 445 110 319</b>	<b>0 986 435 186</b>	<b>F 00V P01 004</b>
	100		D4FB		07.15→	4	DBJ	<b>0 445 110 588</b>	<b>F 00V P01 004</b>				
<b>2.0 CRDi [ED/FF2]</b>	2,0	103	D4EA-F		09.07-12.12	4	DBJ	<b>0 445 110 257</b>	<b>0 986 435 156</b>				
<b>Cee'd Sporty Wagon</b>													
<b>1.4 [JD]</b>	1,4	66	D4FC <1G U2>		06.15→	4	DBJ	<b>0 445 110 586</b>		<b>F 00V P01 004</b>			
<b>1.6 [JD]</b>	1,6	81/94	D4FB <1600 U2>		08.12-05.15	4	DBJ	<b>0 445 110 319</b>	<b>0 986 435 186</b>	<b>F 00V P01 004</b>			
					08.12→	4	DBJ	<b>0 445 110 319</b>	<b>0 986 435 186</b>	<b>F 00V P01 004</b>			
					06.15→	4	DBJ	<b>0 445 110 588</b>		<b>F 00V P01 004</b>			
					CRDi [ED/FF2]	1,6	66	D4FB-L		09.07-01.09	4	DBJ	<b>0 445 110 255</b>
			02.09-12.12	4	DBJ	<b>0 445 110 319</b>	<b>0 986 435 186</b>		<b>F 00V P01 004</b>				
			11.11-12.12	4	DBJ	<b>0 445 110 255</b>	<b>0 986 435 152</b>		<b>F 00V P01 004</b>				
		85	D4FB <1600 U2>		09.07-01.09	4	DBJ	<b>0 445 110 255</b>	<b>0 986 435 152</b>	<b>F 00V P01 004</b>			
				02.09-12.12	4	DBJ	<b>0 445 110 319</b>	<b>0 986 435 186</b>	<b>F 00V P01 004</b>				
				11.11-12.12	4	DBJ	<b>0 445 110 255</b>	<b>0 986 435 152</b>	<b>F 00V P01 004</b>				
		94	D4FB <1600 U2>		09.10-12.12	4	DBJ	<b>0 445 110 319</b>	<b>0 986 435 186</b>	<b>F 00V P01 004</b>			
				11.11-12.12	4	DBJ	<b>0 445 110 319</b>	<b>0 986 435 186</b>	<b>F 00V P01 004</b>				
CRDi [JD]	1,6	100	D4FB		07.15→	4	DBJ	<b>0 445 110 588</b>		<b>F 00V P01 004</b>			
<b>2.0 CRDi [ED/FF2]</b>	2,0	103	D4EA-F		09.07-12.12	4	DBJ	<b>0 445 110 257</b>	<b>0 986 435 156</b>				
<b>Cerato</b>													
<b>1.5 CRDi [FE]</b>	1,5	75	D4FA		06.05-11.09	4	DBJ	<b>0 445 110 222</b>	<b>0 986 435 160</b>				





◀ KIA

1.6 CRDi [FE]	1,6	85	D4FB <1600 U2>	06.05-11.09	4	DBJ	0 445 110 255	0 986 435 152	
2.0 CRDi [FE]	2,0	83	D4EA	04.04-11.09	4	DBJ,KKY	0 445 110 290	0 986 435 174	
<b>Cerato Hatchback</b>									
1.5 CRDi [FE]	1,5	75	D4FA	06.05-11.09	4	DBJ	0 445 110 222	0 986 435 160	
1.6 CRDi [FE]	1,6	85	D4FB <1600 U2>	06.05-11.09	4	DBJ	0 445 110 255	0 986 435 152	
2.0 CRDi [FE]	2,0	83	D4EA	04.04-11.09	4	DBJ,KKY	0 445 110 290	0 986 435 174	
<b>Magentis</b>									
2.0 CRDi [GE]	2,0	103/110	D4EA	02.06-04.10	4	DBJ	0 445 110 257	0 986 435 156	
<b>Mohave</b>									
3.0 CRDi	3,0	184	<3.0S / 3.0S2>	01.09→	6	DBJ,EU3	0 445 115 045	0 986 435 391	F 00V P01 004
					6	DBJ,EU4	0 445 116 048		F 00V P01 004
<b>Optima</b>									
1.7 CRDi [JF]	1,7	104	D4FD <1,7-U2>	07.16→	4	DBJ	0 445 110 588		F 00V P01 004
CRDi [TF]	1,7	100-103	D4FD <1,7-U2>	09.11→	4	DBJ	0 445 110 410	0 986 435 279	F 00V P01 004
				11.11→	4	DBJ	0 445 110 410	0 986 435 279	F 00V P01 004
<b>Picanto</b>									
1.1 CRDi [SA]	1,1	55	D3FA <1H U2>	11.05-01.11	3	DBJ	0 445 110 255	0 986 435 152	
<b>Pride</b>									
1.5 TCI-U [JB]	1,5	82	D4FA	05.05-08.11	4	DBJ	0 445 110 255	0 986 435 152	
<b>Pro Cee'd</b>									
1.4 CRDi [JD]	1,4	66	D4FC <1G U2>	06.15→	4	DBJ	0 445 110 586		F 00V P01 004
1.6 CRDi [ED]	1,6	66	D4FB-FL	03.08-01.09	4	DBJ	0 445 110 255	0 986 435 152	F 00V P01 004
				02.09-12.12	4	DBJ	0 445 110 319	0 986 435 186	F 00V P01 004
				11.11-12.12	4	DBJ	0 445 110 255	0 986 435 152	F 00V P01 004
		85	D4FB <1600 U2>	03.08-01.09	4	DBJ	0 445 110 255	0 986 435 152	F 00V P01 004
				02.09-12.12	4	DBJ	0 445 110 319	0 986 435 186	F 00V P01 004
				11.11-12.12	4	DBJ	0 445 110 255	0 986 435 152	F 00V P01 004
		94	D4FB <1600 U2>	09.10-12.12	4	DBJ	0 445 110 319	0 986 435 186	F 00V P01 004
				11.11-12.12	4	DBJ	0 445 110 319	0 986 435 186	F 00V P01 004
CRDi [JD]	1,6	81	D4FB <1600 U2>	01.13-05.15	4	DBJ	0 445 110 319	0 986 435 186	F 00V P01 004
				01.13→	4	DBJ	0 445 110 319	0 986 435 186	F 00V P01 004
				06.15→	4	DBJ	0 445 110 588		F 00V P01 004
		94	D4FB <1600 U2>	01.13→	4	DBJ	0 445 110 319	0 986 435 186	F 00V P01 004
		100	D4FB	07.15→	4	DBJ	0 445 110 588		F 00V P01 004
2.0 CRDi [ED]	2,0	103	D4EA	03.08-12.12	4	DBJ	0 445 110 257	0 986 435 156	
<b>Rio</b>									
1.5 CRDi [JB, DE]	1,5	65/81	D4FA	03.05-09.11	4	DBJ	0 445 110 255	0 986 435 152	
<b>Rio Hatchback</b>									
1.1 CRDi [UB]	1,1	55	D3FA <1H U2>	11.14→	3	DBJ	0 445 110 589		
1.4 CRDi [UB]	1,4	66	D4FC <1G U2>	11.14→	4	DBJ	0 445 110 586		F 00V P01 004
CRDi [YB]	1,4	57/66	D4FC <1G U2>	02.17→	4	DBJ	0 445 110 586		F 00V P01 004
1.5 CRDi [JB, DE]	1,5	65/81	D4FA	03.05-09.11	4	DBJ	0 445 110 255	0 986 435 152	
<b>Sorento</b>									
2.0 CRDi, CRDi 4x4 [XM]	2,0	110	D4HA	10.10→	4	DBJ	0 445 110 373	0 986 435 243	F 00V P01 004
CRDi 4x4 [UM]	2,0	136	D4HA	02.15→	4	DBJ	0 445 110 581		F 00V P01 004
2.2 CRDi, CRDi 4x4 [UM]	2,2	147	D4HB <2.2L-R>	02.15→	4	DBJ	0 445 110 583		F 00V P01 004
CRDi, CRDi 4x4 [XM]	2,2	145	D4HB <2.2L-R>	09.09→	4	DBJ	0 445 116 017	0 986 435 420	F 00V P01 004
2.5 CRDi [BL]	2,5	107	D4CB	02.02-12.03	4	DBJ	0 445 110 091	0 986 435 154	
				01.04-12.09	4	DBJ	0 445 110 279	0 986 435 182	
CRDi [JC,BL]	2,5	103	D4CB	07.02-12.03	4	DBJ	0 445 110 091	0 986 435 154	F 00V C17 504
				07.02-08.09	4	DBJ	0 445 110 091	0 986 435 154	F 00V C17 504
				01.04-08.09	4	DBJ	0 445 110 279	0 986 435 182	F 00V C17 504
		120-125	D4CB	03.06-08.09	4	DBJ,TW	0 445 110 274	0 986 435 180	F 00V C17 504
					4	DBJ,TW	0 445 110 279	0 986 435 182	F 00V C17 504
<b>Soul</b>									
1.6 CRDi [AM]	1,6	85/94	D4FB <1600 U2>	02.09-12.14	4	DBJ	0 445 110 319	0 986 435 186	F 00V P01 004
				11.11-12.14	4	DBJ	0 445 110 319	0 986 435 186	F 00V P01 004
CRDi [PS]	1,6	94-100	D4FB	03.14-07.16	4	DBJ	0 445 110 319	0 986 435 186	F 00V P01 004
				03.14→	4	DBJ	0 445 110 319	0 986 435 186	F 00V P01 004
				08.16→	4	DBJ	0 445 110 588		F 00V P01 004
<b>Sportage</b>									
1.7 CRDi [QL]	1,7	85/104	D4FD	01.16→	4	DBJ	0 445 110 588		F 00V P01 004





1.7 CRDi [SL]	1,7	85	D4FD	09.10→	4	DBJ,EU5	0 445 110 410	0 986 435 279	F 00V P01 004	
					4	DBJ,EU6	0 445 110 588		F 00V P01 004	
					11.11→	4	DBJ,EU5	0 445 110 410	0 986 435 279	F 00V P01 004
2.0 CRDi	2,0	100	<D2,0 Gen 1>	08.04-12.05	4	DBJ,WGT	0 445 110 290	0 986 435 174		
					01.06→	4	DBJ,VGT	0 445 110 257	0 986 435 156	
					09.04-04.07	4	DBJ	0 445 110 290	0 986 435 174	
						01.06-04.07	4	DBJ	0 445 110 257	0 986 435 156
					05.07-05.10	4	DBJ,EU3	0 445 110 290	0 986 435 174	
CRDi, CRDi 4x4 [KM]	2,0	83	D4EA	100-103	4	DBJ,EU4	0 445 110 257	0 986 435 156		
					110	D4EA	05.07-05.10	4	DBJ,EU3	0 445 110 290
CRDi, CRDi 4x4 [QL]	2,0	100/136	D4HA	01.16→	4	DBJ	0 445 110 581		F 00V P01 004	
CRDi, CRDi 4x4 [SL]	2,0	100	D4HA	07.10→	4	DBJ	0 445 110 373	0 986 435 243	F 00V P01 004	
CRDi, CRDi 4x4 [SL]	2,0	135	D4HA	01.11→	4	DBJ	0 445 116 017	0 986 435 420	F 00V P01 004	
<b>Stinger</b>										
2.2 CRDi, CRDi AWD [CK]	2,2	147	D4HC	10.17→	4	DBJ	0 445 110 583		F 00V P01 004	
<b>Stonic</b>										
1.6 CRDi [YB]	1,6	81	D4FB	10.17→	4	DBJ	0 445 110 588		F 00V P01 004	
<b>Venga</b>										
1.4 CRDi [YN]	1,4	55-57/66	D4FC <1G U2>	12.09→	4	DBJ,TW	0 445 110 586		TW F 00V P01 004	
1.6 CRDi [YN]	1,6	85/94	D4FB <1600 U2>	12.09→	4	DBJ,TW	0 445 110 319	0 986 435 186	F 00V P01 004	
					4	DBJ,TW	0 445 110 588		F 00V P01 004	
					11.11→	4	DBJ,TW	0 445 110 319	0 986 435 186	F 00V P01 004

## LANCIA

**Delta**

1.6 MultiJet [844]	1,6	77	844 A3.000; 944 A3.000	04.11-08.14	4	DBJ,N5P	0 445 110 300	0 986 435 171	F 00V C17 504
					4	5PL,DBJ	0 445 110 524	0 986 435 280	F 00V C17 504
		85	955 A4.000	07.08-12.14	4	DBJ,N5P	0 445 110 300	0 986 435 171	F 00V C17 504
					4	5PL,DBJ	0 445 110 524	0 986 435 280	F 00V C17 504
		88	198 A2.000 <M78>	07.08-12.14	4	DBJ,N5P	0 445 110 300	0 986 435 171	F 00V C17 504
					4	5PL,DBJ	0 445 110 524	0 986 435 280	F 00V C17 504
1.9 MultiJet [844]	1,9	140	844 A1.000 <M94>	08.08-08.14	4	DBJ	0 445 110 299	0 986 435 230	F 00V C17 504
2.0 MultiJet [844]	2,0	120	844 A2.000	08.08-08.14	4	DBJ	0 445 110 299	0 986 435 230	F 00V C17 504
		121	198 A5.000 <M120>	08.08-08.14	4	DBJ	0 445 110 299	0 986 435 230	F 00V C17 504

**Kappa Berlina**

2.4 JTD [838]	2,4	100	838A8.000 <M3>	03.98-12.00	5	DBB	0 445 110 002	0 986 435 001	F 00V C17 504
---------------	-----	-----	----------------	-------------	---	-----	---------------	---------------	---------------

**Kappa Station Wagon**

2.4 JTD [838]	2,4	100	838A8.000 <M3>	03.98-12.00	5	DBB	0 445 110 002	0 986 435 001	F 00V C17 504
---------------	-----	-----	----------------	-------------	---	-----	---------------	---------------	---------------

**Lybra Berlina**

1.9 JTD [839]	1,9	77	AR32302 <M1 CF2>	10.99-09.00	4	DBB	0 445 110 002	0 986 435 001	F 00V C17 504
		80/85	AR37101 <M2 CF3>; 937 A2.000 <M3 CF3>	09.00-11.06	4	DBB	0 445 110 119	0 986 435 083	F 00V C17 504
2.4 JTD [839]	2,4	98	839A5.000/AR32501 <M6/M5 CF2>	10.99-09.00	5	DBB	0 445 110 002	0 986 435 001	F 00V C17 504
					103	839A6.000 <M7 CF3>	09.00-08.01	5	DBB
		103	839A6.000 <M7 CF3>	09.00-05.02	5	DBB	0 445 110 068	0 986 435 083	F 00V C17 504
				09.01-05.02	5	DBB	0 445 110 119	0 986 435 083	F 00V C17 504
		110	841C000 <M8 CF3>	06.02-09.05	5	DBB	0 445 110 119	0 986 435 083	F 00V C17 504

**Lybra Station Wagon**

1.9 JTD [839]	1,9	77	AR32302 <M1 CF2>	10.99-09.00	4	DBB	0 445 110 002	0 986 435 001	F 00V C17 504
		80	AR37101 <M2 CF3>	09.00-06.01	4	DBB	0 445 110 068	0 986 435 083	F 00V C17 504
		85	937 A2.000 <M3 CF3>	06.01-11.06	4	DBB	0 445 110 119	0 986 435 083	F 00V C17 504
2.4 JTD [839]	2,4	98	839A5.000/AR32501 <M6/M5 CF2>	10.99-09.00	5	DBB	0 445 110 002	0 986 435 001	F 00V C17 504
					103	839A6.000 <M7 CF3>	09.00-08.01	5	DBB
		103	839A6.000 <M7 CF3>	09.00-05.02	5	DBB	0 445 110 068	0 986 435 083	F 00V C17 504
				09.01-05.02	5	DBB	0 445 110 119	0 986 435 083	F 00V C17 504
		110	841C000 <M8 CF3>	06.02-09.05	5	DBB	0 445 110 119	0 986 435 083	F 00V C17 504

**Musa**

1.3 MultiJet [350]	1,3	51-55	188 A9.000 <M30>	10.04-11.10	4	DBB	0 445 110 083	0 986 435 078	
		66	199 A3.000 <M72 (ECOCF4)>	09.05-11.10	4	DBB	0 445 110 183	0 986 435 102	





◀ LANCIA

<b>1.6</b> MultiJet [350]	1,6	85/88	350 A2.000; 350 A3.000	10.07-12.12	4	DBJ	<b>0 445 110 300</b>	<b>0 986 435 171</b>	<b>F 00V C17 504</b>
<b>1.9</b> MultiJet [350]	1,9	74	188 B2.000 <M40>	10.04-12.12	4	DBJ	<b>0 445 110 187</b>	<b>0 986 435 099</b>	<b>F 00V C17 504</b>
<b>Phedra</b>									
<b>2.2</b> JTD 16V [179]	2,2	95	4HW <M10>	09.02-09.07	4	DBB	<b>0 445 110 036</b>	<b>0 986 435 013</b>	
								<b>0 986 435 014</b>	
								<b>0 986 435 015</b>	
		120/125	4HP <DW12BTED4>; 4HT <M11,M12,M13>	10.07-12.10	4	DBB	<b>0 445 115 025</b>	<b>0 986 435 450</b>	DW9 <b>F 00V C17 504</b>
<b>Thesis</b>									
<b>2.4</b> JTD 10V [841]	2,4	110	841C.000 <M20>	04.02-02.05	5	DBB	<b>0 445 110 119</b>	<b>0 986 435 083</b>	<b>F 00V C17 504</b>
JTD 20V [841]	2,4	120	841M.000 <M22>	06.03-02.06	5	DBB	<b>0 445 110 111</b>	<b>0 986 435 081</b>	<b>F 00V C17 504</b>
			841N.000 <M23>	06.03-02.06	5	DBB	<b>0 445 110 111</b>	<b>0 986 435 081</b>	<b>F 00V C17 504</b>
		129	841G.000 <M24>	06.03-02.06	5	DBB	<b>0 445 110 111</b>	<b>0 986 435 081</b>	<b>F 00V C17 504</b>
			841H.000 <M25>	06.03-02.06	5	DBB	<b>0 445 110 111</b>	<b>0 986 435 081</b>	<b>F 00V C17 504</b>
		136	841 P.000 <M99 CF4>	03.06-12.09	5	DBJ	<b>0 445 110 213</b>	<b>0 986 435 162</b>	<b>F 00V C17 504</b>
<b>Ypsilon</b>									
<b>1.3</b> JTD [843]	1,3	51	188 A9.000 <M15>	06.03-09.06	4	DBB	<b>0 445 110 083</b>	<b>0 986 435 078</b>	
MultiJet [312]	1,3	57/70	199 B1.000; 312 B1.000; 312 B5.000	06.11→ 01.14→	4	DBB,EU6	<b>0 445 110 614</b>	<b>0 986 435 249</b>	
MultiJet [843]	1,3	55	199 A2.000 <ECOCF4>; 199 A9.000 <ECOCF5>	09.09-11.11	4	DBB	<b>0 445 110 351</b>	<b>0 986 435 204</b>	
		55/66	199 A2.000 <M73>; 199 A3.000 <M72 (ECOCF4)>	10.06-11.11	4	DBB	<b>0 445 110 183</b>	<b>0 986 435 102</b>	
		77	199 A3.000 <M105>	10.06-11.11	4	DBJ	<b>0 445 110 322</b>		
<b>Zeta</b>									
<b>2.0</b> JTD [122]	2,0	80	RHZ <M4>	06.99-06.02	4	DBJ	<b>0 445 110 008</b>	<b>0 986 435 003</b>	

**LAND ROVER GROUP**

<b>Discovery IV</b>									
<b>3.0</b> TDV6 [LA]	3,0	155	306DT	09.10→	6	DBJ	<b>0 445 116 064</b>		
		180-184	306DT	09.09-08.10	6	DBJ	<b>0 445 116 012</b>	<b>0 986 435 403</b>	
		180-200	306DT	09.10→	6	DBJ,LEN	<b>0 445 116 066</b>		
			Fg.-Nr. GA000001→	09.10→	6	DBJ,ERL	<b>0 445 117 052</b>		
<b>Discovery Sport</b>									
<b>2.0</b> TD4 [B5,L550]	2,0	110/132	AJ200 <204DTD>	09.15→	4	DBJ	<b>0 445 110 653</b>		
<b>2.2</b> SD4 AWD, TD4 [B5,L550]	2,2	110/140	224DT	09.14→	4	DBJ,TW	<b>0 445 116 043</b>	<b>0 986 435 423</b>	
					4	DBJ,TW	<b>0 445 116 070</b>		
<b>Discovery V</b>									
<b>2.0</b> Sd4 AWD [LR,B6]	2,0	177	204DTA	04.17→	4	DBJ	<b>0 445 110 700</b>		<b>F 00V P01 004</b>
Td4 AWD [LR,B6]	2,0	132	AJ200 <204DTD>	04.17→	4	DBJ	<b>0 445 110 653</b>		<b>F 00V P01 004</b>
<b>3.0</b> Td6 AWD [LR,B6]	3,0	155-190	306DTX	04.17→	6	DBJ	<b>0 445 117 052</b>		
<b>Freelander I</b>									
<b>2.0</b> TD4 [LN]	2,0	80-82	TD4 204D3						
			Fg.-Nr. →3A239591	09.01-10.06	4	DBJ	<b>0 445 110 049</b>	<b>0 986 435 095</b>	
			Fg.-Nr. 3A239592→	09.01-10.06	4	AG,DBJ	<b>0 445 110 130</b>	<b>0 986 435 096</b>	
					4	DBJ,GS	<b>0 445 110 049</b>	<b>0 986 435 095</b>	
<b>Freelander II</b>									
<b>2.2</b> eD4 [LF]	2,2	110	DW12BTED4						
			Fg.-Nr. BH000001→	09.10-11.14	4	DBJ	<b>0 445 116 043</b>	<b>0 986 435 423</b>	
			Mod.Jahr 2011→						
			Fg.-Nr. →AH999999	09.10-11.14	4	DBB	<b>0 445 115 042</b>	<b>0 986 435 362</b>	
			Mod.Jahr →2010						
SD4, Td4 [LF]	2,2	110-118/ 140	224DT						
			Fg.-Nr. BH000001→	10.06-11.14	4	DBJ	<b>0 445 116 043</b>	<b>0 986 435 423</b>	
			Mod.Jahr 2011→						
			Fg.-Nr. →AH999999	10.06-11.14	4	DBB	<b>0 445 115 042</b>	<b>0 986 435 362</b>	
			Mod.Jahr →2010						
<b>Range Rover Evoque</b>									
<b>2.0</b> eD4, TD4 AWD [LV]	2,0	110/132	AJ200 <204DTD>	09.15→	4	DBJ	<b>0 445 110 653</b>		
<b>2.2</b> eD4 [LV]	2,2	110	224DT	09.12-08.16	4	DBJ	<b>0 445 116 070</b>		
SD4 AWD [LV]	2,2	140	224DT	09.11-08.15	4	DBJ	<b>0 445 116 043</b>	<b>0 986 435 423</b>	



<b>2.2 TD4 AWD [LV]</b>	2,2	110	224DT	09.11-08.15	4	DBJ	<b>0 445 116 043</b>	<b>0 986 435 423</b>	
<b>Range Rover Evoque Cabrio</b>									
<b>2.0 TD4 AWD</b>	2,0	110/132	AJ200 <204DTD>	03.16→	4	DBJ	<b>0 445 110 653</b>		
<b>Range Rover III</b>									
<b>3.0 Td6 [LM,L322]</b>	2,9	130	M57 D30 <30 6D 1>	03.02-09.06	6	DBJ	<b>0 445 110 266</b>	<b>0 986 435 022</b>	
<b>4.4 TDV8 [LM,L322]</b>	4,4	230	4,4	09.10-01.13	8	DBJ	<b>0 445 116 074</b>	<b>0 986 435 457</b>	
<b>Range Rover IV</b>									
<b>3.0 TD AWD [LG,L405]</b>	3,0	155	306DT	10.13→	6	DBJ	<b>0 445 117 052</b>		
		155-190	306DT	02.13→	6	DBJ,ERL	<b>0 445 117 052</b>		
					6	DBJ,LET	<b>0 445 116 064</b>		
<b>4.4 SD AWD [LG,L405]</b>	4,4	250	448DT	01.14→	8	DBJ	<b>0 445 116 074</b>	<b>0 986 435 457</b>	
<b>Range Rover Sport</b>									
<b>2.0 SD4 [LW,L494]</b>	2,0	177	AJ200 <204DTD>	09.16→	4	DBJ	<b>0 445 110 700</b>	<b>F 00V P01 004</b>	
<b>3.0 SDV6 [LW,L494]</b>	3,0	215-225	306DT	09.13→	6	DBJ	<b>0 445 117 052</b>		
SDV6, TDV6	3,0	155-188	306DT	09.09-08.13	6	DBJ	<b>0 445 116 012</b>	<b>0 986 435 403</b>	
[LS,L320]									
TDV6 [LW,L494]	3,0	183-190	306DTX	09.13→	6	DBJ	<b>0 445 116 064</b>		
<b>4.4 SDV8 [LW,L494]</b>	4,4	250	448DT	01.14→	8	DBJ	<b>0 445 116 074</b>	<b>0 986 435 457</b>	
<b>Range Rover Velar</b>									
<b>D180 AWD [LS560]</b>	2,0	132	204DTD	08.17→	4	DBJ	<b>0 445 110 653</b>	<b>F 00V P01 004</b>	
<b>D240 AWD [LS560]</b>	2,0	177	204DTA	08.17→	4	DBJ	<b>0 445 110 700</b>	<b>F 00V P01 004</b>	
<b>D300 AWD [LS560]</b>	3,0	221	306DT	08.17→	6	DBJ	<b>0 445 117 052</b>		

**LUFENG**

**Landwind**

<b>2.5 D</b>	2,5	156	VM_EU3	10.06-02.07	4	DBJ	<b>0 445 110 321</b>	
--------------	-----	-----	--------	-------------	---	-----	----------------------	--

**MAHINDRA**

**Quanto**

<b>1.5 D [U203]</b>	1,5	74	MCR100	09.12→	4	DBJ	<b>0 445 110 525</b>	
---------------------	-----	----	--------	--------	---	-----	----------------------	--

**Scorpio**

<b>2.2 D 4x4 [MI]</b>	2,2	87	mHAWK	08.09→	4	DBJ	<b>0 445 110 498</b>	
TD [MI]	2,2	87	mHAWK	11.07-12.14	4	DBJ	<b>0 445 110 310</b>	<b>0 986 435 296</b>

<b>2.6 CRDe</b>	2,6	85	SZ CRDe	02.05-06.09	4	DBJ	<b>0 445 110 260</b>	
-----------------	-----	----	---------	-------------	---	-----	----------------------	--

**Thar**

<b>2.5 D 4x4</b>	2,5	77	NEF CRDe	12.10→	4	DBJ	<b>0 445 110 260</b>	
------------------	-----	----	----------	--------	---	-----	----------------------	--

**XUV500**

<b>2.2 D, D 4x4</b>	2,2	103	mHAWK	09.11→	4	DBJ	<b>0 445 110 498</b>	
---------------------	-----	-----	-------	--------	---	-----	----------------------	--

**MAZDA**

**BT-50**

<b>2.5 D Turbo [UN]</b>	2,5	105	WL3 <DuraTORQ TDCi>	03.06-09.06	4			<b>F 00V C17 504</b>
D Turbo, D Turbo 4x4	2,5	105	WLC <DuraTORQ TDCi>	03.06-09.06	4	DBB	<b>0 445 110 250</b>	<b>0 986 435 123</b>
[UN]				03.06-07.12	4	DBB	<b>0 445 110 250</b>	<b>0 986 435 123</b>
<b>3.0 D Turbo, D Turbo 4x4</b>	3,0	115	WEC <DuraTORQ TDCi>	03.06-09.06	4	DBB	<b>0 445 110 249</b>	<b>0 986 435 178</b>
[UN]				03.06→	4	DBB	<b>0 445 110 249</b>	<b>0 986 435 178</b>

**CX-3**

<b>1.5 D, D 4x4 [DK]</b>	1,5	77	S5 <Skyactiv-D>	02.15→	4			<b>F 00V C17 504</b>
--------------------------	-----	----	-----------------	--------	---	--	--	----------------------

**CX-5**

<b>2.2 D, D 4x4 [KE]</b>	2,2	110/129	SH <Skyactiv-D>	01.12→	4			<b>F 00V C17 504</b>
D, D 4x4 [KF]	2,2	110/129	SH <Skyactiv-D>	02.17→	4			<b>F 00V C17 504</b>

**CX-7**

<b>2.2 MZR CD 4x4 [ER]</b>	2,2	120/127	R2	06.09→	4			<b>F 00V C17 504</b>
----------------------------	-----	---------	----	--------	---	--	--	----------------------

**2**

<b>1.5 D [DJ]</b>	1,5	77	S5 <Skyactiv-D>	10.14→	4			<b>F 00V C17 504</b>
-------------------	-----	----	-----------------	--------	---	--	--	----------------------







◀ MAZDA

1.6 CD [DE]	1,6	66	Y6	Fg.-Nr. →DEA4**400000 →DEA3**300000	11.08-07.10	4	DBJ	<b>0 445 110 239</b>	<b>0 986 435 122</b>
<b>3</b>									
1.5 D [BM]	1,5	77	S5 <Skyactiv-D>		10.15→	4			<b>F 00V C17 504</b>
D [BN]	1,5	77	S5 <Skyactiv-D>		09.16→	4			<b>F 00V C17 504</b>
1.6 MZ-CD [BK]	1,6	80	Y6		12.03-03.06	4	DBJ	<b>0 445 110 188</b>	<b>0 986 435 090</b>
					04.06-12.08	4	DBJ	<b>0 445 110 259</b>	<b>0 986 435 126</b>
MZR-CD [BL]	1,6	80-81	Y6		12.08-07.11	4	DBJ	<b>0 445 110 188</b>	<b>0 986 435 090</b>
2.2 D [BM]	2,2	110	SH <Skyactiv-D>		08.13→	4			<b>F 00V C17 504</b>
D [BN]	2,2	110	SH <Skyactiv-D>		07.16→	4			<b>F 00V C17 504</b>
MZR-CD [BL]	2,2	110/136	R2		01.09-07.11	4			<b>F 00V C17 504</b>
<b>3 Hatchback</b>									
1.5 D [BM]	1,5	77	S5 <Skyactiv-D>		10.15→	4			<b>F 00V C17 504</b>
D [BN]	1,5	77	S5 <Skyactiv-D>		09.16→	4			<b>F 00V C17 504</b>
1.6 MZ-CD [BK]	1,6	66	Y6		10.05-12.08	4	DBJ,EU3	<b>0 445 110 188</b>	<b>0 986 435 090</b>
				Fg.-Nr. 605426→	04.06-12.08	4	DBJ	<b>0 445 110 239</b>	<b>0 986 435 122</b>
		80	Y6		12.03-09.05	4	DBJ	<b>0 445 110 188</b>	<b>0 986 435 090</b>
					10.05-12.08	4	DBJ	<b>0 445 110 259</b>	<b>0 986 435 126</b>
MZR-CD [BL]	1,6	80-81	Y6		12.08-07.11	4	DBJ	<b>0 445 110 188</b>	<b>0 986 435 090</b>
2.2 D [BM]	2,2	110	SH <Skyactiv-D>		07.13→	4			<b>F 00V C17 504</b>
D [BN]	2,2	110	SH <Skyactiv-D>		07.16→	4			<b>F 00V C17 504</b>
MZR-CD [BL]	2,2	110/136	R2		01.09-10.13	4			<b>F 00V C17 504</b>
<b>5</b>									
2.0 CD [CR]	2,0	81/105	RF		03.05-12.10	4			<b>F 00V C17 504</b>
<b>6</b>									
2.0 D Turbo [GG/GY]	2,0	89/100-105	RF		06.02-08.07	4			<b>F 00V C17 504</b>
MZR-CD [GH]	2,0	103	RF		11.07-01.10	4			<b>F 00V C17 504</b>
2.2 D [GJ]	2,2	110/129	SH <Skyactiv-D>		10.12→	4			<b>F 00V C17 504</b>
D [GL]	2,2	110/129	SH <Skyactiv-D>		06.16→	4			<b>F 00V C17 504</b>
MZR-CD [GH]	2,2	92/95/120/132/136	R2		01.09-12.12	4			<b>F 00V C17 504</b>
<b>6 Fastback</b>									
2.0 D Turbo [GG/GY]	2,0	89/100-105	RF		06.02-08.07	4			<b>F 00V C17 504</b>
MZR-CD [GH]	2,0	103	RF		11.07-01.10	4			<b>F 00V C17 504</b>
2.2 MZR-CD [GH]	2,2	92/95/120/132/136	R2		01.09-12.12	4			<b>F 00V C17 504</b>
<b>6 Wagon</b>									
2.0 D Turbo [GG/GY]	2,0	89/100-105	RF		06.02-12.07	4			<b>F 00V C17 504</b>
MZR-CD [GH]	2,0	103	RF		12.07-01.10	4			<b>F 00V C17 504</b>
2.2 D, D 4x4 [GJ]	2,2	110/129	SH <Skyactiv-D>		08.12→	4			<b>F 00V C17 504</b>
D, D 4x4 [GL]	2,2	110/129	SH <Skyactiv-D>		06.16→	4			<b>F 00V C17 504</b>
MZR-CD [GH]	2,2	92/95/120/132/136	R2		10.08-12.12	4			<b>F 00V C17 504</b>
5.5 D 4x4 [GJ]	2,2	110	SH <Skyactiv-D>		11.14→	4			<b>F 00V C17 504</b>



**MERCEDES-BENZ**

**Serie A**

160 CDI [168]	1,7	44	OM 668.941 <DE 17 A>		09.98-02.01	4			<b>1 987 972 076</b>
			Mot.-Nr. →30 210110		09.98-02.01	4	DBB	<b>0 445 110 014</b>	<b>0 986 435 005</b>
			Mot.-Nr. 30 210111→30 368241		09.98-02.01	4	DBB	<b>0 445 110 115</b>	<b>0 986 435 057</b>
			Mot.-Nr. 30 368242→		09.98-02.01	4	DBB	<b>0 445 110 195</b>	<b>0 986 435 057</b>



<b>160</b> CDI [168]	1,7	55	OM 668.940 <DE 17 LA>	03.01-08.04	4							<b>1987 972 076</b>
			Mot.-Nr. →30 210110	03.01-08.04	4	DBJ	<b>0 445 110 014</b>	<b>0 986 435 005</b>				
			Mot.-Nr. 30 210111→30 368241	03.01-08.04	4	DBB	<b>0 445 110 115</b>	<b>0 986 435 057</b>				
			Mot.-Nr. 30 368242→	03.01-08.04	4	DBB	<b>0 445 110 195</b>	<b>0 986 435 057</b>				
CDI [169]	2,0	60	OM 640.942 <DE 20 LA>	09.04-04.12	4	DBB,EU5, WAS	<b>0 445 110 166</b>	<b>0 986 435 117</b>				<b>1987 972 076</b>
					4	DBB,WAS	<b>0 445 110 323</b>	<b>0 986 435 187</b>				<b>1987 972 076</b>
			Mod.Jahr →2009	09.04-04.12	4	DBB,EU5, WAS	<b>0 445 110 166</b>	<b>0 986 435 117</b>				<b>1987 972 076</b>
			Mod.Jahr 2010→	09.04-04.12	4	DBB,EU5, WAS	<b>0 445 110 377</b>	<b>0 986 435 189</b>				
<b>170</b> CDI [168]	1,7	66	OM 668.940 <DE 17 LA>	07.98-02.01	4							<b>1987 972 076</b>
			Mot.-Nr. →30 210110	07.98-02.01	4	DBJ	<b>0 445 110 014</b>	<b>0 986 435 005</b>				
			Mot.-Nr. 30 210111→30 368241	07.98-02.01	4	DBB	<b>0 445 110 115</b>	<b>0 986 435 057</b>				
			Mot.-Nr. 30 368242→	07.98-02.01	4	DBB	<b>0 445 110 195</b>	<b>0 986 435 057</b>				
		70	OM 668.942 <DE 17 LA>	03.01-08.04	4							<b>1987 972 076</b>
			Mot.-Nr. →30 210110	03.01-08.04	4	DBJ	<b>0 445 110 014</b>	<b>0 986 435 005</b>				
			Mot.-Nr. 30 210111→30 368241	03.01-08.04	4	DBB	<b>0 445 110 115</b>	<b>0 986 435 057</b>				
			Mot.-Nr. 30 368242→	03.01-08.04	4	DBB	<b>0 445 110 195</b>	<b>0 986 435 057</b>				
<b>180</b> CDI [169]	2,0	80	OM 640.940 <DE 20 LA>	09.04-04.12	4	DBB,EU5, WAS	<b>0 445 110 166</b>	<b>0 986 435 117</b>				<b>1987 972 076</b>
					4	DBB,WAS	<b>0 445 110 323</b>	<b>0 986 435 187</b>				<b>1987 972 076</b>
			Mod.Jahr →2009	09.04-04.12	4	DBB,EU5, WAS	<b>0 445 110 166</b>	<b>0 986 435 117</b>				<b>1987 972 076</b>
			Mod.Jahr 2010→	09.04-04.12	4	DBB,EU5, WAS	<b>0 445 110 377</b>	<b>0 986 435 189</b>				
CDI [176]	1,8	80	OM 651.901 <18 LHD>	06.12-12.14	4							<b>1987 972 076</b>
	2,1	100	OM 651.930 <D 22 LHD>	03.15→	4					156		<b>1987 972 076</b>
<b>200</b> CDI [169]	2,0	103	OM 640.941 <DE 20 LA>	09.04-04.12	4	DBB,EU5, WAS	<b>0 445 110 166</b>	<b>0 986 435 117</b>				<b>1987 972 076</b>
					4	DBB,WAS	<b>0 445 110 323</b>	<b>0 986 435 187</b>				<b>1987 972 076</b>
			Mod.Jahr →2009	09.04-04.12	4	DBB,EU5, WAS	<b>0 445 110 166</b>	<b>0 986 435 117</b>				<b>1987 972 076</b>
			Mod.Jahr 2010→	09.04-04.12	4	DBB,EU5, WAS	<b>0 445 110 377</b>	<b>0 986 435 189</b>				
CDI [176]	1,8	100	OM 651.901 <18 LHD>	06.12-12.14	4							<b>1987 972 076</b>
CDI, CDI 4MATIC, d, d 4MATIC [176]	2,1	100	OM 651.930 <D 22 LHD>	02.14→	4					156		<b>1987 972 076</b>
<b>220</b> CDI, CDI 4MATIC [176]	2,1	120-125	OM 651.930 <D 22 LHD>	06.12-06.15	4	DBB,MLU	<b>0 445 117 034</b>	<b>0 986 435 428</b>				<b>1987 972 076</b>
d, d 4MATIC [176]	2,1	130	OM 651.930 <D 22 LHD>	07.15→	4					156		<b>1987 972 076</b>
<b>Serie B</b>												
<b>180</b> CDI [245]	2,0	80	OM 640.940 <DE 20 LA>	04.05-05.11	4	DBB,EU5, WAS	<b>0 445 110 166</b>	<b>0 986 435 117</b>				<b>1987 972 076</b>
					4	DBB,WAS	<b>0 445 110 323</b>	<b>0 986 435 187</b>				<b>1987 972 076</b>
			Mod.Jahr →2009	04.05-05.11	4	DBB,EU5, WAS	<b>0 445 110 166</b>	<b>0 986 435 117</b>				<b>1987 972 076</b>
			Mod.Jahr 2010→	04.05-05.11	4	DBB,EU5, WAS	<b>0 445 110 377</b>	<b>0 986 435 189</b>				
CDI [246]	1,8	80	OM 651.901 <18 LHD>	09.11-12.15	4							<b>1987 972 076</b>
<b>200</b> CDI [245]	2,0	100-103	OM 640.941 <DE 20 LA>	04.05-05.11	4	DBB,EU5, WAS	<b>0 445 110 166</b>	<b>0 986 435 117</b>				<b>1987 972 076</b>
					4	DBB,WAS	<b>0 445 110 323</b>	<b>0 986 435 187</b>				<b>1987 972 076</b>
			Mod.Jahr →2009	04.05-05.11	4	DBB,EU5, WAS	<b>0 445 110 166</b>	<b>0 986 435 117</b>				<b>1987 972 076</b>
			Mod.Jahr 2010→	04.05-05.11	4	DBB,EU5, WAS	<b>0 445 110 377</b>	<b>0 986 435 189</b>				
CDI [246]	1,8	100	OM 651.901 <18 LHD>	09.11-05.15	4							<b>1987 972 076</b>
d [246]	2,1	100	OM 651.930 <D 22 LHD>	08.14→	4					156		<b>1987 972 076</b>
<b>220</b> CDI [246]	2,1	125	OM 651.930 <D 22 LHD>	04.12→	4							<b>1987 972 076</b>
CDI 4MATIC [246]	2,1	100	OM 651.930 <D 22 LHD>	09.14→	4					156		<b>1987 972 076</b>
d [246]	2,1	130	OM 651.930 <D 22 LHD>	07.15→	4							<b>1987 972 076</b>
d 4MATIC [246]	2,1	130	OM 651.930 <D 22 LHD>	09.14→	4					156		<b>1987 972 076</b>





◀ MERCEDES-BENZ

Serie C										
30 AMG CDI [203]	3,0	170	OM 612.990 <DE 30 LA AMG>	01.03-08.04	5	DBB	0 445 110 151			1 987 972 076
180 CDI [204]	2,1	88	OM 651.913 <D 22 LHD RED>	10.10-12.14	4	BO,DBB	0 445 117 034	0 986 435 428		1 987 972 076
200 CDI [202]	2,2	75	OM 611.960 <DE LA>	03.98-04.00	4	DBB	0 445 110 011	0 986 435 004		1 987 972 076
CDI [203]	2,2	75	OM 646.962 <DE 22 LA>	03.03-07.07	4	DBB,MPR	0 445 110 237	0 986 435 139		1 987 972 076
					4	DBB,MPR	0 445 110 176	0 986 435 111		1 987 972 076
		85	OM 611.962 <DE LA>	10.00-05.03	4					1 987 972 076
			Mot.-Nr. →30 314413	10.00-05.03	4	DBB	0 445 110 024	0 986 435 020		
			→40 059864							
			Mot.-Nr. 30 314414→30 445712	10.00-05.03	4	DBB	0 445 110 199	0 986 435 061		
			40 059865→40 068033							
			Mot.-Nr. 30 445713→	10.00-05.03	4	AG,DBB	0 445 110 205	0 986 435 067		
			40 068034→							
		90	OM64696... <DE 22 LA>	03.03-07.07	4	DBB	0 445 110 176	0 986 435 111		1 987 972 076
CDI [204]	2,1	100	OM 651.913 <D 22 LHD RED>	04.08-12.14	4	BO,DBB	0 445 117 034	0 986 435 428		1 987 972 076
	2,2	100	OM 646.81... <DE 22 LALL>	01.07-12.10	4					1 987 972 076
d [205]	2,1	100	OM 651.921 <D 22 LHD>	10.15→	4				156	1 987 972 076
			Komp.Nr. A11	10.15→	4	DBB,TW	0 445 117 034	0 986 435 428		
220 BlueTec [205]	2,1	120	OM 651.921 <D 22 LHD>	04.14-11.15	4					1 987 972 076
BlueTec, d, d 4MATIC [205]	2,1	120/125	OM 651.921 <D 22 LHD>							
			Komp.Nr. A11	11.13→	4	DBB,TW	0 445 117 034	0 986 435 428		
		125	OM 651.921 <D 22 LHD>	11.13→	4				156	1 987 972 076
CDI [202]	2,2	92	OM 611.960 <DE LA>	12.97-04.00	4	DBB	0 445 110 011	0 986 435 004		1 987 972 076
CDI [203]	2,2	100-105	OM 611.962 <DE LA>	05.00-02.03	4					1 987 972 076
			Mot.-Nr. →30 314413	05.00-02.03	4	DBB	0 445 110 024	0 986 435 020		
			→40 059864							
			Mot.-Nr. 30 314414→30 445712	05.00-02.03	4	DBB	0 445 110 199	0 986 435 061		
			40 059865→40 068033							
			Mot.-Nr. 30 445713→	05.00-02.03	4	AG,DBB	0 445 110 205	0 986 435 067		
			40 068034→		4	DBB,GS	0 445 110 199	0 986 435 061		
		110	OM 646.963 <DE 22 LA>	03.03-02.07	4	DBB	0 445 110 176	0 986 435 111		1 987 972 076
CDI [204]	2,1	125	OM 651.911 <D 22 LHD>	12.08-12.14	4	BO,DBB	0 445 117 034	0 986 435 428	156	1 987 972 076
	2,2	120-125	OM 646.811 <DE 22 LALL>	03.07-04.09	4					1 987 972 076
CDI 4MATIC [204]	2,1	125	OM 651.912 <D 22 LHD>	03.13-12.14	4	BO,DBB	0 445 117 034	0 986 435 428		1 987 972 076
250 BlueTec, BlueTec 4MATIC [205]	2,1	150	OM 651.921 <D 22 LHD>	02.14-12.15	4					1 987 972 076
BlueTec, BlueTec 4MATIC, d [205]	2,1	150	OM 651.921 <D 22 LHD>							
			Komp.Nr. A11	02.14→	4	DBB,TW	0 445 117 034	0 986 435 428		
CDI [204]	2,2	150	OM 651.911 <D 22 LHD>	09.08-12.14	4	BO,DBB	0 445 117 034	0 986 435 428		1 987 972 076
CDI 4MATIC [204]	2,1	150	OM 651.912 <D 22 LHD>	04.10-12.14	4					1 987 972 076
d [205]	2,1	150	OM 651.921 <D 22 LHD>	12.15→	4				156	1 987 972 076
270 CDI [203]	2,7	125	OM 612.962 <DE LA>	12.00-08.04	5					1 987 972 076
			Mot.-Nr. →..067962	12.00-08.04	5	DBB	0 445 110 024	0 986 435 020		
			Mot.-Nr. ..067963→..133151	12.00-08.04	5	DBB	0 445 110 199	0 986 435 061		
			Mot.-Nr. ..133152→	12.00-08.04	5	AG,DBB	0 445 110 205	0 986 435 067		
					5	DBB,GS	0 445 110 199	0 986 435 061		
300 CDI 4MATIC [204]	3,0	170	OM 642.832 <D 30>	03.11-12.14	6	DBB,SCJ	0 445 116 025	0 986 435 404		1 987 972 076
					6	DBB,SCJ	0 445 115 059	0 986 435 396		1 987 972 076
320 CDI [203]	3,0	165	OM 642.910 <D 30>	09.04-05.07	6	DBB	0 445 115 063	0 986 435 355		1 987 972 076
CDI [204]	3,0	165	OM 642.960 <D 30>	06.07-04.09	6	DBB	0 445 115 063	0 986 435 355		1 987 972 076
CDI 4MATIC [204]	3,0	165	OM 642.961 <D 30>	07.07-04.09	6					1 987 972 076
			Mot.-Nr. →..40820980	07.07-11.08	6	DBB	0 445 115 063	0 986 435 355		
			Mot.-Nr. ..40820981→	12.08-04.09	6	DBB	0 445 115 075			
350 CDI [204]	3,0	165	OM 642.960 <D 30>	05.09-09.10	6	DBB	0 445 115 063	0 986 435 355		1 987 972 076
		170	OM 642.830 <D 30>	10.09-01.11	6	DBB	0 445 116 025	0 986 435 404		1 987 972 076
		195	OM 642.834	02.11-12.14	6	DBB	0 445 116 025	0 986 435 404		1 987 972 076
CDI 4MATIC [204]	3,0	165	OM 642.961 <D 30>	05.09-09.09	6	DBB	0 445 115 075			1 987 972 076
		170	OM 642.832 <D 30>	10.09-12.14	6	DBB,SCJ	0 445 116 025	0 986 435 404		1 987 972 076
					6	DBB,SCJ	0 445 115 059	0 986 435 396		1 987 972 076
Serie C (Cabrio)										
220 d, d 4MATIC [205]	2,1	125	OM 651.921 <D 22 LHD>	09.16→	4	DBB,TW	0 445 117 034	0 986 435 428	156	1 987 972 076
250 d [205]	2,1	150	OM 651.921 <D 22 LHD>	09.16→	4	DBB,TW	0 445 117 034	0 986 435 428	156	1 987 972 076





Serie C (Coupé)										
220 CDI [204]	2,1	120-125	OM 651.911 <D 22 LHD>	03.11-12.14	4				156	1987 972 076
d, d 4MATIC [205]	2,1	120-125	OM 651.921 <D 22 LHD>	10.15→	4				156	1987 972 076
			Komp.Nr. A11	10.15→	4	DBB,TW	0 445 117 034	0 986 435 428		
250 CDI [204]	2,1	150	OM 651.911 <D 22 LHD>	03.11-12.14	4				156	1987 972 076
d [205]	2,1	150	OM 651.921 <D 22 LHD>	10.15→	4				156	1987 972 076
			Komp.Nr. A11	10.15→	4	DBB,TW	0 445 117 034	0 986 435 428		
d 4MATIC [205]	2,1	150	OM 651.921 <D 22 LHD>	04.16→	4	DBB,TW	0 445 117 034	0 986 435 428		
Serie C (Sportcoupe)										
30 AMG CDI [203]	3,0	170	OM 612.990 <DE 30 LA AMG>	09.02-08.04	5	DBB	0 445 110 151			1987 972 076
200 CDI [203]	2,2	90	OM64696... <DE 22 LA>	03.03-02.08	4	DBB,MPR	0 445 110 237	0 986 435 139		1987 972 076
					4	DBB,MPR	0 445 110 176	0 986 435 111		1987 972 076
220 CDI [203]	2,2	105	OM 611.962 <DE LA>	01.01-04.04	4					1987 972 076
			Mot.-Nr. →30 314413	01.01-04.04	4	DBB	0 445 110 024	0 986 435 020		
			→40 059864							
			Mot.-Nr. 30 314414→30 445712	01.01-04.04	4	DBB	0 445 110 199	0 986 435 061		
			40 059865→40 068033							
			Mot.-Nr. 30 445713→	01.01-04.04	4	AG,DBB	0 445 110 205	0 986 435 067		
			40 068034→		4	DBB,GS	0 445 110 199	0 986 435 061		
	110		OM 646.963 <DE 22 LA>	05.04-02.08	4	DBB,MPR	0 445 110 237	0 986 435 139		1987 972 076
					4	DBB,MPR	0 445 110 176	0 986 435 111		1987 972 076
Serie C (T-Modell)										
30 AMG CDI [203]	3,0	170	OM 612.990 <DE 30 LA AMG>	01.03-08.04	5	DBB	0 445 110 151			1987 972 076
180 CDI [204]	2,1	88	OM 651.913 <D 22 LHD RED>	01.11-12.14	4	BO,DBB	0 445 117 034	0 986 435 428		1987 972 076
200 CDI [202]	2,2	75	OM 611.960 <DE LA>	03.98-02.01	4	DBB	0 445 110 011	0 986 435 004		1987 972 076
CDI [203]	2,2	75	OM 646.962 <DE 22 LA>	03.03-08.07	4	DBB,MPR	0 445 110 237	0 986 435 139		1987 972 076
					4	DBB,MPR	0 445 110 176	0 986 435 111		1987 972 076
	85		OM 611.962 <DE LA>	10.01-05.03	4					1987 972 076
			Mot.-Nr. →30 314413	10.01-05.03	4	DBB	0 445 110 024	0 986 435 020		
			→40 059864							
			Mot.-Nr. 30 314414→30 445712	10.01-05.03	4	DBB	0 445 110 199	0 986 435 061		
			40 059865→40 068033							
			Mot.-Nr. 30 445713→	10.01-05.03	4	AG,DBB	0 445 110 205	0 986 435 067		
			40 068034→		4	DBB,GS	0 445 110 199	0 986 435 061		
	90		OM64696... <DE 22 LA>	03.03-08.07	4	DBB,MPR	0 445 110 237	0 986 435 139		1987 972 076
					4	DBB,MPR	0 445 110 176	0 986 435 111		1987 972 076
CDI [204]	2,1	100	OM 651.913 <D 22 LHD RED>	01.11-12.14	4	BO,DBB	0 445 117 034	0 986 435 428		1987 972 076
	2,2	100	OM 646.811 <DE 22 LA LL>	09.07-10.09	4					1987 972 076
d [205]	2,1	100	OM 651.921 <D 22 LHD>	10.15→	4				156	1987 972 076
			Komp.Nr. A11	10.15→	4	DBB,TW	0 445 117 034	0 986 435 428		
220 CDI [202]	2,2	92	OM 611.960 <DE LA>	12.97-02.01	4	DBB	0 445 110 011	0 986 435 004		1987 972 076
CDI [203]	2,2	100-110	OM 646.963 <DE 22 LA>	03.03-08.07	4	DBB	0 445 110 176	0 986 435 111		1987 972 076
	105		OM 611.962 <DE LA>	01.01-02.03	4					1987 972 076
			Mot.-Nr. →30 314413	01.01-02.03	4	DBB	0 445 110 024	0 986 435 020		
			→40 059864							
			Mot.-Nr. 30 314414→30 445712	01.01-02.03	4	DBB	0 445 110 199	0 986 435 061		
			40 059865→40 068033							
			Mot.-Nr. 30 445713→	01.01-02.03	4	AG,DBB	0 445 110 205	0 986 435 067		
			40 068034→		4	DBB,GS	0 445 110 199	0 986 435 061		
CDI [204]	2,1	125	OM 651.911 <D 22 G>	04.09-12.14	4				156	1987 972 076
	2,2	125	OM 646.811 <DE 22 LA LL>	09.07-03.09	4					1987 972 076
CDI 4MATIC [204]	2,1	125	OM 651.912 <D 22 LHD>	03.13-12.14	4	BO,DBB	0 445 117 034	0 986 435 428		1987 972 076
d BlueTec, d 4MATIC [205]	2,1	125	OM 651.921 <D 22 LHD>	05.14→	4				156	1987 972 076
			Komp.Nr. A11	05.14→	4	DBB,TW	0 445 117 034	0 986 435 428		
250 BlueTec [205]	2,1	150	OM 651.921 <D 22 LHD>	05.14-11.15	4					1987 972 076
BlueTec, BlueTec 4MATIC, d [205]	2,1	150	OM 651.921 <D 22 LHD>	05.14→	4	DBB,TW	0 445 117 034	0 986 435 428		
			Komp.Nr. A11	05.14→	4	DBB,TW	0 445 117 034	0 986 435 428		
BlueTec 4MATIC, d [205]	2,1	150	OM 651.921 <D 22 LHD>	10.14→	4				156	1987 972 076
CDI [204]	2,1	150	OM 651.911 <D 22 LHD>	04.09-12.14	4				156	1987 972 076
CDI 4MATIC [204]	2,1	150	OM 651.912 <D 22 LHD>	04.10-12.14	4	BO,DBB	0 445 117 034	0 986 435 428		1987 972 076





◀ MERCEDES-BENZ

<b>270 CDI [203]</b>	2,7	125	OM 612.962 <DE LA>	01.01-08.04	5					<b>1 987 972 076</b>
			Mot.-Nr. →..067962	01.01-08.04	5	DBB	<b>0 445 110 024</b>	<b>0 986 435 020</b>		
			Mot.-Nr. ..067963→..133151	01.01-08.04	5	DBB	<b>0 445 110 199</b>	<b>0 986 435 061</b>		
			Mot.-Nr. ...133152→	01.01-08.04	5	AG,DBB	<b>0 445 110 205</b>	<b>0 986 435 067</b>		
					5	DBB,GS	<b>0 445 110 199</b>	<b>0 986 435 061</b>		
<b>300 CDI 4MATIC [204]</b>	3,0	170	OM 642.832 <D 30>	09.11-12.14	6	DBB,SGJ	<b>0 445 116 025</b>	<b>0 986 435 404</b>		<b>1 987 972 076</b>
					6	DBB,SCJ	<b>0 445 115 059</b>	<b>0 986 435 396</b>		<b>1 987 972 076</b>
<b>320 CDI [203]</b>	3,0	165	OM 642.910 <D 30>	09.04-08.07	6	DBB	<b>0 445 115 063</b>	<b>0 986 435 355</b>		<b>1 987 972 076</b>
CDI [204]	3,0	165	OM 642.960 <D 30>	09.07-04.09	6	DBB	<b>0 445 115 063</b>	<b>0 986 435 355</b>		<b>1 987 972 076</b>
CDI 4MATIC [204]	3,0	165	OM 642.961 <D 30>							
			Mot.-Nr. →..40820980	09.07-11.08	6	DBB	<b>0 445 115 063</b>	<b>0 986 435 355</b>		
			Mot.-Nr. ..40820981→	12.08-04.09	6	DBB	<b>0 445 115 075</b>			
<b>350 CDI [204]</b>	3,0	165	OM 642.960 <D 30>	05.09-10.09	6	DBB	<b>0 445 115 063</b>	<b>0 986 435 355</b>		<b>1 987 972 076</b>
		170	OM 642.830 <D 30>	10.09-01.11	6	DBB	<b>0 445 116 025</b>	<b>0 986 435 404</b>		<b>1 987 972 076</b>
		195	OM 642.834	02.11-12.14	6	DBB	<b>0 445 116 025</b>	<b>0 986 435 404</b>		<b>1 987 972 076</b>
CDI 4MATIC [204]	3,0	165	OM 642.961 <D 30>	05.09-10.09	6	DBB	<b>0 445 115 075</b>			
		170	OM 642.832 <D 30>	10.09-08.11	6	DBB,SGJ	<b>0 445 116 025</b>	<b>0 986 435 404</b>		<b>1 987 972 076</b>
					6	DBB,SCJ	<b>0 445 115 059</b>	<b>0 986 435 396</b>		<b>1 987 972 076</b>

**Serie C (T-Serie)**

<b>220 d [205]</b>	2,1	125	OM 651.921 <D 22 LHD>	12.15→	4				156	<b>1 987 972 076</b>
			Komp.Nr. A11	12.15→	4	DBB,TW	<b>0 445 117 034</b>	<b>0 986 435 428</b>		

**Serie CLA**

<b>200 CDI [117]</b>	1,8	100	OM 651.901 <18 LHD>	06.13-06.15	4					<b>1 987 972 076</b>
	2,1	100	OM 651.930 <D 22 LHD>	07.14-06.15	4	DBB,MLU	<b>0 445 117 034</b>	<b>0 986 435 428</b>	TW	<b>1 987 972 076</b>
CDI 4MATIC [117]	2,1	100	OM 651.930 <D 22 LHD>	07.14-06.15	4	DBB,MLU	<b>0 445 117 034</b>	<b>0 986 435 428</b>		
d, d 4MATIC [117]	2,1	100	OM 651.930 <D 22 LHD>	07.15→	4				156	<b>1 987 972 076</b>
<b>220 [117]</b>	2,1	120-130	OM 651.930 <D 22 LHD>	12.12-06.15	4					<b>1 987 972 076</b>
			Komp.Nr. A11	12.12-06.15	4	DBB,TW	<b>0 445 117 034</b>	<b>0 986 435 428</b>		
CDI 4MATIC [117]	2,1	120-125	OM 651.930 <D 22 LHD>	05.14-06.15	4	DBB,MLU	<b>0 445 117 034</b>	<b>0 986 435 428</b>		
d, d 4MATIC [117]	2,1	120-130	OM 651.930 <D 22 LHD>	07.15→	4				156	<b>1 987 972 076</b>

**Serie CLA (Shooting Brake)**

<b>200 d [117]</b>	2,1	100	OM 651.930 <D 22 LHD>	03.15→	4				156	<b>1 987 972 076</b>
<b>220 d, d 4MATIC [117]</b>	2,1	120-130	OM 651.930 <D 22 LHD>	03.15→	4				156	<b>1 987 972 076</b>

**Serie CLC**

<b>200 CDI [203]</b>	2,2	90	OM64696... <DE 22 LA>	03.08-05.10	4	DBB,MPPR	<b>0 445 110 237</b>	<b>0 986 435 139</b>		<b>1 987 972 076</b>
					4	DBB,MPPR	<b>0 445 110 176</b>	<b>0 986 435 111</b>		<b>1 987 972 076</b>
<b>220 CDI [203]</b>	2,2	110	OM 646.963 <DE 22 LA>	03.08-05.10	4	DBB,MPPR	<b>0 445 110 237</b>	<b>0 986 435 139</b>		<b>1 987 972 076</b>
					4	DBB,MPPR	<b>0 445 110 176</b>	<b>0 986 435 111</b>		<b>1 987 972 076</b>

**Serie CLK (Cabrio)**

<b>320 CDI [209]</b>	3,0	165	OM 642.910 <D 30>	04.05-12.09	6					<b>1 987 972 076</b>
			Mot.-Nr. →40820980	04.05-11.08	6	DBB	<b>0 445 115 063</b>	<b>0 986 435 355</b>		
			Mot.-Nr. ...40820981→	12.08-12.09	6	DBB	<b>0 445 115 075</b>			

**Serie CLK (Coupé)**

<b>220 CDI [209]</b>	2,1	100-110	OM 646.966 <DE 22 LA>	04.05-04.09	4	DBB,EU3	<b>0 445 110 176</b>	<b>0 986 435 111</b>		<b>1 987 972 076</b>
					4	DBB,EU4	<b>0 445 110 237</b>	<b>0 986 435 139</b>		<b>1 987 972 076</b>
<b>270 CDI [209]</b>	2,7	125	OM612962... <DE LA>	09.02-03.05	5					<b>1 987 972 076</b>
			Mot.-Nr. →30 067962	09.02-03.05	5	DBB	<b>0 445 110 024</b>	<b>0 986 435 020</b>		
			Mot.-Nr. ..067963→..133151	09.02-03.05	5	DBB	<b>0 445 110 199</b>	<b>0 986 435 061</b>		
			Mot.-Nr. ...133152→	09.02-03.05	5	AG,DBB	<b>0 445 110 205</b>	<b>0 986 435 067</b>		
					5	DBB,GS	<b>0 445 110 199</b>	<b>0 986 435 061</b>		

<b>320 CDI [209]</b>	3,0	165	OM 642.910 <D 30>							
			Mot.-Nr. →40820980	04.05-11.08	6	DBB	<b>0 445 115 063</b>	<b>0 986 435 355</b>		
			Mot.-Nr. ...40820981→	12.08-04.09	6	DBB	<b>0 445 115 075</b>			

**Serie CLS (Coupé)**

<b>220 BlueTec, d [218]</b>	2,1	120-130	OM 651.924 <D 22 LHD>	05.14→	4	BO,DBB, TW	<b>0 445 117 034</b>	<b>0 986 435 428</b>		<b>1 987 972 076</b>
<b>250 BlueTec, BlueTec 4MATIC [218]</b>	2,1	150	OM 651.924 <D 22 LHD>	05.14→	4	BO,DBB, TW	<b>0 445 117 034</b>	<b>0 986 435 428</b>		<b>1 987 972 076</b>
CDI [218]	2,1	150	OM 651.924 <D 22 LHD>	07.10→	4					<b>1 987 972 076</b>
d, d 4MATIC [218]	2,1	150	OM 651.924 <D 22 LHD>	03.16→	4	BO,DBB, TW	<b>0 445 117 034</b>	<b>0 986 435 428</b>		<b>1 987 972 076</b>





<b>320</b> CDI [219]	3,0	155-165	OM 642.920 <D 30> Mot.-Nr. →.40820980 Mot.-Nr. ..40820981→	05.05-11.08 12.08-04.09	6 6	DBB DBJ	<b>0 445 115 063</b> <b>0 445 115 075</b>	<b>0 986 435 355</b>	
<b>350</b> BlueTec, CDI, CDI 4MATIC, d, d 4MATIC [218]	3,0	185-190/ 195	OM 642.85... <D 30>; OM 642.853 <D 30>; OM 642.854 <D 30>	10.10→	6	DBB	<b>0 445 116 025</b>	<b>0 986 435 404</b>	<b>1 987 972 076</b>
CDI [219]	3,0	165	OM 642.920 <D 30>	05.09-12.10	6	DBJ	<b>0 445 115 075</b>		
d 4MATIC [257]	2,9	210	OM 656.929 <DE29 LHD>	12.17→	6	DBJ	<b>0 445 118 008</b>		<b>1 987 972 076</b>
<b>400</b> d 4MATIC [257]	2,9	250	OM 656.929 <DE29 LHD>	12.17→	6	DBJ	<b>0 445 118 008</b>		<b>1 987 972 076</b>
<b>Serie CLS (Shooting Brake)</b>									
<b>220</b> BlueTec, d [218]	2,1	120-130	OM 651.924 <D 22 LHD>	05.14→	4	BO, DBB, TW	<b>0 445 117 034</b>	<b>0 986 435 428</b>	<b>1 987 972 076</b>
<b>250</b> BlueTec, BlueTec 4MATIC [218]	2,1	150	OM 651.924 <D 22 LHD>	05.14→	4	BO, DBB, TW	<b>0 445 117 034</b>	<b>0 986 435 428</b>	<b>1 987 972 076</b>
CDI [218]	2,1	150	OM 651.924 <D 22 LHD>	06.12→	4				<b>1 987 972 076</b>
d, d 4MATIC [218]	2,1	150	OM 651.924 <D 22 LHD>	03.16→	4	BO, DBB, TW	<b>0 445 117 034</b>	<b>0 986 435 428</b>	<b>1 987 972 076</b>
<b>350</b> BlueTec, BlueTec 4MATIC, CDI, CDI 4MATIC, d, d 4MATIC [218]	3,0	185-190/ 195	OM 642.85... <D 30>; OM 642.853 <D 30>; OM 642.854 <D 30>	06.12→	6	DBB	<b>0 445 116 025</b>	<b>0 986 435 404</b>	<b>1 987 972 076</b>
<b>Serie E</b>									
<b>200</b> BlueTec, CDI [212]	2,1	100	OM 651.925 <D 22 LHD RED>	04.09-08.16	4	BO, DBB, TW	<b>0 445 117 034</b>	<b>0 986 435 428</b>	<b>1 987 972 076</b>
CDI [210]	2,1	85	OM 611.961 <DE LA>	08.99-08.99	4	DBB	<b>0 445 110 011</b>	<b>0 986 435 004</b>	<b>1 987 972 076</b>
			Mot.-Nr. →30 314413 →40 059864	08.99-03.02	4	DBB	<b>0 445 110 011</b>	<b>0 986 435 004</b>	<b>1 987 972 076</b>
			Mot.-Nr. 30 314414→30 445712 40 059865→40 068033	09.99-03.02	4	DBB	<b>0 445 110 024</b>	<b>0 986 435 020</b>	
			Mot.-Nr. 30 445713→ 40 068034→	09.99-03.02	4	AG, DBB DBB, GS	<b>0 445 110 199</b> <b>0 445 110 199</b>	<b>0 986 435 067</b> <b>0 986 435 061</b>	
	2,2	75	OM 611.961 <DE LA>	07.98-08.99	4	DBB	<b>0 445 110 011</b>	<b>0 986 435 004</b>	<b>1 987 972 076</b>
				07.98-03.02	4	DBB	<b>0 445 110 011</b>	<b>0 986 435 004</b>	<b>1 987 972 076</b>
				09.99-03.02	4	DBB	<b>0 445 110 024</b>	<b>0 986 435 020</b>	<b>1 987 972 076</b>
CDI [211]	2,1	75/90	OM 646.951 <DE 22 LA>	07.02-12.06	4				<b>1 987 972 076</b>
			Mot.-Nr. →30 045955	07.02-12.06	4	DBB	<b>0 445 110 054</b>	<b>0 986 435 133</b>	
			Mot.-Nr. 30 045956→30 112421	07.02-12.06	4	DBB	<b>0 445 110 155</b>	<b>0 986 435 135</b>	
			Mot.-Nr. 30 112422→	07.02-12.06	4	DBB	<b>0 445 110 176</b>	<b>0 986 435 111</b>	
		100	OM 646.82... <DE 22 LA LL>	04.06-03.09	4				<b>1 987 972 076</b>
d [213]	2,0	110	OM 654.920 <DE 20>	06.16→	4	DBJ	<b>0 445 117 047</b>		<b>1 987 972 076</b>
<b>220</b> BlueTec, BlueTec 4MATIC [212]	2,1	125-130	OM 651.924 <D 22 LL>	06.13-08.16	4	BO, DBB, TW	<b>0 445 117 034</b>	<b>0 986 435 428</b>	<b>1 987 972 076</b>
CDI [210]	2,1	100-105	OM 611.961 <DE LA>	08.99-08.99	4	DBB	<b>0 445 110 011</b>	<b>0 986 435 004</b>	<b>1 987 972 076</b>
			Mot.-Nr. →30 314413 →40 059864	08.99-03.02	4	DBB	<b>0 445 110 011</b>	<b>0 986 435 004</b>	<b>1 987 972 076</b>
			Mot.-Nr. 30 314414→30 445712 40 059865→40 068033	09.99-03.02	4	DBB	<b>0 445 110 024</b>	<b>0 986 435 020</b>	
			Mot.-Nr. 30 445713→ 40 068034→	09.99-03.02	4	AG, DBB DBB, GS	<b>0 445 110 199</b> <b>0 445 110 199</b>	<b>0 986 435 067</b> <b>0 986 435 061</b>	
	2,2	92	OM 611.961 <DE LA>	07.98-07.99	4	DBB	<b>0 445 110 011</b>	<b>0 986 435 004</b>	<b>1 987 972 076</b>
CDI [211]	2,1	100/110	OM 646.961 <DE 22 LA>	03.02-01.09	4				<b>1 987 972 076</b>
			Mot.-Nr. →30 045955	03.02-01.09	4	DBB	<b>0 445 110 054</b>	<b>0 986 435 133</b>	
			Mot.-Nr. 30 045956→30 112421	03.02-01.09	4	DBB	<b>0 445 110 155</b>	<b>0 986 435 135</b>	
			Mot.-Nr. 30 112422→	03.02-01.09	4	DBB	<b>0 445 110 176</b>	<b>0 986 435 111</b>	
		120-125	OM 646.821 <DE 22 LA LL>	04.06-03.09	4				<b>1 987 972 076</b>
CDI [212]	2,1	120-125	OM 651.924 <D 22 LL>	12.08-08.16	4				<b>1 987 972 076</b>
d, d 4MATIC [213]	2,0	143	OM 654.920 <DE 20>	01.16→	4	DBJ	<b>0 445 117 047</b>		<b>1 987 972 076</b>
<b>250</b> BlueTec, CDI [212]	2,1	150	OM 651.924 <D 22 LL>	12.08-08.16	4	BO, DBB, TW	<b>0 445 117 034</b>	<b>0 986 435 428</b>	<b>1 987 972 076</b>
BlueTec 4MATIC, CDI 4MATIC [212]	2,1	150	OM 651.924 <D 22 LHD>	01.11-08.16	4	BO, DBB, TW	<b>0 445 117 034</b>	<b>0 986 435 428</b>	<b>1 987 972 076</b>









<b>250</b> BlueTec [207]	2,1	150	OM 651.911 <D 22 G>	07.14-11.16	4				156	<b>1987 972 076</b>
CDI [207]	2,1	150	OM 651.911 <D 22 G>	02.09-08.15	4	BO,DBB	<b>0 445 117 034</b>	<b>0 986 435 428</b>		<b>1987 972 076</b>
d [207]	2,1	150	OM 651.911 <D 22 G>	08.15-11.16	4				156	<b>1987 972 076</b>
<b>350</b> BlueTec, CDI [207]	3,0	170/185-190/195	OM 642.836 <D 30>; OM 642.838 <D 30>	02.09-08.15	6	DBB	<b>0 445 116 025</b>	<b>0 986 435 404</b>		<b>1987 972 076</b>
d 4MATIC [238]	3,0	190	OM 642.873 <D30 LHD>	06.17→	6	DBB	<b>0 445 116 025</b>	<b>0 986 435 404</b>		<b>1987 972 076</b>
<b>Serie E (T-Modell)</b>										
<b>200</b> BlueTec, CDI [212]	2,1	100	OM 651.925 <D 22 LHD RED>	08.09-08.16	4	BO,DBB, TW	<b>0 445 117 034</b>	<b>0 986 435 428</b>		<b>1987 972 076</b>
CDI [211]	2,1	100	OM 646.821 <DE 22 LA LL>	04.07-08.09	4					<b>1987 972 076</b>
d [213]	2,0	110	OM 654.920 <DE 20>	06.16→	4	DBJ	<b>0 445 117 047</b>			<b>1987 972 076</b>
<b>220</b> BlueTec, BlueTec 4MATIC [212]	2,1	125	OM 651.924 <D 22 LHD>	07.14-08.16	4	BO,DBB, TW	<b>0 445 117 034</b>	<b>0 986 435 428</b>		<b>1987 972 076</b>
CDI [210]	2,1	100-105	OM 611.961 <DE LA>	08.99-08.99	4	DBB	<b>0 445 110 011</b>	<b>0 986 435 004</b>		<b>1987 972 076</b>
			Mot.-Nr. →30 314413	08.99-01.03	4	DBB	<b>0 445 110 011</b>	<b>0 986 435 004</b>		<b>1987 972 076</b>
			→40 059864	09.99-01.03	4	DBB	<b>0 445 110 024</b>	<b>0 986 435 020</b>		
			Mot.-Nr. 30 314414→30 445712	09.99-01.03	4	DBB	<b>0 445 110 199</b>	<b>0 986 435 061</b>		
			40 059865→40 068033							
			Mot.-Nr. 30 445713→	09.99-01.03	4	AG,DBB	<b>0 445 110 205</b>	<b>0 986 435 067</b>		
			40 068034→		4	DBB,GS	<b>0 445 110 199</b>	<b>0 986 435 061</b>		
	2,2	92	OM 611.961 <DE LA>	07.98-07.99	4	DBB	<b>0 445 110 011</b>	<b>0 986 435 004</b>		<b>1987 972 076</b>
CDI [211]	2,1	100/110	OM 646.961 <DE 22 LA>	02.03-08.09	4					<b>1987 972 076</b>
			Mot.-Nr. →30 045955	02.03-08.09	4	DBB	<b>0 445 110 054</b>	<b>0 986 435 133</b>		
			Mot.-Nr. 30 045956→30 112421	02.03-08.09	4	DBB	<b>0 445 110 155</b>	<b>0 986 435 135</b>		
			Mot.-Nr. 30 112422→	02.03-08.09	4	DBB	<b>0 445 110 176</b>	<b>0 986 435 111</b>		
		125	OM 646.821 <DE 22 LA LL>	04.06-08.09	4					<b>1987 972 076</b>
CDI [212]	2,1	125	OM 651.924 <D 22 LHD>	08.09-08.16	4					<b>1987 972 076</b>
d, d 4MATIC [213]	2,0	120-143	OM 654.920 <DE 20>	06.16→	4	DBJ	<b>0 445 117 047</b>			<b>1987 972 076</b>
<b>250</b> BlueTec, BlueTec 4MATIC [212]	2,1	150	OM 651.924 <D 22 LHD>	07.14-08.16	4	BO,DBB, TW	<b>0 445 117 034</b>	<b>0 986 435 428</b>		<b>1987 972 076</b>
CDI, CDI 4MATIC [212]	2,1	150	OM 651.924 <D 22 LHD>	08.09-08.16	4					<b>1987 972 076</b>
<b>270</b> CDI [210]	2,7	125	OM 612.961 <DE LA>	08.99-01.03	5					<b>1987 972 076</b>
			Mot.-Nr. →.067962	08.99-01.03	5	DBB	<b>0 445 110 024</b>	<b>0 986 435 020</b>		
			Mot.-Nr. ...067963→.133151	08.99-01.03	5	DBB	<b>0 445 110 199</b>	<b>0 986 435 061</b>		
			Mot.-Nr. ...133152→	08.99-01.03	5	AG,DBB	<b>0 445 110 205</b>	<b>0 986 435 067</b>		
					5	DBB,GS	<b>0 445 110 199</b>	<b>0 986 435 061</b>		
CDI [211]	2,7	120-130	OM 647.961 <DE 27 LA>	02.03-03.05	5					<b>1987 972 076</b>
			Mot.-Nr. →30041540	02.03-03.05	5	DBB	<b>0 445 110 054</b>	<b>0 986 435 133</b>		
			Mot.-Nr. 30041541→30107211	02.03-03.05	5	DBB	<b>0 445 110 155</b>	<b>0 986 435 135</b>		
			Mot.-Nr. 30107212→	02.03-03.05	5	DBB	<b>0 445 110 176</b>	<b>0 986 435 111</b>		
<b>280</b> CDI [211]	3,0	140	OM 642.920 <D 30>	04.05-08.09	6	DBB	<b>0 445 115 063</b>	<b>0 986 435 355</b>		<b>1987 972 076</b>
	3,2	130	OM 648.961 <DE 32 LA>	04.04-03.05	6	DBB	<b>0 445 110 176</b>	<b>0 986 435 111</b>		<b>1987 972 076</b>
CDI 4MATIC [211]	3,0	140	OM 642.921 <D 30>	04.05-08.09	6	DBB	<b>0 445 115 063</b>	<b>0 986 435 355</b>		<b>1987 972 076</b>
<b>300</b> BlueTec, CDI [212]	3,0	170	OM 642.852 <D 30>	08.11-08.16	6	DBB	<b>0 445 116 025</b>	<b>0 986 435 404</b>		<b>1987 972 076</b>
CDI [212]	3,0	150/170	OM 642.850 <D 30>	12.09-12.13	6	DBB,SCJ	<b>0 445 116 025</b>	<b>0 986 435 404</b>		<b>1987 972 076</b>
					6	DBB,SCJ	<b>0 445 115 059</b>	<b>0 986 435 396</b>		<b>1987 972 076</b>
d [213]	2,0	180	OM 654.920 <DE 20>	02.18→	4	DBJ,ERL	<b>0 445 118 008</b>			<b>1987 972 076</b>
					4	DBJ,LEN	<b>0 445 117 047</b>			<b>1987 972 076</b>
<b>320</b> CDI [210]	3,2	145	OM 613.961 <DE LA>	08.99-01.03	6	DBB	<b>0 445 110 095</b>	<b>0 986 435 037</b>		<b>1987 972 076</b>
								<b>0 986 435 063</b>		
CDI [211]	3,0	155-165	OM 642.920 <D 30>	04.05-08.09	6	DBB	<b>0 445 115 063</b>	<b>0 986 435 355</b>		<b>1987 972 076</b>
	3,2	150	OM 648.961 <DE 32 LA>	02.03-03.05	6					<b>1987 972 076</b>
			Mot.-Nr. →30042543	02.03-08.03	6	DBB	<b>0 445 110 155</b>	<b>0 986 435 135</b>		
			Mot.-Nr. 30042544→	09.03-03.05	6	DBB	<b>0 445 110 176</b>	<b>0 986 435 111</b>		
CDI 4MATIC [211]	3,0	165	OM 642.921 <D 30>	04.05-08.09	6	DBB	<b>0 445 115 063</b>	<b>0 986 435 355</b>		<b>1987 972 076</b>
<b>350</b> BlueTec [212]	3,0	155	OM 642.850 <D 30>	08.09-12.13	6	DBB,SCJ	<b>0 445 116 025</b>	<b>0 986 435 404</b>		<b>1987 972 076</b>
					6	DBB,SCJ	<b>0 445 115 059</b>	<b>0 986 435 396</b>		<b>1987 972 076</b>
BlueTec, CDI [212]	3,0	185/195	OM 642.852 <D 30>	12.10-12.13	6	DBB	<b>0 445 116 025</b>	<b>0 986 435 404</b>		<b>1987 972 076</b>
				12.10-08.16	6	DBB	<b>0 445 116 025</b>	<b>0 986 435 404</b>		<b>1987 972 076</b>
BlueTec 4MATIC [212]	3,0	185-190	OM 642.85... <D 30>	08.12-08.16	6	DBB	<b>0 445 116 025</b>	<b>0 986 435 404</b>		<b>1987 972 076</b>





◀ MERCEDES-BENZ

<b>350 CDI</b> [212]	3,0	170	OM 642.850 <D 30>	08.09-11.10	6	DBB	<b>0 445 116 025</b>	<b>0 986 435 404</b>	<b>1 987 972 076</b>	
CDI 4MATIC [212]	3,0	170	OM 642.856 <D 30>	08.09-11.10	6	DBB	<b>0 445 116 025</b>	<b>0 986 435 404</b>	<b>1 987 972 076</b>	
		195	OM 642.858 <D 30>	12.10-12.13	6	DBB	<b>0 445 116 025</b>	<b>0 986 435 404</b>	<b>1 987 972 076</b>	
d, d All-Terrain 4Matic [213]	3,0	190	OM 642.855 <D 30>; OM 642.873 <D30 LHD>	06.16→	6	DBB	<b>0 445 116 025</b>	<b>0 986 435 404</b>	<b>1 987 972 076</b>	
<b>Serie G</b>										
<b>270 CDI</b> [463]	2,7	115	OM 612.965 <DE LA>	10.01-08.06	5				<b>1 987 972 076</b>	
			Mot.-Nr. →30 278709	10.01-08.06	5	DBB	<b>0 445 110 097</b>	<b>0 986 435 037</b>		
			→60 002079					<b>0 986 435 039</b>		
								<b>0 986 435 063</b>		
			Mot.-Nr. 30 278710→	10.01-08.06	5	DBB	<b>0 445 110 203</b>	<b>0 986 435 065</b>		
			60 002080→							
CDI 4MATIC [461]	2,7	115	OM 612.966 <612 DE>	01.03-12.07	5	DBB	<b>0 445 110 181</b>	<b>0 986 435 053</b>	<b>1 987 972 076</b>	
<b>280 CDI</b> [461]	3,0	135	OM 642.884 <OM642>	04.09→	6	DBB	<b>0 445 115 063</b>	<b>0 986 435 355</b>		
<b>300 CDI</b> [461]	3,0	135	OM 642.884 <OM642>	09.09→	6	DBB	<b>0 445 116 027</b>	<b>0 986 435 406</b>	<b>1 987 972 076</b>	
<b>320 CDI</b> [463]	3,0	165	OM 642.970	09.06-12.09	6				<b>1 987 972 076</b>	
			Mot.-Nr. →..40820980	09.06-11.08	6	DBB	<b>0 445 115 063</b>	<b>0 986 435 355</b>		
			Mot.-Nr. ..40820981→	12.08-12.09	6	DBB	<b>0 445 115 075</b>			
<b>350 BlueTec</b> [463]	3,0	155-165	OM 642...	07.10-12.15	6				<b>1 987 972 076</b>	
			Mot.-Typ 642.886	07.10-12.15	6	DBB	<b>0 445 115 059</b>	<b>0 986 435 396</b>		
			Mot.-Typ 642.970	07.10-12.15	6	DBB	<b>0 445 115 063</b>	<b>0 986 435 355</b>		
BlueTec, d [463]	3,0	155/180	OM 642.886; OM 642.887	07.10→	6	DBB	<b>0 445 115 059</b>	<b>0 986 435 396</b>	<b>1 987 972 076</b>	
<b>400 CDI</b> [463]	4,0	184	OM 628.962 <DE40LARL>	12.00-08.06	8				<b>1 987 972 076</b>	
			Mot.-Nr. →40002970	12.00-08.06	8	DBB	<b>0 445 110 073</b>	<b>0 986 435 031</b>		
			Mot.-Nr. 40002971→40016047	12.00-08.06	8	DBB	<b>0 445 110 093</b>	<b>0 986 435 035</b>		
			Mot.-Nr. 40016048→40033944	12.00-08.06	8	DBB	<b>0 445 110 103</b>	<b>0 986 435 043</b>		
			Mot.-Nr. 40033945→	12.00-08.06	8	DBB	<b>0 445 110 207</b>	<b>0 986 435 069</b>		
<b>Serie GL</b>										
<b>320 CDI BlueTec 4MATIC</b> [164]	3,0	155	OM 642.820 <D 30>	09.08-08.09	6	DBB,SCJ	<b>0 445 116 025</b>	<b>0 986 435 404</b>	<b>1 987 972 076</b>	
					6	DBB,SCJ	<b>0 445 115 059</b>	<b>0 986 435 396</b>	<b>1 987 972 076</b>	
CDI 4MATIC [164]	3,0	165	OM 642.940 <D 30>	02.06-04.09	6				<b>1 987 972 076</b>	
			Mot.-Nr. →..40820980	02.06-11.08	6	DBB	<b>0 445 115 063</b>	<b>0 986 435 355</b>		
			Mot.-Nr. ..40820981→	12.08-04.09	6	DBB	<b>0 445 115 075</b>			
<b>350 CDI BlueTec 4MATIC</b> [164]	3,0	155	OM 642.820 <D 30>	04.09-12.12	6	DBB	<b>0 445 115 059</b>	<b>0 986 435 396</b>	<b>1 987 972 076</b>	
CDI BlueTec 4MATIC [166]	3,0	190	OM 642.826 <D 30>	08.12-12.15	6	DBB	<b>0 445 116 025</b>	<b>0 986 435 404</b>	<b>1 987 972 076</b>	
CDI 4MATIC [164]	3,0	165	OM 642.940 <D 30>	05.09-08.10	6	DBB	<b>0 445 115 075</b>		<b>1 987 972 076</b>	
		195	OM 642.822 <D 30>	09.10-12.12	6	DBB	<b>0 445 116 025</b>	<b>0 986 435 404</b>	<b>1 987 972 076</b>	
<b>420 CDI 4MATIC</b> [164]	4,0	225	OM 629.912 <DE 40 LA>	02.06-04.09	8	DBB	<b>0 445 115 065</b>	<b>0 986 435 400</b>	<b>1 987 972 076</b>	
<b>450 CDI 4MATIC</b> [164]	4,0	225	OM 629.912 <DE 40 LA>	05.09-12.12	8	DBB	<b>0 445 115 065</b>	<b>0 986 435 400</b>	<b>1 987 972 076</b>	
<b>Serie GLA</b>										
<b>200 CDI, CDI 4MATIC</b> [156]	2,1	100	OM 651.930 <D 22 LHD>	10.13-06.15	4				<b>1 987 972 076</b>	
			Komp.Nr. A11	10.13-06.15	4	DBB,TW	<b>0 445 117 034</b>	<b>0 986 435 428</b>		
d, d 4MATIC [156]	2,1	100	OM 651.930 <D 22 LHD>	07.15→	4			156	<b>1 987 972 076</b>	
<b>220 CDI, CDI 4MATIC</b> [156]	2,1	120-125	OM 651.930 <D 22 LHD>	10.13-06.15	4				<b>1 987 972 076</b>	
			Komp.Nr. A11	10.13-06.15	4	DBB	<b>0 445 117 034</b>	<b>0 986 435 428</b>		
d, d 4MATIC [156]	2,1	125	OM 651.930 <D 22 LHD>	07.15→	4			156	<b>1 987 972 076</b>	
<b>Serie GLC</b>										
<b>200 d</b> [253]	2,1	100	OM 651.921 <D 22 LHD>	05.16→	4	DBB,TW	<b>0 445 117 034</b>	<b>0 986 435 428</b>	156 <b>1 987 972 076</b>	
<b>220 d 4MATIC</b> [253]	2,1	120-125	OM 651.921 <D 22 LHD>	07.15→	4	DBB	<b>0 445 117 034</b>	<b>0 986 435 428</b>	156 <b>1 987 972 076</b>	
<b>250 d 4MATIC</b> [253]	2,1	150	OM 651.921 <D 22 LHD>	07.15→	4	DBB	<b>0 445 117 034</b>	<b>0 986 435 428</b>	156 <b>1 987 972 076</b>	
<b>350 d 4MATIC</b> [253]	3,0	190	OM 642.873 <D30 LHD>	09.16→	6	DBB	<b>0 445 116 025</b>	<b>0 986 435 404</b>	<b>1 987 972 076</b>	
<b>Serie GLC (Coupé)</b>										
<b>220 d 4MATIC</b> [253]	2,1	120-125	OM 651.921 <D 22 LHD>	10.16→	4	DBB,TW	<b>0 445 117 034</b>	<b>0 986 435 428</b>	156 <b>1 987 972 076</b>	
<b>250 d 4MATIC</b> [253]	2,1	150	OM 651.921 <D 22 LHD>	10.16→	4	DBB,TW	<b>0 445 117 034</b>	<b>0 986 435 428</b>	156 <b>1 987 972 076</b>	
<b>350 d 4MATIC</b> [253]	3,0	190	OM 642.873 <D30 LHD>	10.16→	6	DBB	<b>0 445 116 025</b>	<b>0 986 435 404</b>	<b>1 987 972 076</b>	
<b>Serie GLE</b>										
<b>250 d, d 4MATIC</b> [166]	2,1	150	OM 651.960 <D 22 LHD>	04.15→	4	BO,DBB, TW	<b>0 445 117 034</b>	<b>0 986 435 428</b>	156 <b>1 987 972 076</b>	
<b>350 d 4MATIC</b> [166]	3,0	190	OM 642.826 <D 30>	04.15→	6	DBB	<b>0 445 116 025</b>	<b>0 986 435 404</b>	<b>1 987 972 076</b>	
<b>Serie GLE (Coupé)</b>										
<b>350 d 4MATIC</b> [292]	3,0	190	OM 642.826 <D 30>	04.15→	6	DBB	<b>0 445 116 025</b>	<b>0 986 435 404</b>	<b>1 987 972 076</b>	



Serie GLK										
200 CDI [204]	2,1	100-105	OM 651.91... <D 22 LHD RED> Komp.Nr. A11	07.10-08.15	4					1987 972 076
220 BlueTec 4MATIC [204]	2,1	125	OM 651.912 <D 22 LHD>	03.12-08.16	4	DBB, TW	0 445 117 034	0 986 435 428		1987 972 076
CDI [204]	2,1	120-125	OM 651.916 <D 22 LHD> Komp.Nr. A11	04.09-08.15	4					1987 972 076
CDI 4MATIC [204]	2,1	120-125	OM 651.912 <D 22 LHD> Komp.Nr. A11	06.08-08.15	4	DBB, TW	0 445 117 034	0 986 435 428		1987 972 076
250 BlueTec 4MATIC [204]	2,1	150	OM 651.912 <D 22 LHD>	03.12-08.16	4	DBB, TW	0 445 117 034	0 986 435 428		1987 972 076
CDI 4MATIC [204]	2,1	150	OM 651.912 <D 22 LHD> Komp.Nr. A11	04.09-08.16	4					1987 972 076
				04.09-12.13	4	DBB, TW	0 445 117 034	0 986 435 428		
320 CDI 4MATIC [204]	3,0	165	OM 642.961 <D 30>	09.08-04.09	6	DBB	0 445 115 063	0 986 435 355		1987 972 076
350 CDI 4MATIC [204]	3,0	165	OM 642.961 <D 30>	05.09-02.10	6	DBB	0 445 115 063	0 986 435 355		1987 972 076
		170	OM 642.832 <D 30>	04.09-03.12	6	DBB	0 445 116 025	0 986 435 404		1987 972 076
		195	OM 642.835 <D 30>	03.12-08.15	6	DBB	0 445 116 025	0 986 435 404		1987 972 076
Serie GLS										
350 d [166]	3,0	190	OM 642.826 <D 30>	09.15→	6	DBB	0 445 116 025	0 986 435 404		1987 972 076
Serie ML										
250 CDI BlueTec 4MATIC [166]	2,1	150	OM 651.960 <D 22 LHD>	06.11-08.15	4	BO, DBB, TW	0 445 117 034	0 986 435 428		1987 972 076
270 CDI [163]	2,7	120	OM 612.963 <DE LA>	11.99-06.05	5	DBB	0 445 110 201	0 986 435 063		1987 972 076
280 CDI 4MATIC [164]	3,0	140	OM 642.940 <D 30>	07.05-04.09	6					1987 972 076
			Mot.-Nr. →..40820980	07.05-11.08	6	DBB	0 445 115 063	0 986 435 355		
			Mot.-Nr. ...40820981→	12.08-04.09	6	DBB	0 445 115 075			
300 CDI 4MATIC [164]	3,0	140	OM 642.940 <D 30>	05.09-12.10	6	DBB	0 445 115 075			1987 972 076
		150	OM 642.820 <D 30>	05.09-07.11	6	DBB, SCJ	0 445 116 025	0 986 435 404		1987 972 076
					6	DBB, SCJ	0 445 115 059	0 986 435 396		1987 972 076
320 CDI 4MATIC [164]	3,0	165	OM 642.940 <D 30>	03.05-04.09	6	DBB	0 445 115 063	0 986 435 355		1987 972 076
350 BlueTec 4MATIC [164]	3,0	155	OM 642.820 <D 30>	05.09-07.11	6	DBB	0 445 115 059	0 986 435 396		1987 972 076
BlueTec 4MATIC [166]	3,0	190	OM 642.826 <D 30>	06.11-08.15	6	DBB	0 445 116 025	0 986 435 404		1987 972 076
CDI 4MATIC [164]	3,0	165	OM 642.940 <D 30>	05.09-01.10	6	DBB	0 445 115 063	0 986 435 355		1987 972 076
		170	OM 642.820 <D 30>	02.10-08.11	6	DBB, SCJ	0 445 116 025	0 986 435 404		1987 972 076
					6	DBB, SCJ	0 445 115 059	0 986 435 396		1987 972 076
400 CDI [163]	4,0	184	OM 628.963 <DE 40 LA LL>	09.01-06.05	8					1987 972 076
			Mot.-Nr. →40016047	09.01-06.05	8	DBB	0 445 110 093	0 986 435 035		
			Mot.-Nr. 40016048→40033944	09.01-06.05	8	DBB	0 445 110 103	0 986 435 043		
			Mot.-Nr. 40033945→	09.01-06.05	8	DBB	0 445 110 207	0 986 435 069		
420 CDI 4MATIC [164]	4,0	225	OM 629.912 <DE 40 LA>	02.06-04.09	8	DBB	0 445 115 065	0 986 435 400		1987 972 076
450 CDI 4MATIC [164]	4,0	225	OM 629.912 <DE 40 LA>	05.09-01.11	8	DBB	0 445 115 065	0 986 435 400		1987 972 076
Serie R										
280 CDI, CDI 4MATIC [251]	3,0	140	OM 642.950 <D 30>	04.06-04.09	6					1987 972 076
			Mot.-Nr. →..40820980	04.06-11.08	6	DBB	0 445 115 063	0 986 435 355		
			Mot.-Nr. ...40820981→	12.08-04.09	6	DBB	0 445 115 075			
300 CDI [251]	3,0	140	OM 642... <D 30>	05.10-10.12	6	DBB	0 445 116 025	0 986 435 404		1987 972 076
CDI, CDI 4MATIC [251]	3,0	140	OM 642.950 <D 30>	05.09-05.10	6	DBB	0 445 115 075			1987 972 076
320 CDI 4MATIC [251]	3,0	165	OM 642... <D 30>	06.07-05.09	6					1987 972 076
			Mot.-Nr. →..40820980	06.07-11.08	6	DBB	0 445 115 063	0 986 435 355		
			Mot.-Nr. ...40820981→	12.08-05.09	6	DBB	0 445 115 075			
			OM 642.950 <D 30>	09.05-04.09	6	DBB	0 445 115 063	0 986 435 355		1987 972 076
350 BlueTec 4MATIC [251]	3,0	155	OM 642.870 <D 30>	05.09-10.12	6	DBB	0 445 115 059	0 986 435 396		1987 972 076
CDI 4MATIC [251]	3,0	165	OM 642.950 <D 30>	05.09-05.10	6	DBB	0 445 115 063	0 986 435 355		1987 972 076
		195	OM 642.872 <D 30>	05.10-10.12	6	DBB	0 445 116 025	0 986 435 404		1987 972 076
Serie S										
250 CDI [221]	2,1	150	OM 651.961 <D 22 LHD GST> Komp.Nr. A11	09.10-12.13	4					1987 972 076
				09.10-12.13	4	DBB, TW	0 445 117 034	0 986 435 428		
320 CDI [220]	3,2	145	OM 613.960 <DE 32 LA>	06.99-08.02	6	DBB	0 445 110 095	0 986 435 037		1987 972 076
								0 986 435 063		





◀ MERCEDES-BENZ

320 CDI [220]	3,2	150	OM 648.960 <DE 32 LA>	09.02-02.04	6	DBB	0 445 110 155	0 986 435 135	1 987 972 076		
				09.02-08.05	6	DBB	0 445 110 155	0 986 435 135	1 987 972 076		
				03.04-08.05	6	DBB	0 445 110 176	0 986 435 111	1 987 972 076		
CDI [221]	3,0	155/173	OM 642.930 <D 30>	Mot.-Nr. →40820980	12.05-11.08	6	DBB	0 445 115 063	0 986 435 355		
				Mot.-Nr. ...40820981→	12.08-04.09	6	DBJ	0 445 115 075			
CDI 4MATIC [221]	3,0	155/173	OM 642.932 <D 30>	Mot.-Nr. →40820980	12.06-11.08	6	DBB	0 445 115 063	0 986 435 355		
				Mot.-Nr. ...40820981→	12.08-04.09	6	DBJ	0 445 115 075			
350 BlueTec [221]	3,0	190	OM 642.862 <D 30>	07.10-12.13	6	DBB	0 445 116 025	0 986 435 404	1 987 972 076		
BlueTec, d [222]	3,0	190	OM 642.861 <D 30>	05.13-08.15	6	DBB	0 445 116 025	0 986 435 404	1 987 972 076		
				05.13→	6	DBB	0 445 116 025	0 986 435 404	1 987 972 076		
BlueTec 4MATIC [221]	3,0	190	OM 642.868 <D 30>	07.10-12.13	6	DBB	0 445 116 025	0 986 435 404	1 987 972 076		
BlueTec 4MATIC, d 4MATIC [222]	3,0	185-190	OM 642.867 <D 30>	02.14-08.15	6	DBB	0 445 116 025	0 986 435 404	1 987 972 076		
				02.14→	6	DBB	0 445 116 025	0 986 435 404	1 987 972 076		
CDI [221]	3,0	173	OM 642.930 <D 30>	05.09-06.10	6	DBJ	0 445 115 075		1 987 972 076		
CDI 4MATIC [221]	3,0	155/173	OM 642.932 <D 30>	05.09-06.10	6	DBJ	0 445 115 075		1 987 972 076		
d, d 4MATIC [222]	2,9	210	OM 656.929 <DE29 LHD>	05.17→	6	DBJ	0 445 118 008		1 987 972 076		
400 CDI [220]	4,0	184/191	OM 628.960 <DE 40 LA>	06.99-08.05	8				1 987 972 076		
				Mot.-Nr. →40002970	06.99-08.05	8	DBB	0 445 110 073	0 986 435 031		
				Mot.-Nr. 40002971→40019316	06.99-08.05	8	DBB	0 445 110 093	0 986 435 035		
				Mot.-Nr. 40019317→40033944	06.99-08.05	8	DBB	0 445 110 103	0 986 435 043		
				Mot.-Nr. 40033945→	06.99-08.05	8	DBB	0 445 110 207	0 986 435 069		
d, d 4MATIC [222]	2,9	250	OM 656.929 <DE29 LHD>	05.17→	6	DBJ	0 445 118 008		1 987 972 076		
420 CDI [221]	4,0	235	OM 629.911 <DE 40 LA>	12.06-04.09	8	DBB	0 445 115 065	0 986 435 400	1 987 972 076		
450 CDI [221]	4,0	235	OM 629.911 <DE 40 LA>	05.09-06.10	8	DBB	0 445 115 065	0 986 435 400	1 987 972 076		
<b>Serie SLC</b>											
250 d [172]	2,1	150	OM 651.980 <D 22 LHD GST>	01.16→	4	BO, DBB, TW	0 445 117 034	0 986 435 428	156	1 987 972 076	
<b>Serie SLK</b>											
250 CDI [172]	2,1	150	OM 651.980 <D 22 LHD GST>	09.11-08.16	4	BO, DBB, TW	0 445 117 034	0 986 435 428	156	1 987 972 076	
<b>Vaneo</b>											
1.7 CDI [414]	1,7	55	OM 668.914 <DE 17 LA>	02.02-08.05	4					1 987 972 076	
				Mot.-Nr. →30368491	02.02-08.05	4	DBB	0 445 110 089	0 986 435 033	0 986 435 059	
				55/67	OM 668.914 <DE 17 LA>						
					Mot.-Nr. 30368942→	02.02-08.05	4	DBB	0 445 110 197	0 986 435 059	
				67	OM 668.914 <DE 17 LA>						
		Mot.-Nr. →30368491	02.02-08.05	4	DBB	0 445 110 089	0 986 435 033	0 986 435 059			



**MG**

<b>MG 6</b>										
1.9 DTi	1,8	110		09.12→	4	DBJ	0 445 110 510			
<b>ZT 135</b>										
2.0 CDTi	2,0	96	20 4D 2 <M47R>	10.02-05.05	4	DBJ	0 445 110 030	0 986 435 011		
<b>ZT 190</b>										
2.0 CDT	2,0	85	20 4D 2 <M47R>	10.01-05.05	4	DBJ	0 445 110 030	0 986 435 011		
<b>ZT-Tourer 135</b>										
2.0 CDTi	2,0	96	20 4D 2 <M47R>	10.02-05.05	4	DBJ	0 445 110 030	0 986 435 011		
<b>ZT-Tourer 190</b>										
2.0 CDT	2,0	85	20 4D 2 <M47R>	10.01-05.05	4	DBJ	0 445 110 030	0 986 435 011		

**MINI (BMW)**

<b>Cooper</b>										
1.5 D [F 55]	1,5	85	B37 C15A	10.14→	3	DBJ	0 445 110 598			
D [F 56]	1,5	85	B37 C15A	03.14→	3	DBJ	0 445 110 598			





1.6 D [R 56]	1,6	80	9HZ	03.07-07.10	4	DBJ	0 445 110 259	0 986 435 126
		82	N47 C16A	08.10-11.13	4	DBJ	0 445 110 600	0 986 435 210
								0 986 435 245
2.0 D, SD [R 56]	2,0	82/100-105	N47 C20A	03.11-11.13	4	DBJ	0 445 110 601	0 986 435 179
SD [F 55]	2,0	120-125	B47 C20A	10.14→	4	DBJ	0 445 110 743	0 986 435 269
SD [F 56]	2,0	120-125	B47 C20A	07.14→	4	DBJ	0 445 110 743	0 986 435 269
<b>Cooper Cabrio</b>								
1.5 D [F 57]	1,5	85	B37 C15A	03.16→	3	DBJ	0 445 110 598	
1.6 D [R 57]	1,6	82	N47 C16A	09.10-05.15	4	DBJ	0 445 110 600	0 986 435 210
								0 986 435 245
2.0 D, SD [R 57]	2,0	82/100-105	N47 C20A	03.11-06.14	4	DBJ	0 445 110 601	0 986 435 179
								0 445 110 613
SD [F 57]	2,0	120-125	B47 C20A	03.16→	4	DBJ	0 445 110 743	0 986 435 269
<b>Cooper Clubman</b>								
1.6 D [R 55]	1,6	80	9HZ	11.07-07.10	4	DBJ	0 445 110 259	0 986 435 126
		82	N47 C16A	09.10-06.14	4	DBJ	0 445 110 600	0 986 435 210
								0 986 435 245
2.0 D [F 54]	2,0	100-110	B47 C20A	10.15→	4	DBJ	0 445 110 613	0 986 435 268
D, SD [R 55]	2,0	82/100-105	N47 C20A	03.11-06.14	4	DBJ	0 445 110 601	0 986 435 179
SD, SD ALL4 [F 54]	2,0	120-140	B47 C20A	11.15→	4	DBJ	0 445 110 743	0 986 435 269
<b>Cooper Clubvan</b>								
1.6 D [R 55]	1,6	82	N47 C16A	02.13-06.14	4	DBJ	0 445 110 600	0 986 435 210
								0 986 435 245
2.0 D [R 55]	2,0	82	N47 C20A	02.13-06.14	4	DBJ	0 445 110 601	0 986 435 179
<b>Cooper Countryman</b>								
1.6 D, D ALL4 [R 60]	1,6	82	N47 C16A	09.10-10.16	4	DBJ,EU5	0 445 110 600	0 986 435 210
				07.14-10.16	4	DBJ,EU6	0 445 110 599	0 986 435 253
2.0 D, D ALL4 [F 60]	2,0	100-110	B47 C20A	02.17→	4	DBJ	0 445 110 613	0 986 435 268
D, D ALL4, SD, SD ALL4 [R 60]	2,0	82/100-105	N47 C20A	03.11-06.14	4	DBJ	0 445 110 601	0 986 435 179
SD, SD ALL4 [F 60]	2,0	120-140	B47 C20A	07.14-10.16	4	DBJ	0 445 110 613	0 986 435 268
								0 445 110 743
								0 986 435 269
<b>Cooper Coupé</b>								
2.0 SD [R 58]	2,0	100-105	N47 C20A	09.11-06.14	4	DBJ	0 445 110 601	0 986 435 179
				07.14-05.15	4	DBJ	0 445 110 613	0 986 435 268
<b>Cooper One</b>								
1.5 [F 55]	1,5	70	B37 C15A	11.14→	3	DBJ	0 445 110 598	
				03.14→	3	DBJ	0 445 110 598	
1.6 D [R 56]	1,6	66	N47 C16A	08.10-11.13	4	DBJ	0 445 110 600	0 986 435 210
				09.09-07.10	4	DBJ	0 445 110 259	0 986 435 126
<b>Cooper One Clubman</b>								
1.5 [F 54]	1,5	85	B37 C15A	11.15→	3	DBJ	0 445 110 598	
1.6 D [R 55]	1,6	66	N47 C16A	09.10-06.14	4	DBJ	0 445 110 600	0 986 435 210
								0 986 435 245
<b>Cooper One Countryman</b>								
1.5 D [F 60]	1,5	85	B37 C15A	07.17→	3	DBJ	0 445 110 598	
1.6 D [R 60]	1,6	66	N47 C16A	09.10-10.16	4	DBJ,EU5	0 445 110 600	0 986 435 210
				07.14-10.16	4	DBJ,EU6	0 445 110 599	0 986 435 253
<b>Cooper Paceman</b>								
1.6 D, D ALL4 [R 61]	1,6	82	N47 C16A	03.13-09.16	4	DBJ	0 445 110 600	0 986 435 210
								0 986 435 245
2.0 D, D ALL4, SD, SD ALL4 [R 61]	2,0	82/100-105	N47 C20A	03.13-06.14	4	DBJ	0 445 110 601	0 986 435 179
								0 445 110 613
								0 986 435 268
<b>Cooper Roadster</b>								
2.0 SD [R 59]	2,0	100-105	N47 C20A	02.12-06.14	4	DBJ	0 445 110 601	0 986 435 179
				07.14-04.15	4	DBJ	0 445 110 613	0 986 435 268







## NISSAN

Cube						
1.5 dCi [Z12]	1,5	81	K9K	10.09-03.11	4	2 430 105 043
Evalia						
1.5 dCi [M20M]	1,5	63-66/ 78-84	K9K	10.10→	4	2 430 105 043
Juke						
1.5 dCi [F15]	1,5	81	K9K <Euro 5>; K9K 6...	07.10→	4	2 430 105 043
Kubistar						
1.5 D Turbo 60, D Turbo 70, D Turbo 80 [X76]	1,5	40-45/48- 50/60-62	K9K...	07.03-03.09	4	2 430 105 043
Micra						
1.5 D Turbo [K12E]	1,5	60-63	K9K...	08.03-10.10	4	2 430 105 043
DCi [K14FR]	1,5	66	K9K	01.17→	4	2 430 105 043
Murano						
2.5 dCi 4x4 [Z51]	2,5	140	YD25DDTI	05.10-06.15	4	9 431 612 213
Navara						
2.3 DCi [D23M]	2,3	120	M9T	11.15→	4	2 430 105 043
2.5 DCi [D40M]	2,5	106/140	YD25DDTI	05.15→	4	9 431 612 213
dCi, dCi 4x4 [D40]	2,5	106/120/ 126-128/ 140	YD25DDTI	05.05-06.14	4	9 431 612 213
DCi 4x4 [D40T]	2,5	128	YD25DDTI <DOHC>	08.07-08.14	4	9 431 612 213
3.0 dCi 4x4 [D40]	3,0	170	V9X	05.10-06.14	6	2 430 105 043
DCi 4x4 [D40M]	3,0	170	V9X	05.15→	6	2 430 105 043
Navara NP300						
2.3 dCi [D23M]	2,3	116-140	YS23 <dCi>	11.15→	4	2 430 105 043
Note						
1.5 DCi Turbo [E12]	1,5	66	K9K	12.13→	4	2 430 105 043
dCi 86, dCi 90, dCi 105 [E11]	1,5	63/66/76	K9K; K9K <Euro 5>	01.06-08.14	4	2 430 105 043
NP300						
2.5 dCi, dCi 4x4 [D22SS]	2,5	98	YD25	08.10→	4	9 431 612 213
NV200						
1.5 dCi [M20]	1,5	63	K9K	08.09-05.10	4	2 430 105 043
dCi [M20M]	1,5	63/66/78	K9K	11.09→	4	2 430 105 043
Pathfinder						
2.5 dCi 4x4 [R51]	2,5	128/140	YD25DDTI	01.05-11.14	4	9 431 612 213
3.0 dCi 4x4 [R51]	3,0	170	V9X	05.10-11.14	6	2 430 105 043
Pickup						
2.5 dCi, dCi 4x4 [D22]	2,5	98	YD25DDTI	02.08-12.11	4	9 431 612 213
Primera						
1.9 D Turbo [P12E]	1,9	85-88	F9Q	01.03-07.10	4	2 430 105 043
2.2 D Turbo [P12E]	2,2	93/100- 102	YD22DDT	12.01-09.10	4	9 431 612 213
Primera Hatchback						
1.9 D Turbo [P12E]	1,9	85-88	F9Q	01.03-07.10	4	2 430 105 043
2.2 D Turbo [P12E]	2,2	93/100- 102	YD22DDT	05.02-09.10	4	9 431 612 213
Primera Wagon						
1.9 D Turbo [P12E]	1,9	85-88	F9Q	01.03-07.10	4	2 430 105 043
2.2 D Turbo [P12E]	2,2	93/100- 102	YD22DDT	12.01-09.10	4	9 431 612 213
Pulsar						
1.5 dCi [C13]	1,5	81	K9K 6...	07.14→	4	2 430 105 043
Qashqai						
1.5 dCi [J10]	1,5	76-78/81	K9K	12.06-12.13	4	2 430 105 043
DCi [J11E]	1,5	81	K9K	12.13→	4	2 430 105 043
1.6 [J11R]	1,6	96	R9M	10.15→	4	2 430 105 043
dCi, dCi 4x4 [J10]	1,6	96	R9M	07.11-12.13	4	2 430 105 043



1.6 DCi, DCi 4x4 [J11E]	1,6	96	R9M	12.13→	4					2 430 105 043
2.0 dCi, dCi 4x4 [J10]	2,0	110	M9R	04.07-12.13	4	DBB, EU5	0 445 115 022	0 986 435 390		2 430 105 043
<b>Qashqai+2</b>										
1.5 dCi [JJ10]	1,5	78/81	K9K	08.08-12.13	4					2 430 105 043
1.6 dCi, dCi 4x4 [JJ10]	1,6	96	R9M	07.11-12.13	4					2 430 105 043
2.0 dCi, dCi 4x4 [JJ10]	2,0	110	M9R	08.08-12.13	4	DBB, EU5	0 445 115 022	0 986 435 390		2 430 105 043
<b>X-Trail</b>										
1.6 cDi, dCi [T32]	1,6	96	R9M	04.14→	4					2 430 105 043
DCi 4WD [T32R]	1,6	96	R9M	12.14-04.16	4					2 430 105 043
4x4 [T32RR]	1,6	96	R9M	05.16→	4					2 430 105 043
2.0 D Turbo 4WD [T31]	2,0	127	M9R	09.08-04.14	4	DBB, ZE	0 445 115 022	0 986 435 390		2 430 105 043
dCi [T31]	2,0	110	M9R	04.07-06.10	4	DBB	0 445 115 022	0 986 435 390		2 430 105 043
				04.07-04.14	4	DBB	0 445 115 022	0 986 435 390		2 430 105 043
					4	DBB, ZE	0 445 115 022	0 986 435 390		2 430 105 043
dCi, dCi 4x4 [T32]	2,0	130	M9R	11.16→	4					2 430 105 043
dCi 4x4 [T31]	2,0	110	M9R	04.07-06.10	4	DBB	0 445 115 022	0 986 435 390		2 430 105 043
				04.07-04.14	4	DBB	0 445 115 022	0 986 435 390		2 430 105 043
					4	DBB, ZE	0 445 115 022	0 986 435 390		2 430 105 043
				RUS 07.10-04.14	4	DBB	0 445 115 022	0 986 435 390		2 430 105 043
		127	M9R	04.07-04.14	4	DBB, ZE	0 445 115 022	0 986 435 390		2 430 105 043
dCi 4x4 [T31R]	2,0	110	M9R	02.10-12.14	4	DBB	0 445 115 022	0 986 435 390		2 430 105 043
		127	M9R	02.10-12.14	4					2 430 105 043
2.2 D Turbo 4x4 [T30]	2,2	84/100	YD22DDTi; YD22ETI	06.01-03.07	4					9 431 612 213

OPEL

<b>Agila</b>										
1.3 CDTi [A]	1,3	51	Z 13 DT <Ecotec>	08.03-02.08	4	DBB	0 445 110 083	0 986 435 078		
CDTi [B]	1,2	55	Z 13 DTJ	07.08-08.15	4	DBB	0 445 110 183	0 986 435 102		
<b>Antara</b>										
2.0 CDTi, CDTi 4x4	2,0	93/110	Z 20 DM; Z 20 DMH	05.06-12.11	4	DBJ	0 445 110 269	0 986 435 153		
								0 986 435 238		
CDTi, CDTi 4x4	2,0	125	B 20 DTH	03.16-12.17	4	DBJ	0 445 110 713			F 00V C17 504
<b>Astra</b>										
1.3 CDTi [H]	1,2	66	Z 13 DTH <Ecotec>	08.05-03.10	4	DBB	0 445 110 183	0 986 435 102		
CDTi [J]	1,2	66-70	A 13 DTE <ecoFLEX>	09.09→	4	DBJ	0 445 110 326	0 986 435 200		
1.7 CDTi [G]	1,7	59	Z 17 DTL <Turbo Ecotec>	03.03-01.04	4	DBJ	0 445 110 118	0 986 435 082		
CDTi [H]	1,7	59	Z 17 DTL <Turbo Ecotec>	03.04-09.05	4	DBJ	0 445 110 174	0 986 435 105		
		74	Z 17 DTH	03.04-08.09	4	DBJ	0 445 110 175	0 986 435 089		
1.9 CDTi [H]	1,9	74	Z 19 DTL <Ecotec>	10.05-09.09	4	DBB, TW	0 445 110 165	0 986 435 103		
					4	DBJ, TW	0 445 110 276	0 986 435 148		
			Mot.-Nr. →6260381	10.05-09.09	4					F 00V C17 504
			Mot.-Nr. 6260382→	10.05-09.09	4					F 00V C17 504
	88		Z 19 DT <Ecotec>	09.04-03.10	4					F 00V C17 504
			Fg.-Nr. →72045139 →75030986 →78025126	09.04-03.10	4	DBB	0 445 110 165	0 986 435 103		
			Fg.-Nr. 72045140 → 75030987 → 78025127 → 78007392 →	09.04-03.10	4	DBJ	0 445 110 276	0 986 435 148		
			Z 19 DTJ <Turbo Ecotec>	04.04-03.10	4					F 00V C17 504
			Fg.-Nr. →72045139 →75030986 →78025126	04.04-03.10	4	DBB	0 445 110 159	0 986 435 088		
			Fg.-Nr. 72045140 → 75030987 → 78025127 →	04.04-03.10	4	DBB	0 445 110 243	0 986 435 104		
	110		Z 19 DTH <Ecotec>	04.04-03.10	4					F 00V C17 504
			Fg.-Nr. →72045139 →75030986 →78025126	04.04-03.10	4	DBB	0 445 110 159	0 986 435 088		
			Fg.-Nr. 72045140 → 75030987 → 78025127 →	04.04-03.10	4	DBB	0 445 110 243	0 986 435 104		
2.0 CDTi [J]	2,0	118/121	A 20 DTH <ecoFlex>	09.09→	4	DBB	0 445 110 327	0 986 435 201		F 00V C17 504
		143	A 20 DTR <Ecotec>	08.12→	4	DBB	0 445 117 018	0 986 435 427		F 00V C17 504
<b>Astra Cabrio</b>										
1.7 CDTi [G]	1,7	59	Z 17 DTL <Turbo Ecotec>	03.03-08.05	4	DBJ	0 445 110 118	0 986 435 082		





◀ OPEL

Astra Caravan									
1.3 CDTi [H]	1,2	66	Z 13 DTH <Ecotec>	08.05-03.10	4	DBB	0 445 110 183	0 986 435 102	
1.7 CDTi [G]	1,7	59	Z 17 DTL <Turbo Ecotec>	03.03-07.09	4	DBJ	0 445 110 118	0 986 435 082	
CDTi [H]	1,7	59	Z 17 DTL <Turbo Ecotec>	08.04-09.05	4	DBJ	0 445 110 174	0 986 435 105	
		74	Z 17 DTH	08.04-08.09	4	DBJ	0 445 110 175	0 986 435 089	
1.9 CDTi [H]	1,9	74	Z 19 DTL <Ecotec>	09.05-07.10	4	DBB,TW	0 445 110 165	0 986 435 103	
					4	DBJ,TW	0 445 110 276	0 986 435 148	
			Mot.-Nr. →6260381	09.05-07.10	4				F 00V C17 504
			Mot.-Nr. 6260382→	09.05-07.10	4				F 00V C17 504
	88		Z 19 DT <Ecotec>	09.05-03.10	4				F 00V C17 504
			Fg.-Nr. →72045139 →75030986	09.05-03.10	4	DBB	0 445 110 165	0 986 435 103	
			→78025126						
			Fg.-Nr. 72045140→75030987→	09.05-03.10	4	DBJ	0 445 110 276	0 986 435 148	
			78025127→78007392→						
			Z 19 DTJ <Turbo Ecotec>	08.04-03.10	4				F 00V C17 504
			Fg.-Nr. →72045139 →75030986	08.04-03.10	4	DBB	0 445 110 159	0 986 435 088	
			→78025126						
			Fg.-Nr. 72045140→75030987→	08.04-03.10	4	DBB	0 445 110 243	0 986 435 104	
			78025127→						
	110		Z 19 DTH <Ecotec>	09.04-03.10	4				F 00V C17 504
			Fg.-Nr. →72045139 →75030986	09.04-03.10	4	DBB	0 445 110 159	0 986 435 088	
			→78025126						
			Fg.-Nr. 72045140→75030987→	09.04-03.10	4	DBB	0 445 110 243	0 986 435 104	
			78025127→						
Astra Coupé									
1.7 CDTi [G]	1,7	59	Z 17 DTL <Turbo Ecotec>	03.03-02.05	4	DBJ	0 445 110 118	0 986 435 082	
Astra GTC									
1.3 CDTi [H]	1,2	66	Z 13 DTH <Ecotec>	06.05-02.09	4	DBB	0 445 110 183	0 986 435 102	
1.7 CDTi [H]	1,7	59	Z 17 DTL <Turbo Ecotec>	03.05-03.07	4	DBJ	0 445 110 174	0 986 435 105	
		74	Z 17 DTH	09.05-08.09	4	DBJ	0 445 110 175	0 986 435 089	
1.9 CDTi [H]	1,9	74	Z 19 DTL <Ecotec>	07.05-07.10	4	DBB,TW	0 445 110 165	0 986 435 103	
					4	DBJ,TW	0 445 110 276	0 986 435 148	
			Mot.-Nr. →6260381	07.05-07.10	4				F 00V C17 504
			Mot.-Nr. 6260382→	07.05-07.10	4				F 00V C17 504
	88		Z 19 DT <Ecotec>	07.05-07.10	4	DBB,TW	0 445 110 165	0 986 435 103	
					4	DBJ,TW	0 445 110 276	0 986 435 148	
			Mot.-Nr. →6260381	07.05-07.10	4				F 00V C17 504
			Mot.-Nr. 6260382→	07.05-07.10	4				F 00V C17 504
			Z 19 DTJ <Turbo Ecotec>	03.05-03.08	4				F 00V C17 504
			Fg.-Nr. →72045139 →75030986	03.05-03.08	4	DBB	0 445 110 159	0 986 435 088	
			→78025126						
			Fg.-Nr. 72045140→75030987→	03.05-03.08	4	DBB	0 445 110 243	0 986 435 104	
			78025127→						
	110		Z 19 DTH <Ecotec>	03.05-09.09	4				F 00V C17 504
			Fg.-Nr. →72045139 →75030986	03.05-09.09	4	DBB	0 445 110 159	0 986 435 088	
			→78025126						
			Fg.-Nr. 72045140→75030987→	03.05-09.09	4	DBB	0 445 110 243	0 986 435 104	
			78025127→						
2.0 CDTi [J]	2,0	96/121	A 20 DTH <ecoFlex>; Z 20 DTJ	09.11→	4	DBB	0 445 110 327	0 986 435 201	F 00V C17 504
		143	A 20 DTR <Ecotec>	08.12→	4				F 00V C17 504
Astra Sports Tourer									
1.3 CDTi [J]	1,2	67-70	A 13 DTE <ecoFLEX>	09.10→	4	DBJ	0 445 110 326	0 986 435 200	
2.0 CDTi [J]	2,0	96		06.15→	4	DBB	0 445 110 327	0 986 435 201	F 00V C17 504
		118/121	A 20 DTH <ecoFlex>	09.10→	4	DBB	0 445 110 327	0 986 435 201	F 00V C17 504
		143	A 20 DTR <Ecotec>	08.12→	4	DBB	0 445 117 018	0 986 435 427	F 00V C17 504
Astra TwinTop									
1.9 CDTi [H]	1,9	110	Z 19 DTH <Ecotec>	09.05-10.10	4				F 00V C17 504
			Fg.-Nr. →72045139 →75030986	09.05-10.10	4	DBB	0 445 110 159	0 986 435 088	
			→78025126 →7G						
			Fg.-Nr. 72045140→75030987→	09.05-10.10	4	DBB	0 445 110 243	0 986 435 104	
			78025127→7G→						
Cascada									
2.0 CDTi	2,0	121	A 20 DTH <ecoFlex>	03.13→	4	DBB	0 445 110 327	0 986 435 201	F 00V C17 504



2.0 CDTI	2,0	125	B 20 DTH	09.15→	4	DBJ	0 445 110 713		F 00V C17 504
		143	A 20 DTR <Ecotec>	03.13→	4	DBB	0 445 117 018	0 986 435 427	F 00V C17 504
<b>Combo</b>									
1.3 CDTI [C]	1,3	51	Y 13 DT <Ecotec>; Z 13 DT <Ecotec>	09.04-09.07	4	DBB	0 445 110 083	0 986 435 078	
		55	Z 13 DTJ <Ecotec>	10.05-01.12	4	DBB	0 445 110 183	0 986 435 102	
CDTI [D]	1,2	66	A 13 FD <ecoFLEX>	02.12→	4	DBB	0 445 110 351	0 986 435 204	
1.6 CDTI [D]	1,6	66	A 16 FDL <ecoFLEX>	02.12→	4	DBJ,EU5	0 445 110 300	0 986 435 171	F 00V C17 504
					4	5PL,DBJ,EU6	0 445 110 524	0 986 435 280	F 00V C17 504
		70/88		10.15→	4	DBJ,EU5	0 445 110 300	0 986 435 171	F 00V C17 504
					4	5PL,DBJ,EU6	0 445 110 524	0 986 435 280	F 00V C17 504
		74/77	A 16 FDH <ecoFLEX>	02.12→	4	DBJ,EU5	0 445 110 300	0 986 435 171	F 00V C17 504
					4	5PL,DBJ,EU6	0 445 110 524	0 986 435 280	F 00V C17 504
2.0 CDTI [D]	2,0	99	A 20 FD <ecoFLEX>	02.12→	4	DBJ,EU5	0 445 110 299	0 986 435 230	F 00V C17 504
					4	5PL,DBJ	0 445 110 419	0 986 435 213	F 00V C17 504
<b>Corsa</b>									
1.3 [E]	1,2	55/70	B 13 DTC; B 13 DTE; B 13 DTR	10.14→	4	DBJ	0 445 110 618		
CDTI [C]	1,3	51	Y 13 DT <Ecotec>; Z 13 DT <Ecotec>	09.03-09.06	4	DBB	0 445 110 083	0 986 435 078	
		55	Z 13 DTJ <Ecotec>	09.05-09.06	4	DBB	0 445 110 183	0 986 435 102	
CDTI [D]	1,2	55/66	A 13 DTH <Ecotec>; Z 13 DTH <Ecotec>; Z 13 DTJ <Ecotec>	07.06-07.10	4	DBB	0 445 110 183	0 986 435 102	
		55/70	A 13 DT...; A 13 DTC <Ecotec>; Z 13 DTE	12.09-08.14	4	DBJ	0 445 110 326	0 986 435 200	
1.7 D [B]	1,7	44	17 D <4EE1>	03.93-08.00	4				F 00V C17 504
<b>Crossland X</b>									
1.6	1,6	73/88	B 16 DT <LEK>; <LDI>	01.17→	4				F 00V C17 504
<b>Grandland X</b>									
1.5	1,5	74/96	<LQJ>; <LQP>	03.18→	4				F 00V C17 504
1.6	1,6	88	<LDI>	10.17→	4				F 00V C17 504
<b>Insignia</b>									
2.0 CDTI [A]	2,0	81	A 20 DT... <Ecotec>	09.08-12.17	4				F 00V C17 504
			Mot.-Typ A 20 DT	09.08-12.17	4	DBB	0 445 110 423	0 986 435 237	
			Mot.-Typ A 20 DTL						
			Mot.-Typ A 20 DTJ	09.08-12.17	4	DBB	0 445 110 327	0 986 435 201	
			Mot.-Typ A 20 DTH						
			Mot.-Typ A 20 DTC						
		88/103	A 20 DTE	09.13-12.17	4	DBB	0 445 110 423	0 986 435 237	F 00V C17 504
		96	A 20 DT... <ecoFlex>	09.08-12.17	4				F 00V C17 504
			Mot.-Typ A 20 DT	09.08-12.17	4	DBB	0 445 110 423	0 986 435 237	
			Mot.-Typ A 20 DTL						
			Mot.-Typ A 20 DTJ	09.08-12.17	4	DBB	0 445 110 327	0 986 435 201	
			Mot.-Typ A 20 DTH						
			Mot.-Typ A 20 DTC						
CDTI, CDTI 4x4 [A]	2,0	118	A 20 DTH <ecoFlex>	09.08-12.17	4	DBB	0 445 110 327	0 986 435 201	F 00V C17 504
		125	B 20 DTH	01.15-12.17	4	DBJ	0 445 110 713		F 00V C17 504
		140-143	A 20 DTR <Ecotec>	07.09-12.17	4	DBB	0 445 117 018	0 986 435 427	F 00V C17 504
<b>Insignia Grand Sport</b>									
2.0 ,4x4 [B]	2,0	125	<LFS>	03.17→	4	DBJ	0 445 110 713		F 00V C17 504
4x4 [B]	2,0	154	<LFO>	10.17→	4	DBJ	0 445 110 809		F 00V C17 504
<b>Insignia Sports Tourer</b>									
2.0 ,4x4 [B]	2,0	125	<LFS>	03.17→	4	DBJ	0 445 110 713		F 00V C17 504
CDTI [A]	2,0	81	A 20 DT... <Ecotec>	02.09-12.17	4				F 00V C17 504
			Mot.-Typ A 20 DT	02.09-12.17	4	DBB	0 445 110 423	0 986 435 237	
			Mot.-Typ A 20 DTL						
			Mot.-Typ A 20 DTJ	02.09-12.17	4	DBB	0 445 110 327	0 986 435 201	
			Mot.-Typ A 20 DTH						
			Mot.-Typ A 20 DTC						
		88/103	A 20 DTE	09.13-12.17	4	DBB	0 445 110 423	0 986 435 237	F 00V C17 504





◀ OPEL

<b>2.0 CDTI [A]</b>	2,0	96	A 20 DT... <ecoFlex>	02.09-12.17	4				<b>F 00V C17 504</b>	
			Mot.-Typ A 20 DT	02.09-12.17	4	DBB	<b>0 445 110 423</b>	<b>0 986 435 237</b>		
			Mot.-Typ A 20 DTL							
			Mot.-Typ A 20 DTJ	02.09-12.17	4	DBB	<b>0 445 110 327</b>	<b>0 986 435 201</b>		
			Mot.-Typ A 20 DTH							
		125	B 20 DTH	01.15-12.17	4	DBJ	<b>0 445 110 713</b>		<b>F 00V C17 504</b>	
CDTI, CDTI 4x4 [A]	2,0	118	A 20 DTH <ecoFlex>	02.09-12.17	4	DBB	<b>0 445 110 327</b>	<b>0 986 435 201</b>	<b>F 00V C17 504</b>	
		140-143	A 20 DTR <Ecotec>	07.09-12.17	4	DBB	<b>0 445 117 018</b>	<b>0 986 435 427</b>	<b>F 00V C17 504</b>	
4x4 [B]	2,0	154	<LFO>	10.17→	4	DBJ	<b>0 445 110 809</b>		<b>F 00V C17 504</b>	
<b>Meriva</b>										
<b>1.3 CDTI [A]</b>	1,3	51	Y 13 DT <Ecotec>; Z 13 DT <Ecotec>	04.05-03.10	4	DBB	<b>0 445 110 083</b>	<b>0 986 435 078</b>		
CDTI [B]	1,2	55	Z 13 DTJ <Ecotec>	09.03-03.10	4	DBB	<b>0 445 110 183</b>	<b>0 986 435 102</b>		
		70	A 13 DTC <Ecotec>							
			Fg.-Nr. A4192110→	04.10-12.17	4	DBJ	<b>0 445 110 326</b>	<b>0 986 435 200</b>		
			Fg.-Nr. →A4192109	04.10-12.17	4	DBJ	<b>0 445 110 325</b>	<b>0 986 435 199</b>	<b>0 986 435 200</b>	
			A 13 DTE <ecoFLEX>	04.10-12.17	4	DBJ	<b>0 445 110 326</b>	<b>0 986 435 200</b>		
<b>Signum</b>										
<b>1.9 CDTI</b>	1,9	74	Z 19 DTL <Ecotec>	08.05-09.08	4				<b>F 00V C17 504</b>	
			Fg.-Nr. →71021891	08.05-09.08	4	DBB	<b>0 445 110 165</b>	<b>0 986 435 103</b>		
			Fg.-Nr. 71021892→	08.05-09.08	4	DBJ	<b>0 445 110 276</b>	<b>0 986 435 148</b>		
		88	Z 19 DT <Ecotec>	04.04-09.08	4				<b>F 00V C17 504</b>	
			Fg.-Nr. →71021891	04.04-09.08	4	DBB	<b>0 445 110 165</b>	<b>0 986 435 103</b>		
					Fg.-Nr. 71021892→	04.04-09.08	4	DBJ	<b>0 445 110 276</b>	<b>0 986 435 148</b>
110	Z 19 DTH <Ecotec>									
	Fg.-Nr. →71021891	04.04-09.08	4	DBB	<b>0 445 110 159</b>	<b>0 986 435 088</b>	<b>F 00V C17 504</b>			
	Fg.-Nr. 71021892→	04.04-09.08	4	DBB	<b>0 445 110 243</b>	<b>0 986 435 104</b>	<b>F 00V C17 504</b>			
<b>Tigra TwinTop</b>										
<b>1.3 CDTI [B]</b>	1,3	51	Z 13 DT <Ecotec>	06.04-03.09	4	DBB	<b>0 445 110 083</b>	<b>0 986 435 078</b>		
<b>Vectra</b>										
<b>1.9 CDTI, CDTI GTS [C]</b>	1,9	74	Z 19 DTL <Ecotec>	09.05-10.08	4				<b>F 00V C17 504</b>	
			Fg.-Nr. →71021891 →48999999	09.05-10.08	4	DBB	<b>0 445 110 165</b>	<b>0 986 435 103</b>		
			Fg.-Nr. 71021892→	09.05-10.08	4	DBJ	<b>0 445 110 276</b>	<b>0 986 435 148</b>		
		88	Z 19 DT <Ecotec>	04.04-10.08	4				<b>F 00V C17 504</b>	
			Fg.-Nr. →71021891 →48999999	04.04-10.08	4	DBB	<b>0 445 110 165</b>	<b>0 986 435 103</b>		
					Fg.-Nr. 71021892→	04.04-10.08	4	DBJ	<b>0 445 110 276</b>	<b>0 986 435 148</b>
110	Z 19 DTH <Ecotec>									
	Fg.-Nr. →71021891 →48999999	04.04-03.08	4	DBB	<b>0 445 110 159</b>	<b>0 986 435 088</b>	<b>F 00V C17 504</b>			
	Fg.-Nr. 71021892→	04.04-03.08	4	DBB	<b>0 445 110 243</b>	<b>0 986 435 104</b>	<b>F 00V C17 504</b>			
<b>Vectra Caravan</b>										
<b>1.9 CDTI [C]</b>	1,9	74	Z 19 DTL <Ecotec>	09.05-10.08	4				<b>F 00V C17 504</b>	
			Fg.-Nr. →71021891 →48999999	09.05-10.08	4	DBB	<b>0 445 110 165</b>	<b>0 986 435 103</b>		
			Fg.-Nr. 71021892→	09.05-10.08	4	DBJ	<b>0 445 110 276</b>	<b>0 986 435 148</b>		
		88	Z 19 DT <Ecotec>	04.04-10.08	4				<b>F 00V C17 504</b>	
			Fg.-Nr. →71021891 →48999999	04.04-10.08	4	DBB	<b>0 445 110 165</b>	<b>0 986 435 103</b>		
					Fg.-Nr. 71021892→	04.04-10.08	4	DBJ	<b>0 445 110 276</b>	<b>0 986 435 148</b>
110	Z 19 DTH <Ecotec>									
	Fg.-Nr. →71021891 →48999999	04.04-03.08	4	DBB	<b>0 445 110 159</b>	<b>0 986 435 088</b>	<b>F 00V C17 504</b>			
	Fg.-Nr. 71021892→	04.04-03.08	4	DBB	<b>0 445 110 243</b>	<b>0 986 435 104</b>	<b>F 00V C17 504</b>			
<b>Zafira</b>										
<b>1.9 CDTI [B]</b>	1,9	74	Z 19 DTL <Ecotec>							
			Fg.-Nr. →62999999 →6G999999	07.05-03.08	4	DBB	<b>0 445 110 165</b>	<b>0 986 435 103</b>	<b>F 00V C17 504</b>	
			Fg.-Nr. 72000001→7G000001→	07.05-03.08	4	DBJ	<b>0 445 110 276</b>	<b>0 986 435 148</b>		
		Fg.-Nr. 72000001→92	07.05-03.08	4				<b>F 00V C17 504</b>		
					7G000001→9G					
		88	Z 19 DT <Ecotec>							
Fg.-Nr. →62999999 →6G999999	07.05-12.10		4	DBB	<b>0 445 110 165</b>	<b>0 986 435 103</b>				
Fg.-Nr. 72000001→7G000001→	07.05-12.10		4	DBJ	<b>0 445 110 276</b>	<b>0 986 435 148</b>				
Mot.-Nr. →6260381	07.05-12.10		4				<b>F 00V C17 504</b>			
			Mot.-Nr. 6260382→	07.05-12.10	4			<b>F 00V C17 504</b>		



1.9 CDTi [B]	1,9	110	Z 19 DTH <Ecotec>	07.05-12.10	4					F 00V C17 504	
			Fg.-Nr. →62999999 →6G999999	07.05-12.10	4	DBB	0 445 110 159	0 986 435 088			
			Fg.-Nr. 72000001→7G000001→	07.05-12.10	4	DBB	0 445 110 243	0 986 435 104			
2.0 CDTi [C]	2,0	81	A 20 DTL <Ecotec>	01.12→	4	DBB	0 445 110 423	0 986 435 237		F 00V C17 504	
			96	A 20 DT <ecoFlex>	01.12→	4	DBB	0 445 110 423	0 986 435 237		F 00V C17 504
				Z 20 DTJ	03.12→	4	DBB	0 445 110 327	0 986 435 201		F 00V C17 504
			96/125	B 20 DTH; B 20 DTJ	02.15→	4	DBJ	0 445 110 713			F 00V C17 504
			121	A 20 DTH <ecoFlex>	01.12→	4	DBB	0 445 110 327	0 986 435 201		F 00V C17 504
	143	A 20 DTR <Ecotec>	08.12→	4					F 00V C17 504		

PEUGEOT

**Bipper**

1.3 HDi [A9]	1,3	55	FHZ <F13DTE5>	08.10→	4	DBB	0 445 110 351	0 986 435 204	
			59	FHY <F 13DTE6>	09.15→	4	DBB	0 445 110 614	0 986 435 249
1.4 HDi [A9]	1,4	50	8HS <DV4TED>	02.08→	4	DBJ	0 445 110 252	0 986 435 143	

**Expert**

1.6 BlueHdi [K0]	1,6	70	BHS <DV6FDU>	03.16→	4	DBJ	0 445 110 565		F 00V C17 504	
				BHV <DV6FDU>	02.16→	4	DBJ	0 445 110 565		F 00V C17 504
			85	BHX <DV6FCU>	03.16→	4	DBJ	0 445 110 565		F 00V C17 504
Hdi [G9]	1,6	66	9HH <DV6DU M>; 9HM <DV6U C>	12.10→	4	DBJ	0 445 110 340	0 986 435 203	F 00V C17 504	
				9HU <DV6UTED4>	02.07→	4	DBJ	0 445 110 239	0 986 435 122	F 00V C17 504
2.0 HDi [U64]	2,0	70	RHX <DW10BTED>							
			Org.-Nr. →8763	10.99-11.00	4	DBB,I2G	0 445 110 044	0 986 435 003		
					4	DBJ,I1B	0 445 110 008	0 986 435 003		
			Org.-Nr. 8764→	12.00-01.07	4	DBB	0 445 110 076	0 986 435 077		
			80	RHZ <DW10ATED>	10.99-01.07	4	DBB,I2G	0 445 110 044	0 986 435 003	
		4	DBJ,I1B	0 445 110 008	0 986 435 003					
	81	RHW <DW10ATED4/L4>	06.00-01.07	4	DBB	0 445 110 057	0 986 435 093			

**Partner**

1.6 BlueHdi [B9]	1,6	55	BHW <DV6FE>	03.15→	4	DBJ	0 445 110 565		F 00V C17 504	
			73	BHY <DV6FD>	12.14→	4	DBJ	0 445 110 565		F 00V C17 504
			88	BHZ <DV6FC>	12.14→	4	DBJ	0 445 110 565		F 00V C17 504
Hdi [B9]	1,6	55	9HK <DV6ETED M>	06.11-03.15	4	DBJ	0 445 110 340	0 986 435 203	F 00V C17 504	
				9HT <DV6B/DV6BUTED4>	05.08-02.12	4	DBJ	0 445 110 311	0 986 435 146	F 00V C17 504
			55/66/68	9HF <DV6DTE4>; 9HN <DV6ETED4>; 9HP <DV6DTE4>	07.10-04.15	4	DBJ	0 445 110 340	0 986 435 203	F 00V C17 504
			66	9HS <DV6TED4BU/FAP>; 9HV <DV6TED4/FAP>	10.08-02.12	4	DBJ	0 445 110 297	0 986 435 150	F 00V C17 504
				9HX <DV6ATED4/DV6AUTED4>	05.08-02.12	4	DBJ	0 445 110 311	0 986 435 146	F 00V C17 504
	68	9HJ <DV6DTE4 M>	06.11-03.15	4	DBJ	0 445 110 340	0 986 435 203	F 00V C17 504		
	80-81	9HZ <DV6TED4/FAP>	05.08-02.12	4	DBJ	0 445 110 297	0 986 435 150	F 00V C17 504		
Hdi [M5]	1,6	55/66	9HW <DV6BTED4>; 9HX <DV6ATED4>	07.05-10.11	4	DBJ	0 445 110 239	0 986 435 122	F 00V C17 504	
2.0 HDi [M4]	2,0	66	RHY <DW10TD>							
			Org.-Nr. →8728	12.99-10.00	4	BO,DBB,I2G	0 445 110 044	0 986 435 003		
					4	BO,DBJ,I1B	0 445 110 008	0 986 435 003		
		Org.-Nr. 8729→	11.00-08.02	4	BO,DBB	0 445 110 076	0 986 435 077			
Hdi	2,0	66	DW10TD	05.02-08.06	4	DBB	0 445 110 044	0 986 435 003		

**Traveller**

1.6 BlueHdi [K0]	1,6	70	BHS <DV6FDU>	03.16→	4	DBJ	0 445 110 565		F 00V C17 504	
				BHV <DV6FDU>	03.16→	4	DBJ	0 445 110 565		F 00V C17 504
			85	BHX <DV6FCU>	03.16→	4	DBJ	0 445 110 565		F 00V C17 504

**206**

1.4 HDi [T1]	1,4	50	8H... <DV4TD>						
			Mot.-Nr. →232614	09.01-02.09	4	DBJ	0 445 110 075	0 986 435 076	
			Mot.-Nr. 232615→Org.-Nr. 10618	09.01-12.05	4	DBJ	0 445 110 135	0 986 435 085	
			Org.-Nr. 10619→	01.06-02.09	4	DBJ	0 445 110 252	0 986 435 143	
Hdi 16V [T1]	1,4	50	8H... <DV4TD>	09.08-12.10	4	DBJ,EE2	0 445 110 135	0 986 435 085	
					4	DBJ,FL5	0 445 110 252	0 986 435 143	







◀ PEUGEOT

<b>1.6 HDi [T1]</b>	1,6	80	9H... <DV6TED4>	05.04-03.07	4	DBJ,MPR	<b>0 445 110 297</b>	<b>0 986 435 150</b>		
			Org.-Nr. →10338	05.04-03.05	4	DBJ,MPR	<b>0 445 110 188</b>	<b>0 986 435 090</b>		
			Org.-Nr. 10339→	04.05-03.07	4	DBJ,MPR	<b>0 445 110 259</b>	<b>0 986 435 126</b>		
<b>2.0 HDi [T1]</b>	2,0	66	RHY <DW10TD>							
			Org.-Nr. →8700	04.99-09.00	4	DBB,I2G	<b>0 445 110 044</b>	<b>0 986 435 003</b>		
			Org.-Nr. 8701→	10.00-10.05	4	DBB	<b>0 445 110 076</b>	<b>0 986 435 077</b>		
<b>206+</b>										
<b>1.4 HDi [T3E]</b>	1,4	50	8HR <DV4C>	06.10-05.13	4	DBJ	<b>0 445 110 339</b>	<b>0 986 435 172</b>	<b>F 00V C17 504</b>	
			8HZ <DV4TD>	03.09-05.10	4	DBJ	<b>0 445 110 252</b>	<b>0 986 435 143</b>		
<b>206 CC</b>										
<b>1.6 HDi [T1]</b>	1,6	80	9H... <DV6TED4>	06.05-03.07	4	DBJ,MPR	<b>0 445 110 297</b>	<b>0 986 435 150</b>		
					4	DBJ,MPR	<b>0 445 110 259</b>	<b>0 986 435 126</b>		
<b>206 SW</b>										
<b>1.4 HDi [T1]</b>	1,4	50	8H... <DV4TD>							
			Mot.-Nr. →232614	03.02-12.06	4	DBJ	<b>0 445 110 075</b>	<b>0 986 435 076</b>		
			Mot.-Nr. 232615→	03.02-12.06	4	DBJ	<b>0 445 110 135</b>	<b>0 986 435 085</b>		
<b>1.6 HDi [T1]</b>	1,6	80	9H... <DV6TED4>	05.04-12.06	4	DBJ,MPR	<b>0 445 110 297</b>	<b>0 986 435 150</b>		
			Org.-Nr. →10338	05.04-03.05	4	DBJ,MPR	<b>0 445 110 188</b>	<b>0 986 435 090</b>		
			Org.-Nr. 10339→	04.05-12.06	4	DBJ,MPR	<b>0 445 110 259</b>	<b>0 986 435 126</b>		
<b>2.0 HDi [T1]</b>	2,0	66	RHY <DW10TD>	03.02-10.05	4	DBB	<b>0 445 110 076</b>	<b>0 986 435 077</b>		
<b>207</b>										
<b>1.4 HDi [A7]</b>	1,4	50	8HR <DV4C>	05.10-12.11	4	DBJ	<b>0 445 110 339</b>	<b>0 986 435 172</b>	<b>F 00V C17 504</b>	
			8HZ <DV4TD>	05.06-04.10	4	DBJ	<b>0 445 110 252</b>	<b>0 986 435 143</b>		
<b>1.6 HDi [A7]</b>	1,6	66	9HV <DV6TED4/FAP>	06.07-04.11	4	DBJ	<b>0 445 110 297</b>	<b>0 986 435 150</b>	<b>F 00V C17 504</b>	
			9HX <DV6ATED4>	05.06-04.11	4				<b>F 00V C17 504</b>	
			Org.-Nr. →11073	05.06-03.07	4	DBJ	<b>0 445 110 239</b>	<b>0 986 435 122</b>		
			Org.-Nr. 11074→	04.07-04.11	4	DBJ	<b>0 445 110 311</b>	<b>0 986 435 146</b>		
			68	9HP <DV6DTED>	04.10-04.12	4	DBJ	<b>0 445 110 340</b>	<b>0 986 435 203</b>	<b>F 00V C17 504</b>
			80	9H... <DV6TED4>	05.06-04.10	4	DBJ,MPR	<b>0 445 110 297</b>	<b>0 986 435 150</b>	<b>F 00V C17 504</b>
			Org.-Nr. →11073	05.06-03.07	4	DBJ,MPR	<b>0 445 110 259</b>	<b>0 986 435 126</b>		
			Org.-Nr. 11074→	04.07-04.10	4	DBJ,MPR	<b>0 445 110 297</b>	<b>0 986 435 150</b>		
<b>207+</b>										
<b>1.4 HDi</b>	1,4	50	8HR <DV4C>	11.12-06.15	4	DBJ	<b>0 445 110 339</b>	<b>0 986 435 172</b>	<b>F 00V C17 504</b>	
<b>207 CC</b>										
<b>1.6 HDi [A7]</b>	1,6	80	9H... <DV6TED4>	03.07-02.11	4				<b>F 00V C17 504</b>	
			Org.-Nr. →11073	03.07-03.07	4	DBJ	<b>0 445 110 259</b>	<b>0 986 435 126</b>		
			Org.-Nr. 11074→	04.07-02.11	4	DBJ	<b>0 445 110 297</b>	<b>0 986 435 150</b>		
<b>207 SW</b>										
<b>1.6 HDi [A7]</b>	1,6	66	9HV <DV6TED4/FAP>	06.07-04.11	4	DBJ	<b>0 445 110 297</b>	<b>0 986 435 150</b>	<b>F 00V C17 504</b>	
			9HX <DV6ATED4>	06.07-04.11	4	DBJ	<b>0 445 110 311</b>	<b>0 986 435 146</b>	<b>F 00V C17 504</b>	
			68	9HP <DV6DTED>	04.10-07.13	4	DBJ	<b>0 445 110 340</b>	<b>0 986 435 203</b>	<b>F 00V C17 504</b>
			80	9H... <DV6TED4>	06.07-04.10	4	DBJ	<b>0 445 110 297</b>	<b>0 986 435 150</b>	<b>F 00V C17 504</b>
<b>208</b>										
<b>1.4 HDi</b>	1,4	50	8H... <DV4C>	01.12-04.15	4	DBJ	<b>0 445 110 339</b>	<b>0 986 435 172</b>	<b>F 00V C17 504</b>	
<b>1.5 BlueHdi</b>	1,5	75	YHY <DV5RD>	10.17→	4	DBJ	<b>0 445 110 749</b>		<b>F 00V C17 504</b>	
<b>1.6 BlueHdi</b>	1,6	55/68-73	BHW <DV6FE>; BHY <DV6FD>	02.15→	4	DBJ	<b>0 445 110 565</b>		<b>F 00V C17 504</b>	
			Hdi	01.12→	4	DBJ	<b>0 445 110 340</b>	<b>0 986 435 203</b>	<b>F 00V C17 504</b>	
			85	BHX <DV6FC>	03.14→	4	DBJ	<b>0 445 110 565</b>	<b>F 00V C17 504</b>	
			88	BHZ <DV6FC>	03.14→	4	DBJ	<b>0 445 110 565</b>	<b>F 00V C17 504</b>	
<b>301</b>										
<b>1.6 Blue HDi [M3]</b>	1,6	73	BHY <DV6FD>	04.15→	4	DBJ	<b>0 445 110 565</b>		<b>F 00V C17 504</b>	
			Hdi [M3]	09.12→	4	DBJ	<b>0 445 110 340</b>	<b>0 986 435 203</b>	<b>F 00V C17 504</b>	
				09.12→	4	DBJ	<b>0 445 110 340</b>	<b>0 986 435 203</b>	<b>F 00V C17 504</b>	
<b>306</b>										
<b>2.0 HDi [N5]</b>	2,0	66	RHY <DW10TD>							
			Org.-Nr. →8756	06.99-05.00	4	DBB,I2G	<b>0 445 110 044</b>	<b>0 986 435 003</b>		
			Org.-Nr. 8757→	06.00-10.03	4	DBB	<b>0 445 110 076</b>	<b>0 986 435 077</b>		





**306 Break**

2.0 HDi [N5]	2,0	66	RHY <DW10TD>							
			Org.-Nr. →8756	06.99-05.00	4	DBB,I2G	<b>0 445 110 044</b>	<b>0 986 435 003</b>		
					4	DBJ,I1B	<b>0 445 110 008</b>	<b>0 986 435 003</b>		
			Org.-Nr. 8757→	06.00-03.02	4	DBB	<b>0 445 110 076</b>	<b>0 986 435 077</b>		

**307**

1.4 HDi [T5]	1,4	50	8HZ <DV4TD>							
			Mot.-Nr. →236724	10.01-05.05	4	DBJ	<b>0 445 110 075</b>	<b>0 986 435 076</b>		
			Mot.-Nr. 236725→	10.01-05.05	4	DBJ	<b>0 445 110 135</b>	<b>0 986 435 085</b>		
1.6 HDi [T5]	1,6	66	9HX <DV6ATED4>	02.04-05.05	4	DBJ	<b>0 445 110 239</b>	<b>0 986 435 122</b>	<b>F 00V C17 504</b>	
		80	9H... <DV6TED4>							
			Org.-Nr. →10373	02.04-04.05	4	DBJ	<b>0 445 110 188</b>	<b>0 986 435 090</b>		
			Org.-Nr. 10374→	05.05-05.05	4	DBJ	<b>0 445 110 259</b>	<b>0 986 435 126</b>		
HDi [T6]	1,6	66	9HV <DV6TED4/FAP>	05.06-08.07	4	DBJ	<b>0 445 110 297</b>	<b>0 986 435 150</b>		
			9HX <DV6ATED4>	06.05-08.07	4				<b>F 00V C17 504</b>	
			Org.-Nr. →11192	06.05-07.07	4	DBJ	<b>0 445 110 239</b>	<b>0 986 435 122</b>		
			Org.-Nr. 11193→	08.07-08.07	4	DBJ	<b>0 445 110 311</b>	<b>0 986 435 146</b>		
		80	9H... <DV6TED4>	06.05-08.07	4				<b>F 00V C17 504</b>	
			Org.-Nr. →10919	06.05-10.06	4	DBJ	<b>0 445 110 259</b>	<b>0 986 435 126</b>		
			Org.-Nr. 10920→	11.06-08.07	4	DBJ	<b>0 445 110 297</b>	<b>0 986 435 150</b>		
2.0 HDi [T5]	2,0	66	RHY <DW10TD>							
			Org.-Nr. →9064	08.00-09.01	4	BO,DBB	<b>0 445 110 062</b>	<b>0 986 435 077</b>		
			Org.-Nr. 9065→	10.01-05.05	4	BO,DBB	<b>0 445 110 076</b>	<b>0 986 435 077</b>		
		79	RHS <DW10ATED/FAP>	03.02-05.05	4	DBB	<b>0 445 110 076</b>	<b>0 986 435 077</b>		

**307 Break/SW**

1.4 HDi [T5]	1,4	50	8HZ <DV4TD>							
			Mot.-Nr. →236724	03.02-05.05	4	DBJ	<b>0 445 110 075</b>	<b>0 986 435 076</b>		
			Mot.-Nr. 236725→	03.02-05.05	4	DBJ	<b>0 445 110 135</b>	<b>0 986 435 085</b>		
1.6 HDi [T5]	1,6	66	9HX <DV6ATED4>	02.04-05.05	4	DBJ	<b>0 445 110 239</b>	<b>0 986 435 122</b>	<b>F 00V C17 504</b>	
		80	9H... <DV6TED4>							
			Org.-Nr. →10373	02.04-04.05	4	DBJ	<b>0 445 110 188</b>	<b>0 986 435 090</b>		
			Org.-Nr. 10374→	05.05-05.05	4	DBJ	<b>0 445 110 259</b>	<b>0 986 435 126</b>		
HDi [T6]	1,6	66	9HV <DV6TED4/FAP>	06.07-05.08	4	DBJ	<b>0 445 110 297</b>	<b>0 986 435 150</b>		
			9HX <DV6ATED4>	06.05-05.08	4				<b>F 00V C17 504</b>	
			Org.-Nr. →11192	06.05-07.07	4	DBJ	<b>0 445 110 239</b>	<b>0 986 435 122</b>		
			Org.-Nr. 11193→	08.07-05.08	4	DBJ	<b>0 445 110 311</b>	<b>0 986 435 146</b>		
		80	9H... <DV6TED4>	06.05-05.08	4				<b>F 00V C17 504</b>	
			Org.-Nr. →10919	06.05-10.06	4	DBJ	<b>0 445 110 259</b>	<b>0 986 435 126</b>		
			Org.-Nr. 10920→	11.06-05.08	4	DBJ	<b>0 445 110 297</b>	<b>0 986 435 150</b>		
2.0 HDi [T5]	2,0	66	RHY <DW10TD>	03.02-05.05	4	BO,DBB	<b>0 445 110 076</b>	<b>0 986 435 077</b>		
		79	RHS <DW10ATED/FAP>	03.02-05.05	4	DBB	<b>0 445 110 076</b>	<b>0 986 435 077</b>		

**308**

1.5 BlueHdi [T9]	1,5	96	YHZ <DV5RC>	06.17→	4	DBJ	<b>0 445 110 749</b>		<b>F 00V C17 504</b>	
1.6 Blue HDi [T9]	1,6	73	BHY <DV6FD>	01.14→	4	DBJ	<b>0 445 110 565</b>		<b>F 00V C17 504</b>	
		85	BHX <DV6FC>	01.14→	4	DBJ	<b>0 445 110 565</b>		<b>F 00V C17 504</b>	
		88	BH... <DV6FC>	01.14→	4	DBJ	<b>0 445 110 565</b>		<b>F 00V C17 504</b>	
HDi [T7]	1,6	66	9HV <DV6TED4/FAP>	09.07-03.10	4	DBJ	<b>0 445 110 297</b>	<b>0 986 435 150</b>	<b>F 00V C17 504</b>	
			9HX <DV6ATED4>	09.07-03.10	4	DBJ	<b>0 445 110 311</b>	<b>0 986 435 146</b>	<b>F 00V C17 504</b>	
		68	9HJ <DV6DTED M>; 9HP <DV6DTED>	04.10-06.13	4	DBJ	<b>0 445 110 340</b>	<b>0 986 435 203</b>	<b>F 00V C17 504</b>	
		80	9H... <DV6TED4>	09.07-03.10	4	DBJ,EE2, MPR,NL4	<b>0 445 110 259</b>	<b>0 986 435 126</b>	<b>F 00V C17 504</b>	
					4	DBJ,FL5, MPR	<b>0 445 110 297</b>	<b>0 986 435 150</b>	<b>F 00V C17 504</b>	
					4	DBJ,MPR	<b>0 445 110 297</b>	<b>0 986 435 150</b>	<b>F 00V C17 504</b>	
HDi [T9]	1,6	68	9HP <DV6DTED>	07.13→	4	DBJ	<b>0 445 110 340</b>	<b>0 986 435 203</b>	<b>F 00V C17 504</b>	

**308 SW**

1.5 BlueHdi [T9]	1,5	96	YHZ <DV5RC>	06.17→	4	DBJ	<b>0 445 110 749</b>		<b>F 00V C17 504</b>	
1.6 Blue HDi [T9]	1,6	73	BHY <DV6FD>	01.14→	4	DBJ	<b>0 445 110 565</b>		<b>F 00V C17 504</b>	
		85	BHX <DV6FC>	01.14→	4	DBJ	<b>0 445 110 565</b>		<b>F 00V C17 504</b>	
		88	BH... <DV6FC>	01.14→	4	DBJ	<b>0 445 110 565</b>		<b>F 00V C17 504</b>	
HDi [T7]	1,6	66	9HV <DV6TED4/FAP>	05.08-03.10	4	DBJ	<b>0 445 110 297</b>	<b>0 986 435 150</b>	<b>F 00V C17 504</b>	
			9HX <DV6ATED4>	05.08-03.10	4	DBJ	<b>0 445 110 311</b>	<b>0 986 435 146</b>	<b>F 00V C17 504</b>	





◀ PEUGEOT

1.6 HDi [T7]	1,6	68	9HJ <DV6DTE M>; 9HP <DV6DTE D>	06.10-01.14	4	DBJ	0 445 110 340	0 986 435 203	F 00V C17 504
		80	9H... <DV6TED4>	05.08-03.10	4	DBJ,EE2, MPR,NL4	0 445 110 259	0 986 435 126	F 00V C17 504
					4	DBJ,FL5, MPR	0 445 110 297	0 986 435 150	F 00V C17 504
					4	DBJ,MPR	0 445 110 297	0 986 435 150	F 00V C17 504
HDi [T9]	1,6	68	9HP <DV6DTE D>	01.14→	4	DBJ	0 445 110 340	0 986 435 203	F 00V C17 504
<b>406</b>									
2.0 HDi [D8]	2,0	80	RHZ <DW10ATE D>	10.98-03.99	4	DBJ	0 445 110 008	0 986 435 003	
HDi [D9]	2,0	66	RHY <DW10TE D>	04.99-06.04	4	BO,DBB, I2G	0 445 110 044	0 986 435 003	
					4	BO,DBB, KKK,KKY	0 445 110 076	0 986 435 077	
					4	BO,DBB, I1B	0 445 110 008	0 986 435 003	
		79/80	RHS <DW10ATE D/FAP>; RHZ <DW10ATE D>	04.99-06.04	4	DBB,I2G	0 445 110 044	0 986 435 003	
					4	DBB,KKX, KKY,KKZ	0 445 110 076	0 986 435 077	
					4	DBB,I1B	0 445 110 008	0 986 435 003	
2.2 HDi [D9]	2,2	98	4HX <DW12TE D4>	03.00-06.04	4	DBB	0 445 110 036	0 986 435 013	
								0 986 435 014	
								0 986 435 015	
<b>406 Break</b>									
2.0 HDi [D8]	2,0	80	RHZ <DW10ATE D>	10.98-03.99	4	DBJ	0 445 110 008	0 986 435 003	
HDi [D9]	2,0	66	RHY <DW10TE D>	04.99-06.04	4	BO,DBB, I2G	0 445 110 044	0 986 435 003	
					4	BO,DBB, KKK,KKY	0 445 110 076	0 986 435 077	
					4	BO,DBB, I1B	0 445 110 008	0 986 435 003	
		79/80	RHS <DW10ATE D/FAP>; RHZ <DW10ATE D>	04.99-06.04	4	DBB,I2G	0 445 110 044	0 986 435 003	
					4	DBB,KKX, KKY,KKZ	0 445 110 076	0 986 435 077	
					4	DBB,I1B	0 445 110 008	0 986 435 003	
2.2 HDi [D9]	2,2	98	4HX <DW12TE D4>	03.00-06.04	4	DBB	0 445 110 036	0 986 435 013	
								0 986 435 014	
								0 986 435 015	
<b>406 Coupé</b>									
2.2 HDi [D9]	2,2	98	4HX <DW12TE D4>	03.00-02.05	4	DBB	0 445 110 036	0 986 435 013	
								0 986 435 014	
								0 986 435 015	
<b>407</b>									
1.6 HDi [D2]	1,6	80	9H... <DV6TE D4>	05.04-02.11	4	DBJ,MPR	0 445 110 259	0 986 435 126	F 00V C17 504
			Org.-Nr. →10373	05.04-04.05	4	DBJ,MPR	0 445 110 188	0 986 435 090	
			Org.-Nr. 10374→11073	05.05-03.07	4	DBJ,MPR	0 445 110 259	0 986 435 126	
			Org.-Nr. 11074→	04.07-02.11	4	DBJ,MPR	0 445 110 297	0 986 435 150	
2.2 HDi [D2]	2,2	120-125	4H... <DW12BTE D4>	05.06-07.10	4	DBB	0 445 115 025	0 986 435 450	
<b>407 Coupé</b>									
3.0 HDi 24V [D2]	3,0	177	X8Z <DT20C>	07.09-12.11	6	DBJ	0 445 116 012	0 986 435 403	
<b>407 SW</b>									
1.6 HDi [D2]	1,6	80	9H... <DV6TE D4>	05.04-02.11	4	DBJ,MPR	0 445 110 259	0 986 435 126	F 00V C17 504
			Org.-Nr. →10373	05.04-04.05	4	DBJ,MPR	0 445 110 188	0 986 435 090	
			Org.-Nr. 10374→11073	05.05-03.07	4	DBJ,MPR	0 445 110 259	0 986 435 126	
			Org.-Nr. 11074→	04.07-02.11	4	DBJ,MPR	0 445 110 297	0 986 435 150	
2.2 HDi [D2]	2,2	120-125	4H... <DW12BTE D4>	09.06-07.10	4	DBB	0 445 115 025	0 986 435 450	
<b>508</b>									
1.6 BlueHDi [W2]	1,6	85	BHX <DV6FC>	10.14→	4	DBJ	0 445 110 565		F 00V C17 504
		88	BHZ <DV6FC>	10.14→	4	DBJ	0 445 110 565		F 00V C17 504
2.2 HDi [W2]	2,2	150	4HL <DW12C>	10.10→	4	DBJ	0 445 115 087	0 986 435 392	
								0 986 435 434	
<b>508 SW</b>									
1.6 BlueHDi [W2]	1,6	85	BHX <DV6FC>	10.14→	4	DBJ	0 445 110 565		F 00V C17 504





1.6 BlueHdi [W2]	1,6	88	BHZ <DV6FC>	10.14→	4	DBJ	0 445 110 565		F 00V C17 504
2.2 HDi [W2]	2,2	150	4HL <DW12C>	10.10→	4	DBJ	0 445 115 087	0 986 435 392	
								0 986 435 434	
<b>607</b>									
2.0 HDi [Z8]	2,0	79/80	RHS <DW10ATED/FAP>; RHZ <DW10ATED>	03.00-11.04	4	DBB	0 445 110 076	0 986 435 077	
HDi [Z9]	2,0	79	RHS <DW10ATED/FAP>	12.04-12.07	4	DBB	0 445 110 076	0 986 435 077	
2.2 HDi [Z8]	2,2	98	4HX <DW12TED4>	03.00-11.04	4	DBB	0 445 110 036	0 986 435 013	
								0 986 435 014	
								0 986 435 015	
HDi [Z9]	2,2	98	4HX <DW12TED4>	12.04-12.07	4	DBB	0 445 110 036	0 986 435 013	
								0 986 435 014	
								0 986 435 015	
		125	4H... <DW12BTED4>	05.06-04.09	4	DBB	0 445 115 025	0 986 435 450	
<b>806</b>									
2.0 HDi [U60]	2,0	80	RHZ <DW10ATED>	08.99-08.02	4	DBB, I2G	0 445 110 044	0 986 435 003	
						4 DBB, I1B	0 445 110 008	0 986 435 003	
		81	RHW <DW10ATED4/L4>	06.00-08.02	4	DBB	0 445 110 057	0 986 435 093	
<b>807</b>									
2.0 HDi [V2]	2,0	81	RH... <DW10ATED4/FAP>; RHW <DW10ATED4>	06.02-12.06	4	DBB	0 445 110 057	0 986 435 093	
2.2 HDi [V2]	2,2	94	4HW <DW12TED4/FAP>	06.02-07.06	4	DBB	0 445 110 036	0 986 435 013	
								0 986 435 014	
								0 986 435 015	
		120-125	4H... <DW12BTED4>	09.07-05.10	4	DBB	0 445 115 025	0 986 435 450	
<b>1007</b>									
1.6 HDi [A8]	1,6	80	9HZ <DV6TED4>	03.07-02.11	4	DBJ	0 445 110 297	0 986 435 150	F 00V C17 504
<b>2008</b>									
1.4 HDi [A94]	1,4	50	8H... <DV4C>	03.13→	4	DBJ	0 445 110 339	0 986 435 172	F 00V C17 504
1.6 BlueHdi [A94]	1,6	55/73	BHW <DV6FE>; BHY <DV6FD>	02.15→	4	DBJ	0 445 110 565		F 00V C17 504
HDi [A94]	1,6	68	9HP <DV6DTE>	03.13→	4	DBJ	0 445 110 340	0 986 435 203	F 00V C17 504
		85	BHX <DV6FC>	03.14→	4	DBJ	0 445 110 565		F 00V C17 504
		88	BHZ <DV6FC>	03.14→	4	DBJ	0 445 110 565		F 00V C17 504
<b>3008</b>									
1.5 BlueHdi [P84]	1,5	96	YHZ <DV5RC>	10.17→	4	DBJ	0 445 110 749		F 00V C17 504
1.6 Blue HDi [T8]	1,6	85	BHX <DV6FC>	03.14-12.16	4	DBJ	0 445 110 565		F 00V C17 504
		88	BHZ <DV6FC>	03.14-12.16	4	DBJ	0 445 110 565		F 00V C17 504
BlueHdi [P84]	1,6	85	BHX <DV6FC>	07.16→	4	DBJ	0 445 110 565		F 00V C17 504
		88	BHZ <DV6FC>	07.16→	4	DBJ	0 445 110 565		F 00V C17 504
		100	BHY <DV6FD>	07.16→	4	DBJ	0 445 110 565		F 00V C17 504
HDi [T8]	1,6	80	9HZ <DV6TED4/FAP>	05.09-12.16	4	DBJ	0 445 110 297	0 986 435 150	F 00V C17 504
<b>4007</b>									
2.2 HDi 4x4 [I3]	2,2	115	4HK <DW12ME5>; 4HN <DW12METED4/FAP>	09.07-11.12	4	DBB	0 445 115 025	0 986 435 450	
<b>5008</b>									
1.5 BlueHdi [P87]	1,5	96	YHZ <DV5RC>	10.17→	4	DBJ	0 445 110 749		F 00V C17 504
1.6 Blue HDi [P87]	1,6	73	BHY <DV6FD>	01.17→	4	DBJ	0 445 110 565		F 00V C17 504
		85	BHX <DV6FC>	01.17→	4	DBJ	0 445 110 565		F 00V C17 504
		88	BHZ <DV6FC>	01.17→	4	DBJ	0 445 110 565		F 00V C17 504
HDi [T8]	1,6	80	9HZ... <DV6TED4/FAP>	09.09-12.10	4	DBJ	0 445 110 297	0 986 435 150	F 00V C17 504
		85	BHX <DV6FC>	03.14→	4	DBJ	0 445 110 565		F 00V C17 504
		88	BHZ <DV6FC>	03.14→	4	DBJ	0 445 110 565		F 00V C17 504
<b>PIAGGIO</b>									
<b>Porter</b>									
1.2 D	1,2	47	P120	01.11→	2	DBJ	0 445 110 413		
<b>Porter Maxxi</b>									
1.2 D	1,2	47	P120	01.11→	2	DBJ	0 445 110 413		





**PORSCHE**

<b>Cayenne</b>										
3.0 Diesel [9PA]	3,0	176	M05.9D	09.08-09.10	6					<b>F 00V P01 004</b>
Diesel [92A]	3,0	155	MCR.CB <D51, D59>	06.11-08.14	6	DBJ	<b>0 445 117 021</b>	<b>0 986 435 413</b>		<b>F 00V P01 004</b>
		176	M05.9E	09.10-08.11	6	DBJ	<b>0 445 116 022</b>	<b>0 986 435 357</b>		<b>F 00V P01 004</b>
								<b>0 986 435 379</b>		
		180	MCR.CA <D43>	06.11-08.14	6	DBJ	<b>0 445 117 021</b>	<b>0 986 435 413</b>		<b>F 00V P01 004</b>
<b>Cayenne S</b>										
4.2 [92A]	4,1	283	MCU.DC <DD8>	09.14→	8	DBJ	<b>0 445 117 019</b>	<b>0 986 435 412</b>		
		4,2	281-285	MCU.DB	09.12-08.14	8	DBJ	<b>0 445 117 019</b>	<b>0 986 435 412</b>	
<b>Cayenne S4</b>										
3.0 Diesel [92A]	3,0	180	MCN.RB <D50>	09.11→	6	DBJ	<b>0 445 117 021</b>	<b>0 986 435 413</b>		<b>F 00V P01 004</b>
<b>Panamera</b>										
3.0 Diesel [970]	3,0	155/185	MCR.CB <D51, D59>; MCR.CC <D51, D59>	08.11-08.16	6	DBJ	<b>0 445 117 021</b>	<b>0 986 435 413</b>		
		221	MCW.JA <DJ5>	07.13-10.16	6	DBJ	<b>0 445 117 028</b>	<b>0 986 435 431</b>		
<b>Panamera Sport Turismo 4S</b>										
4.0 Diesel [971]	4,0	310	MDB.U... <DJ7>	03.17→	8	DBJ	<b>0 445 118 006</b>			<b>F 00V P01 009</b>
<b>Panamera 4S</b>										
4.0 Diesel [971]	4,0	310	MDB.U... <DJ7>	11.16→	8	DBJ	<b>0 445 118 006</b>			<b>F 00V P01 009</b>

**RENAULT**

<b>Alaskan</b>										
2.3 DCi 4WD [U3]	2,3	120/140	M9T 260	11.17→	4					<b>1 987 972 077</b>
<b>Avantime</b>										
2.2 DCi [XEO]	2,2	110	G9T 712	12.01-11.02	4	DBB	<b>0 445 110 063</b>	<b>0 986 435 075</b>		<b>1 987 972 078</b>
				12.01-12.03	4	DBB	<b>0 445 110 063</b>	<b>0 986 435 075</b>		<b>1 987 972 078</b>
				12.02-12.03	4	DBB	<b>0 445 110 084</b>	<b>0 986 435 173</b>		<b>1 987 972 078</b>
<b>Captur</b>										
1.5 dCi [J5]	1,5	66	K9K 62...	03.15→	4	DBB	<b>0 445 110 652</b>			<b>1 987 972 077</b>
			K9K 608	01.13→	4	DBB	<b>0 445 110 485</b>	<b>0 986 435 240</b>		<b>1 987 972 077</b>
			K9K 609	01.13→	4	DBB	<b>0 445 110 485</b>	<b>0 986 435 240</b>		<b>1 987 972 077</b>
			81	K9K 646	02.15→	4				<b>1 987 972 077</b>
<b>Clio II</b>										
1.5 dCi [BB/CB/SB]	1,5	47/48/60/62	K9K 700; K9K 702; K9K 704; K9K 710; K9K 716; K9K 718; K9K 740	06.01-12.15	4					<b>1 987 972 077</b>
<b>Clio III</b>										
1.5 dCi [BR/CR]	1,5	50/55/63/65/78	K9K 750; K9K 752; K9K 760; K9K 762; K9K 764; K9K 766; K9K 768; K9K 770; K9K 772	06.05-12.15	4					<b>1 987 972 077</b>
<b>Clio III Grandtour</b>										
1.5 dCi [KR]	1,5	50/55/63/65/78	K9K 764; K9K 766; K9K 768; K9K 770; K9K 772	08.07-12.15	4					<b>1 987 972 077</b>
<b>Clio IV</b>										
1.5 dCi [BH]	1,5	55	K9K 612	05.12→	4	DBB	<b>0 445 110 485</b>	<b>0 986 435 240</b>		<b>1 987 972 077</b>
		63	K9K 830	05.12→	4					<b>1 987 972 077</b>
		66	K9K 60...	05.12→	4	DBB	<b>0 445 110 485</b>	<b>0 986 435 240</b>		<b>1 987 972 077</b>
			K9K 62...	01.16→	4	DBB	<b>0 445 110 652</b>			<b>1 987 972 077</b>
		81	K9K 646	09.16→	4				<b>1 987 972 077</b>	
<b>Clio IV Grandtour</b>										
1.5 dCi [KH]	1,5	55	K9K 612	11.12→	4	DBB	<b>0 445 110 485</b>	<b>0 986 435 240</b>		<b>1 987 972 077</b>
			K9K 628	01.16→	4	DBB	<b>0 445 110 652</b>			<b>1 987 972 077</b>
		66	K9K 60...	11.12→	4	DBB	<b>0 445 110 485</b>	<b>0 986 435 240</b>		<b>1 987 972 077</b>
			K9K 62...	01.16→	4	DBB	<b>0 445 110 652</b>			<b>1 987 972 077</b>
		81	K9K 646	09.16→	4				<b>1 987 972 077</b>	
<b>Duster</b>										
1.5 dCi [HS]	1,5	66	K9K 612	09.13→	4	DBB	<b>0 445 110 485</b>	<b>0 986 435 240</b>		<b>1 987 972 077</b>
dCi, dCi 4x4 [HS]	1,5	80	K9K 858	09.13→	4					<b>1 987 972 077</b>









◀ RENAULT

Koleos										
1.6 dCi [HC]	1,6	96	R9M 4...	09.17→	4	DBB	0 445 110 546	0 986 435 273		1 987 972 077
2.0 dCi [HC]	2,0	128	M9R 86...; M9R 868	09.17→	4					1 987 972 077
dCi [HY]	2,0	127	M9R 86...	09.13-12.16	4	DBB	0 445 115 084	0 986 435 435		1 987 972 077
dCi, dCi 4x4 [HY]	2,0	110	M9R 832	09.08-12.16	4	DBB	0 445 115 007	0 986 435 350		1 987 972 077
			M9R 833	09.08-12.16	4	DBB	0 445 115 007	0 986 435 350		1 987 972 077
dCi 4x4 [HY]	2,0	110	M9R 835	09.08-12.16	4	DBB	0 445 115 007	0 986 435 350		
		127	M9R 830	09.08-12.16	4	DBB	0 445 115 007	0 986 435 350		1 987 972 077
Laguna I										
1.9 DCI [B56]	1,9	80	F9Q 718	09.99-02.01	4	BO,DBB	0 445 110 146	0 986 435 007	BO	1 987 972 077
Laguna I Grandtour										
1.9 DCI [K56]	1,9	80	F9Q 718	09.99-02.01	4	BO,DBB	0 445 110 146	0 986 435 007	BO	1 987 972 077
Laguna II										
1.9 DCI [BG.]	1,9	68	F9Q 664	01.05-12.06	4	DBB	0 445 110 178			1 987 972 077
		74	F9Q 752	03.01-04.03	4	DBB	0 445 110 146	0 986 435 007		1 987 972 077
				03.01-09.07	4	DBB	0 445 110 146	0 986 435 007		1 987 972 077
				05.03-09.07	4	DBB	0 445 110 110	0 986 435 080		1 987 972 077
			F9Q 754	03.01-08.02	4	DBB	0 445 110 146	0 986 435 007		1 987 972 077
				03.01-09.07	4	DBB	0 445 110 146	0 986 435 007		1 987 972 077
				09.02-09.07	4	DBB	0 445 110 110	0 986 435 080		1 987 972 077
	81		F9Q 670	09.04-09.07	4	DBB	0 445 110 110	0 986 435 080		1 987 972 077
			F9Q 674	01.05-09.07	4	DBB	0 445 110 110	0 986 435 080		1 987 972 077
	88		F9Q 650	05.02-09.07	4	DBB	0 445 110 127			1 987 972 077
			F9Q 750	03.01-04.03	4	DBB	0 445 110 146	0 986 435 007		1 987 972 077
				03.01-09.07	4	DBB	0 445 110 146	0 986 435 007		1 987 972 077
				05.03-09.07	4	DBB	0 445 110 110	0 986 435 080		1 987 972 077
	96		F9Q 758	01.05-09.07	4	DBB	0 445 110 230	0 986 435 124		1 987 972 077
			F9Q 759	01.05-09.07	4	DBB	0 445 110 230	0 986 435 124		1 987 972 077
2.0 DCI [BG.]	2,0	110/127	M9R 740; M9R 760	09.04-09.07	4	DBB	0 445 115 007	0 986 435 350		
2.2 DCI [BG.]	2,2	102	G9T 605	07.05-09.07	4	DBB	0 445 110 261			
		110	G9T 700	03.01-09.07	4	DBB	0 445 110 084	0 986 435 173		
			G9T 702	03.01-09.07	4	DBB	0 445 110 084	0 986 435 173		1 987 972 078
			G9T 703	03.01-09.07	4	DBB	0 445 110 084	0 986 435 173		1 987 972 078
			G9T 706	03.01-09.07	4	DBB	0 445 110 084	0 986 435 173		1 987 972 078
			G9T 707	03.01-09.07	4	DBB	0 445 110 084	0 986 435 173		1 987 972 078
Laguna II Grandtour										
1.9 DCI [KG.]	1,9	68	F9Q 664	01.05-12.06	4	DBB	0 445 110 178			1 987 972 077
		74-79	F9Q 752	03.01-04.03	4	DBB	0 445 110 146	0 986 435 007		1 987 972 077
				03.01-12.05	4	DBB	0 445 110 146	0 986 435 007		1 987 972 077
				05.03-12.05	4	DBB	0 445 110 110	0 986 435 080		1 987 972 077
			F9Q 754	03.01-08.02	4	DBB	0 445 110 146	0 986 435 007		1 987 972 077
				03.01-12.05	4	DBB	0 445 110 146	0 986 435 007		1 987 972 077
				09.02-12.05	4	DBB	0 445 110 110	0 986 435 080		1 987 972 077
	81		F9Q 670	01.05-09.07	4	DBB	0 445 110 110	0 986 435 080		1 987 972 077
			F9Q 674	01.05-09.07	4	DBB	0 445 110 110	0 986 435 080		1 987 972 077
	88		F9Q 650	05.02-09.07	4	DBB	0 445 110 127			1 987 972 077
			F9Q 750	03.01-04.03	4	DBB	0 445 110 146	0 986 435 007		1 987 972 077
				03.01-12.05	4	DBB	0 445 110 146	0 986 435 007		1 987 972 077
				05.03-12.05	4	DBB	0 445 110 110	0 986 435 080		1 987 972 077
	96		F9Q 758	04.04-09.07	4	DBB	0 445 110 230	0 986 435 124		1 987 972 077
			F9Q 759	04.04-09.07	4	DBB	0 445 110 230	0 986 435 124		1 987 972 077
2.0 DCI [KG.]	2,0	110/127	M9R 740; M9R 760	09.04-09.07	4	DBB	0 445 115 007	0 986 435 350		
2.2 DCI [KG.]	2,2	102	G9T 605	07.05-09.07	4	DBB	0 445 110 261			
		110	G9T 700	03.01-09.07	4	DBB	0 445 110 084	0 986 435 173		
			G9T 702	03.01-09.07	4	DBB	0 445 110 084	0 986 435 173		1 987 972 078
			G9T 703	03.01-09.07	4	DBB	0 445 110 084	0 986 435 173		1 987 972 078
			G9T 706	03.01-09.07	4	DBB	0 445 110 084	0 986 435 173		1 987 972 078
			G9T 707	03.01-09.07	4	DBB	0 445 110 084	0 986 435 173		1 987 972 078
Laguna III										
1.5 dCi [BT]	1,5	47-81	K9K...; K9K 780	07.07-12.16	4					1 987 972 077
2.0 dCi [BT]	2,0	96/110	M9R 802	10.07-12.16	4	DBB	0 445 115 007	0 986 435 350		1 987 972 077
			M9R 858	12.11-12.16	4	DBB	0 445 115 084	0 986 435 435		1 987 972 077
		110	M9R 742	10.07-12.16	4	DBB	0 445 115 007	0 986 435 350		1 987 972 077





2.0 dCi [BT]	2,0	110	M9R 805	10.07-12.16	4	DBB	0 445 115 007	0 986 435 350	1 987 972 077		
		110/131	M9R 754; M9R 816	02.08-12.16	4	DBB	0 445 115 007	0 986 435 350	1 987 972 077		
		127	M9R 800	10.07-12.16	4	DBB	0 445 115 007	0 986 435 350	1 987 972 077		
			M9R 857	12.11-12.16	4	DBB	0 445 115 084	0 986 435 435	1 987 972 077		
		131	M9R 828	01.13-12.16	4	DBB	0 445 115 084	0 986 435 435	1 987 972 077		
3.0 dCi [BT]	3,0	173	V9X 891	02.08→	6				1 987 972 077		
<b>Laguna III Coupé</b>											
1.5 dCi [DT]	1,5	81	K9K 846	01.13-12.16	4				1 987 972 077		
2.0 dCi [DT]	2,0	110	M9R 742	02.08-12.16	4	DBB	0 445 115 007	0 986 435 350	1 987 972 077		
			M9R 802	02.08-12.16	4	DBB	0 445 115 007	0 986 435 350	1 987 972 077		
			M9R 805	02.08-12.16	4	DBB	0 445 115 007	0 986 435 350	1 987 972 077		
		127	M9R 858	12.11-12.16	4	DBB	0 445 115 084	0 986 435 435	1 987 972 077		
			M9R 800	02.08-12.16	4	DBB	0 445 115 007	0 986 435 350	1 987 972 077		
			M9R 857	12.11-12.16	4	DBB	0 445 115 084	0 986 435 435	1 987 972 077		
131	M9R 816	02.08-12.16	4	DBB	0 445 115 007	0 986 435 350	1 987 972 077				
3.0 dCi [DT]	3,0	173	V9X 791; V9X 891	02.08-12.16	6				1 987 972 077		
<b>Laguna III Grandtour</b>											
1.5 dCi [KT]	1,5	81	K9K...; K9K 780	07.07-12.16	4				1 987 972 077		
2.0 dCi [KT]	2,0	96/110	M9R 802	10.07-12.16	4	DBB	0 445 115 007	0 986 435 350	1 987 972 077		
			M9R 858	12.11-12.16	4	DBB	0 445 115 084	0 986 435 435	1 987 972 077		
		110	M9R 742	10.07-12.16	4	DBB	0 445 115 007	0 986 435 350	1 987 972 077		
			M9R 805	10.07-12.16	4	DBB	0 445 115 007	0 986 435 350	1 987 972 077		
		127	M9R 8...	12.11-12.16	4	DBB	0 445 115 084	0 986 435 435	1 987 972 077		
			M9R 800	10.07-12.16	4	DBB	0 445 115 007	0 986 435 350	1 987 972 077		
131	M9R 816	02.08-12.16	4	DBB	0 445 115 007	0 986 435 350	1 987 972 077				
3.0 dCi [KT]	3,0	173	V9X 891	02.08-12.16	6				1 987 972 077		
<b>Latitude</b>											
1.5 dCi [L7]	1,5	81	K9K 782	09.10-12.16	4				1 987 972 077		
2.0 dCi [L7]	2,0	96	M9R 756	08.10-12.17	4	DBB	0 445 115 007	0 986 435 350	1 987 972 077		
			M9R 8...; M9R 846	09.10-12.16	4	DBB	0 445 115 084	0 986 435 435	1 987 972 077		
3.0 dCi [L7]	3,0	177	V9X 891	09.10-12.16	6				1 987 972 077		
<b>Logan</b>											
1.5 dCi [LS]	1,5	48/50/63	K9K 790; K9K 792; K9K 796	06.05-12.16	4				1 987 972 077		
<b>Logan MCV</b>											
1.5 dCi [KS/FS]	1,5	50/63	K9K 792; K9K 796	01.07-12.13	4				1 987 972 077		
dCi [K8]	1,5	55/66	K9K 612	09.15→	4	DBB	0 445 110 485	0 986 435 240	1 987 972 077		
<b>Megane I</b>											
1.9 DCI [X64]	1,9	72-75	F9Q 732	03.99-08.02	4	DBB	0 445 110 146	0 986 435 007	1 987 972 077		
				03.99-10.02	4	DBB	0 445 110 146	0 986 435 007	1 987 972 077		
				09.02-10.02	4	DBB	0 445 110 110	0 986 435 080	1 987 972 077		
		75	F9Q 733	05.00-10.02	4	BO,DBB	0 445 110 146	0 986 435 007	BO	1 987 972 077	
				F9Q 738	03.99-10.02	4	BO,DBB	0 445 110 146	0 986 435 007	BO	1 987 972 077
		75	F9Q 738	01.01-08.02	4	DBB	0 445 110 146	0 986 435 007	1 987 972 077		
				01.01-10.02	4	DBB	0 445 110 146	0 986 435 007	1 987 972 077		
				09.02-10.02	4	DBB	0 445 110 110	0 986 435 080	1 987 972 077		
<b>Megane I Classic</b>											
1.9 DCI [X64]	1,9	72-75	F9Q 732	04.99-08.02	4	DBB	0 445 110 146	0 986 435 007	1 987 972 077		
				04.99-09.03	4	DBB	0 445 110 146	0 986 435 007	1 987 972 077		
				09.02-09.03	4	DBB	0 445 110 110	0 986 435 080	1 987 972 077		
		75	F9Q 733	04.99-09.03	4	BO,DBB	0 445 110 146	0 986 435 007	BO	1 987 972 077	
				F9Q 738	05.00-09.03	4	DBB	0 445 110 109	0 986 435 100	BO	1 987 972 077
<b>Megane I Coupé</b>											
1.9 DCI [X64]	1,9	72-75	F9Q 732	03.99-08.02	4	DBB	0 445 110 146	0 986 435 007	1 987 972 077		
				03.99-10.02	4	DBB	0 445 110 146	0 986 435 007	1 987 972 077		
				09.02-10.02	4	DBB	0 445 110 110	0 986 435 080	1 987 972 077		
		75	F9Q 733	05.00-10.02	4	BO,DBB	0 445 110 146	0 986 435 007	BO	1 987 972 077	
<b>Megane I Grandtour</b>											
1.9 DCI [X64]	1,9	72-75	F9Q 732	03.99-08.02	4	DBB	0 445 110 146	0 986 435 007	1 987 972 077		
				03.99-09.03	4	DBB	0 445 110 146	0 986 435 007	1 987 972 077		
				09.02-09.03	4	DBB	0 445 110 110	0 986 435 080	1 987 972 077		
		75	F9Q 733; F9Q 738	03.99-09.03	4	BO,DBB	0 445 110 146	0 986 435 007	BO	1 987 972 077	





◀ RENAULT

Megane II									
1.5 dCi [LM]	1,5	60/63/76/78	K9K 722; K9K 724; K9K 728; K9K 729; K9K 732; K9K 734	11.02-10.09	4				1 987 972 077
1.9 dCi [LM]	1,9	68	F9Q 808	10.03-10.09	4	DBB	0 445 110 178		1 987 972 077
		88	F9Q 800	10.03-10.09	4	DBB	0 445 110 110	0 986 435 080	1 987 972 077
		96	F9Q 803; F9Q 804	09.04-10.09	4	DBB	0 445 110 230	0 986 435 124	1 987 972 077
2.0 dCi [LM]	2,0	110	M9R 700	09.04-10.09	4	DBB	0 445 115 007	0 986 435 350	1 987 972 077
Megane II Cabrio									
1.5 dCi [EM]	1,5	76/78	K9K 732; K9K 734	12.05-03.10	4				1 987 972 077
1.9 dCi [EM]	1,9	88	F9Q 800	10.03-03.10	4	DBB	0 445 110 110	0 986 435 080	1 987 972 077
		96	F9Q 803; F9Q 804; F9Q 814	05.04-03.10	4	DBB	0 445 110 230	0 986 435 124	1 987 972 077
2.0 dCi [EM]	2,0	110	M9R 700	09.04-03.10	4	DBB	0 445 115 007	0 986 435 350	1 987 972 077
			M9R 722	09.04-03.10	4	DBB	0 445 115 007	0 986 435 350	1 987 972 077
Megane II Grandtour									
1.5 dCi [KM.]	1,5	63/76/78	K9K 724; K9K 732; K9K 734	10.03-05.09	4				1 987 972 077
1.9 dCi [KM.]	1,9	68	F9Q 808	10.03-05.09	4	DBB	0 445 110 178		1 987 972 077
		88	F9Q 800	10.03-05.09	4	DBB	0 445 110 110	0 986 435 080	1 987 972 077
		96	F9Q 803; F9Q 804	09.04-05.09	4	DBB	0 445 110 230	0 986 435 124	1 987 972 077
2.0 dCi [KM.]	2,0	110	M9R 700; M9R 722	09.04-05.09	4	DBB	0 445 115 007	0 986 435 350	
Megane II Hatchback									
1.5 dCi [BM./CM./GM./SM.]	1,5	63/78	K9K 724; K9K 732	10.04-10.08	4				1 987 972 077
1.9 dCi [BM./CM./GM./SM.]	1,9	68	F9Q 808	11.02-10.08	4	DBB	0 445 110 178		1 987 972 077
		88	F9Q 800	11.02-10.08	4	DBB	0 445 110 110	0 986 435 080	1 987 972 077
		96	F9Q 803	05.05-10.08	4	DBB	0 445 110 230	0 986 435 124	1 987 972 077
			F9Q 804	09.04-10.08	4	DBB	0 445 110 230	0 986 435 124	1 987 972 077
			F9Q 816	05.05-10.08	4	DBB	0 445 110 280	0 986 435 192	1 987 972 077
2.0 dCi [BM./CM./GM./SM.]	2,0	110	M9R 700; M9R 722	09.04-10.08	4	DBB	0 445 115 007	0 986 435 350	
dCi Sport [BM./CM./GM./SM.]	2,0	127	M9R 724	04.07-10.08	4	DBB	0 445 115 007	0 986 435 350	1 987 972 077
Megane III CC									
1.5 dCi [EZ]	1,5	81	K9K 636; K9K 836; K9K 837	10.10-12.16	4				1 987 972 077
1.6 dCi [EZ]	1,6	96	R9M 402	11.12-12.16	4	DBB	0 445 110 414	0 986 435 211	1 987 972 077
1.9 dCi [EZ]	1,9	96	F9Q 870	10.10-12.16	4	DBB	0 445 110 328	0 986 435 188	1 987 972 077
2.0 dCi [EZ]	2,0	118	M9R 610	10.10-12.16	4	DBB	0 445 115 084	0 986 435 435	1 987 972 077
Megane III Coupé									
1.5 dCi [DZ]	1,5	66/70/78/81	K9K 8...; K9K 636; K9K 830; K9K 832; K9K 834; K9K 836	01.09-12.16	4				1 987 972 077
1.6 dCi [DZ]	1,6	96	R9M 402	01.12-12.16	4	DBB	0 445 110 414	0 986 435 211	1 987 972 077
1.9 dCi [DZ]	1,9	96	F9Q 870	01.09-12.16	4	DBB	0 445 110 328	0 986 435 188	1 987 972 077
			F9Q 872	01.09-12.16	4	DBB	0 445 110 328	0 986 435 188	1 987 972 077
2.0 dCi [DZ]	2,0	110/118/120	M9R 610; M9R 615	01.09-12.16	4	DBB	0 445 115 084	0 986 435 435	1 987 972 077
Megane III Grandtour									
1.5 dCi [KZ]	1,5	66/70/78/81	K9K 8...; K9K 636; K9K 830; K9K 832; K9K 834; K9K 836	06.09-12.15	4				1 987 972 077
1.6 dCi [KZ]	1,6	96	R9M 402	01.12-12.15	4	DBB	0 445 110 414	0 986 435 211	1 987 972 077
1.9 dCi [KZ]	1,9	96	F9Q 870	06.09-12.15	4	DBB	0 445 110 328	0 986 435 188	1 987 972 077
			F9Q 872	06.09-12.15	4	DBB	0 445 110 328	0 986 435 188	1 987 972 077
2.0 dCi [KZ]	2,0	110/118/120	M9R 610; M9R 615	06.09-12.15	4	DBB	0 445 115 084	0 986 435 435	1 987 972 077
Megane III Hatchback									
1.5 dCi [BZ]	1,5	66/70/78/81	K9K 8...; K9K 636; K9K 830; K9K 832; K9K 834; K9K 836	11.08-12.16	4				1 987 972 077
1.6 dCi [BZ]	1,6	96	R9M 402	01.12-12.16	4	DBB	0 445 110 414	0 986 435 211	1 987 972 077
1.9 dCi [BZ]	1,9	96	F9Q 870	11.08-12.16	4	DBB	0 445 110 328	0 986 435 188	1 987 972 077
			F9Q 872	11.08-12.16	4	DBB	0 445 110 328	0 986 435 188	1 987 972 077
2.0 dCi [BZ]	2,0	110/118/120	M9R 610; M9R 615	11.08-12.16	4	DBB	0 445 115 084	0 986 435 435	1 987 972 077





Megane IV										
1.5 dCi [B9]	1,5	66/81	K9K 6...	12.15→	4					1987 972 077
1.6 [B9]	1,6	121	R9M 452	12.15→	4	DBB	0 445 110 569			1987 972 077
dCi [B9]	1,6	96	R9M 4...	12.15→	4	DBB	0 445 110 546	0 986 435 273		1987 972 077
Megane IV Grand Coupé										
1.5 dCi [LV]	1,5	66/81	K9K...; K9K 6...	02.17→	4					1987 972 077
1.6 dCi [LV]	1,6	96	R9M 4...	02.17→	4	DBB	0 445 110 546	0 986 435 273		1987 972 077
Megane IV Grandtour										
1.5 dCi [B9]	1,5	66/81	K9K 6...	04.16→	4					1987 972 077
1.6 dCi [B9]	1,6	96	R9M 4...	04.16→	4	DBB	0 445 110 546	0 986 435 273		1987 972 077
		121	R9M 452	04.16→	4	DBB	0 445 110 569			1987 972 077
Modus										
1.5 dCi [FP/JP]	1,5	50/55/63/65/78	K9K 752; K9K 760; K9K 762; K9K 764; K9K 766; K9K 768; K9K 770; K9K 772	09.04-12.15	4					1987 972 077
Sandero										
1.5 dCi [BS]	1,5	50	K9K 79...	12.09→	4					1987 972 077
Scenic I										
1.9 dCi [JA]	1,9	75	F9Q 738	09.00-04.03	4	DBB	0 445 110 109	0 986 435 100	BO	1987 972 077
DCI, DCI RX4 [JA]	1,9	75	F9Q 732	03.99-08.02	4	DBB	0 445 110 146	0 986 435 007		1987 972 077
				03.99-04.03	4	DBB	0 445 110 146	0 986 435 007		1987 972 077
				09.02-04.03	4	DBB	0 445 110 110	0 986 435 080		1987 972 077
			F9Q 733	10.99-04.03	4	DBB	0 445 110 110	0 986 435 080	BO	1987 972 077
			F9Q 740	06.00-04.03	4	DBB	0 445 110 146	0 986 435 007		1987 972 077
			F9Q 746	02.01-04.03	4	DBB	0 445 110 146	0 986 435 007		1987 972 077
			F9Q 748	02.01-04.03	4	DBB	0 445 110 146	0 986 435 007		1987 972 077
			F9Q 796	06.97-04.03	4	DBB	0 445 110 160	0 986 435 098		1987 972 077
Scenic II										
1.5 dCi [JM]	1,5	74-78	K9K 728; K9K 732	05.03-04.09	4					1987 972 077
1.9 dCi [JM]	1,9	81/96	F9Q 804	05.03-11.08	4	DBB	0 445 110 230	0 986 435 124		1987 972 077
				05.03-04.09	4	DBB	0 445 110 230	0 986 435 124		1987 972 077
		88	F9Q 812	05.03-04.09	4	DBB	0 445 110 110	0 986 435 080		1987 972 077
		96	F9Q 803	05.05-04.09	4	DBB	0 445 110 230	0 986 435 124		1987 972 077
			F9Q 816	05.05-11.08	4	DBB	0 445 110 280	0 986 435 192		1987 972 077
			F9Q 818	05.05-11.08	4	DBB	0 445 110 280	0 986 435 192		1987 972 077
2.0 dCi [JM]	2,0	110	M9R 700; M9R 721	09.04-04.09	4	DBB	0 445 115 007	0 986 435 350		1987 972 077
			M9R 722	09.04-04.09	4	DBB	0 445 115 007	0 986 435 350		1987 972 077
Scenic III										
1.5 dCi [JZ]	1,5	63/70/77/81	K9K 83...; K9K 636; K9K 830; K9K 832; K9K 846	05.09-12.16	4					1987 972 077
1.6 dCi [JZ]	1,6	96	R9M 402	03.11-12.16	4	DBB	0 445 110 414	0 986 435 211		1987 972 077
			R9M 414	02.16-12.16	4	DBB	0 445 110 546	0 986 435 273		1987 972 077
1.9 dCi [JZ]	1,9	96	F9Q 870	05.09-12.16	4	DBB	0 445 110 328	0 986 435 188		1987 972 077
			F9Q 872	05.09-12.16	4	DBB	0 445 110 328	0 986 435 188		1987 972 077
2.0 dCi [JZ]	2,0	110	M9R 615	05.09-12.16	4	DBB	0 445 115 084	0 986 435 435		1987 972 077
		118	M9R 610	05.09-12.16	4	DBB	0 445 115 084	0 986 435 435		1987 972 077
Scenic IV										
1.5 dCi [J9]	1,5	70/81	K9K 64...	11.16→	4					1987 972 077
1.6 dCi [J9]	1,6	96	R9M 409	11.16→	4	DBB	0 445 110 546	0 986 435 273		1987 972 077
		118	R9M 452	11.16→	4	DBB	0 445 110 569			1987 972 077
Symbol										
1.5 dCi [L8]	1,5	55/66	K9K 612	03.13→	4	DBB	0 445 110 485	0 986 435 240		1987 972 077
Talisman										
1.5 dCi [LP]	1,5	81	K9K 64...	12.15→	4					1987 972 077
1.6 dCi [LP]	1,6	96	R9M 409	12.15→	4	DBB	0 445 110 546	0 986 435 273		1987 972 077
		118	R9M 452	12.15→	4	DBB	0 445 110 569			1987 972 077
Talisman Grandtour										
1.5 dCi [KP]	1,5	81	K9K 64...	03.16→	4					1987 972 077
1.6 dCi [KP]	1,6	96	R9M 409	03.16→	4	DBB	0 445 110 546	0 986 435 273		1987 972 077
		118	R9M 452	03.16→	4	DBB	0 445 110 569			1987 972 077
Thalia										
1.5 dCi [LB]	1,5	48/50/59/60	K9K 700; K9K 702; K9K 706; K9K 714	06.01-10.07	4					1987 972 077





◀ RENAULT

<b>1.5 dCi [LU]</b>	1,5	47/48/62	K9K 700; K9K 718; K9K 740	10.08-06.14	4					<b>1 987 972 077</b>
<b>Twingo II</b>										
<b>1.5 dCi [CN/GN]</b>	1,5	47/55/62/63	K9K 718; K9K 740; K9K 820	04.07-12.15	4					<b>1 987 972 077</b>
<b>Vel Satis</b>										
<b>2.0 DCI [BJ]</b>	2,0	110/127	M9R 760	08.05-12.09	4	DBB	<b>0 445 115 007</b>	<b>0 986 435 350</b>		<b>1 987 972 077</b>
<b>2.2 DCI [BJ]</b>	2,2	102	G9T 607	07.05-12.09	4	DBB	<b>0 445 110 261</b>			<b>1 987 972 078</b>
		102/110	G9T 600; G9T 606	09.02-12.09	4					<b>1 987 972 078</b>
		110	G9T 702	04.02-12.09	4	DBB	<b>0 445 110 084</b>	<b>0 986 435 173</b>		<b>1 987 972 078</b>
			G9T 703	04.02-12.09	4	DBB	<b>0 445 110 084</b>	<b>0 986 435 173</b>		<b>1 987 972 078</b>

**ROVER**

<b>75</b>										
<b>2.0 CDT, CDTi</b>	2,0	85/96	20 4D 2 <M 47 D 20>	01.99-05.05	4	DBJ	<b>0 445 110 030</b>	<b>0 986 435 011</b>		
<b>75 Tourer</b>										
<b>2.0 CDT, CDTi</b>	2,0	85/96	20 4D 2 <M 47 D 20>	01.01-05.05	4	DBJ	<b>0 445 110 030</b>	<b>0 986 435 011</b>		

**SAAB (SAAB AUTOMOBILE AB)**

<b>9-3</b>										
<b>1.9 TiD [9440]</b>	1,9	88	Z 19 DT	09.04-12.10	4					<b>F 00V C17 504</b>
			Fg.-Nr. →71019398 →76004481	09.04-12.10	4	DBB	<b>0 445 110 165</b>	<b>0 986 435 103</b>		
			Fg.-Nr. 71100001 → 76100001 →	09.04-12.10	4	DBJ	<b>0 445 110 276</b>	<b>0 986 435 148</b>		
		110	Z 19 DTH	09.04-09.10	4					<b>F 00V C17 504</b>
			Fg.-Nr. →71019398 →76004481	09.04-09.10	4	DBB	<b>0 445 110 159</b>	<b>0 986 435 088</b>		
			Fg.-Nr. 71100001 → 76100001 →	09.04-09.10	4	DBB	<b>0 445 110 243</b>	<b>0 986 435 104</b>		
<b>TTiD [9440]</b>	1,9	96	A19DTR (130)	09.10-06.12	4	DBJ	<b>0 445 110 299</b>	<b>0 986 435 230</b>		<b>F 00V C17 504</b>
		118	A19DTR (160)	09.10-06.12	4	DBJ	<b>0 445 110 299</b>	<b>0 986 435 230</b>		<b>F 00V C17 504</b>
		132	Z 19 DTR	02.08-02.11	4	DBJ	<b>0 445 110 299</b>	<b>0 986 435 230</b>		<b>F 00V C17 504</b>
<b>9-3 Cabriolet</b>										
<b>1.9 TiD [9440]</b>	1,9	110	Z 19 DTH	01.06-09.10	4					<b>F 00V C17 504</b>
			Fg.-Nr. →71019398 →76004481	01.06-09.10	4	DBB	<b>0 445 110 159</b>	<b>0 986 435 088</b>		
			Fg.-Nr. 71100001 → 76100001 →	01.06-09.10	4	DBB	<b>0 445 110 243</b>	<b>0 986 435 104</b>		
<b>TTiD [9440]</b>	1,9	118/132	A19DTR (160); Z 19 DTR	02.08-06.12	4	DBJ	<b>0 445 110 299</b>	<b>0 986 435 230</b>		<b>F 00V C17 504</b>
<b>9-3 Kombi</b>										
<b>1.9 TiD [9440]</b>	1,9	88	Z 19 DT	03.05-09.10	4					<b>F 00V C17 504</b>
			Fg.-Nr. →71019398 →76004481	03.05-09.10	4	DBB	<b>0 445 110 165</b>	<b>0 986 435 103</b>		
			Fg.-Nr. 71100001 → 76100001 →	03.05-09.10	4	DBJ	<b>0 445 110 276</b>	<b>0 986 435 148</b>		
		110	Z 19 DTH	03.05-09.10	4					<b>F 00V C17 504</b>
			Fg.-Nr. →71019398 →76004481	03.05-09.10	4	DBB	<b>0 445 110 159</b>	<b>0 986 435 088</b>		
			Fg.-Nr. 71100001 → 76100001 →	03.05-09.10	4	DBB	<b>0 445 110 243</b>	<b>0 986 435 104</b>		
<b>TTiD [9440]</b>	1,9	96	A19DTR (130)	09.10-06.12	4	DBJ	<b>0 445 110 299</b>	<b>0 986 435 230</b>		<b>F 00V C17 504</b>
		118	A19DTR (160)	09.10-06.12	4	DBJ	<b>0 445 110 299</b>	<b>0 986 435 230</b>		<b>F 00V C17 504</b>
		132	Z 19 DTR	02.08-02.11	4	DBJ	<b>0 445 110 299</b>	<b>0 986 435 230</b>		<b>F 00V C17 504</b>
<b>9-3X</b>										
<b>1.9 TTiD [9440]</b>	1,9	132	Z 19 DTR	03.10-06.12	4	DBJ	<b>0 445 110 299</b>	<b>0 986 435 230</b>		<b>F 00V C17 504</b>
<b>9-5</b>										
<b>1.9 TiD [9600]</b>	1,9	110	Z 19 DTH	09.05-02.10	4	DBB	<b>0 445 110 243</b>	<b>0 986 435 104</b>		<b>F 00V C17 504</b>
<b>2.0 TiD4 [650]</b>	2,0	118	A 20 DTH	03.10-06.12	4	DBB	<b>0 445 110 327</b>	<b>0 986 435 201</b>		<b>F 00V C17 504</b>
<b>TTiD4, TTiD4 XWD [650]</b>	2,0	140	A 20 DTR	03.10-06.12	4	DBB	<b>0 445 117 018</b>	<b>0 986 435 427</b>		<b>F 00V C17 504</b>
<b>9-5 Kombi</b>										
<b>1.9 TiD [9600]</b>	1,9	110/129	Z 19 DTH	01.06-02.10	4	DBB	<b>0 445 110 243</b>	<b>0 986 435 104</b>		<b>F 00V C17 504</b>





SEAT

Alhambra									
2.0 TDI [710]	2,0	85	CFFE <DE4>	05.11-07.15	4	DBJ	0 445 110 646	0 986 435 166	F 00V P01 004
		100	CFFA	05.10-07.15	4	DBJ	0 445 110 646	0 986 435 166	F 00V P01 004
		125	CFGB <D93>	05.10-07.15	4	DBJ	0 445 110 646	0 986 435 166	F 00V P01 004
		130	CFGC <DE2>	11.12-07.15	4	DBJ	0 445 110 646	0 986 435 166	F 00V P01 004
TDI [711]	2,0	85	CUVA <DE4>	05.15-10.15	4	DBJ	0 445 110 468	0 986 435 258	F 00V P01 004
			DFLD <DE4>	11.15→	4	DBJ	0 445 110 468	0 986 435 258	F 00V P01 004
		135	CUWA <DK7>	05.15-10.15	4	DBJ	0 445 110 470	0 986 435 257	F 00V P01 004
TDI, TDI 4Drive [710]	2,0	103	CFFB <D91>	05.10-07.15	4	DBJ	0 445 110 646	0 986 435 166	F 00V P01 004
								0 986 435 167	
TDI, TDI 4Drive [711]	2,0	110	CUVC <DN4>	05.15-10.15	4	DBJ	0 445 110 468	0 986 435 258	F 00V P01 004
			DFLA <DN4>	11.15→	4	DBJ	0 445 110 468	0 986 435 258	F 00V P01 004
		135	DFMA <DK7>	11.15→	4	DBJ	0 445 110 470	0 986 435 257	F 00V P01 004
Altea									
2.0 TDI [5P1]	2,0	103	CFHC <D91>	09.10-07.15	4	DBJ	0 445 110 646	0 986 435 166	F 00V P01 004
		125	CEGA <D93>	03.09-05.10	4	DBJ	0 445 116 029	0 986 435 360	F 00V P01 004
								0 986 435 167	
Altea Freetrack									
2.0 TDI 4WD [5P5/5P8]	2,0	103/125	CFHC <D91>; CFJA <D93>	09.10-07.15	4	DBJ	0 445 110 646	0 986 435 166	F 00V P01 004
		125	CEGA <D93>	03.09-10.10	4	DBJ	0 445 116 029	0 986 435 360	F 00V P01 004
								0 986 435 167	
Altea XL									
2.0 TDI [5P5]	2,0	125	CEGA <D93>	03.09-05.10	4	DBJ	0 445 116 029	0 986 435 360	F 00V P01 004
TDI, TDI 4WD [5P5]	2,0	103	CFHC <D91>	10.10-07.15	4	DBJ	0 445 110 646	0 986 435 166	F 00V P01 004
								0 986 435 167	
Ateca									
2.0 TDI [KH7]	2,0	81	CRVA <DN1>	01.17→	4	DBJ,EU6	0 445 110 468	0 986 435 258	F 00V P01 004
					4	DBJ,EU6	0 445 110 474	0 986 435 242	F 00V P01 004
		105	CRVC <DN6>	01.17→	4	DBJ,EU6	0 445 110 468	0 986 435 258	F 00V P01 004
					4	DBJ,EU6	0 445 110 474	0 986 435 242	F 00V P01 004
TDI, TDI 4Drive [KH7]	2,0	110	DFFA <DN4>	04.16→	4	DBJ,EU6	0 445 110 468	0 986 435 258	F 00V P01 004
					4	DBJ,EU6	0 445 110 474	0 986 435 242	F 00V P01 004
TDI 4Drive [KH7]	2,0	140	DFHA <DE5>	06.16→	4	DBJ	0 445 110 470	0 986 435 257	F 00V P01 004
Exeo									
2.0 TDI [3R2]	2,0	88	CAGC <D90>	12.08-12.11	4	DBJ	0 445 116 029	0 986 435 360	F 00V P01 004
			CJCC <D90>	01.12-08.13	4	DBJ	0 445 110 646	0 986 435 166	F 00V P01 004
								0 986 435 167	
		105	CAGA <D92>	12.08-12.11	4	DBJ	0 445 116 029	0 986 435 360	F 00V P01 004
			CJCA <D92>	01.12-08.13	4	DBJ	0 445 110 646	0 986 435 166	F 00V P01 004
								0 986 435 167	
		125	CAHA <D93>	02.09-12.11	4	DBJ	0 445 116 029	0 986 435 360	F 00V P01 004
			CGLB <D93>	01.12-08.13	4	DBJ	0 445 110 646	0 986 435 166	F 00V P01 004
								0 986 435 167	
Exeo ST									
2.0 TDI [3R5]	2,0	88	CAGC <D90>	07.09-12.11	4	DBJ	0 445 116 029	0 986 435 360	F 00V P01 004
			CJCC <D90>	01.12-08.13	4	DBJ	0 445 110 646	0 986 435 166	F 00V P01 004
								0 986 435 167	
		105	CAGA <D92>	06.09-12.11	4	DBJ	0 445 116 029	0 986 435 360	F 00V P01 004
			CJCA <D92>	01.12-08.13	4	DBJ	0 445 110 646	0 986 435 166	F 00V P01 004
								0 986 435 167	
		125	CAHA <D93>	06.09-12.11	4	DBJ	0 445 116 029	0 986 435 360	F 00V P01 004
			CGLB <D93>	01.12-08.13	4	DBJ	0 445 110 646	0 986 435 166	F 00V P01 004
								0 986 435 167	
Ibiza									
2.0 TDI [6J5]	2,0	105	CFHD <D92>	01.10-05.15	4	DBJ	0 445 110 646	0 986 435 166	F 00V P01 004
								0 986 435 167	





◀ SEAT

Ibiza SC												
2.0 TDI [6J1]	2,0	105	CFHD <D92>	01.10-05.15	4	DBJ	0 445 110 646	0 986 435 166	F 00V P01 004			
								0 986 435 167				
Leon												
1.6 TDI [5F1]	1,6	66	CLHB <D36>	11.12-10.14	4	DBJ,EU6	0 445 110 472	0 986 435 259	F 00V P01 004			
				11.12-05.15	4	DBJ,EU5	0 445 110 476	0 986 435 241	F 00V P01 004			
					4	DBJ,EU6	0 445 110 472	0 986 435 259	F 00V P01 004			
			CXXA <D36>			05.15-12.16	4	DBJ,EU5	0 445 110 476	0 986 435 241	F 00V P01 004	
			PR-Code FM1 PR-Code FM3			05.16-12.16	4	DBJ,EU6, TW	0 445 110 472	0 986 435 259		
			77 CLHA <D38>			09.12-05.15	4	DBJ,EU5	0 445 110 476	0 986 435 241	F 00V P01 004	
							4	DBJ,EU6	0 445 110 472	0 986 435 259	F 00V P01 004	
			81 CRKB <DK5>			08.13-08.14	4	DBJ,EU5	0 445 110 472	0 986 435 259	F 00V P01 004	
						08.13-10.16	4	DBJ,EU5	0 445 110 472	0 986 435 259	F 00V P01 004	
							4	DBJ,EU6, TW	0 445 110 472	0 986 435 259	F 00V P01 004	
						09.14-10.16	4	DBJ,EU5	0 445 110 476	0 986 435 241	F 00V P01 004	
			CXXB <DK5>; DBKA <DK5>			11.14-10.16	4	DBJ,EU5	0 445 110 476	0 986 435 241	F 00V P01 004	
							4	DBJ,EU6, TW	0 445 110 472	0 986 435 259	F 00V P01 004	
			2.0 TDI [1P1]			05.10-12.12	4	DBJ	0 445 110 646	0 986 435 166	F 00V P01 004	
											0 986 435 167	
125 CEGA <D93>			03.09-12.12	4	DBJ	0 445 116 029	0 986 435 360	F 00V P01 004				
TDI [5F1]	2,0	81	CRVA <DN1>	08.13-12.16	4	DBJ,EU6	0 445 110 468	0 986 435 258	F 00V P01 004			
					4	DBJ,EU6	0 445 110 474	0 986 435 242	F 00V P01 004			
			105/110 CKFC <DN4>; CRVC <DN6>			10.12→	4	DBJ,EU6	0 445 110 468	0 986 435 258	F 00V P01 004	
							4	DBJ,EU6	0 445 110 474	0 986 435 242	F 00V P01 004	
			110 CRMB <DN4>			08.13→	4	DBJ,EU6	0 445 110 468	0 986 435 258	F 00V P01 004	
							4	DBJ,EU6	0 445 110 474	0 986 435 242	F 00V P01 004	
			135 CUNA <DK7>			08.13→	4	DBJ	0 445 110 470	0 986 435 257	F 00V P01 004	
			CUPA <DK7>			08.13-12.16	4	DBJ	0 445 110 470	0 986 435 257	F 00V P01 004	
			Leon SC									
			1.6 TDI [5F5]	1,6	66	CLHB <D36>	02.13-10.14	4	DBJ,EU6	0 445 110 472	0 986 435 259	F 00V P01 004
02.13-05.15	4	DBJ,EU5					0 445 110 476	0 986 435 241	F 00V P01 004			
	4	DBJ,EU6					0 445 110 472	0 986 435 259	F 00V P01 004			
CXXA <D36>						05.15-10.16	4	DBJ,EU5	0 445 110 476	0 986 435 241	F 00V P01 004	
PR-Code FM1 PR-Code FM3						05.16-10.16	4	DBJ,EU6, TW	0 445 110 472	0 986 435 259		
77 CLHA <D38>						02.13-05.15	4	DBJ,EU5	0 445 110 476	0 986 435 241	F 00V P01 004	
							4	DBJ,EU6	0 445 110 472	0 986 435 259	F 00V P01 004	
81 CRKB <DK5>						08.13-08.14	4	DBJ,EU5	0 445 110 472	0 986 435 259	F 00V P01 004	
						08.13-10.16	4	DBJ,EU5	0 445 110 472	0 986 435 259	F 00V P01 004	
							4	DBJ,EU6, TW	0 445 110 472	0 986 435 259	F 00V P01 004	
						09.14-10.16	4	DBJ,EU5	0 445 110 476	0 986 435 241	F 00V P01 004	
CXXB <DK5>						11.14-10.16	4	DBJ,EU5	0 445 110 476	0 986 435 241	F 00V P01 004	
							4	DBJ,EU6, TW	0 445 110 472	0 986 435 259	F 00V P01 004	
DBKA <DK5>						05.15-10.16	4	DBJ,EU5	0 445 110 476	0 986 435 241	F 00V P01 004	
							4	DBJ,EU6, TW	0 445 110 472	0 986 435 259	F 00V P01 004	
2.0 TDI [5F5]	2,0	81	CRVA <DN1>	08.13-12.16	4	DBJ,EU6	0 445 110 468	0 986 435 258	F 00V P01 004			
					4	DBJ,EU6	0 445 110 474	0 986 435 242	F 00V P01 004			
			105 CRVC <DN6>			08.13→	4	DBJ,EU6	0 445 110 468	0 986 435 258	F 00V P01 004	
							4	DBJ,EU6	0 445 110 474	0 986 435 242	F 00V P01 004	
			110 CKFC <DN4>			02.13-12.16	4	DBJ,EU6	0 445 110 468	0 986 435 258	F 00V P01 004	
							4	DBJ,EU6	0 445 110 474	0 986 435 242	F 00V P01 004	
			CRMB <DN4>			08.13→	4	DBJ,EU6	0 445 110 468	0 986 435 258	F 00V P01 004	
							4	DBJ,EU6	0 445 110 474	0 986 435 242	F 00V P01 004	
			135 CUNA <DK7>			08.13→	4	DBJ	0 445 110 470	0 986 435 257	F 00V P01 004	
			CUPA <DK7>			08.13-12.16	4	DBJ	0 445 110 470	0 986 435 257	F 00V P01 004	





Leon ST												
1.6 TDI [5F8]	1,6	66	CLHB <D36>	08.13-10.14	4	DBJ,EU6	0 445 110 472	0 986 435 259	F 00V P01 004			
				08.13-05.15	4	DBJ,EU5	0 445 110 476	0 986 435 241	F 00V P01 004			
					4	DBJ,EU6	0 445 110 472	0 986 435 259	F 00V P01 004			
				CXXA <D36>	05.15-10.16	4	DBJ,EU5	0 445 110 476	0 986 435 241	F 00V P01 004		
				PR-Code FM1 PR-Code FM3	05.16-10.16	4	DBJ,EU6, TW	0 445 110 472	0 986 435 259			
				81	CRKB <DK5>	08.13-08.14	4	DBJ,EU5	0 445 110 472	0 986 435 259	F 00V P01 004	
						08.13-10.16	4	DBJ,EU5	0 445 110 472	0 986 435 259	F 00V P01 004	
							4	DBJ,EU6, TW	0 445 110 472	0 986 435 259	F 00V P01 004	
						09.14-10.16	4	DBJ,EU5	0 445 110 476	0 986 435 241	F 00V P01 004	
						CXXB <DK5>	11.14-10.16	4	DBJ,EU5	0 445 110 476	0 986 435 241	F 00V P01 004
	4	DBJ,EU6, TW	0 445 110 472			0 986 435 259	F 00V P01 004					
DBKA <DK5>	05.15-10.16	4	DBJ,EU5	0 445 110 476	0 986 435 241	F 00V P01 004						
		4	DBJ,EU6, TW	0 445 110 472	0 986 435 259	F 00V P01 004						
TDI, TDI 4Drive [5F8]	1,6	77	CLHA <D38>	08.13-05.15	4	DBJ,EU5	0 445 110 476	0 986 435 241	F 00V P01 004			
					4	DBJ,EU6	0 445 110 472	0 986 435 259	F 00V P01 004			
TDI 4Drive [5F8]	1,6	81	CRKB <DK5>	11.14-10.16	4	DBJ,EU5	0 445 110 476	0 986 435 241	F 00V P01 004			
					4	DBJ,EU6, TW	0 445 110 472	0 986 435 259	F 00V P01 004			
2.0 TDI [5F8]	2,0	81	CRLD <DN1>	01.17→	4	DBJ	0 445 110 474	0 986 435 242	F 00V P01 004			
				CRVA <DN1>	08.13-12.16	4	DBJ,EU6	0 445 110 468	0 986 435 258	F 00V P01 004		
			105	CRVC <DN6>	08.13→	4	DBJ,EU6	0 445 110 474	0 986 435 242	F 00V P01 004		
						4	DBJ,EU6	0 445 110 474	0 986 435 242	F 00V P01 004		
			110	CKFC <DN4>	08.13-12.16	4	DBJ,EU6	0 445 110 468	0 986 435 258	F 00V P01 004		
						4	DBJ,EU6	0 445 110 474	0 986 435 242	F 00V P01 004		
			135	CUPA <DK7>	08.13-12.16	4	DBJ	0 445 110 470	0 986 435 257	F 00V P01 004		
			TDI, TDI 4Drive [5F8]	2,0	110	CRLB <DN4>	05.14→	4	DBJ,EU6	0 445 110 468	0 986 435 258	F 00V P01 004
								4	DBJ,EU6	0 445 110 474	0 986 435 242	F 00V P01 004
						CRMB <DN4>	08.13→	4	DBJ,EU6	0 445 110 468	0 986 435 258	F 00V P01 004
					4	DBJ,EU6	0 445 110 474	0 986 435 242	F 00V P01 004			
		135	CUNA <DK7>	08.13→	4	DBJ	0 445 110 470	0 986 435 257	F 00V P01 004			
TDI 4Drive [5F8]	2,0	110	DCYA <DN4>	09.17→	4	DBJ	0 445 110 468	0 986 435 258	F 00V P01 004			
TDI 4Drive, TSI [5F8]	2,0	110	CRBC <DN4>	08.13-12.16	4	DBJ,EU6	0 445 110 468	0 986 435 258	F 00V P01 004			
					4	DBJ,EU6	0 445 110 474	0 986 435 242	F 00V P01 004			

Toledo									
1.6 TDI [KG3]	1,6	85	CXMA <DK8>	05.15→	4	DBJ	0 445 110 472	0 986 435 259	F 00V P01 004
2.0 TDI [5P2]	2,0	125	CEGA <D93>	03.09-05.09	4	DBJ	0 445 116 029	0 986 435 360	F 00V P01 004

SKODA

Karoq										
1.6 TDI [NU7]	1,6	85	DDYA <DK8>	07.17→	4				F 00V P01 004	
2.0 TDI 4x4 [NU7]	2,0	110	DFFA <DN4>	07.17→	4	DBJ	0 445 110 468	0 986 435 258	F 00V P01 004	
Kodiaq										
2.0 TDI, TDI 4x4 [NS7]	2,0	110	DBGA <DN4>	03.17→	4	DBJ	0 445 110 638		F 00V P01 004	
				DBGC <DN4>	03.17→	4	DBJ	0 445 110 638		F 00V P01 004
				DFGA <DN4>	03.17→	4	5PL,DBJ, EU4	0 445 110 474	0 986 435 242	F 00V P01 004
					4	6PL,DBJ	0 445 110 468	0 986 435 258	F 00V P01 004	
TDI 4x4 [NS7]	2,0	140	DFHA <DE5>	03.17→	4	DBJ	0 445 110 470	0 986 435 257	F 00V P01 004	

Octavia									
1.6 TDI [5E3]	1,6	66	CLHB <D36>	11.12-05.15	4	5PL,DBJ	0 445 110 476	0 986 435 241	F 00V P01 004
					4	6PL,DBJ, GNL	0 445 110 468	0 986 435 258	F 00V P01 004
				CXXA <D36>	05.15→	4	5PL,DBJ	0 445 110 476	0 986 435 241
		66/85	DDYA <DK8>; DDYB <D36>	02.17→	4				F 00V P01 004



## ◀ SKODA

1.6 TDI [5E3]	1,6	77	CLHA <D38>	11.12-05.15	4	5PL,DBJ	0 445 110 476	0 986 435 241	F 00V P01 004
					4	6PL,DBJ, GNL	0 445 110 468	0 986 435 258	F 00V P01 004
		81	CRKB <DK5>	11.13-05.15	4	DBJ,GNL	0 445 110 468	0 986 435 258	F 00V P01 004
			DBKA <DK5>	05.15→	4	5PL,DBJ, KGL	0 445 110 476	0 986 435 241	F 00V P01 004
TDI, TDI 4x4 [5E3]	1,6	81	CXXB <DK5>	05.15→	4	5PL,DBJ, KGL	0 445 110 476	0 986 435 241	F 00V P01 004
					4	5PL,6PL, DBJ,GNL	0 445 110 468	0 986 435 258	F 00V P01 004
TDI 4x4 [5E3]	1,6	77	CLHA <D38>	09.14-05.15	4	DBJ	0 445 110 476	0 986 435 241	F 00V P01 004
2.0 TDI [5E3]	2,0	105	CKFB <DN6>	11.12-06.13	4	DBJ,EU6	0 445 110 468	0 986 435 258	F 00V P01 004
					4	5PL,DBJ, EU4	0 445 110 474	0 986 435 242	F 00V P01 004
			CRVC <DN6>	05.13→	4	DBJ,EU6	0 445 110 468	0 986 435 258	F 00V P01 004
					4	5PL,DBJ, EU4	0 445 110 474	0 986 435 242	F 00V P01 004
TDI, TDI 4x4 [1Z3]	2,0	81/103	CFHC <D91>; CFHF <D96>; CLCA <D96>; CLCB <D91>	02.10-06.13	4	DBJ	0 445 110 646	0 986 435 166 0 986 435 167	F 00V P01 004
TDI, TDI 4x4 [5E3]	2,0	110	CKFC <DN4>	11.12-05.15	4	DBJ,EU6	0 445 110 468	0 986 435 258	F 00V P01 004
					4	5PL,DBJ, EU4	0 445 110 474	0 986 435 242	F 00V P01 004
			CRMB <DN4>	08.14→	4	5PL,DBJ, EU4	0 445 110 474	0 986 435 242	F 00V P01 004
					4	6PL,DBJ	0 445 110 468	0 986 435 258	F 00V P01 004
			DCYA <DN4>	02.17→	4	DBJ	0 445 110 468	0 986 435 258	F 00V P01 004
TDI 4x4 [5E3]	2,0	135	CUPA <DK7>	09.14-05.15	4	DBJ	0 445 110 470	0 986 435 257	F 00V P01 004
<b>Octavia Combi</b>									
1.6 TDI [5E5]	1,6	66	CLHB <D36>	11.12-05.15	4	5PL,DBJ	0 445 110 476	0 986 435 241	F 00V P01 004
					4	6PL,DBJ, GNL	0 445 110 468	0 986 435 258	F 00V P01 004
			CXXA <D36>	05.15→	4	5PL,DBJ	0 445 110 476	0 986 435 241	F 00V P01 004
					4				F 00V P01 004
		66/85	DDYA <DK8>; DDYB <D36>	02.17→	4				F 00V P01 004
		81	CRKB <DK5>	11.13-05.15	4	DBJ,GNL	0 445 110 468	0 986 435 258	F 00V P01 004
			DBKA <DK5>	05.15→	4	5PL,DBJ, KGL	0 445 110 476	0 986 435 241	F 00V P01 004
TDI, TDI 4x4 [5E5]	1,6	77	CLHA <D38>	11.12-05.15	4	5PL,DBJ	0 445 110 476	0 986 435 241	F 00V P01 004
					4	6PL,DBJ, GNL	0 445 110 468	0 986 435 258	F 00V P01 004
		81	CXXB <DK5>	05.15→	4	5PL,DBJ, KGL	0 445 110 476	0 986 435 241	F 00V P01 004
					4	5PL,6PL, DBJ,GNL	0 445 110 468	0 986 435 258	F 00V P01 004
2.0 TDI, TDI 4x4 [1Z5]	2,0	81/103	CFHC <D91>; CFHF <D96>; CLCA <D96>; CLCB <D91>	02.10-06.13	4	DBJ	0 445 110 646	0 986 435 166 0 986 435 167	F 00V P01 004
TDI, TDI 4x4 [5E5]	2,0	105/110	CKFB <DN6>; CKFC <DN4>; CRVC <DN6>	11.12→	4	DBJ,EU6	0 445 110 468	0 986 435 258	F 00V P01 004
					4	5PL,DBJ, EU4	0 445 110 474	0 986 435 242	F 00V P01 004
		110	CRMB <DN4>	08.14→	4	5PL,DBJ, EU4	0 445 110 474	0 986 435 242	F 00V P01 004
					4	6PL,DBJ	0 445 110 468	0 986 435 258	F 00V P01 004
			DCYA <DN4>	02.17→	4	DBJ	0 445 110 468	0 986 435 258	F 00V P01 004
TDI 4x4 [5E5]	2,0	135	CUPA <DK7>	09.14-05.15	4	DBJ	0 445 110 470	0 986 435 257	F 00V P01 004
<b>Octavia Combi RS</b>									
2.0 FSI, TDI, TDI 4x4 [5E5]	2,0	135	CUNA <DK7>; CUPA <DK7>	05.13→	4	DBJ	0 445 110 470	0 986 435 257	F 00V P01 004
TDI [1Z5]	2,0	125	CEGA <D93>	05.08-02.13	4	DBJ	0 445 116 029	0 986 435 360	F 00V P01 004



Octavia RS									
2.0 TDI [1Z3]	2,0	125	CEGA <D93>	05.08-02.13	4	DBJ	0 445 116 029	0 986 435 360	F 00V P01 004
TDI, TDI 4x4 [5E3]	2,0	135	CUNA <DK7>; CUPA <DK7>	05.13→	4	DBJ	0 445 110 470	0 986 435 257	F 00V P01 004
Rapid									
1.6 TDI [NH3]	1,6	85	CXMA <DK8>	05.15→	4	DBJ	0 445 110 468	0 986 435 258	
Rapid Spaceback									
1.6 TDI [NH1]	1,6	85	CXMA <DK8>	05.15→	4	DBJ	0 445 110 468	0 986 435 258	
Superb									
1.6 TDI [3V3]	1,6	88	DCXA <DK5>; DCZA <DN8>	05.15→	4	DBJ	0 445 110 468	0 986 435 258	F 00V P01 004
2.0 TDI, TDI 4x4 [3T4]	2,0	103/125	CFFB <D91>; CFGB <D93>; CLJA <D91>	02.10-05.15	4	DBJ	0 445 110 646	0 986 435 166	F 00V P01 004
		125	CBBB <D93>	06.08-05.10	4	DBJ	0 445 116 029	0 986 435 360	F 00V P01 004
TDI, TDI 4x4 [3V3]	2,0	110	CRLB <DN4>	05.15→	4	DBJ	0 445 110 468	0 986 435 258	F 00V P01 004
			DFEA <DN4>	05.15→	4	DBJ	0 445 110 468	0 986 435 258	F 00V P01 004
			DFGA <DN4>	07.17→	4	DBJ	0 445 110 468	0 986 435 258	F 00V P01 004
		140	DDAA <DE5>	05.15→	4	DBJ	0 445 110 470	0 986 435 257	F 00V P01 004
			DFCA <DE5>	05.15→	4	DBJ	0 445 110 470	0 986 435 257	F 00V P01 004
			DFHA <DE5>	08.17→	4	DBJ	0 445 110 470	0 986 435 257	F 00V P01 004
Superb Combi									
1.6 TDI [3V5]	1,6	88	DCXA <DK5>; DCZA <DN8>	05.15→	4	DBJ	0 445 110 468	0 986 435 258	F 00V P01 004
2.0 TDI [3V5]	2,0	125	CFGB <D93>	05.10-05.15	4	DBJ	0 445 110 646	0 986 435 166	F 00V P01 004
								0 986 435 167	
TDI, TDI 4x4 [3T5]	2,0	103/125	CFFB <D91>; CFGB <D93>; CLJA <D91>	02.10-05.15	4	DBJ	0 445 110 646	0 986 435 166	F 00V P01 004
		125	CBBB <D93>	09.09-05.10	4	DBJ	0 445 116 029	0 986 435 360	F 00V P01 004
TDI, TDI 4x4 [3V5]	2,0	110	CRLB <DN4>	05.15→	4	DBJ	0 445 110 468	0 986 435 258	F 00V P01 004
			DFEA <DN4>	05.15→	4	DBJ	0 445 110 468	0 986 435 258	F 00V P01 004
			DFGA <DN4>	07.17→	4	DBJ	0 445 110 468	0 986 435 258	F 00V P01 004
		140	DDAA <DE5>	05.15→	4	DBJ	0 445 110 470	0 986 435 257	F 00V P01 004
			DFCA <DE5>	05.15→	4	DBJ	0 445 110 470	0 986 435 257	F 00V P01 004
			DFHA <DE5>	08.17→	4	DBJ	0 445 110 470	0 986 435 257	F 00V P01 004
Yeti									
2.0 TDI, TDI 4x4 [5L7]	2,0	81	CFHA <D96>	11.09-05.15	4	DBJ	0 445 110 646	0 986 435 166	F 00V P01 004
								0 986 435 167	
			CUUA <DN1>	05.15-11.15	4	DBJ	0 445 110 468	0 986 435 258	F 00V P01 004
			DFSA <DN1>	05.15-12.17	4	DBJ	0 445 110 468	0 986 435 258	F 00V P01 004
		81/103/125	CFHC <D91>; CFJA <D93>; CLCA <D96>; CLCB <D91>	11.09-12.17	4	DBJ	0 445 110 646	0 986 435 166	F 00V P01 004
								0 986 435 167	
		110	CUUB <DN4>	05.15-12.17	4	DBJ	0 445 110 468	0 986 435 258	F 00V P01 004
			DFSB <DN4>	05.15-12.17	4	DBJ	0 445 110 468	0 986 435 258	F 00V P01 004
TDI 4x4 [5L7]	2,0	81	CFHF <D96>	11.09-05.15	4	DBJ	0 445 110 646	0 986 435 166	F 00V P01 004
								0 986 435 167	
		103/125	CBDB <D91>; CEGA <D93>	05.09-05.10	4	DBJ	0 445 116 029	0 986 435 360	F 00V P01 004



**SMART (MCC)**

Forfour									
1.5 cdi [454]	1,5	50/70	OM 639.939	09.04-06.07	3	DBB	0 445 110 166	0 986 435 117	1 987 972 076
								0 986 435 118	
Fortwo Cabrio									
0.8 cdi [450]	0,8	30	OM 660.940	02.04-03.07	3	DBB	0 445 110 022	0 986 435 008	
cdi [451]	0,8	33/40	660.950; 660.951 <OM 660>	04.07-09.13	3	DBB	0 445 110 302	0 986 435 184	1 987 972 076
Fortwo Coupé									
0.8 cdi [450]	0,8	30	OM 660.940	02.04-03.07	3	DBB	0 445 110 022	0 986 435 008	
cdi [451]	0,8	33/40	660.950; 660.951 <OM 660>	04.07-09.13	3	DBB	0 445 110 302	0 986 435 184	1 987 972 076
Smart Cabrio									
0.8 cdi [450]	0,8	30	OM 660.940	03.01-01.04	3	DBB	0 445 110 022	0 986 435 008	
Smart Coupé									
0.8 cdi [450]	0,8	30	OM 660.940	11.99-01.04	3	DBB	0 445 110 022	0 986 435 008	



**SUZUKI**

<b>Grand Vitara</b>										
1.9 DDiS 4x4 [JT]	1,9	95	F9Q							
			Fg.-Nr. →00610000	10.05-12.14	4	DBB	0 445 110 230	0 986 435 124		
			Fg.-Nr. 00610001→	10.05-12.14	4	DBB	0 445 110 328	0 986 435 188		
2.0 D Turbo [FT]	2,0	80	RHW	11.00-12.05	4	DBB,KKB	0 445 110 057	0 986 435 093		
			RHZ	11.00-12.05	4	DBB	0 445 110 044	0 986 435 003		
TDi XL-7 [HT]	2,0	80	RHW	06.01-10.05	4	DBB,KKB	0 445 110 057	0 986 435 093		
<b>Ignis Hatchback</b>										
1.3 DDiS Turbo	1,3	51	Z13DT	10.03-12.07	4	DBB	0 445 110 083	0 986 435 078		
<b>Splash</b>										
1.3 DDiS [A5B]	1,2	55	D13A <DPF>; Z13DTJ	01.08-10.10	4	DBJ	0 445 110 316	0 986 435 226		
<b>Swift Hatchback</b>										
1.3 DDiS [FZ/NZ]	1,2	55	D13AA	09.10-12.14	4	DBB	0 445 110 351	0 986 435 204		
DDiS D Turbo [FZ/NZ]	1,2	55	D13A <DPF>	09.10-12.14	4	DBJ	0 445 110 398	0 986 435 247		
DDiS D Turbo [MZ/EZ]	1,3	51-55	Z13DT							
			Fg.-Nr. →00500000	08.05-12.14	4	DBB	0 445 110 083	0 986 435 078		
			Fg.-Nr. 00500001→	08.05-12.14	4	DBJ	0 445 110 316	0 986 435 226		
DDiS, DDiS D Turbo [MZ/EZ]	1,2	55	D13A <DPF>; Z13DTJ	02.08-12.14	4	DBJ	0 445 110 316	0 986 435 226		
<b>SX4 Hatchback</b>										
1.6 DDiS	1,6	66	9HX	04.07-08.09	4	DBJ	0 445 110 239	0 986 435 122		
1.9 DDiS, DDiS 4WD	1,9	88	D19AA	05.06-08.09	4	DBJ	0 445 110 276	0 986 435 148		
<b>Wagon R+</b>										
1.3 DDiS D Turbo [MM]	1,3	51	Z13DT	09.03-03.06	4	DBB	0 445 110 083	0 986 435 078		

**TATA (TELCO)**

<b>Indica Vista</b>										
1.2 D [X1]	1,2	55	Quadrajel	08.08→	4	DBJ	0 445 110 331	0 986 435 298		

**UAZ**

<b>Patriot</b>										
2.2 TD 4x4	2,3	85	F1AE0481B	01.07→	4	DBB	0 445 110 273	0 986 435 165		

**VAUXHALL**

<b>Agila</b>										
1.3 CDTi [B]	1,2	55	Z 13 DTJ	07.08-08.15	4	DBB	0 445 110 183	0 986 435 102		
<b>Antara</b>										
2.0 CDTi 4x4	2,0	93/110	Z 20 DM <Ecotec>; Z 20 DMH <Ecotec>	11.06-12.11	4	DBJ	0 445 110 269	0 986 435 153		
								0 986 435 238		
<b>Astra</b>										
1.3 CDTi [H]	1,3	66	Z 13 DTH <Ecotec>	01.06-03.10	4	DBB	0 445 110 183	0 986 435 102		
CDTi [J]	1,2	70	A 13 DTE <ecoFlex>	09.09-08.16	4	DBJ	0 445 110 326	0 986 435 200		
1.7 CDTi [H]	1,7	59	Z 17 DTL <Turbo Ecotec>	03.04-03.07	4	DBJ	0 445 110 174	0 986 435 105		
		74	Z 17 DTH <Turbo Ecotec>	03.04-08.09	4	DBJ	0 445 110 175	0 986 435 089		
CDTi 16V [G]	1,7	59	Z 17 DTL <Turbo Ecotec>	03.03-08.05	4	DBJ	0 445 110 118	0 986 435 082		
1.9 CDTi [H]	1,9	74	Z 19 DTL <Turbo Ecotec>	09.05-03.10	4					<b>F 00V C17 504</b>
			Fg.-Nr. →72045139→75030986	09.05-03.10	4	DBB	0 445 110 165	0 986 435 103		
			→78025126							
			Fg.-Nr. 72045140→75030987→	09.05-03.10	4	DBJ	0 445 110 276	0 986 435 148		
			78025127→78007392→							





1.9 CDTI [H]	1,9	88	Z 19 DT <Turbo Ecotec>	09.05-03.10	4							F 00V C17 504
			Fg.-Nr. →72045139 →75030986 →78025126	09.05-03.10	4	DBB	0 445 110 165	0 986 435 103				
			Fg.-Nr. 72045140 → 75030987 → 78025127 → 78007392 →	09.05-03.10	4	DBJ	0 445 110 276	0 986 435 148				
			Z 19 DTJ <Turbo Ecotec>	03.04-03.10	4							F 00V C17 504
			Fg.-Nr. →72045139 →75030986 →78025126	03.04-03.10	4	DBB	0 445 110 159	0 986 435 088				
			Fg.-Nr. 72045140 → 75030987 → 78025127 →	03.04-03.10	4	DBB	0 445 110 243	0 986 435 104				
		110	Z 19 DTH <Ecotec>	03.04-03.10	4							F 00V C17 504
			Fg.-Nr. →72045139 →75030986 →78025126	03.04-03.10	4	DBB	0 445 110 159	0 986 435 088				
			Fg.-Nr. 72045140 → 75030987 → 78025127 →	03.04-03.10	4	DBB	0 445 110 243	0 986 435 104				
2.0 CDTI [J]	2,0	118/121	A 20 DTH <Ecotec>	09.09-08.16	4	DBB	0 445 110 327	0 986 435 201				F 00V C17 504
		143	A 20 DTR <Ecotec>	08.12-08.16	4	DBB	0 445 117 018	0 986 435 427				F 00V C17 504
				08.12 →	4	DBB	0 445 117 018	0 986 435 427				F 00V C17 504
GTC [J]	2,0	143	A 20 DTR <Ecotec>	08.12 →	4							F 00V C17 504
<b>Astra Estate</b>												
1.3 CDTI [H]	1,3	66	Z 13 DTH <Ecotec>	06.05-03.10	4	DBB	0 445 110 183	0 986 435 102				
1.7 CDTI [G]	1,7	59	Z 17 DTL <Turbo Ecotec>	03.03-08.05	4	DBJ	0 445 110 118	0 986 435 082				
CDTI [H]	1,7	59	Z 17 DTL <Turbo Ecotec>	08.04-03.07	4	DBJ	0 445 110 174	0 986 435 105				
		74	Z 17 DTH <Turbo Ecotec>	08.04-08.09	4	DBJ	0 445 110 175	0 986 435 089				
1.9 CDTI [H]	1,9	74	Z 19 DTL <Turbo Ecotec>	09.05-03.10	4							F 00V C17 504
			Fg.-Nr. →72045139 →75030986 →78025126	09.05-03.10	4	DBB	0 445 110 165	0 986 435 103				
			Fg.-Nr. 72045140 → 75030987 → 78025127 → 78007392 →	09.05-03.10	4	DBJ	0 445 110 276	0 986 435 148				
		88	Z 19 DT <Turbo Ecotec>	09.05-03.10	4							F 00V C17 504
			Fg.-Nr. →72045139 →75030986 →78025126	09.05-03.10	4	DBB	0 445 110 165	0 986 435 103				
			Fg.-Nr. 72045140 → 75030987 → 78025127 → 78007392 →	09.05-03.10	4	DBJ	0 445 110 276	0 986 435 148				
			Z 19 DTJ <Turbo Ecotec>	08.04-03.10	4							F 00V C17 504
			Fg.-Nr. →72045139 →75030986 →78025126	08.04-03.10	4	DBB	0 445 110 159	0 986 435 088				
			Fg.-Nr. 72045140 → 75030987 → 78025127 →	08.04-03.10	4	DBB	0 445 110 243	0 986 435 104				
		110	Z 19 DTH <Ecotec>	08.04-03.10	4							F 00V C17 504
			Fg.-Nr. →72045139 →75030986 →78025126	08.04-03.10	4	DBB	0 445 110 159	0 986 435 088				
			Fg.-Nr. 72045140 → 75030987 → 78025127 →	08.04-03.10	4	DBB	0 445 110 243	0 986 435 104				
<b>Astra GTC</b>												
1.7 CDTI [H]	1,7	59	Z 17 DTL <Turbo Ecotec>	09.05-03.07	4	DBJ	0 445 110 174	0 986 435 105				
		74	Z 17 DTH <Turbo Ecotec>	06.05-08.09	4	DBJ	0 445 110 175	0 986 435 089				
1.9 CDTI [H]	1,9	88	Z 19 DTJ <Turbo Ecotec>	06.05-03.09	4							F 00V C17 504
			Fg.-Nr. →72045139 →75030986 →78025126	06.05-03.09	4	DBB	0 445 110 159	0 986 435 088				
			Fg.-Nr. 72045140 → 75030987 → 78025127 →	06.05-03.09	4	DBB	0 445 110 243	0 986 435 104				
		110	Z 19 DTH <Ecotec>	06.05-12.09	4							F 00V C17 504
			Fg.-Nr. →72045139 →75030986 →78025126	06.05-12.09	4	DBB	0 445 110 159	0 986 435 088				
			Fg.-Nr. 72045140 → 75030987 → 78025127 →	06.05-12.09	4	DBB	0 445 110 243	0 986 435 104				
2.0 [J]	2,0	121	A 20 DTH <Ecotec>	09.11 →	4	DBB	0 445 110 327	0 986 435 201				F 00V C17 504
<b>Astra Sports Tourer</b>												
1.3 CDTI [J]	1,2	70	A 13 DTE <ecoFlex>	09.10-08.16	4	DBJ	0 445 110 326	0 986 435 200				
2.0 CDTI [J]	2,0	118/121	A 20 DTH <Ecotec>	09.10-08.16	4	DBB	0 445 110 327	0 986 435 201				F 00V C17 504
		143	A 20 DTR <Ecotec>	08.12-08.16	4	DBB	0 445 117 018	0 986 435 427				F 00V C17 504







◀ VAUXHALL

Astra TwinTop									
1.9 CDTi [H]	1,9	110	Z 19 DTH <Ecotec>	09.05-12.09	4				F 00V C17 504
			Fg.-Nr. →72045139 →75030986 →78025126	09.05-12.09	4	DBB	0 445 110 159	0 986 435 088	
			Fg.-Nr. 72045140 → 75030987 → 78025127 →	09.05-12.09	4	DBB	0 445 110 243	0 986 435 104	
Astra Van									
1.7 CDTi [G]	1,7	59	Z 17 DTL <Turbo Ecotec>	03.03-08.05	4	DBJ	0 445 110 118	0 986 435 082	
Cascada									
2.0 CDTi	2,0	121	A 20 DTH <Ecotec>	04.13 →	4	DBB	0 445 110 327	0 986 435 201	F 00V C17 504
		125	B 20 DTH	07.15 →	4	DBJ	0 445 110 713		F 00V C17 504
		143	A 20 DTR <Ecotec>	04.13 →	4	DBB	0 445 117 018	0 986 435 427	F 00V C17 504
Combo									
1.3 [D]	1,2	66	A 13 FD <ecoFLEX>	02.12 →	4	DBB	0 445 110 351	0 986 435 204	
	1,3	70		07.16 →	4	DBB	0 445 110 351	0 986 435 204	
CDTi [Tour]	1,3	51	Y 13 DT <Turbo>; Z 13 DT <Ecotec>	09.04-01.12	4	DBB	0 445 110 083	0 986 435 078	
		55	Z 13 DTJ <Turbo>	03.06-01.12	4	DBB	0 445 110 183	0 986 435 102	
1.6 [D]	1,6	66	A 16 FDL <ecoFLEX>	02.12 →	4	DBJ,EU5	0 445 110 300	0 986 435 171	F 00V C17 504
					4	5PL,DBJ	0 445 110 524	0 986 435 280	F 00V C17 504
		74/77	A 16 FDH <ecoFLEX>	02.12 →	4	DBJ,EU5	0 445 110 300	0 986 435 171	F 00V C17 504
					4	5PL,DBJ	0 445 110 524	0 986 435 280	F 00V C17 504
2.0 [D]	2,0	99	A 20 FD <ecoFLEX>	02.12 →	4	DBJ,EU5	0 445 110 299	0 986 435 230	F 00V C17 504
					4	5PL,DBJ	0 445 110 419	0 986 435 213	F 00V C17 504
Corsa									
1.3 [E]	1,2	55/70	B 13 DTC; B 13 DTE; B 13 DTR	10.14 →	4	DBJ	0 445 110 618		
CDTi [C]	1,3	51	Y 13 DT <Turbo Ecotec>; Z 13 DT <Ecotec>	09.03-09.06	4	DBB	0 445 110 083	0 986 435 078	
		55	Z 13 DTJ <Turbo Ecotec>	09.05-09.06	4	DBB	0 445 110 183	0 986 435 102	
CDTi [D]	1,2	55/66	Z 13 DTH <Turbo Ecotec>; Z 13 DTJ <Turbo Ecotec>	07.06-07.10	4	DBB	0 445 110 183	0 986 435 102	
		55/70	A 13 DT... <ecoFlex>; A 13 DTC <Ecotec>	01.11-08.14	4	DBJ	0 445 110 326	0 986 435 200	
		70	Z 13 DTE <eco Flex>	12.09-09.10	4	DBJ	0 445 110 326	0 986 435 200	
	1,3	55/66	A 13 DTH <Turbo Ecotec>; A 13 DTJ <Turbo Ecotec>	10.06-02.09	4	DBB	0 445 110 183	0 986 435 102	
Crossland X									
1.6	1,6	73-74/88	B 16 DT <LEK>; <LDI>	01.17 →	4				F 00V C17 504
Grandland X									
1.6	1,6	88	<LDI>	10.17 →	4				F 00V C17 504
Insignia									
2.0 CDTi [A]	2,0	81/96	A 20 DT... <Ecotec>	11.08-12.17	4				F 00V C17 504
			Mot.-Typ A 20 DT	11.08-12.17	4	DBB	0 445 110 423	0 986 435 237	
			Mot.-Typ A 20 DTL						
			Mot.-Typ A 20 DTJ	11.08-12.17	4	DBB	0 445 110 327	0 986 435 201	
			Mot.-Typ A 20 DTH						
			Mot.-Typ A 20 DTC						
		88/103	A 20 DTE	09.13-12.17	4	DBB	0 445 110 423	0 986 435 237	F 00V C17 504
CDTi, CDTi 4x4 [A]	2,0	118	A 20 DTH <Ecotec>	11.08-12.17	4	DBB	0 445 110 327	0 986 435 201	F 00V C17 504
		125	B 20 DTH	01.15-12.17	4	DBJ	0 445 110 713		F 00V C17 504
		140-143	A 20 DTR <Ecotec>	07.09-12.17	4	DBB	0 445 117 018	0 986 435 427	F 00V C17 504
Insignia Grand Sport									
2.0 , 4x4 [B]	2,0	125	<LFS>	03.17 →	4	DBJ	0 445 110 713		F 00V C17 504
4x4 [B]	2,0	154	<LFO>	10.17 →	4	DBJ	0 445 110 809		F 00V C17 504
Insignia Sports Tourer									
2.0 , 4x4 [B]	2,0	125	<LFS>	03.17 →	4	DBJ	0 445 110 713		F 00V C17 504
CDTi [A]	2,0	81/96	A 20 DT... <Ecotec>	02.09-12.17	4				F 00V C17 504
			Mot.-Typ A 20 DT	02.09-12.17	4	DBB	0 445 110 423	0 986 435 237	
			Mot.-Typ A 20 DTL						
			Mot.-Typ A 20 DTJ	02.09-12.17	4	DBB	0 445 110 327	0 986 435 201	
			Mot.-Typ A 20 DTH						
			Mot.-Typ A 20 DTC						
		88/103	A 20 DTE	09.13-12.17	4	DBB	0 445 110 423	0 986 435 237	F 00V C17 504





<b>2.0</b>	CDTI, CDTI 4x4 [A]	2,0	118	A 20 DTH <Ecotec>	02.09-12.17	4	DBB	<b>0 445 110 327</b>	<b>0 986 435 201</b>	<b>F 00V C17 504</b>	
			125	B 20 DTH	01.15-12.17	4	DBJ	<b>0 445 110 713</b>		<b>F 00V C17 504</b>	
			140-143	A 20 DTR <Ecotec>	07.09-12.17	4	DBB	<b>0 445 117 018</b>	<b>0 986 435 427</b>	<b>F 00V C17 504</b>	
		4x4 [B]	2,0	154	<LFO>	10.17→	4	DBJ	<b>0 445 110 809</b>		<b>F 00V C17 504</b>
<b>Meriva</b>											
<b>1.3</b>	CDTI [A]	1,3	51	Y 13 DT <Ecotec>; Z 13 DT <Ecotec>	09.05-03.10	4	DBB	<b>0 445 110 083</b>	<b>0 986 435 078</b>		
			55	Z 13 DTJ <Ecotec>	09.03-03.10	4	DBB	<b>0 445 110 183</b>	<b>0 986 435 102</b>		
		CDTI [B]	1,2	55	A 13 DTC <Ecotec>						
				Fg.-Nr. A4192110→	06.10-12.17	4	DBJ	<b>0 445 110 326</b>	<b>0 986 435 200</b>		
				Fg.-Nr. →A4192109	06.10-12.17	4	DBJ	<b>0 445 110 325</b>	<b>0 986 435 199</b>		
									<b>0 986 435 200</b>		
			70	A 13 DTE <ecoFlex>	06.10-12.17	4	DBJ	<b>0 445 110 326</b>	<b>0 986 435 200</b>		
<b>Signum</b>											
<b>1.9</b>	CDTI	1,9	74	Z 19 DTL <Ecotec>	09.05-09.08	4				<b>F 00V C17 504</b>	
				Fg.-Nr. →71021891	09.05-09.08	4	DBB	<b>0 445 110 165</b>	<b>0 986 435 103</b>		
				Fg.-Nr. 71021892→	09.05-09.08	4	DBJ	<b>0 445 110 276</b>	<b>0 986 435 148</b>		
				88	Z 19 DT <Ecotec>	04.04-09.08	4			<b>F 00V C17 504</b>	
					Fg.-Nr. →71021891	04.04-09.08	4	DBB	<b>0 445 110 165</b>	<b>0 986 435 103</b>	
					Fg.-Nr. 71021892→	04.04-09.08	4	DBJ	<b>0 445 110 276</b>	<b>0 986 435 148</b>	
				110	Z 19 DTH <Ecotec>	04.04-09.08	4			<b>F 00V C17 504</b>	
					Fg.-Nr. →71021891	04.04-09.08	4	DBB	<b>0 445 110 159</b>	<b>0 986 435 088</b>	
					Fg.-Nr. 71021892→	04.04-09.08	4	DBB	<b>0 445 110 243</b>	<b>0 986 435 104</b>	
	<b>Tigra TwinTop</b>										
<b>1.3</b>	CDTI [B]	1,3	51	Z 13 DT <Ecotec>	06.04-03.09	4	DBB	<b>0 445 110 083</b>	<b>0 986 435 078</b>		
<b>Vectra</b>											
<b>1.9</b>	CDTI [C]	1,9	74	Z 19 DTL <Ecotec>	09.05-10.08	4				<b>F 00V C17 504</b>	
				Fg.-Nr. →71021891 →48999999	09.05-10.08	4	DBB	<b>0 445 110 165</b>	<b>0 986 435 103</b>		
				Fg.-Nr. 71021892→	09.05-10.08	4	DBJ	<b>0 445 110 276</b>	<b>0 986 435 148</b>		
				88	Z 19 DT <Ecotec>	04.04-10.08	4			<b>F 00V C17 504</b>	
					Fg.-Nr. →71021891 →48999999	04.04-10.08	4	DBB	<b>0 445 110 165</b>	<b>0 986 435 103</b>	
					Fg.-Nr. 71021892→	04.04-10.08	4	DBJ	<b>0 445 110 276</b>	<b>0 986 435 148</b>	
				110	Z 19 DTH <Ecotec>	04.04-03.08	4			<b>F 00V C17 504</b>	
					Fg.-Nr. →71021891 →48999999	04.04-03.08	4	DBB	<b>0 445 110 159</b>	<b>0 986 435 088</b>	
					Fg.-Nr. 71021892→	04.04-03.08	4	DBB	<b>0 445 110 243</b>	<b>0 986 435 104</b>	
	<b>Vectra Estate</b>										
<b>1.9</b>	CDTI [C]	1,9	74	Z 19 DTL <Ecotec>	09.05-10.08	4				<b>F 00V C17 504</b>	
				Fg.-Nr. →71021891 →48999999	09.05-10.08	4	DBB	<b>0 445 110 165</b>	<b>0 986 435 103</b>		
				Fg.-Nr. 71021892→	09.05-10.08	4	DBJ	<b>0 445 110 276</b>	<b>0 986 435 148</b>		
				88	Z 19 DT <Ecotec>	04.04-10.08	4			<b>F 00V C17 504</b>	
					Fg.-Nr. →71021891 →48999999	04.04-10.08	4	DBB	<b>0 445 110 165</b>	<b>0 986 435 103</b>	
					Fg.-Nr. 71021892→	04.04-10.08	4	DBJ	<b>0 445 110 276</b>	<b>0 986 435 148</b>	
				110	Z 19 DTH <Ecotec>	04.04-03.08	4			<b>F 00V C17 504</b>	
					Fg.-Nr. →71021891 →48999999	04.04-03.08	4	DBB	<b>0 445 110 159</b>	<b>0 986 435 088</b>	
					Fg.-Nr. 71021892→	04.04-03.08	4	DBB	<b>0 445 110 243</b>	<b>0 986 435 104</b>	
	<b>Zafira</b>										
<b>1.9</b>	CDTI [B]	1,9	74	Z 19 DTL <Ecotec>	07.05-03.08	4				<b>F 00V C17 504</b>	
				Fg.-Nr. →62999999 →6G999999	07.05-03.08	4	DBB	<b>0 445 110 165</b>	<b>0 986 435 103</b>		
				Fg.-Nr. 72000001→ 7G000001→	07.05-03.08	4	DBJ	<b>0 445 110 276</b>	<b>0 986 435 148</b>		
				88	Z 19 DT <Ecotec>						
					Fg.-Nr. →62999999 →6G999999	07.05-12.10	4	DBB	<b>0 445 110 165</b>	<b>0 986 435 103</b>	
					Fg.-Nr. 72000001→ 7G000001→	07.05-12.10	4	DBJ	<b>0 445 110 276</b>	<b>0 986 435 148</b>	
					Mot.-Nr. →6260381	07.05-12.10	4			<b>F 00V C17 504</b>	
					Mot.-Nr. 6260382→	07.05-12.10	4			<b>F 00V C17 504</b>	
				110	Z 19 DTH <Ecotec>	07.05-12.10	4			<b>F 00V C17 504</b>	
					Fg.-Nr. →62999999 →6G999999	07.05-12.10	4	DBB	<b>0 445 110 159</b>	<b>0 986 435 088</b>	
				Fg.-Nr. 72000001→ 7G000001→	07.05-12.10	4	DBB	<b>0 445 110 243</b>	<b>0 986 435 104</b>		
<b>2.0</b>	CDTI [C]	2,0	81	A 20 DTL <Ecotec>	01.12→	4	DBB	<b>0 445 110 423</b>	<b>0 986 435 237</b>	<b>F 00V C17 504</b>	
			96	A 20 DT <ecoFLEX>	01.12→	4	DBB	<b>0 445 110 423</b>	<b>0 986 435 237</b>	<b>F 00V C17 504</b>	
			121	A 20 DTH <Ecotec>	01.12→	4	DBB	<b>0 445 110 327</b>	<b>0 986 435 201</b>	<b>F 00V C17 504</b>	
			125	B 20 DTH	02.15→	4	DBJ	<b>0 445 110 713</b>		<b>F 00V C17 504</b>	
			143	A 20 DTR <Ecotec>	01.13→	4				<b>F 00V C17 504</b>	





**VOLVO**

<b>C30</b>										
1.6 D DRiVe [P14]	1,6	79-80	D4164TDRIve	10.06-07.11	4					<b>F 00V C17 504</b>
			Fg.-Nr. →26508	10.06-07.11	4	DBJ	<b>0 445 110 188</b>	<b>0 986 435 090</b>		
			Fg.-Nr. 26509→	10.06-07.11	4	DBJ	<b>0 445 110 259</b>	<b>0 986 435 126</b>		
2.0 D3 [P14]	2,0	110	D5204T5	08.10→	5	DBJ	<b>0 445 116 045</b>	<b>0 986 435 424</b>		<b>F 00V P01 004</b>
D4 [P14]	2,0	130	D5204T	08.10→	5	DBJ	<b>0 445 116 045</b>	<b>0 986 435 424</b>		<b>F 00V P01 004</b>
2.4 D5 [P14]	2,4	120/131-132	D5244T9; D5244T13	10.06-07.10	5	DBJ	<b>0 445 110 251</b>	<b>0 986 435 125</b>		
<b>C70 II Cabrio</b>										
2.0 D3	2,0	110	D5204T5	10.10-07.13	5	DBJ	<b>0 445 116 045</b>	<b>0 986 435 424</b>		<b>F 00V P01 004</b>
D4	2,0	130	D5204T	10.10-07.13	5	DBJ	<b>0 445 116 045</b>	<b>0 986 435 424</b>		<b>F 00V P01 004</b>
2.4 D	2,4	120	D5244T9	08.06-07.10	5	DBJ	<b>0 445 110 251</b>	<b>0 986 435 125</b>		
D5	2,4	132	D5244T13							
			Mot.-Nr. →566747	08.06-07.10	5	DBJ	<b>0 445 110 251</b>	<b>0 986 435 125</b>		
			Mot.-Nr. 566748→	08.06-07.10	5	DBJ	<b>0 445 110 298</b>	<b>0 986 435 195</b>		
<b>S40 II</b>										
1.6 D DRiVe [P11]	1,6	80-81	D4164TDRIve	11.04-08.12	4	DBJ	<b>0 445 110 188</b>	<b>0 986 435 090</b>		<b>F 00V C17 504</b>
2.0 D3 [P11]	2,0	110	D5204T5	08.10-08.12	5	DBJ	<b>0 445 116 045</b>	<b>0 986 435 424</b>		<b>F 00V P01 004</b>
D4 [P11]	2,0	130	D5204T	08.10-08.12	5	DBJ	<b>0 445 116 045</b>	<b>0 986 435 424</b>		<b>F 00V P01 004</b>
2.4 D5 [P11]	2,4	120/132	D5244T9; D5244T13	03.06-07.10	5	DBJ	<b>0 445 110 251</b>	<b>0 986 435 125</b>		
<b>S60 Cross Country</b>										
2.4 D5 AWD	2,4	140	D5244T21	08.15→	5	DBJ	<b>0 445 116 016</b>	<b>0 986 435 393</b>		<b>F 00V P01 004</b>
<b>S60 I</b>										
2.4 D	2,4	85/96/120	D5244T; D5244T2; D5244T3	08.01-07.06	5	DBJ	<b>0 445 110 078</b>	<b>0 986 435 120</b>		
D, D5	2,4	90/93/120/136	D5244T4; D5244T5; D5244T6; D5244T7	08.05-07.09	5	DBJ	<b>0 445 110 251</b>	<b>0 986 435 125</b>		
<b>S60 II</b>										
2.0 D3, D4	2,0	100/120	D5204T2; D5204T3; D5204T7	08.10-12.15	5	DBJ	<b>0 445 116 045</b>	<b>0 986 435 424</b>		<b>F 00V P01 004</b>
2.4 D4 AWD, D5, D5 AWD	2,4	140/169	D5244T21; D5244T23	08.14→	5	DBJ	<b>0 445 116 016</b>	<b>0 986 435 393</b>		<b>F 00V P01 004</b>
D5	2,4	158	D5244T11	08.11-07.15	5	DBJ	<b>0 445 116 016</b>	<b>0 986 435 393</b>		<b>F 00V P01 004</b>
D5, D5 AWD	2,4	151	D5244T10	08.10-07.11	5	DBJ	<b>0 445 116 016</b>	<b>0 986 435 393</b>		<b>F 00V P01 004</b>
		158	D5244T15	08.11-07.15	5	DBJ	<b>0 445 116 016</b>	<b>0 986 435 393</b>		<b>F 00V P01 004</b>
<b>S80 I</b>										
2.4 D, D5	2,4	96/120	D5244T; D5244T2	08.01-07.06	5	DBJ	<b>0 445 110 078</b>	<b>0 986 435 120</b>		
<b>S80 II</b>										
1.6 D DRiVe	1,6	80	D4164T	08.09-07.11	4	DBJ	<b>0 445 110 259</b>	<b>0 986 435 126</b>		<b>F 00V C17 504</b>
2.0 D3, D4	2,0	100/120	D5204T2; D5204T3; D5204T7	08.10-08.16	5	DBJ	<b>0 445 116 045</b>	<b>0 986 435 424</b>		<b>F 00V P01 004</b>
2.4 D	2,4	120	D5244T5							
			Fg.-Nr. →45801	08.06-07.09	5	DBJ	<b>0 445 110 251</b>	<b>0 986 435 125</b>		
			Fg.-Nr. 45802→	08.06-07.09	5	DBJ	<b>0 445 110 298</b>	<b>0 986 435 195</b>		
			D5244T19	08.09-07.10	5	DBJ	<b>0 445 116 036</b>	<b>0 986 435 408</b>		<b>F 00V P01 004</b>
		129	D5244T14	08.09-07.10	5	DBJ	<b>0 445 116 036</b>	<b>0 986 435 408</b>		<b>F 00V P01 004</b>
D5, D5 AWD	2,4	136	D5244T4	03.06-07.09	5	DBJ	<b>0 445 110 251</b>	<b>0 986 435 125</b>		
		151	D5244T10	11.08-07.11	5	DBJ	<b>0 445 116 016</b>	<b>0 986 435 393</b>		<b>F 00V P01 004</b>
		158	D5244T11; D5244T15	08.11-08.16	5	DBJ	<b>0 445 116 016</b>	<b>0 986 435 393</b>		<b>F 00V P01 004</b>
<b>V40 Cross Country</b>										
2.0 D3, D4	2,0	110/130	D5204T4; D5204T6	01.13-08.17	5	DBJ	<b>0 445 116 045</b>	<b>0 986 435 424</b>		<b>F 00V P01 004</b>
TD D3	2,0	121	D5204T3	02.12→	5	DBJ	<b>0 445 116 045</b>	<b>0 986 435 424</b>		
<b>V40 II</b>										
2.0 D3, D4	2,0	110/130	D5204T4; D5204T6	09.12-08.15	5	DBJ	<b>0 445 116 045</b>	<b>0 986 435 424</b>		<b>F 00V P01 004</b>
<b>V50</b>										
1.6 D DRiVe [P12]	1,6	80-81	D4164TDRIve	11.04-07.10	4	DBJ	<b>0 445 110 188</b>	<b>0 986 435 090</b>		<b>F 00V C17 504</b>
2.0 D3 [P12]	2,0	110	D5204T5	08.10-12.12	5	DBJ	<b>0 445 116 045</b>	<b>0 986 435 424</b>		<b>F 00V P01 004</b>
D4 [P12]	2,0	130	D5204T	08.10-12.12	5	DBJ	<b>0 445 116 045</b>	<b>0 986 435 424</b>		<b>F 00V P01 004</b>
2.4 D5 [P12]	2,4	120/132	D5244T9; D5244T13	04.06-07.10	5	DBJ	<b>0 445 110 251</b>	<b>0 986 435 125</b>		
<b>V60</b>										
2.0 D3, D4	2,0	100/120	D5204T2; D5204T3; D5204T7	09.10-08.15	5	DBJ	<b>0 445 116 045</b>	<b>0 986 435 424</b>		<b>F 00V P01 004</b>





2.4 D4 AWD, D5, D5 AWD	2,4	120/133/140/169	D5244T12; D5244T17; D5244T21; D5244T23	09.12→	5	DBJ	0 445 116 016	0 986 435 393	F 00V P01 004
D5	2,4	158	D5244T11	09.11-08.15	5	DBJ	0 445 116 016	0 986 435 393	F 00V P01 004
D5, D5 AWD	2,4	151	D5244T10	09.10-08.11	5	DBJ	0 445 116 016	0 986 435 393	F 00V P01 004
		158	D5244T15	09.11-08.15	5	DBJ	0 445 116 016	0 986 435 393	F 00V P01 004
<b>V60 Cross Country</b>									
2.4 D5 AWD	2,4	140	D5244T21	08.15→	5	DBJ	0 445 116 016	0 986 435 393	F 00V P01 004
<b>V70 II</b>									
2.4 D, D AWD, D5, D5 AWD	2,4	96/120/136	D5244T; D5244T2; D5244T3	08.01-07.06	5	DBJ	0 445 110 078	0 986 435 120	
D, D5, D5 AWD	2,4	90/93/120/136	D5244T4; D5244T5; D5244T6; D5244T7	08.06-07.07	5	DBJ	0 445 110 251	0 986 435 125	
<b>V70 III</b>									
1.6 D DRiVe	1,6	80	D4164T	01.10-07.11	4	DBJ	0 445 110 259	0 986 435 126	F 00V C17 504
2.0 D3, D3/D4	2,0	100/120	D5204T2; D5204T3; D5204T7	08.10-07.15	5	DBJ	0 445 116 045	0 986 435 424	F 00V P01 004
2.4 D	2,4	129	D5244T14	08.09-07.10	5	DBJ	0 445 116 036	0 986 435 408	F 00V P01 004
D, D5, D5 AWD	2,4	120/132-136	D5244T4; D5244T5	08.07-07.09	5	DBJ	0 445 110 298	0 986 435 195	
D4 AWD	2,4	120/133	D5244T12; D5244T17	08.12-07.16	5	DBJ	0 445 116 016	0 986 435 393	F 00V P01 004
D5	2,4	158	D5244T11	08.11-07.15	5	DBJ	0 445 116 016	0 986 435 393	F 00V P01 004
D5, D5 AWD	2,4	151	D5244T10	08.09-07.11	5	DBJ	0 445 116 016	0 986 435 393	F 00V P01 004
		158	D5244T15	08.11-07.15	5	DBJ	0 445 116 016	0 986 435 393	F 00V P01 004
<b>XC60 I</b>									
2.0 D3	2,0	100	D5204T7	08.12-07.15	5	DBJ	0 445 116 045	0 986 435 424	F 00V P01 004
D3 DRiVe	2,0	120	D5204T2	08.10-07.11	5	DBJ	0 445 116 045	0 986 435 424	F 00V P01 004
D3 DRiVe, D4	2,0	120	D5204T3	08.11-07.12	5	DBJ	0 445 116 045	0 986 435 424	F 00V P01 004
				08.11-07.15	5	DBJ	0 445 116 045	0 986 435 424	F 00V P01 004
2.4 D AWD	2,4	120	D5244T16	08.09-07.11	5	DBJ	0 445 116 016	0 986 435 393	F 00V P01 004
D AWD, D5 AWD	2,4	120/136	D5244T4; D5244T5	03.09-07.09	5	DBJ	0 445 110 298	0 986 435 195	
D DRiVe	2,4	129	D5244T14	08.09-07.10	5				F 00V P01 004
D3 AWD, D4 AWD, D5 AWD	2,4	120/133/158/169	D5244T1...; D5244T12; D5244T17; D5244T23	08.11-02.17	5	DBJ	0 445 116 016	0 986 435 393	F 00V P01 004
D4 AWD	2,4	140	D5244T21	08.15-02.17	5	DBJ	0 445 116 016	0 986 435 393	F 00V P01 004
D5 AWD	2,4	151	D5244T10	08.09-07.11	5	DBJ	0 445 116 016	0 986 435 393	F 00V P01 004
		162	D5244T2...	08.15-02.17	5	DBJ	0 445 116 016	0 986 435 393	F 00V P01 004
<b>XC70 I</b>									
2.4 D AWD	2,4	120	D5244T	08.02-07.06	5	DBJ	0 445 110 078	0 986 435 120	
D5 AWD	2,4	136	D5244T4	12.05-07.07	5	DBJ	0 445 110 251	0 986 435 125	
<b>XC70 II</b>									
2.0 D3 DRiVe	2,0	120	D5204T2; D5204T3	08.10-07.15	5	DBJ	0 445 116 045	0 986 435 424	F 00V P01 004
2.4 D AWD	2,4	120	D5244T16	08.09-07.11	5	DBJ	0 445 116 016	0 986 435 393	F 00V P01 004
D AWD, D5 AWD	2,4	120/136	D5244T4; D5244T5	08.07-07.09	5	DBJ	0 445 110 298	0 986 435 195	
D DRiVe	2,4	129	D5244T14	08.09-07.10	5	DBJ	0 445 116 036	0 986 435 408	F 00V P01 004
D3 AWD, D4 AWD	2,4	120/133	D5244T12; D5244T17	08.11-07.16	5	DBJ	0 445 116 016	0 986 435 393	F 00V P01 004
D5 AWD	2,4	151	D5244T10	08.09-07.11	5	DBJ	0 445 116 016	0 986 435 393	F 00V P01 004
		158	D5244T11	08.11-07.15	5	DBJ	0 445 116 016	0 986 435 393	F 00V P01 004
			D5244T15	08.11-07.15	5	DBJ	0 445 116 016	0 986 435 393	F 00V P01 004
		162	D5244T20	08.15-07.16	5	DBJ	0 445 116 016	0 986 435 393	F 00V P90 003
<b>XC90 I</b>									
2.4 D3, D5 AWD	2,4	120/136	D5244T4; D5244T5	05.05-07.15	5	DBJ	0 445 110 251	0 986 435 125	
D5 AWD	2,4	120	D5244T	01.03-07.06	5	DBJ	0 445 110 078	0 986 435 120	

## VW (VOLKSWAGEN)

## Amarok

2.0 BiTDI, BiTDI 4Motion, TDI, TDI 4Motion [2H, S1]	2,0	90-103/120-132	CDBA <D45>; CDCA <D46>	09.10-10.12	4	DBJ	0 445 116 034	0 986 435 369	F 00V P01 004
TDI, TDI 4Motion [S6, S7]	2,0	103	CNFB <D91>	06.16→	4	DBJ	0 445 110 646	0 986 435 166	F 00V P01 004
		132	CNEA <D49>	06.16→	4	DBJ	0 445 110 646	0 986 435 166	F 00V P01 004
								0 986 435 167	



◀ VW

2.0	TDI, TDI 4Motion [S6, S7]	2,0	132	CSHA <D49>	06.16→	4	DBJ	0 445 110 646	0 986 435 166	F 00V P01 004		
									0 986 435 167			
	TDI, TDI 4Motion [2H, S1]	2,0	90	CNFA <D45>	11.11-10.12	4	DBJ	0 445 110 646	0 986 435 166	F 00V P01 004		
				103	CNFB <D91>	06.12-10.16	4	DBJ	0 445 110 646	0 986 435 166	F 00V P01 004	
				132	CNEA <D49>	11.11-10.16	4	DBJ	0 445 110 646	0 986 435 166	F 00V P01 004	
			CSHA <D49>	11.11-10.16	4	DBJ	0 445 110 646	0 986 435 166	F 00V P01 004			
								0 986 435 167				
3.0	TDI, TDI 4Motion [S6, S7]	3,0	120	DDXA <DJ1>	06.16→	6	DBJ	0 445 117 041	0 986 435 441	F 00V P01 009		
	TDI 4Motion [S6, S7]	3,0	150	DDXB <D1Q>	06.16→	6	DBJ	0 445 117 041	0 986 435 441	F 00V P01 009		
				165	DDXC <D4E>	06.16→	6	DBJ	0 445 117 041	0 986 435 441	F 00V P01 009	
TDI 4MOTION [S6, S7]	3,0	165	DDXD <D4E>	03.17→	6	DBJ	0 445 117 041	0 986 435 441	F 00V P01 009			
<b>Arteon</b>												
2.0	TDI [3H7]	2,0	110	DBGA <DN4>	11.17→	4	DBJ	0 445 110 638		F 00V P01 004		
					DFGA <DN4>	03.17→	4	DBJ	0 445 110 468	0 986 435 258	F 00V P01 004	
	TDI, TDI 4Motion [3H7]	2,0	140	DFHA <DE5>	05.17→	4	DBJ	0 445 110 470	0 986 435 257	F 00V P01 004		
TDI 4Motion [3H7]	2,0	176	CUAA <DK9>	03.17→	4	DBJ	0 445 118 002		F 00V P01 004			
<b>Beetle</b>												
2.0	TDI [5C1]	2,0	81	CUUA <DN1>	12.14-06.16	4	DBJ	0 445 110 468	0 986 435 258	F 00V P01 004		
				103	CFFB <D91>	04.12-06.16	4	DBJ	0 445 110 646	0 986 435 166	F 00V P01 004	
										0 986 435 167		
	TDI [5C2]	2,0	110	CUUB <DN4>	12.14-06.16	4	DBJ	0 445 110 468	0 986 435 258	F 00V P01 004		
				81	CUUA <DN1>	07.16→	4	DBJ	0 445 110 468	0 986 435 258	F 00V P01 004	
				110	CUUB <DN4>	07.16→	4	DBJ	0 445 110 468	0 986 435 258	F 00V P01 004	
<b>Beetle Cabriolet</b>												
2.0	TDI [5C7]	2,0	81	CUUA <DN1>	12.14-07.16	4	DBJ	0 445 110 468	0 986 435 258	F 00V P01 004		
				103	CFFB <D91>	01.13-07.16	4	DBJ	0 445 110 646	0 986 435 166	F 00V P01 004	
										0 986 435 167		
	TDI [5C8]	2,0	110	CUUB <DN4>	12.14-07.16	4	DBJ	0 445 110 468	0 986 435 258	F 00V P01 004		
				81	CUUA <DN1>	07.16→	4	DBJ	0 445 110 468	0 986 435 258	F 00V P01 004	
				110	CUUB <DN4>	07.16→	4	DBJ	0 445 110 468	0 986 435 258	F 00V P01 004	
<b>Caddy</b>												
2.0	TDI [SA]	2,0	55	CUUC <DS2>	05.15-12.15	4	DBJ	0 445 110 468	0 986 435 258	F 00V P01 004		
						CUUF <DS2>	05.15-11.15	4	DBJ	0 445 110 468	0 986 435 258	F 00V P01 004
						DFSC <DS2>	11.15→	4	DBJ	0 445 110 468	0 986 435 258	F 00V P01 004
						DFSF <DS2>	11.15→	4	DBJ	0 445 110 468	0 986 435 258	F 00V P01 004
				75	CUUD <MOH>	05.15-11.15	4	DBJ	0 445 110 468	0 986 435 258	F 00V P01 004	
						DFSD <MOH>	11.15→	4	DBJ	0 445 110 468	0 986 435 258	F 00V P01 004
				81	CLCA <D96>	09.15→	4	DBJ	0 445 110 646	0 986 435 166	F 00V P01 004	
										0 986 435 167		
				110	CUUB <DN4>	05.15-11.15	4	DBJ	0 445 110 468	0 986 435 258	F 00V P01 004	
						DFSB <DN4>	11.15→	4	DBJ	0 445 110 468	0 986 435 258	F 00V P01 004
		TDI [2C]	2,0	81	CLCA <D96>	08.10-05.15	4	DBJ	0 445 110 646	0 986 435 166	F 00V P01 004	
										0 986 435 167		
				103/125	CFJA <D93>; CLCB <D91>	05.12-05.15	4	DBJ	0 445 110 646	0 986 435 166	F 00V P01 004	
										0 986 435 167		
	TDI, TDI 4Motion [SA]	2,0	103	CFHC <D91>	05.15→	4	DBJ	0 445 110 646	0 986 435 166	F 00V P01 004		
									0 986 435 167			
	TDI, TDI 4Motion [2C]	2,0	103	CFHC <D91>	11.10-05.15	4	DBJ	0 445 110 646	0 986 435 166	F 00V P01 004		
									0 986 435 167			
					CFHE	11.10-05.15	4	DBJ	0 445 110 646	0 986 435 166	F 00V P01 004	
									0 986 435 167			
TDI 4Motion [SA]	2,0	81	CFHF <D96>	05.15→	4	DBJ	0 445 110 646	0 986 435 166	F 00V P01 004			
								0 986 435 167				
		90	CUUE <DN9>	05.15-11.15	4	DBJ	0 445 110 468	0 986 435 258	F 00V P01 004			
				DFSE <DN9>	11.15→	4	DBJ	0 445 110 468	0 986 435 258	F 00V P01 004		
TDI 4Motion [2C]	2,0	81	CFHF <D96>	08.10-05.15	4	DBJ	0 445 110 646	0 986 435 166	F 00V P01 004			
								0 986 435 167				



CC										
2.0 TDI [358]	2,0	100	CFFA <D94>	11.11-12.16	4	DBJ	0 445 110 646	0 986 435 166	F 00V P01 004	
								0 986 435 167		
		110	CUVC <DN4>	05.15-12.16	4	DBJ	0 445 110 468	0 986 435 258	F 00V P01 004	
		135	CUWA <DK7>	05.15-12.16	4	DBJ	0 445 110 470	0 986 435 257	F 00V P01 004	
TDI, TDI 4Motion [358]	2,0	103	CFFB <D91>	11.11-12.16	4	DBJ	0 445 110 646	0 986 435 166	F 00V P01 004	
								0 986 435 167		
		125	CFGB <D93>	11.11-01.13	4	DBJ	0 445 110 646	0 986 435 166	F 00V P01 004	
								0 986 435 167		
						11.11-12.16	4	DBJ	0 445 110 646	0 986 435 166
		125/130	CFGC <DE2>; CLLA <D93>	01.12-12.16	4	DBJ	0 445 110 646	0 986 435 166	F 00V P01 004	
							0 986 435 167			

Eos										
2.0 TDI [1F7]	2,0	103	CBAB <D91>	05.08-11.10	4	DBJ	0 445 116 029	0 986 435 360	F 00V P01 004	
TDI [1F8]	2,0	100	CFFA <D94>	11.10-08.15	4	DBJ	0 445 110 646	0 986 435 166	F 00V P01 004	
								0 986 435 167		
		103	CFFB <D91>	11.10-08.15	4	DBJ	0 445 110 646	0 986 435 166	F 00V P01 004	
							0 986 435 167			

Golf Alltrack												
1.6 TDI 4Motion [BA5]	1,6	81	CRKB <DK5>; CXXB <DK5>	11.14-03.17	4	DBJ,EU5	0 445 110 476	0 986 435 241	F 00V P01 004			
2.0 GTD 4Motion [BA5]	2,0	135	CUNA <DK7>	12.14-03.17	4	DBJ	0 445 110 470	0 986 435 257	F 00V P01 004			
GTD 4Motion [BV5]	2,0	135	DGCA <DK7>	11.16→	4	DBJ	0 445 110 470	0 986 435 257	F 00V P01 004			
TDI [BV5]	2,0	110	CRLB <DN4>	05.17→	4	DBJ	0 445 110 468	0 986 435 258	F 00V P01 004			
TDI 4Motion [BA5]	2,0	110	CRBC <DN4>	12.14-03.17	4	DBJ,EU5	0 445 110 474	0 986 435 242	F 00V P01 004			
							4	DBJ,EU6	0 445 110 468	0 986 435 258	F 00V P01 004	
				12.14-03.17	4	DBJ,EU5	0 445 110 474	0 986 435 242	F 00V P01 004			
							4	DBJ,EU6	0 445 110 468	0 986 435 258	F 00V P01 004	
TDI 4Motion [BV5]	2,0	110	DCYA <DN4>	11.16→	4	DBJ	0 445 110 468	0 986 435 258	F 00V P01 004			

Golf Plus											
2.0 TDI [521]	2,0	81	CBDC <D96>	01.09-05.10	4	DBJ	0 445 116 029	0 986 435 360	F 00V P01 004		
			CLCA <D96>	05.10-12.13	4	DBJ	0 445 110 646	0 986 435 166	F 00V P01 004		
									0 986 435 167		
			100	CBDA <D94>	01.09-11.09	4	DBJ	0 445 116 029	0 986 435 360	F 00V P01 004	
				CFHB <D94>	11.09-12.13	4	DBJ	0 445 110 646	0 986 435 166	F 00V P01 004	
									0 986 435 167		
		103	CBDB <D91>	01.09-11.09	4	DBJ	0 445 116 029	0 986 435 360	F 00V P01 004		
			CFHC <D91>	11.09-12.13	4	DBJ	0 445 110 646	0 986 435 166	F 00V P01 004		
							0 986 435 167				

Golf Sportsvan													
1.6 TDI [AM1]	1,6	66	CRKA <D36>	02.14-09.14	4	DBJ,EU6	0 445 110 472	0 986 435 259	F 00V P01 004				
				02.14-11.14	4	DBJ,EU5	0 445 110 476	0 986 435 241	F 00V P01 004				
					4	DBJ,EU6	0 445 110 472	0 986 435 259	F 00V P01 004				
				CXXA <D36>	11.14-10.16	4	DBJ,EU5	0 445 110 476	0 986 435 241	F 00V P01 004			
				PR-Code FM1	05.15-10.16	4	DBJ,EU6	0 445 110 472	0 986 435 259				
				66/85	DDYA <DK8>; DDYB <D36>	11.16→	4			F 00V P01 004			
				81	CRKB <DK5>	02.14-09.14	4	DBJ,EU6	0 445 110 472	0 986 435 259	F 00V P01 004		
						02.14-11.14	4	DBJ,EU5	0 445 110 476	0 986 435 241	F 00V P01 004		
							4	DBJ,EU6	0 445 110 472	0 986 435 259	F 00V P01 004		
						CXXB <DK5>	11.14-10.16	4			F 00V P01 004		
						PR-Code FM0	11.14-10.16	4	DBJ,EU5	0 445 110 476	0 986 435 241		
						PR-Code FM1	11.14-10.16	4	DBJ,EU5	0 445 110 472	0 986 435 259		
							05.15-10.16	4	DBJ,EU6	0 445 110 472	0 986 435 259		
						DBKA <DK5>	05.15-11.17	4			F 00V P01 004		
						PR-Code FM0	05.15-11.17	4	DBJ,EU5	0 445 110 476	0 986 435 241		
PR-Code FM1	05.15-11.17	4	DBJ,EU5,	0 445 110 472	0 986 435 259								
			EU6										
2.0 TDI [AM1]	2,0	81	CRLD <DN1>; CRVA <DN1>	05.14-11.17	4	DBJ	0 445 110 474	0 986 435 242	F 00V P01 004				
		81/110	DCYA <DN4>; DCYB <DN1>	11.16→	4	DBJ	0 445 110 468	0 986 435 258	F 00V P01 004				
		110	CRLB <DN4>	02.14-10.16	4	DBJ	0 445 110 468	0 986 435 258	F 00V P01 004				

Golf V Variant										
2.0 TDI [1K5]	2,0	100	CBDA <D94>	07.08-07.09	4	DBJ	0 445 116 029	0 986 435 360	F 00V P01 004	
		103	CBDB <D91>	07.08-07.09	4	DBJ	0 445 116 029	0 986 435 360	F 00V P01 004	







◀ VW

Golf VI												
2.0 TDI [5K1]	2,0	81	CLCA <D96>	05.10-11.12	4	DBJ	0 445 110 646	0 986 435 166	F 00V P01 004			
			81/125	CBBB <D93>; CBDC <D96>	10.08-05.11	4	DBJ	0 445 116 029	0 986 435 360	F 00V P01 004		
			100	CBAA <D94>	10.08-11.09	4	DBJ	0 445 116 029	0 986 435 360	F 00V P01 004		
				CFFA <D94>	11.09-11.12	4	DBJ	0 445 110 646	0 986 435 166	F 00V P01 004		
			103	CJAA <D91>	09.09-11.12	4	DBJ	0 445 116 010	0 986 435 367	F 00V P01 004		
			125	CFGB <D93>	11.09-11.12	4	DBJ	0 445 110 646	0 986 435 166	F 00V P01 004		
			TDI, TDI 4Motion [5K1]	2,0	103	CBAB <D91>	10.08-11.09	4	DBJ	0 445 116 029	0 986 435 360	F 00V P01 004
						CFFB <D91>	11.09-11.12	4	DBJ	0 445 110 646	0 986 435 166	F 00V P01 004
											0 986 435 167	
											0 986 435 167	

Golf VI Cabriolet										
2.0 TDI [517]	2,0	81	CUUA <DN1>	05.15-05.16	4	DBJ	0 445 110 468	0 986 435 258	F 00V P01 004	
			103	CFHC <D91>	11.11-05.16	4	DBJ	0 445 110 646	0 986 435 166	F 00V P01 004
			110	CUUB <DN4>	05.15-05.16	4	DBJ	0 445 110 468	0 986 435 258	F 00V P01 004

Golf VI Variant										
2.0 TDI [AJ5]	2,0	81/100	CFHB <D94>; CLCA <D96>	01.10-04.13	4	DBJ	0 445 110 646	0 986 435 166	F 00V P01 004	
			100	CBDA <D94>	07.09-09.10	4	DBJ	0 445 116 029	0 986 435 360	F 00V P01 004
			103	CBDB <D91>	07.09-04.13	4	DBJ	0 445 116 029	0 986 435 360	F 00V P01 004
				CFHC <D91>	07.09-04.13	4	DBJ	0 445 110 646	0 986 435 166	F 00V P01 004

Golf VII												
1.6 TDI [BQ1]	1,6	66/85	DDYA <DK8>; DDYB <D36>	11.16→	4				F 00V P01 004			
			77	CLHA <D38>	11.16→	4	DBJ	0 445 110 476	0 986 435 241	F 00V P01 004		
TDI [5G1]	1,6	66	CLHB <D36>	04.13-09.14	4	DBJ,EU6	0 445 110 472	0 986 435 259	F 00V P01 004			
				04.13-12.15	4	DBJ,EU5	0 445 110 476	0 986 435 241	F 00V P01 004			
					4	DBJ,EU6	0 445 110 472	0 986 435 259	F 00V P01 004			
			CRKA <D36>	04.13-09.14	4	DBJ,EU6	0 445 110 472	0 986 435 259	F 00V P01 004			
				04.13-12.15	4	DBJ,EU5	0 445 110 476	0 986 435 241	F 00V P01 004			
					4	DBJ,EU6	0 445 110 472	0 986 435 259	F 00V P01 004			
			CXXA <D36>	08.14-03.17	4	DBJ,EU5	0 445 110 476	0 986 435 241	F 00V P01 004			
				PR-Code FM1	05.15-03.17	4	DBJ,EU6	0 445 110 472	0 986 435 259			
			81	DBKA <DK5>	05.15-03.17	4				F 00V P01 004		
				PR-Code FMO	05.15-03.17	4	DBJ,EU5	0 445 110 476	0 986 435 241			
				PR-Code FM1	05.15-03.17	4	DBJ,EU5, EU6	0 445 110 472	0 986 435 259			
			TDI, TDI 4Motion [5G1]	1,6	77	CLHA <D38>	08.12-03.13	4	DBJ	0 445 110 472	0 986 435 259	F 00V P01 004
							08.12-03.17	4	DBJ	0 445 110 472	0 986 435 259	F 00V P01 004
							04.13-09.14	4	DBJ,EU6	0 445 110 472	0 986 435 259	F 00V P01 004
							04.13-03.17	4	DBJ,EU5	0 445 110 476	0 986 435 241	F 00V P01 004
81	CRKB <DK5>	01.13-03.13	4	DBJ	0 445 110 472	0 986 435 259	F 00V P01 004					
				01.13-03.17	4	DBJ	0 445 110 472	0 986 435 259	F 00V P01 004			
				04.13-09.14	4	DBJ,EU6	0 445 110 472	0 986 435 259	F 00V P01 004			
				04.13-03.17	4	DBJ,EU5	0 445 110 476	0 986 435 241	F 00V P01 004			
			CXXB <DK5>	11.14-03.17	4				F 00V P01 004			
			PR-Code FMO	11.14-03.17	4	DBJ,EU5	0 445 110 476	0 986 435 241				
			PR-Code FM1	11.14-03.17	4	DBJ,EU5	0 445 110 472	0 986 435 259				
				05.15-03.17	4	DBJ,EU6	0 445 110 472	0 986 435 259				
2.0 GTD [BQ1]	2,0	135	DGCA <DK7>	11.16→	4	DBJ	0 445 110 470	0 986 435 257	F 00V P01 004			
GTD [5G1]	2,0	135	CUNA <DK7>	04.13-03.17	4	DBJ	0 445 110 470	0 986 435 257	F 00V P01 004			
TDI [BQ1]	2,0	81	CRLD <DN1>	11.16→	4	DBJ	0 445 110 468	0 986 435 258	F 00V P01 004			
			CYKB <DN1>	11.16→	4	DBJ	0 445 110 638		F 00V P01 004			
			DCYB <DN1>	11.16→	4	DBJ	0 445 110 468	0 986 435 258	F 00V P01 004			
			DEJB <DN1>	11.16→	4	DBJ	0 445 110 468	0 986 435 258	F 00V P01 004			
			110	CRBC <DN4>	11.16→	4	DBJ	0 445 110 474	0 986 435 242	F 00V P01 004		
				CRLB <DN4>	11.16→	4	DBJ	0 445 110 468	0 986 435 258	F 00V P01 004		
				DEJA <DN4>	11.16→	4	DBJ	0 445 110 468	0 986 435 258	F 00V P01 004		
			TDI [5G1]	2,0	81	CRVA <DN1>	11.12-03.17	4	DBJ	0 445 110 474	0 986 435 242	F 00V P01 004
						CYKB <DN1>	05.15-03.17	4	DBJ	0 445 110 638		F 00V P01 004



2.0 TDI [5G1]	2,0	81	DEJB <DN1>	05.16-03.17	4	DBJ	0 445 110 474	0 986 435 242	F 00V P01 004					
		105	CRBB <DN6>	08.12-12.15	4				F 00V P01 004					
			CRVC <DN6>	05.14-03.17	4	DBJ,EU4,EU5	0 445 110 474	0 986 435 242	F 00V P01 004					
					4	DBJ,EU6	0 445 110 468	0 986 435 258	F 00V P01 004					
TDI, TDI 4Motion [BQ1]	2,0	110	DCYA <DN4>	11.16→	4	DBJ	0 445 110 468	0 986 435 258	F 00V P01 004					
TDI, TDI 4Motion [5G1]	2,0	110	CRBC <DN4>	11.12-05.15	4	DBJ,EU4,EU5	0 445 110 474	0 986 435 242	F 00V P01 004					
						DBJ,EU6	0 445 110 468	0 986 435 258	F 00V P01 004					
						DBJ,EU4,EU5	0 445 110 474	0 986 435 242	F 00V P01 004					
			CRLB <DN4>	08.12-03.17	4	DBJ,EU6	0 445 110 468	0 986 435 258	F 00V P01 004					
					4	DBJ,EU4,EU5	0 445 110 474	0 986 435 242	F 00V P01 004					
					4	DBJ,EU6	0 445 110 468	0 986 435 258	F 00V P01 004					
TDI, TSI 4Motion [5G1]	2,0	110	DEJA <DN4>	05.16-03.17	4	5PL,DBJ	0 445 110 474	0 986 435 242	F 00V P01 004					
						6PL,DBJ	0 445 110 468	0 986 435 258	F 00V P01 004					
<b>Golf VII Variant</b>														
1.6 TDI [BA5]	1,6	66	CLHB <D36>	05.13-09.14	4	DBJ,EU6	0 445 110 472	0 986 435 259	F 00V P01 004					
							05.13-03.17	4	DBJ,EU5	0 445 110 476	0 986 435 241	F 00V P01 004		
								4	DBJ,EU6	0 445 110 472	0 986 435 259	F 00V P01 004		
							CRKA <D36>	05.13-09.14	4	DBJ,EU6	0 445 110 472	0 986 435 259	F 00V P01 004	
								05.13-12.15	4	DBJ,EU5	0 445 110 476	0 986 435 241	F 00V P01 004	
							CXXA <D36>	11.14-03.17	4	DBJ,EU5	0 445 110 476	0 986 435 241	F 00V P01 004	
							81	DBKA <DK5>	05.15-03.17	4			F 00V P01 004	
								PR-Code FM0	05.15-03.17	4	DBJ,EU5	0 445 110 476	0 986 435 241	F 00V P01 004
								PR-Code FM1	05.15-03.17	4	DBJ,EU5,EU6	0 445 110 472	0 986 435 259	F 00V P01 004
											4			F 00V P01 004
TDI [BV5]	1,6	66/85	DDYA <DK8>; DDYB <D36>	11.16→	4				F 00V P01 004					
TDI, TDI 4Motion [BA5]	1,6	77	CLHA <D38>	05.13-09.14	4	DBJ,EU6	0 445 110 472	0 986 435 259	F 00V P01 004					
							05.13-03.17	4	DBJ,EU5	0 445 110 476	0 986 435 241	F 00V P01 004		
								4	DBJ,EU6	0 445 110 472	0 986 435 259	F 00V P01 004		
							81	CRKB <DK5>	05.13-09.14	4	DBJ,EU6	0 445 110 472	0 986 435 259	F 00V P01 004
									05.13-03.17	4	DBJ,EU5	0 445 110 476	0 986 435 241	F 00V P01 004
					4	DBJ,EU6	0 445 110 472	0 986 435 259	F 00V P01 004					
			CXXB <DK5>	11.14-03.17	4	DBJ,EU5	0 445 110 476	0 986 435 241	F 00V P01 004					
2.0 GTD [BV5]	2,0	135	DGCA <DK7>	11.16→	4	DBJ	0 445 110 470	0 986 435 257	F 00V P01 004					
TDI [BA5]	2,0	81	CRLD <DN1>	11.15-03.17	4	DBJ,EU5	0 445 110 474	0 986 435 242	F 00V P01 004					
							CRVA <DN1>	05.13-03.17	4	DBJ,EU5	0 445 110 474	0 986 435 242	F 00V P01 004	
									4	DBJ,EU6	0 445 110 468	0 986 435 258	F 00V P01 004	
								CYKB <DN1>	05.15-03.17	4	DBJ	0 445 110 638		F 00V P01 004
								DEJB <DN1>	05.16-03.17	4	DBJ	0 445 110 468	0 986 435 258	F 00V P01 004
							105	CRBB <DN6>	05.13-12.15	4				F 00V P01 004
							110	CRBC <DN4>	04.13-03.17	4	DBJ,EU5	0 445 110 474	0 986 435 242	F 00V P01 004
										4	DBJ,EU6	0 445 110 468	0 986 435 258	F 00V P01 004
							135	CUNA <DK7>	11.14-03.17	4	DBJ	0 445 110 470	0 986 435 257	F 00V P01 004
										4	DBJ	0 445 110 468	0 986 435 258	F 00V P01 004
										4	DBJ	0 445 110 638		F 00V P01 004
						TDI [BV5]	2,0	81	CRLD <DN1>	11.16→	4	DBJ	0 445 110 468	0 986 435 258
	CYKB <DN1>	11.16→	4	DBJ	0 445 110 638								F 00V P01 004	
	DCYB <DN1>	11.16→	4	DBJ	0 445 110 468							0 986 435 258	F 00V P01 004	
	DEJB <DN1>	11.16→	4	DBJ	0 445 110 468							0 986 435 258	F 00V P01 004	
	110	CRBC <DN4>	11.16→	4	DBJ							0 445 110 474	0 986 435 242	F 00V P01 004
			11.16→	4	DBJ							0 445 110 468	0 986 435 258	F 00V P01 004
TDI, TDI 4Motion [BA5]	2,0	110	CKFC <DN4>	05.13-12.15	4	DBJ,EU5	0 445 110 474	0 986 435 242	F 00V P01 004					
							CRVA <DN1>	05.13-03.17	4	DBJ,EU5	0 445 110 474	0 986 435 242	F 00V P01 004	
									4	DBJ,EU6	0 445 110 468	0 986 435 258	F 00V P01 004	
								DEJA <DN4>	05.16-03.17	4	DBJ,EU4,EU5	0 445 110 474	0 986 435 242	F 00V P01 004
										4	6PL,DBJ	0 445 110 468	0 986 435 258	F 00V P01 004
										4	DBJ	0 445 110 468	0 986 435 258	F 00V P01 004
<b>Jetta</b>														
2.0 D	2,0	81	CLC	03.10-08.11	4	DBJ	0 445 110 368	0 986 435 166						





◀ VW

2.0 TDI [1K2]	2,0	81	CLCA <D96>	01.10-10.10	4	DBJ	0 445 110 646	0 986 435 166	
								0 986 435 167	
		100	CBDA <D94>	07.08-10.10	4	DBJ	0 445 116 029	0 986 435 360	F 00V P01 004
		103	CBDB <D91>	07.08-10.10	4	DBJ	0 445 116 029	0 986 435 360	F 00V P01 004
		125	CEGA <D93>	07.08-10.10	4	DBJ	0 445 116 029	0 986 435 360	F 00V P01 004
TDI [162]	2,0	103	CFFB <D91>	10.10-07.14	4	DBJ	0 445 110 646	0 986 435 166	F 00V P01 004
								0 986 435 167	
			CFHC <D91>	10.10-07.11	4	DBJ	0 445 110 646	0 986 435 166	F 00V P01 004
							0 986 435 167		
			CLCB <D91>	10.10-07.14	4	DBJ	0 445 110 646	0 986 435 166	F 00V P01 004
							0 986 435 167		
TDI [163]	2,0	81	CLCA <D96>	07.14-12.17	4	DBJ	0 445 110 646	0 986 435 166	F 00V P01 004
								0 986 435 167	
			CUUA <DN1>	07.14-12.17	4	DBJ	0 445 110 468	0 986 435 258	F 00V P01 004
		103	CFFB <D91>	08.14-12.17	4	DBJ	0 445 110 646	0 986 435 166	F 00V P01 004
								0 986 435 167	
			CLCB <D91>	08.14-12.17	4	DBJ	0 445 110 646	0 986 435 166	F 00V P01 004
							0 986 435 167		
		110	CUUB <DN4>	07.14-12.17	4	DBJ	0 445 110 468	0 986 435 258	F 00V P01 004
<b>Passat</b>									
1.6 TDI [3G2]	1,6	88	DCXA <DK5>; DCZA <DN8>	08.14→	4	DBJ	0 445 110 472	0 986 435 259	F 00V P01 004
2.0 TDI [A32]	2,0		CKRA	09.11-08.14	4	DBJ	0 445 110 437	0 986 435 190	F 00V P01 004
TDI [3C2]	2,0	81/105	CBAC <D92>; CBDC <D96>	11.08-11.10	4	DBJ	0 445 116 029	0 986 435 360	F 00V P01 004
		100	CBAA <D94>	05.08-11.09	4	DBJ	0 445 116 029	0 986 435 360	F 00V P01 004
TDI [3G2]	2,0	81	CRLD <DN1>	01.16→	4	DBJ	0 445 110 468	0 986 435 258	F 00V P01 004
		110	DBGA <DN4>	05.15→	4	DBJ	0 445 110 638		F 00V P01 004
			DFGA <DN4>	11.15→	4	DBJ	0 445 110 468	0 986 435 258	F 00V P01 004
		135	CUPA <DK7>	05.15→	4	DBJ	0 445 110 470	0 986 435 257	F 00V P01 004
TDI [362]	2,0	100	CFFA <D94>	08.10-12.14	4	DBJ	0 445 110 646	0 986 435 166	F 00V P01 004
								0 986 435 167	
TDI, TDI 4Motion [3C2]	2,0	103	CBAB <D91>	05.08-07.10	4	DBJ	0 445 116 029	0 986 435 360	F 00V P01 004
				05.08-08.10	4	DBJ	0 445 116 029	0 986 435 360	F 00V P01 004
		125	CBBB <D93>	05.08-07.10	4	DBJ	0 445 116 029	0 986 435 360	F 00V P01 004
TDI, TDI 4Motion [3G2]	2,0	110	CRLB <DN4>	08.14→	4	DBJ	0 445 110 468	0 986 435 258	F 00V P01 004
		140	DDAA <DE5>	11.14→	4	DBJ	0 445 110 470	0 986 435 257	F 00V P01 004
			DFCA <DE5>	05.15→	4	DBJ	0 445 110 470	0 986 435 257	F 00V P01 004
			DFHA <DE5>	08.17→	4	DBJ	0 445 110 470	0 986 435 257	F 00V P01 004
TDI, TDI 4Motion [362]	2,0	103	CFFB <D91>	08.10-12.14	4	DBJ	0 445 110 646	0 986 435 166	F 00V P01 004
								0 986 435 167	
		125	CFGB <D93>	08.10-01.13	4	DBJ	0 445 110 646	0 986 435 166	F 00V P01 004
								0 986 435 167	
				08.10-12.14	4	DBJ	0 445 110 646	0 986 435 166	F 00V P01 004
						0 986 435 167			
		125/130	CFGC <DE2>; CLLA <D93>	11.10-12.14	4	DBJ	0 445 110 646	0 986 435 166	F 00V P01 004
							0 986 435 167		
TDI 4Motion [3G2]	2,0	110	DFEA <DN4>	05.15→	4	DBJ	0 445 110 468	0 986 435 258	F 00V P01 004
			DFGA <DN4>	11.17→	4				F 00V P01 004
			PR-Code 7CN PR-Code 7MM	11.17→	4	DBJ	0 445 110 468	0 986 435 258	
			PR-Code 7MV	11.17→	4	DBJ	0 445 110 470	0 986 435 257	
		176	CUAA <DK9>	08.14→	4	DBJ	0 445 118 002		F 00V P01 004
<b>Passat Alltrack</b>									
2.0 TDI [3G5]	2,0	140	DFHA <DE5>	11.17→	4	DBJ	0 445 110 470	0 986 435 257	F 00V P01 004
TDI, TDI 4Motion [365]	2,0	103/125/130	CFFB <D91>; CFGB <D93>; CFGC <DE2>	01.12-12.14	4	DBJ	0 445 110 646	0 986 435 166	F 00V P01 004
								0 986 435 167	
TDI 4Motion [3G5]	2,0	110	CRLB <DN4>	05.15-05.16	4	DBJ	0 445 110 468	0 986 435 258	F 00V P01 004
			DFEA <DN4>	05.15-11.17	4	DBJ	0 445 110 468	0 986 435 258	F 00V P01 004
			DFGA <DN4>	11.17→	4				F 00V P01 004
			PR-Code 7CN PR-Code 7MM	11.17→	4	DBJ	0 445 110 468	0 986 435 258	
			PR-Code 7MV	11.17→	4	DBJ	0 445 110 470	0 986 435 257	
		135	CUPA <DK7>	05.15→	4	DBJ	0 445 110 470	0 986 435 257	F 00V P01 004
		140	DDAA <DE5>	05.15-11.17	4	DBJ	0 445 110 470	0 986 435 257	F 00V P01 004
	DFCA <DE5>	05.15→	4	DBJ	0 445 110 470	0 986 435 257	F 00V P01 004		
176	CUAA <DK9>	05.15→	4	DBJ	0 445 118 002		F 00V P01 004		



Passat CC									
2.0 TDI [357]	2,0	100	CFFA <D94>	11.10-05.12	4	DBJ	0 445 110 646	0 986 435 166	F 00V P01 004
								0 986 435 167	
TDI, TDI 4Motion [357]	2,0	100/103/105/125	CBAA <D94>; CBAB <D91>; CBAC <D92>; CBBB <D93>	05.08-11.10	4	DBJ	0 445 116 029	0 986 435 360	
		103	CFFB <D91>	11.10-05.12	4	DBJ	0 445 110 646	0 986 435 166	F 00V P01 004
								0 986 435 167	
		125	CFGB <D93>	11.10-05.12	4	DBJ	0 445 110 646	0 986 435 166	F 00V P01 004
								0 986 435 167	
Passat Variant									
1.6 TDI [3G5]	1,6	88	DCXA <DK5>; DCZA <DN8>	11.14→	4	DBJ	0 445 110 472	0 986 435 259	F 00V P01 004
2.0 TDI [3C5]	2,0	81	CBDC <D96>	11.08-11.10	4	DBJ	0 445 116 029	0 986 435 360	F 00V P01 004
		100	CBAA <D94>	01.08-11.09	4	DBJ	0 445 116 029	0 986 435 360	F 00V P01 004
		105	CBAC <D92>	11.08-11.10	4	DBJ	0 445 116 029	0 986 435 360	F 00V P01 004
TDI [3G5]	2,0	110	DBG A <DN4>	05.15→	4	DBJ	0 445 110 638		F 00V P01 004
		135	CUPA <DK7>	05.15→	4	DBJ	0 445 110 470	0 986 435 257	F 00V P01 004
TDI [365]	2,0	100	CFFA <D94>	08.10-05.13	4	DBJ	0 445 110 646	0 986 435 166	F 00V P01 004
								0 986 435 167	
		125	CLLA <D93>	08.10-12.14	4	DBJ	0 445 110 646	0 986 435 166	F 00V P01 004
								0 986 435 167	
TDI, TDI 4Motion [3C5]	2,0	103	CBAB <D91>	01.08-11.10	4	DBJ	0 445 116 029	0 986 435 360	F 00V P01 004
		125	CBBB <D93>	05.08-11.10	4	DBJ	0 445 116 029	0 986 435 360	F 00V P01 004
TDI, TDI 4Motion [3G5]	2,0	81/110	CRLD <DN1>; DFGA <DN4>	11.15→	4	DBJ	0 445 110 468	0 986 435 258	F 00V P01 004
		110	CRLB <DN4>	11.14→	4	DBJ	0 445 110 468	0 986 435 258	F 00V P01 004
		140	DDAA <DE5>	11.14→	4	DBJ	0 445 110 470	0 986 435 257	F 00V P01 004
			DFCA <DE5>	05.15→	4	DBJ	0 445 110 470	0 986 435 257	F 00V P01 004
			DFHA <DE5>	08.17→	4	DBJ	0 445 110 470	0 986 435 257	F 00V P01 004
TDI, TDI 4Motion [365]	2,0	103	CFFB <D91>	08.10-12.14	4	DBJ	0 445 110 646	0 986 435 166	F 00V P01 004
								0 986 435 167	
		125	CFGB <D93>	08.10-01.13	4	DBJ	0 445 110 646	0 986 435 166	F 00V P01 004
								0 986 435 167	
				08.10-12.14	4	DBJ	0 445 110 646	0 986 435 166	F 00V P01 004
								0 986 435 167	
		130	CFGC <DE2>	12.12-12.14	4	DBJ	0 445 110 646	0 986 435 166	F 00V P01 004
								0 986 435 167	
TDI 4Motion [3G5]	2,0	110	DFEA <DN4>	05.15→	4	DBJ	0 445 110 468	0 986 435 258	F 00V P01 004
		176	CUAA <DK9>	08.14→	4	DBJ	0 445 118 002		F 00V P01 004
Phaeton									
3.0 TDI 4Motion [3D]	3,0	165	BMK	09.04-05.07	6	DBJ	0 445 115 051		
		171	CARA	06.07-10.08	6	DBJ	0 445 116 002	0 986 435 377	
		176/180	CEXA <D50>; CEXB <D43>	06.08-03.16	6	DBJ	0 445 116 002	0 986 435 377	F 00V P01 004
Scirocco III									
2.0 TDI [137]	2,0	100	CFHB <D94>	11.10-05.14	4	DBJ	0 445 110 646	0 986 435 166	F 00V P01 004
								0 986 435 167	
		103	CFHC <D91>	11.10-05.14	4	DBJ	0 445 110 646	0 986 435 166	F 00V P01 004
								0 986 435 167	
		103/125	CBBB <D93>; CBDB <D91>	10.08-11.10	4	DBJ	0 445 116 029	0 986 435 360	F 00V P01 004
		125	CFGB <D93>	11.10-01.13	4	DBJ	0 445 110 646	0 986 435 166	F 00V P01 004
								0 986 435 167	
		130	CFGC <DE2>	01.13-05.14	4	DBJ	0 445 110 646	0 986 435 166	F 00V P01 004
								0 986 435 167	
TDI [138]	2,0	110	CUUB <DN4>	05.14-11.17	4	DBJ	0 445 110 470	0 986 435 257	F 00V P01 004
		132	CUXA <DN4>	05.14-11.17	4	DBJ	0 445 110 468	0 986 435 258	F 00V P01 004
		135	CUWA <DK7>	05.14-11.17	4	DBJ	0 445 110 468	0 986 435 258	F 00V P01 004
Sharan									
2.0 TDI [7N1]	2,0	85	CFFE <DE4>	05.11-11.15	4	DBJ	0 445 110 646	0 986 435 166	F 00V P01 004
								0 986 435 167	
		125	CFGB <D93>	08.10-01.13	4	DBJ	0 445 110 646	0 986 435 166	F 00V P01 004
								0 986 435 167	
		130	CFGC <DE2>	01.13-11.15	4	DBJ	0 445 110 646	0 986 435 166	F 00V P01 004
								0 986 435 167	
TDI [7N2]	2,0	85	CUVA <DE4>	05.15-11.15	4	DBJ	0 445 110 468	0 986 435 258	F 00V P01 004
			DFLD <DE4>	11.15→	4	DBJ	0 445 110 468	0 986 435 258	F 00V P01 004





◀ VW

2.0 TDI [7N2]	2,0	135	CUWA <DK7>	05.15-11.15	4	DBJ	0 445 110 470	0 986 435 257	F 00V P01 004
TDI, TDI 4Motion [7N1]	2,0	100	CFFA <D94>	05.10-05.12	4	DBJ	0 445 110 646	0 986 435 166	F 00V P01 004
				05.10-11.15	4	DBJ	0 445 110 646	0 986 435 167	F 00V P01 004
		103	CFFB <D91>	05.10-11.15	4	DBJ	0 445 110 646	0 986 435 166	F 00V P01 004
								0 986 435 167	
TDI, TDI 4Motion [7N2]	2,0	110	CUVC <DN4>	05.15-11.15	4	DBJ	0 445 110 468	0 986 435 258	F 00V P01 004
			DFLA <DN4>	11.15→	4	DBJ	0 445 110 468	0 986 435 258	F 00V P01 004
		135	DFMA <DK7>	11.15→	4	DBJ	0 445 110 470	0 986 435 257	F 00V P01 004

**Tiguan**

1.6 TDI [AD1]	1,6	85	DGDB <DK8>	05.16→	4	DBJ	0 445 110 472	0 986 435 259	F 00V P01 004
2.0 TDI [AD1]	2,0	81	CYKC <DN1>	10.16→	4	DBJ	0 445 110 638		F 00V P01 004
		85	DFGC <DE4>	05.16→	4	DBJ	0 445 110 468	0 986 435 258	F 00V P01 004
TDI [5N1]	2,0	81	CFFD <D96>	05.10-05.11	4	DBJ	0 445 110 646	0 986 435 166	F 00V P01 004
								0 986 435 167	
TDI [5N2]	2,0	81	CFFD <D96>	05.11-12.16	4	DBJ	0 445 110 646	0 986 435 166	F 00V P01 004
								0 986 435 167	
			CUVE <DN1>	05.15-12.16	4	DBJ	0 445 110 468	0 986 435 258	F 00V P01 004
TDI, TDI 4Motion [AD1]	2,0	110	DFGA <DN4>	01.16→	4	DBJ	0 445 110 468	0 986 435 258	F 00V P01 004
TDI, TDI 4Motion [5N1]	2,0	103	CBAB <D91>	11.07-05.11	4	DBJ	0 445 116 029	0 986 435 360	F 00V P01 004
			CFFB <D91>	11.09-05.11	4	DBJ	0 445 110 646	0 986 435 166	F 00V P01 004
								0 986 435 167	
TDI, TDI 4Motion [5N2]	2,0	103	CFFB <D91>	05.11-12.16	4	DBJ	0 445 110 646	0 986 435 166	F 00V P01 004
								0 986 435 167	
		110	CUVC <DN4>	05.15-12.16	4	DBJ	0 445 110 468	0 986 435 258	F 00V P01 004
TDI 4Motion [AD1]	2,0	110	DBGC <DN4>	10.16→	4	DBJ	0 445 110 638		F 00V P01 004
		140	DFHA <DE5>	01.16→	4	DBJ	0 445 110 470	0 986 435 257	F 00V P01 004
		176	CUAA <DK9>	05.16→	4	DBJ	0 445 118 002		F 00V P01 004
TDI 4Motion [BT1]	2,0	110	DBGC <DN4>	10.16→	4	DBJ	0 445 110 638		F 00V P01 004
TDI 4Motion [5N1]	2,0	100	CBAA <D94>	11.07-05.11	4	DBJ	0 445 116 029	0 986 435 360	F 00V P01 004
			CFFA <D94>	05.10-05.11	4	DBJ	0 445 110 646	0 986 435 166	F 00V P01 004
								0 986 435 167	
		103	CLJA <D91>	11.10-05.11	4	DBJ	0 445 110 646	0 986 435 166	F 00V P01 004
								0 986 435 167	
		120	CBBA <D95>	03.08-05.11	4	DBJ	0 445 116 029	0 986 435 360	F 00V P01 004
		125	CBBB <D93>	02.08-05.11	4	DBJ	0 445 116 029	0 986 435 360	F 00V P01 004
			CFGB <D93>	05.10-05.11	4	DBJ	0 445 110 646	0 986 435 166	F 00V P01 004
								0 986 435 167	
TDI 4Motion [5N2]	2,0	100	CFFA <D94>	05.11-12.16	4	DBJ	0 445 110 646	0 986 435 166	F 00V P01 004
								0 986 435 167	
		103	CBAB <D91>	05.11-12.16	4	DBJ	0 445 116 029	0 986 435 360	F 00V P01 004
			CLJA <D91>	05.11-12.16	4	DBJ	0 445 110 646	0 986 435 166	F 00V P01 004
								0 986 435 167	
		125	CFGB <D93>	05.11-05.13	4	DBJ	0 445 110 646	0 986 435 166	F 00V P01 004
								0 986 435 167	
		130	CFGC <DE2>	11.12-12.16	4	DBJ	0 445 110 646	0 986 435 166	F 00V P01 004
								0 986 435 167	
		135	CUWA <DK7>	05.15-12.16	4	DBJ	0 445 110 470	0 986 435 257	F 00V P01 004

**Tiguan Allspace**

2.0 TDI, TDI 4Motion [BW2]	2,0	110	DFGA <DN4>	06.17→	4	DBJ	0 445 110 468	0 986 435 258	F 00V P01 004
TDI 4Motion [BW2]	2,0	110	DBGC <DN4>	06.17→	4	DBJ	0 445 110 638		F 00V P01 004
		140	DFHA <DE5>	06.17→	4	DBJ	0 445 110 470	0 986 435 257	F 00V P01 004
		176	CUAA <DK9>	06.17→	4	DBJ	0 445 118 002		F 00V P01 004

**Touareg**

3.0 TDI [CR7]	3,0	183	CVMD <DD9>	01.18→	6	DBJ	0 445 117 041	0 986 435 441	F 00V P01 009
		190	CVMC <DD7>	01.18→	6	DBJ	0 445 117 041	0 986 435 441	F 00V P01 009
		210	DENA <DV8>	11.17→	6				F 00V P01 009
TDI [7LA]	3,0	155/165	BKS; BUN	11.04-11.06	6	DBJ	0 445 115 051		F 00V P01 004
TDI [7L6]	3,0	155	CASB	11.07-05.10	6	DBJ	0 445 116 022	0 986 435 357	F 00V P01 004
								0 986 435 379	



<b>3.0</b> TDI [7L6]	3,0	155/165	BKS; BUN	12.06-05.08	6	DBJ	<b>0 445 115 051</b>		
		165	CATA	05.09-05.10	6	DBJ	<b>0 445 117 004</b>	<b>0 986 435 382</b>	<b>F 00V P01 004</b>
		176	CASA <D50>	11.07-05.10	6	DBJ	<b>0 445 116 022</b>	<b>0 986 435 357</b>	<b>F 00V P01 004</b>
			CASC	01.08-05.10	6	DBJ	<b>0 445 116 022</b>	<b>0 986 435 357</b>	<b>F 00V P01 004</b>
TDI [7P5]	3,0	150	CASD <D1Q>	11.10-05.11	6	DBJ	<b>0 445 116 022</b>	<b>0 986 435 357</b>	<b>F 00V P01 004</b>
			CJMA	05.11-12.14	6	DBJ	<b>0 445 117 021</b>	<b>0 986 435 413</b>	<b>F 00V P01 009</b>
		176	CASA <D50>	01.10-05.11	6	DBJ	<b>0 445 116 022</b>	<b>0 986 435 357</b>	<b>F 00V P01 004</b>
TDI [7P6]	3,0	150	CRCA <D43>	05.11-12.14	6	DBJ	<b>0 445 117 021</b>	<b>0 986 435 413</b>	<b>F 00V P01 009</b>
			CJMA <D1Q>	08.14→	6	DBJ	<b>0 445 117 021</b>	<b>0 986 435 413</b>	<b>F 00V P01 009</b>
			CVVA <D1Q>	08.14→	6	DBJ,UV2	<b>0 445 117 032</b>	<b>0 986 435 432</b>	<b>F 00V P01 009</b>
					6	6PL,DBJ, EU6	<b>0 445 117 026</b>	<b>0 986 435 453</b>	<b>F 00V P01 009</b>
		180	CRCA <D43>	08.14→	6	DBJ	<b>0 445 117 021</b>	<b>0 986 435 413</b>	<b>F 00V P01 009</b>
TDI 4x4 [7P5]	3,0	165	CATA	09.10-08.12	6	DBJ	<b>0 445 117 004</b>	<b>0 986 435 382</b>	
<b>4.2</b> TDI [7P5]	4,2	250	CKDA <D57>	01.10-12.14	8	DBJ	<b>0 445 117 019</b>	<b>0 986 435 412</b>	<b>F 00V P01 009</b>
TDI [7P6]	4,2	250	CKDA <D57>	08.14→	8	DBJ	<b>0 445 117 019</b>	<b>0 986 435 412</b>	<b>F 00V P01 009</b>
<b>Touran</b>									
<b>1.6</b> TDI [5T1]	1,6	81/85	CRKB <DK5>; DGDA <DK8>	05.15→	4	DBJ	<b>0 445 110 472</b>	<b>0 986 435 259</b>	<b>F 00V P01 004</b>
<b>2.0</b> TDI [1T3]	2,0	81	CLCA <D96>	05.10-05.15	4	DBJ	<b>0 445 110 646</b>	<b>0 986 435 166</b>	<b>F 00V P01 004</b>
								<b>0 986 435 167</b>	
		81/130	CFHF <D96>; CFJB <DE2>	01.13-05.15	4	DBJ	<b>0 445 110 646</b>	<b>0 986 435 166</b>	<b>F 00V P01 004</b>
								<b>0 986 435 167</b>	
		103	CFHC <D91>	05.10-05.15	4	DBJ	<b>0 445 110 646</b>	<b>0 986 435 166</b>	<b>F 00V P01 004</b>
TDI [5T1]	2,0	81	CRVA <DN1>	11.15→	4	5PL,DBJ	<b>0 445 110 474</b>	<b>0 986 435 242</b>	<b>F 00V P01 004</b>
					4	6PL,DBJ	<b>0 445 110 468</b>	<b>0 986 435 258</b>	<b>F 00V P01 004</b>
			CYKB <DN1>	11.15→	4	5PL,DBJ	<b>0 445 110 474</b>	<b>0 986 435 242</b>	<b>F 00V P01 004</b>
					4	6PL,DBJ	<b>0 445 110 468</b>	<b>0 986 435 258</b>	<b>F 00V P01 004</b>
			DFEB <DN1>	02.16-05.16	4	5PL,DBJ	<b>0 445 110 474</b>	<b>0 986 435 242</b>	<b>F 00V P01 004</b>
					4	6PL,DBJ	<b>0 445 110 468</b>	<b>0 986 435 258</b>	<b>F 00V P01 004</b>
			DFGB <DN1>	05.16→	4	5PL,DBJ	<b>0 445 110 474</b>	<b>0 986 435 242</b>	<b>F 00V P01 004</b>
					4	6PL,DBJ	<b>0 445 110 468</b>	<b>0 986 435 258</b>	<b>F 00V P01 004</b>
		110	DFEA <DN4>	05.15-05.16	4	DBJ	<b>0 445 110 468</b>	<b>0 986 435 258</b>	<b>F 00V P01 004</b>
			DFGA <DN4>	05.16→	4	DBJ	<b>0 445 110 468</b>	<b>0 986 435 258</b>	<b>F 00V P01 004</b>
	140	DFHA <DE5>	11.15→	4	DBJ	<b>0 445 110 470</b>	<b>0 986 435 257</b>	<b>F 00V P01 004</b>	
<b>T-Roc</b>									
<b>2.0</b> TDI, TDI 4Motion [A11]	2,0	110	DFFA <DN4>	09.17→	4	DBJ	<b>0 445 110 468</b>	<b>0 986 435 258</b>	<b>F 00V P01 004</b>







**AMUR (AUTOM.AND MOTOR OF URAL)**

<b>10t</b>									
531320	4,8	100	D 245.9 E3 <Euro 3>	01.08→	4	DBJ	<b>0 445 120 141</b>		
<b>11t</b>									
341240	4,8	111,4	D 245.30 E3 <Euro 3>	04.09→	4	DBJ	<b>0 445 120 141</b>		
541340	4,8	111,4	D 245.30 E3 <Euro 3>	04.09→	4	DBJ	<b>0 445 120 141</b>		

**ASTRA**

<b>HD9C-Serie</b>									
HD9	12,9	368	F3HFE611B+						
			Mot.-Nr. →16791	10.15→	6	DBJ	<b>0 445 124 015</b>	<b>0 986 435 663</b>	
			Mot.-Nr. 16792→	10.15→	6	DBJ	<b>0 445 124 036</b>	<b>0 986 435 674</b>	
		412	F3HFE611A+						
			Mot.-Nr. →16791	10.15→	6	DBJ	<b>0 445 124 015</b>	<b>0 986 435 663</b>	
			Mot.-Nr. 16792→	10.15→	6	DBJ	<b>0 445 124 036</b>	<b>0 986 435 674</b>	

**BAW**

<b>Fenix</b>									
1044	3,2	76	CA4DC2-10E3 <Euro 3>	04.08-12.11	4	DBJ	<b>0 445 110 291</b>		
1065	3,2	88	CA4DC2-12E3 <Euro 3>	04.08-12.11	4	DBJ	<b>0 445 110 291</b>		

**CHEVROLET**

<b>Express 2500</b>									
6.6	6,6		LLY	09.05-08.06	8	DBJ	<b>0 445 120 042</b>	<b>0 986 435 521</b>	
				09.06-08.07	8	DBJ	<b>0 445 120 082</b>	<b>0 986 435 520</b>	
<b>Express 3500</b>									
6.6	6,6	187	LLY	09.05-08.06	8	DBJ	<b>0 445 120 042</b>	<b>0 986 435 521</b>	
				09.06-08.07	8	DBJ	<b>0 445 120 082</b>	<b>0 986 435 520</b>	

**CITROEN**

<b>Jumper</b>									
2.0 HDi [U5]	2,0	62	RHV <DW10TD>	02.02-05.06	4	DBB	<b>0 445 110 076</b>	<b>0 986 435 077</b>	
HDi [23]	2,0	62	RHV <DW10TD>	03.01-02.02	4	DBB	<b>0 445 110 076</b>	<b>0 986 435 077</b>	
2.2 HDi [U5]	2,2	74	4HY <DW12TED>	02.02-12.06	4	DBB	<b>0 445 110 076</b>	<b>0 986 435 077</b>	
2.8 HDi [U5]	2,8	94/107	8140 43N <SOFIM 2800 HDi>; 8140.43S	02.02-05.06	4	DBJ	<b>0 445 120 002</b>	<b>0 986 435 501</b>	
HDi [23]	2,8	94	8140.43S	09.00-02.02	4	DBJ	<b>0 445 120 002</b>	<b>0 986 435 501</b>	
HDI	2,8	93	8140.43S	09.05-09.09	4	DBJ	<b>0 445 120 002</b>	<b>0 986 435 501</b>	
3.0 HDi [U6]	3,0	130	F1CE3481E <30 DT PEF EURO5 175>	03.11→	4	DBJ	<b>0 445 116 059</b>	<b>0 986 435 395</b>	
HDi [U9]	3,0	107/115	F1CE3481... <30 DT PEF EURO5 155>; F1CE3481N <30 DT PEF EURO5 145>	01.10→	4	DBJ	<b>0 445 116 059</b>	<b>0 986 435 395</b>	
		116	F1CE0481D <SOFIM F 30DT/ PEF>	06.06-12.11	4	DBJ	<b>0 445 110 248</b>	<b>0 986 435 163</b>	

**DACIA**

<b>Logan Pick-Up</b>									
1.5 dCi [US]	1,5	50/55/63/ 65	K9K 792; K9K 796; K9K 892	01.07-12.14	4		<b>1 987 972 077</b>		





## DAF

CF										
65	.180, .220, .250	5,9	136/162/ 184	CE 136 <Euro3>; CE 162 <Euro3>; CE 184 C <Euro3>	01.01-01.07	6	DBJ	<b>0 445 120 273</b>	<b>0 986 435 571</b>	
	.220, .250	6,7	165/184	GR 165 <Euro 4/5/EEV>; GR 184 <Euro 4/5/EEV>	04.06→	6	DBJ,TW	<b>0 445 120 060</b>	<b>0 986 435 533</b>	
	.280	6,7	210	GR 210 <Euro 4/5>	04.07→	6	DBJ,EU4	<b>0 445 120 060</b>	<b>0 986 435 533</b>	
LF										
45	.130	3,9	99	BE 99 <Euro 3>	11.01-09.06	4	DBJ	<b>0 445 120 273</b>	<b>0 986 435 571</b>	
	.140, .160, .180	4,5	103/118/ 136	FR 103 <Euro 4/5>; FR 118 <Euro 4/5/EEV>; FR 136 <Euro 4/5>	05.06→	4	DBJ,TW	<b>0 445 120 060</b>	<b>0 986 435 533</b>	
	.150	3,9	110	BE 110 C <Euro 3>	04.01-10.07	4	DBJ	<b>0 445 120 273</b>	<b>0 986 435 571</b>	
	.170	3,9	123	BE 123 C <Euro 3>	04.01-12.07	4	DBJ,TW	<b>0 445 120 060</b>	<b>0 986 435 533</b>	
	.180	5,9	136	CE 136 C <Euro 3>	07.01-12.08	6	DBJ	<b>0 445 120 273</b>	<b>0 986 435 571</b>	
	.220	5,9	162	CE 162 C <Euro 3>	11.01-01.09	6	DBJ,TW	<b>0 445 120 060</b>	<b>0 986 435 533</b>	
	.220, .250	6,7	165/184	GR 165 <Euro 4/5/EEV>; GR 184 <Euro 4/5/EEV>	09.06→	6	DBJ,TW	<b>0 445 120 273</b>	<b>0 986 435 571</b>	
55	.180	4,5	136	FR 136 <Euro 4/5>	04.06→	4	DBJ,TW	<b>0 445 120 060</b>	<b>0 986 435 533</b>	
		5,9	136	CE 136 C <Euro 3>	04.01-08.08	6	DBJ	<b>0 445 120 273</b>	<b>0 986 435 571</b>	
	.220	5,9	162	CE 162 C <Euro 3>	04.01-08.08	6	DBJ,TW	<b>0 445 120 060</b>	<b>0 986 435 533</b>	
						6	DBJ,TW	<b>0 445 120 273</b>	<b>0 986 435 571</b>	
	.220, .250, .280	6,7	165/184/ 210	GR 165 <Euro 4/5/EEV>; GR 184 <Euro 4/5/EEV>; GR 210 <Euro 4/5>	04.06→	6	DBJ,TW	<b>0 445 120 060</b>	<b>0 986 435 533</b>	
	.250	5,9	184	CE 184 C <Euro3>	04.01-08.08	6	DBJ,TW	<b>0 445 120 060</b>	<b>0 986 435 533</b>	
						6	DBJ,TW	<b>0 445 120 273</b>	<b>0 986 435 571</b>	

## DODGE

Ram 4500										
6.7		6,7		ETJ	09.09-08.10	6	DBJ,SGJ, V86	<b>0 445 120 204</b>	<b>0 986 435 519</b>	
Sprinter 2500										
2.7 [VA]		2,7	115	OM 612	01.03-12.03	5	DBB	<b>0 445 110 181</b>	<b>0 986 435 053</b>	
3.0 CDI [VB]		3,0	115	EXM	09.06-08.09	6	DBB	<b>0 445 115 061</b>	<b>0 986 435 398</b>	

## FIAT

Ducato Cargo										
2.8 JTD		2,8	93	8140.43S	06.05-08.09	4	DBJ	<b>0 445 120 002</b>	<b>0 986 435 501</b>	
Ducato Maxi 17										
120 Multijet [250]		2,3	88	F1AE0481D <M94>	07.13-12.14	4	DBJ	<b>0 445 110 435</b>	<b>0 986 435 227</b>	
				Mot.-Nr. →1303266	06.06-06.13	4	DBB	<b>0 445 110 273</b>	<b>0 986 435 165</b>	
130 Multijet [250]		2,3	96	F1AE0481N <M95>	07.13-12.14	4	DBJ	<b>0 445 110 435</b>	<b>0 986 435 227</b>	
				Mot.-Nr. →1303266	06.06-06.13	4	DBB	<b>0 445 110 273</b>	<b>0 986 435 165</b>	
160 Multijet [250]		3,0	116	F1CE0481D <M96>	06.06-12.14	4	DBJ	<b>0 445 110 248</b>	<b>0 986 435 163</b>	
Ducato Maxi 20										
120 Multijet [250]		2,3	88	F1AE0481D <M94>	07.13-12.14	4	DBJ	<b>0 445 110 435</b>	<b>0 986 435 227</b>	
				Mot.-Nr. →1303266	06.06-06.13	4	DBB	<b>0 445 110 273</b>	<b>0 986 435 165</b>	
130 Multijet [250]		2,3	96	F1AE0481N <M95>	07.13-12.14	4	DBJ	<b>0 445 110 435</b>	<b>0 986 435 227</b>	
				Mot.-Nr. →1303266	06.06-06.13	4	DBB	<b>0 445 110 273</b>	<b>0 986 435 165</b>	
160 Multijet [250]		3,0	116	F1CE0481D <M96>	06.06-12.14	4	DBJ	<b>0 445 110 248</b>	<b>0 986 435 163</b>	
Ducato Minibus										
2.8 JTD		2,8	93	8140.43S	06.05-08.09	4	DBJ	<b>0 445 120 002</b>	<b>0 986 435 501</b>	
Ducato 10										
2.0 JTD [230]		2,0	63	RHV <M15>	10.01-04.02	4	DBB,KKY	<b>0 445 110 076</b>	<b>0 986 435 077</b>	



◀ FIAT

<b>2.8</b> JTD, JTD EGR, JTD EGR 4x4, JTD 4x4 [230]	2,8	94	8140.43S <M13>; 8140.43S <M14>	08.00-03.02	4	DBJ	<b>0 445 120 002</b>	<b>0 986 435 501</b>	
<b>Ducato 11</b>									
<b>2.0</b> JTD [244]	2,0	62	RHV <M5>	04.02-08.06	4	DBB,KKY	<b>0 445 110 076</b>	<b>0 986 435 077</b>	
<b>2.3</b> JTD [244]	2,3	81	F1AE0481C <M10>	04.02-08.06	4	DBJ	<b>0 445 120 011</b>	<b>0 986 435 506</b>	
			Mot.-Nr. →1303266	01.08-12.11	4	DBB	<b>0 445 110 273</b>	<b>0 986 435 165</b>	
			Mot.-Nr. 1303267→	01.08-12.11	4	DBJ	<b>0 445 110 435</b>	<b>0 986 435 227</b>	
JTD EGR [244]	2,3	81	F1AE0481C <M11>	04.02-08.06	4	DBJ	<b>0 445 120 011</b>	<b>0 986 435 506</b>	
<b>2.8</b> JTD, JTD EGR, JTD EGR 4x4, JTD 4x4 [244]	2,8	94	8140.43S <M15>	04.02-08.06	4	DBJ	<b>0 445 120 002</b>	<b>0 986 435 501</b>	
<b>110</b> Multijet [250]	2,3	83	F1AE3481G	10.11-12.14	4	DBJ	<b>0 445 110 418</b>	<b>0 986 435 212</b>	
								<b>0 986 435 248</b>	
<b>115</b> Multijet [250]	2,0	85	250 A1.000	06.11-12.14	4	DBJ	<b>0 445 110 419</b>	<b>0 986 435 213</b>	<b>F 00V C17 504</b>
<b>120</b> Multijet [250]	2,3	88	F1AE0481D <M94>	07.13-12.14	4	DBJ	<b>0 445 110 435</b>	<b>0 986 435 227</b>	
			Mot.-Nr. →1303266	06.06-06.13	4	DBB	<b>0 445 110 273</b>	<b>0 986 435 165</b>	
<b>130</b> Multijet [250]	2,3	96	F1AE0481N <M95>	07.13-12.14	4	DBJ	<b>0 445 110 435</b>	<b>0 986 435 227</b>	
			Mot.-Nr. →1303266	06.06-06.13	4	DBB	<b>0 445 110 273</b>	<b>0 986 435 165</b>	
			F1AE3481D	06.11-12.14	4	DBJ	<b>0 445 110 418</b>	<b>0 986 435 212</b>	
								<b>0 986 435 248</b>	
<b>150</b> Multijet [250]	2,3	109	F1AE3481E	06.11-12.14	4	DBJ	<b>0 445 110 418</b>	<b>0 986 435 212</b>	
								<b>0 986 435 248</b>	
<b>160</b> Multijet [250]	3,0	116	F1CE0481D <M96>	06.06-12.14	4	DBJ	<b>0 445 110 248</b>	<b>0 986 435 163</b>	
<b>180</b> Multijet [250]	3,0	130	F1CE3481E						
			Mot.-Nr. →1522774	06.11-12.14	4	DBJ	<b>0 445 116 059</b>	<b>0 986 435 395</b>	
<b>Ducato 14</b>									
<b>2.0</b> JTD [230]	2,0	63	RHV <M15>	10.01-03.02	4	DBB,KKY	<b>0 445 110 076</b>	<b>0 986 435 077</b>	
<b>2.8</b> JTD, JTD EGR, JTD EGR 4x4, JTD 4x4 [230]	2,8	94	8140.43S <M13>; 8140.43S <M14>	08.00-03.02	4	DBJ	<b>0 445 120 002</b>	<b>0 986 435 501</b>	
<b>110</b> MultiJet [290]	2,3	83	F1AE3481G	05.14-11.16	4	DBJ,TW	<b>0 445 110 520</b>	<b>0 986 435 212</b>	
								<b>0 986 435 248</b>	
				04.15-11.16	4	DBJ,TW	<b>0 445 110 418</b>	<b>0 986 435 212</b>	
								<b>0 986 435 248</b>	
<b>115</b> MultiJet [290]	2,0	85	250 A1.000; 250 A2.000	05.14→	4	DBJ	<b>0 445 110 419</b>	<b>0 986 435 213</b>	<b>F 00V C17 504</b>
<b>130</b> MultiJet [290]	2,3	96	F1AE3481D	05.14-11.16	4	DBJ,TW	<b>0 445 110 520</b>	<b>0 986 435 212</b>	
								<b>0 986 435 248</b>	
				04.15-11.16	4	DBJ,TW	<b>0 445 110 418</b>	<b>0 986 435 212</b>	
								<b>0 986 435 248</b>	
			F1AGL411...	06.16→	4	DBJ	<b>0 445 110 418</b>	<b>0 986 435 212</b>	
								<b>0 986 435 248</b>	
<b>150</b> EcoJet, MultiJet [290]	2,3	110	F1AGL411A; F1AGL411C	06.15→	4	DBJ	<b>0 445 110 418</b>	<b>0 986 435 212</b>	
								<b>0 986 435 248</b>	
MultiJet [290]	2,3	109	F1AE3481E	05.14-11.16	4	DBJ,TW	<b>0 445 110 520</b>	<b>0 986 435 212</b>	
								<b>0 986 435 248</b>	
				04.15-11.16	4	DBJ,TW	<b>0 445 110 418</b>	<b>0 986 435 212</b>	
								<b>0 986 435 248</b>	
<b>180</b> MultiJet [290]	2,3	130	F1AGL411B	06.16→	4	DBJ	<b>0 445 110 418</b>	<b>0 986 435 212</b>	
								<b>0 986 435 248</b>	
	3,0	130	F1CE3481E	04.15-11.16	4	DBJ	<b>0 445 116 059</b>	<b>0 986 435 395</b>	
<b>Ducato 15</b>									
<b>2.0</b> JTD [244]	2,0	62	RHV <M5>	04.02-08.06	4	DBB,KKY	<b>0 445 110 076</b>	<b>0 986 435 077</b>	
<b>2.3</b> JTD [244]	2,3	81	F1AE0481C <M10>	04.02-08.06	4	DBJ	<b>0 445 120 011</b>	<b>0 986 435 506</b>	
			Mot.-Nr. →1303266	01.08-12.11	4	DBB	<b>0 445 110 273</b>	<b>0 986 435 165</b>	
			Mot.-Nr. 1303267→	01.08-12.11	4	DBJ	<b>0 445 110 435</b>	<b>0 986 435 227</b>	
JTD EGR [244]	2,3	81	F1AE0481C <M11>	04.02-08.06	4	DBJ	<b>0 445 120 011</b>	<b>0 986 435 506</b>	
			Mot.-Nr. →1303266	01.08-12.11	4	DBB	<b>0 445 110 273</b>	<b>0 986 435 165</b>	
			Mot.-Nr. 1303267→	01.08-12.11	4	DBJ	<b>0 445 110 435</b>	<b>0 986 435 227</b>	
<b>2.8</b> JTD, JTD CGV, JTD EGR, JTD EGR 4x4, JTD 4x4 [244]	2,8	94/107	8140.43N <M22>; 8140.43S <M15>	04.02-08.06	4	DBJ	<b>0 445 120 002</b>	<b>0 986 435 501</b>	





<b>120</b> Multijet [250]	2,3	88	F1AE0481D <M94> Mot.-Nr. →1303266	07.13-12.14 06.06-06.13	4 4	DBJ DBB	<b>0 445 110 435</b> <b>0 445 110 273</b>	<b>0 986 435 227</b> <b>0 986 435 165</b>	
<b>130</b> Multijet [250]	2,3	96	F1AE0481N <M95> Mot.-Nr. →1303266	07.13-12.14 06.06-06.13	4 4	DBJ DBB	<b>0 445 110 435</b> <b>0 445 110 273</b>	<b>0 986 435 227</b> <b>0 986 435 165</b>	
<b>160</b> Multijet [250]	3,0	116	F1CE0481D <M96>	06.06-12.14	4	DBJ	<b>0 445 110 248</b>	<b>0 986 435 163</b>	
<b>Ducato 17</b>									
<b>120</b> Multijet [250]	2,3	88	F1AE0481D <M94> Mot.-Nr. →1303266	07.13-12.14 06.06-06.13	4 4	DBJ DBB	<b>0 445 110 435</b> <b>0 445 110 273</b>	<b>0 986 435 227</b> <b>0 986 435 165</b>	
<b>130</b> Multijet [250]	2,3	96	F1AE0481N <M95> Mot.-Nr. →1303266	07.13-12.14 06.06-06.13	4 4	DBJ DBB	<b>0 445 110 435</b> <b>0 445 110 273</b>	<b>0 986 435 227</b> <b>0 986 435 165</b>	
<b>150</b> Multijet [250]	3,0	107	F1CE3481N <M97> Mot.-Nr. →1522774	04.10-12.14	4	DBJ	<b>0 445 116 059</b>	<b>0 986 435 395</b>	
<b>160</b> Multijet [250]	3,0	116	F1CE0481D <M96>	06.06-12.14	4	DBJ	<b>0 445 110 248</b>	<b>0 986 435 163</b>	
<b>Ducato 18</b>									
<b>2.3</b> JTD [244]	2,3	81	F1AE0481C <M10> Mot.-Nr. →1303266 Mot.-Nr. 1303267→	04.02-08.06 01.08-12.11 01.08-12.11	4 4 4	DBJ DBB DBJ	<b>0 445 120 011</b> <b>0 445 110 273</b> <b>0 445 110 435</b>	<b>0 986 435 506</b> <b>0 986 435 165</b> <b>0 986 435 227</b>	
JTD EGR [244]	2,3	81	F1AE0481C <M11> Mot.-Nr. →1303266 Mot.-Nr. 1303267→	01.08-12.11 01.08-12.11	4 4	DBB DBJ	<b>0 445 110 273</b> <b>0 445 110 435</b>	<b>0 986 435 165</b> <b>0 986 435 227</b>	
<b>2.8</b> JTD, JTD CGV, JTD EGR, JTD EGR 4x4, JTD 4x4 [244]	2,8	94/107	8140.43N <M22>; 8140.43S <M15>	04.02-08.06	4	DBJ	<b>0 445 120 002</b>	<b>0 986 435 501</b>	
JTD, JTD EGR, JTD EGR 4x4, JTD 4x4 [230]	2,8	94	8140.43S <M13>; 8140.43S <M14>	08.00-03.02	4	DBJ	<b>0 445 120 002</b>	<b>0 986 435 501</b>	
<b>Ducato 20</b>									
<b>150</b> Multijet [250]	3,0	107	F1CE3481N <M97> Mot.-Nr. →1522774	09.10-12.14	4	DBJ	<b>0 445 116 059</b>	<b>0 986 435 395</b>	
<b>160</b> Multijet [250]	3,0	115	F1CE3481M <M99> Mot.-Nr. →1522774	09.10-12.14	4	DBJ	<b>0 445 116 059</b>	<b>0 986 435 395</b>	

FORD

**Cargo**

<b>1830</b>	7,3	221	ECOTORQ 300 <Euro 3>	08.03-11.06	6	DBJ	<b>0 445 120 025</b>	<b>0 986 435 625</b>
<b>2524</b>	7,3	176	ECOTORQ 240 <Euro 3>	08.03-11.06	6	DBJ	<b>0 445 120 025</b>	<b>0 986 435 625</b>
<b>2530</b>	7,3	221	ECOTORQ 300 <Euro 3>	08.03-11.06	6	DBJ	<b>0 445 120 025</b>	<b>0 986 435 625</b>
<b>3230</b>	7,3	221	ECOTORQ 300 <Euro 3>	08.03-11.06	6	DBJ	<b>0 445 120 025</b>	<b>0 986 435 625</b>

**Transit Connect**

<b>1.5</b> TDCi [13]	1,5	55	XUGA <Euro 6>	06.15→	4	DBJ	<b>0 445 110 488</b>	<b>0 986 435 288</b>	<b>F 00V C17 504</b>
		74	XVG... <Euro 6>	06.15→	4	DBJ	<b>0 445 110 488</b>	<b>0 986 435 288</b>	<b>F 00V C17 504</b>
			XXGA <Euro 6>	03.16→	4	DBJ	<b>0 445 110 488</b>	<b>0 986 435 288</b>	<b>F 00V C17 504</b>
		88	XWG... <Euro 6>	06.15→	4	DBJ	<b>0 445 110 488</b>	<b>0 986 435 288</b>	<b>F 00V C17 504</b>

**Transit Courier**

<b>1.5</b> TDCi [14]	1,5	55	UGC... <Euro 5>	04.14-12.17	4	DBJ	<b>0 445 110 488</b>	<b>0 986 435 288</b>	<b>F 00V C17 504</b>
			XUC... <Euro 6>	06.15→	4	DBJ	<b>0 445 110 488</b>	<b>0 986 435 288</b>	<b>F 00V C17 504</b>
		70	XVC... <Euro 6>	06.15→	4	DBJ	<b>0 445 110 488</b>	<b>0 986 435 288</b>	<b>F 00V C17 504</b>
		1,6	70	T3C... <Euro 5>	04.14-12.17	4	DBJ	<b>0 445 110 488</b>	<b>0 986 435 288</b>

GALICH CRANE PLANT

**50t**

<b>KS-64713-2</b>	11,1	303	650.10 <Euro 3>	01.10→	6	DBJ	<b>0 445 120 142</b>
-------------------	------	-----	-----------------	--------	---	-----	----------------------



## GAZ

GAZelle									
2.7 TD	2,7	80	ADCR110 <Euro 4>	01.07-03.13	4	DBJ	0 445 110 312		
[2705,3221,3302]									
2.8 TD	2,8	102,7	ISF 2.8s3148T <Euro 3>	08.10-03.13	4	DBJ	0 445 110 376		
[2705,3221,3302]									
TD	2,8	88,3	ISF 2.8s3129T <Euro 3>	08.10-03.13	4	DBJ	0 445 110 376		
[3705,3221,3302]									
GAZon									
4.8 TD [3309]	4,8	90	D 245.7 E3 <Euro 3>	01.08→	4	<del>DBJ</del>	0 445 120 141		
		90-92,2	D 245.7 E4 <Euro 4>	12.11→	4	<del>DBJ</del>	0 445 120 245		
Sadko									
4.8 TD [3308]	4,8	87-90	D 245.7 E3 <Euro 3>	01.08→	4	<del>DBJ</del>	0 445 120 141		
		90	D 245.7 E4 <Euro 4>	12.11→	4	<del>DBJ</del>	0 445 120 245		
Sobol									
2.8 TD	2,8	88,3/102,	ISF 2.8s3129T <Euro 3>;	08.10→	4	DBJ	0 445 110 376		
[2217,2310,2752]									
		7	ISF 2.8s3148T <Euro 3>						
Valday									
3.8 TD [3310]	3,8	125	ISF 3.8 <Euro 3>	12.11→	4	DBJ	0 445 120 134		
4.8 TD [3310]	4,8	90	D 245.7 E3 <Euro 3>	01.08→	4	<del>DBJ</del>	0 445 120 141		
		90-92,2	D 245.7 E4 <Euro 4>	12.11→	4	<del>DBJ</del>	0 445 120 245		

## GREAT WALL

Wingle									
2.8 D	2,8	70	GW2.8TC_EU3	06.07-09.09	4	DBJ	0 445 110 293		

## HEULIEZ

Access` Bus GX									
427	7,8	280	F2CFE612C <EEV>	09.07-12.13	6	DBJ,TW	0 445 120 054	0 986 435 545	
					6	<del>DBJ,TW</del>	0 445 120 157	0 986 435 564	
GX Acces Bus									
127, 127 L	5,9	194	F4AE3682 <EEV>	06.09→	6	DBJ	0 445 120 346	0 986 435 662	
GX Access Bus									
127, 127 L	5,9	160	F4AE3682 <Euro 4/5>	03.06→	6	DBJ	0 445 120 346	0 986 435 662	
Serie GX									
Access` Bus 137, 137 L,	6,7	184/210-	F4AFE612F <Tector 7 - Euro 6>	09.15→	6	DBJ	0 445 120 346	0 986 435 662	
337, 337 L									
437, 437 L	8,7	265/294	F2CFE612A <Cursor 9 - Euro 6>;	09.15→	6	<del>DBJ</del>	0 445 120 157	0 986 435 564	
F2CFE612B <Cursor 9 - Euro 6>									

## HYUNDAI

H-1									
2.5 CRDi	2,5	81/103	D4CB	12.01-12.06	4	DBJ	0 445 110 091	0 986 435 154	
				01.07-12.07	4	DBJ,N25	0 445 110 279	0 986 435 182	
					4	DBJ,N25	0 445 110 277	0 986 435 181	
H-1 Cargo									
2.5 CRDi	2,5	81-85	D4CB <(6A) A25/(6B) A25B>	12.08→	4	DBJ,MG5,	0 445 110 274	0 986 435 180	MG5 F 00V C17 504
					4	DBJ,MG5,	0 445 110 277	0 986 435 181	MG5 F 00V C17 504
					4	DBJ,MG5,	0 445 110 274	0 986 435 180	MG5 F 00V C17 504
					4	DBJ,MG5,	0 445 110 277	0 986 435 181	MG5 F 00V C17 504
		100	D4CB... <(6A) A25/(6B) A25B>	12.08→	4	DBJ,MG5,	0 445 110 274	0 986 435 180	MG5 F 00V C17 504
					4	DBJ,MG5,	0 445 110 277	0 986 435 181	MG5 F 00V C17 504



2.5 CRDi	2,5	120-125	D4CB... <(6A) A25>	03.08→	4	DBJ, MG5, TW	0 445 110 274	0 986 435 180	MG5	F 00V C17 504
					4	DBJ, MG5, TW	0 445 110 277	0 986 435 181	MG5	F 00V C17 504

**H-1 Travel**

2.5 CRDi	2,5	81-85/ 100/120- 125	D4CB <(6A) A25>; D4CB... <(6A) A25/(6B) A25B>; D4CB <(6A) A25/(6B) A25B>	03.08→	4	DBJ, MG5, TW	0 445 110 274	0 986 435 180	MG5	F 00V C17 504
					4	DBJ, MG5, TW	0 445 110 277	0 986 435 181	MG5	F 00V C17 504

**H100**

2.5 CRDi	2,5	95	D4CB <(6A) A25/(6B) A25B>	01.09-12.11	4	DBJ, EUR6	0 445 110 277	0 986 435 181	EUR6	F 00V C17 504
----------	-----	----	---------------------------	-------------	---	-----------	---------------	---------------	------	---------------

**Starex**

2.5 CRDi	2,5	103	D4CB	10.02-05.04	4	DBJ	0 445 110 091	0 986 435 154		F 00V C17 504
				10.02-01.07	4	DBJ	0 445 110 091	0 986 435 154		F 00V C17 504
				06.04-01.07	4	DBJ	0 445 110 279	0 986 435 182		F 00V C17 504
		107	D4CB	01.02-11.03	4	DBJ	0 445 110 091	0 986 435 154		
				12.03-05.07	4	DBJ	0 445 110 279	0 986 435 182		

**IRISBUS****Proway**

5,9	160	F4AE3681 <Euro 4/5>	06.06-12.13	6	DBJ	0 445 120 054	0 986 435 545
-----	-----	---------------------	-------------	---	-----	---------------	---------------

**IVECO****CityClass**

2.8 D	2,8	92	8140.43S	10.05-07.07	4	DBJ	0 445 120 002	0 986 435 501
45 S 17	3,0	125	F1C DS <Euro 5 / P-7 (EGR)>	10.12→	4	DBJ	0 445 116 059	0 986 435 395
55 S 17	3,0	125	F1C DS <Euro 5 / P-7 (EGR)>	10.12→	4	DBJ	0 445 116 059	0 986 435 395

**Crossway**

6.7	6,7	210/235	F4AFE612D <Tector 7 - Euro 6>; F4AFE612F <Tector 7 - Euro 6>	07.14→	6	DBJ	0 445 120 346	0 986 435 662
8.7	8,7	265/294	F2CFE612A <Cursor 9 - Euro 6>; F2CFE612B <Cursor 9 - Euro 6>	07.14→	6	DBJ	0 445 120 157	0 986 435 564

**Crossway LE**

6.7	6,7	210/235	F4AFE612D <Tector 7 - Euro 6>; F4AFE612F <Tector 7 - Euro 6>	07.14→	6	DBJ	0 445 120 346	0 986 435 662
8.7	8,7	265/294	F2CFE612A <Cursor 9 - Euro 6>; F2CFE612B <Cursor 9 - Euro 6>	07.14→	6	DBJ	0 445 120 157	0 986 435 564

**Daily**

29 L 9, 13 [00]	2,8	66/92	8140.43R.43...; 8140.43S	10.00-03.06	4	DBJ	0 445 120 002	0 986 435 501
10 [06]	2,3	71	F1AE0481F*... Fg.-Nr. →1303265 Fg.-Nr. 1303266→	04.06-12.11	4	DBB	0 445 110 273	0 986 435 165
				04.06-12.11	4	DBJ	0 445 110 435	0 986 435 227
10, 12, 14 [00]	2,3	70/85/ 100	F1AE0481A...; F1AE0481B...; F1AE0481M..	09.02-03.06	4	DBJ	0 445 120 011	0 986 435 506
11 [12]	2,3	78	F1AE3481A*A0...	07.11-07.14	4	DBJ, TW	0 445 110 418	0 986 435 212
								0 986 435 248
					4	DBJ, TW	0 445 116 059	0 986 435 395
12 [06]	2,3	85	F1AE0481G*... Fg.-Nr. →1303265 Fg.-Nr. 1303266→	04.06-12.11	4	DBB	0 445 110 273	0 986 435 165
				04.06-12.11	4	DBJ	0 445 110 435	0 986 435 227
13 [12]	2,3	93	F1AE3481B*A0...	07.11-07.14	4	DBJ, TW	0 445 110 418	0 986 435 212
								0 986 435 248
					4	DBJ, TW	0 445 116 059	0 986 435 395
14 [06]	2,3	100	F1AE0481H*... Fg.-Nr. →1303265 Fg.-Nr. 1303266→	04.06-12.11	4	DBB	0 445 110 273	0 986 435 165
				04.06-12.11	4	DBJ	0 445 110 435	0 986 435 227
15 [12]	2,3	146	F1AE3481C..	07.11-07.14	4	DBJ, TW	0 445 110 418	0 986 435 212
								0 986 435 248
					4	DBJ, TW	0 445 116 059	0 986 435 395







◀ IVECO

<b>30 S</b> 18 [14]	3,0	132	F1CFL411W <Euro 6>	07.17→	4	DBJ	<b>0 445 110 564</b>	<b>0 986 435 255</b>	<b>F 00V D38 010</b>
<b>33 S</b> 11, 13, 15 [14]	2,3	78/93/ 107	F1AFL411A*A; F1AFL411B*A; F1AFL411C*A	05.14→	4	DBJ	<b>0 445 110 418</b>	<b>0 986 435 212</b> <b>0 986 435 248</b>	
<b>33-120</b> [16]	2,3	85	F1AGL411H <Euro 6>	07.16→	4	DBJ	<b>0 445 110 418</b>	<b>0 986 435 212</b> <b>0 986 435 248</b>	
<b>33-140</b> [16]	2,3	100	F1AGL411J <Euro 6>	07.16→	4	DBJ	<b>0 445 110 418</b>	<b>0 986 435 212</b> <b>0 986 435 248</b>	
<b>33-160</b> [16]	2,3	110-114,6	F1AGL411... <Euro 6>	07.16→	4	DBJ	<b>0 445 110 418</b>	<b>0 986 435 212</b> <b>0 986 435 248</b>	
<b>35</b> 13	2,8	92	8140.43S	10.05-07.07	4	<del>DBJ</del>	<b>0 445 120 002</b>	<b>0 986 435 501</b>	
<b>35 C</b> 9, 11, 13, 15 [00]	2,8	66/78/92/ 108	8140.43B.43...; 8140.43N.43...; 8140.43R...; 8140.43S...	05.99-09.04	4	<del>DBJ</del>	<b>0 445 120 002</b>	<b>0 986 435 501</b>	
10 [06]	2,3	71	F1AE0481F*B... Fg.-Nr. →1303265 Fg.-Nr. 1303266→	04.06-12.11 04.06-12.11	4	DBB DBJ	<b>0 445 110 273</b> <b>0 445 110 435</b>	<b>0 986 435 165</b> <b>0 986 435 227</b>	
10, 12, 14 [00]	2,3	70/85/ 100	F1AE0481A*A; F1AE0481B*A; F1AE0481M..	09.02-03.06	4	<del>DBJ</del>	<b>0 445 120 011</b>	<b>0 986 435 506</b>	
11 [09]	2,3	78	F1AE0481U*... Fg.-Nr. →1303265 Fg.-Nr. 1303266→	06.09-12.11 06.09-12.11	4	DBB DBJ	<b>0 445 110 273</b> <b>0 445 110 435</b>	<b>0 986 435 165</b> <b>0 986 435 227</b>	
11 [12]	2,3	78	F1AE3481A*A0... Fg.-Nr. →1303265 Fg.-Nr. 1303266→	07.11-07.14 04.06-12.11	4	DBJ DBJ	<b>0 445 110 418</b> <b>0 445 110 435</b>	<b>0 986 435 212</b> <b>0 986 435 227</b>	
11, 13, 15 [14]	2,3	78/93/ 107	F1AFL411A*A; F1AFL411B*A; F1AFL411C*A	05.14→	4	DBJ	<b>0 445 110 418</b>	<b>0 986 435 212</b> <b>0 986 435 248</b>	
12 [06]	2,3	85	F1AE0481G*... Fg.-Nr. →1303265 Fg.-Nr. 1303266→	04.06-12.11 04.06-12.11	4	DBB DBJ	<b>0 445 110 273</b> <b>0 445 110 435</b>	<b>0 986 435 165</b> <b>0 986 435 227</b>	
13 [09]	2,3	93	F1AE0481R.. Fg.-Nr. →1303265 Fg.-Nr. 1303266→	04.06-12.11 04.06-12.11	4	DBB DBJ	<b>0 445 110 273</b> <b>0 445 110 435</b>	<b>0 986 435 165</b> <b>0 986 435 227</b>	
13 [09]	2,3	93	F1AE0481V*... Fg.-Nr. →1303265 Fg.-Nr. 1303266→	06.09-12.11 06.09-12.11	4	DBB DBJ	<b>0 445 110 273</b> <b>0 445 110 435</b>	<b>0 986 435 165</b> <b>0 986 435 227</b>	
13, 15 [12]	2,3	93/107	F1AE3481B*A0...; F1AE3481C*A034	07.11-07.14	4	DBJ,TW	<b>0 445 110 418</b>	<b>0 986 435 212</b> <b>0 986 435 248</b>	
14 [06]	2,3	100	F1AE0481H.. Fg.-Nr. →1303265 Fg.-Nr. 1303266→	06.09-12.11 04.06-12.11	4	<del>DBJ</del> ,TW	<b>0 445 116 059</b>	<b>0 986 435 395</b>	
14 [06]	2,3	100	F1AE0481H.. Fg.-Nr. →1303265 Fg.-Nr. 1303266→	04.06-05.09 04.06-05.09	4	DBB DBJ	<b>0 445 110 273</b> <b>0 445 110 435</b>	<b>0 986 435 165</b> <b>0 986 435 227</b>	
14 [09]	3,0	103	F1CE3481L*C.. Fg.-Nr. →1303265 Fg.-Nr. 1303266→	06.09-12.11 04.06-12.11	4	DBJ,TW	<b>0 445 110 418</b>	<b>0 986 435 212</b> <b>0 986 435 248</b>	
14, 17 [00]	3,0	100/122	F1CE0481A...; F1CE0481B	09.04-03.06	4	<del>DBJ</del>	<b>0 445 116 059</b>	<b>0 986 435 395</b>	
15 [14]	3,0	107	F1CFL411E*C	09.04-03.06	4	<del>DBJ</del>	<b>0 445 120 036</b>	<b>0 986 435 507</b>	
15, 17 [12]	3,0	107/125	F1CFL411E*C	05.14→	4	DBJ	<b>0 445 110 564</b>	<b>0 986 435 255</b>	<b>F 00V D38 010</b>
15, 17 [12]	3,0	107/125	F1CE3481... Fg.-Nr. →1303265 Fg.-Nr. 1303266→	07.11-07.14 04.06-12.11	4	DBJ,TW	<b>0 445 110 418</b>	<b>0 986 435 212</b> <b>0 986 435 248</b>	
15, 17, 21 [14]	3,0	107/125/ 150	F1CFL411G*C; F1CFL411H*C; F1CFL411J*C	07.11-07.14	4	<del>DBJ</del> ,TW	<b>0 445 116 059</b>	<b>0 986 435 395</b>	
15, 17, 21 [14]	3,0	107/125/ 150	F1CFL411G*C; F1CFL411H*C; F1CFL411J*C	05.14→	4	<del>DBJ</del>	<b>0 445 116 059</b>	<b>0 986 435 395</b>	
15, 18 [06]	3,0	107/130	F1CE0481F*...; F1CE0481H*...	04.06-12.11	4	<del>DBJ</del>	<b>0 445 110 248</b>	<b>0 986 435 163</b>	
17 [09]	3,0	125	F1CE3481C*... Fg.-Nr. →1303265 Fg.-Nr. 1303266→	06.09-12.11 04.06-12.11	4	DBJ,TW	<b>0 445 110 418</b>	<b>0 986 435 212</b> <b>0 986 435 248</b>	
17 [14]	3,0	125	F1CFL411F*C	06.09-12.11	4	<del>DBJ</del> ,TW	<b>0 445 116 059</b>	<b>0 986 435 395</b>	
21 [12]	3,0	150	F1CE3481D*B13... Fg.-Nr. →1303265 Fg.-Nr. 1303266→	05.14→ 04.06-12.11	4	DBJ	<b>0 445 110 564</b>	<b>0 986 435 255</b>	<b>F 00V D38 010</b>
21 [12]	3,0	150	F1CE3481D*B13... Fg.-Nr. →1303265 Fg.-Nr. 1303266→	07.11-07.14 04.06-12.11	4	DBJ,TW	<b>0 445 110 418</b>	<b>0 986 435 212</b> <b>0 986 435 248</b>	
21 [12]	3,0	150	F1CE3481D*B13... Fg.-Nr. →1303265 Fg.-Nr. 1303266→	07.11-07.14 04.06-12.11	4	<del>DBJ</del> ,TW	<b>0 445 116 059</b>	<b>0 986 435 395</b>	
<b>35 S</b> 9, 11, 13, 15 [00]	2,8	66/78/92/ 108	8140.43B.43...; 8140.43N.43...; 8140.43R...; 8140.43S...;	05.99-09.06	4	<del>DBJ</del>	<b>0 445 120 002</b>	<b>0 986 435 501</b>	
10 [06]	2,3	71	F1AE0481F*... Fg.-Nr. →1303265 Fg.-Nr. 1303266→	04.06-12.11 04.06-12.11	4	DBB DBJ	<b>0 445 110 273</b> <b>0 445 110 435</b>	<b>0 986 435 165</b> <b>0 986 435 227</b>	





<b>35 S</b> 10, 12, 14 [00]	2,3	70/85/ 100	F1AE0481A*; F1AE0481B...; F1AE0481M..	09.02-03.06	4	DBJ	<b>0 445 120 011</b>	<b>0 986 435 506</b>	
11 [09]	2,3	78	F1AE0481U*... Fg.-Nr. →1303265 Fg.-Nr. 1303266→	06.09-12.11 06.09-12.11	4	DBB DBJ	<b>0 445 110 273</b> <b>0 445 110 435</b>	<b>0 986 435 165</b> <b>0 986 435 227</b>	
11 [12]	2,3	78	F1AE3481A..	07.11-07.14	4	DBJ,TW	<b>0 445 110 418</b>	<b>0 986 435 212</b> <b>0 986 435 248</b>	
					4	DBJ,TW	<b>0 445 116 059</b>	<b>0 986 435 395</b>	
11, 15 [14]	2,3	78/107	F1AFL411A*; F1AFL411C*A	05.14→	4	DBJ	<b>0 445 110 418</b>	<b>0 986 435 212</b> <b>0 986 435 248</b>	
12 [06]	2,3	85	F1AE0481G... Fg.-Nr. →1303265 Fg.-Nr. 1303266→ F1AE0481R.. Fg.-Nr. →1303265 Fg.-Nr. 1303266→	04.06-05.09 04.06-05.09	4	DBB DBJ	<b>0 445 110 273</b> <b>0 445 110 435</b>	<b>0 986 435 165</b> <b>0 986 435 227</b>	
				04.06-12.11 04.06-12.11	4	DBB DBJ	<b>0 445 110 273</b> <b>0 445 110 435</b>	<b>0 986 435 165</b> <b>0 986 435 227</b>	
13 [09]	2,3	93	F1AE0481V*... Fg.-Nr. →1303265 Fg.-Nr. 1303266→	06.09-12.11 06.09-12.11	4	DBB DBJ	<b>0 445 110 273</b> <b>0 445 110 435</b>	<b>0 986 435 165</b> <b>0 986 435 227</b>	
13 [12]	2,3	93	F1AE3481B*AO...	07.11-07.14	4	DBJ,TW	<b>0 445 110 418</b>	<b>0 986 435 212</b> <b>0 986 435 248</b>	
					4	DBJ,TW	<b>0 445 116 059</b>	<b>0 986 435 395</b>	
13 [14]	2,3	93	F1AFL411B*A	05.14→	4	DBJ,TW	<b>0 445 110 418</b>	<b>0 986 435 212</b> <b>0 986 435 248</b>	
					4	DBJ,TW	<b>0 445 110 520</b>	<b>0 986 435 212</b> <b>0 986 435 248</b>	
14	3,0	100	F1CE0481 <Euro 3>	08.07-03.12	4	DBJ	<b>0 445 110 248</b>	<b>0 986 435 163</b>	
14 [06]	2,3	100	F1AE0481H*... Fg.-Nr. →1303265 Fg.-Nr. 1303266→	04.06-12.11 04.06-12.11	4	DBB DBJ	<b>0 445 110 273</b> <b>0 445 110 435</b>	<b>0 986 435 165</b> <b>0 986 435 227</b>	
14 [09]	3,0	103	F1CE3481L*C..	06.09-12.11	4	DBJ,TW	<b>0 445 110 418</b>	<b>0 986 435 212</b> <b>0 986 435 248</b>	
					4	DBJ,TW	<b>0 445 116 059</b>	<b>0 986 435 395</b>	
14, 17 [00]	3,0	100/122	F1CE0481A..; F1CE0481B	09.04-03.06	4	DBJ	<b>0 445 120 036</b>	<b>0 986 435 507</b>	
15 [12]	2,3	107	F1AE3481C..	07.11-07.14	4	DBJ,TW	<b>0 445 110 418</b>	<b>0 986 435 212</b> <b>0 986 435 248</b>	
					4	DBJ,TW	<b>0 445 116 059</b>	<b>0 986 435 395</b>	
15 [14]	3,0	107	F1CFL411E*C	05.14→	4	DBJ	<b>0 445 110 564</b>	<b>0 986 435 255</b>	<b>F 00V D38 010</b>
15, 17 [12]	3,0	107/125	F1CE3481...	07.11-07.14	4	DBJ,TW	<b>0 445 110 418</b>	<b>0 986 435 212</b> <b>0 986 435 248</b>	
					4	DBJ,TW	<b>0 445 116 059</b>	<b>0 986 435 395</b>	
15, 17, 21 [14]	3,0	107/125/ 150	F1CFL411G*C; F1CFL411H*C; F1CFL411J*C	05.14→	4	DBJ	<b>0 445 116 059</b>	<b>0 986 435 395</b>	
15, 18 [06]	3,0	107/130	F1CE0481...; F1CE0481H*...	04.06-12.11	4	DBJ	<b>0 445 110 248</b>	<b>0 986 435 163</b>	
17 [09]	3,0	125	F1CE3481C*...	06.09-12.11	4	DBJ,TW	<b>0 445 110 418</b>	<b>0 986 435 212</b> <b>0 986 435 248</b>	
					4	DBJ,TW	<b>0 445 116 059</b>	<b>0 986 435 395</b>	
17 [14]	3,0	125	F1CFL411F*C	05.14→	4	DBJ	<b>0 445 110 564</b>	<b>0 986 435 255</b>	<b>F 00V D38 010</b>
18 [09]	3,0	130	F1CE3481H..	11.10-12.11	4	DBJ	<b>0 445 110 248</b>	<b>0 986 435 163</b>	
21 [12]	3,0	150	F1CE3481D..	07.11-07.14	4	DBJ,TW	<b>0 445 110 418</b>	<b>0 986 435 212</b> <b>0 986 435 248</b>	
					4	DBJ,TW	<b>0 445 116 059</b>	<b>0 986 435 395</b>	
<b>35-120</b> [16]	2,3	85	F1AGL411H <Euro 6>	07.16→	4	DBJ	<b>0 445 110 418</b>	<b>0 986 435 212</b> <b>0 986 435 248</b>	
<b>35-130</b> [16]	2,3	93	F1AFL411B*A	07.17→	4	DBJ	<b>0 445 110 418</b>	<b>0 986 435 212</b> <b>0 986 435 248</b>	
<b>35-140</b> [16]	2,3	100	F1AGL411... <EURO 6>	07.16→	4	DBJ	<b>0 445 110 418</b>	<b>0 986 435 212</b> <b>0 986 435 248</b>	
<b>35-150</b> [16]	3,0	110	F1C... <Euro 6>	07.16→	4	DBJ	<b>0 445 110 564</b>	<b>0 986 435 255</b>	<b>F 00V D38 010</b>
<b>35-160</b> [16]	2,3	110-114,6	F1AGL411... <Euro 6>; F1AGL411... <EURO 6>	07.16→	4	DBJ	<b>0 445 110 418</b>	<b>0 986 435 212</b> <b>0 986 435 248</b>	
<b>35-180</b> [16]	3,0	132	F1C... <Euro 6>	07.16→	4	DBJ	<b>0 445 110 564</b>	<b>0 986 435 255</b>	<b>F 00V D38 010</b>
<b>35-210</b> [16]	3,0	150	F1CGL411C <Euro 6>	07.16→	4	DBJ	<b>0 445 110 564</b>	<b>0 986 435 255</b>	<b>F 00V D38 010</b>





◀ IVECO

38 13	2,8	92	8140.43S	10.05-07.07	4	DBJ	0 445 120 002	0 986 435 501	
40 13	2,8	92	8140.43S	10.05-07.07	4	DBJ	0 445 120 002	0 986 435 501	
40 C 10 [06]	2,3	71	F1AE0481F..						
			Fg.-Nr. →1303265	04.06-05.09	4	DBB	0 445 110 273	0 986 435 165	
			Fg.-Nr. 1303266→	04.06-05.09	4	DBJ	0 445 110 435	0 986 435 227	
11 [09]	2,3	78	F1AE0481U..						
			Fg.-Nr. →1303265	06.09-12.11	4	DBB	0 445 110 273	0 986 435 165	
			Fg.-Nr. 1303266→	06.09-12.11	4	DBJ	0 445 110 435	0 986 435 227	
11 [12]	2,3	78	F1AE3481A*A00...	01.12-07.14	4	DBJ,TW	0 445 110 418	0 986 435 212	
								0 986 435 248	
					4	DBJ,TW	0 445 116 059	0 986 435 395	
12 [06]	2,3	85	F1AE0481G..						
			Fg.-Nr. →1303265	04.06-05.09	4	DBB	0 445 110 273	0 986 435 165	
			Fg.-Nr. 1303266→	04.06-05.09	4	DBJ	0 445 110 435	0 986 435 227	
13 [09]	2,3	93	F1AE0481V..						
			Fg.-Nr. →1303265	06.09-12.11	4	DBB	0 445 110 273	0 986 435 165	
			Fg.-Nr. 1303266→	06.09-12.11	4	DBJ	0 445 110 435	0 986 435 227	
13 [12]	2,3	93	F1AE3481B*A00...	01.12-07.14	4	DBJ,TW	0 445 110 418	0 986 435 212	
								0 986 435 248	
					4	DBJ,TW	0 445 116 059	0 986 435 395	
13, 15 [00]	2,8	92/108	8140.43N.43...; 8140.43S...	01.01-09.04	4	DBJ	0 445 120 002	0 986 435 501	
14 [09]	3,0	103	F1CE3481C..	06.09-12.11	4	DBJ,TW	0 445 110 418	0 986 435 212	
								0 986 435 248	
					4	DBJ,TW	0 445 116 059	0 986 435 395	
14, 17 [00]	3,0	100/122	F1CE0481A...; F1CE0481B	09.04-03.06	4	DBJ	0 445 120 036	0 986 435 507	
15 [14]	3,0	107	F1CFL411E°C	05.14→	4	DBJ	0 445 110 564	0 986 435 255	F 00V D38 010
15, 17 [12]	3,0	107/125	F1CE3481...	01.12-07.14	4	DBJ,TW	0 445 110 418	0 986 435 212	
								0 986 435 248	
					4	DBJ,TW	0 445 116 059	0 986 435 395	
15, 17, 21 [14]	3,0	107/125/ 150	F1CFL411G°C; F1CFL411H°C; F1CFL411J°C	05.14→	4	DBJ	0 445 116 059	0 986 435 395	
15, 18 [06]	3,0	107/130	F1CE0481...; F1CE0481H..	04.06-12.11	4	DBJ	0 445 110 248	0 986 435 163	
17 [09]	3,0	125	F1CE3481C°C..	06.09-12.11	4	DBJ,TW	0 445 110 418	0 986 435 212	
								0 986 435 248	
					4	DBJ,TW	0 445 116 059	0 986 435 395	
17 [14]	3,0	125	F1CFL411F°C	05.14→	4	DBJ	0 445 110 564	0 986 435 255	F 00V D38 010
21 [12]	3,0	150	F1CE3481D*B13...	01.12-07.14	4	DBJ,TW	0 445 110 418	0 986 435 212	
								0 986 435 248	
					4	DBJ,TW	0 445 116 059	0 986 435 395	
40 S 16	3,0	114	F1CE0481 <Euro 3>	08.07-03.12	4	DBJ	0 445 110 248	0 986 435 163	
40-150 [16]	3,0	110	F1C... <Euro 6>	07.16→	4	DBJ	0 445 110 564	0 986 435 255	F 00V D38 010
40-160 [16]	2,3	110-114,6	F1AGL411... <Euro 6>	07.17→	4	DBJ	0 445 110 418	0 986 435 212	
								0 986 435 248	
40-180 [16]	3,0	132	F1C... <Euro 6>	07.16→	4	DBJ	0 445 110 564	0 986 435 255	F 00V D38 010
40-210 [16]	3,0	150	F1CGL411C <Euro 6>	07.16→	4	DBJ	0 445 110 564	0 986 435 255	F 00V D38 010
45 C 13 [00]	2,8	92	8140.43S	01.01-09.04	4	DBJ	0 445 120 002	0 986 435 501	
14 [09]	3,0	103	F1CE3481L..	05.10-12.11	4	DBJ	0 445 116 059	0 986 435 395	
15, 18 [06]	3,0	107/130	F1CE0481F...; F1CE0481H..	04.06-12.11	4	DBJ	0 445 110 248	0 986 435 163	
45 S 17	3,0	125	F1C DS <Euro 5 / P-7 (EGR)>	04.12→	4	DBJ	0 445 116 059	0 986 435 395	
50 13	2,8	92	8140.43S	10.05-07.07	4	DBJ	0 445 120 002	0 986 435 501	
50 C 11, 13, 15 [00]	2,8	78/92/ 108	8140.43B.43...; 8140.43N.43...; 8140.43S...	05.99-09.04	4	DBJ	0 445 120 002	0 986 435 501	
12 [00]	2,3	85	F1AE0481B..	09.02-03.06	4	DBJ	0 445 120 011	0 986 435 506	
12 [06]	2,3	85	F1AE0481G..	04.06-12.11	4	DBB	0 445 110 273	0 986 435 165	
14 [09]	3,0	103	F1CE3481L°C..	06.09-12.11	4	DBJ,TW	0 445 110 418	0 986 435 212	
								0 986 435 248	
					4	DBJ,TW	0 445 116 059	0 986 435 395	
14, 17 [00]	3,0	100/122	F1CE0481A...; F1CE0481B	09.04-03.06	4	DBJ	0 445 120 036	0 986 435 507	
15 [14]	3,0	107	F1CFL411E°C	05.14→	4	DBJ	0 445 110 564	0 986 435 255	F 00V D38 010
15, 17 [12]	3,0	107/125	F1CE3481...	07.11-07.14	4	DBJ,TW	0 445 110 418	0 986 435 212	
								0 986 435 248	
					4	DBJ,TW	0 445 116 059	0 986 435 395	





<b>50 C</b> 15, 17, 21 [14]	3,0	107/125/ 150	F1CFL411G*C; F1CFL411H*C; F1CFL411J*C	05.14→	4	DBJ	<b>0 445 116 059</b>	<b>0 986 435 395</b>	
15, 18 [06]	3,0	107/130	F1CE0481...; F1CE0481H..	04.06-12.11	4	DBJ	<b>0 445 110 248</b>	<b>0 986 435 163</b>	
17 [09]	3,0	125	F1CE3481C*...	06.09-12.11	4	DBJ,TW	<b>0 445 110 418</b>	<b>0 986 435 212</b>	
								<b>0 986 435 248</b>	
					4	DBJ,TW	<b>0 445 116 059</b>	<b>0 986 435 395</b>	
17 [14]	3,0	125	F1CFL411F*C	05.14→	4	DBJ	<b>0 445 110 564</b>	<b>0 986 435 255</b>	<b>F 00V D38 010</b>
21 [12]	3,0	150	F1CE3481D*B13...	07.11-07.14	4	DBJ,TW	<b>0 445 110 418</b>	<b>0 986 435 212</b>	
								<b>0 986 435 248</b>	
					4	DBJ,TW	<b>0 445 116 059</b>	<b>0 986 435 395</b>	
<b>50-150</b> [16]	3,0	110	F1C... <Euro 6>	07.16→	4	DBJ	<b>0 445 110 564</b>	<b>0 986 435 255</b>	<b>F 00V D38 010</b>
<b>50-160</b> [16]	2,3	110-114,6	F1AGL411... <Euro 6>	07.17→	4	DBJ	<b>0 445 110 418</b>	<b>0 986 435 212</b>	
								<b>0 986 435 248</b>	
<b>50-180</b> [16]	3,0	132	F1C... <Euro 6>	07.16→	4	DBJ	<b>0 445 110 564</b>	<b>0 986 435 255</b>	<b>F 00V D38 010</b>
<b>50-210</b> [16]	3,0	150	F1CGL411C <Euro 6>	07.16→	4	DBJ	<b>0 445 110 564</b>	<b>0 986 435 255</b>	<b>F 00V D38 010</b>
<b>55 C</b> 16	3,0	114	F1CE0481 <Euro 3>	08.07-03.12	4	DBJ	<b>0 445 110 248</b>	<b>0 986 435 163</b>	
17	3,0	125	F1C DS <Euro 5 / P-7 (EGR)>	04.12→	4	DBJ	<b>0 445 116 059</b>	<b>0 986 435 395</b>	
<b>55 S</b> 15 [14]	3,0	107	F1CE3481J*B..	09.15→	4	DBJ	<b>0 445 116 059</b>	<b>0 986 435 395</b>	
17 [09]	3,0	125	F1CE3481C*C..	06.09-12.11	4	DBJ,TW	<b>0 445 110 418</b>	<b>0 986 435 212</b>	
								<b>0 986 435 248</b>	
					4	DBJ,TW	<b>0 445 116 059</b>	<b>0 986 435 395</b>	
17 [12]	3,0	125	F1CE3481...	07.11-07.14	4	DBJ,TW	<b>0 445 110 418</b>	<b>0 986 435 212</b>	
								<b>0 986 435 248</b>	
					4	DBJ,TW	<b>0 445 116 059</b>	<b>0 986 435 395</b>	
17 [14]	3,0	125	F1CFL411F*C	09.15→	4	DBJ	<b>0 445 110 564</b>	<b>0 986 435 255</b>	<b>F 00V D38 010</b>
18 [06]	3,0	130	F1CE0481H..	04.06-12.11	4	DBJ	<b>0 445 110 248</b>	<b>0 986 435 163</b>	
<b>55-180</b> [16]	3,0	132	F1C... <Euro 6>	07.16→	4	DBJ	<b>0 445 110 564</b>	<b>0 986 435 255</b>	<b>F 00V D38 010</b>
<b>60 C</b> 14 [09]	3,0	103	F1CE3481L..	11.10-12.11	4	DBJ	<b>0 445 116 059</b>	<b>0 986 435 395</b>	
15, 17, 21 [12]	3,0	107/125/ 150	F1CE3481...; F1CE3481D*B..; F1CE3481J*B..	07.11-07.14	4	DBJ	<b>0 445 116 059</b>	<b>0 986 435 395</b>	
15, 18 [06]	3,0	107/130	F1CE0481F..; F1CE0481H..	04.06-12.11	4	DBJ	<b>0 445 110 248</b>	<b>0 986 435 163</b>	
17 [14]	3,0	107/125	F1CFL411E*C; F1CFL411F*C	05.14→	4	DBJ	<b>0 445 110 564</b>	<b>0 986 435 255</b>	<b>F 00V D38 010</b>
<b>60-150</b> [16]	3,0	110	F1C... <Euro 6>	02.17→	4	DBJ	<b>0 445 110 564</b>	<b>0 986 435 255</b>	<b>F 00V D38 010</b>
<b>60-180</b> [16]	3,0	132	F1C... <Euro 6>	02.17→	4	DBJ	<b>0 445 110 564</b>	<b>0 986 435 255</b>	<b>F 00V D38 010</b>
<b>65 C</b> 13, 15 [00]	2,8	108	8140.43N.43..; 8140.43N.43...	05.00-09.04	4	DBJ	<b>0 445 120 002</b>	<b>0 986 435 501</b>	
14 [09]	3,0	103	F1CE3481L*C..	06.09-12.11	4	DBJ,TW	<b>0 445 110 418</b>	<b>0 986 435 212</b>	
								<b>0 986 435 248</b>	
					4	DBJ,TW	<b>0 445 116 059</b>	<b>0 986 435 395</b>	
14, 17 [00]	3,0	100/122	F1CE0481A..; F1CE0481B	09.04-03.06	4	DBJ	<b>0 445 120 036</b>	<b>0 986 435 507</b>	
15 [14]	3,0	107	F1CFL411E*C	05.14→	4	DBJ	<b>0 445 110 564</b>	<b>0 986 435 255</b>	<b>F 00V D38 010</b>
15, 17 [12]	3,0	107/125	F1CE3481...	07.11-07.14	4	DBJ,TW	<b>0 445 110 418</b>	<b>0 986 435 212</b>	
								<b>0 986 435 248</b>	
					4	DBJ,TW	<b>0 445 116 059</b>	<b>0 986 435 395</b>	
15, 17, 21 [14]	3,0	107/125/ 150	F1CFL411G*C; F1CFL411H*C; F1CFL411J*C	05.14→	4	DBJ	<b>0 445 116 059</b>	<b>0 986 435 395</b>	
15, 18 [06]	3,0	107/130	F1CE0481F..; F1CE0481H..	04.06-12.11	4	DBJ	<b>0 445 110 248</b>	<b>0 986 435 163</b>	
17 [09]	3,0	125	F1CE3481C*...	06.09-12.11	4	DBJ,TW	<b>0 445 110 418</b>	<b>0 986 435 212</b>	
								<b>0 986 435 248</b>	
					4	DBJ,TW	<b>0 445 116 059</b>	<b>0 986 435 395</b>	
17 [14]	3,0	125	F1CFL411F*C	05.14→	4	DBJ	<b>0 445 110 564</b>	<b>0 986 435 255</b>	<b>F 00V D38 010</b>
21 [12]	3,0	150	F1CE3481D*B134	07.11-07.14	4	DBJ,TW	<b>0 445 110 418</b>	<b>0 986 435 212</b>	
								<b>0 986 435 248</b>	
					4	DBJ,TW	<b>0 445 116 059</b>	<b>0 986 435 395</b>	
<b>65-150</b> [16]	3,0	110	F1C... <Euro 6>	07.16→	4	DBJ	<b>0 445 110 564</b>	<b>0 986 435 255</b>	<b>F 00V D38 010</b>
<b>65-180</b> [16]	3,0	132	F1C... <Euro 6>	07.16→	4	DBJ	<b>0 445 110 564</b>	<b>0 986 435 255</b>	<b>F 00V D38 010</b>
<b>65-210</b> [16]	3,0	150	F1CGL411C <Euro 6>	07.16→	4	DBJ	<b>0 445 110 564</b>	<b>0 986 435 255</b>	<b>F 00V D38 010</b>
<b>70</b> 13	2,8	92	8140.43S	10.05-07.07	4	DBJ	<b>0 445 120 002</b>	<b>0 986 435 501</b>	
<b>70 C</b> 14 [09]	3,0	103	F1CE3481L..	11.10-12.11	4	DBJ,TW	<b>0 445 110 418</b>	<b>0 986 435 212</b>	
								<b>0 986 435 248</b>	
					4	DBJ,TW	<b>0 445 116 059</b>	<b>0 986 435 395</b>	
15 [14]	3,0	107	F1CFL411E*C	05.14→	4	DBJ	<b>0 445 110 564</b>	<b>0 986 435 255</b>	<b>F 00V D38 010</b>





◀ IVECO

<b>70 C</b> 15, 17 [12]	3,0	107/125	F1CE3481...	07.11-07.14	4	DBJ,TW	<b>0 445 110 418</b>	<b>0 986 435 212</b>	
								<b>0 986 435 248</b>	
					4	DBJ,TW	<b>0 445 116 059</b>	<b>0 986 435 395</b>	
15, 17, 21 [14]	3,0	107/125/ 150	F1CFL411G*C; F1CFL411H*C; F1CFL411J*C	05.14→	4	DBJ	<b>0 445 116 059</b>	<b>0 986 435 395</b>	
15, 18 [09]	3,0	107/130	F1CE...; F1CE3481H..	06.10-12.11	4	DBJ	<b>0 445 110 248</b>	<b>0 986 435 163</b>	
17	3,0	125	F1C DS <Euro 5 / P-7 (EGR)>	04.12→	4	DBJ	<b>0 445 116 059</b>	<b>0 986 435 395</b>	
17 [09]	3,0	125	F1CE3481C..	11.10-12.11	4	DBJ,TW	<b>0 445 110 418</b>	<b>0 986 435 212</b>	
								<b>0 986 435 248</b>	
					4	DBJ,TW	<b>0 445 116 059</b>	<b>0 986 435 395</b>	
17 [14]	3,0	125	F1CFL411F*C	05.14→	4	DBJ	<b>0 445 110 564</b>	<b>0 986 435 255</b>	<b>F 00V D38 010</b>
21 [12]	3,0	150	F1CE3481D*B13...	07.11-07.14	4	DBJ,TW	<b>0 445 110 418</b>	<b>0 986 435 212</b>	
								<b>0 986 435 248</b>	
					4	DBJ,TW	<b>0 445 116 059</b>	<b>0 986 435 395</b>	
<b>70-150</b> [16]	3,0	110	F1C... <Euro 6>	07.16→	4	DBJ	<b>0 445 110 564</b>	<b>0 986 435 255</b>	<b>F 00V D38 010</b>
<b>70-180</b> [16]	3,0	132	F1C... <Euro 6>	07.16→	4	DBJ	<b>0 445 110 564</b>	<b>0 986 435 255</b>	<b>F 00V D38 010</b>
<b>70-210</b> [16]	3,0	150	F1CGL411C <Euro 6>	07.16→	4	DBJ	<b>0 445 110 564</b>	<b>0 986 435 255</b>	<b>F 00V D38 010</b>
<b>EuroCargo</b>									
<b>65 E</b> 13	3,9	95	F4AE0481D*C	08.00-08.03	4	DBJ	<b>0 445 120 273</b>	<b>0 986 435 571</b>	
13, 15 [03]	3,9	95/110	F4AE0481C*C...; F4AE0481D*C	09.03-08.05	4	DBJ	<b>0 445 120 273</b>	<b>0 986 435 571</b>	
14, 16 [03]	3,9	103/118	F4AE3481C*P; F4AE3481D*P	09.04-08.06	4	DBJ	<b>0 445 120 054</b>	<b>0 986 435 545</b>	
15	3,9	110	F4AE0481C*C..	08.00-08.03	4	DBJ	<b>0 445 120 273</b>	<b>0 986 435 571</b>	TW <b>F 00R J00 345</b>
<b>75 E</b> 13	3,9	95	F4AE0481D*C	09.00-08.03	4	DBJ	<b>0 445 120 273</b>	<b>0 986 435 571</b>	
13, 15, 17 [03]	3,9	95/110/ 125	F4AE0481A*C...; F4AE0481C*C...; F4AE0481D*C	09.03-08.05	4	DBJ	<b>0 445 120 273</b>	<b>0 986 435 571</b>	
14, 16, 18 [03]	3,9	103/118/ 130	F4AE3481B*...; F4AE3481C*...; F4AE3481D*...	09.05-01.14	4	DBJ	<b>0 445 120 054</b>	<b>0 986 435 545</b>	
15	3,9	110	F4AE0481C*CC	09.00-08.03	4	DBJ	<b>0 445 120 273</b>	<b>0 986 435 571</b>	TW <b>F 00R J00 345</b>
16, 19 [14]	4,5	118/137	F4AFE411... <Tector 5>	09.13→	4	DBJ,TW	<b>0 445 120 346</b>	<b>0 986 435 662</b>	
					4	DBJ,TW	<b>0 445 120 409</b>		
17	3,9	125	F4AE0481A*C...	09.00-08.03	4	DBJ	<b>0 445 120 273</b>	<b>0 986 435 571</b>	
18	5,9	134	F4AE0681E*C...	09.00-08.03	6	DBJ	<b>0 445 120 273</b>	<b>0 986 435 571</b>	
18 [03]	5,9	134	F4AE0681E*C..	09.03-08.05	6	DBJ	<b>0 445 120 273</b>	<b>0 986 435 571</b>	
21 [14]	4,5	152	F4AFE411C* <Tector 5>	09.13→	4	DBJ,TW	<b>0 445 120 346</b>	<b>0 986 435 662</b>	
					4	DBJ,TW	<b>0 445 120 409</b>		
<b>80 E</b> 15	3,9	110	F4AE0481C*C..	09.00-08.03	4	DBJ	<b>0 445 120 273</b>	<b>0 986 435 571</b>	TW <b>F 00R J00 345</b>
15, 17 [03]	3,9	110/125	F4AE0481A*C...; F4AE0481C*C..	09.03-08.05	4	DBJ	<b>0 445 120 273</b>	<b>0 986 435 571</b>	
16, 18 [03]	3,9	118/130	F4AE3481B*...; F4AE3481D*...	09.05-01.14	4	DBJ	<b>0 445 120 054</b>	<b>0 986 435 545</b>	
17	3,9	125	F4AE0481A*C..	09.00-08.03	4	DBJ	<b>0 445 120 273</b>	<b>0 986 435 571</b>	
18, 21	5,9	134/154	F4AE0681D*C...; F4AE0681E*C..	09.00-08.03	6	DBJ	<b>0 445 120 273</b>	<b>0 986 435 571</b>	
18, 21 [03]	5,9	134/154	F4AE0681D*C...; F4AE0681E*C..	09.03-08.05	6	DBJ	<b>0 445 120 273</b>	<b>0 986 435 571</b>	
22 [03]	5,9	160	F4AE3681B*...	09.05-01.14	6	DBJ	<b>0 445 120 054</b>	<b>0 986 435 545</b>	
<b>90 E</b> 17	3,9	125	F4AE0481A*C..	09.00-08.03	4	DBJ	<b>0 445 120 273</b>	<b>0 986 435 571</b>	
17 [03]	3,9	125	F4AE0481A*C..	09.03-09.05	4	DBJ	<b>0 445 120 273</b>	<b>0 986 435 571</b>	
18 [03]	3,9	130	F4AE3481B*...	09.05-01.14	4	DBJ	<b>0 445 120 054</b>	<b>0 986 435 545</b>	
18, 19 [03]	5,9	134/154	F4AE0681D*C...; F4AE0681E*C..	09.03-09.05	6	DBJ	<b>0 445 120 273</b>	<b>0 986 435 571</b>	
18, 21	5,9	134/154	F4AE0681D*C...; F4AE0681E*C..	09.00-08.03	6	DBJ	<b>0 445 120 273</b>	<b>0 986 435 571</b>	
22 [03]	5,9	160	F4AE3681B*...	09.05-01.14	6	DBJ	<b>0 445 120 054</b>	<b>0 986 435 545</b>	
<b>100 E</b> 17	3,9	125	F4AE0481A*C...	09.00-08.03	4	DBJ	<b>0 445 120 273</b>	<b>0 986 435 571</b>	
17 [03]	3,9	125	F4AE0481A*C..	09.03-08.05	4	DBJ	<b>0 445 120 273</b>	<b>0 986 435 571</b>	
18 [03]	3,9	130	F4AE3481B*...	09.06-01.14	4	DBJ,TW	<b>0 445 120 054</b>	<b>0 986 435 545</b>	
					4	DBJ,TW	<b>0 445 120 273</b>	<b>0 986 435 571</b>	
	5,9	135	F4AE3681C*...	09.05-01.14	6	DBJ,TW	<b>0 445 120 054</b>	<b>0 986 435 545</b>	
					6	DBJ,TW	<b>0 445 120 273</b>	<b>0 986 435 571</b>	
18, 21	5,9	134/154	F4AE0681D*C...; F4AE0681E*C...	09.00-08.03	6	DBJ	<b>0 445 120 273</b>	<b>0 986 435 571</b>	
18, 21 [03]	5,9	134/154	F4AE0681D*C...; F4AE0681E*C..	09.03-08.05	6	DBJ	<b>0 445 120 273</b>	<b>0 986 435 571</b>	
19 [14]	4,5	137	F4AFE411... <Tector 5>	09.13→	4	DBJ,TW	<b>0 445 120 346</b>	<b>0 986 435 662</b>	
					4	DBJ,TW	<b>0 445 120 409</b>		
21 [14]	4,5	152	F4AFE411C* <Tector 5>	09.13→	4	DBJ,TW	<b>0 445 120 346</b>	<b>0 986 435 662</b>	
					4	DBJ,TW	<b>0 445 120 409</b>		
22 [03]	5,9	160	F4AE3681B*...	09.05-01.14	6	DBJ,TW	<b>0 445 120 054</b>	<b>0 986 435 545</b>	
					6	DBJ,TW	<b>0 445 120 273</b>	<b>0 986 435 571</b>	
22 [14]	6,7	162	F4AFE611A* <Tector 7>	09.13→	6	DBJ	<b>0 445 120 346</b>	<b>0 986 435 662</b>	







<b>110 E</b> 18, 22 [16]	5,9	132/162	F4AEE681 <Tector 6 - Euro 3>	01.18→	6	DBJ	<b>0 445 120 054</b>	<b>0 986 435 545</b>
22 [03]	5,9	160	F4AE3681B*...	09.07-01.14	6	DBJ,TW	<b>0 445 120 054</b>	<b>0 986 435 545</b>
					6	DBJ,TW	<b>0 445 120 273</b>	<b>0 986 435 571</b>
22 [14]	6,7	162	F4AFE611A* <Tector 7>	07.14→	6	DBJ	<b>0 445 120 346</b>	<b>0 986 435 662</b>
25 [03]	5,9	185	F4AE3681D*..	09.07-01.14	6	DBJ	<b>0 445 120 054</b>	<b>0 986 435 545</b>
<b>120 E</b> 17	3,9	125	F4AE0481A*C...	09.00-08.03	4	DBJ	<b>0 445 120 273</b>	<b>0 986 435 571</b>
17 [03]	3,9	125	F4AE0481A*C...	09.03-08.05	4	DBJ	<b>0 445 120 273</b>	<b>0 986 435 571</b>
18 [03]	3,9	134	F4AE3481A*...	09.05-01.14	4	DBJ,TW	<b>0 445 120 054</b>	<b>0 986 435 545</b>
					4	DBJ,TW	<b>0 445 120 273</b>	<b>0 986 435 571</b>
18, 21, 24, 28	5,9	134/154/ 176/202	F4AE0681A*C...; F4AE0681B*C...; F4AE0681D*C...; F4AE0681E*C...	09.00-08.03	6	DBJ	<b>0 445 120 273</b>	<b>0 986 435 571</b>
18, 21, 24, 28 [03]	5,9	134/154/ 176/202	F4AE0681A*C...; F4AE0681B*C...; F4AE0681D*C...; F4AE0681E*C...	09.03-08.05	6	DBJ	<b>0 445 120 273</b>	<b>0 986 435 571</b>
18, 22 [16]	5,9	132/162	F4AEE681 <Tector 6 - Euro 3>	01.18→	6	DBJ	<b>0 445 120 054</b>	<b>0 986 435 545</b>
19 [14]	4,5	137	F4AFE411... <Tector 5>	09.13→	4	DBJ,TW	<b>0 445 120 346</b>	<b>0 986 435 662</b>
					4	DBJ,TW	<b>0 445 120 409</b>	
21 [14]	4,5	152	F4AFE411C* <Tector 5>	09.13→	4	DBJ	<b>0 445 120 346</b>	<b>0 986 435 662</b>
22 [03]	5,9	160	F4AE3681B*...	09.05-01.14	6	DBJ,TW	<b>0 445 120 054</b>	<b>0 986 435 545</b>
					6	DBJ,TW	<b>0 445 120 273</b>	<b>0 986 435 571</b>
22 [14]	6,7	162	F4AFE611A* <Tector 7>	09.13→	6	DBJ	<b>0 445 120 346</b>	<b>0 986 435 662</b>
25, 28 [03]	5,9	185/205	F4AE3681D*...; F4AE3681E*...	09.05-01.14	6	DBJ	<b>0 445 120 054</b>	<b>0 986 435 545</b>
<b>120 EL</b> 18 [03]	3,9	130	F4AE3481B*P	09.05-01.14	4	DBJ	<b>0 445 120 054</b>	<b>0 986 435 545</b>
22 [03]	5,9	160	F4AE3681B*...	05.09-01.14	6	DBJ	<b>0 445 120 054</b>	<b>0 986 435 545</b>
<b>130 E</b> 18 [03]	3,9	134	F4AE3481A*P	09.05-01.14	4	DBJ	<b>0 445 120 054</b>	<b>0 986 435 545</b>
18, 21, 24, 28	5,9	134/154/ 176/202	F4AE0681A*C...; F4AE0681B*C...; F4AE0681D*C...; F4AE0681E*C...	09.00-08.03	6	DBJ	<b>0 445 120 273</b>	<b>0 986 435 571</b>
18, 21, 24, 28 [03]	5,9	134/154/ 176/202	F4AE0681A*C...; F4AE0681B*C...; F4AE0681D*C...; F4AE0681E*C...	09.03-08.05	6	DBJ	<b>0 445 120 273</b>	<b>0 986 435 571</b>
25 [03]	5,9	185	F4AE3681D*..	09.05-01.14	6	DBJ	<b>0 445 120 054</b>	<b>0 986 435 545</b>
<b>140 E</b> 18 [03]	3,9	134	F4AE3481A*...	09.05-01.14	4	DBJ,TW	<b>0 445 120 054</b>	<b>0 986 435 545</b>
					4	DBJ,TW	<b>0 445 120 273</b>	<b>0 986 435 571</b>
18, 21, 24, 28 [03]	5,9	134/154/ 176/202	F4AE0681A*C...; F4AE0681B*C...; F4AE0681D*C...; F4AE0681E*C...	09.03-08.05	6	DBJ	<b>0 445 120 273</b>	<b>0 986 435 571</b>
18, 24	5,9	134/176	F4AE0681B*C...; F4AE0681E*C...	09.00-08.03	6	DBJ	<b>0 445 120 273</b>	<b>0 986 435 571</b>
19 [14]	4,5	137	F4AFE411... <Tector 5>	09.13→	4	DBJ,TW	<b>0 445 120 346</b>	<b>0 986 435 662</b>
					4	DBJ,TW	<b>0 445 120 409</b>	
21 [14]	4,5	152	F4AFE411C* <Tector 5>	09.13→	4	DBJ	<b>0 445 120 346</b>	<b>0 986 435 662</b>
22 [03]	5,9	160	F4AE3681B*...	09.05-01.14	6	DBJ,TW	<b>0 445 120 054</b>	<b>0 986 435 545</b>
					6	DBJ,TW	<b>0 445 120 273</b>	<b>0 986 435 571</b>
22 [14]	6,7	162	F4AFE611A* <Tector 7>	09.13→	6	DBJ,TW	<b>0 445 120 054</b>	<b>0 986 435 545</b>
					6	DBJ,TW	<b>0 445 120 273</b>	<b>0 986 435 571</b>
					6	DBJ,TW	<b>0 445 120 346</b>	<b>0 986 435 662</b>
22, 24, 25, 28 [16]	5,9	162/176/ 185/202	F4AEE681 <Tector 6 - Euro 3>; F4AE3681D*..	01.18→	6	DBJ	<b>0 445 120 054</b>	<b>0 986 435 545</b>
25 [03]	5,9	185	F4AE3681D*...	09.05-01.14	6	DBJ,TW	<b>0 445 120 054</b>	<b>0 986 435 545</b>
					6	DBJ,TW	<b>0 445 120 273</b>	<b>0 986 435 571</b>
25, 28 [14]	6,7	185/206	F4AFE611C* <Tector 7>; F4AFE611E* <Tector 7>	09.13→	6	DBJ	<b>0 445 120 346</b>	<b>0 986 435 662</b>
28 [03]	5,9	205	F4AE3681E*...	09.05-01.14	6	DBJ,TW	<b>0 445 120 054</b>	<b>0 986 435 545</b>
					6	DBJ,TW	<b>0 445 120 273</b>	<b>0 986 435 571</b>
<b>150 E</b> 18 [03]	3,9	134	F4AE3481A*..	09.05-01.14	4	DBJ,TW	<b>0 445 120 054</b>	<b>0 986 435 545</b>
					4	DBJ,TW	<b>0 445 120 273</b>	<b>0 986 435 571</b>
18, 21, 24, 28	5,9	134/154/ 176/202	F4AE0681A*C...; F4AE0681B*C...; F4AE0681D*C...; F4AE0681E*C...	09.00-08.03	6	DBJ	<b>0 445 120 273</b>	<b>0 986 435 571</b>
18, 21, 24, 28 [03]	5,9	134/154/ 176/202	F4AE0681A*C...; F4AE0681B*C...; F4AE0681D*C...; F4AE0681E*C...	09.03-08.05	6	DBJ	<b>0 445 120 273</b>	<b>0 986 435 571</b>
22 [03]	5,9	160	F4AE3681B*..	09.05-01.14	6	DBJ	<b>0 445 120 054</b>	<b>0 986 435 545</b>
22 [14]	6,7	162	F4AFE611A* <Tector 7>	09.13→	6	DBJ	<b>0 445 120 054</b>	<b>0 986 435 545</b>
24, 25, 28 [16]	5,9	176/185/ 202	F4AEE681 <Tector 6 - Euro 3>; F4AE3681D*..	01.18→	6	DBJ	<b>0 445 120 054</b>	<b>0 986 435 545</b>
25 [03]	5,9	185	F4AE3681D*..	09.05-01.14	6	DBJ,TW	<b>0 445 120 054</b>	<b>0 986 435 545</b>
					6	DBJ,TW	<b>0 445 120 273</b>	<b>0 986 435 571</b>







◀ IVECO

<b>150 E</b> 25, 28, 32 [14]	6,7	185/206/235	F4AFE611C* <Tector 7>; F4AFE611D* <Tector 7>; F4AFE611E* <Tector 7>	09.13→	6	DBJ	<b>0 445 120 346</b>	<b>0 986 435 662</b>
28 [03]	5,9	205	F4AE3681E*..	09.05-01.14	6	DBJ,TW	<b>0 445 120 054</b>	<b>0 986 435 545</b>
30 [03]	5,9	220	F4AE3681A*..	09.05-01.14	6	DBJ,TW	<b>0 445 120 054</b>	<b>0 986 435 545</b>
					6	DBJ,TW	<b>0 445 120 273</b>	<b>0 986 435 571</b>
<b>160 E</b> 18 [03]	3,9	134	F4AE3481A*..	09.05-01.14	4	DBJ,TW	<b>0 445 120 054</b>	<b>0 986 435 545</b>
					4	DBJ,TW	<b>0 445 120 273</b>	<b>0 986 435 571</b>
19, 21 [14]	4,5	137/152	F4AFE411... <Tector 5>; F4AFE411C* <Tector 5>	09.13→	4	DBJ	<b>0 445 120 346</b>	<b>0 986 435 662</b>
21, 24, 28 [03]	5,9	154/176/202	F4AE0681A*C...; F4AE0681B*C...; F4AE0681D*C..	09.03-08.05	6	DBJ	<b>0 445 120 273</b>	<b>0 986 435 571</b>
22 [03]	5,9	160	F4AE3681B*..	09.05-01.14	6	DBJ,TW	<b>0 445 120 054</b>	<b>0 986 435 545</b>
					6	DBJ,TW	<b>0 445 120 273</b>	<b>0 986 435 571</b>
22, 24, 25, 28 [16]	5,9	162/176/185/202	F4AEE681 <Tector 6 - Euro 3>; F4AE3681D*..	01.18→	6	DBJ	<b>0 445 120 054</b>	<b>0 986 435 545</b>
22, 25, 28, 32 [14]	6,7	162/185/206/235	F4AFE611A* <Tector 7>; F4AFE611C* <Tector 7>; F4AFE611D* <Tector 7>; F4AFE611E* <Tector 7>	09.13→	6	DBJ	<b>0 445 120 346</b>	<b>0 986 435 662</b>
25 [03]	5,9	185	F4AE3681D*..	09.05-01.14	6	DBJ,TW	<b>0 445 120 054</b>	<b>0 986 435 545</b>
					6	DBJ,TW	<b>0 445 120 273</b>	<b>0 986 435 571</b>
28 [03]	5,9	205	F4AE3681E*..	09.05-01.14	6	DBJ,TW	<b>0 445 120 054</b>	<b>0 986 435 545</b>
					6	DBJ,TW	<b>0 445 120 273</b>	<b>0 986 435 571</b>
30 [03]	5,9	220	F4AE3681A*..	09.05-01.14	6	DBJ,TW	<b>0 445 120 054</b>	<b>0 986 435 545</b>
					6	DBJ,TW	<b>0 445 120 273</b>	<b>0 986 435 571</b>
<b>180 E</b> 21, 24, 28	5,9	154/176/202	F4AE0681A*C...; F4AE0681B*C...; F4AE0681D*C...	09.00-08.03	6	DBJ	<b>0 445 120 273</b>	<b>0 986 435 571</b>
21, 24, 28 [03]	5,9	154/176/202	F4AE0681A*C...; F4AE0681B*C...; F4AE0681D*C..	09.03-08.05	6	DBJ	<b>0 445 120 273</b>	<b>0 986 435 571</b>
24, 25, 28 [16]	5,9	176/185/202	F4AEE681 <Tector 6 - Euro 3>; F4AE3681D*..	01.18→	6	DBJ	<b>0 445 120 054</b>	<b>0 986 435 545</b>
25 [03]	5,9	185	F4AE3681D*..	09.05-01.14	6	DBJ,TW	<b>0 445 120 054</b>	<b>0 986 435 545</b>
					6	DBJ,TW	<b>0 445 120 273</b>	<b>0 986 435 571</b>
25, 32 [14]	6,7	185/235	F4AFE611D* <Tector 7>; F4AFE611E* <Tector 7>	09.13→	6	DBJ	<b>0 445 120 346</b>	<b>0 986 435 662</b>
28 [03]	5,9	205	F4AE3681E*..	09.05-01.14	6	DBJ,TW	<b>0 445 120 054</b>	<b>0 986 435 545</b>
					6	DBJ,TW	<b>0 445 120 273</b>	<b>0 986 435 571</b>
28 [14]	6,7	206	F4AFE611C* <Tector 7>	09.13→	6	DBJ,TW	<b>0 445 120 054</b>	<b>0 986 435 545</b>
					6	DBJ,TW	<b>0 445 120 273</b>	<b>0 986 435 571</b>
					6	DBJ,TW	<b>0 445 120 346</b>	<b>0 986 435 662</b>
30 [03]	5,9	220	F4AE3681A*..	09.05-01.14	6	DBJ,TW	<b>0 445 120 054</b>	<b>0 986 435 545</b>
					6	DBJ,TW	<b>0 445 120 273</b>	<b>0 986 435 571</b>
<b>260 E</b> 28 [03]	5,9	202	F4AE0681A*C..	09.03-08.05	6	DBJ	<b>0 445 120 273</b>	<b>0 986 435 571</b>
<b>320 E</b> 28	5,9	202	F4AE0681A*C..	09.00-08.03	6	DBJ	<b>0 445 120 273</b>	<b>0 986 435 571</b>
<b>Eurofire</b>								
<b>150 E</b> 32	6,7	235	F4AFE611D* <Tector 7>	09.15→	6	DBJ	<b>0 445 120 346</b>	<b>0 986 435 662</b>
<b>EuroFire</b>								
<b>140 E</b> 25	6,7	185	F4AFE611E* <Tector 7>	09.13→	6	DBJ	<b>0 445 120 346</b>	<b>0 986 435 662</b>
<b>160 E</b> 32	6,7	235	F4AFE611D* <Tector 7>	09.15→	6	DBJ	<b>0 445 120 346</b>	<b>0 986 435 662</b>
<b>Euromidi CC</b>								
<b>100 E</b> 22	5,9	162	F4AEE681 <Tector 6 - Euro 3>	07.13→	6	DBJ	<b>0 445 120 054</b>	<b>0 986 435 545</b>
22, 25	6,7	162/185	F4AFE611C* <Tector 7>; F4AFE611E* <Tector 7>	12.13→	6	DBJ	<b>0 445 120 346</b>	<b>0 986 435 662</b>
<b>150 E</b> 25	6,7	185	F4AFE611E* <Tector 7>	09.13→	6	DBJ	<b>0 445 120 346</b>	<b>0 986 435 662</b>
<b>Iveco</b>								
<b>2.8 D</b>	2,8	125	Sofim	12.04→	4	<del>DBJ</del>	<b>0 445 120 002</b>	<b>0 986 435 501</b>
<b>Magelys</b>								
	8,7	294	F2CFE612A <Cursor 9 - Euro 6>	07.14→	6	<del>DBJ</del>	<b>0 445 120 157</b>	<b>0 986 435 564</b>
<b>Scudato</b>								
<b>70 C</b> 17	3,0	125	F1C DS <Euro 5 / P-7 (EGR)>	04.12→	4	<del>DBJ</del>	<b>0 445 116 059</b>	<b>0 986 435 395</b>





Stralis Hi-Way									
310	8,7	228	F2CFE611D*C <CURSOR 9>	07.13→	6	DBJ	0 445 120 157	0 986 435 564	
[16]	8,7	228	F2CFE611D*C <CURSOR 9>	01.17→	6	DBJ	0 445 120 157	0 986 435 564	
330	8,7	243	F2CFE611C*C <CURSOR 9>	07.13→	6	DBJ	0 445 120 157	0 986 435 564	
[16]	8,7	243	F2CFE611C*C <CURSOR 9>	01.17→	6	DBJ	0 445 120 157	0 986 435 564	
360	8,7	265	F2CFE611B <Euro 6>	07.13→	6	DBJ	0 445 120 157	0 986 435 564	
[16]	8,7	265	F2CFE611B <Euro 6>	08.16→	6	DBJ	0 445 120 157	0 986 435 564	
400	8,7	294	F2CFE611A <Euro 6>	07.13→	6	DBJ	0 445 120 157	0 986 435 564	
[16]	8,7	294	F2CFE611A <Euro 6>	08.16→	6	DBJ	0 445 120 157	0 986 435 564	
420	11,1	309	F3GFE611D* <Cursor 11>						
			Mot.-Nr. F3G39798→	07.13→	6	DBJ	0 445 124 036	0 986 435 674	
			Mot.-Nr. →F3G39797	07.13→	6	DBJ	0 445 124 015	0 986 435 663	
[16]	11,1	309	F3GFE611F <Euro 6>	08.16→	4	DBJ	0 445 124 036	0 986 435 674	
460	11,1	338	F3GFE611B* <Cursor 11>						
			Mot.-Nr. F3G39798→	07.13→	6	DBJ	0 445 124 036	0 986 435 674	
			Mot.-Nr. →F3G39797	07.13→	6	DBJ	0 445 124 015	0 986 435 663	
[16]	11,1	338	F3GFE611E <Euro 6>	08.16→	4	DBJ	0 445 124 036	0 986 435 674	
			Mot.-Nr. F3G39798→	08.16→	4	DBJ	0 445 124 036	0 986 435 674	
			Mot.-Nr. →F3G39797	08.16→	4	DBJ	0 445 124 015	0 986 435 663	
480	11,1	353	F3GFE611A* <Cursor 11>						
			Mot.-Nr. F3G39798→	07.13→	6	DBJ	0 445 124 036	0 986 435 674	
			Mot.-Nr. →F3G39797	07.13→	6	DBJ	0 445 124 015	0 986 435 663	
[16]	12,9	358	F3GF... <Euro 6>; F3GFL611D <Euro 6>	08.16→	6	DBJ	0 445 124 036	0 986 435 674	
500	12,9	368	F3HFE611B* <Cursor 13>						
			Mot.-Nr. →16791	07.13→	6	DBJ	0 445 124 015	0 986 435 663	
			Mot.-Nr. 16792→	07.13→	6	DBJ	0 445 124 036	0 986 435 674	
[16]	12,9	368	F3HFE611B* <Cursor 13>	08.16→	6	DBJ	0 445 124 036	0 986 435 674	
510 [16]	12,9	375	F3HFE611G <Euro 6>	08.16→	4	DBJ	0 445 124 036	0 986 435 674	
560	12,9	412	F3HFE611A* <Cursor 13>						
			Mot.-Nr. →16791	07.13→	6	DBJ	0 445 124 015	0 986 435 663	
			Mot.-Nr. 16792→	07.13→	6	DBJ	0 445 124 036	0 986 435 674	
[16]	8,7	228	F2CFE611D*C <CURSOR 9>	01.17→	6	DBJ	0 445 120 157	0 986 435 564	
	12,9	412	F3HFE611A* <Cursor 13>	08.16→	6	DBJ	0 445 124 036	0 986 435 674	
570 [16]	12,9	420	F3HF... <Cursor 13>	08.16→	6	DBJ	0 445 124 036	0 986 435 674	
Stralis X-Way									
330	8,7	243	F2CFE611C*C <CURSOR 9>	01.18→	6	DBJ	0 445 120 157	0 986 435 564	
360	8,7	265	F2CFE611B <Euro 6>	08.17→	6	DBJ	0 445 120 157	0 986 435 564	
400	8,7	294	F2CFE611A <Euro 6>	08.17→	6	DBJ	0 445 120 157	0 986 435 564	
420	11,1	309	F3GFE611F <Euro 6>	08.17→	4	DBJ	0 445 124 036	0 986 435 674	
460	11,1	338	F3GFE611E <Euro 6>	08.17→	4	DBJ	0 445 124 036	0 986 435 674	
480	11,1	358	F3GF... <Euro 6>; F3GFE611G <Euro 6>	08.17→	6	DBJ	0 445 124 036	0 986 435 674	
	12,9	358	F3GF... <Euro 6>	08.17→	6	DBJ	0 445 124 036	0 986 435 674	
510	12,9	375	F3HFE611G <Euro 6>	08.17→	4	DBJ	0 445 124 036	0 986 435 674	
570	12,9	420	F3HF... <Cursor 13>	08.17→	6	DBJ	0 445 124 036	0 986 435 674	
			F3HF... <Euro 6>	01.18→	4	DBJ	0 445 124 036	0 986 435 674	
Trakker									
190T 31, 33, 36 [13]	8,7	228/243/265	F2CFE611B <Euro 6>; F2CFE611C*C <CURSOR 9>; F2CFE611D*C <CURSOR 9>	11.13→	6	DBJ	0 445 120 157	0 986 435 564	
41 [13]	12,9	302	F3HFE611D*C <CURSOR 13>						
			Mot.-Nr. →16791	11.13→	6	DBJ	0 445 124 015	0 986 435 663	
			Mot.-Nr. 16792→	11.13→	6	DBJ	0 445 124 036	0 986 435 674	
45 [13]	12,9	331	F3HFE611C*C <CURSOR 13>						
			Mot.-Nr. →16791	11.13→	6	DBJ	0 445 124 015	0 986 435 663	
			Mot.-Nr. 16792→	11.13→	6	DBJ	0 445 124 036	0 986 435 674	
260T 33, 36, 41 [13]	8,7	243/265/302	F2CFE611A <Euro 6>; F2CFE611B <Euro 6>; F2CFE611C*C <CURSOR 9>	11.13→	6	DBJ	0 445 120 157	0 986 435 564	
41 [13]	12,9	302	F3HFE611D*C <CURSOR 13>	11.13→	6	DBJ,TW	0 445 120 157	0 986 435 564	
			Mot.-Nr. →16791	11.13→	6	DBJ,TW	0 445 124 015	0 986 435 663	
			Mot.-Nr. 16792→	11.13→	6	DBJ,TW	0 445 124 036	0 986 435 674	





<b>720T 50 [13]</b>	12,9	368	F3HFE611... <Cursor 13>						
			Mot.-Nr. →16791	11.13→	6	DBJ	<b>0 445 124 015</b>	<b>0 986 435 663</b>	
			Mot.-Nr. 16792→	11.13→	6	DBJ	<b>0 445 124 036</b>	<b>0 986 435 674</b>	
<b>Urbanway</b>									
<b>12</b>	8,7	228/294	F2CFE612A <Cursor 9 - Euro 6>; F2CFE612D <Cursor 9 - Euro 6>	06.13→	6	DBJ	<b>0 445 120 157</b>	<b>0 986 435 564</b>	
<b>18</b>	8,7	228/294	F2CFE612A <Cursor 9 - Euro 6>; F2CFE612D <Cursor 9 - Euro 6>	06.13→	6	DBJ	<b>0 445 120 157</b>	<b>0 986 435 564</b>	

**KAVZ KURGAN**

<b>Serie 4000</b>									
<b>4235</b>	3,9	110	ISBe 150 31 <Euro 3>	09.08→	4	DBJ	<b>0 445 120 123</b>		
	4,5	136	4ISBe185B <Euro 3>	09.08→	4	DBJ	<b>0 445 120 123</b>		
<b>4238</b>	4,8	158	TCD 2013 L04 4V <Euro 3>	01.10→	4	DBB	<b>0 445 120 074</b>	<b>0 986 435 536</b>	
	6,7	155	6ISBe 210 <Euro 3>	09.08→	6	DBJ	<b>0 445 120 123</b>		
<b>Serie 320000</b>									
<b>324410</b>	4,8	115	D 245.30 E3 <Euro 3>	01.08→	4	DBJ	<b>0 445 120 141</b>		

**LDV GROUP LIMITED**

<b>Maxus</b>									
<b>2.5 CRD</b>	2,5	70-88	VM39C; VM40C	01.05-06.11	4	DBJ	<b>0 445 110 059</b>	<b>0 986 435 149</b>	

**LIAZ LIKINSKI (RUS)**

<b>Serie 6000</b>									
<b>6212</b>	11,1	303	650 DCi 11 <Euro 3>	06.08→	6	DBJ	<b>0 445 120 142</b>		

**MAHINDRA**

<b>Genio</b>									
<b>2.5 D</b>	2,5	56	mDI CRDe	02.11→	4	DBJ	<b>0 445 110 580</b>		

**MAN**

<b>Bus</b>									
<b>19.290 HOCLN-LE [RC3]</b>	6,9	213	D 0836 LOH64 <Euro 5>	04.14→	6	DBJ	<b>0 445 120 162</b>	<b>0 986 435 565</b>	<b>F 00R J02 175</b>
<b>26.430 HOCLN-SD [RR4]</b>	10,5	316	D 2066 LOH10 <Euro 3>	05.13→	6	DBJ	<b>0 445 120 218</b>	<b>0 986 435 517</b>	<b>F 00R J02 175</b>
<b>26.440 HOCLN-SD [RR4]</b>	12,4	324	D 2676 LOH26 <Euro 5/EEV/OBD2>	08.14→	6	DBJ	<b>0 445 120 202</b>	<b>0 986 435 570</b>	<b>F 00R J02 175</b>
<b>26.480 HOCLN-DD [RR6]</b>	12,4	353	D 2676 LOH04 <Euro 4/OBD1>	02.12→	6	DBJ	<b>0 445 120 219</b>	<b>0 986 435 528</b>	<b>F 00R J02 175</b>
HOCLN-SD [RR4]	12,4	353	D 2676 LOH04 <Euro 4/OBD1>	04.13→	6	DBJ	<b>0 445 120 219</b>	<b>0 986 435 528</b>	<b>F 00R J02 175</b>
			D 2676 LOH27 <Euro 5/EEV/OBD2>	06.09→	6	DBJ	<b>0 445 120 202</b>	<b>0 986 435 570</b>	<b>F 00R J02 175</b>
			D 2676 LOH31 <Euro 6>	04.13→	6	DBJ	<b>0 445 120 354</b>	<b>0 986 435 650</b>	<b>F 00R J02 175</b>
			D 2676 LOH33 <Euro 4>; D 2676 LOH34 <Euro 5/EEV>	03.15→	6	DBJ	<b>0 445 120 219</b>	<b>0 986 435 528</b>	<b>F 00R J02 175</b>
<b>26.500 HOCLN-DD [RR6]</b>	12,4	371	D 2676 LOH28 <EEV/OBD2>	03.09→	6	DBJ	<b>0 445 120 202</b>	<b>0 986 435 570</b>	<b>F 00R J02 175</b>
<b>Bus 12t</b>									
<b>12.240 HOCLN-NL [A76]</b>	6,9	176	D 0836 LOH41 <Euro 3>	03.05-09.08	6	DBJ	<b>0 445 120 045</b>	<b>0 986 435 558</b>	<b>F 00R J02 175</b>
			D 0836 LOH52 <Euro 4/OBD1>	02.06-09.09	6	DBJ	<b>0 445 120 147</b>	<b>0 986 435 562</b>	<b>F 00R J02 175</b>
			D 0836 LOH56 <Euro 4/OBD1>	03.07-09.09	6	DBJ	<b>0 445 120 147</b>	<b>0 986 435 562</b>	<b>F 00R J02 175</b>
			D 0836 LOH58 <Euro 4>	03.07-09.09	6	DBJ	<b>0 445 120 147</b>	<b>0 986 435 562</b>	<b>F 00R J02 175</b>
HOCLN-NL-CIB [A80]	6,9	177	D 0836 LOH56 <Euro 4>	03.07→	6	DBJ	<b>0 445 120 147</b>	<b>0 986 435 562</b>	<b>F 00R J02 175</b>
<b>12.250 HOCLN-NL-CIB [A80]</b>	6,9	184	D 0836 LOH 65 <Euro 5>	02.10→	6	DBJ	<b>0 445 120 162</b>	<b>0 986 435 565</b>	<b>F 00R J02 175</b>





◀ MAN

<b>12.280</b>	HOCL-NL-CIB [A80]	6,9	206	D 0836 LOH55 <Euro 4/OBD1>	04.08→	6	DBJ	<b>0 445 120 147</b>	<b>0 986 435 562</b>	<b>F 00R J02 175</b>
<b>Bus 14t</b>										
<b>14.240</b>	HOCL-NL [A66]	6,9	176	D 0836 LOH41 <Euro 3>	01.04-09.08	6	DBJ	<b>0 445 120 045</b>	<b>0 986 435 558</b>	<b>F 00R J02 175</b>
				D 0836 LOH52 <Euro 4/OBD1>	01.06-08.09	6	DBJ	<b>0 445 120 147</b>	<b>0 986 435 562</b>	<b>F 00R J02 175</b>
				D 0836 LOH56 <Euro 4/OBD1>	03.07-09.09	6	DBJ	<b>0 445 120 147</b>	<b>0 986 435 562</b>	<b>F 00R J02 175</b>
				D 0836 LOH58 <Euro 4>	03.07-09.09	6	DBJ	<b>0 445 120 147</b>	<b>0 986 435 562</b>	<b>F 00R J02 175</b>
<b>14.250</b>	HOCL-NL [A66]	6,9	184	D 0836 LOH61 <Euro 5/EEV/OBD2>; D 0836 LOH65 <Euro 5/EEV>	01.09→	6	DBJ	<b>0 445 120 162</b>	<b>0 986 435 565</b>	<b>F 00R J02 175</b>
<b>14.260</b>	HOCL-NL [A66]	6,9	191	D 0836 LOH62 <Euro 4>	02.10→	6	DBJ,TW	<b>0 445 120 147</b>	<b>0 986 435 562</b>	<b>F 00R J02 175</b>
						6	DBJ,TW	<b>0 445 120 162</b>	<b>0 986 435 565</b>	<b>F 00R J02 175</b>
<b>14.280</b>	HOCL-NL [A66]	6,9	206	D 0836 LOH51 <Euro 4>	09.05-08.09	6	DBJ	<b>0 445 120 147</b>	<b>0 986 435 562</b>	<b>F 00R J02 175</b>
				D 0836 LOH55 <Euro 4/OBD1>	01.07-09.10	6	DBJ	<b>0 445 120 147</b>	<b>0 986 435 562</b>	<b>F 00R J02 175</b>
				D 0836 LOH57 <Euro 4>	01.07-09.10	6	DBJ	<b>0 445 120 147</b>	<b>0 986 435 562</b>	<b>F 00R J02 175</b>
	HOCL-SR [A67]	6,9	206	D 0836 LOH51 <Euro 4>; D 0836 LOH55 <Euro 4/OBD1>	02.06-09.10	6	DBJ	<b>0 445 120 147</b>	<b>0 986 435 562</b>	<b>F 00R J02 175</b>
<b>14.290</b>	HOCL-NL [A66]	6,9	213	D 0836 LOH60	06.11→	6	DBJ	<b>0 445 120 162</b>	<b>0 986 435 565</b>	<b>F 00R J02 175</b>
	HOCL-SR [A67]	6,9	213	D 0836 LOH64 <Euro 5>	02.10→	6	DBJ	<b>0 445 120 162</b>	<b>0 986 435 565</b>	<b>F 00R J02 175</b>
<b>Bus 18t</b>										
<b>18.240</b>	HOCL-NL [A69]	6,9	176	D 0836 LOH41 <Euro 3>	03.05-09.08	6	DBJ	<b>0 445 120 045</b>	<b>0 986 435 558</b>	<b>F 00R J02 175</b>
				D 0836 LOH52 <Euro 4/OBD1>; D 0836 LOH56 <Euro 4/OBD1>	03.06-09.09	6	DBJ	<b>0 445 120 147</b>	<b>0 986 435 562</b>	<b>F 00R J02 175</b>
<b>18.250</b>	HOCL-R-CIB [A94]	6,9	184	D 0836 LOH65 <Euro 5/EEV>	01.12→	6	DBJ	<b>0 445 120 162</b>	<b>0 986 435 565</b>	<b>F 00R J02 175</b>
<b>18.260</b>	HOCL-NL [A69]	6,9	191	D 0836 LOH62 <Euro 4>	02.11→	6	DBJ,TW	<b>0 445 120 147</b>	<b>0 986 435 562</b>	<b>F 00R J02 175</b>
						6	DBJ,TW	<b>0 445 120 162</b>	<b>0 986 435 565</b>	<b>F 00R J02 175</b>
<b>18.280</b>	HOCL-R-NL-CIB [A84]	6,9	206	D 0836 LOH40 <Euro 3>	03.07→	6	DBJ	<b>0 445 120 045</b>	<b>0 986 435 558</b>	<b>F 00R J02 175</b>
<b>18.290</b>	HOCL-NL [A69]	6,9	213	D 0836 LOH60; D 0836 LOH64 <Euro 5>	02.10→	6	DBJ	<b>0 445 120 162</b>	<b>0 986 435 565</b>	<b>F 00R J02 175</b>
	HOCL-R-CIB [A94]	6,9	213	D 0836 LOH64 <Euro 5>	01.14→	6	DBJ	<b>0 445 120 162</b>	<b>0 986 435 565</b>	<b>F 00R J02 175</b>
<b>18.310</b>	HOCL-NL [A69]	10,5	228	D 2066 LUH12 <Euro 4>; D 2066 LUH22 <Euro 4/OBD1>	03.06-05.09	6	DBJ	<b>0 445 120 217</b>	<b>0 986 435 526</b>	<b>F 00R J02 175</b>
<b>18.320</b>	HOCL-NL [R33]	10,5	235	D 2066 LOH01 <Euro 4>	10.06→	6	DBJ	<b>0 445 120 217</b>	<b>0 986 435 526</b>	<b>F 00R J02 175</b>
	HOCL-NL [A69]	10,5	235	D 2066 LUH32 <V6400, Euro5>	09.10→	6	DBJ	<b>0 445 120 197</b>	<b>0 986 435 569</b>	<b>F 00R J02 175</b>
<b>18.350</b>	HOCL-NL [R33]	10,5	257	D 2066 LOH12 <Euro 3>	09.08-09.12	6	DBJ,TW	<b>0 445 120 217</b>	<b>0 986 435 526</b>	<b>F 00R J02 175</b>
						6	DBJ,TW	<b>0 445 120 218</b>	<b>0 986 435 517</b>	<b>F 00R J02 175</b>
	HOCL-R CIB [R38]	10,5	257	D 2066 LOH12 <Euro 3>	06.09→	6	DBJ,TW	<b>0 445 120 217</b>	<b>0 986 435 526</b>	<b>F 00R J02 175</b>
						6	DBJ,TW	<b>0 445 120 218</b>	<b>0 986 435 517</b>	<b>F 00R J02 175</b>
<b>18.360</b>	HOCL-NL [R33]	10,5	265	D 2066 LOH02 <Euro 4>	10.06→	6	DBJ	<b>0 445 120 217</b>	<b>0 986 435 526</b>	<b>F 00R J02 175</b>
				D 2066 LOH06 <Euro 4/OBD1>	10.06→	6	DBJ	<b>0 445 120 217</b>	<b>0 986 435 526</b>	<b>F 00R J02 175</b>
				D 2066 LOH27 <Euro5/EEV/OBD2>	09.09→	6	DBJ	<b>0 445 120 201</b>	<b>0 986 435 656</b>	<b>F 00R J02 175</b>
<b>18.400</b>	HOCL-NL [R33]	10,5	294	D 2066 LOH03 <Euro 4>	10.06→	6	DBJ	<b>0 445 120 217</b>	<b>0 986 435 526</b>	<b>F 00R J02 175</b>
				D 2066 LOH07 <Euro 4/OBD1>	10.06→	6	DBJ	<b>0 445 120 217</b>	<b>0 986 435 526</b>	<b>F 00R J02 175</b>
				D 2066 LOH28 <Euro5/EEV/OBD2>	09.09→	6	DBJ	<b>0 445 120 201</b>	<b>0 986 435 656</b>	<b>F 00R J02 175</b>
	HOCL-R LBC [A82]	10,5	294	D 2066 LF06 <Euro 2>	04.06-05.09	6	DBJ	<b>0 445 120 218</b>	<b>0 986 435 517</b>	<b>F 00R J02 175</b>
<b>18.430</b>	HOCL-NL [R33]	10,5	316	D 2066 LOH10 <Euro 3>	03.08→	6	DBJ	<b>0 445 120 218</b>	<b>0 986 435 517</b>	<b>F 00R J02 175</b>
	HOCL-R CIB [R39]	10,5	316	D 2066 LOH10 <Euro 3>	07.07→	6	DBJ	<b>0 445 120 218</b>	<b>0 986 435 517</b>	<b>F 00R J02 175</b>
<b>18.440</b>	HOCL-NL [R33]	10,5	324	D 2066 LOH04 <Euro 4>	10.06→	6	DBJ	<b>0 445 120 217</b>	<b>0 986 435 526</b>	<b>F 00R J02 175</b>
				D 2066 LOH08 <Euro 4/OBD1>	10.06→	6	DBJ	<b>0 445 120 217</b>	<b>0 986 435 526</b>	<b>F 00R J02 175</b>
		12,4	324	D 2676 LOH26 <Euro 5/EEV/OBD2>	09.09→	6	DBJ	<b>0 445 120 202</b>	<b>0 986 435 570</b>	<b>F 00R J02 175</b>
	HOCL-R CIB [R39]	10,5	324	D 2066 LOH08 <Euro 4/OBD1>	03.11→	6	DBJ	<b>0 445 120 217</b>	<b>0 986 435 526</b>	<b>F 00R J02 175</b>
<b>18.480</b>	HOCL-NL [R33]	12,4	353	D 2676 LOH02 <Euro 4>; D 2676 LOH04 <Euro 4/OBD1>	09.05-09.09	6	DBJ	<b>0 445 120 219</b>	<b>0 986 435 528</b>	<b>F 00R J02 175</b>
				D 2676 LOH27 <Euro 5/EEV/OBD2>	09.09→	6	DBJ	<b>0 445 120 202</b>	<b>0 986 435 570</b>	<b>F 00R J02 175</b>
	HOCL-R CIB [R39]	12,4	353	D 2676 LOH04 <Euro 4/OBD1>	02.11→	6	DBJ	<b>0 445 120 219</b>	<b>0 986 435 528</b>	<b>F 00R J02 175</b>
<b>Bus 19t</b>										
<b>19.250</b>	HOCL-LE-SD, HOCL-LE-SD [RC2]	6,9	184	D 0836 LOH65 <Euro 5/EEV>; D 0836 LOH73 <Euro 6>	01.15→	6	DBJ	<b>0 445 120 162</b>	<b>0 986 435 565</b>	<b>F 00R J02 175</b>







<b>19.250</b>	HOCL-LS-SD [RR8]	6,9	184	D 0836 LOH65 <Euro 5/EEV>	02.13→	6	DBJ	<b>0 445 120 162</b>	<b>0 986 435 565</b>	<b>F 00R J02 175</b>
	HOCL-ÜL-CIB [RR9]	6,9	184	D 0836 LOH65 <Euro 5/EEV>	05.13→	6	DBJ	<b>0 445 120 162</b>	<b>0 986 435 565</b>	<b>F 00R J02 175</b>
<b>19.280</b>	HOCL-LS-SD [RR8]	6,9	206	D 0836 LOH40 <Euro 3>	07.13→	6	DBJ	<b>0 445 120 045</b>	<b>0 986 435 558</b>	<b>F 00R J02 175</b>
				D 0836 LOH55 <Euro 4/OBD1>	02.08→	6	DBJ	<b>0 445 120 147</b>	<b>0 986 435 562</b>	<b>F 00R J02 175</b>
<b>19.290</b>	HOCL-LE-SD [RC2]	6,9	213	D 0836 LOH64 <Euro 5>	01.15→	6	DBJ	<b>0 445 120 162</b>	<b>0 986 435 565</b>	<b>F 00R J02 175</b>
				D 0836 LOH72 <Euro 6>	01.15→	6	DBJ	<b>0 445 120 162</b>	<b>0 986 435 565</b>	<b>F 00R J02 175</b>
	HOCL-LS-SD [RR8]	6,9	213	D 0836 LOH64 <Euro 5>; D 0836 LOH72 <Euro 6>	03.08→	6	DBJ	<b>0 445 120 162</b>	<b>0 986 435 565</b>	<b>F 00R J02 175</b>
<b>19.310</b>	HOCL-LE-SD [RC2]	10,5	228	D 2066 LUH22 <Euro 4/OBD1>	02.14→	6	DBJ	<b>0 445 120 217</b>	<b>0 986 435 526</b>	<b>F 00R J02 175</b>
<b>19.320</b>	HOCL-LE-SD [RC2]	10,5	235	D 2066 LUH32 <V6400, Euro5>	01.09→	6	DBJ	<b>0 445 120 197</b>	<b>0 986 435 569</b>	<b>F 00R J02 175</b>
	HOCL-LS-SD [RR8]	10,5	235	D 2066 LUH32 <V6400, Euro5>	07.11→	6	DBJ	<b>0 445 120 197</b>	<b>0 986 435 569</b>	<b>F 00R J02 175</b>
<b>19.360</b>	HOCL-LS-SD [RR8]	10,5	265	D 2066 LUH33 <V6400, Euro5>	01.13→	6	DBJ	<b>0 445 120 197</b>	<b>0 986 435 569</b>	<b>F 00R J02 175</b>
<b>19.430</b>	HOCL-CIB [RR3]	10,5	316	D 2066 LOH10 <Euro 3>	01.14→	6	DBJ	<b>0 445 120 218</b>	<b>0 986 435 517</b>	<b>F 00R J02 175</b>
<b>Bus 24t</b>										
<b>24.320</b>	HOCLN [R37]	10,5	235	D 2066 LOH01 <Euro 4>	10.06→	6	DBJ	<b>0 445 120 217</b>	<b>0 986 435 526</b>	<b>F 00R J02 175</b>
<b>24.360</b>	HOCLN [R37]	10,5	265	D 2066 LOH02 <Euro 4>	10.06→	6	DBJ	<b>0 445 120 217</b>	<b>0 986 435 526</b>	<b>F 00R J02 175</b>
<b>24.400</b>	HOCLN [R37]	10,5	294	D 2066 LOH03 <Euro 4>	10.06→	6	DBJ	<b>0 445 120 217</b>	<b>0 986 435 526</b>	<b>F 00R J02 175</b>
<b>24.440</b>	HOCLN [R37]	10,5	324	D 2066 LOH04 <Euro 4>	10.06→	6	DBJ	<b>0 445 120 217</b>	<b>0 986 435 526</b>	<b>F 00R J02 175</b>
<b>24.460</b>	HOCLN CIB [R40]	12,4	338	D 2676 LOH10 <Euro 3>	04.11→	6	DBJ	<b>0 445 120 219</b>	<b>0 986 435 528</b>	<b>F 00R J02 175</b>
	HOCLN/R [R37]	12,4	338	D 2676 LOH10 <Euro 3>	09.11→	6	DBJ	<b>0 445 120 219</b>	<b>0 986 435 528</b>	<b>F 00R J02 175</b>
<b>24.480</b>	HOCLN CIB [R40]	12,4	353	D 2676 LOH04 <Euro 4/OBD1>	02.12→	6	DBJ	<b>0 445 120 219</b>	<b>0 986 435 528</b>	<b>F 00R J02 175</b>
	HOCLN/R [R37]	12,4	353	D 2676 LOH02 <Euro 4>; D 2676 LOH04 <Euro 4/OBD1>	03.06-09.09	6	DBJ	<b>0 445 120 219</b>	<b>0 986 435 528</b>	<b>F 00R J02 175</b>
				D 2676 LOH27 <Euro 5/EEV/OBD2>	09.09→	6	DBJ	<b>0 445 120 202</b>	<b>0 986 435 570</b>	<b>F 00R J02 175</b>
<b>Lion's City</b>										
	[A37]	6,9	176/206	D 0836 LOH51 <Euro 4>; D 0836 LOH52 <Euro 4>	01.06→	6	DBJ	<b>0 445 120 147</b>	<b>0 986 435 562</b>	<b>F 00R J02 175</b>
			184/213	D 0836 LOH60; D 0836 LOH61 <Euro 5/EEV/OBD2>	02.09→	6	DBJ	<b>0 445 120 162</b>	<b>0 986 435 565</b>	<b>F 00R J02 175</b>
			191	D 0836 LOH62 <Euro 4>	07.06→	6	DBJ,TW	<b>0 445 120 147</b>	<b>0 986 435 562</b>	<b>F 00R J02 175</b>
						6	DBJ,TW	<b>0 445 120 162</b>	<b>0 986 435 565</b>	<b>F 00R J02 175</b>
			191/206	D 0836 LOH55 <Euro 4/OBD1>; D 0836 LOH63 <Euro 4>	04.07→	6	DBJ	<b>0 445 120 147</b>	<b>0 986 435 562</b>	<b>F 00R J02 175</b>
			206	D 0836 LOH50 <Euro 4>	08.05→	6	DBJ	<b>0 445 120 045</b>	<b>0 986 435 558</b>	<b>F 00R J02 175</b>
<b>C</b>	[A36]	10,5	264	D 2066 LUH48 <Euro 5/EEV/OBD2>	03.13→	6	DBJ	<b>0 445 120 197</b>	<b>0 986 435 569</b>	<b>F 00R J02 175</b>
<b>CLE</b>	[A45]	10,5	264	D 2066 LUH48 <Euro 5/EEV/OBD2>	02.13→	6	DBJ	<b>0 445 120 197</b>	<b>0 986 435 569</b>	<b>F 00R J02 175</b>
<b>LLE</b>	[A44]	10,5	235	D 2066 LUH47 <Euro 5/EEV/OBD2>	06.12→	6	DBJ	<b>0 445 120 197</b>	<b>0 986 435 569</b>	<b>F 00R J02 175</b>
<b>Lion's City / NL</b>										
	[A21]	6,9	206	D 0836 LUH40 <Euro 3>	06.04-09.06	6	DBJ	<b>0 445 120 045</b>	<b>0 986 435 558</b>	<b>F 00R J02 175</b>
		10,5	199	D 2066 LUH21 <Euro 4/OBD1>	04.07→	6	DBJ	<b>0 445 120 217</b>	<b>0 986 435 526</b>	<b>F 00R J02 175</b>
				D 2066 LUH26 <Euro 4/OBD1>	05.07→	6	DBJ	<b>0 445 120 217</b>	<b>0 986 435 526</b>	<b>F 00R J02 175</b>
			199/228	D 2066 LUH16 <Euro 4/OBD1>; D 2066 LUH17 <Euro 4/OBD1>	08.06→	6	DBJ	<b>0 445 120 217</b>	<b>0 986 435 526</b>	<b>F 00R J02 175</b>
			206	D 2066 LUH41 <Euro 5/EEV/OBD2>	04.07→	6	DBJ	<b>0 445 120 197</b>	<b>0 986 435 569</b>	<b>F 00R J02 175</b>
				D 2066 LUH46 <Euro 5/EEV/OBD2>	03.09→	6	DBJ	<b>0 445 120 197</b>	<b>0 986 435 569</b>	<b>F 00R J02 175</b>
			228	D 2066 LUH22 <Euro 4/OBD1>	04.07→	6	DBJ	<b>0 445 120 217</b>	<b>0 986 435 526</b>	<b>F 00R J02 175</b>
				D 2066 LUH27 <Euro 4/OBD1>	06.07→	6	DBJ	<b>0 445 120 217</b>	<b>0 986 435 526</b>	<b>F 00R J02 175</b>
			235	D 2066 LUH47 <Euro 5/EEV/OBD2>	03.09→	6	DBJ	<b>0 445 120 197</b>	<b>0 986 435 569</b>	<b>F 00R J02 175</b>
			235/264	D 2066 LUH42 <Euro 5/EEV>; D 2066 LUH43 <Euro 5/EEV>	07.07→	6	DBJ	<b>0 445 120 197</b>	<b>0 986 435 569</b>	<b>F 00R J02 175</b>







◀ MAN

[A21]	10,5	257	D 2066 LUH23 <Euro 4/OBD1>	06.07→	6	DBJ	0 445 120 217	0 986 435 526	F 00R J02 175
		264	D 2066 LUH48 <Euro 5/EEV/OBD2>	06.09→	6	DBJ	0 445 120 197	0 986 435 569	F 00R J02 175
<b>NL 243</b> [A37]	6,9	176	D 0836 LOH41 <Euro 3>	01.02-09.06	6	DBJ	0 445 120 045	0 986 435 558	F 00R J02 175
<b>NL 283</b> [A37]	6,9	206	D 0836 LOH40 <Euro 3>	01.02-09.06	6	DBJ	0 445 120 045	0 986 435 558	F 00R J02 175
<b>Lion's City DD / ND</b>									
<b>ND 313</b> [A39]	10,5	228	D 2066 LUH12 <Euro 4>; D 2066 LUH17 <Euro 4/OBD1>	04.06-08.14	6	DBJ	0 445 120 217	0 986 435 526	F 00R J02 175
			D 2066 LUH27 <Euro 4/OBD1>	04.07-08.14	6	DBJ	0 445 120 217	0 986 435 526	F 00R J02 175
		235	D 2066 LUH47 <Euro 5/EEV/OBD2>	01.09-08.14	6	DBJ	0 445 120 197	0 986 435 569	F 00R J02 175
		257	D 2066 LUH13 <Euro 4>	04.07-08.14	6	DBJ	0 445 120 217	0 986 435 526	F 00R J02 175
<b>ND 363</b> [A39]	10,5	264	D 2066 LUH48 <Euro 5/EEV/OBD2>	01.09-08.14	6	DBJ	0 445 120 197	0 986 435 569	F 00R J02 175
<b>Lion's City G / GL</b>									
[A23]	10,5	199	D 2066 LUH11 <Euro 4>	01.07→	6	DBJ	0 445 120 217	0 986 435 526	F 00R J02 175
		199/257	D 2066 LUH21 <Euro 4/OBD1>; D 2066 LUH23 <Euro 4/OBD1>	08.07→	6	DBJ	0 445 120 217	0 986 435 526	F 00R J02 175
		206	D 2066 LUH46 <Euro 5/EEV/OBD2>	08.09→	6	DBJ	0 445 120 197	0 986 435 569	F 00R J02 175
		228	D 2066 LUH12 <Euro 4>	10.06-12.09	6	DBJ	0 445 120 217	0 986 435 526	F 00R J02 175
			D 2066 LUH17 <Euro 4/OBD1>	01.07→	6	DBJ	0 445 120 217	0 986 435 526	F 00R J02 175
			D 2066 LUH22 <Euro 4/OBD1>	04.07→	6	DBJ	0 445 120 217	0 986 435 526	F 00R J02 175
			D 2066 LUH27 <Euro 4/OBD1>	04.07→	6	DBJ	0 445 120 217	0 986 435 526	F 00R J02 175
		235	D 2066 LUH42 <Euro 5/EEV>	07.07→	6	DBJ	0 445 120 197	0 986 435 569	F 00R J02 175
			D 2066 LUH47 <Euro 5/EEV/OBD2>	03.09→	6	DBJ	0 445 120 197	0 986 435 569	F 00R J02 175
		257	D 2066 LUH02 <Euro 4>	10.06-12.09	6	DBJ	0 445 120 217	0 986 435 526	F 00R J02 175
			D 2066 LUH13 <Euro 4>	02.07→	6	DBJ	0 445 120 217	0 986 435 526	F 00R J02 175
		264	D 2066 LUH43 <Euro 5/EEV>	07.07→	6	DBJ	0 445 120 197	0 986 435 569	F 00R J02 175
			D 2066 LUH48 <Euro 5/EEV/OBD2>	03.09→	6	DBJ	0 445 120 197	0 986 435 569	F 00R J02 175
<b>Lion's City GL</b>									
[A40]	10,5	235/264	D 2066 LUH47 <Euro 5/EEV/OBD2>; D 2066 LUH48 <Euro 5/EEV/OBD2>	06.11→	6	DBJ	0 445 120 197	0 986 435 569	F 00R J02 175
<b>LE</b> [A49]	10,5	264	D 2066 LUH48 <Euro 5/EEV/OBD2>	05.12→	6	DBJ	0 445 120 197	0 986 435 569	F 00R J02 175
<b>Lion's City LL / NL</b>									
[A26]	10,5	228	D 2066 LUH22 <Euro 4/OBD1>	07.07→	6	DBJ	0 445 120 217	0 986 435 526	F 00R J02 175
		228/257	D 2066 LUH12 <Euro 4>; D 2066 LUH17 <Euro 4/OBD1>; D 2066 LUH23 <Euro 4/OBD1>	02.06→	6	DBJ	0 445 120 217	0 986 435 526	F 00R J02 175
		235	D 2066 LUH42 <Euro 5/EEV>	07.07→	6	DBJ	0 445 120 197	0 986 435 569	F 00R J02 175
		235/264/	D 2066 LUH43 <Euro 5/EEV>;	02.09→	6	DBJ	0 445 120 197	0 986 435 569	F 00R J02 175
		265	D 2066 LUH47 <Euro 5/EEV/OBD2>; D 2066 LUH48 <Euro 5/EEV/OBD2>						
		257	D 2066 LUH28 <Euro 4/OBD1>	01.08→	6	DBJ	0 445 120 217	0 986 435 526	F 00R J02 175
<b>Lion's City M / NM</b>									
[A47]	6,9	176	D 0836 LOH52 <Euro 4>	01.06-08.09	6	DBJ	0 445 120 147	0 986 435 562	F 00R J02 175
		184	D 0836 LOH67 <Euro 6>	01.14→	6	DBJ	0 445 120 162	0 986 435 565	F 00R J02 175
		184/213	D 0836 LOH60; D 0836 LOH61 <Euro 5/EEV/OBD2>	09.09→	6	DBJ	0 445 120 162	0 986 435 565	F 00R J02 175
		191	D 0836 LOH62 <Euro 4>	03.07→	6	DBJ,TW	0 445 120 147	0 986 435 562	F 00R J02 175
					6	DBJ,TW	0 445 120 162	0 986 435 565	F 00R J02 175
			D 0836 LOH63 <Euro 4>	03.07→	6	DBJ	0 445 120 147	0 986 435 562	F 00R J02 175
		206	D 0836 LOH40 <Euro 3>	04.05→	6	DBJ	0 445 120 045	0 986 435 558	F 00R J02 175
			D 0836 LOH51 <Euro 4>	01.06-08.09	6	DBJ	0 445 120 147	0 986 435 562	F 00R J02 175
		213	D 0836 LOH66 <Euro 6>	01.14→	6	DBJ	0 445 120 162	0 986 435 565	F 00R J02 175
<b>Lion's City T / TÜ / EL</b>									
[A78]	6,9	191	D 0836 LOH62 <Euro 4>	04.07→	6	DBJ,TW	0 445 120 147	0 986 435 562	F 00R J02 175
					6	DBJ,TW	0 445 120 162	0 986 435 565	F 00R J02 175





[A78]	6,9	206	D 0836 LOH40 <Euro 3>	05.08→	6	DBJ	0 445 120 045	0 986 435 558	F 00R J02 175
			D 0836 LOH50 <Euro 4>	05.05→	6	DBJ	0 445 120 045	0 986 435 558	F 00R J02 175
			D 0836 LOH51 <Euro 4>	08.06→	6	DBJ	0 445 120 147	0 986 435 562	F 00R J02 175
			D 0836 LOH55 <Euro 4/OBD1>	07.07→	6	DBJ	0 445 120 147	0 986 435 562	F 00R J02 175
		213	D 0836 LOH60	04.09→	6	DBJ	0 445 120 162	0 986 435 565	F 00R J02 175
<b>Lion's City Ü</b>									
[A21]	10,5	199	D 2066 LUH11 <Euro 4>	10.06-12.09	6	DBJ	0 445 120 217	0 986 435 526	F 00R J02 175
		228	D 2066 LUH12 <Euro 4>	10.06-12.09	6	DBJ	0 445 120 217	0 986 435 526	F 00R J02 175
<b>Lion's City Ü / NÜ</b>									
[A20]	6,9	206	D 0836 LUH40 <Euro 3>	06.04-09.06	6	DBJ	0 445 120 045	0 986 435 558	F 00R J02 175
	10,5	199	D 2066 LUH16 <Euro 4/OBD1>	07.06→	6	DBJ	0 445 120 217	0 986 435 526	F 00R J02 175
			D 2066 LUH21 <Euro 4/OBD1>	01.08→	6	DBJ	0 445 120 217	0 986 435 526	F 00R J02 175
			D 2066 LUH26 <Euro 4/OBD1>	03.08→	6	DBJ	0 445 120 217	0 986 435 526	F 00R J02 175
		206	D 2066 LUH41 <Euro 5/EEV/OBD2>	02.08→	6	DBJ	0 445 120 197	0 986 435 569	F 00R J02 175
			D 2066 LUH46 <Euro 5/EEV/OBD2>	03.09→	6	DBJ	0 445 120 197	0 986 435 569	F 00R J02 175
		228	D 2066 LUH17 <Euro 4/OBD1>	07.06→	6	DBJ	0 445 120 217	0 986 435 526	F 00R J02 175
			D 2066 LUH22 <Euro 4/OBD1>	05.07→	6	DBJ	0 445 120 217	0 986 435 526	F 00R J02 175
			D 2066 LUH27 <Euro 4/OBD1>	05.07→	6	DBJ	0 445 120 217	0 986 435 526	F 00R J02 175
		235	D 2066 LUH42 <Euro 5/EEV>	07.07→	6	DBJ	0 445 120 197	0 986 435 569	F 00R J02 175
			D 2066 LUH47 <Euro 5/EEV/OBD2>	03.09→	6	DBJ	0 445 120 197	0 986 435 569	F 00R J02 175
		257	D 2066 LUH13 <Euro 4>	05.06→	6	DBJ	0 445 120 217	0 986 435 526	F 00R J02 175
			D 2066 LUH23 <Euro 4/OBD1>	06.07→	6	DBJ	0 445 120 217	0 986 435 526	F 00R J02 175
			D 2066 LUH28 <Euro 4/OBD1>	01.08→	6	DBJ	0 445 120 217	0 986 435 526	F 00R J02 175
		264	D 2066 LUH48 <Euro 5/EEV/OBD2>	06.09→	6	DBJ	0 445 120 197	0 986 435 569	F 00R J02 175
<b>Lion's City ÜLL / NÜ</b>									
NÜ 313 [A25]	10,5	228	D 2066 LUH12 <Euro 4>	05.06-05.08	6	DBJ	0 445 120 217	0 986 435 526	F 00R J02 175
NÜ 353 [A25]	10,5	257	D 2066 LUH13 <Euro 4>	02.06-05.08	6	DBJ	0 445 120 217	0 986 435 526	F 00R J02 175
<b>Lion's Coach</b>									
[R07,R08,R09]	10,5	294	D 2066 LOH03 <Euro 4>	10.06-12.09	6	DBJ	0 445 120 217	0 986 435 526	F 00R J02 175
			D 2066 LOH07 <Euro 4/OBD1>	04.07→	6	DBJ	0 445 120 217	0 986 435 526	F 00R J02 175
			D 2066 LOH28 <Euro 5/EEV/OBD2>	01.09→	6	DBJ	0 445 120 201	0 986 435 656	F 00R J02 175
			D 2066 LOH32 <Euro 6>	03.13→	6	DBJ	0 445 120 353	0 986 435 593	F 00R J02 175
		324	D 2066 LOH08 <Euro 4/OBD1>	04.07→	6	DBJ	0 445 120 217	0 986 435 526	F 00R J02 175
C,L [R07,R08,R09]	10,5	324	D 2066 LOH04 <Euro 4>	09.05-12.09	6	DBJ	0 445 120 217	0 986 435 526	F 00R J02 175
	12,4	324	D 2676 LOH30 <Euro 6>	03.13→	6	DBJ	0 445 120 354	0 986 435 650	F 00R J02 175
		324/353	D 2676 LOH26 <Euro 5/EEV/OBD2>; D 2676 LOH27 <Euro 5/EEV/OBD2>	08.08→	6	DBJ	0 445 120 202	0 986 435 570	F 00R J02 175
		338	D 2676 LOH01 <Euro 4>	09.05-09.06	6	DBJ	0 445 120 219	0 986 435 528	F 00R J02 175
		353	D 2676 LOH02 <Euro 4>; D 2676 LOH04 <Euro 4/OBD1>	03.07→	6	DBJ	0 445 120 219	0 986 435 528	F 00R J02 175
			D 2676 LOH31 <Euro 6>	03.13→	6	DBJ	0 445 120 354	0 986 435 650	F 00R J02 175
<b>Lion's Coach RHC</b>									
RHC 464 [R07,R08,R09]	10,5	316	D 2066 LOH10 <Euro 3>	01.09→	6	DBJ	0 445 120 218	0 986 435 517	F 00R J02 175
<b>Lion's Intercity</b>									
ÜL [R60]	6,9	213	D 0836 LOH64 <Euro 5>; D 0836 LOH72 <Euro 6>	01.13→	6	DBJ	0 445 120 162	0 986 435 565	F 00R J02 175
[R62]	6,9	213	D 0836 LOH72 <Euro 6>	09.15→	6	DBJ	0 445 120 162	0 986 435 565	F 00R J02 175
<b>Lion's Intercity C</b>									
ÜL [R61]	6,9	213	D 0836 LOH64 <Euro 5>; D 0836 LOH72 <Euro 6>	01.13→	6	DBJ	0 445 120 162	0 986 435 565	F 00R J02 175
				01.13→	6	DBJ	0 445 120 162	0 986 435 565	F 00R J02 175
<b>Lion's Regio</b>									
[R12,R13,R14]	10,5	228	D 2066 LUH12 <Euro 4>	01.06→	6	DBJ	0 445 120 217	0 986 435 526	F 00R J02 175
			D 2066 LUH22 <Euro 4/OBD1>	01.06→	6	DBJ	0 445 120 217	0 986 435 526	F 00R J02 175
		235	D 2066 LUH32 <V6400, Euro 5>	01.06→	6	DBJ	0 445 120 197	0 986 435 569	F 00R J02 175
			D 2066 LUH47 <Euro 5/EEV/OBD2>	01.06→	6	DBJ	0 445 120 197	0 986 435 569	F 00R J02 175





◀ MAN

[R12,R13,R14]	10,5	257	D 2066 LUH08 <V6400, Euro3>	01.06→	6	DBJ	0 445 120 217	0 986 435 526	F 00R J02 175
			D 2066 LUH13 <Euro 4>	01.06→	6	DBJ	0 445 120 217	0 986 435 526	F 00R J02 175
			D 2066 LUH23 <Euro 4/OBD1>	01.06→	6	DBJ	0 445 120 217	0 986 435 526	F 00R J02 175
		264	D 2066 LUH48 <Euro 5/EEV/OBD2>	01.06→	6	DBJ	0 445 120 197	0 986 435 569	F 00R J02 175
		265	D 2066 LUH33 <V6400, Euro5>	01.06→	6	DBJ	0 445 120 197	0 986 435 569	F 00R J02 175
		287	D 2066 LUH14 <Euro4>	01.06→	6	DBJ	0 445 120 217	0 986 435 526	F 00R J02 175
			D 2066 LUH24 <Euro 4/OBD1>	01.06→	6	DBJ	0 445 120 217	0 986 435 526	F 00R J02 175
		294	D 2066 LUH34 <V6400, Euro5>	01.06→	6	DBJ	0 445 120 197	0 986 435 569	F 00R J02 175
		316	D 2066 LUH15 <Euro 3>	01.07-09.10	6	DBJ	0 445 120 217	0 986 435 526	F 00R J02 175

**Lion's Regio C**

[R12,R13,R14]	10,5	228	D 2066 LUH01 <Euro4>	10.06-05.07	6	DBJ	0 445 120 217	0 986 435 526	F 00R J02 175
		257/287	D 2066 LUH02 <Euro 4>; D 2066 LUH03 <Euro 4>	10.06-05.07	6	DBJ	0 445 120 217	0 986 435 526	

**Lion's Regio L**

[R12,R13,R14]	10,5	228	D 2066 LUH01 <Euro4>	10.06-05.07	6	DBJ	0 445 120 217	0 986 435 526	F 00R J02 175
		257/287	D 2066 LUH02 <Euro 4>; D 2066 LUH03 <Euro 4>	10.06-05.07	6	DBJ	0 445 120 217	0 986 435 526	

**ND-Serie**

ND 323 FR [A95]	10,5	235	D 2066 LUH32 <V6400, Euro5>	01.13→	6	DBJ	0 445 120 197	0 986 435 569	F 00R J02 175
ND 363 FR [A95]	10,5	265	D 2066 LUH33 <V6400, Euro5>	01.14→	6	DBJ	0 445 120 197	0 986 435 569	F 00R J02 175

**NG-Serie**

NG 313 F [A24]	10,5	228	D 2066 LUH22 <Euro 4/OBD1>	07.07→	6	DBJ	0 445 120 217	0 986 435 526	F 00R J02 175
NG 323 F [A24]	10,5	235	D 2066 LUH47 <Euro 5/EEV/OBD2>	03.10→	6	DBJ	0 445 120 197	0 986 435 569	F 00R J02 175
NG 353 F [A24]	10,5	257	D 2066 LUH13 <Euro 4>; D 2066 LUH23 <Euro 4/OBD1>	03.07→	6	DBJ	0 445 120 217	0 986 435 526	F 00R J02 175
NG 363 F [A24]	10,5	264	D 2066 LUH48 <Euro 5/EEV/OBD2>	07.09→	6	DBJ	0 445 120 197	0 986 435 569	F 00R J02 175
		265	D 2066 LUH33 <V6400, Euro5>	07.09→	6	DBJ	0 445 120 197	0 986 435 569	F 00R J02 175

**NL-Serie**

NL 243 F [A38]	6,9	176	D 0836 LOH41 <Euro 3>	06.03-04.06	6	DBJ	0 445 120 045	0 986 435 558	F 00R J02 175
NL 273 F [A22]	10,5	199	D 2066 LUH11 <Euro 4>	04.06→	6	DBJ	0 445 120 217	0 986 435 526	F 00R J02 175
NL 283 F [A22]	10,5	206	D 2066 LUH46 <Euro 5/EEV/OBD2>	01.09→	6	DBJ	0 445 120 197	0 986 435 569	F 00R J02 175
F [A38]	6,9	206	D 0836 LOH40 <Euro 3>	06.04-04.06	6	DBJ	0 445 120 045	0 986 435 558	F 00R J02 175
			D 0836 LOH51 <Euro 4>	01.06-03.07	6	DBJ	0 445 120 147	0 986 435 562	F 00R J02 175
NL 313 F [A22]	10,5	228	D 2066 LUH12 <Euro 4>; D 2066 LUH22 <Euro 4/OBD1>	01.07→	6	DBJ	0 445 120 217	0 986 435 526	F 00R J02 175
NL 323 F [A22]	10,5	235	D 2066 LUH32 <V6400, Euro5>	01.09→	6	DBJ	0 445 120 197	0 986 435 569	F 00R J02 175
			D 2066 LUH47 <Euro 5/EEV/OBD2>	01.09→	6	DBJ	0 445 120 197	0 986 435 569	F 00R J02 175

**NM-Serie**

NM 243 F [A35]	6,9	176	D 0836 LOH52 <Euro 4/OBD1>	01.06-09.09	6	DBJ	0 445 120 147	0 986 435 562	F 00R J02 175
			D 0836 LOH56 <Euro 4/OBD1>	01.06-09.09	6	DBJ	0 445 120 147	0 986 435 562	F 00R J02 175
NM 253 F [A35]	6,9	184	D 0836 LOH61 <Euro 5/EEV/OBD2>	01.09→	6	DBJ	0 445 120 162	0 986 435 565	F 00R J02 175
NM 263 F [A35]	6,9	191	D 0836 LOH62 <Euro 4>	01.09→	6	DBJ,TW	0 445 120 147	0 986 435 562	F 00R J02 175
					6	DBJ,TW	0 445 120 162	0 986 435 565	F 00R J02 175
NM 283 F [A35]	6,9	206	D 0836 LOH55 <Euro 4/OBD1>	03.07-09.10	6	DBJ	0 445 120 147	0 986 435 562	F 00R J02 175
			D 0836 LOH57 <Euro 4>	03.07-09.10	6	DBJ	0 445 120 147	0 986 435 562	F 00R J02 175
NM 293 F [A35]	6,9	213	D 0836 LOH60	07.08-12.13	6	DBJ	0 445 120 162	0 986 435 565	F 00R J02 175

**RR2**

350	10,5	257	D 2066 LOH12 <Euro 3>	05.13→	6	DBJ,TW	0 445 120 217	0 986 435 526	F 00R J02 175
					6	DBJ,TW	0 445 120 218	0 986 435 517	F 00R J02 175
360	10,5	265	D 2066 LOH27 <Euro5/EEV/OBD2>	05.10→	6	DBJ	0 445 120 201	0 986 435 656	F 00R J02 175
400	10,5	294	D 2066 LOH28 <Euro5/EEV/OBD2>	05.10→	6	DBJ	0 445 120 201	0 986 435 656	F 00R J02 175
440	12,4	324	D 2676 LOH26 <Euro 5/EEV/OBD2>	07.09→	6	DBJ	0 445 120 202	0 986 435 570	F 00R J02 175
480	12,4	353	D 2676 LOH27 <Euro 5/EEV/OBD2>	03.12→	6	DBJ	0 445 120 202	0 986 435 570	F 00R J02 175



SL										
313 F [A89]	10,5	228	D 2066 LUH12 <Euro 4>	02.06-12.09	6	DBJ	0 445 120 217	0 986 435 526	F 00R J02 175	
353 F [A89]	10,5	257	D 2066 LUH13 <Euro 4>; D 2066 LUH23 <Euro 4/OBD1>	02.07-12.10	6	DBJ	0 445 120 217	0 986 435 526	F 00R J02 175	
363 F [A89]	10,5	265	D 2066 LUH33 <V6400, Euro5>	02.09-04.14	6	DBJ	0 445 120 197	0 986 435 569	F 00R J02 175	
Sü										
363 F [A91]	10,5	265	D 2066 LUH33 <V6400, Euro5>	09.08-09.13	6	DBJ	0 445 120 197	0 986 435 569	F 00R J02 175	
SÜ										
243 F [A91]	6,9	176	D 0836 LOH56 <Euro 4/OBD1>	02.07-09.09	6	DBJ	0 445 120 147	0 986 435 562	F 00R J02 175	
253 F [A91]	6,9	184	D 0836 LOH 65 <Euro 5>	09.08-09.13	6	DBJ	0 445 120 162	0 986 435 565	F 00R J02 175	
263 F [A91]	6,9	191	D 0836 LOH63 <Euro 4>	01.08→	6	DBJ	0 445 120 147	0 986 435 562	F 00R J02 175	
283 F [A91]	6,9	206	D 0836 LOH51 <Euro 4>; D 0836 LOH55 <Euro 4/OBD1>	06.04-09.13	6	DBJ	0 445 120 147	0 986 435 562	F 00R J02 175	
293 F [A91]	6,9	213	D 0836 LOH64 <Euro 5>	09.07-09.13	6	DBJ	0 445 120 162	0 986 435 565	F 00R J02 175	
313 F [A91]	10,5	228	D 2066 LUH12 <Euro 4>; D 2066 LUH22 <Euro 4/OBD1>	02.06-09.13	6	DBJ	0 445 120 217	0 986 435 526	F 00R J02 175	
323 F [A91]	10,5	235	D 2066 LUH32 <V6400, Euro5>	09.08-09.13	6	DBJ	0 445 120 197	0 986 435 569	F 00R J02 175	
353 F [A91]	10,5	257	D 2066 LUH13 <Euro 4>; D 2066 LUH23 <Euro 4/OBD1>	09.06-09.13	6	DBJ	0 445 120 217	0 986 435 526	F 00R J02 175	
TAG										
24.430 FN, FP	10,5	316	D 2066 LF01 <Euro 3>	09.04-09.06	6	DBJ	0 445 120 218	0 986 435 517	F 00R J02 175	
TGA										
18.310 FA, FH, FC, FK, FL	10,5	228	D 2066 LF04 <V5500, Euro 3>	03.04-09.06	6	DBJ	0 445 120 218	0 986 435 517	F 00R J02 175	
FC, FK, FL	10,5	228	D 2066 LF14 <V5500, Euro 4>	04.06-09.07	6	DBJ	0 445 120 217	0 986 435 526	F 00R J02 175	
18.320 F, FL, FA, FC, FK, FL, FC, FK, FL	10,5	235	D 2066 LF20 <Euro 5/OBD1>; D 2066 LF28 <Euro 5/OBD1>; D 2066 LF30 <Euro 5/OBD1>; D 2066 LF35 <V5500, Euro 4>; D 2066 LF39 <Euro 4/OBD1>	07.06-03.09	6	DBJ	0 445 120 217	0 986 435 526	F 00R J02 175	
18.350 FA, FC, FK, FL	10,5	257	D 2066 LF03 <Euro 3>	03.04-08.08	6	DBJ	0 445 120 218	0 986 435 517	F 00R J02 175	
FA, FC, FK, FL, FA, FH	10,5	257	D 2066 LF13 <V5500, Euro 4>	10.04-09.06	6	DBJ	0 445 120 217	0 986 435 526	F 00R J02 175	
18.360 F, FL, FA, FC, FK, FL	10,5	265	D 2066 LF19 <Euro 5/OBD1>; D 2066 LF27 <Euro 5/OBD1>; D 2066 LF29 <V5500, Euro 5>; D 2066 LF33 <V5500, Euro 4>; D 2066 LF38 <Euro 4/OBD1>	07.06-03.09	6	DBJ	0 445 120 217	0 986 435 526	F 00R J02 175	
18.390 FA, FH, FC, FK, FL	10,5	287	D 2066 LF02 <Euro 3>	03.04-08.08	6	DBJ	0 445 120 218	0 986 435 517	F 00R J02 175	
FA, FL, FC, FK, FL	10,5	287	D 2066 LF12 <Euro 4>	10.04-09.06	6	DBJ	0 445 120 217	0 986 435 526	F 00R J02 175	
18.400 F, FL, FA, FC, FK, FL, FC, FK, FL	10,5	294	D 2066 LF18 <Euro 5/OBD1>; D 2066 LF22 <V5500, Euro 5>; D 2066 LF24 <Euro 5/OBD1>; D 2066 LF26 <Euro 5/OBD1>; D 2066 LF32 <Euro 4/OBD1>; D 2066 LF37 <Euro 4/OBD1>	01.06-03.09	6	DBJ	0 445 120 217	0 986 435 526	F 00R J02 175	
18.430 FA, FH, FC, FK, FL	10,5	316	D 2066 LF01 <Euro 3>	03.04-08.08	6	DBJ	0 445 120 218	0 986 435 517	F 00R J02 175	
FC, FK, FL	10,5	316	D 2066 LF11 <V5500, Euro 4>	09.04-09.06	6	DBJ	0 445 120 217	0 986 435 526	F 00R J02 175	
18.440 F, FL	10,5	324	D 2066 LF17 <Euro 5/OBD1>	04.08-08.08	6	DBJ	0 445 120 217	0 986 435 526	F 00R J02 175	
			D 2066 LF25 <Euro 5/OBD1>	10.07-08.08	6	DBJ	0 445 120 217	0 986 435 526	F 00R J02 175	
F, FL, FA, FC, FK, FL, FC, FK, FL	10,5	321/324	D 2066 LF21 <V5500, Euro 5>; D 2066 LF23 <Euro 5/OBD1>; D 2066 LF31 <Euro 4/OBD1>	01.06-03.09	6	DBJ	0 445 120 217	0 986 435 526	F 00R J02 175	
FA, FC, FH, FK, FL	10,5	324	D 2066 LF36 <Euro 4/OBD1>	10.07-08.08	6	DBJ	0 445 120 217	0 986 435 526	F 00R J02 175	
18.480 F, FA, FC, FK, FL	12,8	353	D 2876 LF12 <V5300, Euro 3>	10.02-09.06	6	DBJ	0 445 120 044	0 986 435 527	F 00R J02 175	
F, FL, FA, FC, FH, FK, FL	12,4	353	D 2676 LF01 <Euro4/OBD1>; D 2676 LF05 <Euro 4/OBD1>; D 2676 LF12 <Euro5/OBD1>; D 2676 LF14 <Euro 5/OBD1>; D 2676 LF16 <Euro 5/OBD1>	04.06-03.09	6	DBJ	0 445 120 219	0 986 435 528	F 00R J02 175	
18.530 F, FL, FC, FK, FL	12,8	390	D 2876 LF13 <V5300, Euro 3>	10.02-09.06	6	DBJ	0 445 120 044	0 986 435 527	F 00R J02 175	





◀ MAN

<b>18.540</b> FL, FL	12,4	397	D 2676 LF11 <Euro 5/OBD1>; D 2676 LF13 <Euro 5/OBD1>; D 2676 LF15 <Euro 5/OBD1>	02.07-08.08	6	DBJ	<b>0 445 120 219</b>	<b>0 986 435 528</b>	<b>F 00R J02 175</b>
<b>19.350</b> FL-, FC-, FK-WW	10,5	258	D 2066 LF03 <Euro 3>	07.06-05.10	6	DBJ	<b>0 445 120 218</b>	<b>0 986 435 517</b>	<b>F 00R J02 175</b>
<b>19.360</b> FL-, FC-, FK-WW	10,5	265	D 2066 LF07 <Euro 2>	07.06-05.10	6	DBJ	<b>0 445 120 218</b>	<b>0 986 435 517</b>	<b>F 00R J02 175</b>
<b>19.390</b> FL-, FC-, FK-WW	10,5	287	D 2066 LF02 <Euro 3>	07.06-05.10	6	DBJ	<b>0 445 120 218</b>	<b>0 986 435 517</b>	<b>F 00R J02 175</b>
<b>19.400</b> FL-, FC-, FK-WW	10,5	294	D 2066 LF06 <Euro 2>	07.06-05.10	6	DBJ	<b>0 445 120 218</b>	<b>0 986 435 517</b>	<b>F 00R J02 175</b>
<b>19.430</b> FL-, FC-, FK-WW	10,5	316	D 2066 LF01 <Euro 3>	07.06-05.10	6	DBJ	<b>0 445 120 218</b>	<b>0 986 435 517</b>	<b>F 00R J02 175</b>
<b>19.440</b> FL-, FC-, FK-WW	12,4	324	D 2676 LF04 <Euro 2>	07.06-05.10	6	DBJ	<b>0 445 120 219</b>	<b>0 986 435 528</b>	<b>F 00R J02 175</b>
<b>19.480</b> FL-, FC-, FK-WW	12,4	353	D 2676 LF02 <Euro 3> D 2676 LF03 <Euro 2>	07.06-05.10	6	DBJ	<b>0 445 120 219</b>	<b>0 986 435 528</b>	<b>F 00R J02 175</b>
<b>24.350</b> FN, FP	10,5	257	D 2066 LF03 <Euro 3> D 2066 LF13 <V5500, Euro 4>	09.04-09.06 10.04-09.06	6	DBJ	<b>0 445 120 218</b>	<b>0 986 435 517</b>	<b>F 00R J02 175</b>
<b>24.360</b> DF, FN	10,5	265	D 2066 LF19 <Euro 5/OBD1>; D 2066 LF27 <Euro 5/OBD1>; D 2066 LF29 <V5500, Euro 5>; D 2066 LF33 <V5500, Euro 4>; D 2066 LF38 <Euro 4/OBD1>	07.06-03.09	6	DBJ	<b>0 445 120 217</b>	<b>0 986 435 526</b>	<b>F 00R J02 175</b>
<b>24.390</b> FN, FP	10,5	287	D 2066 LF02 <Euro 3> D 2066 LF12 <Euro 4>	09.04-09.06 10.04-09.06	6	DBJ	<b>0 445 120 218</b>	<b>0 986 435 517</b>	<b>F 00R J02 175</b>
<b>24.400</b> DF, FN	10,5	294	D 2066 LF18 <Euro 5/OBD1>; D 2066 LF22 <V5500, Euro 5>; D 2066 LF24 <Euro 5/OBD1>; D 2066 LF26 <Euro 5/OBD1>; D 2066 LF32 <Euro 4/OBD1>; D 2066 LF37 <Euro 4/OBD1>	07.06-03.09	6	DBJ	<b>0 445 120 217</b>	<b>0 986 435 526</b>	<b>F 00R J02 175</b>
<b>24.430</b> FN, FP	10,5	316	D 2066 LF11 <V5500, Euro 4>	10.04-09.06	6	DBJ	<b>0 445 120 217</b>	<b>0 986 435 526</b>	<b>F 00R J02 175</b>
<b>24.440</b> DF, FD, FN, FN, FP	10,5	321/324	D 2066 LF17 <Euro 5/OBD1>; D 2066 LF21 <V5500, Euro 5>; D 2066 LF23 <Euro 5/OBD1>; D 2066 LF25 <Euro 5/OBD1>; D 2066 LF31 <Euro 4/OBD1>; D 2066 LF36 <Euro 4/OBD1>	07.06-03.09	6	DBJ	<b>0 445 120 217</b>	<b>0 986 435 526</b>	<b>F 00R J02 175</b>
<b>24.480</b> DF, FN	12,4	353	D 2676 LF01 <Euro 4/OBD1>; D 2676 LF05 <Euro 4/OBD1>; D 2676 LF12 <Euro 5/OBD1>; D 2676 LF14 <Euro 5/OBD1>; D 2676 LF16 <Euro 5/OBD1>	07.06-03.09	6	DBJ	<b>0 445 120 219</b>	<b>0 986 435 528</b>	<b>F 00R J02 175</b>
FN, FP, FV	12,8	353	D 2876 LF12 <V5300, Euro 3>	06.03-09.06	6	DBJ	<b>0 445 120 044</b>	<b>0 986 435 527</b>	
<b>24.530</b> FN, FP, FV	12,8	390	D 2876 LF13 <V5300, Euro 3>	12.02-09.06	6	DBJ	<b>0 445 120 044</b>	<b>0 986 435 527</b>	
<b>24.540</b> DF	12,4	397	D 2676 LF11 <Euro 5/OBD1>; D 2676 LF13 <Euro 5/OBD1>; D 2676 LF15 <Euro 5/OBD1>	02.07-08.08	6	DBJ	<b>0 445 120 219</b>	<b>0 986 435 528</b>	<b>F 00R J02 175</b>
<b>26.280</b> DF	6,9	206	D 0836 LF41 <V5200, Euro 3>	03.03-02.05	6	DBJ	<b>0 445 120 045</b>	<b>0 986 435 558</b>	
<b>26.310</b> FD, FH, FN, FV, FD, FV	10,5	228	D 2066 LF04 <V5500, Euro 3> D 2066 LF14 <V5500, Euro 4>	03.04-09.06 04.06-09.07	6	DBJ	<b>0 445 120 218</b>	<b>0 986 435 517</b>	<b>F 00R J02 175</b>
<b>26.320</b> FD, FH, FN, FV	10,5	235	D 2066 LF20 <Euro 5/OBD1>; D 2066 LF28 <Euro 5/OBD1>; D 2066 LF30 <Euro 5/OBD1>; D 2066 LF35 <V5500, Euro 4>; D 2066 LF39 <Euro 4/OBD1>	07.06-09.08	6	DBJ	<b>0 445 120 217</b>	<b>0 986 435 526</b>	<b>F 00R J02 175</b>
<b>26.330</b> DA	6,9	240	D 0836 LF44 <V5200, Euro 3>	03.03-02.05	6	DBJ	<b>0 445 120 045</b>	<b>0 986 435 558</b>	
<b>26.350</b> FD, FH, FN, FV, FD, FV	10,5	257	D 2066 LF03 <Euro 3> D 2066 LF13 <V5500, Euro 4>	03.04-09.06 10.04-09.06	6	DBJ	<b>0 445 120 218</b>	<b>0 986 435 517</b>	<b>F 00R J02 175</b>
<b>26.360</b> FD, FH, FN, FV	10,5	265	D 2066 LF19 <Euro 5/OBD1>; D 2066 LF27 <Euro 5/OBD1>; D 2066 LF29 <V5500, Euro 5>; D 2066 LF33 <V5500, Euro 4>; D 2066 LF38 <Euro 4/OBD1>	07.06-09.08	6	DBJ	<b>0 445 120 217</b>	<b>0 986 435 526</b>	<b>F 00R J02 175</b>
<b>26.390</b> FD, FFD, FD, FH, FN, FV	10,5	287	D 2066 LF12 <Euro 4>	10.04-09.06	6	DBJ	<b>0 445 120 217</b>	<b>0 986 435 526</b>	<b>F 00R J02 175</b>
FD, FFD, FV, FD, FH, FN, FV	10,5	287	D 2066 LF02 <Euro 3>	03.04-09.06	6	DBJ	<b>0 445 120 218</b>	<b>0 986 435 517</b>	<b>F 00R J02 175</b>







26.400	FD, FH, FN, FV	10,5	294	D 2066 LF18 <Euro 5/OBD1>; D 2066 LF22 <V5500, Euro 5>; D 2066 LF24 <Euro 5/OBD1>; D 2066 LF26 <Euro 5/OBD1>; D 2066 LF32 <Euro 4/OBD1>; D 2066 LF37 <Euro 4/OBD1>	01.06-09.08	6	DBJ	0 445 120 217	0 986 435 526	F 00R J02 175
26.430	FD, FD, FH, FN, FV	10,5	316	D 2066 LF01 <Euro 3> D 2066 LF11 <V5500, Euro 4>	03.04-09.06 10.04-09.06	6	DBJ	0 445 120 218 0 445 120 217	0 986 435 517 0 986 435 526	F 00R J02 175 F 00R J02 175
26.440	F, FL, FD, FH, FN, FV	10,5	321/324	D 2066 LF17 <Euro 5/OBD1>; D 2066 LF21 <V5500, Euro 5>; D 2066 LF23 <Euro 5/OBD1>; D 2066 LF25 <Euro 5/OBD1>; D 2066 LF31 <Euro 4/OBD1>; D 2066 LF36 <Euro 4/OBD1>	01.06-03.09	6	DBJ	0 445 120 217	0 986 435 526	F 00R J02 175
26.480	DA, FD, FN, FP, FV	12,8	353	D 2876 LF12 <V5300, Euro 3>	09.02-09.06	6	DBJ	0 445 120 044	0 986 435 527	
	FD, FH, FN, FV	12,4	353	D 2676 LF01 <Euro 4/OBD1>; D 2676 LF05 <Euro 4/OBD1>; D 2676 LF12 <Euro 5/OBD1>; D 2676 LF14 <Euro 5/OBD1>; D 2676 LF16 <Euro 5/OBD1>	07.06-03.09	6	DBJ	0 445 120 219	0 986 435 528	F 00R J02 175
26.530	DA, FD, FN, FP, FV	12,8	390	D 2876 LF13 <V5300, Euro 3>	09.02-09.06	6	DBJ	0 445 120 044	0 986 435 527	
26.540	FD, FH, FN, FV	12,4	397	D 2676 LF11 <Euro 5/OBD1>; D 2676 LF13 <Euro 5/OBD1>; D 2676 LF15 <Euro 5/OBD1>	02.07-08.08	6	DBJ	0 445 120 219	0 986 435 528	F 00R J02 175
28.310	DF, FN	10,5	228	D 2066 LF04 <V5500, Euro 3> D 2066 LF14 <V5500, Euro 4>	03.04-09.06 10.04-06.07	6	DBJ	0 445 120 218 0 445 120 217	0 986 435 517 0 986 435 526	F 00R J02 175 F 00R J02 175
28.320		10,5	235	D 2066 LF86 <Euro 6/OBDC>	09.16→	6	DBJ	0 445 120 353	0 986 435 593	F 00R J02 175
	DF, FN	10,5	235	D 2066 LF30 <Euro 5/OBD1>; D 2066 LF35 <V5500, Euro 4> D 2066 LF39 <Euro 4/OBD1>	04.06-08.08 10.07-06.08 10.07-08.08	6	DBJ	0 445 120 217 0 445 120 217 0 445 120 217	0 986 435 526 0 986 435 526 0 986 435 526	F 00R J02 175 F 00R J02 175 F 00R J02 175
	FN	10,5	235	D 2066 LF20 <Euro 5/OBD1>	04.08-08.08	6	DBJ	0 445 120 217	0 986 435 526	F 00R J02 175
			236	D 2066 LF28 <Euro 5/OBD1>	10.07-08.08	6	DBJ	0 445 120 217	0 986 435 526	F 00R J02 175
28.350	DF, FN	10,5	257	D 2066 LF03 <Euro 3> D 2066 LF13 <V5500, Euro 4>	03.04-09.06 10.04-09.06	6	DBJ	0 445 120 218 0 445 120 217	0 986 435 517 0 986 435 526	F 00R J02 175 F 00R J02 175
28.360	DF, FN	10,5	265	D 2066 LF29 <V5500, Euro 5>; D 2066 LF33 <V5500, Euro 4> D 2066 LF38 <Euro 4/OBD1>	07.06-08.08 10.07-06.08 10.07-08.08	6	DBJ	0 445 120 217 0 445 120 217 0 445 120 217	0 986 435 526 0 986 435 526 0 986 435 526	F 00R J02 175 F 00R J02 175 F 00R J02 175
	FN	10,5	265	D 2066 LF19 <Euro 5/OBD1> D 2066 LF27 <Euro 5/OBD1>	04.08-08.08 10.07-08.08	6	DBJ	0 445 120 217 0 445 120 217	0 986 435 526 0 986 435 526	F 00R J02 175 F 00R J02 175
28.390	FN	10,5	287	D 2066 LF02 <Euro 3> D 2066 LF12 <Euro 4>	03.04-09.06 10.04-09.06	6	DBJ	0 445 120 218 0 445 120 217	0 986 435 517 0 986 435 526	F 00R J02 175 F 00R J02 175
28.400	FN	10,5	294	D 2066 LF18 <Euro 5/OBD1> D 2066 LF22 <V5500, Euro 5>; D 2066 LF24 <Euro 5/OBD1>; D 2066 LF32 <Euro 4/OBD1> D 2066 LF26 <Euro 5/OBD1> D 2066 LF37 <Euro 4/OBD1>	04.08-08.08 07.06-08.08 10.07-08.08 10.07-08.08	6	DBJ	0 445 120 217 0 445 120 217 0 445 120 217 0 445 120 217	0 986 435 526 0 986 435 526 0 986 435 526 0 986 435 526	F 00R J02 175 F 00R J02 175 F 00R J02 175 F 00R J02 175
28.430	FN	10,5	316	D 2066 LF01 <Euro 3> D 2066 LF11 <V5500, Euro 4>	03.04-09.06 10.04-09.06	6	DBJ	0 445 120 218 0 445 120 217	0 986 435 517 0 986 435 526	F 00R J02 175 F 00R J02 175
28.440	DF, FN	10,5	321/324	D 2066 LF21 <V5500, Euro 5>; D 2066 LF23 <Euro 5/OBD1>; D 2066 LF31 <Euro 4/OBD1>	01.06-08.08	6	DBJ	0 445 120 217	0 986 435 526	F 00R J02 175
	FN	10,5	324	D 2066 LF17 <Euro 5/OBD1> D 2066 LF25 <Euro 5/OBD1> D 2066 LF36 <Euro 4/OBD1>	04.08-08.08 10.07-08.08 10.07-08.08	6	DBJ	0 445 120 217 0 445 120 217 0 445 120 217	0 986 435 526 0 986 435 526 0 986 435 526	F 00R J02 175 F 00R J02 175 F 00R J02 175
28.480	DF	12,8	353	D 2876 LF12 <V5300, Euro 3>	06.03-09.06	6	DBJ	0 445 120 044	0 986 435 527	
	FN	12,4	353	D 2676 LF01 <Euro 4/OBD1>; D 2676 LF12 <Euro 5/OBD1> D 2676 LF05 <Euro 4/OBD1>	07.06-08.08 10.07-08.08	6	DBJ	0 445 120 219 0 445 120 219	0 986 435 528 0 986 435 528	F 00R J02 175 F 00R J02 175







◀ MAN

28.480 FN	12,4	353	D 2676 LF14 <Euro 5/OBD1>	10.07-08.08	6	DBJ	0 445 120 219	0 986 435 528	F 00R J02 175
			D 2676 LF16 <Euro 5/OBD1>	04.08-08.08	6	DBJ	0 445 120 219	0 986 435 528	F 00R J02 175
28.530 DF	12,8	390	D 2876 LF13 <V5300, Euro 3>	09.02-09.06	6	DBJ	0 445 120 044	0 986 435 527	
28.540 FN	12,4	397	D 2676 LF11 <Euro 5/OBD1>;	02.07-08.08	6	DBJ	0 445 120 219	0 986 435 528	F 00R J02 175
			D 2676 LF13 <Euro 5/OBD1>;						
			D 2676 LF15 <Euro 5/OBD1>						
32.350 FFD	10,5	257	D 2066 LF03 <Euro 3>	06.04-09.06	6	DBJ	0 445 120 218	0 986 435 517	F 00R J02 175
			D 2066 LF13 <V5500, Euro 4>	04.06-09.06	6	DBJ	0 445 120 217	0 986 435 526	F 00R J02 175
32.360 FFD	10,5	265	D 2066 LF33 <V5500, Euro 4>;	07.06-08.08	6	DBJ	0 445 120 217	0 986 435 526	F 00R J02 175
			D 2066 LF38 <Euro 4/OBD1>						
32.390 FFD	10,5	287	D 2066 LF02 <Euro 3>	06.04-09.06	6	DBJ	0 445 120 218	0 986 435 517	F 00R J02 175
32.400 FFD	10,5	294	D 2066 LF32 <Euro 4/OBD1>;	07.06-08.08	6	DBJ	0 445 120 217	0 986 435 526	F 00R J02 175
			D 2066 LF37 <Euro 4/OBD1>						
32.430 FFD	10,5	316	D 2066 LF01 <Euro 3>	06.04-09.06	6	DBJ	0 445 120 218	0 986 435 517	F 00R J02 175
			D 2066 LF11 <V5500, Euro 4>	04.06-09.06	6	DBJ	0 445 120 217	0 986 435 526	F 00R J02 175
32.440 FFD	10,5	324	D 2066 LF31 <Euro 4/OBD1>;	07.06-08.08	6	DBJ	0 445 120 217	0 986 435 526	F 00R J02 175
			D 2066 LF36 <Euro 4/OBD1>						
32.480 FFD	12,4	353	D 2676 LF01 <Euro4/OBD1>;	07.06-08.08	6	DBJ	0 445 120 219	0 986 435 528	F 00R J02 175
			D 2676 LF05 <Euro 4/OBD1>						
	12,8	352	D 2876 LF12 <V5300, Euro 3>	05.04-01.06	6	DBJ	0 445 120 044	0 986 435 527	
32.530 DA	12,8	390	D 2876 LF13 <V5300, Euro 3>	05.04-09.04	6	DBJ	0 445 120 044	0 986 435 527	
33.310 FFD	10,5	228	D 2066 LF04 <V5500, Euro 3>	03.04-09.06	6	DBJ	0 445 120 218	0 986 435 517	F 00R J02 175
33.350 DF, FD, FDA	10,5	257	D 2066 LF13 <V5500, Euro 4>	10.04-09.06	6	DBJ	0 445 120 217	0 986 435 526	F 00R J02 175
			FDA, FD-WW	10,5	257	D 2066 LF03 <Euro 3>	03.04-05.10	6	DBJ
33.360 FD	10,5	265	D 2066 LF33 <V5500, Euro 4>	07.06-09.08	6	DBJ	0 445 120 217	0 986 435 526	F 00R J02 175
			D 2066 LF38 <Euro 4/OBD1>	10.07-09.08	6	DBJ	0 445 120 217	0 986 435 526	F 00R J02 175
FD-, FDA-WW	10,5	265	D 2066 LF07 <Euro 2>	07.06-05.10	6	DBJ	0 445 120 218	0 986 435 517	F 00R J02 175
33.390 DF, FDA	10,5	287	D 2066 LF12 <Euro 4>	10.04-09.06	6	DBJ	0 445 120 217	0 986 435 526	F 00R J02 175
			FDA, FD-WW	10,5	287	D 2066 LF02 <Euro 3>	03.04-05.10	6	DBJ
33.400 FD	10,5	294	D 2066 LF32 <Euro 4/OBD1>	07.06-08.08	6	DBJ	0 445 120 217	0 986 435 526	F 00R J02 175
			D 2066 LF37 <Euro 4/OBD1>	10.07-08.08	6	DBJ	0 445 120 217	0 986 435 526	F 00R J02 175
FD-, FDA-WW	10,5	294	D 2066 LF06 <Euro 2>	07.06-05.10	6	DBJ	0 445 120 218	0 986 435 517	F 00R J02 175
33.430 DF, FDA	10,5	316	D 2066 LF11 <V5500, Euro 4>	10.04-09.06	6	DBJ	0 445 120 217	0 986 435 526	F 00R J02 175
			FDA, FD-WW	10,5	316	D 2066 LF01 <Euro 3>	03.04-05.10	6	DBJ
33.440 FD	10,5	324	D 2066 LF31 <Euro 4/OBD1>;	07.06-08.08	6	DBJ	0 445 120 217	0 986 435 526	F 00R J02 175
			D 2066 LF36 <Euro 4/OBD1>						
FD-, FDA-WW	12,4	324	D 2676 LF04 <Euro 2>	07.06-05.10	6	DBJ	0 445 120 219	0 986 435 528	F 00R J02 175
33.480 DA	12,8	352/353	D 2876 LF12 <V5300, Euro 3>	10.02-03.09	6	DBJ	0 445 120 044	0 986 435 527	
			FD	12,4	353	D 2676 LF01 <Euro4/OBD1>	07.06-08.08	6	DBJ
			D 2676 LF05 <Euro 4/OBD1>	10.07-08.08	6	DBJ	0 445 120 219	0 986 435 528	F 00R J02 175
FD-, FDA-WW	12,4	353	D 2676 LF03 <Euro 2>	07.06-05.10	6	DBJ	0 445 120 219	0 986 435 528	F 00R J02 175
FDA-WW, FD-WW	12,8	352/353	D 2876 LF12 <V5300, Euro 3>	06.03-03.09	6	DBJ	0 445 120 044	0 986 435 527	F 00R J02 175
FD-WW	12,4	353	D 2676 LF02 <Euro 3>	07.06-05.10	6	DBJ	0 445 120 219	0 986 435 528	F 00R J02 175
	12,8	353	D 2876 LF25 <Euro 2>	07.06-03.09	6	DBJ	0 445 120 044	0 986 435 527	
33.530 DF	12,8	390	D 2876 LF13 <V5300, Euro 3>	10.02-09.06	6	DBJ	0 445 120 044	0 986 435 527	
35.350 FFD, FV	10,5	257	D 2066 LF13 <V5500, Euro 4>	10.04-09.06	6	DBJ	0 445 120 217	0 986 435 526	F 00R J02 175
			FFD, VF	10,5	257	D 2066 LF03 <Euro 3>	03.04-09.06	6	DBJ
35.360 FFD	10,5	265	D 2066 LF33 <V5500, Euro 4>;	07.06-08.08	6	DBJ	0 445 120 217	0 986 435 526	F 00R J02 175
			D 2066 LF38 <Euro 4/OBD1>						
35.390 FFD	10,5	287	D 2066 LF02 <Euro 3>	03.04-09.06	6	DBJ	0 445 120 218	0 986 435 517	F 00R J02 175
			FFD, FV	10,5	287	D 2066 LF12 <Euro 4>	10.04-09.06	6	DBJ
35.400 FFD	10,5	294	D 2066 LF32 <Euro 4/OBD1>;	07.06-08.08	6	DBJ	0 445 120 217	0 986 435 526	F 00R J02 175
			D 2066 LF37 <Euro 4/OBD1>						
35.430 FFD	10,5	316	D 2066 LF01 <Euro 3>	03.04-09.06	6	DBJ	0 445 120 218	0 986 435 517	F 00R J02 175
			FFD, FV	10,5	316	D 2066 LF11 <V5500, Euro 4>	10.04-09.06	6	DBJ
35.440 FFD	10,5	324	D 2066 LF31 <Euro 4/OBD1>;	07.06-08.08	6	DBJ	0 445 120 217	0 986 435 526	F 00R J02 175
			D 2066 LF36 <Euro 4/OBD1>						
35.480 FFD	12,4	353	D 2676 LF01 <Euro4/OBD1>;	07.06-08.08	6	DBJ	0 445 120 219	0 986 435 528	F 00R J02 175
			D 2676 LF05 <Euro 4/OBD1>						
	12,8	352/353	D 2876 LF12 <V5300, Euro 3>	06.03-09.06	6	DBJ	0 445 120 044	0 986 435 527	
35.530 FFD	12,8	390	D 2876 LF13 <V5300, Euro 3>	06.04-03.06	6	DBJ	0 445 120 044	0 986 435 527	
37.350 FFD	10,5	257	D 2066 LF03 <Euro 3>	03.04-09.06	6	DBJ	0 445 120 218	0 986 435 517	F 00R J02 175
			D 2066 LF13 <V5500, Euro 4>	10.04-09.06	6	DBJ	0 445 120 217	0 986 435 526	F 00R J02 175



37.360	FFD	10,5	265	D 2066 LF33 <V5500, Euro 4>; D 2066 LF38 <Euro 4/OBD1>	07.06-08.08	6	DBJ	0 445 120 217	0 986 435 526	F 00R J02 175
37.390	FFD	10,5	287	D 2066 LF02 <Euro 3> D 2066 LF12 <Euro 4>	03.04-09.06 10.04-09.06	6	DBJ	0 445 120 218	0 986 435 517	F 00R J02 175
37.400	FFD	10,5	294	D 2066 LF32 <Euro 4/OBD1>; D 2066 LF37 <Euro 4/OBD1>	07.06-08.08	6	DBJ	0 445 120 217	0 986 435 526	F 00R J02 175
37.430	FFD	10,5	316	D 2066 LF01 <Euro 3> D 2066 LF11 <V5500, Euro 4>	03.04-09.06 10.04-09.06	6	DBJ	0 445 120 218	0 986 435 517	F 00R J02 175
37.440	FFD	10,5	324	D 2066 LF31 <Euro 4/OBD1>; D 2066 LF36 <Euro 4/OBD1>	07.06-08.08	6	DBJ	0 445 120 217	0 986 435 526	F 00R J02 175
37.480	FFD	12,4	353	D 2676 LF01 <Euro4/OBD1>; D 2676 LF05 <Euro 4/OBD1>	07.06-08.08	6	DBJ	0 445 120 219	0 986 435 528	F 00R J02 175
VF		12,8	353	D 2876 LF12 <V5300, Euro 3>	08.04-09.06	6	DBJ	0 445 120 044	0 986 435 527	
37.530	VF	12,8	390	D 2876 LF13 <V5300, Euro 3>	06.03-09.06	6	DBJ	0 445 120 044	0 986 435 527	
39.390	FV	10,5	287	D 2066 LF02 <Euro 3> D 2066 LF12 <Euro 4>	03.04-09.06 09.05-09.06	6	DBJ	0 445 120 218	0 986 435 517	F 00R J02 175
39.400	FFD	10,5	294	D 2066 LF32 <Euro 4/OBD1>; D 2066 LF37 <Euro 4/OBD1>	07.06-08.08	6	DBJ	0 445 120 217	0 986 435 526	F 00R J02 175
39.430	FFD	10,5	316	D 2066 LF01 <Euro 3> D 2066 LF11 <V5500, Euro 4>	07.04-09.06 09.05-09.06	6	DBJ	0 445 120 218	0 986 435 517	F 00R J02 175
39.440	FFD	10,5	324	D 2066 LF31 <Euro 4/OBD1>; D 2066 LF36 <Euro 4/OBD1>	07.06-08.08	6	DBJ	0 445 120 217	0 986 435 526	F 00R J02 175
39.480	FFD	12,4	353	D 2676 LF01 <Euro4/OBD1>; D 2676 LF05 <Euro 4/OBD1>	07.06-08.08	6	DBJ	0 445 120 219	0 986 435 528	F 00R J02 175
40.390	FDA-WW, FD-WW	10,5	287	D 2066 LF02 <Euro 3>	01.05-05.10	6	DBJ	0 445 120 218	0 986 435 517	F 00R J02 175
40.400	FD-WW	10,5	294	D 2066 LF06 <Euro 2> D 2066 LF32 <Euro 4/OBD1> D 2066 LF37 <Euro 4/OBD1>	07.06-05.10 09.08-05.10 09.08-05.10	6	DBJ	0 445 120 218	0 986 435 517	F 00R J02 175
40.430	FDA-WW, FD-WW	10,5	316	D 2066 LF01 <Euro 3>	07.04-05.10	6	DBJ	0 445 120 218	0 986 435 517	F 00R J02 175
40.440	FD-WW	10,5	324	D 2066 LF31 <Euro 4/OBD1> D 2066 LF36 <Euro 4/OBD1>	09.08-05.10 09.08-05.10	6	DBJ	0 445 120 217	0 986 435 526	F 00R J02 175
		12,4	324	D 2676 LF04 <Euro 2>	07.06-05.10	6	DBJ	0 445 120 219	0 986 435 528	F 00R J02 175
40.480	DF	12,8	353	D 2876 LF12 <V5300, Euro 3>	10.04-03.09	6	DBJ	0 445 120 044	0 986 435 527	
	FDA-WW	12,4	353	D 2676 LF02 <Euro 3> D 2676 LF03 <Euro 2>	07.06-05.10 07.06-05.10	6	DBJ	0 445 120 219	0 986 435 528	F 00R J02 175
	FD-WW	12,8	353	D 2876 LF12 <V5300, Euro 3> D 2876 LF25 <Euro 2>	11.04-03.09 07.06-03.09	6	DBJ	0 445 120 044	0 986 435 527	F 00R J02 175
41.350	FFD	10,5	257	D 2066 LF13 <V5500, Euro 4>	10.04-09.06	6	DBJ	0 445 120 217	0 986 435 526	F 00R J02 175
	FFD-WW	10,5	257	D 2066 LF03 <Euro 3>	03.04-05.10	6	DBJ	0 445 120 218	0 986 435 517	F 00R J02 175
41.360	FFD	10,5	265	D 2066 LF33 <V5500, Euro 4> D 2066 LF38 <Euro 4/OBD1>	07.06-08.08 09.07-08.08	6	DBJ	0 445 120 217	0 986 435 526	F 00R J02 175
	FV-WW	10,5	265	D 2066 LF07 <Euro 2>	07.06-05.10	6	DBJ	0 445 120 218	0 986 435 517	F 00R J02 175
41.390	FFD	10,5	287	D 2066 LF12 <Euro 4>	10.04-09.06	6	DBJ	0 445 120 217	0 986 435 526	F 00R J02 175
	FFD-WW	10,5	287	D 2066 LF02 <Euro 3>	03.04-05.10	6	DBJ	0 445 120 218	0 986 435 517	F 00R J02 175
41.400	FFD	10,5	294	D 2066 LF32 <Euro 4/OBD1> D 2066 LF37 <Euro 4/OBD1>	07.06-08.08 09.07-08.08	6	DBJ	0 445 120 217	0 986 435 526	F 00R J02 175
	FV-WW	10,5	294	D 2066 LF06 <Euro 2>	07.06-05.10	6	DBJ	0 445 120 218	0 986 435 517	F 00R J02 175
41.430	FFD	10,5	316	D 2066 LF11 <V5500, Euro 4>	10.04-09.06	6	DBJ	0 445 120 217	0 986 435 526	F 00R J02 175
	FFD, FFD-WW	10,5	316	D 2066 LF01 <Euro 3>	03.04-05.10	6	DBJ	0 445 120 218	0 986 435 517	F 00R J02 175
41.440	FFD	10,5	324	D 2066 LF31 <Euro 4/OBD1>; D 2066 LF36 <Euro 4/OBD1>	07.06-08.08	6	DBJ	0 445 120 217	0 986 435 526	F 00R J02 175
	FV-WW	12,4	324	D 2676 LF04 <Euro 2>	07.06-05.10	6	DBJ	0 445 120 219	0 986 435 528	F 00R J02 175
41.480	FFD	12,4	353	D 2676 LF01 <Euro4/OBD1> D 2676 LF05 <Euro 4/OBD1>	07.06-08.08 10.07-08.08	6	DBJ	0 445 120 219	0 986 435 528	F 00R J02 175
		12,8	353	D 2876 LF12 <V5300, Euro 3>	05.03-03.09	6	DBJ	0 445 120 044	0 986 435 527	
	FFD-WW	12,8	353	D 2876 LF12 <V5300, Euro 3> D 2876 LF25 <Euro 2>	06.03-03.09 07.06-03.09	6	DBJ	0 445 120 044	0 986 435 527	F 00R J02 175
	FV-WW	12,4	353	D 2676 LF02 <Euro 3> D 2676 LF03 <Euro 2>	07.06-05.10 07.06-05.10	6	DBJ	0 445 120 219	0 986 435 528	F 00R J02 175
41.530	FFD, FV	12,8	390	D 2876 LF13 <V5300, Euro 3>	06.03-09.06	6	DBJ	0 445 120 044	0 986 435 527	
41.540	FV	12,4	397	D 2676 LF11 <Euro 5/OBD1>; D 2676 LF13 <Euro 5/OBD1>	04.07-07.08	6	DBJ	0 445 120 219	0 986 435 528	F 00R J02 175
41.660	VF	18,3	485	D 2840 LF25 <V5800, Euro 3>	04.03-09.06	10	DBJ	0 445 120 031		F 00R J02 175





◀ MAN

TGD									
18.400 WW	10,5	294	D 2066 LFL49 <Euro 3>	06.10→	6	DBJ	0 445 120 217	0 986 435 526	F 00R J02 175
TGL									
7.150	4,6	110	D 0834 LFLAA <Euro 6/OBDC>; D 0834 LFL66 <Euro 6>	06.13→	4	DBJ	0 445 120 186	0 986 435 568	F 00R J02 175
			D 0834 LFL40 <Euro 3>	06.11→	4	DBJ	0 445 120 045	0 986 435 558	F 00R J02 175
			D 0834 LFL60 <Euro 5/EEV/OBD2>; D 0834 LFL63 <Euro 5/OBD2>	04.09→	4	DBJ	0 445 120 186	0 986 435 568	F 00R J02 175
L	4,6	110	D 0834 LFL40 <Euro 3>	05.05-09.06	4	DBJ	0 445 120 045	0 986 435 558	F 00R J02 175
			D 0834 LFL50 <Euro 4/OBD1>; D 0834 LFL53 <Euro 4/OBD1>	04.06→	4	DBJ	0 445 120 148	0 986 435 563	F 00R J02 175
7.160	4,6	118	D 0834 LFL77 <Euro 6/OBDC>	09.17→	4	DBJ	0 445 120 162	0 986 435 565	F 00R J02 175
7.180	4,6	132	D 0834 LFLAB <Euro 6/OBDC>; D 0834 LFL67 <Euro 6>	06.13→	4	DBJ	0 445 120 186	0 986 435 568	F 00R J02 175
			D 0834 LFL41 <Euro 3>	06.11→	4	DBJ	0 445 120 045	0 986 435 558	F 00R J02 175
			D 0834 LFL61 <Euro 5/EEV/OBD2>	04.09→	4	DBJ	0 445 120 162	0 986 435 565	F 00R J02 175
			D 0834 LFL64 <Euro 5/OBD2>	04.09→	4	DBJ	0 445 120 162	0 986 435 565	F 00R J02 175
L	4,6	132	D 0834 LFL41 <Euro 3>	05.05-09.06	4	DBJ	0 445 120 045	0 986 435 558	F 00R J02 175
			D 0834 LFL51 <Euro 4/OBD1>; D 0834 LFL54 <Euro 4/OBD1>	04.06→	4	DBJ	0 445 120 147	0 986 435 562	F 00R J02 175
7.190	4,6	140	D 0834 LFL78 <Euro 6/OBDC>	09.17→	4	DBJ	0 445 120 162	0 986 435 565	F 00R J02 175
8.150	4,6	110	D 0834 LFLAA <Euro 6/OBDC>; D 0834 LFL66 <Euro 6>	06.13→	4	DBJ	0 445 120 186	0 986 435 568	F 00R J02 175
			D 0834 LFL40 <Euro 3>	06.11→	4	DBJ	0 445 120 045	0 986 435 558	F 00R J02 175
			D 0834 LFL60 <Euro 5/EEV/OBD2>; D 0834 LFL63 <Euro 5/OBD2>	04.09→	4	DBJ	0 445 120 186	0 986 435 568	F 00R J02 175
L	4,6	110	D 0834 LFL50 <Euro 4/OBD1>; D 0834 LFL53 <Euro 4/OBD1>	02.07→	4	DBJ	0 445 120 148	0 986 435 563	F 00R J02 175
8.160	4,6	118	D 0834 LFL77 <Euro 6/OBDC>	09.17→	4	DBJ	0 445 120 162	0 986 435 565	F 00R J02 175
8.180	4,6	132	D 0834 LFLAB <Euro 6/OBDC>; D 0834 LFL67 <Euro 6>	06.13→	4	DBJ	0 445 120 186	0 986 435 568	F 00R J02 175
			D 0834 LFL61 <Euro 5/EEV/OBD2>	04.09→	4	DBJ	0 445 120 162	0 986 435 565	F 00R J02 175
			D 0834 LFL64 <Euro 5/OBD2>	04.09→	4	DBJ	0 445 120 162	0 986 435 565	F 00R J02 175
L	4,6	132	D 0834 LFL41 <Euro 3>	05.05→	4	DBJ	0 445 120 045	0 986 435 558	F 00R J02 175
			D 0834 LFL51 <Euro 4/OBD1>; D 0834 LFL54 <Euro 4/OBD1>	04.06→	4	DBJ	0 445 120 147	0 986 435 562	F 00R J02 175
8.190	4,6	140	D 0834 LFL78 <Euro 6/OBDC>	09.17→	4	DBJ	0 445 120 162	0 986 435 565	F 00R J02 175
8.210 L	4,6	151	D 0834 LFL42 <Euro 3>	05.05→	4	DBJ	0 445 120 045	0 986 435 558	F 00R J02 175
			D 0834 LFL52 <Euro 4/OBD1>; D 0834 LFL55 <Euro 4/OBD1>	04.06→	4	DBJ	0 445 120 147	0 986 435 562	F 00R J02 175
8.220	4,6	162	D 0834 LFLAC <Euro 6/OBDC>; D 0834 LFL68 <Euro 6>; D 0834 LFL79 <Euro 6/OBDC>	06.13→	4	DBJ	0 445 120 162	0 986 435 565	F 00R J02 175
			D 0834 LFL62 <Euro 5/EEV/OBD2>	04.09→	4	DBJ	0 445 120 162	0 986 435 565	F 00R J02 175
			D 0834 LFL65 <Euro 5/OBD2>	04.09→	4	DBJ	0 445 120 162	0 986 435 565	F 00R J02 175
8.240 L	6,9	176	D 0836 LFL40 <Euro 3>	05.05-12.13	6	DBJ	0 445 120 045	0 986 435 558	F 00R J02 175
			D 0836 LFL50 <Euro 4/OBD1>	04.06-12.13	6	DBJ	0 445 120 148	0 986 435 563	F 00R J02 175
				01.08-12.13	6	DBJ	0 445 120 148	0 986 435 563	F 00R J02 175
			D 0836 LFL53 <Euro 4/OBD1>	09.07-12.13	6	DBJ	0 445 120 148	0 986 435 563	F 00R J02 175
				01.08-12.13	6	DBJ	0 445 120 148	0 986 435 563	F 00R J02 175
8.250	6,9	184	D 0836 LFLAA <Euro 6/OBDC>; D 0836 LFL60 <Euro 5/EEV/OBD2>; D 0836 LFL63 <Euro 5/OBD2>; D 0836 LFL66 <Euro 6>	04.09→	6	DBJ	0 445 120 186	0 986 435 568	F 00R J02 175
			D 0836 LFL79 <Euro 6/OBDC>	09.17→	6	DBJ	0 445 120 162	0 986 435 565	F 00R J02 175
10.180	4,6	132	D 0834 LFLAB <Euro 6/OBDC>; D 0834 LFL67 <Euro 6>	06.13→	4	DBJ	0 445 120 186	0 986 435 568	F 00R J02 175





<b>10.180</b>	4,6	132	D 0834 LFL61 <Euro 5/EEV/OBD2>	04.09→	4	DBJ	<b>0 445 120 162</b>	<b>0 986 435 565</b>	<b>F 00R J02 175</b>
			D 0834 LFL64 <Euro 5/OBD2>	04.09→	4	DBJ	<b>0 445 120 162</b>	<b>0 986 435 565</b>	<b>F 00R J02 175</b>
L	4,6	132	D 0834 LFL41 <Euro 3>	05.05→	4	DBJ	<b>0 445 120 045</b>	<b>0 986 435 558</b>	<b>F 00R J02 175</b>
			D 0834 LFL51 <Euro 4/OBD1>; D 0834 LFL54 <Euro 4/OBD1>	04.06→	4	DBJ	<b>0 445 120 147</b>	<b>0 986 435 562</b>	<b>F 00R J02 175</b>
<b>10.190</b>	4,6	140	D 0834 LFL78 <Euro 6/OBDC>	09.17→	4	DBJ	<b>0 445 120 162</b>	<b>0 986 435 565</b>	<b>F 00R J02 175</b>
<b>10.210 L</b>	4,6	151	D 0834 LFL42 <Euro 3>	05.05→	4	DBJ	<b>0 445 120 045</b>	<b>0 986 435 558</b>	<b>F 00R J02 175</b>
			D 0834 LFL52 <Euro 4/OBD1>; D 0834 LFL55 <Euro 4/OBD1>	04.06→	4	DBJ	<b>0 445 120 147</b>	<b>0 986 435 562</b>	<b>F 00R J02 175</b>
<b>10.220</b>	4,6	162	D 0834 LFLAC <Euro 6/OBDC>; D 0834 LFL68 <Euro 6>; D 0834 LFL79 <Euro 6/OBDC>	06.13→	4	DBJ	<b>0 445 120 162</b>	<b>0 986 435 565</b>	<b>F 00R J02 175</b>
			D 0834 LFL62 <Euro 5/EEV/OBD2>	04.09→	4	DBJ	<b>0 445 120 162</b>	<b>0 986 435 565</b>	<b>F 00R J02 175</b>
			D 0834 LFL65 <Euro 5/OBD2>	04.09→	4	DBJ	<b>0 445 120 162</b>	<b>0 986 435 565</b>	<b>F 00R J02 175</b>
<b>10.240 L</b>	6,9	176	D 0836 LFL40 <Euro 3>	05.05→	6	DBJ	<b>0 445 120 045</b>	<b>0 986 435 558</b>	<b>F 00R J02 175</b>
			D 0836 LFL50 <Euro 4/OBD1>	04.06-12.13	6	DBJ	<b>0 445 120 148</b>	<b>0 986 435 563</b>	<b>F 00R J02 175</b>
				01.08-12.13	6	DBJ	<b>0 445 120 148</b>	<b>0 986 435 563</b>	<b>F 00R J02 175</b>
			D 0836 LFL53 <Euro 4/OBD1>	09.07→	6	DBJ	<b>0 445 120 148</b>	<b>0 986 435 563</b>	<b>F 00R J02 175</b>
				01.08→	6	DBJ	<b>0 445 120 148</b>	<b>0 986 435 563</b>	<b>F 00R J02 175</b>
<b>10.250</b>	6,9	184	D 0836 LFLAA <Euro 6/OBDC>; D 0836 LFL60 <Euro 5/EEV/OBD2>; D 0836 LFL63 <Euro 5/OBD2>; D 0836 LFL66 <Euro 6>	04.09→	6	DBJ	<b>0 445 120 186</b>	<b>0 986 435 568</b>	<b>F 00R J02 175</b>
			D 0836 LFL79 <Euro 6/OBDC>	09.17→	6	DBJ	<b>0 445 120 162</b>	<b>0 986 435 565</b>	<b>F 00R J02 175</b>
<b>12.180</b>	4,6	132	D 0834 LFLAB <Euro 6/OBDC>; D 0834 LFL67 <Euro 6>	06.13→	4	DBJ	<b>0 445 120 186</b>	<b>0 986 435 568</b>	<b>F 00R J02 175</b>
			D 0834 LFL61 <Euro 5/EEV/OBD2>	04.09→	4	DBJ	<b>0 445 120 162</b>	<b>0 986 435 565</b>	<b>F 00R J02 175</b>
			D 0834 LFL64 <Euro 5/OBD2>	04.09→	4	DBJ	<b>0 445 120 162</b>	<b>0 986 435 565</b>	<b>F 00R J02 175</b>
L	4,6	132	D 0834 LFL41 <Euro 3>	05.05→	4	DBJ	<b>0 445 120 045</b>	<b>0 986 435 558</b>	<b>F 00R J02 175</b>
			D 0834 LFL51 <Euro 4/OBD1>; D 0834 LFL54 <Euro 4/OBD1>	04.06→	4	DBJ	<b>0 445 120 147</b>	<b>0 986 435 562</b>	<b>F 00R J02 175</b>
<b>12.190</b>	4,6	140	D 0834 LFL78 <Euro 6/OBDC>	09.17→	4	DBJ	<b>0 445 120 162</b>	<b>0 986 435 565</b>	<b>F 00R J02 175</b>
<b>12.210 L</b>	4,6	151	D 0834 LFL42 <Euro 3>	05.05→	4	DBJ	<b>0 445 120 045</b>	<b>0 986 435 558</b>	<b>F 00R J02 175</b>
			D 0834 LFL52 <Euro 4/OBD1>; D 0834 LFL55 <Euro 4/OBD1>	04.06→	4	DBJ	<b>0 445 120 147</b>	<b>0 986 435 562</b>	<b>F 00R J02 175</b>
<b>12.220</b>	4,6	162	D 0834 LFLAC <Euro 6/OBDC>; D 0834 LFL68 <Euro 6>; D 0834 LFL79 <Euro 6/OBDC>	06.13→	4	DBJ	<b>0 445 120 162</b>	<b>0 986 435 565</b>	<b>F 00R J02 175</b>
			D 0834 LFL62 <Euro 5/EEV/OBD2>	04.09→	4	DBJ	<b>0 445 120 162</b>	<b>0 986 435 565</b>	<b>F 00R J02 175</b>
			D 0834 LFL65 <Euro 5/OBD2>	04.09→	4	DBJ	<b>0 445 120 162</b>	<b>0 986 435 565</b>	<b>F 00R J02 175</b>
<b>12.240 L</b>	6,9	176	D 0836 LFL40 <Euro 3>	05.05→	6	DBJ	<b>0 445 120 045</b>	<b>0 986 435 558</b>	<b>F 00R J02 175</b>
			D 0836 LFL50 <Euro 4/OBD1>	04.06-12.13	6	DBJ	<b>0 445 120 148</b>	<b>0 986 435 563</b>	<b>F 00R J02 175</b>
				01.08-12.13	6	DBJ	<b>0 445 120 148</b>	<b>0 986 435 563</b>	<b>F 00R J02 175</b>
			D 0836 LFL53 <Euro 4/OBD1>	09.07→	6	DBJ	<b>0 445 120 148</b>	<b>0 986 435 563</b>	<b>F 00R J02 175</b>
				01.08→	6	DBJ	<b>0 445 120 148</b>	<b>0 986 435 563</b>	<b>F 00R J02 175</b>
<b>12.250</b>	6,9	184	D 0836 LFLAA <Euro 6/OBDC>; D 0836 LFL60 <Euro 5/EEV/OBD2>; D 0836 LFL63 <Euro 5/OBD2>; D 0836 LFL66 <Euro 6>	04.09→	6	DBJ	<b>0 445 120 186</b>	<b>0 986 435 568</b>	<b>F 00R J02 175</b>
			D 0836 LFL79 <Euro 6/OBDC>	09.17→	6	DBJ	<b>0 445 120 162</b>	<b>0 986 435 565</b>	<b>F 00R J02 175</b>
<b>TGM</b>									
<b>12.240 L</b>	6,9	176	D 0836 LFL50 <Euro 4/OBD1>	04.06-12.13	6	DBJ	<b>0 445 120 148</b>	<b>0 986 435 563</b>	<b>F 00R J02 175</b>
				01.08-12.13	6	DBJ	<b>0 445 120 148</b>	<b>0 986 435 563</b>	<b>F 00R J02 175</b>
			D 0836 LFL53 <Euro 4/OBD1>	09.07→	6	DBJ	<b>0 445 120 148</b>	<b>0 986 435 563</b>	<b>F 00R J02 175</b>
				01.08→	6	DBJ	<b>0 445 120 148</b>	<b>0 986 435 563</b>	<b>F 00R J02 175</b>
<b>12.250</b>	6,9	184	D 0836 LFLAA <Euro 6/OBDC>; D 0836 LFL60 <Euro 5/EEV/OBD2>; D 0836 LFL63 <Euro 5/OBD2>; D 0836 LFL66 <Euro 6>	04.09→	6	DBJ	<b>0 445 120 186</b>	<b>0 986 435 568</b>	<b>F 00R J02 175</b>







◀ MAN

<b>12.250</b>	6,9	184	D 0836 LFL79 <Euro 6/OBDC>	09.17→	6	DBJ	<b>0 445 120 162</b>	<b>0 986 435 565</b>	<b>F 00R J02 175</b>
<b>12.280 L</b>	6,9	206	D 0836 LFL51 <Euro 4/OBD1>; D 0836 LFL54 <Euro 4/OBD1>	04.06→	6	DBJ	<b>0 445 120 147</b>	<b>0 986 435 562</b>	<b>F 00R J02 175</b>
<b>12.290</b>	6,9	213	D 0836 LFLAB <Euro 6/OBDC>; D 0836 LFL67 <Euro 6>; D 0836 LFL80 <Euro 6/OBDC>	06.13→	6	DBJ	<b>0 445 120 162</b>	<b>0 986 435 565</b>	<b>F 00R J02 175</b>
			D 0836 LFL61 <Euro 5/EEV/OBD2>	04.09→	6	DBJ	<b>0 445 120 162</b>	<b>0 986 435 565</b>	<b>F 00R J02 175</b>
			D 0836 LFL64 <Euro 5/OBD2>	04.09→	6	DBJ	<b>0 445 120 162</b>	<b>0 986 435 565</b>	<b>F 00R J02 175</b>
<b>13:290</b>	6,9	213	D 0836 LFL67 <Euro 6>	06.13-05.17	6	DBJ	<b>0 445 120 162</b>	<b>0 986 435 565</b>	<b>F 00R J02 175</b>
<b>13.240 L</b>	6,9	176	D 0836 LFL40 <Euro 3>	10.06→	6	DBJ	<b>0 445 120 045</b>	<b>0 986 435 558</b>	<b>F 00R J02 175</b>
			D 0836 LFL50 <Euro 4/OBD1>	10.06-12.13	6	DBJ	<b>0 445 120 148</b>	<b>0 986 435 563</b>	<b>F 00R J02 175</b>
				01.08-12.13	6	DBJ	<b>0 445 120 148</b>	<b>0 986 435 563</b>	<b>F 00R J02 175</b>
			D 0836 LFL53 <Euro 4/OBD1>	09.07→	6	DBJ	<b>0 445 120 148</b>	<b>0 986 435 563</b>	<b>F 00R J02 175</b>
				01.08→	6	DBJ	<b>0 445 120 148</b>	<b>0 986 435 563</b>	<b>F 00R J02 175</b>
<b>13.250</b>	6,9	184	D 0836 LFLAA <Euro 6/OBDC>; D 0836 LFL60 <Euro 5/EEV/OBD2>; D 0836 LFL63 <Euro 5/OBD2>; D 0836 LFL66 <Euro 6>	04.09→	6	DBJ	<b>0 445 120 186</b>	<b>0 986 435 568</b>	<b>F 00R J02 175</b>
			D 0836 LFL79 <Euro 6/OBDC>	09.17→	6	DBJ	<b>0 445 120 162</b>	<b>0 986 435 565</b>	<b>F 00R J02 175</b>
<b>13.280 L</b>	6,9	206	D 0836 LFL41 <Euro 3>	07.06→	6	DBJ	<b>0 445 120 045</b>	<b>0 986 435 558</b>	<b>F 00R J02 175</b>
			D 0836 LFL51 <Euro 4/OBD1>; D 0836 LFL54 <Euro 4/OBD1>	10.06→	6	DBJ	<b>0 445 120 147</b>	<b>0 986 435 562</b>	<b>F 00R J02 175</b>
<b>13.290</b>	6,9	213	D 0836 LFLAB <Euro 6/OBDC>; D 0836 LFL80 <Euro 6/OBDC>	06.16→	6	DBJ	<b>0 445 120 162</b>	<b>0 986 435 565</b>	<b>F 00R J02 175</b>
			D 0836 LFL61 <Euro 5/EEV/OBD2>	04.09→	6	DBJ	<b>0 445 120 162</b>	<b>0 986 435 565</b>	<b>F 00R J02 175</b>
			D 0836 LFL64 <Euro 5/OBD2>	04.09→	6	DBJ	<b>0 445 120 162</b>	<b>0 986 435 565</b>	<b>F 00R J02 175</b>
<b>15.240</b>	6,9	176	D 0836 LFL40 <Euro 3>	09.11→	6	DBJ	<b>0 445 120 045</b>	<b>0 986 435 558</b>	<b>F 00R J02 175</b>
L	6,9	176	D 0836 LFL50 <Euro 4/OBD1>	04.06-12.13	6	DBJ	<b>0 445 120 148</b>	<b>0 986 435 563</b>	<b>F 00R J02 175</b>
				01.08-12.13	6	DBJ	<b>0 445 120 148</b>	<b>0 986 435 563</b>	<b>F 00R J02 175</b>
			D 0836 LFL53 <Euro 4/OBD1>	09.07→	6	DBJ	<b>0 445 120 148</b>	<b>0 986 435 563</b>	<b>F 00R J02 175</b>
				01.08→	6	DBJ	<b>0 445 120 148</b>	<b>0 986 435 563</b>	<b>F 00R J02 175</b>
<b>15.250</b>	6,9	184	D 0836 LFLAA <Euro 6/OBDC>; D 0836 LFL60 <Euro 5/EEV/OBD2>; D 0836 LFL63 <Euro 5/OBD2>; D 0836 LFL66 <Euro 6>	04.09→	6	DBJ	<b>0 445 120 186</b>	<b>0 986 435 568</b>	<b>F 00R J02 175</b>
			D 0836 LFL79 <Euro 6/OBDC>	09.17→	6	DBJ	<b>0 445 120 162</b>	<b>0 986 435 565</b>	<b>F 00R J02 175</b>
<b>15.280</b>	6,9	206	D 0836 LFL41 <Euro 3>	09.11→	6	DBJ	<b>0 445 120 045</b>	<b>0 986 435 558</b>	<b>F 00R J02 175</b>
L	6,9	206	D 0836 LFL51 <Euro 4/OBD1>; D 0836 LFL54 <Euro 4/OBD1>	04.06→	6	DBJ	<b>0 445 120 147</b>	<b>0 986 435 562</b>	<b>F 00R J02 175</b>
<b>15.290</b>	6,9	213	D 0836 LFLAB <Euro 6/OBDC>; D 0836 LFL67 <Euro 6>; D 0836 LFL80 <Euro 6/OBDC>	06.13→	6	DBJ	<b>0 445 120 162</b>	<b>0 986 435 565</b>	<b>F 00R J02 175</b>
			D 0836 LFL61 <Euro 5/EEV/OBD2>	04.09→	6	DBJ	<b>0 445 120 162</b>	<b>0 986 435 565</b>	<b>F 00R J02 175</b>
			D 0836 LFL64 <Euro 5/OBD2>	04.09→	6	DBJ	<b>0 445 120 162</b>	<b>0 986 435 565</b>	<b>F 00R J02 175</b>
<b>15.320</b>	6,9	235	D 0836 LFL81 <Euro 6/OBDC>	09.17→	6	DBJ	<b>0 445 120 162</b>	<b>0 986 435 565</b>	<b>F 00R J02 175</b>
<b>15.330</b>	6,9	240	D 0836 LFL44 <Euro 3>	09.11→	6	DBJ	<b>0 445 120 045</b>	<b>0 986 435 558</b>	<b>F 00R J02 175</b>
L	6,9	240	D 0836 LFL51 <Euro 4/OBD1>; D 0836 LFL55 <Euro 4/OBD1>	04.06→	6	DBJ	<b>0 445 120 147</b>	<b>0 986 435 562</b>	<b>F 00R J02 175</b>
<b>15.340</b>	6,9	250	D 0836 LFL62 <Euro 5/EEV/OBD2>	04.09→	6	DBJ	<b>0 445 120 162</b>	<b>0 986 435 565</b>	<b>F 00R J02 175</b>
			D 0836 LFL65 <Euro 5/OBD2>	04.09→	6	DBJ	<b>0 445 120 162</b>	<b>0 986 435 565</b>	<b>F 00R J02 175</b>
		250/251	D 0836 LFLAC <Euro 6/OBDC>; D 0836 LFL68 <Euro 6>	06.13→	6	DBJ	<b>0 445 120 162</b>	<b>0 986 435 565</b>	<b>F 00R J02 175</b>
<b>18.240 L</b>	6,9	176	D 0836 LFL40 <Euro 3>	10.05→	6	DBJ	<b>0 445 120 045</b>	<b>0 986 435 558</b>	<b>F 00R J02 175</b>
			D 0836 LFL50 <Euro 4/OBD1>	04.06-12.13	6	DBJ	<b>0 445 120 148</b>	<b>0 986 435 563</b>	<b>F 00R J02 175</b>
				01.08-12.13	6	DBJ	<b>0 445 120 148</b>	<b>0 986 435 563</b>	<b>F 00R J02 175</b>
			D 0836 LFL53 <Euro 4/OBD1>	09.07→	6	DBJ	<b>0 445 120 148</b>	<b>0 986 435 563</b>	<b>F 00R J02 175</b>
				01.08→	6	DBJ	<b>0 445 120 148</b>	<b>0 986 435 563</b>	<b>F 00R J02 175</b>





18.250	6,9	184	D 0836 LFLAA <Euro 6/OBDC>; D 0836 LFL60 <Euro 5/EEV/OBD2>; D 0836 LFL63 <Euro 5/OBD2>; D 0836 LFL66 <Euro 6>	04.09→	6	DBJ	0 445 120 186	0 986 435 568	F 00R J02 175
			D 0836 LFL79 <Euro 6/OBDC>	09.17→	6	DBJ	0 445 120 162	0 986 435 565	F 00R J02 175
18.280 , L	6,9	206	D 0836 LFL51 <Euro 4/OBD1>; D 0836 LFL54 <Euro 4/OBD1>	04.06→	6	DBJ	0 445 120 147	0 986 435 562	F 00R J02 175
L	6,9	206	D 0836 LFL41 <Euro 3>	10.05→	6	DBJ	0 445 120 045	0 986 435 558	F 00R J02 175
18.290	6,9	213	D 0836 LFLAB <Euro 6/OBDC>; D 0836 LFL67 <Euro 6>; D 0836 LFL80 <Euro 6/OBDC>	06.13→	6	DBJ	0 445 120 162	0 986 435 565	F 00R J02 175
			D 0836 LFL61 <Euro 5/EEV/OBD2>	04.09→	6	DBJ	0 445 120 162	0 986 435 565	F 00R J02 175
			D 0836 LFL64 <Euro 5/OBD2>	04.09→	6	DBJ	0 445 120 162	0 986 435 565	F 00R J02 175
18.320	6,9	235	D 0836 LFL81 <Euro 6/OBDC>	09.17→	6	DBJ	0 445 120 162	0 986 435 565	F 00R J02 175
	10,5	235	D 2066 LF68 <Euro 6>; D 2066 LF81 <Euro 6>	10.12→	6	DBJ	0 445 120 353	0 986 435 593	F 00R J02 175
18.330 , L	6,9	240	D 0836 LFL52 <Euro 4/OBD1>; D 0836 LFL55 <Euro 4/OBD1>	07.06→	6	DBJ	0 445 120 147	0 986 435 562	F 00R J02 175
L	6,9	240	D 0836 LFL44 <Euro 3>	10.05→	6	DBJ	0 445 120 045	0 986 435 558	F 00R J02 175
18.340	6,9	250	D 0836 LFL62 <Euro 5/EEV/OBD2>	04.09→	6	DBJ	0 445 120 162	0 986 435 565	F 00R J02 175
			D 0836 LFL65 <Euro 5/OBD2>	04.09→	6	DBJ	0 445 120 162	0 986 435 565	F 00R J02 175
		250/251	D 0836 LFLAC <Euro 6/OBDC>; D 0836 LFL68 <Euro 6>	06.13→	6	DBJ	0 445 120 162	0 986 435 565	F 00R J02 175
18.360	10,5	265	D 2066 LF80 <Euro 6>	06.15→	6	DBJ	0 445 120 353	0 986 435 593	F 00R J02 175
19.250	6,9	184	D 0836 LFLAA <Euro 6/OBDC>; D 0836 LFL60 <Euro 5/EEV/OBD2>; D 0836 LFL63 <Euro 5/OBD2>; D 0836 LFL66 <Euro 6>	10.12→	6	DBJ	0 445 120 186	0 986 435 568	F 00R J02 175
			D 0836 LFL79 <Euro 6/OBDC>	09.17→	6	DBJ	0 445 120 162	0 986 435 565	F 00R J02 175
19.290	6,9	213	D 0836 LFLAB <Euro 6/OBDC>; D 0836 LFL67 <Euro 6>; D 0836 LFL80 <Euro 6/OBDC>	06.13→	6	DBJ	0 445 120 162	0 986 435 565	F 00R J02 175
			D 0836 LFL61 <Euro 5/EEV/OBD2>	10.12→	6	DBJ	0 445 120 162	0 986 435 565	F 00R J02 175
			D 0836 LFL64 <Euro 5/OBD2>	10.12→	6	DBJ	0 445 120 162	0 986 435 565	F 00R J02 175
19.320	6,9	235	D 0836 LFL81 <Euro 6/OBDC>	09.17→	6	DBJ	0 445 120 162	0 986 435 565	F 00R J02 175
19.340	6,9	250	D 0836 LFL62 <Euro 5/EEV/OBD2>	10.12→	6	DBJ	0 445 120 162	0 986 435 565	F 00R J02 175
			D 0836 LFL65 <Euro 5/OBD2>	10.12→	6	DBJ	0 445 120 162	0 986 435 565	F 00R J02 175
		250/251	D 0836 LFLAC <Euro 6/OBDC>; D 0836 LFL68 <Euro 6>	06.13→	6	DBJ	0 445 120 162	0 986 435 565	F 00R J02 175
22.240 L	6,9	176	D 0836 LFL53 <Euro 4/OBD1>	09.07→	6	DBJ	0 445 120 148	0 986 435 563	F 00R J02 175
				01.08→	6	DBJ	0 445 120 148	0 986 435 563	F 00R J02 175
22.250	6,9	184	D 0836 LFL60 <Euro 5/EEV/OBD2>; D 0836 LFL63 <Euro 5/OBD2>; D 0836 LFL66 <Euro 6>	04.09→	6	DBJ	0 445 120 186	0 986 435 568	F 00R J02 175
22.280	6,9	206	D 0836 LFL54 <Euro 4/OBD1>	09.07→	6	DBJ	0 445 120 147	0 986 435 562	F 00R J02 175
22.290	6,9	213	D 0836 LFL61 <Euro 5/EEV/OBD2>	04.09→	6	DBJ	0 445 120 162	0 986 435 565	F 00R J02 175
			D 0836 LFL64 <Euro 5/OBD2>	04.09→	6	DBJ	0 445 120 162	0 986 435 565	F 00R J02 175
			D 0836 LFL67 <Euro 6>	06.13-06.16	6	DBJ	0 445 120 162	0 986 435 565	F 00R J02 175
26.280 L	6,9	206	D 0836 LFL51 <Euro 4/OBD1>; D 0836 LFL54 <Euro 4/OBD1>	09.06→	6	DBJ	0 445 120 147	0 986 435 562	F 00R J02 175
26.290	6,9	213	D 0836 LFLAB <Euro 6/OBDC>; D 0836 LFL67 <Euro 6>; D 0836 LFL80 <Euro 6/OBDC>	06.13→	6	DBJ	0 445 120 162	0 986 435 565	F 00R J02 175
			D 0836 LFL61 <Euro 5/EEV/OBD2>	04.09→	6	DBJ	0 445 120 162	0 986 435 565	F 00R J02 175
			D 0836 LFL64 <Euro 5/OBD2>	04.09→	6	DBJ	0 445 120 162	0 986 435 565	F 00R J02 175
26.320	6,9	235	D 0836 LFL81 <Euro 6/OBDC>	09.17→	6	DBJ	0 445 120 162	0 986 435 565	F 00R J02 175







◀ MAN

<b>26.330 L</b>	6,9	240	D 0836 LFL52 <Euro 4/OBD1>; D 0836 LFL55 <Euro 4/OBD1>	07.06→	6	DBJ	<b>0 445 120 147</b>	<b>0 986 435 562</b>	<b>F 00R J02 175</b>
<b>26.340</b>	6,9	250	D 0836 LFL62 <Euro 5/EEV/OBD2>	04.09→	6	DBJ	<b>0 445 120 162</b>	<b>0 986 435 565</b>	<b>F 00R J02 175</b>
			D 0836 LFL65 <Euro 5/OBD2>	04.09→	6	DBJ	<b>0 445 120 162</b>	<b>0 986 435 565</b>	<b>F 00R J02 175</b>
	250/251		D 0836 LFLAC <Euro 6/OBDC>; D 0836 LFL68 <Euro 6>	06.13→	6	DBJ	<b>0 445 120 162</b>	<b>0 986 435 565</b>	<b>F 00R J02 175</b>
<b>TGS</b>									
<b>18.320</b>	10,5	235	D 2066 LF20 <Euro 5/OBD1>; D 2066 LF28 <Euro 5/OBD1>; D 2066 LF39 <Euro 4/OBD1>	10.07-06.16	6	DBJ	<b>0 445 120 217</b>	<b>0 986 435 526</b>	<b>F 00R J02 175</b>
			D 2066 LF43 <Euro 5/OBD2>	09.09→	6	DBJ	<b>0 445 120 217</b>	<b>0 986 435 526</b>	<b>F 00R J02 175</b>
			D 2066 LF53 <Euro 5/OBD2>	10.09-06.16	6	DBJ	<b>0 445 120 201</b>	<b>0 986 435 656</b>	<b>F 00R J02 175</b>
			D 2066 LF60 <Euro 5/EEV/OBD2>	09.09→	6	DBJ	<b>0 445 120 217</b>	<b>0 986 435 526</b>	<b>F 00R J02 175</b>
			D 2066 LF86 <Euro 6/OBDC>	09.16→	6	DBJ	<b>0 445 120 353</b>	<b>0 986 435 593</b>	<b>F 00R J02 175</b>
<b>18.350 WW</b>	10,5	257	D 2066 LF03 <Euro 3>	06.10-12.13	6	DBJ	<b>0 445 120 218</b>	<b>0 986 435 517</b>	<b>F 00R J02 175</b>
<b>18.360</b>	10,5	265	D 2066 LF19 <Euro 5/OBD1>; D 2066 LF27 <Euro 5/OBD1>; D 2066 LF38 <Euro 4/OBD1>	10.07-06.16	6	DBJ	<b>0 445 120 217</b>	<b>0 986 435 526</b>	<b>F 00R J02 175</b>
			D 2066 LF52 <Euro 5/OBD2>	10.09-06.16	6	DBJ	<b>0 445 120 201</b>	<b>0 986 435 656</b>	<b>F 00R J02 175</b>
			D 2066 LF59 <Euro 5/EEV/OBD2>	09.09→	6	DBJ	<b>0 445 120 217</b>	<b>0 986 435 526</b>	<b>F 00R J02 175</b>
			D 2066 LF67 <Euro 6>	10.12-06.16	6	DBJ	<b>0 445 120 353</b>	<b>0 986 435 593</b>	<b>F 00R J02 175</b>
			D 2066 LF85 <Euro 6/OBDC>	09.16→	6	DBJ	<b>0 445 120 353</b>	<b>0 986 435 593</b>	<b>F 00R J02 175</b>
, WW	10,5	265	D 2066 LF42 <Euro 5/OBD2>	09.09→	6	DBJ	<b>0 445 120 217</b>	<b>0 986 435 526</b>	<b>F 00R J02 175</b>
WW	10,5	265	D 2066 LF48 <Euro 3>	06.10→	6	DBJ	<b>0 445 120 217</b>	<b>0 986 435 526</b>	<b>F 00R J02 175</b>
			D 2066 LF64 <Euro 4/OBD2>	06.10→	6	DBJ	<b>0 445 120 217</b>	<b>0 986 435 526</b>	<b>F 00R J02 175</b>
<b>18.390 WW</b>	10,5	287	D 2066 LF02 <Euro 3>	06.10-12.13	6	DBJ	<b>0 445 120 218</b>	<b>0 986 435 517</b>	<b>F 00R J02 175</b>
<b>18.400</b>	10,5	294	D 2066 LF18 <Euro 5/OBD1>; D 2066 LF26 <Euro 5/OBD1>; D 2066 LF37 <Euro 4/OBD1>	10.07-06.16	6	DBJ	<b>0 445 120 217</b>	<b>0 986 435 526</b>	<b>F 00R J02 175</b>
			D 2066 LF51 <Euro 5/OBD2>	10.09-06.16	6	DBJ	<b>0 445 120 201</b>	<b>0 986 435 656</b>	<b>F 00R J02 175</b>
			D 2066 LF58 <Euro 5/EEV/OBD2>	09.09→	6	DBJ	<b>0 445 120 217</b>	<b>0 986 435 526</b>	<b>F 00R J02 175</b>
			D 2066 LF61 <Euro 6>	10.12-06.16	6	DBJ	<b>0 445 120 353</b>	<b>0 986 435 593</b>	<b>F 00R J02 175</b>
	12,4	294	D 2676 LF47 <Euro 6>	03.15→	6	DBJ	<b>0 445 120 354</b>	<b>0 986 435 650</b>	<b>F 00R J02 175</b>
, WW	10,5	294	D 2066 LF41 <Euro 5/OBD2>	09.09→	6	DBJ	<b>0 445 120 217</b>	<b>0 986 435 526</b>	<b>F 00R J02 175</b>
WW	10,5	294	D 2066 LF63 <Euro 4/OBD2>	06.10→	6	DBJ	<b>0 445 120 217</b>	<b>0 986 435 526</b>	<b>F 00R J02 175</b>
<b>18.420</b>	12,4	309	D 2676 LF53 <Euro 6/OBDC>	06.16→	6	DBJ	<b>0 445 120 420</b>		<b>F 00R J02 175</b>
<b>18.430 WW</b>	10,5	316	D 2066 LF01 <Euro 3>	06.10-12.13	6	DBJ	<b>0 445 120 218</b>	<b>0 986 435 517</b>	<b>F 00R J02 175</b>
<b>18.440</b>	10,5	324	D 2066 LF17 <Euro 5/OBD1>; D 2066 LF25 <Euro 5/OBD1>; D 2066 LF36 <Euro 4/OBD1>	10.07-06.16	6	DBJ	<b>0 445 120 217</b>	<b>0 986 435 526</b>	<b>F 00R J02 175</b>
			D 2066 LF57 <Euro 5/EEV/OBD2>	09.09→	6	DBJ	<b>0 445 120 217</b>	<b>0 986 435 526</b>	<b>F 00R J02 175</b>
	12,4	324	D 2676 LF22 <Euro 5/OBD2>	10.09-06.16	6	DBJ	<b>0 445 120 202</b>	<b>0 986 435 570</b>	<b>F 00R J02 175</b>
			D 2676 LF26 <Euro 6>; D 2676 LF46 <Euro 6>	10.12→	6	DBJ	<b>0 445 120 354</b>	<b>0 986 435 650</b>	<b>F 00R J02 175</b>
, WW	10,5	324	D 2066 LF40 <Euro 5/OBD2>	09.09→	6	DBJ	<b>0 445 120 217</b>	<b>0 986 435 526</b>	<b>F 00R J02 175</b>
WW	10,5	324	D 2066 LF50 <Euro 3>	06.10→	6	DBJ	<b>0 445 120 217</b>	<b>0 986 435 526</b>	<b>F 00R J02 175</b>
			D 2066 LF62 <Euro 4/OBD2>	06.10→	6	DBJ	<b>0 445 120 217</b>	<b>0 986 435 526</b>	<b>F 00R J02 175</b>
<b>18.460</b>	12,4	338	D 2676 LF52 <Euro 6/OBDC>	06.16→	6	DBJ	<b>0 445 120 420</b>		<b>F 00R J02 175</b>
<b>18.480</b>	12,4	353	D 2676 LF18 <Euro 5/EEV/OBD2>	09.09→	6	DBJ	<b>0 445 120 219</b>	<b>0 986 435 528</b>	<b>F 00R J02 175</b>
			D 2676 LF25 <Euro 6>; D 2676 LF45 <Euro 6>	10.12→	6	DBJ	<b>0 445 120 354</b>	<b>0 986 435 650</b>	<b>F 00R J02 175</b>
, F, FL	12,4	353	D 2676 LF05 <Euro 4/OBD1>; D 2676 LF14 <Euro 5/OBD1>; D 2676 LF16 <Euro 5/OBD1>	10.07-06.16	6	DBJ	<b>0 445 120 219</b>	<b>0 986 435 528</b>	<b>F 00R J02 175</b>
, WW	12,4	353	D 2676 LF07 <Euro 5/OBD2>	09.09→	6	DBJ	<b>0 445 120 219</b>	<b>0 986 435 528</b>	<b>F 00R J02 175</b>
WW	12,4	353	D 2676 LF02 <Euro 3>; D 2676 LF20 <Euro 4/OBD2>	06.10→	6	DBJ	<b>0 445 120 219</b>	<b>0 986 435 528</b>	<b>F 00R J02 175</b>
<b>18.500</b>	12,4	368	D 2676 LF51 <Euro 6/OBDC>	06.16→	6	DBJ	<b>0 445 120 420</b>		<b>F 00R J02 175</b>
<b>18.540</b>	12,4	397	D 2676 LF06 <Euro 5/OBD2>; D 2676 LF13 <Euro 5/OBD1>; D 2676 LF15 <Euro 5/OBD1>	10.07→	6	DBJ	<b>0 445 120 219</b>	<b>0 986 435 528</b>	<b>F 00R J02 175</b>
<b>19.320 WW</b>	10,5	235	D 2066 LF43 <Euro 5/OBD2>	06.16→	6	DBJ	<b>0 445 120 217</b>	<b>0 986 435 526</b>	<b>F 00R J02 175</b>





19.350 WW	10,5	257	D 2066 LF03 <Euro 3>	01.10-12.13	6	DBJ	0 445 120 218	0 986 435 517	F 00R J02 175
19.360 WW	10,5	265	D 2066 LF07 <Euro 2>	01.10→	6	DBJ	0 445 120 218	0 986 435 517	F 00R J02 175
			D 2066 LF42 <Euro 5/OBD2>;	06.16→	6	DBJ	0 445 120 217	0 986 435 526	F 00R J02 175
			D 2066 LF59 <Euro 5/EEV/OBD2>						
			D 2066 LF48 <Euro 3>	02.11→	6	DBJ	0 445 120 217	0 986 435 526	F 00R J02 175
			D 2066 LF64 <Euro 4/OBD2>	02.11→	6	DBJ	0 445 120 217	0 986 435 526	F 00R J02 175
19.390 WW	10,5	287	D 2066 LF02 <Euro 3>	01.10-12.13	6	DBJ	0 445 120 218	0 986 435 517	F 00R J02 175
19.400 WW	10,5	294	D 2066 LF06 <Euro 2>	01.10→	6	DBJ	0 445 120 218	0 986 435 517	F 00R J02 175
			D 2066 LF41 <Euro 5/OBD2>;	06.16→	6	DBJ	0 445 120 217	0 986 435 526	F 00R J02 175
			D 2066 LF58 <Euro 5/EEV/OBD2>						
			D 2066 LF49 <Euro 3>	02.11→	6	DBJ	0 445 120 217	0 986 435 526	F 00R J02 175
			D 2066 LF63 <Euro 4/OBD2>	02.11→	6	DBJ	0 445 120 217	0 986 435 526	F 00R J02 175
19.430 WW	10,5	316	D 2066 LF01 <Euro 3>	01.10-12.13	6	DBJ	0 445 120 218	0 986 435 517	F 00R J02 175
19.440 WW	10,5	324	D 2066 LF40 <Euro 5/OBD2>;	06.16→	6	DBJ	0 445 120 217	0 986 435 526	F 00R J02 175
			D 2066 LF57 <Euro 5/EEV/OBD2>						
			D 2066 LF50 <Euro 3>	02.11→	6	DBJ	0 445 120 217	0 986 435 526	F 00R J02 175
			D 2066 LF62 <Euro 4/OBD2>	02.11→	6	DBJ	0 445 120 217	0 986 435 526	F 00R J02 175
	12,4	324	D 2676 LF04 <Euro 2>	01.10→	6	DBJ	0 445 120 219	0 986 435 528	F 00R J02 175
19.480 WW	12,4	353	D 2676 LF02 <Euro 3>	01.10→	6	DBJ	0 445 120 219	0 986 435 528	F 00R J02 175
			D 2676 LF03 <Euro 2>	01.10→	6	DBJ	0 445 120 219	0 986 435 528	F 00R J02 175
			D 2676 LF07 <Euro 5/OBD2>;	02.11→	6	DBJ	0 445 120 219	0 986 435 528	F 00R J02 175
			D 2676 LF18 <Euro 5/EEV/OBD2>;						
			D 2676 LF20 <Euro 4/OBD2>						
20.320	10,5	235	D 2066 LF60 <Euro 5/EEV/OBD2>	07.17→	6	DBJ	0 445 120 217	0 986 435 526	F 00R J02 175
, WW	10,5	235	D 2066 LF43 <Euro 5/OBD2>	07.17→	6	DBJ	0 445 120 217	0 986 435 526	F 00R J02 175
20.360 , WW	10,5	265	D 2066 LF42 <Euro 5/OBD2>	07.17→	6	DBJ	0 445 120 217	0 986 435 526	F 00R J02 175
			D 2066 LF59 <Euro 5/EEV/OBD2>	07.17→	6	DBJ	0 445 120 217	0 986 435 526	F 00R J02 175
20.400 , WW	10,5	294	D 2066 LF41 <Euro 5/OBD2>	07.17→	6	DBJ	0 445 120 217	0 986 435 526	F 00R J02 175
			D 2066 LF58 <Euro 5/EEV/OBD2>	07.17→	6	DBJ	0 445 120 217	0 986 435 526	F 00R J02 175
20.440 , WW	10,5	324	D 2066 LF40 <Euro 5/OBD2>	07.17→	6	DBJ	0 445 120 217	0 986 435 526	F 00R J02 175
			D 2066 LF57 <Euro 5/EEV/OBD2>	07.17→	6	DBJ	0 445 120 217	0 986 435 526	F 00R J02 175
21.320 WW	10,5	235	D 2066 LF43 <Euro 5/OBD2>	06.16→	6	DBJ	0 445 120 217	0 986 435 526	F 00R J02 175
21.360 WW	10,5	265	D 2066 LF07 <Euro 2>	05.12→	6	DBJ	0 445 120 218	0 986 435 517	F 00R J02 175
			D 2066 LF42 <Euro 5/OBD2>;	06.16→	6	DBJ	0 445 120 217	0 986 435 526	F 00R J02 175
			D 2066 LF59 <Euro 5/EEV/OBD2>						
			D 2066 LF64 <Euro 4/OBD2>	05.12→	6	DBJ	0 445 120 217	0 986 435 526	F 00R J02 175
21.400 WW	10,5	294	D 2066 LF06 <Euro 2>	05.12→	6	DBJ	0 445 120 218	0 986 435 517	F 00R J02 175
			D 2066 LF41 <Euro 5/OBD2>;	06.16→	6	DBJ	0 445 120 217	0 986 435 526	F 00R J02 175
			D 2066 LF58 <Euro 5/EEV/OBD2>						
			D 2066 LF49 <Euro 3>	05.12→	6	DBJ	0 445 120 217	0 986 435 526	F 00R J02 175
			D 2066 LF63 <Euro 4/OBD2>	05.12→	6	DBJ	0 445 120 217	0 986 435 526	F 00R J02 175
21.440 WW	10,5	324	D 2066 LF40 <Euro 5/OBD2>;	06.16→	6	DBJ	0 445 120 217	0 986 435 526	F 00R J02 175
			D 2066 LF57 <Euro 5/EEV/OBD2>						
			D 2066 LF50 <Euro 3>	05.12→	6	DBJ	0 445 120 217	0 986 435 526	F 00R J02 175
			D 2066 LF62 <Euro 4/OBD2>	05.12→	6	DBJ	0 445 120 217	0 986 435 526	F 00R J02 175
	12,4	324	D 2676 LF04 <Euro 2>	05.12→	6	DBJ	0 445 120 219	0 986 435 528	F 00R J02 175
21.480 WW	12,4	353	D 2676 LF02 <Euro 3>	05.12→	6	DBJ	0 445 120 219	0 986 435 528	F 00R J02 175
			D 2676 LF03 <Euro 2>	05.12→	6	DBJ	0 445 120 219	0 986 435 528	F 00R J02 175
			D 2676 LF07 <Euro 5/OBD2>;	06.16→	6	DBJ	0 445 120 219	0 986 435 528	F 00R J02 175
			D 2676 LF18 <Euro 5/EEV/OBD2>						
			D 2676 LF20 <Euro 4/OBD2>	05.12→	6	DBJ	0 445 120 219	0 986 435 528	F 00R J02 175
23.320	10,5	235	D 2066 LF86 <Euro 6/OBDC>	07.17→	6	DBJ	0 445 120 353	0 986 435 593	F 00R J02 175
23.360	10,5	265	D 2066 LF85 <Euro 6/OBDC>	07.17→	6	DBJ	0 445 120 353	0 986 435 593	F 00R J02 175
23.420	12,4	309	D 2676 LF53 <Euro 6/OBDC>	07.17→	6	DBJ	0 445 120 420		F 00R J02 175
23.460	12,4	338	D 2676 LF52 <Euro 6/OBDC>	07.17→	6	DBJ	0 445 120 420		F 00R J02 175
23.500	12,4	368	D 2676 LF51 <Euro 6/OBDC>	07.17→	6	DBJ	0 445 120 420		F 00R J02 175
24.230	10,5	235	D 2066 LF81 <Euro 6>	06.15→	6	DBJ	0 445 120 353	0 986 435 593	F 00R J02 175
24.320	10,5	235	D 2066 LF20 <Euro 5/OBD1>;	10.07-12.13	6	DBJ	0 445 120 217	0 986 435 526	F 00R J02 175
			D 2066 LF28 <Euro 5/OBD1>;						
			D 2066 LF39 <Euro 4/OBD1>						
			D 2066 LF43 <Euro 5/OBD2>	09.09→	6	DBJ	0 445 120 217	0 986 435 526	F 00R J02 175
			D 2066 LF53 <Euro 5/OBD2>	10.09-06.16	6	DBJ	0 445 120 201	0 986 435 656	F 00R J02 175
			D 2066 LF60 <Euro 5/EEV/OBD2>	09.09→	6	DBJ	0 445 120 217	0 986 435 526	F 00R J02 175



◀ MAN

24.320	10,5	235	D 2066 LF68 <Euro 6>	10.12-06.16	6	DBJ	0 445 120 353	0 986 435 593	F 00R J02 175			
			D 2066 LF86 <Euro 6/OBDC>	09.16→	6	DBJ	0 445 120 353	0 986 435 593	F 00R J02 175			
24.360	10,5	265	D 2066 LF19 <Euro 5/OBD1>; D 2066 LF27 <Euro 5/OBD1>; D 2066 LF38 <Euro 4/OBD1>	10.07-12.13	6	DBJ	0 445 120 217	0 986 435 526	F 00R J02 175			
			D 2066 LF42 <Euro 5/OBD2>	09.09→	6	DBJ	0 445 120 217	0 986 435 526	F 00R J02 175			
			D 2066 LF52 <Euro 5/OBD2>	10.09-06.16	6	DBJ	0 445 120 201	0 986 435 656	F 00R J02 175			
			D 2066 LF59 <Euro 5/EEV/OBD2>	09.09→	6	DBJ	0 445 120 217	0 986 435 526	F 00R J02 175			
			D 2066 LF67 <Euro 6>; D 2066 LF80 <Euro 6>; D 2066 LF85 <Euro 6/OBDC>	10.12→	6	DBJ	0 445 120 353	0 986 435 593	F 00R J02 175			
			24.400	10,5	294	D 2066 LF18 <Euro 5/OBD1>; D 2066 LF26 <Euro 5/OBD1>; D 2066 LF37 <Euro 4/OBD1>	10.07-12.13	6	DBJ	0 445 120 217	0 986 435 526	F 00R J02 175
						D 2066 LF41 <Euro 5/OBD2>	09.09→	6	DBJ	0 445 120 217	0 986 435 526	F 00R J02 175
						D 2066 LF51 <Euro 5/OBD2>	10.09-06.16	6	DBJ	0 445 120 201	0 986 435 656	F 00R J02 175
D 2066 LF58 <Euro 5/EEV/OBD2>	09.09→	6				DBJ	0 445 120 217	0 986 435 526	F 00R J02 175			
24.420	12,4	294	D 2066 LF61 <Euro 6>	10.12-06.16	6	DBJ	0 445 120 353	0 986 435 593	F 00R J02 175			
			D 2676 LF47 <Euro 6>	03.15→	6	DBJ	0 445 120 354	0 986 435 650	F 00R J02 175			
24.440	12,4	309	D 2676 LF53 <Euro 6/OBDC>	06.16→	6	DBJ	0 445 120 420		F 00R J02 175			
24.440	10,5	324	D 2066 LF17 <Euro 5/OBD1>; D 2066 LF25 <Euro 5/OBD1>; D 2066 LF36 <Euro 4/OBD1>	10.07-12.13	6	DBJ	0 445 120 217	0 986 435 526	F 00R J02 175			
			D 2066 LF40 <Euro 5/OBD2>	09.09→	6	DBJ	0 445 120 217	0 986 435 526	F 00R J02 175			
			D 2066 LF57 <Euro 5/EEV/OBD2>	09.09→	6	DBJ	0 445 120 217	0 986 435 526	F 00R J02 175			
			12,4	324	D 2676 LF22 <Euro 5/OBD2>	10.09-06.16	6	DBJ	0 445 120 202	0 986 435 570	F 00R J02 175	
					D 2676 LF26 <Euro 6>; D 2676 LF46 <Euro 6>	10.12→	6	DBJ	0 445 120 354	0 986 435 650	F 00R J02 175	
			24.460	12,4	338	D 2676 LF52 <Euro 6/OBDC>	06.16→	6	DBJ	0 445 120 420		F 00R J02 175
24.480	12,4	353	D 2676 LF07 <Euro 5/OBD2>	09.09→	6	DBJ	0 445 120 219	0 986 435 528	F 00R J02 175			
			D 2676 LF18 <Euro 5/EEV/OBD2>	09.09→	6	DBJ	0 445 120 219	0 986 435 528	F 00R J02 175			
			D 2676 LF25 <Euro 6>; D 2676 LF45 <Euro 6>	10.12→	6	DBJ	0 445 120 354	0 986 435 650	F 00R J02 175			
			, DF	12,4	353	D 2676 LF05 <Euro 4/OBD1>; D 2676 LF14 <Euro 5/OBD1>; D 2676 LF16 <Euro 5/OBD1>	10.07-12.13	6	DBJ	0 445 120 219	0 986 435 528	F 00R J02 175
24.500	12,4	368	D 2676 LF51 <Euro 6/OBDC>	06.16→	6	DBJ	0 445 120 420		F 00R J02 175			
24.540	12,4	397	D 2676 LF06 <Euro 5/OBD2>	09.09→	6	DBJ	0 445 120 219	0 986 435 528	F 00R J02 175			
26.320	10,5	235	D 2066 LF20 <Euro 5/OBD1>; D 2066 LF28 <Euro 5/OBD1>; D 2066 LF39 <Euro 4/OBD1>	10.07-06.16	6	DBJ	0 445 120 217	0 986 435 526	F 00R J02 175			
			D 2066 LF43 <Euro 5/OBD2>	09.09→	6	DBJ	0 445 120 217	0 986 435 526	F 00R J02 175			
			D 2066 LF53 <Euro 5/OBD2>	10.09-06.16	6	DBJ	0 445 120 201	0 986 435 656	F 00R J02 175			
			D 2066 LF60 <Euro 5/EEV/OBD2>	09.09→	6	DBJ	0 445 120 217	0 986 435 526	F 00R J02 175			
			D 2066 LF68 <Euro 6>; D 2066 LF81 <Euro 6>; D 2066 LF86 <Euro 6/OBDC>	10.12→	6	DBJ	0 445 120 353	0 986 435 593	F 00R J02 175			
			26.350 WW	10,5	257	D 2066 LF03 <Euro 3>	01.10-12.13	6	DBJ	0 445 120 218	0 986 435 517	F 00R J02 175
			26.360	10,5	265	D 2066 LF19 <Euro 5/OBD1>; D 2066 LF27 <Euro 5/OBD1>; D 2066 LF38 <Euro 4/OBD1>	10.07-06.16	6	DBJ	0 445 120 217	0 986 435 526	F 00R J02 175
						D 2066 LF52 <Euro 5/OBD2>	10.09-06.16	6	DBJ	0 445 120 201	0 986 435 656	F 00R J02 175
D 2066 LF59 <Euro 5/EEV/OBD2>	09.09→	6				DBJ	0 445 120 217	0 986 435 526	F 00R J02 175			
D 2066 LF67 <Euro 6>; D 2066 LF80 <Euro 6>	10.12→	6				DBJ	0 445 120 353	0 986 435 593	F 00R J02 175			
D 2066 LF85 <Euro 6/OBDC>	09.16→	6				DBJ	0 445 120 353	0 986 435 593	F 00R J02 175			
, WW	10,5	265				D 2066 LF42 <Euro 5/OBD2>	09.09→	6	DBJ	0 445 120 217	0 986 435 526	F 00R J02 175
WW	10,5	265				D 2066 LF48 <Euro 3>	02.11→	6	DBJ	0 445 120 217	0 986 435 526	F 00R J02 175
26.390 WW	10,5	287	D 2066 LF64 <Euro 4/OBD2>	02.11→	6	DBJ	0 445 120 217	0 986 435 526	F 00R J02 175			
			D 2066 LF02 <Euro 3>	01.10-12.13	6	DBJ	0 445 120 218	0 986 435 517	F 00R J02 175			
26.400	10,5	294	D 2066 LF18 <Euro 5/OBD1>; D 2066 LF26 <Euro 5/OBD1>; D 2066 LF37 <Euro 4/OBD1>	10.07-06.16	6	DBJ	0 445 120 217	0 986 435 526	F 00R J02 175			





26.400	10,5	294	D 2066 LF51 <Euro 5/OBD2>	10.09-06.16	6	DBJ	0 445 120 201	0 986 435 656	F 00R J02 175	
			D 2066 LF58 <Euro 5/EEV/OBD2>	09.09→	6	DBJ	0 445 120 217	0 986 435 526	F 00R J02 175	
			D 2066 LF61 <Euro 6>	10.12-06.16	6	DBJ	0 445 120 353	0 986 435 593	F 00R J02 175	
	12,4	294	D 2676 LF47 <Euro 6>	03.15→	6	DBJ	0 445 120 354	0 986 435 650	F 00R J02 175	
, WW	10,5	294	D 2066 LF41 <Euro 5/OBD2>	09.09→	6	DBJ	0 445 120 217	0 986 435 526	F 00R J02 175	
WW	10,5	294	D 2066 LF49 <Euro 3>	02.11→	6	DBJ	0 445 120 217	0 986 435 526	F 00R J02 175	
			D 2066 LF63 <Euro 4/OBD2>	02.11→	6	DBJ	0 445 120 217	0 986 435 526	F 00R J02 175	
26.420	12,4	309	D 2676 LF53 <Euro 6/OBDC>	06.16→	6	DBJ	0 445 120 420		F 00R J02 175	
26.430 WW	10,5	316	D 2066 LF01 <Euro 3>	01.10-12.13	6	DBJ	0 445 120 218	0 986 435 517	F 00R J02 175	
26.440	10,5	324	D 2066 LF17 <Euro 5/OBD1>;	10.07-06.16	6	DBJ	0 445 120 217	0 986 435 526	F 00R J02 175	
			D 2066 LF25 <Euro 5/OBD1>;							
			D 2066 LF36 <Euro 4/OBD1>							
			D 2066 LF44 <Euro 5/OBD2>	09.12→	6	DBJ	0 445 120 217	0 986 435 526	F 00R J02 175	
			D 2066 LF57 <Euro 5/EEV/OBD2>	09.09→	6	DBJ	0 445 120 217	0 986 435 526	F 00R J02 175	
	12,4	324	D 2676 LF22 <Euro 5/OBD2>	10.09-06.16	6	DBJ	0 445 120 202	0 986 435 570	F 00R J02 175	
			D 2676 LF26 <Euro 6>;	10.12→	6	DBJ	0 445 120 354	0 986 435 650	F 00R J02 175	
			D 2676 LF46 <Euro 6>							
, WW	10,5	324	D 2066 LF40 <Euro 5/OBD2>	09.09→	6	DBJ	0 445 120 217	0 986 435 526	F 00R J02 175	
WW	10,5	324	D 2066 LF50 <Euro 3>	02.11→	6	DBJ	0 445 120 217	0 986 435 526	F 00R J02 175	
			D 2066 LF62 <Euro 4/OBD2>	02.11→	6	DBJ	0 445 120 217	0 986 435 526	F 00R J02 175	
26.460	12,4	338	D 2676 LF52 <Euro 6/OBDC>	06.16→	6	DBJ	0 445 120 420		F 00R J02 175	
26.480	12,4	353	D 2676 LF05 <Euro 4/OBD1>;	10.07-06.16	6	DBJ	0 445 120 219	0 986 435 528	F 00R J02 175	
			D 2676 LF14 <Euro 5/OBD1>;							
			D 2676 LF16 <Euro 5/OBD1>							
			D 2676 LF18 <Euro 5/EEV/OBD2>	09.09→	6	DBJ	0 445 120 219	0 986 435 528	F 00R J02 175	
			D 2676 LF25 <Euro 6>;	10.12→	6	DBJ	0 445 120 354	0 986 435 650	F 00R J02 175	
			D 2676 LF45 <Euro 6>							
, WW	12,4	353	D 2676 LF07 <Euro 5/OBD2>	09.09→	6	DBJ	0 445 120 219	0 986 435 528	F 00R J02 175	
WW	12,4	353	D 2676 LF02 <Euro 3>;	01.10→	6	DBJ	0 445 120 219	0 986 435 528	F 00R J02 175	
			D 2676 LF20 <Euro 4/OBD2>							
26.500	12,4	368	D 2676 LF51 <Euro 6/OBDC>	06.16→	6	DBJ	0 445 120 420		F 00R J02 175	
26.540	12,4	397	D 2676 LF06 <Euro 5/OBD2>;	10.07→	6	DBJ	0 445 120 219	0 986 435 528	F 00R J02 175	
			D 2676 LF13 <Euro 5/OBD1>;							
			D 2676 LF15 <Euro 5/OBD1>							
28.320	10,5	235	D 2066 LF43 <Euro 5/OBD2>	09.09→	6	DBJ	0 445 120 217	0 986 435 526	F 00R J02 175	
			D 2066 LF60 <Euro 5/EEV/OBD2>	09.09→	6	DBJ	0 445 120 217	0 986 435 526	F 00R J02 175	
			D 2066 LF68 <Euro 6>;	10.12→	6	DBJ	0 445 120 353	0 986 435 593	F 00R J02 175	
			D 2066 LF81 <Euro 6>							
	235/236		D 2066 LF20 <Euro 5/OBD1>;	09.07-06.16	6	DBJ	0 445 120 217	0 986 435 526	F 00R J02 175	
			D 2066 LF28 <Euro 5/OBD1>;							
			D 2066 LF39 <Euro 4/OBD1>							
28.350 WW	10,5	257	D 2066 LF03 <Euro 3>	04.10-12.13	6	DBJ	0 445 120 218	0 986 435 517	F 00R J02 175	
28.360	10,5	265	D 2066 LF19 <Euro 5/OBD1>;	09.07-06.16	6	DBJ	0 445 120 217	0 986 435 526	F 00R J02 175	
			D 2066 LF27 <Euro 5/OBD1>;							
			D 2066 LF38 <Euro 4/OBD1>							
			D 2066 LF59 <Euro 5/EEV/OBD2>	09.09→	6	DBJ	0 445 120 217	0 986 435 526	F 00R J02 175	
			D 2066 LF67 <Euro 6>;	10.12→	6	DBJ	0 445 120 353	0 986 435 593	F 00R J02 175	
			D 2066 LF80 <Euro 6>							
			D 2066 LF85 <Euro 6/OBDC>	09.16→	6	DBJ	0 445 120 353	0 986 435 593	F 00R J02 175	
, WW	10,5	265	D 2066 LF42 <Euro 5/OBD2>	09.09→	6	DBJ	0 445 120 217	0 986 435 526	F 00R J02 175	
WW	10,5	265	D 2066 LF48 <Euro 3>	02.11→	6	DBJ	0 445 120 217	0 986 435 526	F 00R J02 175	
			D 2066 LF64 <Euro 4/OBD2>	02.11→	6	DBJ	0 445 120 217	0 986 435 526	F 00R J02 175	
28.390 WW	10,5	287	D 2066 LF02 <Euro 3>	04.10-12.13	6	DBJ	0 445 120 218	0 986 435 517	F 00R J02 175	
28.400	10,5	294	D 2066 LF18 <Euro 5/OBD1>;	09.07-06.16	6	DBJ	0 445 120 217	0 986 435 526	F 00R J02 175	
			D 2066 LF26 <Euro 5/OBD1>;							
			D 2066 LF37 <Euro 4/OBD1>							
			D 2066 LF58 <Euro 5/EEV/OBD2>	09.09→	6	DBJ	0 445 120 217	0 986 435 526	F 00R J02 175	
			D 2066 LF61 <Euro 6>	10.12-06.16	6	DBJ	0 445 120 353	0 986 435 593	F 00R J02 175	
	12,4	294	D 2676 LF47 <Euro 6>	03.15→	6	DBJ	0 445 120 354	0 986 435 650	F 00R J02 175	
, WW	10,5	294	D 2066 LF41 <Euro 5/OBD2>	09.09→	6	DBJ	0 445 120 217	0 986 435 526	F 00R J02 175	
WW	10,5	294	D 2066 LF49 <Euro 3>	02.11→	6	DBJ	0 445 120 217	0 986 435 526	F 00R J02 175	
			D 2066 LF63 <Euro 4/OBD2>	02.11→	6	DBJ	0 445 120 217	0 986 435 526	F 00R J02 175	
28.420	12,4	309	D 2676 LF53 <Euro 6/OBDC>	06.16→	6	DBJ	0 445 120 420		F 00R J02 175	







◀ MAN

<b>28.430 WW</b>	10,5	316	D 2066 LF01 <Euro 3>	04.10-12.13	6	DBJ	<b>0 445 120 218</b>	<b>0 986 435 517</b>	<b>F 00R J02 175</b>
<b>28.440</b>	10,5	324	D 2066 LF17 <Euro 5/OBD1>; D 2066 LF25 <Euro 5/OBD1>; D 2066 LF36 <Euro 4/OBD1>	09.07-06.16	6	DBJ	<b>0 445 120 217</b>	<b>0 986 435 526</b>	<b>F 00R J02 175</b>
	12,4	324	D 2066 LF57 <Euro 5/EEV/OBD2> D 2676 LF26 <Euro 6>; D 2676 LF46 <Euro 6>	09.09→ 10.12→	6	DBJ	<b>0 445 120 217</b>	<b>0 986 435 526</b>	<b>F 00R J02 175</b>
. WW	10,5	324	D 2066 LF40 <Euro 5/OBD2>	09.09→	6	DBJ	<b>0 445 120 217</b>	<b>0 986 435 526</b>	<b>F 00R J02 175</b>
WW	10,5	324	D 2066 LF50 <Euro 3> D 2066 LF62 <Euro 4/OBD2>	02.11→ 02.11→	6	DBJ	<b>0 445 120 217</b>	<b>0 986 435 526</b>	<b>F 00R J02 175</b>
<b>28.460</b>	12,4	338	D 2676 LF52 <Euro 6/OBDC>	06.16→	6	DBJ	<b>0 445 120 420</b>		<b>F 00R J02 175</b>
<b>28.480</b>	12,4	353	D 2676 LF05 <Euro 4/OBD1>; D 2676 LF14 <Euro 5/OBD1>; D 2676 LF16 <Euro 5/OBD1>	09.07-06.16	6	DBJ	<b>0 445 120 219</b>	<b>0 986 435 528</b>	<b>F 00R J02 175</b>
			D 2676 LF18 <Euro 5/EEV/OBD2> D 2676 LF25 <Euro 6>; D 2676 LF45 <Euro 6>	09.09→ 10.12→	6	DBJ	<b>0 445 120 219</b>	<b>0 986 435 528</b>	<b>F 00R J02 175</b>
. WW	12,4	353	D 2676 LF07 <Euro 5/OBD2>	09.09→	6	DBJ	<b>0 445 120 219</b>	<b>0 986 435 528</b>	<b>F 00R J02 175</b>
WW	12,4	353	D 2676 LF02 <Euro 3>; D 2676 LF20 <Euro 4/OBD2>	04.10→	6	DBJ	<b>0 445 120 219</b>	<b>0 986 435 528</b>	<b>F 00R J02 175</b>
<b>28.500</b>	12,4	368	D 2676 LF51 <Euro 6/OBDC>	06.16→	6	DBJ	<b>0 445 120 420</b>		<b>F 00R J02 175</b>
<b>28.540</b>	12,4	397	D 2676 LF06 <Euro 5/OBD2>; D 2676 LF13 <Euro 5/OBD1>; D 2676 LF15 <Euro 5/OBD1>	09.07→	6	DBJ	<b>0 445 120 219</b>	<b>0 986 435 528</b>	<b>F 00R J02 175</b>
<b>31.360 WW</b>	10,5	265	D 2066 LF48 <Euro 3>	05.12→	6	DBJ	<b>0 445 120 217</b>	<b>0 986 435 526</b>	<b>F 00R J02 175</b>
<b>32.320</b>	10,5	235	D 2066 LF20 <Euro 5/OBD1>; D 2066 LF28 <Euro 5/OBD1>; D 2066 LF39 <Euro 4/OBD1>	10.07-06.16	6	DBJ	<b>0 445 120 217</b>	<b>0 986 435 526</b>	<b>F 00R J02 175</b>
			D 2066 LF43 <Euro 5/OBD2> D 2066 LF53 <Euro 5/OBD2>	09.09→ 10.09→	6	DBJ	<b>0 445 120 217</b>	<b>0 986 435 526</b>	<b>F 00R J02 175</b>
			D 2066 LF60 <Euro 5/EEV/OBD2> D 2066 LF68 <Euro 6>; D 2066 LF81 <Euro 6>; D 2066 LF86 <Euro 6/OBDC>	09.09→ 06.13→	6	DBJ	<b>0 445 120 217</b>	<b>0 986 435 526</b>	<b>F 00R J02 175</b>
<b>32.360</b>	10,5	265	D 2066 LF19 <Euro 5/OBD1>; D 2066 LF27 <Euro 5/OBD1>; D 2066 LF38 <Euro 4/OBD1>	10.07-06.16	6	DBJ	<b>0 445 120 217</b>	<b>0 986 435 526</b>	<b>F 00R J02 175</b>
			D 2066 LF42 <Euro 5/OBD2> D 2066 LF52 <Euro 5/OBD2>	09.09→ 10.09→	6	DBJ	<b>0 445 120 217</b>	<b>0 986 435 526</b>	<b>F 00R J02 175</b>
			D 2066 LF59 <Euro 5/EEV/OBD2> D 2066 LF67 <Euro 6>; D 2066 LF80 <Euro 6>	09.09→ 06.13→	6	DBJ	<b>0 445 120 217</b>	<b>0 986 435 526</b>	<b>F 00R J02 175</b>
			D 2066 LF85 <Euro 6/OBDC>	09.16→	6	DBJ	<b>0 445 120 353</b>	<b>0 986 435 593</b>	<b>F 00R J02 175</b>
WW	10,5	265	D 2066 LF48 <Euro 3>	02.16→	6	DBJ	<b>0 445 120 217</b>	<b>0 986 435 526</b>	<b>F 00R J02 175</b>
<b>32.400</b>	10,5	294	D 2066 LF18 <Euro 5/OBD1>; D 2066 LF26 <Euro 5/OBD1>; D 2066 LF37 <Euro 4/OBD1>	10.07-06.16	6	DBJ	<b>0 445 120 217</b>	<b>0 986 435 526</b>	<b>F 00R J02 175</b>
			D 2066 LF41 <Euro 5/OBD2> D 2066 LF51 <Euro 5/OBD2>	09.09→ 10.09→	6	DBJ	<b>0 445 120 217</b>	<b>0 986 435 526</b>	<b>F 00R J02 175</b>
			D 2066 LF58 <Euro 5/EEV/OBD2> D 2066 LF61 <Euro 6>	09.09→ 06.13-06.16	6	DBJ	<b>0 445 120 217</b>	<b>0 986 435 526</b>	<b>F 00R J02 175</b>
	12,4	294	D 2676 LF47 <Euro 6>	03.15→	6	DBJ	<b>0 445 120 354</b>	<b>0 986 435 650</b>	<b>F 00R J02 175</b>
WW	10,5	294	D 2066 LF49 <Euro 3>	02.16→	6	DBJ	<b>0 445 120 217</b>	<b>0 986 435 526</b>	<b>F 00R J02 175</b>
<b>32.420</b>	12,4	309	D 2676 LF53 <Euro 6/OBDC>	06.16→	6	DBJ	<b>0 445 120 420</b>		<b>F 00R J02 175</b>
<b>32.440</b>	10,5	324	D 2066 LF17 <Euro 5/OBD1>; D 2066 LF25 <Euro 5/OBD1>; D 2066 LF36 <Euro 4/OBD1>	10.07-06.16	6	DBJ	<b>0 445 120 217</b>	<b>0 986 435 526</b>	<b>F 00R J02 175</b>
			D 2066 LF40 <Euro 5/OBD2> D 2066 LF57 <Euro 5/EEV/OBD2>	09.09→ 09.09→	6	DBJ	<b>0 445 120 217</b>	<b>0 986 435 526</b>	<b>F 00R J02 175</b>
	12,4	324	D 2676 LF22 <Euro 5/OBD2> D 2676 LF26 <Euro 6>; D 2676 LF46 <Euro 6>	10.09→ 06.13→	6	DBJ	<b>0 445 120 202</b>	<b>0 986 435 570</b>	<b>F 00R J02 175</b>
<b>32.460</b>	12,4	338	D 2676 LF52 <Euro 6/OBDC>	06.16→	6	DBJ	<b>0 445 120 420</b>		<b>F 00R J02 175</b>





<b>32.480</b>	12,4	353	D 2676 LF05 <Euro 4/OBD1>; D 2676 LF14 <Euro 5/OBD1>; D 2676 LF16 <Euro 5/OBD1>	10.07-12.13	6	DBJ	<b>0 445 120 219</b>	<b>0 986 435 528</b>	<b>F 00R J02 175</b>
			D 2676 LF07 <Euro 5/OBD2>	09.09→	6	DBJ	<b>0 445 120 219</b>	<b>0 986 435 528</b>	<b>F 00R J02 175</b>
			D 2676 LF18 <Euro 5/EEV/OBD2>	09.09→	6	DBJ	<b>0 445 120 219</b>	<b>0 986 435 528</b>	<b>F 00R J02 175</b>
			D 2676 LF25 <Euro 6>; D 2676 LF45 <Euro 6>	06.13→	6	DBJ	<b>0 445 120 354</b>	<b>0 986 435 650</b>	<b>F 00R J02 175</b>
<b>32.500</b>	12,4	368	D 2676 LF51 <Euro 6/OBDC>	06.16→	6	DBJ	<b>0 445 120 420</b>		<b>F 00R J02 175</b>
<b>33.320</b>	10,5	235	D 2066 LF20 <Euro 5/OBD1>; D 2066 LF28 <Euro 5/OBD1>; D 2066 LF39 <Euro 4/OBD1>	10.07-06.16	6	DBJ	<b>0 445 120 217</b>	<b>0 986 435 526</b>	<b>F 00R J02 175</b>
			D 2066 LF43 <Euro 5/OBD2>	09.09→	6	DBJ	<b>0 445 120 217</b>	<b>0 986 435 526</b>	<b>F 00R J02 175</b>
			D 2066 LF60 <Euro 5/EEV/OBD2>	09.09→	6	DBJ	<b>0 445 120 217</b>	<b>0 986 435 526</b>	<b>F 00R J02 175</b>
			D 2066 LF68 <Euro 6>; D 2066 LF81 <Euro 6>; D 2066 LF86 <Euro 6/OBDC>	06.13→	6	DBJ	<b>0 445 120 353</b>	<b>0 986 435 593</b>	<b>F 00R J02 175</b>
<b>33.350 WW</b>	10,5	257	D 2066 LF03 <Euro 3>	01.10-09.16	6	DBJ	<b>0 445 120 218</b>	<b>0 986 435 517</b>	<b>F 00R J02 175</b>
<b>33.360</b>	10,5	265	D 2066 LF19 <Euro 5/OBD1>; D 2066 LF27 <Euro 5/OBD1>; D 2066 LF38 <Euro 4/OBD1>	10.07-06.16	6	DBJ	<b>0 445 120 217</b>	<b>0 986 435 526</b>	<b>F 00R J02 175</b>
			D 2066 LF59 <Euro 5/EEV/OBD2>	09.09→	6	DBJ	<b>0 445 120 217</b>	<b>0 986 435 526</b>	<b>F 00R J02 175</b>
			D 2066 LF67 <Euro 6>; D 2066 LF80 <Euro 6>	06.13→	6	DBJ	<b>0 445 120 353</b>	<b>0 986 435 593</b>	<b>F 00R J02 175</b>
			D 2066 LF85 <Euro 6/OBDC>	09.16→	6	DBJ	<b>0 445 120 353</b>	<b>0 986 435 593</b>	<b>F 00R J02 175</b>
, WW	10,5	265	D 2066 LF42 <Euro 5/OBD2>	09.09→	6	DBJ	<b>0 445 120 217</b>	<b>0 986 435 526</b>	<b>F 00R J02 175</b>
WW	10,5	265	D 2066 LF07 <Euro 2>	03.10→	6	DBJ	<b>0 445 120 218</b>	<b>0 986 435 517</b>	<b>F 00R J02 175</b>
			D 2066 LF48 <Euro 3>	02.11→	6	DBJ	<b>0 445 120 217</b>	<b>0 986 435 526</b>	<b>F 00R J02 175</b>
			D 2066 LF64 <Euro 4/OBD2>	02.11→	6	DBJ	<b>0 445 120 217</b>	<b>0 986 435 526</b>	<b>F 00R J02 175</b>
<b>33.390 WW</b>	10,5	287	D 2066 LF02 <Euro 3>	01.10-09.16	6	DBJ	<b>0 445 120 218</b>	<b>0 986 435 517</b>	<b>F 00R J02 175</b>
<b>33.400</b>	10,5	294	D 2066 LF18 <Euro 5/OBD1>; D 2066 LF26 <Euro 5/OBD1>; D 2066 LF37 <Euro 4/OBD1>	10.07-06.16	6	DBJ	<b>0 445 120 217</b>	<b>0 986 435 526</b>	<b>F 00R J02 175</b>
			D 2066 LF58 <Euro 5/EEV/OBD2>	09.09→	6	DBJ	<b>0 445 120 217</b>	<b>0 986 435 526</b>	<b>F 00R J02 175</b>
			D 2066 LF61 <Euro 6>	06.13-06.16	6	DBJ	<b>0 445 120 353</b>	<b>0 986 435 593</b>	<b>F 00R J02 175</b>
	12,4	294	D 2676 LF47 <Euro 6>	03.15→	6	DBJ	<b>0 445 120 354</b>	<b>0 986 435 650</b>	<b>F 00R J02 175</b>
, WW	10,5	294	D 2066 LF41 <Euro 5/OBD2>	09.09→	6	DBJ	<b>0 445 120 217</b>	<b>0 986 435 526</b>	<b>F 00R J02 175</b>
WW	10,5	294	D 2066 LF06 <Euro 2>	03.10→	6	DBJ	<b>0 445 120 218</b>	<b>0 986 435 517</b>	<b>F 00R J02 175</b>
			D 2066 LF49 <Euro 3>	02.11→	6	DBJ	<b>0 445 120 217</b>	<b>0 986 435 526</b>	<b>F 00R J02 175</b>
			D 2066 LF63 <Euro 4/OBD2>	02.11→	6	DBJ	<b>0 445 120 217</b>	<b>0 986 435 526</b>	<b>F 00R J02 175</b>
<b>33.420</b>	12,4	309	D 2676 LF53 <Euro 6/OBDC>	06.16→	6	DBJ	<b>0 445 120 420</b>		<b>F 00R J02 175</b>
<b>33.430 WW</b>	10,5	316	D 2066 LF01 <Euro 3>	01.10-09.16	6	DBJ	<b>0 445 120 218</b>	<b>0 986 435 517</b>	<b>F 00R J02 175</b>
<b>33.440</b>	10,5	324	D 2066 LF17 <Euro 5/OBD1>; D 2066 LF25 <Euro 5/OBD1>; D 2066 LF36 <Euro 4/OBD1>	10.07-06.16	6	DBJ	<b>0 445 120 217</b>	<b>0 986 435 526</b>	<b>F 00R J02 175</b>
			D 2066 LF57 <Euro 5/EEV/OBD2>	09.09→	6	DBJ	<b>0 445 120 217</b>	<b>0 986 435 526</b>	<b>F 00R J02 175</b>
	12,4	324	D 2676 LF26 <Euro 6>; D 2676 LF46 <Euro 6>	06.13→	6	DBJ	<b>0 445 120 354</b>	<b>0 986 435 650</b>	<b>F 00R J02 175</b>
, WW	10,5	324	D 2066 LF40 <Euro 5/OBD2>	09.09→	6	DBJ	<b>0 445 120 217</b>	<b>0 986 435 526</b>	<b>F 00R J02 175</b>
WW	10,5	324	D 2066 LF50 <Euro 3>	02.11→	6	DBJ	<b>0 445 120 217</b>	<b>0 986 435 526</b>	<b>F 00R J02 175</b>
			D 2066 LF62 <Euro 4/OBD2>	02.11→	6	DBJ	<b>0 445 120 217</b>	<b>0 986 435 526</b>	<b>F 00R J02 175</b>
	12,4	324	D 2676 LF04 <Euro 2>	03.10→	6	DBJ	<b>0 445 120 219</b>	<b>0 986 435 528</b>	<b>F 00R J02 175</b>
<b>33.460</b>	12,4	338	D 2676 LF52 <Euro 6/OBDC>	06.16→	6	DBJ	<b>0 445 120 420</b>		<b>F 00R J02 175</b>
<b>33.480</b>	12,4	353	D 2676 LF18 <Euro 5/EEV/OBD2>	09.09→	6	DBJ	<b>0 445 120 219</b>	<b>0 986 435 528</b>	<b>F 00R J02 175</b>
			D 2676 LF25 <Euro 6>; D 2676 LF45 <Euro 6>	06.13→	6	DBJ	<b>0 445 120 354</b>	<b>0 986 435 650</b>	<b>F 00R J02 175</b>
, DF	12,4	353	D 2676 LF05 <Euro 4/OBD1>; D 2676 LF14 <Euro 5/OBD1>; D 2676 LF16 <Euro 5/OBD1>	10.07-06.16	6	DBJ	<b>0 445 120 219</b>	<b>0 986 435 528</b>	<b>F 00R J02 175</b>
, WW	12,4	353	D 2676 LF07 <Euro 5/OBD2>	09.09→	6	DBJ	<b>0 445 120 219</b>	<b>0 986 435 528</b>	<b>F 00R J02 175</b>
WW	12,4	353	D 2676 LF02 <Euro 3>; D 2676 LF03 <Euro 2>; D 2676 LF20 <Euro 4/OBD2>	01.10→	6	DBJ	<b>0 445 120 219</b>	<b>0 986 435 528</b>	<b>F 00R J02 175</b>
<b>33.500</b>	12,4	368	D 2676 LF51 <Euro 6/OBDC>	06.16→	6	DBJ	<b>0 445 120 420</b>		<b>F 00R J02 175</b>



















◀ MAN

<b>33.540</b>	12,4	397	D 2676 LF06 <Euro 5/OBD2>; D 2676 LF13 <Euro 5/OBD1>; D 2676 LF15 <Euro 5/OBD1>	10.07→	6	DBJ	<b>0 445 120 219</b>	<b>0 986 435 528</b>	<b>F 00R J02 175</b>
<b>35.320</b>	10,5	235	D 2066 LF20 <Euro 5/OBD1>; D 2066 LF28 <Euro 5/OBD1>; D 2066 LF39 <Euro 4/OBD1>	10.07-06.16	6	DBJ	<b>0 445 120 217</b>	<b>0 986 435 526</b>	<b>F 00R J02 175</b>
			D 2066 LF43 <Euro 5/OBD2>	09.09→	6	DBJ	<b>0 445 120 217</b>	<b>0 986 435 526</b>	<b>F 00R J02 175</b>
			D 2066 LF53 <Euro 5/OBD2>	10.09→	6	DBJ	<b>0 445 120 201</b>	<b>0 986 435 656</b>	<b>F 00R J02 175</b>
			D 2066 LF60 <Euro 5/EEV/OBD2>	09.09→	6	DBJ	<b>0 445 120 217</b>	<b>0 986 435 526</b>	<b>F 00R J02 175</b>
			D 2066 LF68 <Euro 6>; D 2066 LF81 <Euro 6>; D 2066 LF86 <Euro 6/OBDC>	06.13→	6	DBJ	<b>0 445 120 353</b>	<b>0 986 435 593</b>	<b>F 00R J02 175</b>
<b>35.360</b>	10,5	265	D 2066 LF19 <Euro 5/OBD1>; D 2066 LF27 <Euro 5/OBD1>; D 2066 LF38 <Euro 4/OBD1>	10.07-06.16	6	DBJ	<b>0 445 120 217</b>	<b>0 986 435 526</b>	<b>F 00R J02 175</b>
			D 2066 LF42 <Euro 5/OBD2>	09.09→	6	DBJ	<b>0 445 120 217</b>	<b>0 986 435 526</b>	<b>F 00R J02 175</b>
			D 2066 LF52 <Euro 5/OBD2>	10.09→	6	DBJ	<b>0 445 120 201</b>	<b>0 986 435 656</b>	<b>F 00R J02 175</b>
			D 2066 LF59 <Euro 5/EEV/OBD2>	09.09→	6	DBJ	<b>0 445 120 217</b>	<b>0 986 435 526</b>	<b>F 00R J02 175</b>
			D 2066 LF67 <Euro 6>; D 2066 LF80 <Euro 6>; D 2066 LF85 <Euro 6/OBDC>	06.13→	6	DBJ	<b>0 445 120 353</b>	<b>0 986 435 593</b>	<b>F 00R J02 175</b>
WW	10,5	265	D 2066 LF64 <Euro 4/OBD2>	02.11-12.13	6	DBJ	<b>0 445 120 217</b>	<b>0 986 435 526</b>	<b>F 00R J02 175</b>
<b>35.390 WW</b>	10,5	287	D 2066 LF02 <Euro 3>	06.10-12.13	6	DBJ	<b>0 445 120 218</b>	<b>0 986 435 517</b>	<b>F 00R J02 175</b>
<b>35.400</b>	10,5	294	D 2066 LF18 <Euro 5/OBD1>; D 2066 LF26 <Euro 5/OBD1>; D 2066 LF37 <Euro 4/OBD1>	10.07-06.16	6	DBJ	<b>0 445 120 217</b>	<b>0 986 435 526</b>	<b>F 00R J02 175</b>
			D 2066 LF41 <Euro 5/OBD2>	09.09→	6	DBJ	<b>0 445 120 217</b>	<b>0 986 435 526</b>	<b>F 00R J02 175</b>
			D 2066 LF51 <Euro 5/OBD2>	10.09→	6	DBJ	<b>0 445 120 201</b>	<b>0 986 435 656</b>	<b>F 00R J02 175</b>
			D 2066 LF58 <Euro 5/EEV/OBD2>	09.09→	6	DBJ	<b>0 445 120 217</b>	<b>0 986 435 526</b>	<b>F 00R J02 175</b>
			D 2066 LF61 <Euro 6>	06.13-06.16	6	DBJ	<b>0 445 120 353</b>	<b>0 986 435 593</b>	<b>F 00R J02 175</b>
WW	12,4	294	D 2676 LF47 <Euro 6>	03.15→	6	DBJ	<b>0 445 120 354</b>	<b>0 986 435 650</b>	<b>F 00R J02 175</b>
	10,5	294	D 2066 LF49 <Euro 3>	02.11-12.13	6	DBJ	<b>0 445 120 217</b>	<b>0 986 435 526</b>	<b>F 00R J02 175</b>
			D 2066 LF63 <Euro 4/OBD2>	02.11-12.13	6	DBJ	<b>0 445 120 217</b>	<b>0 986 435 526</b>	<b>F 00R J02 175</b>
<b>35.420</b>	12,4	309	D 2676 LF53 <Euro 6/OBDC>	06.16→	6	DBJ	<b>0 445 120 420</b>		<b>F 00R J02 175</b>
<b>35.430 WW</b>	10,5	316	D 2066 LF01 <Euro 3>	06.10-12.13	6	DBJ	<b>0 445 120 218</b>	<b>0 986 435 517</b>	<b>F 00R J02 175</b>
<b>35.440</b>	10,5	324	D 2066 LF17 <Euro 5/OBD1>; D 2066 LF25 <Euro 5/OBD1>; D 2066 LF36 <Euro 4/OBD1>	10.07-06.16	6	DBJ	<b>0 445 120 217</b>	<b>0 986 435 526</b>	<b>F 00R J02 175</b>
			D 2066 LF40 <Euro 5/OBD2>	09.09→	6	DBJ	<b>0 445 120 217</b>	<b>0 986 435 526</b>	<b>F 00R J02 175</b>
			D 2066 LF57 <Euro 5/EEV/OBD2>	09.09→	6	DBJ	<b>0 445 120 217</b>	<b>0 986 435 526</b>	<b>F 00R J02 175</b>
	12,4	324	D 2676 LF22 <Euro 5/OBD2>	10.09→	6	DBJ	<b>0 445 120 202</b>	<b>0 986 435 570</b>	<b>F 00R J02 175</b>
			D 2676 LF26 <Euro 6>; D 2676 LF46 <Euro 6>	06.13→	6	DBJ	<b>0 445 120 354</b>	<b>0 986 435 650</b>	<b>F 00R J02 175</b>
WW	10,5	324	D 2066 LF50 <Euro 3>	02.11-12.13	6	DBJ	<b>0 445 120 217</b>	<b>0 986 435 526</b>	<b>F 00R J02 175</b>
			D 2066 LF62 <Euro 4/OBD2>	02.11-12.13	6	DBJ	<b>0 445 120 217</b>	<b>0 986 435 526</b>	<b>F 00R J02 175</b>
<b>35.460</b>	12,4	338	D 2676 LF52 <Euro 6/OBDC>	06.16→	6	DBJ	<b>0 445 120 420</b>		<b>F 00R J02 175</b>
<b>35.480</b>	12,4	353	D 2676 LF05 <Euro 4/OBD1>; D 2676 LF14 <Euro 5/OBD1>; D 2676 LF16 <Euro 5/OBD1>	10.07-12.13	6	DBJ	<b>0 445 120 219</b>	<b>0 986 435 528</b>	<b>F 00R J02 175</b>
			D 2676 LF07 <Euro 5/OBD2>	09.09→	6	DBJ	<b>0 445 120 219</b>	<b>0 986 435 528</b>	<b>F 00R J02 175</b>
			D 2676 LF18 <Euro 5/EEV/OBD2>	09.09→	6	DBJ	<b>0 445 120 219</b>	<b>0 986 435 528</b>	<b>F 00R J02 175</b>
			D 2676 LF25 <Euro 6>; D 2676 LF45 <Euro 6>	06.13→	6	DBJ	<b>0 445 120 354</b>	<b>0 986 435 650</b>	<b>F 00R J02 175</b>
WW	12,4	353	D 2676 LF02 <Euro 3>; D 2676 LF20 <Euro 4/OBD2>	06.10-12.13	6	DBJ	<b>0 445 120 219</b>	<b>0 986 435 528</b>	<b>F 00R J02 175</b>
<b>35.500</b>	12,4	368	D 2676 LF51 <Euro 6/OBDC>	06.16→	6	DBJ	<b>0 445 120 420</b>		<b>F 00R J02 175</b>
<b>35.540</b>	12,4	397	D 2676 LF06 <Euro 5/OBD2>; D 2676 LF13 <Euro 5/OBD1>; D 2676 LF15 <Euro 5/OBD1>	10.07→	6	DBJ	<b>0 445 120 219</b>	<b>0 986 435 528</b>	<b>F 00R J02 175</b>
<b>37.320</b>	10,5	235	D 2066 LF20 <Euro 5/OBD1>; D 2066 LF28 <Euro 5/OBD1>; D 2066 LF39 <Euro 4/OBD1>	10.07-12.13	6	DBJ	<b>0 445 120 217</b>	<b>0 986 435 526</b>	<b>F 00R J02 175</b>
			D 2066 LF43 <Euro 5/OBD2>	09.09→	6	DBJ	<b>0 445 120 217</b>	<b>0 986 435 526</b>	<b>F 00R J02 175</b>



												
<b>37.320</b>	10,5	235	D 2066 LF60 <Euro 5/EEV/OBD2>	09.09→	6	DBJ	<b>0 445 120 217</b>	<b>0 986 435 526</b>	<b>F 00R J02 175</b>			
			D 2066 LF68 <Euro 6>;	06.13→	6	DBJ	<b>0 445 120 353</b>	<b>0 986 435 593</b>	<b>F 00R J02 175</b>			
			D 2066 LF81 <Euro 6>;									
			D 2066 LF86 <Euro 6/OBDC>									
<b>37.360</b>	10,5	265	D 2066 LF19 <Euro 5/OBD1>;	10.07-12.13	6	DBJ	<b>0 445 120 217</b>	<b>0 986 435 526</b>	<b>F 00R J02 175</b>			
			D 2066 LF27 <Euro 5/OBD1>;									
			D 2066 LF38 <Euro 4/OBD1>									
			D 2066 LF42 <Euro 5/OBD2>	09.09→	6	DBJ	<b>0 445 120 217</b>	<b>0 986 435 526</b>	<b>F 00R J02 175</b>			
			D 2066 LF59 <Euro 5/EEV/OBD2>	09.09→	6	DBJ	<b>0 445 120 217</b>	<b>0 986 435 526</b>	<b>F 00R J02 175</b>			
			D 2066 LF67 <Euro 6>;	06.13→	6	DBJ	<b>0 445 120 353</b>	<b>0 986 435 593</b>	<b>F 00R J02 175</b>			
<b>37.400</b>	10,5	294	D 2066 LF26 <Euro 5/OBD1>;	10.07-12.13	6	DBJ	<b>0 445 120 217</b>	<b>0 986 435 526</b>	<b>F 00R J02 175</b>			
			D 2066 LF37 <Euro 4/OBD1>									
			D 2066 LF41 <Euro 5/OBD2>	09.09→	6	DBJ	<b>0 445 120 217</b>	<b>0 986 435 526</b>	<b>F 00R J02 175</b>			
			D 2066 LF58 <Euro 5/EEV/OBD2>	09.09→	6	DBJ	<b>0 445 120 217</b>	<b>0 986 435 526</b>	<b>F 00R J02 175</b>			
			D 2066 LF61 <Euro 6>	06.13-06.16	6	DBJ	<b>0 445 120 353</b>	<b>0 986 435 593</b>	<b>F 00R J02 175</b>			
	12,4	294	D 2676 LF47 <Euro 6>	03.15→	6	DBJ	<b>0 445 120 354</b>	<b>0 986 435 650</b>	<b>F 00R J02 175</b>			
<b>37.420</b>	12,4	309	D 2676 LF53 <Euro 6/OBDC>	06.16→	6	DBJ	<b>0 445 120 420</b>		<b>F 00R J02 175</b>			
<b>37.440</b>	10,5	324	D 2066 LF17 <Euro 5/OBD1>;	10.07-12.13	6	DBJ	<b>0 445 120 217</b>	<b>0 986 435 526</b>	<b>F 00R J02 175</b>			
			D 2066 LF25 <Euro 5/OBD1>;									
			D 2066 LF36 <Euro 4/OBD1>									
			D 2066 LF40 <Euro 5/OBD2>	09.09→	6	DBJ	<b>0 445 120 217</b>	<b>0 986 435 526</b>	<b>F 00R J02 175</b>			
			D 2066 LF57 <Euro 5/EEV/OBD2>	09.09→	6	DBJ	<b>0 445 120 217</b>	<b>0 986 435 526</b>	<b>F 00R J02 175</b>			
	12,4	324	D 2676 LF26 <Euro 6>;	06.13→	6	DBJ	<b>0 445 120 354</b>	<b>0 986 435 650</b>	<b>F 00R J02 175</b>			
			D 2676 LF46 <Euro 6>									
<b>37.460</b>	12,4	338	D 2676 LF52 <Euro 6/OBDC>	06.16→	6	DBJ	<b>0 445 120 420</b>		<b>F 00R J02 175</b>			
<b>37.480</b>	12,4	353	D 2676 LF05 <Euro 4/OBD1>;	10.07-12.13	6	DBJ	<b>0 445 120 219</b>	<b>0 986 435 528</b>	<b>F 00R J02 175</b>			
			D 2676 LF14 <Euro 5/OBD1>;									
			D 2676 LF16 <Euro 5/OBD1>									
			D 2676 LF07 <Euro 5/OBD2>	09.09→	6	DBJ	<b>0 445 120 219</b>	<b>0 986 435 528</b>	<b>F 00R J02 175</b>			
			D 2676 LF18 <Euro 5/EEV/OBD2>	09.09→	6	DBJ	<b>0 445 120 219</b>	<b>0 986 435 528</b>	<b>F 00R J02 175</b>			
			D 2676 LF25 <Euro 6>;	06.13→	6	DBJ	<b>0 445 120 354</b>	<b>0 986 435 650</b>	<b>F 00R J02 175</b>			
			D 2676 LF45 <Euro 6>									
<b>37.500</b>	12,4	368	D 2676 LF51 <Euro 6/OBDC>	06.16→	6	DBJ	<b>0 445 120 420</b>		<b>F 00R J02 175</b>			
<b>37.540</b>	12,4	397	D 2676 LF06 <Euro 5/OBD2>;	10.07→	6	DBJ	<b>0 445 120 219</b>	<b>0 986 435 528</b>	<b>F 00R J02 175</b>			
			D 2676 LF13 <Euro 5/OBD1>;									
			D 2676 LF15 <Euro 5/OBD1>									
<b>40.360 WW</b>	10,5	265	D 2066 LF07 <Euro 2>	09.11→	6	DBJ	<b>0 445 120 218</b>	<b>0 986 435 517</b>	<b>F 00R J02 175</b>			
			D 2066 LF42 <Euro 5/OBD2>;	12.11→	6	DBJ	<b>0 445 120 217</b>	<b>0 986 435 526</b>	<b>F 00R J02 175</b>			
			D 2066 LF64 <Euro 4/OBD2>									
			D 2066 LF48 <Euro 3>	09.11→	6	DBJ	<b>0 445 120 217</b>	<b>0 986 435 526</b>	<b>F 00R J02 175</b>			
<b>40.390 WW</b>	10,5	287	D 2066 LF02 <Euro 3>	03.10-09.16	6	DBJ	<b>0 445 120 218</b>	<b>0 986 435 517</b>	<b>F 00R J02 175</b>			
<b>40.400 WW</b>	10,5	294	D 2066 LF06 <Euro 2>	03.10→	6	DBJ	<b>0 445 120 218</b>	<b>0 986 435 517</b>	<b>F 00R J02 175</b>			
			D 2066 LF41 <Euro 5/OBD2>;	02.11→	6	DBJ	<b>0 445 120 217</b>	<b>0 986 435 526</b>	<b>F 00R J02 175</b>			
			D 2066 LF49 <Euro 3>;									
			D 2066 LF63 <Euro 4/OBD2>									
<b>40.430 WW</b>	10,5	316	D 2066 LF01 <Euro 3>	03.10-09.16	6	DBJ	<b>0 445 120 218</b>	<b>0 986 435 517</b>	<b>F 00R J02 175</b>			
<b>40.440 WW</b>	10,5	324	D 2066 LF40 <Euro 5/OBD2>;	02.11→	6	DBJ	<b>0 445 120 217</b>	<b>0 986 435 526</b>	<b>F 00R J02 175</b>			
			D 2066 LF50 <Euro 3>;									
			D 2066 LF62 <Euro 4/OBD2>									
	12,4	324	D 2676 LF04 <Euro 2>	03.10→	6	DBJ	<b>0 445 120 219</b>	<b>0 986 435 528</b>	<b>F 00R J02 175</b>			
<b>40.480 WW</b>	12,4	353	D 2676 LF02 <Euro 3>	03.10→	6	DBJ	<b>0 445 120 219</b>	<b>0 986 435 528</b>	<b>F 00R J02 175</b>			
			D 2676 LF03 <Euro 2>	03.10→	6	DBJ	<b>0 445 120 219</b>	<b>0 986 435 528</b>	<b>F 00R J02 175</b>			
			D 2676 LF07 <Euro 5/OBD2>;	12.11→	6	DBJ	<b>0 445 120 219</b>	<b>0 986 435 528</b>	<b>F 00R J02 175</b>			
			D 2676 LF20 <Euro 4/OBD2>									
<b>40.540 WW</b>	12,4	397	D 2676 LF06 <Euro 5/OBD2>	03.15→	6	DBJ	<b>0 445 120 219</b>	<b>0 986 435 528</b>	<b>F 00R J02 175</b>			
			D 2676 LF19 <Euro 4/OBD2>	03.15→	6	DBJ	<b>0 445 120 219</b>	<b>0 986 435 528</b>	<b>F 00R J02 175</b>			
<b>41.320</b>	10,5	235	D 2066 LF20 <Euro 5/OBD1>;	10.07-06.16	6	DBJ	<b>0 445 120 217</b>	<b>0 986 435 526</b>	<b>F 00R J02 175</b>			
			D 2066 LF28 <Euro 5/OBD1>;									
			D 2066 LF39 <Euro 4/OBD1>									
			D 2066 LF43 <Euro 5/OBD2>	09.09→	6	DBJ	<b>0 445 120 217</b>	<b>0 986 435 526</b>	<b>F 00R J02 175</b>			
			D 2066 LF60 <Euro 5/EEV/OBD2>	09.09→	6	DBJ	<b>0 445 120 217</b>	<b>0 986 435 526</b>	<b>F 00R J02 175</b>			





◀ MAN

<b>41.320</b>	10,5	235	D 2066 LF68 <Euro 6>; D 2066 LF81 <Euro 6>; D 2066 LF86 <Euro 6/OBDC>	06.13→	6	DBJ	<b>0 445 120 353</b>	<b>0 986 435 593</b>	<b>F 00R J02 175</b>
<b>41.350 WW</b>	10,5	257	D 2066 LF03 <Euro 3>	01.10-12.13	6	DBJ	<b>0 445 120 218</b>	<b>0 986 435 517</b>	<b>F 00R J02 175</b>
<b>41.360</b>	10,5	265	D 2066 LF19 <Euro 5/OBD1>; D 2066 LF27 <Euro 5/OBD1>; D 2066 LF38 <Euro 4/OBD1>	10.07-06.16	6	DBJ	<b>0 445 120 217</b>	<b>0 986 435 526</b>	<b>F 00R J02 175</b>
			D 2066 LF59 <Euro 5/EEV/OBD2>	09.09→	6	DBJ	<b>0 445 120 217</b>	<b>0 986 435 526</b>	<b>F 00R J02 175</b>
			D 2066 LF67 <Euro 6>; D 2066 LF80 <Euro 6>	06.13→	6	DBJ	<b>0 445 120 353</b>	<b>0 986 435 593</b>	<b>F 00R J02 175</b>
			D 2066 LF85 <Euro 6/OBDC>	09.16→	6	DBJ	<b>0 445 120 353</b>	<b>0 986 435 593</b>	<b>F 00R J02 175</b>
, WW	10,5	265	D 2066 LF42 <Euro 5/OBD2>	09.09→	6	DBJ	<b>0 445 120 217</b>	<b>0 986 435 526</b>	<b>F 00R J02 175</b>
WW	10,5	265	D 2066 LF07 <Euro 2> D 2066 LF48 <Euro 3> D 2066 LF64 <Euro 4/OBD2>	01.10→ 02.11→ 02.11→	6 6 6	DBJ DBJ DBJ	<b>0 445 120 218</b> <b>0 445 120 217</b> <b>0 445 120 217</b>	<b>0 986 435 517</b> <b>0 986 435 526</b> <b>0 986 435 526</b>	<b>F 00R J02 175</b> <b>F 00R J02 175</b> <b>F 00R J02 175</b>
<b>41.390 WW</b>	10,5	287	D 2066 LF02 <Euro 3>	01.10-12.13	6	DBJ	<b>0 445 120 218</b>	<b>0 986 435 517</b>	<b>F 00R J02 175</b>
<b>41.400</b>	10,5	294	D 2066 LF18 <Euro 5/OBD1>; D 2066 LF26 <Euro 5/OBD1>; D 2066 LF37 <Euro 4/OBD1>	10.07-06.16	6	DBJ	<b>0 445 120 217</b>	<b>0 986 435 526</b>	<b>F 00R J02 175</b>
			D 2066 LF58 <Euro 5/EEV/OBD2>	09.09→	6	DBJ	<b>0 445 120 217</b>	<b>0 986 435 526</b>	<b>F 00R J02 175</b>
			D 2066 LF61 <Euro 6>	06.13-06.16	6	DBJ	<b>0 445 120 353</b>	<b>0 986 435 593</b>	<b>F 00R J02 175</b>
	12,4	294	D 2676 LF47 <Euro 6>	03.15→	6	DBJ	<b>0 445 120 354</b>	<b>0 986 435 650</b>	<b>F 00R J02 175</b>
, WW	10,5	294	D 2066 LF41 <Euro 5/OBD2>	09.09→	6	DBJ	<b>0 445 120 217</b>	<b>0 986 435 526</b>	<b>F 00R J02 175</b>
WW	10,5	294	D 2066 LF06 <Euro 2> D 2066 LF49 <Euro 3> D 2066 LF63 <Euro 4/OBD2>	01.10→ 02.11→ 02.11→	6 6 6	DBJ DBJ DBJ	<b>0 445 120 218</b> <b>0 445 120 217</b> <b>0 445 120 217</b>	<b>0 986 435 517</b> <b>0 986 435 526</b> <b>0 986 435 526</b>	<b>F 00R J02 175</b> <b>F 00R J02 175</b> <b>F 00R J02 175</b>
<b>41.420</b>	12,4	309	D 2676 LF53 <Euro 6/OBDC>	06.16→	6	DBJ	<b>0 445 120 420</b>		<b>F 00R J02 175</b>
<b>41.430 WW</b>	10,5	316	D 2066 LF01 <Euro 3>	01.10-12.13	6	DBJ	<b>0 445 120 218</b>	<b>0 986 435 517</b>	<b>F 00R J02 175</b>
<b>41.440</b>	10,5	324	D 2066 LF17 <Euro 5/OBD1>; D 2066 LF25 <Euro 5/OBD1>; D 2066 LF36 <Euro 4/OBD1>	10.07-06.16	6	DBJ	<b>0 445 120 217</b>	<b>0 986 435 526</b>	<b>F 00R J02 175</b>
			D 2066 LF57 <Euro 5/EEV/OBD2>	09.09→	6	DBJ	<b>0 445 120 217</b>	<b>0 986 435 526</b>	<b>F 00R J02 175</b>
	12,4	324	D 2676 LF26 <Euro 6>; D 2676 LF46 <Euro 6>	06.13→	6	DBJ	<b>0 445 120 354</b>	<b>0 986 435 650</b>	<b>F 00R J02 175</b>
, WW	10,5	324	D 2066 LF40 <Euro 5/OBD2>	09.09→	6	DBJ	<b>0 445 120 217</b>	<b>0 986 435 526</b>	<b>F 00R J02 175</b>
WW	10,5	324	D 2066 LF50 <Euro 3> D 2066 LF62 <Euro 4/OBD2>	02.11→ 02.11→	6 6	DBJ DBJ	<b>0 445 120 217</b> <b>0 445 120 217</b>	<b>0 986 435 526</b> <b>0 986 435 526</b>	<b>F 00R J02 175</b> <b>F 00R J02 175</b>
	12,4	324	D 2676 LF04 <Euro 2>	01.10→	6	DBJ	<b>0 445 120 219</b>	<b>0 986 435 528</b>	<b>F 00R J02 175</b>
<b>41.460</b>	12,4	338	D 2676 LF52 <Euro 6/OBDC>	06.16→	6	DBJ	<b>0 445 120 420</b>		<b>F 00R J02 175</b>
<b>41.480</b>	12,4	353	D 2676 LF05 <Euro 4/OBD1>; D 2676 LF14 <Euro 5/OBD1>; D 2676 LF16 <Euro 5/OBD1>	10.07-06.16	6	DBJ	<b>0 445 120 219</b>	<b>0 986 435 528</b>	<b>F 00R J02 175</b>
			D 2676 LF18 <Euro 5/EEV/OBD2>	09.09→	6	DBJ	<b>0 445 120 219</b>	<b>0 986 435 528</b>	<b>F 00R J02 175</b>
			D 2676 LF25 <Euro 6>; D 2676 LF45 <Euro 6>	06.13→	6	DBJ	<b>0 445 120 354</b>	<b>0 986 435 650</b>	<b>F 00R J02 175</b>
, WW	12,4	353	D 2676 LF07 <Euro 5/OBD2>	09.09→	6	DBJ	<b>0 445 120 219</b>	<b>0 986 435 528</b>	<b>F 00R J02 175</b>
WW	12,4	353	D 2676 LF02 <Euro 3> D 2676 LF03 <Euro 2> D 2676 LF20 <Euro 4/OBD2>	01.10→ 01.10→ 02.11→	6 6 6	DBJ DBJ DBJ	<b>0 445 120 219</b> <b>0 445 120 219</b> <b>0 445 120 219</b>	<b>0 986 435 528</b> <b>0 986 435 528</b> <b>0 986 435 528</b>	<b>F 00R J02 175</b> <b>F 00R J02 175</b> <b>F 00R J02 175</b>
<b>41.500</b>	12,4	368	D 2676 LF51 <Euro 6/OBDC>	06.16→	6	DBJ	<b>0 445 120 420</b>		<b>F 00R J02 175</b>
<b>41.540</b>	12,4	397	D 2676 LF06 <Euro 5/OBD2>; D 2676 LF13 <Euro 5/OBD1>; D 2676 LF15 <Euro 5/OBD1>	10.07→	6	DBJ	<b>0 445 120 219</b>	<b>0 986 435 528</b>	<b>F 00R J02 175</b>

**TGX**

<b>18.360</b>	10,5	265	D 2066 LF19 <Euro 5/OBD1>; D 2066 LF27 <Euro 5/OBD1>; D 2066 LF38 <Euro 4/OBD1>	10.07-06.16	6	DBJ	<b>0 445 120 217</b>	<b>0 986 435 526</b>	<b>F 00R J02 175</b>
			D 2066 LF42 <Euro 5/OBD2>	09.09→	6	DBJ	<b>0 445 120 217</b>	<b>0 986 435 526</b>	<b>F 00R J02 175</b>
			D 2066 LF59 <Euro 5/EEV/OBD2>	09.09→	6	DBJ	<b>0 445 120 217</b>	<b>0 986 435 526</b>	<b>F 00R J02 175</b>
			D 2066 LF67 <Euro 6>; D 2066 LF80 <Euro 6>; D 2066 LF85 <Euro 6/OBDC>	10.12→	6	DBJ	<b>0 445 120 353</b>	<b>0 986 435 593</b>	<b>F 00R J02 175</b>



18.400	10,5	294	D 2066 LF18 <Euro 5/OBD1>; D 2066 LF26 <Euro 5/OBD1>; D 2066 LF37 <Euro 4/OBD1>	10.07-06.16	6	DBJ	0 445 120 217	0 986 435 526	F 00R J02 175	
			D 2066 LF41 <Euro 5/OBD2>	09.09→	6	DBJ	0 445 120 217	0 986 435 526	F 00R J02 175	
			D 2066 LF51 <Euro 5/OBD2>	10.09-06.16	6	DBJ	0 445 120 201	0 986 435 656	F 00R J02 175	
			D 2066 LF58 <Euro 5/EEV/OBD2>	09.09→	6	DBJ	0 445 120 217	0 986 435 526	F 00R J02 175	
			D 2066 LF61 <Euro 6>	10.12-06.16	6	DBJ	0 445 120 353	0 986 435 593	F 00R J02 175	
	12,4	294	D 2676 LF47 <Euro 6>	03.15→	6	DBJ	0 445 120 354	0 986 435 650	F 00R J02 175	
18.420	12,4	309	D 2676 LF53 <Euro 6/OBDC>	06.16→	6	DBJ	0 445 120 420		F 00R J02 175	
18.440	10,5	324	D 2066 LF17 <Euro 5/OBD1>; D 2066 LF25 <Euro 5/OBD1>; D 2066 LF36 <Euro 4/OBD1>	10.07-06.16	6	DBJ	0 445 120 217	0 986 435 526	F 00R J02 175	
			D 2066 LF40 <Euro 5/OBD2>	09.09→	6	DBJ	0 445 120 217	0 986 435 526	F 00R J02 175	
			D 2066 LF57 <Euro 5/EEV/OBD2>	09.09→	6	DBJ	0 445 120 217	0 986 435 526	F 00R J02 175	
	12,4	324	D 2676 LF22 <Euro 5/OBD2>	10.09-06.16	6	DBJ	0 445 120 202	0 986 435 570	F 00R J02 175	
			D 2676 LF26 <Euro 6>; D 2676 LF46 <Euro 6>	10.12→	6	DBJ	0 445 120 354	0 986 435 650	F 00R J02 175	
18.460	12,4	338	D 2676 LF52 <Euro 6/OBDC>	06.16→	6	DBJ	0 445 120 420		F 00R J02 175	
18.480	12,4	353	D 2676 LF07 <Euro 5/OBD2>	09.09→	6	DBJ	0 445 120 219	0 986 435 528	F 00R J02 175	
			D 2676 LF18 <Euro 5/EEV/OBD2>	09.09→	6	DBJ	0 445 120 219	0 986 435 528	F 00R J02 175	
			D 2676 LF25 <Euro 6>; D 2676 LF45 <Euro 6>	10.12→	6	DBJ	0 445 120 354	0 986 435 650	F 00R J02 175	
	, F, FL	12,4	353	D 2676 LF05 <Euro 4/OBD1>; D 2676 LF14 <Euro 5/OBD1>; D 2676 LF16 <Euro 5/OBD1>	10.07-06.16	6	DBJ	0 445 120 219	0 986 435 528	F 00R J02 175
18.500	12,4	368	D 2676 LF51 <Euro 6/OBDC>	06.16→	6	DBJ	0 445 120 420		F 00R J02 175	
18.520	15,2	383	D 3876 LF02 <Euro 6>	10.14-06.17	6	DBJ	0 445 124 024		F 00R J02 175	
				10.14→	6	DBJ	0 445 124 024		F 00R J02 175	
				07.17→	6	DBJ	0 445 124 052		F 00R J02 175	
18.540	12,4	397	D 2676 LF06 <Euro 5/OBD2>; D 2676 LF13 <Euro 5/OBD1>; D 2676 LF15 <Euro 5/OBD1>	10.07→	6	DBJ	0 445 120 219	0 986 435 528	F 00R J02 175	
	15,2	397	D 3876 LF08 <Euro 6/OBDC>	09.16-06.17	6	DBJ	0 445 124 024		F 00R J02 175	
				09.16→	6	DBJ	0 445 124 024		F 00R J02 175	
				07.17→	6	DBJ	0 445 124 052		F 00R J02 175	
18.560	15,2	412	D 3876 LF01 <Euro 6>	10.14-06.17	6	DBJ	0 445 124 024		F 00R J02 175	
				10.14→	6	DBJ	0 445 124 024		F 00R J02 175	
				07.17→	6	DBJ	0 445 124 052		F 00R J02 175	
18.580	15,2	427	D 3876 LF07 <Euro 6/OBDC>	09.16-06.17	6	DBJ	0 445 124 024		F 00R J02 175	
				09.16→	6	DBJ	0 445 124 024		F 00R J02 175	
				07.17→	6	DBJ	0 445 124 052		F 00R J02 175	
18.640	15,2	471	D 3876 LF09 <Euro 6/OBDC>	04.17-06.17	6	DBJ	0 445 124 024		F 00R J02 175	
				04.17→	6	DBJ	0 445 124 024		F 00R J02 175	
				07.17→	6	DBJ	0 445 124 052		F 00R J02 175	
18.680	16,2	500	D 2868 LF02 <Euro 5/OBD1>; D 2868 LF05 <Euro 5/EEV/OBD2>	01.08-05.14	8	DBJ	0 445 120 131	0 986 435 561	F 00R J02 175	
20.360	10,5	265	D 2066 LF42 <Euro 5/OBD2>	07.17→	6	DBJ	0 445 120 217	0 986 435 526	F 00R J02 175	
			D 2066 LF59 <Euro 5/EEV/OBD2>	07.17→	6	DBJ	0 445 120 217	0 986 435 526	F 00R J02 175	
20.400	10,5	294	D 2066 LF41 <Euro 5/OBD2>	07.17→	6	DBJ	0 445 120 217	0 986 435 526	F 00R J02 175	
			D 2066 LF58 <Euro 5/EEV/OBD2>	07.17→	6	DBJ	0 445 120 217	0 986 435 526	F 00R J02 175	
20.440	10,5	324	D 2066 LF40 <Euro 5/OBD2>	07.17→	6	DBJ	0 445 120 217	0 986 435 526	F 00R J02 175	
			D 2066 LF57 <Euro 5/EEV/OBD2>	07.17→	6	DBJ	0 445 120 217	0 986 435 526	F 00R J02 175	
20.480	12,4	353	D 2676 LF07 <Euro 5/OBD2>	07.17→	6	DBJ	0 445 120 219	0 986 435 528	F 00R J02 175	
			D 2676 LF18 <Euro 5/EEV/OBD2>	07.17→	6	DBJ	0 445 120 219	0 986 435 528	F 00R J02 175	
20.540	12,4	397	D 2676 LF06 <Euro 5/OBD2>	07.17→	6	DBJ	0 445 120 219	0 986 435 528	F 00R J02 175	
24.360	10,5	265	D 2066 LF19 <Euro 5/OBD1>; D 2066 LF27 <Euro 5/OBD1>; D 2066 LF38 <Euro 4/OBD1>	10.07-12.13	6	DBJ	0 445 120 217	0 986 435 526	F 00R J02 175	
			D 2066 LF42 <Euro 5/OBD2>	09.09→	6	DBJ	0 445 120 217	0 986 435 526	F 00R J02 175	
			D 2066 LF59 <Euro 5/EEV/OBD2>	09.09→	6	DBJ	0 445 120 217	0 986 435 526	F 00R J02 175	
			D 2066 LF67 <Euro 6>; D 2066 LF80 <Euro 6>; D 2066 LF85 <Euro 6/OBDC>	10.12→	6	DBJ	0 445 120 353	0 986 435 593	F 00R J02 175	





◀ MAN

<b>24.400</b>	10,5	294	D 2066 LF18 <Euro 5/OBD1>; D 2066 LF26 <Euro 5/OBD1>; D 2066 LF37 <Euro 4/OBD1>	10.07-12.13	6	DBJ	<b>0 445 120 217</b>	<b>0 986 435 526</b>	<b>F 00R J02 175</b>
			D 2066 LF41 <Euro 5/OBD2>	09.09→	6	DBJ	<b>0 445 120 217</b>	<b>0 986 435 526</b>	<b>F 00R J02 175</b>
			D 2066 LF51 <Euro 5/OBD2>	10.09-06.16	6	DBJ	<b>0 445 120 201</b>	<b>0 986 435 656</b>	<b>F 00R J02 175</b>
			D 2066 LF58 <Euro 5/EEV/OBD2>	09.09→	6	DBJ	<b>0 445 120 217</b>	<b>0 986 435 526</b>	<b>F 00R J02 175</b>
			D 2066 LF61 <Euro 6>	10.12-06.16	6	DBJ	<b>0 445 120 353</b>	<b>0 986 435 593</b>	<b>F 00R J02 175</b>
	12,4	294	D 2676 LF47 <Euro 6>	03.15→	6	DBJ	<b>0 445 120 354</b>	<b>0 986 435 650</b>	<b>F 00R J02 175</b>
<b>24.420</b>	12,4	309	D 2676 LF53 <Euro 6/OBDC>	06.16→	6	DBJ	<b>0 445 120 420</b>		<b>F 00R J02 175</b>
<b>24.440</b>	10,5	324	D 2066 LF17 <Euro 5/OBD1>; D 2066 LF25 <Euro 5/OBD1>; D 2066 LF36 <Euro 4/OBD1>	10.07-12.13	6	DBJ	<b>0 445 120 217</b>	<b>0 986 435 526</b>	<b>F 00R J02 175</b>
			D 2066 LF40 <Euro 5/OBD2>	09.09→	6	DBJ	<b>0 445 120 217</b>	<b>0 986 435 526</b>	<b>F 00R J02 175</b>
			D 2066 LF57 <Euro 5/EEV/OBD2>	09.09→	6	DBJ	<b>0 445 120 217</b>	<b>0 986 435 526</b>	<b>F 00R J02 175</b>
	12,4	324	D 2676 LF22 <Euro 5/OBD2>	10.09-06.16	6	DBJ	<b>0 445 120 202</b>	<b>0 986 435 570</b>	<b>F 00R J02 175</b>
			D 2676 LF26 <Euro 6>; D 2676 LF46 <Euro 6>	10.12→	6	DBJ	<b>0 445 120 354</b>	<b>0 986 435 650</b>	<b>F 00R J02 175</b>
<b>24.460</b>	12,4	338	D 2676 LF52 <Euro 6/OBDC>	06.16→	6	DBJ	<b>0 445 120 420</b>		<b>F 00R J02 175</b>
<b>24.480</b>	12,4	353	D 2676 LF05 <Euro 4/OBD1>; D 2676 LF07 <Euro 5/OBD2>; D 2676 LF14 <Euro 5/OBD1>; D 2676 LF16 <Euro 5/OBD1>; D 2676 LF18 <Euro 5/EEV/OBD2>; D 2676 LF25 <Euro 6>; D 2676 LF45 <Euro 6>	10.07-12.13	6	DBJ	<b>0 445 120 219</b>	<b>0 986 435 528</b>	<b>F 00R J02 175</b>
				09.09→	6	DBJ	<b>0 445 120 219</b>	<b>0 986 435 528</b>	<b>F 00R J02 175</b>
				10.07-05.11	6	DBJ	<b>0 445 120 219</b>	<b>0 986 435 528</b>	<b>F 00R J02 175</b>
				10.07-05.11	6	DBJ	<b>0 445 120 219</b>	<b>0 986 435 528</b>	<b>F 00R J02 175</b>
				09.09→	6	DBJ	<b>0 445 120 219</b>	<b>0 986 435 528</b>	<b>F 00R J02 175</b>
				10.12→	6	DBJ	<b>0 445 120 354</b>	<b>0 986 435 650</b>	<b>F 00R J02 175</b>
<b>24.500</b>	12,4	368	D 2676 LF51 <Euro 6/OBDC>	06.16→	6	DBJ	<b>0 445 120 420</b>		<b>F 00R J02 175</b>
<b>24.540</b>	12,4	397	D 2676 LF06 <Euro 5/OBD2>	09.09→	6	DBJ	<b>0 445 120 219</b>	<b>0 986 435 528</b>	<b>F 00R J02 175</b>
<b>26.360</b>	10,5	265	D 2066 LF19 <Euro 5/OBD1>; D 2066 LF27 <Euro 5/OBD1>; D 2066 LF38 <Euro 4/OBD1>	10.07-06.16	6	DBJ	<b>0 445 120 217</b>	<b>0 986 435 526</b>	<b>F 00R J02 175</b>
			D 2066 LF42 <Euro 5/OBD2>	09.09→	6	DBJ	<b>0 445 120 217</b>	<b>0 986 435 526</b>	<b>F 00R J02 175</b>
			D 2066 LF59 <Euro 5/EEV/OBD2>	09.09→	6	DBJ	<b>0 445 120 217</b>	<b>0 986 435 526</b>	<b>F 00R J02 175</b>
			D 2066 LF67 <Euro 6>; D 2066 LF80 <Euro 6>; D 2066 LF85 <Euro 6/OBDC>	10.12→	6	DBJ	<b>0 445 120 353</b>	<b>0 986 435 593</b>	<b>F 00R J02 175</b>
<b>26.400</b>	10,5	294	D 2066 LF18 <Euro 5/OBD1>; D 2066 LF26 <Euro 5/OBD1>; D 2066 LF37 <Euro 4/OBD1>	10.07-06.16	6	DBJ	<b>0 445 120 217</b>	<b>0 986 435 526</b>	<b>F 00R J02 175</b>
			D 2066 LF41 <Euro 5/OBD2>	09.09→	6	DBJ	<b>0 445 120 217</b>	<b>0 986 435 526</b>	<b>F 00R J02 175</b>
			D 2066 LF51 <Euro 5/OBD2>	10.09-06.16	6	DBJ	<b>0 445 120 201</b>	<b>0 986 435 656</b>	<b>F 00R J02 175</b>
			D 2066 LF58 <Euro 5/EEV/OBD2>	09.09→	6	DBJ	<b>0 445 120 217</b>	<b>0 986 435 526</b>	<b>F 00R J02 175</b>
			D 2066 LF61 <Euro 6>	10.12-06.16	6	DBJ	<b>0 445 120 353</b>	<b>0 986 435 593</b>	<b>F 00R J02 175</b>
	12,4	294	D 2676 LF47 <Euro 6>	03.15→	6	DBJ	<b>0 445 120 354</b>	<b>0 986 435 650</b>	<b>F 00R J02 175</b>
<b>26.420</b>	12,4	309	D 2676 LF53 <Euro 6/OBDC>	06.16→	6	DBJ	<b>0 445 120 420</b>		<b>F 00R J02 175</b>
<b>26.440</b>	10,5	324	D 2066 LF17 <Euro 5/OBD1>; D 2066 LF25 <Euro 5/OBD1>; D 2066 LF36 <Euro 4/OBD1>	10.07-06.16	6	DBJ	<b>0 445 120 217</b>	<b>0 986 435 526</b>	<b>F 00R J02 175</b>
			D 2066 LF40 <Euro 5/OBD2>	09.09→	6	DBJ	<b>0 445 120 217</b>	<b>0 986 435 526</b>	<b>F 00R J02 175</b>
			D 2066 LF57 <Euro 5/EEV/OBD2>	09.09→	6	DBJ	<b>0 445 120 217</b>	<b>0 986 435 526</b>	<b>F 00R J02 175</b>
	12,4	324	D 2676 LF22 <Euro 5/OBD2>	10.09-06.16	6	DBJ	<b>0 445 120 202</b>	<b>0 986 435 570</b>	<b>F 00R J02 175</b>
			D 2676 LF26 <Euro 6>; D 2676 LF46 <Euro 6>	10.12→	6	DBJ	<b>0 445 120 354</b>	<b>0 986 435 650</b>	<b>F 00R J02 175</b>
<b>26.460</b>	12,4	338	D 2676 LF52 <Euro 6/OBDC>	06.16→	6	DBJ	<b>0 445 120 420</b>		<b>F 00R J02 175</b>
<b>26.480</b>	12,4	353	D 2676 LF05 <Euro 4/OBD1>; D 2676 LF14 <Euro 5/OBD1>; D 2676 LF16 <Euro 5/OBD1>	10.07-06.16	6	DBJ	<b>0 445 120 219</b>	<b>0 986 435 528</b>	<b>F 00R J02 175</b>
			D 2676 LF07 <Euro 5/OBD2>	09.09→	6	DBJ	<b>0 445 120 219</b>	<b>0 986 435 528</b>	<b>F 00R J02 175</b>
			D 2676 LF18 <Euro 5/EEV/OBD2>	09.09→	6	DBJ	<b>0 445 120 219</b>	<b>0 986 435 528</b>	<b>F 00R J02 175</b>
			D 2676 LF45 <Euro 6>	03.15→	6	DBJ	<b>0 445 120 354</b>	<b>0 986 435 650</b>	<b>F 00R J02 175</b>
<b>26.500</b>	12,4	368	D 2676 LF51 <Euro 6/OBDC>	06.16→	6	DBJ	<b>0 445 120 420</b>		<b>F 00R J02 175</b>
<b>26.520</b>	15,2	383	D 3876 LF02 <Euro 6>	10.14-06.17	6	DBJ	<b>0 445 124 024</b>		<b>F 00R J02 175</b>
				10.14→	6	DBJ	<b>0 445 124 024</b>		<b>F 00R J02 175</b>
				07.17→	6	DBJ	<b>0 445 124 052</b>		<b>F 00R J02 175</b>







26.540	12,4	397	D 2676 LF06 <Euro 5/OBD2>; D 2676 LF13 <Euro 5/OBD1>; D 2676 LF15 <Euro 5/OBD1>	10.07→	6	DBJ	0 445 120 219	0 986 435 528	F 00R J02 175	
	15,2	397	D 3876 LF08 <Euro 6/OBDC>	09.16-06.17	6	DBJ	0 445 124 024		F 00R J02 175	
				09.16→	6	DBJ	0 445 124 024		F 00R J02 175	
				07.17→	6	DBJ	0 445 124 052		F 00R J02 175	
26.560	15,2	412	D 3876 LF01 <Euro 6>	10.14-06.17	6	DBJ	0 445 124 024		F 00R J02 175	
				10.14→	6	DBJ	0 445 124 024		F 00R J02 175	
				07.17→	6	DBJ	0 445 124 052		F 00R J02 175	
26.580	15,2	427	D 3876 LF07 <Euro 6/OBDC>	09.16-06.17	6	DBJ	0 445 124 024		F 00R J02 175	
				09.16→	6	DBJ	0 445 124 024		F 00R J02 175	
				07.17→	6	DBJ	0 445 124 052		F 00R J02 175	
26.640	15,2	471	D 3876 LF09 <Euro 6/OBDC>	04.17-06.17	6	DBJ	0 445 124 024		F 00R J02 175	
				04.17→	6	DBJ	0 445 124 024		F 00R J02 175	
				07.17→	6	DBJ	0 445 124 052		F 00R J02 175	
28.360	10,5	265	D 2066 LF19 <Euro 5/OBD1>; D 2066 LF27 <Euro 5/OBD1>; D 2066 LF38 <Euro 4/OBD1>	10.07-06.16	6	DBJ	0 445 120 217	0 986 435 526	F 00R J02 175	
				D 2066 LF42 <Euro 5/OBD2>	09.09→	6	DBJ	0 445 120 217	0 986 435 526	F 00R J02 175
				D 2066 LF59 <Euro 5/EEV/OBD2>	09.09→	6	DBJ	0 445 120 217	0 986 435 526	F 00R J02 175
				D 2066 LF67 <Euro 6>; D 2066 LF80 <Euro 6>; D 2066 LF85 <Euro 6/OBDC>	10.12→	6	DBJ	0 445 120 353	0 986 435 593	F 00R J02 175
				D 2066 LF18 <Euro 5/OBD1>; D 2066 LF26 <Euro 5/OBD1>; D 2066 LF37 <Euro 4/OBD1>	10.07-06.16	6	DBJ	0 445 120 217	0 986 435 526	F 00R J02 175
				D 2066 LF41 <Euro 5/OBD2>	09.09→	6	DBJ	0 445 120 217	0 986 435 526	F 00R J02 175
28.400	10,5	294	D 2066 LF58 <Euro 5/EEV/OBD2>	09.09→	6	DBJ	0 445 120 217	0 986 435 526	F 00R J02 175	
				D 2066 LF61 <Euro 6>	10.12-06.16	6	DBJ	0 445 120 353	0 986 435 593	F 00R J02 175
				D 2676 LF47 <Euro 6>	03.15→	6	DBJ	0 445 120 354	0 986 435 650	F 00R J02 175
28.420	12,4	309	D 2676 LF53 <Euro 6/OBDC>	06.16→	6	DBJ	0 445 120 420		F 00R J02 175	
28.440	10,5	324	D 2066 LF17 <Euro 5/OBD1>; D 2066 LF25 <Euro 5/OBD1>; D 2066 LF36 <Euro 4/OBD1>	10.07-06.16	6	DBJ	0 445 120 217	0 986 435 526	F 00R J02 175	
				D 2066 LF40 <Euro 5/OBD2>	09.09→	6	DBJ	0 445 120 217	0 986 435 526	F 00R J02 175
				D 2066 LF57 <Euro 5/EEV/OBD2>	09.09→	6	DBJ	0 445 120 217	0 986 435 526	F 00R J02 175
				D 2676 LF26 <Euro 6>; D 2676 LF46 <Euro 6>	10.12→	6	DBJ	0 445 120 354	0 986 435 650	F 00R J02 175
28.460	12,4	338	D 2676 LF52 <Euro 6/OBDC>	06.16→	6	DBJ	0 445 120 420		F 00R J02 175	
28.480	12,4	353	D 2676 LF05 <Euro 4/OBD1>; D 2676 LF14 <Euro 5/OBD1>	10.07-06.16	6	DBJ	0 445 120 219	0 986 435 528	F 00R J02 175	
				D 2676 LF07 <Euro 5/OBD2>	09.09→	6	DBJ	0 445 120 219	0 986 435 528	F 00R J02 175
				D 2676 LF18 <Euro 5/EEV/OBD2>	09.09→	6	DBJ	0 445 120 219	0 986 435 528	F 00R J02 175
				D 2676 LF25 <Euro 6>; D 2676 LF45 <Euro 6>	10.12→	6	DBJ	0 445 120 354	0 986 435 650	F 00R J02 175
				D 2676 LF51 <Euro 6/OBDC>	06.16→	6	DBJ	0 445 120 420		F 00R J02 175
28.520	15,2	383	D 3876 LF02 <Euro 6>	10.14-06.17	6	DBJ	0 445 124 024		F 00R J02 175	
				10.14→	6	DBJ	0 445 124 024		F 00R J02 175	
				07.17→	6	DBJ	0 445 124 052		F 00R J02 175	
28.540	12,4	397	D 2676 LF06 <Euro 5/OBD2>; D 2676 LF13 <Euro 5/OBD1>; D 2676 LF15 <Euro 5/OBD1>	10.07→	6	DBJ	0 445 120 219	0 986 435 528	F 00R J02 175	
				D 3876 LF08 <Euro 6/OBDC>	09.16-06.17	6	DBJ	0 445 124 024		F 00R J02 175
					09.16→	6	DBJ	0 445 124 024		F 00R J02 175
					07.17→	6	DBJ	0 445 124 052		F 00R J02 175
28.560	15,2	412	D 3876 LF01 <Euro 6>	10.14-06.17	6	DBJ	0 445 124 024		F 00R J02 175	
				10.14→	6	DBJ	0 445 124 024		F 00R J02 175	
				07.17→	6	DBJ	0 445 124 052		F 00R J02 175	
28.580	15,2	427	D 3876 LF07 <Euro 6/OBDC>	09.16-06.17	6	DBJ	0 445 124 024		F 00R J02 175	
				09.16→	6	DBJ	0 445 124 024		F 00R J02 175	
				07.17→	6	DBJ	0 445 124 052		F 00R J02 175	







◀ MAN

28.640	15,2	471	D 3876 LF09 <Euro 6/OBDC>	06.17-06.17	6	DBJ	0 445 124 024	F 00R J02 175		
				06.17→	6	DBJ	0 445 124 024	F 00R J02 175		
				07.17→	6	DBJ	0 445 124 052	F 00R J02 175		
33.360	10,5	265	D 2066 LF19 <Euro 5/OBD1>; D 2066 LF27 <Euro 5/OBD1>; D 2066 LF38 <Euro 4/OBD1>	10.07-06.16	6	DBJ	0 445 120 217	0 986 435 526	F 00R J02 175	
				09.09→	6	DBJ	0 445 120 217	0 986 435 526	F 00R J02 175	
				09.09→	6	DBJ	0 445 120 217	0 986 435 526	F 00R J02 175	
				06.13→	6	DBJ	0 445 120 353	0 986 435 593	F 00R J02 175	
				D 2066 LF42 <Euro 5/OBD2>	09.09→	6	DBJ	0 445 120 217	0 986 435 526	F 00R J02 175
				D 2066 LF59 <Euro 5/EEV/OBD2>	09.09→	6	DBJ	0 445 120 217	0 986 435 526	F 00R J02 175
				D 2066 LF67 <Euro 6>; D 2066 LF80 <Euro 6>; D 2066 LF85 <Euro 6/OBDC>	06.13→	6	DBJ	0 445 120 353	0 986 435 593	F 00R J02 175
33.400	10,5	294	D 2066 LF18 <Euro 5/OBD1>; D 2066 LF26 <Euro 5/OBD1>; D 2066 LF37 <Euro 4/OBD1>	10.07-06.16	6	DBJ	0 445 120 217	0 986 435 526	F 00R J02 175	
				09.09→	6	DBJ	0 445 120 217	0 986 435 526	F 00R J02 175	
				09.09→	6	DBJ	0 445 120 217	0 986 435 526	F 00R J02 175	
				D 2066 LF58 <Euro 5/EEV/OBD2>	09.09→	6	DBJ	0 445 120 217	0 986 435 526	F 00R J02 175
				D 2066 LF61 <Euro 6>	06.13-06.16	6	DBJ	0 445 120 353	0 986 435 593	F 00R J02 175
33.420	12,4	294	D 2676 LF47 <Euro 6>	03.15→	6	DBJ	0 445 120 354	0 986 435 650	F 00R J02 175	
				09.16→	6	DBJ	0 445 120 420	F 00R J02 175		
33.440	10,5	324	D 2066 LF17 <Euro 5/OBD1>; D 2066 LF25 <Euro 5/OBD1>; D 2066 LF36 <Euro 4/OBD1>	10.07-06.16	6	DBJ	0 445 120 217	0 986 435 526	F 00R J02 175	
				09.09→	6	DBJ	0 445 120 217	0 986 435 526	F 00R J02 175	
				09.09→	6	DBJ	0 445 120 217	0 986 435 526	F 00R J02 175	
				D 2066 LF40 <Euro 5/OBD2>	09.09→	6	DBJ	0 445 120 217	0 986 435 526	F 00R J02 175
33.460	12,4	338	D 2676 LF52 <Euro 6/OBDC>	09.16→	6	DBJ	0 445 120 420	F 00R J02 175		
				06.13→	6	DBJ	0 445 120 354	0 986 435 650	F 00R J02 175	
33.480	12,4	353	D 2676 LF07 <Euro 5/OBD2>; D 2676 LF18 <Euro 5/EEV/OBD2>; D 2676 LF25 <Euro 6>; D 2676 LF45 <Euro 6>	09.09→	6	DBJ	0 445 120 219	0 986 435 528	F 00R J02 175	
				09.09→	6	DBJ	0 445 120 219	0 986 435 528	F 00R J02 175	
				06.13→	6	DBJ	0 445 120 354	0 986 435 650	F 00R J02 175	
				09.09→	6	DBJ	0 445 120 219	0 986 435 528	F 00R J02 175	
,DF	12,4	353	D 2676 LF05 <Euro 4/OBD1>; D 2676 LF14 <Euro 5/OBD1>; D 2676 LF16 <Euro 5/OBD1>	10.07-06.16	6	DBJ	0 445 120 219	0 986 435 528	F 00R J02 175	
				09.16→	6	DBJ	0 445 120 420	F 00R J02 175		
33.500	12,4	368	D 2676 LF51 <Euro 6/OBDC>	09.16→	6	DBJ	0 445 120 420	F 00R J02 175		
				10.14-06.17	6	DBJ	0 445 124 024	F 00R J02 175		
				10.14→	6	DBJ	0 445 124 024	F 00R J02 175		
33.520	15,2	383	D 3876 LF02 <Euro 6>	07.17→	6	DBJ	0 445 124 052	F 00R J02 175		
				10.14→	6	DBJ	0 445 124 024	F 00R J02 175		
				07.17→	6	DBJ	0 445 124 052	F 00R J02 175		
33.540	12,4	397	D 2676 LF06 <Euro 5/OBD2>; D 2676 LF13 <Euro 5/OBD1>; D 2676 LF15 <Euro 5/OBD1>	10.07→	6	DBJ	0 445 120 219	0 986 435 528	F 00R J02 175	
				09.16-06.17	6	DBJ	0 445 124 024	F 00R J02 175		
				09.16→	6	DBJ	0 445 124 024	F 00R J02 175		
				07.17→	6	DBJ	0 445 124 052	F 00R J02 175		
				09.16-06.17	6	DBJ	0 445 124 024	F 00R J02 175		
33.560	15,2	412	D 3876 LF01 <Euro 6>	10.14-06.17	6	DBJ	0 445 124 024	F 00R J02 175		
				10.14→	6	DBJ	0 445 124 024	F 00R J02 175		
				07.17→	6	DBJ	0 445 124 052	F 00R J02 175		
				09.16-06.17	6	DBJ	0 445 124 024	F 00R J02 175		
33.580	15,2	427	D 3876 LF07 <Euro 6/OBDC>	09.16→	6	DBJ	0 445 124 024	F 00R J02 175		
				07.17→	6	DBJ	0 445 124 052	F 00R J02 175		
				09.16→	6	DBJ	0 445 124 024	F 00R J02 175		
33.640	15,2	471	D 3876 LF09 <Euro 6/OBDC>	04.17-06.17	6	DBJ	0 445 124 024	F 00R J02 175		
				04.17→	6	DBJ	0 445 124 024	F 00R J02 175		
				07.17→	6	DBJ	0 445 124 052	F 00R J02 175		
33.680	16,2	500	D 2868 LF02 <Euro 5/OBD1>; D 2868 LF05 <Euro 5/EEV/OBD2>	01.08-05.14	8	DBJ	0 445 120 131	0 986 435 561	F 00R J02 175	
				09.07-12.13	6	DBJ	0 445 120 217	0 986 435 526	F 00R J02 175	
35.360	10,5	265	D 2066 LF19 <Euro 5/OBD1>; D 2066 LF27 <Euro 5/OBD1>; D 2066 LF38 <Euro 4/OBD1>	09.07-12.13	6	DBJ	0 445 120 217	0 986 435 526	F 00R J02 175	
				09.09→	6	DBJ	0 445 120 217	0 986 435 526	F 00R J02 175	
				09.09→	6	DBJ	0 445 120 217	0 986 435 526	F 00R J02 175	
				D 2066 LF42 <Euro 5/OBD2>	09.09→	6	DBJ	0 445 120 217	0 986 435 526	F 00R J02 175
				D 2066 LF59 <Euro 5/EEV/OBD2>	09.09→	6	DBJ	0 445 120 217	0 986 435 526	F 00R J02 175
				D 2066 LF67 <Euro 6>; D 2066 LF80 <Euro 6>; D 2066 LF85 <Euro 6/OBDC>	12.13→	6	DBJ	0 445 120 353	0 986 435 593	F 00R J02 175





35.400	10,5	294	D 2066 LF18 <Euro 5/OBD1>; D 2066 LF26 <Euro 5/OBD1>; D 2066 LF37 <Euro 4/OBD1>	09.07-12.13	6	DBJ	0 445 120 217	0 986 435 526	F 00R J02 175
			D 2066 LF41 <Euro 5/OBD2>	09.09→	6	DBJ	0 445 120 217	0 986 435 526	F 00R J02 175
			D 2066 LF58 <Euro 5/EEV/OBD2>	09.09→	6	DBJ	0 445 120 217	0 986 435 526	F 00R J02 175
			D 2066 LF61 <Euro 6>	12.13-06.16	6	DBJ	0 445 120 353	0 986 435 593	F 00R J02 175
	12,4	294	D 2676 LF47 <Euro 6>	03.15→	6	DBJ	0 445 120 354	0 986 435 650	F 00R J02 175
35.420	12,4	309	D 2676 LF53 <Euro 6/OBDC>	09.16→	6	DBJ	0 445 120 420		F 00R J02 175
35.440	10,5	324	D 2066 LF17 <Euro 5/OBD1>; D 2066 LF25 <Euro 5/OBD1>; D 2066 LF36 <Euro 4/OBD1>	09.07-12.13	6	DBJ	0 445 120 217	0 986 435 526	F 00R J02 175
			D 2066 LF40 <Euro 5/OBD2>	09.09→	6	DBJ	0 445 120 217	0 986 435 526	F 00R J02 175
			D 2066 LF57 <Euro 5/EEV/OBD2>	09.09→	6	DBJ	0 445 120 217	0 986 435 526	F 00R J02 175
	12,4	324	D 2676 LF26 <Euro 6>; D 2676 LF46 <Euro 6>	12.13→	6	DBJ	0 445 120 354	0 986 435 650	F 00R J02 175
35.460	12,4	338	D 2676 LF52 <Euro 6/OBDC>	09.16→	6	DBJ	0 445 120 420		F 00R J02 175
35.480	12,4	353	D 2676 LF05 <Euro 4/OBD1>; D 2676 LF14 <Euro 5/OBD1>; D 2676 LF16 <Euro 5/OBD1>	09.07-12.13	6	DBJ	0 445 120 219	0 986 435 528	F 00R J02 175
			D 2676 LF07 <Euro 5/OBD2>	09.09→	6	DBJ	0 445 120 219	0 986 435 528	F 00R J02 175
			D 2676 LF18 <Euro 5/EEV/OBD2>	09.09→	6	DBJ	0 445 120 219	0 986 435 528	F 00R J02 175
			D 2676 LF25 <Euro 6>; D 2676 LF45 <Euro 6>	12.13→	6	DBJ	0 445 120 354	0 986 435 650	F 00R J02 175
35.500	12,4	368	D 2676 LF51 <Euro 6/OBDC>	09.16→	6	DBJ	0 445 120 420		F 00R J02 175
35.520	15,2	383	D 3876 LF02 <Euro 6>	10.14-06.17	6	DBJ	0 445 124 024		F 00R J02 175
				10.14→	6	DBJ	0 445 124 024		F 00R J02 175
				07.17→	6	DBJ	0 445 124 052		F 00R J02 175
35.540	12,4	397	D 2676 LF06 <Euro 5/OBD2>; D 2676 LF13 <Euro 5/OBD1>; D 2676 LF15 <Euro 5/OBD1>	09.07→	6	DBJ	0 445 120 219	0 986 435 528	F 00R J02 175
	15,2	397	D 3876 LF08 <Euro 6/OBDC>	09.16-06.17	6	DBJ	0 445 124 024		F 00R J02 175
				09.16→	6	DBJ	0 445 124 024		F 00R J02 175
				07.17→	6	DBJ	0 445 124 052		F 00R J02 175
35.560	15,2	412	D 3876 LF01 <Euro 6>	10.14-06.17	6	DBJ	0 445 124 024		F 00R J02 175
				10.14→	6	DBJ	0 445 124 024		F 00R J02 175
				07.17→	6	DBJ	0 445 124 052		F 00R J02 175
35.580	15,2	427	D 3876 LF07 <Euro 6/OBDC>	09.16-06.17	6	DBJ	0 445 124 024		F 00R J02 175
				09.16→	6	DBJ	0 445 124 024		F 00R J02 175
				07.17→	6	DBJ	0 445 124 052		F 00R J02 175
35.640	15,2	471	D 3876 LF09 <Euro 6/OBDC>	04.17-06.17	6	DBJ	0 445 124 024		F 00R J02 175
				04.17→	6	DBJ	0 445 124 024		F 00R J02 175
				07.17→	6	DBJ	0 445 124 052		F 00R J02 175
41.540	12,4	397	D 2676 LF06 <Euro 5/OBD2>; D 2676 LF13 <Euro 5/OBD1>; D 2676 LF15 <Euro 5/OBD1>	10.07→	6	DBJ	0 445 120 219	0 986 435 528	F 00R J02 175
41.560	15,2	412	D 3876 LF01 <Euro 6>	10.14-06.17	6	DBJ	0 445 124 024		F 00R J02 175
				10.14→	6	DBJ	0 445 124 024		F 00R J02 175
				07.17→	6	DBJ	0 445 124 052		F 00R J02 175
41.580	15,2	427	D 3876 LF07 <Euro 6/OBDC>	09.16-06.17	6	DBJ	0 445 124 024		F 00R J02 175
				09.16→	6	DBJ	0 445 124 024		F 00R J02 175
				07.17→	6	DBJ	0 445 124 052		F 00R J02 175
41.640	15,2	471	D 3876 LF03 <Euro 6>	10.15-06.17	6	DBJ	0 445 124 024		F 00R J02 175
				10.15→	6	DBJ	0 445 124 024		F 00R J02 175
				07.17→	6	DBJ	0 445 124 052		F 00R J02 175
			D 3876 LF09 <Euro 6/OBDC>	09.16-06.17	6	DBJ	0 445 124 024		F 00R J02 175
				09.16→	6	DBJ	0 445 124 024		F 00R J02 175
				07.17→	6	DBJ	0 445 124 052		F 00R J02 175
41.680	16,2	500	D 2868 LF03 <Euro 5/OBD1>; D 2868 LF06 <Euro 5/OBD2>	01.08→	8	DBJ	0 445 120 131	0 986 435 561	F 00R J02 175
<b>TRX</b>									
26.480	12,4	353	D 2676 LF25 <Euro 6>	10.12-06.16	6	DBJ	0 445 120 354	0 986 435 650	F 00R J02 175





**MAZ MINSK**

Serie 100										
103	7,1	161,5/ 169	D 260.5 E2 <Euro 2>; D 260.5 E3 <Euro 3>	01.02→	6	DBJ	0 445 120 141			
438043										
	4,8	130	D245.35 E4 <Euro 4>	12.11→	4	DBJ	0 445 120 245			
457043										
	4,8	115	D245.30 E3 <Euro 3>	01.08→	4	DBJ	0 445 120 141			

**MERCEDES-BENZ**

Actros									
1833 L,LS [963]	10,7	240	470.9... <OM470LA Euro 6>	07.12→	6	DBJ,TW	0 445 120 298	0 986 435 622	2 430 105 049
					6	DBJ,TW	0 445 120 303	0 986 435 646	2 430 105 049
1836 L,LS [963]	10,7	265	470.9... <OM470LA Euro 6>	07.12→	6	DBJ,TW	0 445 120 298	0 986 435 622	2 430 105 049
					6	DBJ,TW	0 445 120 303	0 986 435 646	2 430 105 049
								0 986 435 649	
1840 L,LS [963]	10,7	290	470.9... <OM470LA Euro 6>	07.12→	6	DBJ,TW	0 445 120 298	0 986 435 622	2 430 105 049
					6	DBJ,TW	0 445 120 303	0 986 435 646	2 430 105 049
								0 986 435 649	
1842 L,LS [963]	12,8	310	OM 471.9... <EEV, Euro 5/6>	09.11→	6	DBJ,TW	0 445 120 270	0 986 435 598	2 430 105 049
					6	DBJ,TW	0 445 120 287	0 986 435 624	2 430 105 049
					6	DBJ,TW	0 445 120 385	0 986 435 647	2 430 105 049
1843 L,LS [963]	10,7	315	470.9... <OM470LA Euro 6>	07.12→	6	DBJ,TW	0 445 120 298	0 986 435 622	2 430 105 049
					6	DBJ,TW	0 445 120 303	0 986 435 646	2 430 105 049
								0 986 435 649	
1845 L,LS [963]	12,8	330	OM 471.9... <EEV, Euro 5/6>	09.11→	6	DBJ,TW	0 445 120 270	0 986 435 598	2 430 105 049
					6	DBJ,TW	0 445 120 287	0 986 435 624	2 430 105 049
					6	DBJ,TW	0 445 120 385	0 986 435 647	2 430 105 049
1848 L,LS [963]	12,8	350	OM 471.9... <Euro 6>	09.11→	6	DBJ,TW	0 445 120 270	0 986 435 598	2 430 105 049
					6	DBJ,TW	0 445 120 287	0 986 435 624	2 430 105 049
					6	DBJ,TW	0 445 120 385	0 986 435 647	2 430 105 049
1851 L,LS [963]	12,8	375	OM 471.9... <EEV, Euro 5/6>	09.11→	6	DBJ,TW	0 445 120 270	0 986 435 598	2 430 105 049
					6	DBJ,TW	0 445 120 287	0 986 435 624	2 430 105 049
					6	DBJ,TW	0 445 120 385	0 986 435 647	2 430 105 049
1852 L,LS [963]	15,6	380	473.900 <OM473LA Euro 6>	10.13→	6	DBJ	0 445 120 300		2 430 105 049
1858 L,LS [963]	15,6	425	473.900 <OM473LA Euro 6>	10.13→	6	DBJ	0 445 120 300		2 430 105 049
1863 L,LS [963]	15,6	460	473.900 <OM473LA Euro 6>	10.13→	6	DBJ	0 445 120 300		2 430 105 049
2033 L,LS [963]	10,7	240	470.9... <OM470LA Euro 6>	07.12→	6	DBJ,TW	0 445 120 298	0 986 435 622	2 430 105 049
					6	DBJ,TW	0 445 120 303	0 986 435 646	2 430 105 049
								0 986 435 649	
2036 L,LS [963]	10,7	265	470.9... <OM470LA Euro 6>	03.13→	6	DBJ,TW	0 445 120 298	0 986 435 622	2 430 105 049
					6	DBJ,TW	0 445 120 303	0 986 435 646	2 430 105 049
								0 986 435 649	
2040 L,LS [963]	10,7	290	470.9... <OM470LA Euro 6>	03.13→	6	DBJ,TW	0 445 120 298	0 986 435 622	2 430 105 049
					6	DBJ,TW	0 445 120 303	0 986 435 646	2 430 105 049
								0 986 435 649	
2042 L,LS [963]	12,8	310	OM 471.9...	03.13→	6	DBJ,TW	0 445 120 270	0 986 435 598	2 430 105 049
					6	DBJ,TW	0 445 120 287	0 986 435 624	2 430 105 049
					6	DBJ,TW	0 445 120 385	0 986 435 647	2 430 105 049
2043 L,LS [963]	10,7	315	470.9... <OM470LA Euro 6>	03.13→	6	DBJ,TW	0 445 120 298	0 986 435 622	2 430 105 049
					6	DBJ,TW	0 445 120 303	0 986 435 646	2 430 105 049
								0 986 435 649	
2045 L,LS [963]	12,8	330	OM 471.9...	09.11→	6	DBJ,TW	0 445 120 270	0 986 435 598	2 430 105 049
					6	DBJ,TW	0 445 120 287	0 986 435 624	2 430 105 049
					6	DBJ,TW	0 445 120 385	0 986 435 647	2 430 105 049
2048 L,LS [963]	12,8	350	OM 471.90... <Euro 6>	03.13→	6	DBJ,TW	0 445 120 270	0 986 435 598	2 430 105 049
					6	DBJ,TW	0 445 120 287	0 986 435 624	2 430 105 049
					6	DBJ,TW	0 445 120 385	0 986 435 647	2 430 105 049





2051 L,LS [963]	12,8	375	OM 471.90... <Euro 6>	09.11→	6	DBJ,TW	0 445 120 270	0 986 435 598	2 430 105 049
					6	DBJ,TW	0 445 120 287	0 986 435 624	2 430 105 049
					6	DBJ,TW	0 445 120 385	0 986 435 647	2 430 105 049
2052 L,LS [963]	15,6	380	473.900 <OM473LA Euro 6>	12.13→	6	DBJ	0 445 120 300		2 430 105 049
2058 L,LS [963]	15,6	425	473.900 <OM473LA Euro 6>	12.13→	6	DBJ	0 445 120 300		2 430 105 049
2063 L,LS [963]	15,6	460	473.900 <OM473LA Euro 6>	12.13→	6	DBJ	0 445 120 300		2 430 105 049
2433 LS [963]	10,7	240	470.9... <OM470LA Euro 6>	07.12→	6	DBJ,TW	0 445 120 298	0 986 435 622	2 430 105 049
					6	DBJ,TW	0 445 120 303	0 986 435 646	2 430 105 049
2436 LS [963]	10,7	265	470.9... <OM470LA Euro 6>	07.12→	6	DBJ,TW	0 445 120 298	0 986 435 622	2 430 105 049
					6	DBJ,TW	0 445 120 303	0 986 435 646	2 430 105 049
							0 986 435 649		
2440 LS [963]	10,7	290	470.9... <OM470LA Euro 6>	07.12→	6	DBJ,TW	0 445 120 298	0 986 435 622	2 430 105 049
					6	DBJ,TW	0 445 120 303	0 986 435 646	2 430 105 049
							0 986 435 649		
2442 LS [963]	12,8	310	OM 471.9... <Euro 6>	07.12→	6	DBJ,TW	0 445 120 270	0 986 435 598	2 430 105 049
					6	DBJ,TW	0 445 120 287	0 986 435 624	2 430 105 049
					6	DBJ,TW	0 445 120 385	0 986 435 647	2 430 105 049
2443 LS [963]	10,7	315	470.9... <OM470LA Euro 6>	07.12→	6	DBJ,TW	0 445 120 298	0 986 435 622	2 430 105 049
					6	DBJ,TW	0 445 120 303	0 986 435 646	2 430 105 049
							0 986 435 649		
2445 LS [963]	12,8	330	OM 471.9... <Euro 6>	07.12→	6	DBJ,TW	0 445 120 270	0 986 435 598	2 430 105 049
					6	DBJ,TW	0 445 120 287	0 986 435 624	2 430 105 049
					6	DBJ,TW	0 445 120 385	0 986 435 647	2 430 105 049
2448 LS [963]	12,8	350	OM 471.9... <Euro 6>	07.12→	6	DBJ,TW	0 445 120 270	0 986 435 598	2 430 105 049
					6	DBJ,TW	0 445 120 287	0 986 435 624	2 430 105 049
					6	DBJ,TW	0 445 120 385	0 986 435 647	2 430 105 049
2451 LS [963]	12,8	375	OM 471.9... <Euro 6>	07.12→	6	DBJ,TW	0 445 120 270	0 986 435 598	2 430 105 049
					6	DBJ,TW	0 445 120 287	0 986 435 624	2 430 105 049
					6	DBJ,TW	0 445 120 385	0 986 435 647	2 430 105 049
2452 LS [963]	15,6	380	473.900 <OM473LA Euro 6>	12.13→	6	DBJ	0 445 120 300		2 430 105 049
2458 LS [963]	15,6	425	473.900 <OM473LA Euro 6>	12.13→	6	DBJ	0 445 120 300		2 430 105 049
2463 LS [963]	15,6	460	473.900 <OM473LA Euro 6>	12.13→	6	DBJ	0 445 120 300		2 430 105 049
2533 L,LS [963]	10,7	240	470.9... <OM470LA Euro 6>	07.12→	6	DBJ,TW	0 445 120 298	0 986 435 622	2 430 105 049
					6	DBJ,TW	0 445 120 303	0 986 435 646	2 430 105 049
2536 L,LS [963]	10,7	265	470.9... <OM470LA Euro 6>	07.12→	6	DBJ,TW	0 445 120 298	0 986 435 622	2 430 105 049
					6	DBJ,TW	0 445 120 303	0 986 435 646	2 430 105 049
							0 986 435 649		
2540 L,LS [963]	10,7	290	470.9... <OM470LA Euro 6>	07.12→	6	DBJ,TW	0 445 120 298	0 986 435 622	2 430 105 049
					6	DBJ,TW	0 445 120 303	0 986 435 646	2 430 105 049
							0 986 435 649		
2542 L,LS [963]	12,8	310	OM 471.9... <EEV, Euro 5/6>	09.11→	6	DBJ,TW	0 445 120 270	0 986 435 598	2 430 105 049
					6	DBJ,TW	0 445 120 287	0 986 435 624	2 430 105 049
					6	DBJ,TW	0 445 120 385	0 986 435 647	2 430 105 049
2543 L,LS [963]	10,7	315	470.9... <OM470LA Euro 6>	07.12→	6	DBJ,TW	0 445 120 298	0 986 435 622	2 430 105 049
					6	DBJ,TW	0 445 120 303	0 986 435 646	2 430 105 049
							0 986 435 649		
2545 L,LS [963]	12,8	330	OM 471.9... <EEV, Euro 5/6>	09.11→	6	DBJ,TW	0 445 120 270	0 986 435 598	2 430 105 049
					6	DBJ,TW	0 445 120 287	0 986 435 624	2 430 105 049
					6	DBJ,TW	0 445 120 385	0 986 435 647	2 430 105 049
2548 L,LS [963]	12,8	350	OM 471.9... <Euro 6>	09.11→	6	DBJ,TW	0 445 120 270	0 986 435 598	2 430 105 049
					6	DBJ,TW	0 445 120 287	0 986 435 624	2 430 105 049
					6	DBJ,TW	0 445 120 385	0 986 435 647	2 430 105 049
2551 L,LS [963]	12,8	375	OM 471.9... <EEV, Euro 5/6>	09.11→	6	DBJ,TW	0 445 120 270	0 986 435 598	2 430 105 049
					6	DBJ,TW	0 445 120 287	0 986 435 624	2 430 105 049
					6	DBJ,TW	0 445 120 385	0 986 435 647	2 430 105 049
2552 L,LS [963]	15,6	380	473.900 <OM473LA Euro 6>	12.13→	6	DBJ	0 445 120 300		2 430 105 049
2558 L,LS [963]	15,6	425	473.900 <OM473LA Euro 6>	12.13→	6	DBJ	0 445 120 300		2 430 105 049
2563 L,LS [963]	15,6	460	473.900 <OM473LA Euro 6>	12.13→	6	DBJ	0 445 120 300		2 430 105 049
2633 L,LS [963]	10,7	240	470.9... <OM470LA Euro 6>	07.12→	6	DBJ,TW	0 445 120 298	0 986 435 622	2 430 105 049
					6	DBJ,TW	0 445 120 303	0 986 435 646	2 430 105 049
							0 986 435 649		





◀ MERCEDES-BENZ

2636 L,LS [963]	10,7	265	470.9... <OM470LA Euro 6>	07.12→	6	DBJ,TW	0 445 120 298	0 986 435 622	2 430 105 049
					6	DBJ,TW	0 445 120 303	0 986 435 646	2 430 105 049
					0 986 435 649				
2640 L,LS [963]	10,7	290	470.9... <OM470LA Euro 6>	07.12→	6	DBJ,TW	0 445 120 298	0 986 435 622	2 430 105 049
					6	DBJ,TW	0 445 120 303	0 986 435 646	2 430 105 049
					0 986 435 649				
2642 L,LS [963]	12,8	310	OM 471.9... <Euro 6>	07.12→	6	DBJ,TW	0 445 120 270	0 986 435 598	2 430 105 049
					6	DBJ,TW	0 445 120 287	0 986 435 624	2 430 105 049
					6	DBJ,TW	0 445 120 385	0 986 435 647	2 430 105 049
2643 L,LS [963]	10,7	315	470.9... <OM470LA Euro 6>	07.12→	6	DBJ,TW	0 445 120 298	0 986 435 622	2 430 105 049
					6	DBJ,TW	0 445 120 303	0 986 435 646	2 430 105 049
					0 986 435 649				
2645 L,LS [963]	12,8	330	OM 471.9... <Euro 6>	07.12→	6	DBJ,TW	0 445 120 270	0 986 435 598	2 430 105 049
					6	DBJ,TW	0 445 120 287	0 986 435 624	2 430 105 049
					6	DBJ,TW	0 445 120 385	0 986 435 647	2 430 105 049
2648 L,LS [963]	12,8	350	OM 471.9... <Euro 6>	07.12→	6	DBJ,TW	0 445 120 270	0 986 435 598	2 430 105 049
					6	DBJ,TW	0 445 120 287	0 986 435 624	2 430 105 049
					6	DBJ,TW	0 445 120 385	0 986 435 647	2 430 105 049
2651 L,LS [963]	12,8	375	OM 471.9...	09.11→	6	DBJ,TW	0 445 120 270	0 986 435 598	2 430 105 049
					6	DBJ,TW	0 445 120 287	0 986 435 624	2 430 105 049
					6	DBJ,TW	0 445 120 385	0 986 435 647	2 430 105 049
2652 L,LS [963]	15,6	380	473.900 <OM473LA Euro 6>	12.13→	6	DBJ	0 445 120 300		2 430 105 049
2658 L,LS [963]	15,6	425	473.900 <OM473LA Euro 6>	12.13→	6	DBJ	0 445 120 300		2 430 105 049
2663 L,LS [963]	15,6	460	473.900 <OM473LA Euro 6>	12.13→	6	DBJ	0 445 120 300		2 430 105 049
3333 L,LS [963]	10,7	240	470.9... <OM470LA Euro 6>	03.13→	6	DBJ,TW	0 445 120 298	0 986 435 622	2 430 105 049
					6	DBJ,TW	0 445 120 303	0 986 435 646	2 430 105 049
					0 986 435 649				
3336 L,LS [963]	10,7	265	470.9... <OM470LA Euro 6>	03.13→	6	DBJ,TW	0 445 120 298	0 986 435 622	2 430 105 049
					6	DBJ,TW	0 445 120 303	0 986 435 646	2 430 105 049
					0 986 435 649				
3340 L,LS [963]	10,7	290	470.9... <OM470LA Euro 6>	03.13→	6	DBJ,TW	0 445 120 298	0 986 435 622	2 430 105 049
					6	DBJ,TW	0 445 120 303	0 986 435 646	2 430 105 049
					0 986 435 649				
3342 L,LS [963]	12,8	310	OM 471.9...	03.13→	6	DBJ,TW	0 445 120 270	0 986 435 598	2 430 105 049
					6	DBJ,TW	0 445 120 287	0 986 435 624	2 430 105 049
					6	DBJ,TW	0 445 120 385	0 986 435 647	2 430 105 049
3343 L,LS [963]	10,7	315	470.9... <OM470LA Euro 6>	03.13→	6	DBJ,TW	0 445 120 298	0 986 435 622	2 430 105 049
					6	DBJ,TW	0 445 120 303	0 986 435 646	2 430 105 049
					0 986 435 649				
3345 L,LS [963]	12,8	330	OM 471.9...	03.13→	6	DBJ,TW	0 445 120 270	0 986 435 598	2 430 105 049
					6	DBJ,TW	0 445 120 287	0 986 435 624	2 430 105 049
					6	DBJ,TW	0 445 120 385	0 986 435 647	2 430 105 049
3348 L,LS [963]	12,8	350	OM 471.9...	03.13→	6	DBJ,TW	0 445 120 270	0 986 435 598	2 430 105 049
					6	DBJ,TW	0 445 120 287	0 986 435 624	2 430 105 049
					6	DBJ,TW	0 445 120 385	0 986 435 647	2 430 105 049
3351 L,LS [963]	12,8	375	OM 471.9... <EEV, Euro 5/6>	03.13→	6	DBJ,TW	0 445 120 270	0 986 435 598	2 430 105 049
					6	DBJ,TW	0 445 120 287	0 986 435 624	2 430 105 049
					6	DBJ,TW	0 445 120 385	0 986 435 647	2 430 105 049
3352 L,LS [963]	15,6	380	473.900 <OM473LA Euro 6>	03.13→	6	DBJ	0 445 120 300		2 430 105 049
3358 L,LS [963]	15,6	425	473.900 <OM473LA Euro 6>	03.13→	6	DBJ	0 445 120 300		2 430 105 049
3363 L,LS [963]	15,6	460	473.900 <OM473LA Euro 6>	03.13→	6	DBJ	0 445 120 300		2 430 105 049
<b>Antos</b>									
1833 L,LS	10,7	240	470.9... <OM470LA Euro 6>	09.12→	6	DBJ,TW	0 445 120 298	0 986 435 622	2 430 105 049
					6	DBJ,TW	0 445 120 303	0 986 435 646	2 430 105 049
					0 986 435 649				
1836 L,LS	10,7	265	470.9... <OM470LA Euro 6>	09.12→	6	DBJ,TW	0 445 120 298	0 986 435 622	2 430 105 049
					6	DBJ,TW	0 445 120 303	0 986 435 646	2 430 105 049
					0 986 435 649				
1840 L,LS	10,7	290	470.9... <OM470LA Euro 6>	09.12→	6	DBJ,TW	0 445 120 298	0 986 435 622	2 430 105 049
					6	DBJ,TW	0 445 120 303	0 986 435 646	2 430 105 049
					0 986 435 649				







1842 L,LS	12,8	310	OM 471.9...	09.12→	6 DBJ,TW	0 445 120 270	0 986 435 598	2 430 105 049
					6 DBJ,TW	0 445 120 287	0 986 435 624	2 430 105 049
					6 DBJ,TW	0 445 120 385	0 986 435 647	2 430 105 049
1843 L,LS	10,7	315	470.9... <OM470LA Euro 6>	09.12→	6 DBJ,TW	0 445 120 298	0 986 435 622	2 430 105 049
					6 DBJ,TW	0 445 120 303	0 986 435 646	2 430 105 049
							0 986 435 649	
1845 L,LS	12,8	330	OM 471.9...	09.12→	6 DBJ,TW	0 445 120 270	0 986 435 598	2 430 105 049
					6 DBJ,TW	0 445 120 287	0 986 435 624	2 430 105 049
					6 DBJ,TW	0 445 120 385	0 986 435 647	2 430 105 049
1848 L,LS	12,8	350	OM 471.9...	09.12→	6 DBJ,TW	0 445 120 270	0 986 435 598	2 430 105 049
					6 DBJ,TW	0 445 120 287	0 986 435 624	2 430 105 049
					6 DBJ,TW	0 445 120 385	0 986 435 647	2 430 105 049
1851 L,LS	12,8	375	OM 471.9... <Euro 6>	09.12→	6 DBJ,TW	0 445 120 270	0 986 435 598	2 430 105 049
					6 DBJ,TW	0 445 120 287	0 986 435 624	2 430 105 049
					6 DBJ,TW	0 445 120 385	0 986 435 647	2 430 105 049
1852 L,LS	15,6	380	473.900 <OM473LA Euro 6>	10.13→	6 DBJ	0 445 120 300		2 430 105 049
1858 L,LS	15,6	425	473.900 <OM473LA Euro 6>	10.13→	6 DBJ	0 445 120 300		2 430 105 049
1863 L,LS	15,6	460	473.900 <OM473LA Euro 6>	10.13→	6 DBJ	0 445 120 300		2 430 105 049
2033 L,LS	10,7	240	470.9... <OM470LA Euro 6>	03.13→	6 DBJ,TW	0 445 120 298	0 986 435 622	2 430 105 049
					6 DBJ,TW	0 445 120 303	0 986 435 646	2 430 105 049
							0 986 435 649	
2036 L,LS	10,7	265	470.9... <OM470LA Euro 6>	03.13→	6 DBJ,TW	0 445 120 298	0 986 435 622	2 430 105 049
					6 DBJ,TW	0 445 120 303	0 986 435 646	2 430 105 049
							0 986 435 649	
2040 L,LS	10,7	290	470.9... <OM470LA Euro 6>	03.13→	6 DBJ,TW	0 445 120 298	0 986 435 622	2 430 105 049
					6 DBJ,TW	0 445 120 303	0 986 435 646	2 430 105 049
							0 986 435 649	
2042 L,LS	12,8	310	OM 471.9...	03.13→	6 DBJ,TW	0 445 120 270	0 986 435 598	2 430 105 049
					6 DBJ,TW	0 445 120 287	0 986 435 624	2 430 105 049
					6 DBJ,TW	0 445 120 385	0 986 435 647	2 430 105 049
2043 L,LS	10,7	315	470.9... <OM470LA Euro 6>	03.13→	6 DBJ,TW	0 445 120 298	0 986 435 622	2 430 105 049
					6 DBJ,TW	0 445 120 303	0 986 435 646	2 430 105 049
							0 986 435 649	
2045 L,LS	12,8	330	OM 471.9...	03.13→	6 DBJ,TW	0 445 120 270	0 986 435 598	2 430 105 049
					6 DBJ,TW	0 445 120 287	0 986 435 624	2 430 105 049
					6 DBJ,TW	0 445 120 385	0 986 435 647	2 430 105 049
2048 L,LS	12,8	350	OM 471.9...	03.13→	6 DBJ,TW	0 445 120 270	0 986 435 598	2 430 105 049
					6 DBJ,TW	0 445 120 287	0 986 435 624	2 430 105 049
					6 DBJ,TW	0 445 120 385	0 986 435 647	2 430 105 049
2051 L,LS	12,8	375	OM 471.9...	03.13→	6 DBJ,TW	0 445 120 270	0 986 435 598	2 430 105 049
					6 DBJ,TW	0 445 120 287	0 986 435 624	2 430 105 049
					6 DBJ,TW	0 445 120 385	0 986 435 647	2 430 105 049
2052 L,LS	15,6	380	473.900 <OM473LA Euro 6>	12.13→	6 DBJ	0 445 120 300		2 430 105 049
2058 L,LS	15,6	425	473.900 <OM473LA Euro 6>	12.13→	6 DBJ	0 445 120 300		2 430 105 049
2063 L,LS	15,6	460	473.900 <OM473LA Euro 6>	12.13→	6 DBJ	0 445 120 300		2 430 105 049
2433 LS	10,7	240	470.9... <OM470LA Euro 6>	09.12→	6 DBJ,TW	0 445 120 298	0 986 435 622	2 430 105 049
					6 DBJ,TW	0 445 120 303	0 986 435 646	2 430 105 049
							0 986 435 649	
2436 LS	10,7	265	470.9... <OM470LA Euro 6>	09.12→	6 DBJ,TW	0 445 120 298	0 986 435 622	2 430 105 049
					6 DBJ,TW	0 445 120 303	0 986 435 646	2 430 105 049
							0 986 435 649	
2440 LS	10,7	290	470.9... <OM470LA Euro 6>	09.12→	6 DBJ,TW	0 445 120 298	0 986 435 622	2 430 105 049
					6 DBJ,TW	0 445 120 303	0 986 435 646	2 430 105 049
							0 986 435 649	
2442 LS	12,8	310	OM 471.9...	09.12→	6 DBJ,TW	0 445 120 270	0 986 435 598	2 430 105 049
					6 DBJ,TW	0 445 120 287	0 986 435 624	2 430 105 049
					6 DBJ,TW	0 445 120 385	0 986 435 647	2 430 105 049
2443 LS	10,7	315	470.9... <OM470LA Euro 6>	09.12→	6 DBJ,TW	0 445 120 298	0 986 435 622	2 430 105 049
					6 DBJ,TW	0 445 120 303	0 986 435 646	2 430 105 049
							0 986 435 649	
2445 LS	12,8	330	OM 471.9...	09.12→	6 DBJ,TW	0 445 120 270	0 986 435 598	2 430 105 049
					6 DBJ,TW	0 445 120 287	0 986 435 624	2 430 105 049
					6 DBJ,TW	0 445 120 385	0 986 435 647	2 430 105 049







◀ MERCEDES-BENZ

2448 LS	12,8	350	OM 471.9...	09.12→	6 DBJ,TW	0 445 120 270	0 986 435 598	2 430 105 049
					6 DBJ,TW	0 445 120 287	0 986 435 624	2 430 105 049
					6 DBJ,TW	0 445 120 385	0 986 435 647	2 430 105 049
2451 LS	12,8	375	OM 471.9...	09.12→	6 DBJ,TW	0 445 120 270	0 986 435 598	2 430 105 049
					6 DBJ,TW	0 445 120 287	0 986 435 624	2 430 105 049
					6 DBJ,TW	0 445 120 385	0 986 435 647	2 430 105 049
2452 LS	15,6	380	473.900 <OM473LA Euro 6>	12.13→	6 DBJ	0 445 120 300		2 430 105 049
2458 LS	15,6	425	473.900 <OM473LA Euro 6>	12.13→	6 DBJ	0 445 120 300		2 430 105 049
2463 LS	15,6	460	473.900 <OM473LA Euro 6>	12.13→	6 DBJ	0 445 120 300		2 430 105 049
2533 L,LS	10,7	240	470.9... <OM470LA Euro 6>	09.12→	6 DBJ,TW	0 445 120 298	0 986 435 622	2 430 105 049
					6 DBJ,TW	0 445 120 303	0 986 435 646	2 430 105 049
2536 L,LS	10,7	265	470.9... <OM470LA Euro 6>	09.12→	6 DBJ,TW	0 445 120 298	0 986 435 622	2 430 105 049
					6 DBJ,TW	0 445 120 303	0 986 435 646	2 430 105 049
							0 986 435 649	
2540 L,LS	10,7	290	470.9... <OM470LA Euro 6>	09.12→	6 DBJ,TW	0 445 120 298	0 986 435 622	2 430 105 049
					6 DBJ,TW	0 445 120 303	0 986 435 646	2 430 105 049
2542 L,LS	12,8	310	OM 471.9...	09.12→	6 DBJ,TW	0 445 120 270	0 986 435 598	2 430 105 049
					6 DBJ,TW	0 445 120 287	0 986 435 624	2 430 105 049
					6 DBJ,TW	0 445 120 385	0 986 435 647	2 430 105 049
2543 L,LS	10,7	315	470.9... <OM470LA Euro 6>	09.12→	6 DBJ,TW	0 445 120 298	0 986 435 622	2 430 105 049
					6 DBJ,TW	0 445 120 303	0 986 435 646	2 430 105 049
2545 L,LS	12,8	330	OM 471.9...	09.12→	6 DBJ,TW	0 445 120 270	0 986 435 598	2 430 105 049
					6 DBJ,TW	0 445 120 287	0 986 435 624	2 430 105 049
					6 DBJ,TW	0 445 120 385	0 986 435 647	2 430 105 049
2548 L,LS	12,8	350	OM 471.9...	09.12→	6 DBJ,TW	0 445 120 270	0 986 435 598	2 430 105 049
					6 DBJ,TW	0 445 120 287	0 986 435 624	2 430 105 049
					6 DBJ,TW	0 445 120 385	0 986 435 647	2 430 105 049
2551 L,LS	12,8	350-375	OM 471.9...	09.12→	6 DBJ,TW	0 445 120 270	0 986 435 598	2 430 105 049
					6 DBJ,TW	0 445 120 287	0 986 435 624	2 430 105 049
					6 DBJ,TW	0 445 120 385	0 986 435 647	2 430 105 049
2552 L,LS	15,6	380	473.900 <OM473LA Euro 6>	12.13→	6 DBJ	0 445 120 300		2 430 105 049
2558 L,LS	15,6	425	473.900 <OM473LA Euro 6>	12.13→	6 DBJ	0 445 120 300		2 430 105 049
2563 L,LS	15,6	460	473.900 <OM473LA Euro 6>	12.13→	6 DBJ	0 445 120 300		2 430 105 049
2633 L,LS	10,7	240	470.9... <OM470LA Euro 6>	09.12→	6 DBJ,TW	0 445 120 298	0 986 435 622	2 430 105 049
					6 DBJ,TW	0 445 120 303	0 986 435 646	2 430 105 049
2636 L,LS	10,7	265	470.9... <OM470LA Euro 6>	09.12→	6 DBJ,TW	0 445 120 298	0 986 435 622	2 430 105 049
					6 DBJ,TW	0 445 120 303	0 986 435 646	2 430 105 049
							0 986 435 649	
2640 L,LS	10,7	290	470.9... <OM470LA Euro 6>	09.12→	6 DBJ,TW	0 445 120 298	0 986 435 622	2 430 105 049
					6 DBJ,TW	0 445 120 303	0 986 435 646	2 430 105 049
2642 L,LS	12,8	310	OM 471.9...	09.12→	6 DBJ,TW	0 445 120 270	0 986 435 598	2 430 105 049
					6 DBJ,TW	0 445 120 287	0 986 435 624	2 430 105 049
					6 DBJ,TW	0 445 120 385	0 986 435 647	2 430 105 049
2643 L,LS	10,7	315	470.9... <OM470LA Euro 6>	09.12→	6 DBJ,TW	0 445 120 298	0 986 435 622	2 430 105 049
					6 DBJ,TW	0 445 120 303	0 986 435 646	2 430 105 049
2645 L,LS	12,8	330	OM 471.9...	09.12→	6 DBJ,TW	0 445 120 270	0 986 435 598	2 430 105 049
					6 DBJ,TW	0 445 120 287	0 986 435 624	2 430 105 049
					6 DBJ,TW	0 445 120 385	0 986 435 647	2 430 105 049
2648 L,LS	12,8	350	OM 471.9...	09.12→	6 DBJ,TW	0 445 120 270	0 986 435 598	2 430 105 049
					6 DBJ,TW	0 445 120 287	0 986 435 624	2 430 105 049
					6 DBJ,TW	0 445 120 385	0 986 435 647	2 430 105 049
2651 L,LS	12,8	375	OM 471.9...	09.12→	6 DBJ,TW	0 445 120 270	0 986 435 598	2 430 105 049
					6 DBJ,TW	0 445 120 287	0 986 435 624	2 430 105 049
					6 DBJ,TW	0 445 120 385	0 986 435 647	2 430 105 049
2652 L,LS	15,6	380	473.900 <OM473LA Euro 6>	12.13→	6 DBJ	0 445 120 300		2 430 105 049
2658 L,LS	15,6	425	473.900 <OM473LA Euro 6>	12.13→	6 DBJ	0 445 120 300		2 430 105 049
2663 L,LS	15,6	460	473.900 <OM473LA Euro 6>	12.13→	6 DBJ	0 445 120 300		2 430 105 049





3333 L,LS	10,7	240	470.9... <OM470LA Euro 6>	03.13→	6 DBJ,TW	0 445 120 298	0 986 435 622	2 430 105 049
					6 DBJ,TW	0 445 120 303	0 986 435 646	2 430 105 049
0 986 435 649								
3336 L,LS	10,7	265	470.9... <OM470LA Euro 6>	03.13→	6 DBJ,TW	0 445 120 298	0 986 435 622	2 430 105 049
					6 DBJ,TW	0 445 120 303	0 986 435 646	2 430 105 049
0 986 435 649								
3340 L,LS	10,7	290	470.9... <OM470LA Euro 6>	03.13→	6 DBJ,TW	0 445 120 298	0 986 435 622	2 430 105 049
					6 DBJ,TW	0 445 120 303	0 986 435 646	2 430 105 049
0 986 435 649								
3342 L,LS	12,8	310	OM 471.9...	03.13→	6 DBJ,TW	0 445 120 270	0 986 435 598	2 430 105 049
					6 DBJ,TW	0 445 120 287	0 986 435 624	2 430 105 049
					6 DBJ,TW	0 445 120 385	0 986 435 647	2 430 105 049
3343 L,LS	10,7	315	470.9... <OM470LA Euro 6>	03.13→	6 DBJ,TW	0 445 120 298	0 986 435 622	2 430 105 049
					6 DBJ,TW	0 445 120 303	0 986 435 646	2 430 105 049
0 986 435 649								
3345 L,LS	12,8	330	OM 471.9...	03.13→	6 DBJ,TW	0 445 120 270	0 986 435 598	2 430 105 049
					6 DBJ,TW	0 445 120 287	0 986 435 624	2 430 105 049
					6 DBJ,TW	0 445 120 385	0 986 435 647	2 430 105 049
3348 L,LS	12,8	350	OM 471.9...	03.13→	6 DBJ,TW	0 445 120 270	0 986 435 598	2 430 105 049
					6 DBJ,TW	0 445 120 287	0 986 435 624	2 430 105 049
					6 DBJ,TW	0 445 120 385	0 986 435 647	2 430 105 049
3351 L,LS	12,8	375	OM 471.9...	03.13→	6 DBJ,TW	0 445 120 270	0 986 435 598	2 430 105 049
					6 DBJ,TW	0 445 120 287	0 986 435 624	2 430 105 049
					6 DBJ,TW	0 445 120 385	0 986 435 647	2 430 105 049
3352 L,LS	15,6	380	473.900 <OM473LA Euro 6>	03.13→	6 DBJ	0 445 120 300		2 430 105 049
3358 L,LS	15,6	425	473.900 <OM473LA Euro 6>	03.13→	6 DBJ	0 445 120 300		2 430 105 049
3363 L,LS	15,6	460	473.900 <OM473LA Euro 6>	03.13→	6 DBJ	0 445 120 300		2 430 105 049
<b>Arocs</b>								
1833 [964]	10,7	240	470.9... <OM470LA Euro 6>	04.13→	6 DBJ,TW	0 445 120 298	0 986 435 622	2 430 105 049
					6 DBJ,TW	0 445 120 303	0 986 435 646	2 430 105 049
0 986 435 649								
1836 [964]	10,7	265	470.9... <OM470LA Euro 6>	04.13→	6 DBJ,TW	0 445 120 298	0 986 435 622	2 430 105 049
					6 DBJ,TW	0 445 120 303	0 986 435 646	2 430 105 049
0 986 435 649								
1840 [964]	10,7	290	470.9... <OM470LA Euro 6>	04.13→	6 DBJ,TW	0 445 120 298	0 986 435 622	2 430 105 049
					6 DBJ,TW	0 445 120 303	0 986 435 646	2 430 105 049
0 986 435 649								
1842 [964]	12,8	310	OM 471.9...	04.13→	6 DBJ,TW	0 445 120 270	0 986 435 598	2 430 105 049
					6 DBJ,TW	0 445 120 287	0 986 435 624	2 430 105 049
					6 DBJ,TW	0 445 120 385	0 986 435 647	2 430 105 049
1843 [964]	10,7	315	470.9... <OM470LA Euro 6>	04.13→	6 DBJ,TW	0 445 120 298	0 986 435 622	2 430 105 049
					6 DBJ,TW	0 445 120 303	0 986 435 646	2 430 105 049
0 986 435 649								
1845 [964]	12,8	330	OM 471.9...	04.13→	6 DBJ,TW	0 445 120 270	0 986 435 598	2 430 105 049
					6 DBJ,TW	0 445 120 287	0 986 435 624	2 430 105 049
					6 DBJ,TW	0 445 120 385	0 986 435 647	2 430 105 049
1848 [964]	12,8	350	OM 471.9...	04.13→	6 DBJ,TW	0 445 120 270	0 986 435 598	2 430 105 049
					6 DBJ,TW	0 445 120 287	0 986 435 624	2 430 105 049
					6 DBJ,TW	0 445 120 385	0 986 435 647	2 430 105 049
1851 [964]	12,8	375	OM 471.9...	04.13→	6 DBJ,TW	0 445 120 270	0 986 435 598	2 430 105 049
					6 DBJ,TW	0 445 120 287	0 986 435 624	2 430 105 049
					6 DBJ,TW	0 445 120 385	0 986 435 647	2 430 105 049
1852 [964]	15,6	380	473.900 <OM473LA Euro 6>	04.13→	6 DBJ	0 445 120 300		2 430 105 049
1858 [964]	15,6	425	473.900 <OM473LA Euro 6>	04.13→	6 DBJ	0 445 120 300		2 430 105 049
1863 [964]	15,6	460	473.900 <OM473LA Euro 6>	04.13→	6 DBJ	0 445 120 300		2 430 105 049
2033 [964]	10,7	240	470.9... <OM470LA Euro 6>	04.13→	6 DBJ,TW	0 445 120 298	0 986 435 622	2 430 105 049
					6 DBJ,TW	0 445 120 303	0 986 435 646	2 430 105 049
0 986 435 649								
2036 [964]	10,7	265	470.9... <OM470LA Euro 6>	04.13→	6 DBJ,TW	0 445 120 298	0 986 435 622	2 430 105 049
					6 DBJ,TW	0 445 120 303	0 986 435 646	2 430 105 049
0 986 435 649								









◀ MERCEDES-BENZ

<b>3352</b> [964]	15,6	380	473.900 <OM473LA Euro 6>	04.13→	6	DBJ	<b>0 445 120 300</b>		<b>2 430 105 049</b>
<b>3358</b> [964]	15,6	425	473.900 <OM473LA Euro 6>	04.13→	6	DBJ	<b>0 445 120 300</b>		<b>2 430 105 049</b>
<b>3363</b> [964]	15,6	460	473.900 <OM473LA Euro 6>	04.13→	6	DBJ	<b>0 445 120 300</b>		<b>2 430 105 049</b>
<b>4133</b> [964]	10,7	240	470.9... <OM470LA Euro 6>	04.13→	6	DBJ,TW	<b>0 445 120 298</b>	<b>0 986 435 622</b>	<b>2 430 105 049</b>
					6	DBJ,TW	<b>0 445 120 303</b>	<b>0 986 435 646</b>	<b>2 430 105 049</b>
								<b>0 986 435 649</b>	
<b>4136</b> [964]	10,7	265	470.9... <OM470LA Euro 6>	04.13→	6	DBJ,TW	<b>0 445 120 298</b>	<b>0 986 435 622</b>	<b>2 430 105 049</b>
					6	DBJ,TW	<b>0 445 120 303</b>	<b>0 986 435 646</b>	<b>2 430 105 049</b>
								<b>0 986 435 649</b>	
<b>4140</b> [964]	10,7	290	470.9... <OM470LA Euro 6>	04.13→	6	DBJ,TW	<b>0 445 120 298</b>	<b>0 986 435 622</b>	<b>2 430 105 049</b>
					6	DBJ,TW	<b>0 445 120 303</b>	<b>0 986 435 646</b>	<b>2 430 105 049</b>
								<b>0 986 435 649</b>	
<b>4142</b> [964]	12,8	310	OM 471.9...	04.13→	6	DBJ,TW	<b>0 445 120 270</b>	<b>0 986 435 598</b>	<b>2 430 105 049</b>
					6	DBJ,TW	<b>0 445 120 287</b>	<b>0 986 435 624</b>	<b>2 430 105 049</b>
					6	DBJ,TW	<b>0 445 120 385</b>	<b>0 986 435 647</b>	<b>2 430 105 049</b>
<b>4143</b> [964]	10,7	315	470.9... <OM470LA Euro 6>	04.13→	6	DBJ,TW	<b>0 445 120 298</b>	<b>0 986 435 622</b>	<b>2 430 105 049</b>
					6	DBJ,TW	<b>0 445 120 303</b>	<b>0 986 435 646</b>	<b>2 430 105 049</b>
								<b>0 986 435 649</b>	
<b>4145</b> [964]	12,8	330	OM 471.9...	04.13→	6	DBJ,TW	<b>0 445 120 270</b>	<b>0 986 435 598</b>	<b>2 430 105 049</b>
					6	DBJ,TW	<b>0 445 120 287</b>	<b>0 986 435 624</b>	<b>2 430 105 049</b>
					6	DBJ,TW	<b>0 445 120 385</b>	<b>0 986 435 647</b>	<b>2 430 105 049</b>
<b>4148</b> [964]	12,8	350	OM 471.9...	04.13→	6	DBJ,TW	<b>0 445 120 270</b>	<b>0 986 435 598</b>	<b>2 430 105 049</b>
					6	DBJ,TW	<b>0 445 120 287</b>	<b>0 986 435 624</b>	<b>2 430 105 049</b>
					6	DBJ,TW	<b>0 445 120 385</b>	<b>0 986 435 647</b>	<b>2 430 105 049</b>
<b>4151</b> [964]	12,8	375	OM 471.9...	04.13→	6	DBJ,TW	<b>0 445 120 270</b>	<b>0 986 435 598</b>	<b>2 430 105 049</b>
					6	DBJ,TW	<b>0 445 120 287</b>	<b>0 986 435 624</b>	<b>2 430 105 049</b>
					6	DBJ,TW	<b>0 445 120 385</b>	<b>0 986 435 647</b>	<b>2 430 105 049</b>
<b>4152</b> [964]	15,6	380	473.900 <OM473LA Euro 6>	04.13→	6	DBJ	<b>0 445 120 300</b>		<b>2 430 105 049</b>
<b>4158</b> [964]	15,6	425	473.900 <OM473LA Euro 6>	04.13→	6	DBJ	<b>0 445 120 300</b>		<b>2 430 105 049</b>
<b>4163</b> [964]	15,6	460	473.900 <OM473LA Euro 6>	04.13→	6	DBJ	<b>0 445 120 300</b>		<b>2 430 105 049</b>
<b>CapaCity</b>									
<b>10.7</b>	10,7	290	470.904 <OM470LA Euro 6>	01.15→	6	DBJ	<b>0 445 120 298</b>	<b>0 986 435 622</b>	
<b>Citaro</b>									
<b>0 530 G/GÜ</b>	10,7	265	470.904 <OM470LA Euro 6>	05.12→	6	DBJ	<b>0 445 120 298</b>	<b>0 986 435 622</b>	<b>2 430 105 049</b>
<b>Conecto G</b>									
<b>10.7 [628]</b>	10,7	265	470.904 <OM470LA Euro 6>	09.13→	6	DBJ	<b>0 445 120 298</b>	<b>0 986 435 622</b>	<b>2 430 105 049</b>
<b>Integro II</b>									
<b>L</b>	10,7	265-290	470.908 <OM470LA Euro6>	04.13→	6	DBJ	<b>0 445 120 298</b>	<b>0 986 435 622</b>	<b>2 430 105 049</b>
<b>Serie V</b>									
<b>200 CDI [447]</b>	2,1	100	OM 651.950 <OM 651 D22 LHD>	04.14→	4	DBB,SSJ, WAS	<b>0 445 110 573</b>	<b>0 986 435 286</b>	156 <b>1 987 972 076</b>
					4	DBJ,SSJ, WAS	<b>0 445 110 571</b>		156 <b>1 987 972 076</b>
CDI [638]	2,2	75	OM 611.980	06.99-09.03	4	DBB,TW	<b>0 445 110 011</b>	<b>0 986 435 004</b>	
					4	DBB,TW	<b>0 445 110 034</b>	<b>0 986 435 012</b>	
					4	DBB,TW	<b>0 445 110 105</b>	<b>0 986 435 045</b>	
								<b>0 986 435 164</b>	
					4	DBB,TW	<b>0 445 110 181</b>	<b>0 986 435 053</b>	
					4	DBB,TW	<b>0 445 110 201</b>	<b>0 986 435 063</b>	
<b>220 CDI [447]</b>	2,1	120	OM 651.950 <OM 651 D22 LHD>	04.14→	4	DBB,SSJ, WAS	<b>0 445 110 573</b>	<b>0 986 435 286</b>	156 <b>1 987 972 076</b>
					4	DBJ,SSJ, WAS	<b>0 445 110 571</b>		156 <b>1 987 972 076</b>
CDI [638]	2,2	90	OM 611.980	06.99-09.03	4	DBB,TW	<b>0 445 110 011</b>	<b>0 986 435 004</b>	
					4	DBB,TW	<b>0 445 110 034</b>	<b>0 986 435 012</b>	
					4	DBB,TW	<b>0 445 110 105</b>	<b>0 986 435 045</b>	
								<b>0 986 435 164</b>	
					4	DBB,TW	<b>0 445 110 181</b>	<b>0 986 435 053</b>	
					4	DBB,TW	<b>0 445 110 201</b>	<b>0 986 435 063</b>	
<b>250 BlueTec [447]</b>	2,1	140	OM 651.950 <OM 651 D22 LHD>	04.14→	4	DBB,SSJ, WAS	<b>0 445 110 573</b>	<b>0 986 435 286</b>	156 <b>1 987 972 076</b>
					4	DBJ,SSJ, WAS	<b>0 445 110 571</b>		156 <b>1 987 972 076</b>







Sprinter																				
208	CDI [T1N]	2,2	60	OM 611.987 D LA	04.00-05.06	4	DBB,EU2	<b>0 445 110 034</b>	<b>0 986 435 012</b>	<b>1 987 972 076</b>										
						4	ACF,DBB	<b>0 445 110 024</b>	<b>0 986 435 020</b>	<b>1 987 972 076</b>										
				Mot.-Nr. →..427374	04.00-05.06	4	DBB,EU3	<b>0 445 110 069</b>	<b>0 986 435 045</b>	<b>0 986 435 158</b>										
				Mot.-Nr. ...427375→..498369	04.00-05.06	4	DBB,EU3	<b>0 445 110 203</b>	<b>0 986 435 065</b>											
				Mot.-Nr. ...498370→	04.00-05.06	4	DBB,EU3, TW	<b>0 445 110 107</b>	<b>0 986 435 047</b>	<b>0 986 435 055</b>										
				4	DBB,EU3, TW	<b>0 445 110 189</b>	<b>0 986 435 055</b>													
209	CDI [NCV3]	2,1	65	OM 646.984 D 22 LA <Euro 4>	04.06-12.09	4	DBB	<b>0 445 115 068</b>	<b>0 986 435 356</b>	<b>1 987 972 076</b>										
210	CDI [NCV3]	2,1	70	OM 651.955 D 22 LA	03.09→	4	BO,DBB	<b>0 445 117 034</b>	<b>0 986 435 428</b>	TW <b>1 987 972 076</b>										
211	CDI [NCV3]	2,1	80	OM 646.985 D 22 LA <Euro 4>	04.06-09.11	4	DBB	<b>0 445 115 068</b>	<b>0 986 435 356</b>	<b>1 987 972 076</b>										
				84-85	OM 651.955 D 22 LA	06.11→	4	BO,DBB	<b>0 445 117 034</b>	<b>0 986 435 428</b>	156 <b>1 987 972 076</b>									
CDI [T1N]	2,1	80	OM 611.981 D LA	04.00-05.06	4	4	DBB,EU2	<b>0 445 110 095</b>	<b>0 986 435 037</b>	<b>1 987 972 076</b>										
											Mot.-Nr. ...427375→..498369	04.00-05.06	4	DBB,EU3	<b>0 445 110 203</b>	<b>0 986 435 065</b>				
													4	DBB,EU3, WW	<b>0 445 110 069</b>	<b>0 986 435 045</b>	<b>0 986 435 158</b>			
Mot.-Nr. ...498370→	04.00-05.06	4	DBB,EU3, TW	<b>0 445 110 107</b>	<b>0 986 435 047</b>	<b>0 986 435 055</b>														
				4	DBB,EU3, TW	<b>0 445 110 189</b>	<b>0 986 435 055</b>													
213	CDI [NCV3]	2,1	95	OM 646.986 D 22 LA <Euro 4>	04.06-09.11	4	DBB	<b>0 445 115 068</b>	<b>0 986 435 356</b>	<b>1 987 972 076</b>										
				OM 651.955...	03.09→	4	BO,DBB	<b>0 445 117 034</b>	<b>0 986 435 428</b>	TW <b>1 987 972 076</b>										
CDI [T1N]	2,1	95	OM 611.981 D LA	04.00-05.06	4	4	DBB,EU2	<b>0 445 110 095</b>	<b>0 986 435 037</b>	<b>1 987 972 076</b>										
											Mot.-Nr. ...427375→..498369	04.00-05.06	4	DBB,EU3	<b>0 445 110 203</b>	<b>0 986 435 065</b>				
													4	DBB,EU3, WW	<b>0 445 110 069</b>	<b>0 986 435 045</b>	<b>0 986 435 158</b>			
Mot.-Nr. ...498370→	04.00-05.06	4	DBB,EU3, TW	<b>0 445 110 107</b>	<b>0 986 435 047</b>	<b>0 986 435 055</b>														
				4	DBB,EU3, TW	<b>0 445 110 189</b>	<b>0 986 435 055</b>													
214	CDI [NCV3]	2,1	105	OM 651.955 D 22 LA	04.16→	4	BO,DBB	<b>0 445 117 034</b>	<b>0 986 435 428</b>	156 <b>1 987 972 076</b>										
215	CDI [NCV3]	2,1	110	OM 646.9... <Euro 4>	04.06-12.11	4				<b>1 987 972 076</b>										
				Mot.-Typ 646.986	04.06-12.11	4	DBB	<b>0 445 115 068</b>	<b>0 986 435 356</b>											
				Mot.-Typ 646.990	04.06-12.11	4	DBB	<b>0 445 110 294</b>	<b>0 986 435 159</b>											
				OM 651.955 DE 22 LA	06.11→	4	BO,DBB	<b>0 445 117 034</b>	<b>0 986 435 428</b>	TW <b>1 987 972 076</b>										
216	CDI [NCV3]	2,1	120	OM 651.955...	03.09→	4	BO,DBB	<b>0 445 117 034</b>	<b>0 986 435 428</b>	156 <b>1 987 972 076</b>										
				CDI [T1N]	2,7	115	OM 612.981 D LA	04.00-05.06	5	DBB,N13	<b>0 445 110 069</b>	<b>0 986 435 045</b>	<b>1 987 972 076</b>							
Mot.-Nr. →..427378	04.00-05.06	5	ACF,DBB											<b>0 445 110 024</b>	<b>0 986 435 020</b>	<b>1 987 972 076</b>				
		5	DBB,EU2, EU3											<b>0 445 110 095</b>	<b>0 986 435 037</b>	<b>0 986 435 063</b>				
Mot.-Nr. →..498369	04.00-05.06	5	DBB,EU3, TW	<b>0 445 110 105</b>	<b>0 986 435 045</b>	<b>0 986 435 164</b>														
				5	DBB,EU3	<b>0 445 110 203</b>	<b>0 986 435 065</b>													
Mot.-Nr. ...427379→..499018	04.00-05.06	5	DBB,EU3, TW	<b>0 445 110 170</b>	<b>0 986 435 053</b>	<b>0 986 435 164</b>														
				5	DBB,EU3, TW	<b>0 445 110 181</b>	<b>0 986 435 053</b>													
Mot.-Nr. ...499019→	04.00-05.06	5	DBB,EU3, TW	<b>0 445 110 107</b>	<b>0 986 435 047</b>	<b>0 986 435 055</b>														
				5	DBB,EU3, TW	<b>0 445 110 189</b>	<b>0 986 435 055</b>													
218	CDI [NCV3]	3,0	135	OM 642... <Euro 4>	04.06-03.09	6				<b>1 987 972 076</b>										
				Mot.-Nr. →..40820980	04.06-11.08	6	DBB	<b>0 445 115 063</b>	<b>0 986 435 355</b>											
				Mot.-Nr. ...40820981→	12.08-03.09	6	DBB	<b>0 445 115 075</b>												









316 CDI [T1N]	2,7	115	OM 612.981 D LA	04.00-05.06	5	DBB,N13	<b>0 445 110 069</b>	<b>0 986 435 045</b>	<b>1 987 972 076</b>		
									<b>0 986 435 158</b>		
					5	AGF,DBB	<b>0 445 110 024</b>	<b>0 986 435 020</b>	<b>1 987 972 076</b>		
					Mot.-Nr. →..427378	04.00-05.06	5	DBB,EU2,EU3	<b>0 445 110 095</b>	<b>0 986 435 037</b>	<b>0 986 435 063</b>
					Mot.-Nr. →..498369	04.00-05.06	5	DBB,EU3, TW	<b>0 445 110 105</b>	<b>0 986 435 045</b>	<b>0 986 435 164</b>
					Mot.-Nr. ...427379→..499018	04.00-05.06	5	DBB,EU3	<b>0 445 110 203</b>	<b>0 986 435 065</b>	
					Mot.-Nr. ...498370→	04.00-05.06	5	DBB,EU3, TW	<b>0 445 110 170</b>	<b>0 986 435 053</b>	<b>0 986 435 164</b>
							5	DBB,EU3, TW	<b>0 445 110 181</b>	<b>0 986 435 053</b>	
					Mot.-Nr. ...499019→	04.00-05.06	5	DBB,EU3, TW	<b>0 445 110 107</b>	<b>0 986 435 047</b>	<b>0 986 435 055</b>
							5	DBB,EU3, TW	<b>0 445 110 189</b>	<b>0 986 435 055</b>	
			OM 647.981 D 27 LA	10.04-05.06	5	DBB	<b>0 445 110 162</b>	<b>0 986 435 109</b>	<b>1 987 972 076</b>		
318 CDI [NCV3]	3,0	135	OM 642... <Euro 4>	04.06-03.09	6				<b>1 987 972 076</b>		
					Mot.-Nr. →..40820980	04.06-11.08	6	DBB	<b>0 445 115 063</b>	<b>0 986 435 355</b>	
					Mot.-Nr. ...40820981→	12.08-03.09	6	DBB	<b>0 445 115 075</b>		
319 CDI [NCV3]	3,0	140	OM 642... <Euro 5>	03.09→	6				<b>1 987 972 076</b>		
					Mot.-Typ 642.896/898	03.09→	6	DBB	<b>0 445 116 027</b>	<b>0 986 435 406</b>	
					Mot.-Typ 642.992	03.09→	6	DBB	<b>0 445 115 061</b>	<b>0 986 435 398</b>	
408 CDI [T1N]	2,2	60	OM 611.987 D LA	04.00-05.06	4	DBB,EU2	<b>0 445 110 034</b>	<b>0 986 435 012</b>	<b>1 987 972 076</b>		
							4	AGF,DBB	<b>0 445 110 024</b>	<b>0 986 435 020</b>	<b>1 987 972 076</b>
					Mot.-Nr. →..427374	04.00-05.06	4	DBB,EU3	<b>0 445 110 069</b>	<b>0 986 435 045</b>	<b>0 986 435 158</b>
					Mot.-Nr. ...427375→..498369	04.00-05.06	4	DBB,EU3	<b>0 445 110 203</b>	<b>0 986 435 065</b>	
					Mot.-Nr. ...498370→	04.00-05.06	4	DBB,EU3, TW	<b>0 445 110 107</b>	<b>0 986 435 047</b>	<b>0 986 435 055</b>
							4	DBB,EU3, TW	<b>0 445 110 189</b>	<b>0 986 435 055</b>	
411 CDI [NCV3]	2,1	80	OM 646.985 D 22 LA <Euro 4>	04.06-09.11	4	DBB	<b>0 445 115 068</b>	<b>0 986 435 356</b>	<b>1 987 972 076</b>		
					CDI [T1N]	2,1	80	OM 611.981 D LA	04.00-05.06	4	DBB,EU2
					4	AGF,DBB	<b>0 445 110 024</b>	<b>0 986 435 020</b>	<b>1 987 972 076</b>		
			Mot.-Nr. ...427375→..498369	04.00-05.06	4	DBB,EU3	<b>0 445 110 203</b>	<b>0 986 435 065</b>			
					4	DBB,EU3, WW	<b>0 445 110 069</b>	<b>0 986 435 045</b>	<b>0 986 435 158</b>		
			Mot.-Nr. ...498370→	04.00-05.06	4	DBB,EU3, TW	<b>0 445 110 107</b>	<b>0 986 435 047</b>	<b>0 986 435 055</b>		
					4	DBB,EU3, TW	<b>0 445 110 189</b>	<b>0 986 435 055</b>			
CDI [909]	2,1	80	OM 646.701 <OM 646 DE22LA>	11.13→	4	DBB	<b>0 445 115 068</b>	<b>0 986 435 356</b>	<b>1 987 972 076</b>		
413 CDI	2,2	95	OM 611 LA	06.01-05.12	4				<b>1 987 972 076</b>		
					Komp.Nr. 522647/06	06.01-05.12	4	DBB	<b>0 445 110 181</b>	<b>0 986 435 053</b>	
					Komp.Nr. 522647/07 /08	06.01-05.12	4	DBB	<b>0 445 110 189</b>	<b>0 986 435 055</b>	
					Komp.Nr. 522647/10	06.01-05.12	4	DBB	<b>0 445 110 203</b>	<b>0 986 435 065</b>	
CDI [NCV3]	2,1	95	OM 651.95...	03.09→	4	BO,DBB	<b>0 445 117 034</b>	<b>0 986 435 428</b>	TW <b>1 987 972 076</b>		
CDI [T1N]	2,1	95	OM 611.981 D LA	04.00-05.06	4	DBB,EU2	<b>0 445 110 095</b>	<b>0 986 435 037</b>	<b>1 987 972 076</b>		
									<b>0 986 435 063</b>		
					4	AGF,DBB	<b>0 445 110 024</b>	<b>0 986 435 020</b>	<b>1 987 972 076</b>		
					Mot.-Nr. ...427375→..498369	04.00-05.06	4	DBB,EU3	<b>0 445 110 203</b>	<b>0 986 435 065</b>	
							4	DBB,EU3, WW	<b>0 445 110 069</b>	<b>0 986 435 045</b>	<b>0 986 435 158</b>
					Mot.-Nr. ...498370→	04.00-05.06	4	DBB,EU3, TW	<b>0 445 110 107</b>	<b>0 986 435 047</b>	<b>0 986 435 055</b>
		4	DBB,EU3, TW	<b>0 445 110 189</b>	<b>0 986 435 055</b>						
CDI [909]	2,1	100	OM 646.701 <OM 646 DE22LA>	11.16→	4	DBB	<b>0 445 115 089</b>		<b>1 987 972 076</b>		
414 CDI [NCV3]	2,1	105	OM 651.955 D 22 LA	05.16→	4	BO,DBB	<b>0 445 117 034</b>	<b>0 986 435 428</b>	156 <b>1 987 972 076</b>		





◀ MERCEDES-BENZ

415 CDI [NCV3]	2,1	110	OM 646.9... <Euro 4>	04.06-09.11	4					<b>1 987 972 076</b>			
			Mot.-Typ 646.986	04.06-09.11	4	DBB	<b>0 445 115 068</b>	<b>0 986 435 356</b>					
			Mot.-Typ 646.990	04.06-09.11	4	DBB	<b>0 445 110 294</b>	<b>0 986 435 159</b>					
416 CDI [NCV3]	2,1	120	OM 651.95...	03.09→	4	BO,DBB	<b>0 445 117 034</b>	<b>0 986 435 428</b>	156	<b>1 987 972 076</b>			
			CDI [T1N]	2,7	115	OM 612.981 D LA	04.00-05.06	5	DBB,N13	<b>0 445 110 069</b>	<b>0 986 435 045</b>	<b>1 987 972 076</b>	
								5	AGF,DBB	<b>0 445 110 024</b>	<b>0 986 435 020</b>	<b>1 987 972 076</b>	
			Mot.-Nr. →..427378	04.00-05.06	5	DBB,EU2,EU3	<b>0 445 110 095</b>	<b>0 986 435 037</b>	<b>0 986 435 063</b>				
			Mot.-Nr. →..498369	04.00-05.06	5	DBB,EU3,TW	<b>0 445 110 105</b>	<b>0 986 435 045</b>	<b>0 986 435 164</b>				
			Mot.-Nr. ...427379→..499018	04.00-05.06	5	DBB,EU3	<b>0 445 110 203</b>	<b>0 986 435 065</b>					
			Mot.-Nr. ...498370→	04.00-05.06	5	DBB,EU3,TW	<b>0 445 110 170</b>	<b>0 986 435 053</b>	<b>0 986 435 164</b>				
					5	DBB,EU3,TW	<b>0 445 110 181</b>	<b>0 986 435 053</b>					
			Mot.-Nr. ...499019→	04.00-05.06	5	DBB,EU3,TW	<b>0 445 110 107</b>	<b>0 986 435 047</b>	<b>0 986 435 055</b>				
					5	DBB,EU3,TW	<b>0 445 110 189</b>	<b>0 986 435 055</b>					
						OM 647.981 D 27 LA	10.04-05.06	5	DBB	<b>0 445 110 162</b>	<b>0 986 435 109</b>	<b>1 987 972 076</b>	
			418 CDI [NCV3]	3,0	135	OM 642... <Euro 4>	04.06-03.09	6					<b>1 987 972 076</b>
						Mot.-Nr. →..40820980	04.06-11.08	6	DBB	<b>0 445 115 063</b>	<b>0 986 435 355</b>		
Mot.-Nr. ...40820981→	12.08-03.09	6				DBJ	<b>0 445 115 075</b>						
419 CDI [NCV3]	3,0	140	OM 642... <Euro 5>	03.09→	6					<b>1 987 972 076</b>			
			Mot.-Typ 642.896	03.09→	6	DBB	<b>0 445 116 027</b>	<b>0 986 435 406</b>					
			Mot.-Typ 642.992	03.09→	6	DBB	<b>0 445 115 061</b>	<b>0 986 435 398</b>					
509 CDI [NCV3]	2,1	65	OM 646.984 D 22 LA <Euro 4>	04.06-12.09	4	DBB	<b>0 445 115 068</b>	<b>0 986 435 356</b>		<b>1 987 972 076</b>			
510 CDI [NCV3]	2,1	70	OM 651.955 D 22 LA	03.09→	4	BO,DBB	<b>0 445 117 034</b>	<b>0 986 435 428</b>	156	<b>1 987 972 076</b>			
511 CDI [NCV3]	2,1	80	OM 646.985 D 22 LA <Euro 4>	04.06-09.11	4	DBB	<b>0 445 115 068</b>	<b>0 986 435 356</b>		<b>1 987 972 076</b>			
		84	OM 651.955 D 22 LA	05.16→	4	BO,DBB	<b>0 445 117 034</b>	<b>0 986 435 428</b>	156	<b>1 987 972 076</b>			
513 CDI [NCV3]	2,1	95	OM 651.95...	03.09→	4	BO,DBB	<b>0 445 117 034</b>	<b>0 986 435 428</b>	TW	<b>1 987 972 076</b>			
514 CDI [NCV3]	2,1	105	OM 651.955 D 22 LA	05.16→	4	BO,DBB	<b>0 445 117 034</b>	<b>0 986 435 428</b>	156	<b>1 987 972 076</b>			
515 CDI [NCV3]	2,1	110	OM 646.9... <Euro 4>	04.06-09.11	4					<b>1 987 972 076</b>			
			Mot.-Typ 646.986	04.06-09.11	4	DBB	<b>0 445 115 068</b>	<b>0 986 435 356</b>					
			Mot.-Typ 646.990	04.06-09.11	4	DBB	<b>0 445 110 294</b>	<b>0 986 435 159</b>					
			OM 651.955 DE 22 LA	06.11→	4	BO,DBB	<b>0 445 117 034</b>	<b>0 986 435 428</b>	156	<b>1 987 972 076</b>			
516 CDI [NCV3]	2,1	120	OM 651.95...	03.09→	4	BO,DBB	<b>0 445 117 034</b>	<b>0 986 435 428</b>	156	<b>1 987 972 076</b>			
518 CDI [NCV3]	3,0	135	OM 642... <Euro 4>	04.06-03.09	6					<b>1 987 972 076</b>			
			Mot.-Nr. →..40820980	04.06-11.08	6	DBB	<b>0 445 115 063</b>	<b>0 986 435 355</b>					
			Mot.-Nr. ...40820981→	12.08-03.09	6	DBJ	<b>0 445 115 075</b>						
519 CDI [NCV3]	3,0	140	OM 642... <Euro 5>	03.09→	6					<b>1 987 972 076</b>			
			Mot.-Typ 642.896/898	03.09→	6	DBB	<b>0 445 116 027</b>	<b>0 986 435 406</b>					
			Mot.-Typ 642.992	03.09→	6	DBB	<b>0 445 115 061</b>	<b>0 986 435 398</b>					
616 CDI [T1N]	2,7	115	OM 612.981 D LA	02.01-05.06	5	DBB,N13	<b>0 445 110 069</b>	<b>0 986 435 045</b>		<b>1 987 972 076</b>			
					5	AGF,DBB	<b>0 445 110 024</b>	<b>0 986 435 020</b>	<b>1 987 972 076</b>				
			Mot.-Nr. →..427378	02.01-05.06	5	DBB,EU2,EU3	<b>0 445 110 095</b>	<b>0 986 435 037</b>	<b>0 986 435 063</b>				
			Mot.-Nr. →..498369	02.01-05.06	5	DBB,EU3,TW	<b>0 445 110 105</b>	<b>0 986 435 045</b>	<b>0 986 435 164</b>				
			Mot.-Nr. ...427379→..499018	02.01-05.06	5	DBB,EU3	<b>0 445 110 203</b>	<b>0 986 435 065</b>					
			Mot.-Nr. ...498370→	02.01-05.06	5	DBB,EU3,TW	<b>0 445 110 170</b>	<b>0 986 435 053</b>	<b>0 986 435 164</b>				
					5	DBB,EU3,TW	<b>0 445 110 181</b>	<b>0 986 435 053</b>					
			Mot.-Nr. ...499019→	02.01-05.06	5	DBB,EU3,TW	<b>0 445 110 107</b>	<b>0 986 435 047</b>	<b>0 986 435 055</b>				
					5	DBB,EU3,TW	<b>0 445 110 189</b>	<b>0 986 435 055</b>					





**Sprinter (James Cook)**

<b>316</b> CDI [T1N]	2,7	115	OM 612.981 DLA	04.01-05.06	5	DBB,N13	<b>0 445 110 069</b>	<b>0 986 435 045</b>	<b>1 987 972 076</b>
								<b>0 986 435 158</b>	
					5	AGF,DBB	<b>0 445 110 024</b>	<b>0 986 435 020</b>	<b>1 987 972 076</b>
Mot.-Nr. →..427378				04.01-05.06	5	DBB,EU2,EU3	<b>0 445 110 095</b>	<b>0 986 435 037</b>	
								<b>0 986 435 063</b>	
Mot.-Nr. →..498369				04.01-05.06	5	DBB,EU3,TW	<b>0 445 110 105</b>	<b>0 986 435 045</b>	
								<b>0 986 435 164</b>	
Mot.-Nr. ..427379→..499018				04.01-05.06	5	DBB,EU3	<b>0 445 110 203</b>	<b>0 986 435 065</b>	
Mot.-Nr. ..498370→				04.01-05.06	5	DBB,EU3,TW	<b>0 445 110 170</b>	<b>0 986 435 053</b>	
								<b>0 986 435 164</b>	
					5	DBB,EU3,TW	<b>0 445 110 181</b>	<b>0 986 435 053</b>	
Mot.-Nr. ..499019→				04.01-05.06	5	DBB,EU3,TW	<b>0 445 110 107</b>	<b>0 986 435 047</b>	
								<b>0 986 435 055</b>	
					5	DBB,EU3,TW	<b>0 445 110 189</b>	<b>0 986 435 055</b>	

**Sprinter Street**

<b>311</b> CDI	2,2	95	OM 611 LA	01.09-05.12	4	DBB	<b>0 445 110 189</b>	<b>0 986 435 055</b>	
----------------	-----	----	-----------	-------------	---	-----	----------------------	----------------------	--

**Travego**

<b>0 580</b> M,L [Edition1]	12,8	350	OM 471.902 LA <Euro 6>	02.12→	6	DBJ	<b>0 445 120 270</b>	<b>0 986 435 598</b>	<b>2 430 105 049</b>
-----------------------------	------	-----	------------------------	--------	---	-----	----------------------	----------------------	----------------------

**Viano**

<b>2.0</b> CDI [639]	2,1	80	OM 646.982 <OM 646 DE22LA>	09.03-10.06	4				<b>1 987 972 076</b>
			Komp.Nr. 522647/03	09.03-10.06	4	DBB	<b>0 445 110 191</b>	<b>0 986 435 113</b>	
								<b>0 986 435 114</b>	
			Komp.Nr. 522647/13	09.03-10.06	4	DBB	<b>0 445 110 139</b>	<b>0 986 435 107</b>	
			Komp.Nr. 522647/18	09.03-10.06	4	DBB	<b>0 445 110 263</b>	<b>0 986 435 115</b>	
		85	OM 646.98... <OM 646 DE22LA>	11.06-08.10	4				<b>1 987 972 076</b>
			Mot.-Typ 646.980/981	11.06-08.10	4	DBB	<b>0 445 115 068</b>	<b>0 986 435 356</b>	
			Mot.-Typ 646.982	11.06-08.10	4	DBB	<b>0 445 110 191</b>	<b>0 986 435 113</b>	
			Komp.Nr. 522647/03					<b>0 986 435 114</b>	
			Mot.-Typ 646.982	11.06-08.10	4	DBB	<b>0 445 110 139</b>	<b>0 986 435 107</b>	
			Komp.Nr. 522647/13						
			Mot.-Typ 646.982	11.06-08.10	4	DBB	<b>0 445 110 263</b>	<b>0 986 435 115</b>	
			Komp.Nr. 522647/18						
		100	OM 651.940 <OM 651 DE22LA>	07.10-12.14	4				156 <b>1 987 972 076</b>
<b>2.2</b> CDI [639]	2,1	110	OM 646.98... <OM 646 DE22LA>	09.03-12.10	4				<b>1 987 972 076</b>
			Mot.-Typ 646.980	09.03-12.10	4	DBB	<b>0 445 115 068</b>	<b>0 986 435 356</b>	
			Mot.-Typ 646.982	09.03-12.10	4	DBB	<b>0 445 110 191</b>	<b>0 986 435 113</b>	
			Komp.Nr. 522647/03					<b>0 986 435 114</b>	
			Mot.-Typ 646.982	09.03-12.10	4	DBB	<b>0 445 110 139</b>	<b>0 986 435 107</b>	
			Komp.Nr. 522647/13						
			Mot.-Typ 646.982	09.03-12.10	4	DBB	<b>0 445 110 263</b>	<b>0 986 435 115</b>	
			Komp.Nr. 522647/18						
		120	OM 651.940 <OM 651 DE22LA>	07.10-12.14	4				156 <b>1 987 972 076</b>
<b>3.0</b> CDI [639]	3,0	150	OM 642.990 <OM 642 DE 30LA>	04.06-08.10	6				<b>1 987 972 076</b>
			Mot.-Nr. →40820980	04.06-11.08	6	DBB	<b>0 445 115 063</b>	<b>0 986 435 355</b>	
			Mot.-Nr. ..40820981→	12.08-08.10	6	DBJ	<b>0 445 115 075</b>		
		165	OM 642.890 <OM 642 DE 30 LA>	07.10-12.14	6	DBB	<b>0 445 116 025</b>	<b>0 986 435 404</b>	<b>1 987 972 076</b>

**Vito**

<b>108</b> CDI [638]	2,2	60	OM 611.980	04.99-09.03	4	DBB,TW	<b>0 445 110 011</b>	<b>0 986 435 004</b>	<b>1 987 972 076</b>
					4	DBB,TW	<b>0 445 110 034</b>	<b>0 986 435 012</b>	<b>1 987 972 076</b>
					4	DBB,TW	<b>0 445 110 105</b>	<b>0 986 435 045</b>	<b>1 987 972 076</b>
								<b>0 986 435 164</b>	
					4	DBB,TW	<b>0 445 110 181</b>	<b>0 986 435 053</b>	<b>1 987 972 076</b>
					4	DBB,TW	<b>0 445 110 201</b>	<b>0 986 435 063</b>	<b>1 987 972 076</b>

<b>109</b> CDI [639]	2,1	65	OM 646.983 <OM 646 DE22LA>	10.03-10.06	4				<b>1 987 972 076</b>
----------------------	-----	----	----------------------------	-------------	---	--	--	--	----------------------

			Mot.-Nr. →50202886	10.03-10.06	4	DBB	<b>0 445 110 139</b>	<b>0 986 435 107</b>	
--	--	--	--------------------	-------------	---	-----	----------------------	----------------------	--

			Mot.-Nr. 50202887→	10.03-10.06	4	DBB	<b>0 445 110 263</b>	<b>0 986 435 115</b>	
--	--	--	--------------------	-------------	---	-----	----------------------	----------------------	--

		70	OM 646.980 <OM 646 DE22LA>	11.06-07.10	4	DBB	<b>0 445 115 068</b>	<b>0 986 435 356</b>	<b>1 987 972 076</b>
--	--	----	----------------------------	-------------	---	-----	----------------------	----------------------	----------------------





◀ MERCEDES-BENZ

<b>110</b> CDI [638]	2,2	75	OM 611.980	04.99-09.03	4	DBB,TW	<b>0 445 110 011</b>	<b>0 986 435 004</b>	<b>1 987 972 076</b>			
					4	DBB,TW	<b>0 445 110 034</b>	<b>0 986 435 012</b>	<b>1 987 972 076</b>			
					4	DBB,TW	<b>0 445 110 105</b>	<b>0 986 435 045</b>	<b>1 987 972 076</b>			
								<b>0 986 435 164</b>				
					4	DBB,TW	<b>0 445 110 181</b>	<b>0 986 435 053</b>	<b>1 987 972 076</b>			
					4	DBB,TW	<b>0 445 110 201</b>	<b>0 986 435 063</b>	<b>1 987 972 076</b>			
CDI [639]	2,1	70	OM 651.940 <OM 651 DE22LA>	07.10-12.14	4			156	<b>1 987 972 076</b>			
<b>111</b> CDI [639]	2,1	80	OM 646.982 <OM 646 DE22LA>	10.03-07.10	4				<b>1 987 972 076</b>			
					Komp.Nr. 522647/03	10.03-07.10	4	DBB	<b>0 445 110 191</b>	<b>0 986 435 113</b>	<b>0 986 435 114</b>	
					Komp.Nr. 522647/13	10.03-07.10	4	DBB	<b>0 445 110 139</b>	<b>0 986 435 107</b>		
					Komp.Nr. 522647/18	10.03-07.10	4	DBB	<b>0 445 110 263</b>	<b>0 986 435 115</b>		
					85	OM 646.98... <OM 646 DE22LA>	11.06-07.10	4				<b>1 987 972 076</b>
					Mot.-Typ 646.980/981	11.06-07.10	4	DBB	<b>0 445 115 068</b>	<b>0 986 435 356</b>		
					Mot.-Typ 646.982	11.06-07.10	4	DBB	<b>0 445 110 191</b>	<b>0 986 435 113</b>		
					Komp.Nr. 522647/03					<b>0 986 435 114</b>		
					Mot.-Typ 646.982	11.06-07.10	4	DBB	<b>0 445 110 139</b>	<b>0 986 435 107</b>		
					Komp.Nr. 522647/13							
Mot.-Typ 646.982	11.06-07.10	4	DBB	<b>0 445 110 263</b>	<b>0 986 435 115</b>							
Komp.Nr. 522647/18												
OM 651.940 <OM 651 DE22LA>				07.10-12.14	4			156	<b>1 987 972 076</b>			
<b>112</b> CDI [638]	2,2	90	OM 611.980	04.99-09.03	4	DBB,TW	<b>0 445 110 011</b>	<b>0 986 435 004</b>	<b>1 987 972 076</b>			
					4	DBB,TW	<b>0 445 110 034</b>	<b>0 986 435 012</b>	<b>1 987 972 076</b>			
					4	DBB,TW	<b>0 445 110 105</b>	<b>0 986 435 045</b>	<b>1 987 972 076</b>			
								<b>0 986 435 164</b>				
					4	DBB,TW	<b>0 445 110 181</b>	<b>0 986 435 053</b>	<b>1 987 972 076</b>			
					4	DBB,TW	<b>0 445 110 201</b>	<b>0 986 435 063</b>	<b>1 987 972 076</b>			
<b>113</b> CDI [639]	2,1	100	OM 651.940 <OM 651 DE22LA>	07.10-12.14	4			156	<b>1 987 972 076</b>			
<b>114</b> CDI [447]	2,1	100	OM 651.950 <OM 651 D22 LHD>	09.14→	4	DBB,SSJ, WAS	<b>0 445 110 573</b>	<b>0 986 435 286</b>	156	<b>1 987 972 076</b>		
					4	DBJ,SSJ, WAS	<b>0 445 110 571</b>		156	<b>1 987 972 076</b>		
<b>115</b> CDI [639]	2,1	110	OM 646.982 <OM 646 DE22LA>	10.03-07.10	4					<b>1 987 972 076</b>		
					Komp.Nr. 522647/03	10.03-07.10	4	DBB	<b>0 445 110 191</b>	<b>0 986 435 113</b>	<b>0 986 435 114</b>	
					Komp.Nr. 522647/13	10.03-07.10	4	DBB	<b>0 445 110 139</b>	<b>0 986 435 107</b>		
					Komp.Nr. 522647/18	10.03-07.10	4	DBB	<b>0 445 110 263</b>	<b>0 986 435 115</b>		
<b>116</b> CDI [447]	2,1	120	OM 651.950 <OM 651 D22 LHD>	09.14→	4	DBB,SSJ, WAS	<b>0 445 110 573</b>	<b>0 986 435 286</b>	156	<b>1 987 972 076</b>		
					4	DBJ,SSJ, WAS	<b>0 445 110 571</b>		156	<b>1 987 972 076</b>		
CDI [639]	2,1	120	OM 651.940 <OM 651 DE22LA>	07.10-12.14	4			156	<b>1 987 972 076</b>			
<b>119</b> CDI BlueTEC [447]	2,1	140	OM 651.950 <OM 651 D22 LHD>	09.14→	4	DBB,SSJ, WAS	<b>0 445 110 573</b>	<b>0 986 435 286</b>	156	<b>1 987 972 076</b>		
					4	DBJ,SSJ, WAS	<b>0 445 110 571</b>		156	<b>1 987 972 076</b>		
<b>120</b> CDI [639]	3,0	150	642.990 <OM 642 DE30LA>	04.06-07.10	6					<b>1 987 972 076</b>		
					Mot.-Nr. →40820980	04.06-11.08	6	DBB	<b>0 445 115 063</b>	<b>0 986 435 355</b>		
					Mot.-Nr. ...40820981→	12.08-07.10	6	DBJ	<b>0 445 115 075</b>			
<b>122</b> CDI [639]	3,0	165	OM 642.890 <OM 642 DE 30 LA>	07.10-12.14	6	DBB	<b>0 445 116 025</b>	<b>0 986 435 404</b>		<b>1 987 972 076</b>		



**MITSUBISHI**

**Canter 35**

<b>3C11</b> [FB]	3,0	81	4M42-T1 <Euro 4>	04.06→	4	DBJ	<b>0 445 120 073</b>	<b>0 986 435 550</b>
<b>3C13</b> [FB]	3,0	92	4M42-T2 <Euro 4>	04.06→	4	DBJ	<b>0 445 120 073</b>	<b>0 986 435 550</b>
<b>3C15</b> [FB]	3,0	107	4M42-T4 <Euro 4>	04.06→	4	DBJ	<b>0 445 120 073</b>	<b>0 986 435 550</b>
<b>3S11</b> [FE]	3,0	81	4M42-T1 <Euro 4>	04.06→	4	DBJ	<b>0 445 120 073</b>	<b>0 986 435 550</b>
<b>3S13</b> [FE]	3,0	92	4M42-T2 <Euro 4>	04.06→	4	DBJ	<b>0 445 120 073</b>	<b>0 986 435 550</b>

**Canter 55**

<b>5S13</b> [FE]	3,0	92	4M42-3A T2 <Euro 4>	04.06→	4	DBJ	<b>0 445 120 073</b>	<b>0 986 435 550</b>
------------------	-----	----	---------------------	--------	---	-----	----------------------	----------------------



<b>Canter 65</b>										
<b>6C15</b> [FE]	3,0	107	4M42-3A T4 <Euro 4>	04.06→	4	DBJ	<b>0 445 120 073</b>	<b>0 986 435 550</b>		
<b>6C18</b> [FE]	4,9	132	4M50-T5 <Euro 4>	08.06→	4	DBJ	<b>0 445 120 072</b>			
<b>Canter 75</b>										
<b>7C15</b> [FE]	3,0	107	4M42-3A T4 <Euro 4>	04.06→	4	DBJ	<b>0 445 120 073</b>	<b>0 986 435 550</b>		
<b>7C18</b> [FE]	4,9	132	4M50-T5 <Euro 4>	08.06→	4	DBJ	<b>0 445 120 072</b>			

**MITSUBISHI FUSO TRUCK & BUS CO**

<b>Canter</b>										
<b>3C11D</b>	3,0	81	4M42-3AT1 <Euro 4>	04.06-11.10	4	DBJ	<b>0 445 120 073</b>	<b>0 986 435 550</b>		
<b>3C13D</b>	3,0	92	4M42-3AT2 <Euro 4>	04.06-11.10	4	DBJ	<b>0 445 120 073</b>	<b>0 986 435 550</b>		
<b>3C15</b>	3,0	107	4M42-3AT4 <Euro 4>	04.06-11.10	4	DBJ	<b>0 445 120 073</b>	<b>0 986 435 550</b>		
<b>3S11D</b>	3,0	81	4M42-3AT1 <Euro 4>	04.06-11.10	4	DBJ	<b>0 445 120 073</b>	<b>0 986 435 550</b>		
<b>3S13D</b>	3,0	92	4M42-3AT2 <Euro 4>	04.06-11.10	4	DBJ	<b>0 445 120 073</b>	<b>0 986 435 550</b>		
<b>4.9 D Turbo</b>	4,9	110	4M50-7AT7 <Euro 3>	11.09→	4	DBJ	<b>0 445 120 049</b>			
<b>5S13D</b>	3,0	92	4M42-3AT2 <Euro 4>	04.06-11.10	4	DBJ	<b>0 445 120 073</b>	<b>0 986 435 550</b>		
<b>6C15D</b>	3,0	107	4M42-3AT4 <Euro 4>	04.06-11.10	4	DBJ	<b>0 445 120 073</b>	<b>0 986 435 550</b>		
<b>6C18D</b>	4,9	132	4M50-T5 <Euro 4>	04.06-11.10	4	DBJ	<b>0 445 120 072</b>			
<b>7C15D</b>	3,0	107	4M42-3AT4 <Euro 4>	04.06-11.10	4	DBJ	<b>0 445 120 073</b>	<b>0 986 435 550</b>		
<b>7C18D</b>	4,9	132	4M50-T5 <Euro 4>	04.06-11.10	4	DBJ	<b>0 445 120 072</b>			

**MZKT**

<b>42t</b>										
<b>700600</b>	11,1	303	650.10 <Euro 3>	01.10→	6	DBJ	<b>0 445 120 142</b>			

**NEFAZ NEFTEKAMSK**

<b>Serie 5000</b>										
<b>5297</b>	5,9	184	6ISBe 250.30 <Euro 3>	01.00→	6	DBJ,TW	<b>0 445 120 123</b>			
					6	DBJ,TW	<b>0 445 120 273</b>	<b>0 986 435 571</b>		
<b>5299</b>	6,7	184	6ISBe 250.30 <Euro 3>	01.08→	6	DBJ,TW	<b>0 445 120 123</b>			
		198	6ISBe 270B <Euro 3>	01.08→	6	DBJ,TW	<b>0 445 120 123</b>			
					6	DBJ,TW	<b>0 445 120 273</b>	<b>0 986 435 571</b>		

**NEOPLAN**

<b>Trendliner</b>										
<b>N 3516 ..</b>	10,5	228	D 2066 LUH01 <Euro4>	01.06-03.10	6	DBJ	<b>0 445 120 217</b>	<b>0 986 435 526</b>		<b>F 00R J02 175</b>

**NISSAN**

<b>Atleon</b>										
<b>3.0 [TK3]</b>	3,0	110	ZD30Kai	09.09→	4				ZDA	<b>9 431 612 709</b>
<b>Cabstar</b>										
<b>2.5 D Turbo [F24]</b>	2,5	81-90/96-100/107	YD25DDTI	09.06-08.16	4					<b>9 431 612 213</b>
<b>3.0 D Turbo, TD [F24]</b>	3,0	110	ZD30DDTI	09.06→	4				ZDA	<b>9 431 612 709</b>
<b>Cabstar NT400</b>										
<b>3.0 DDTI [F24]</b>	3,0	96/110	ZD30DDTI	11.16→	4				ZDA	<b>9 431 612 709</b>
<b>Interstar</b>										
<b>1.9 dCi80 [X70]</b>	1,9	59-60	F9Q 77...	07.02-06.10	4					<b>2 430 105 043</b>
			Mot.-Nr. F9Q 774	07.02-06.10	4	DBB	<b>0 445 110 110</b>	<b>0 986 435 080</b>		
<b>2.2 dCi90 [X70]</b>	2,2	66	G9T 7...	07.02-06.10	4	DBB	<b>0 445 110 102</b>	<b>0 986 435 106</b>		







◀ NISSAN

<b>2.5 dCi 100 [X70]</b>	2,5	73-74	G9U...	11.03-06.10	4						<b>2 430 105 043</b>
			Mot.-Nr. G9U 650	11.03-06.10	4	DBB	<b>0 445 110 265</b>	<b>0 986 435 170</b>			
								<b>0 986 435 236</b>			
								<b>0 986 435 275</b>			
			Mot.-Nr. G9U 754	11.03-06.10	4		<b>0 445 110 141</b>	<b>0 986 435 086</b>			
								<b>0 986 435 239</b>			
<b>dCi 120 [X70]</b>	2,5	84-88	G9U...	07.02-06.10	4						<b>2 430 105 043</b>
			Mot.-Nr. G9U 632	07.02-06.10	4	DBB	<b>0 445 110 265</b>	<b>0 986 435 170</b>			
			Mot.-Nr. G9U 650					<b>0 986 435 236</b>			
								<b>0 986 435 275</b>			
			Mot.-Nr. G9U 720	07.02-06.10	4	DBB,TW	<b>0 445 110 087</b>	<b>0 986 435 079</b>			
			Mot.-Nr. G9U 750					<b>0 986 435 235</b>			
								<b>0 986 435 274</b>			
			Mot.-Nr. G9U 724	07.02-06.10	4		<b>0 445 110 141</b>	<b>0 986 435 086</b>			
			Mot.-Nr. G9U 754					<b>0 986 435 239</b>			

<b>NT500</b>											
<b>35.15 [G40M]</b>	3,0	110	ZD30VNT	12.13→	4				ZDA		<b>9 431 612 709</b>
<b>56.15 [G40M]</b>	3,0	110	ZD30VNT	12.13→	4				ZDA		<b>9 431 612 709</b>
<b>65.15 [G40M]</b>	3,0	110	ZD30VNT	12.13→	4				ZDA		<b>9 431 612 709</b>
<b>75.18 [G40M]</b>	3,0	130	ZD30TT	01.14→	4				ZDA		<b>9 431 612 709</b>

<b>NV300</b>											
<b>1.6 dCi [X82]</b>	1,6	70/89/92/107	R9M	09.16→	4						<b>2 430 105 043</b>

<b>NV400</b>											
<b>2.3 dCi [X62]</b>	2,3	120	M9T 70...	07.14→	4						<b>2 430 105 043</b>

<b>Primastar</b>											
<b>1.9 dCi 80, dCi 100 [X83]</b>	1,9	59-60/74	F9Q 760; F9Q 762	07.02-12.07	4						<b>2 430 105 043</b>

<b>2.0 dCi 90, dCi 115 [X83]</b>	2,0	66/84-85	M9R...	10.06→	4						<b>2 430 105 043</b>
			Mot.-Nr. M9R 780	10.06→	4	DBB	<b>0 445 115 022</b>	<b>0 986 435 390</b>			
			Mot.-Nr. M9R 782								

<b>2.5 dCi 135 [X83]</b>	2,5	99	G9U 730	09.03-11.11	4	DBB	<b>0 445 110 087</b>	<b>0 986 435 079</b>			<b>2 430 105 043</b>
								<b>0 986 435 235</b>			
								<b>0 986 435 274</b>			
<b>dCi 150 [X83]</b>	2,5	107-110	G9U 630	10.06→	4						<b>2 430 105 043</b>
			Mot.-Nr. G9U 630	10.06→	4	DBB	<b>0 445 110 265</b>	<b>0 986 435 170</b>			
								<b>0 986 435 236</b>			
								<b>0 986 435 275</b>			
			Mot.-Nr. G9U 730	10.06→	4	DBB	<b>0 445 110 087</b>	<b>0 986 435 079</b>			
								<b>0 986 435 235</b>			
								<b>0 986 435 274</b>			

<b>Urvan Bus</b>											
<b>2.5 D [E25]</b>	3,0	77-78	ZD30DD	07.01-11.12	4				ZDA		<b>9 431 612 709</b>

**OPEL**

<b>Movano</b>											
<b>1.9 DTI [A]</b>	1,9	60	F9Q-77... <EEC99/102A>	10.01-10.05	4	DBB	<b>0 445 110 146</b>	<b>0 986 435 007</b>			
<b>2.2 DTI [A]</b>	2,2	66	G9T-7... <EEC99/102A>	03.01-10.05	4	DBB	<b>0 445 110 102</b>	<b>0 986 435 106</b>			
			G9T-720 <EEC96/69>	09.00-10.05	4	DBB	<b>0 445 110 063</b>	<b>0 986 435 075</b>			
<b>2.3 CDTI FWD [B]</b>	2,3	74	M9T 87...	10.12→	4	DBJ	<b>0 445 110 375</b>	<b>0 986 435 205</b>			<b>F 00V C17 504</b>
								<b>0 986 435 234</b>			
		74/92	M9T 67...	04.10→	4	DBJ	<b>0 445 110 375</b>	<b>0 986 435 205</b>			<b>F 00V C17 504</b>
								<b>0 986 435 234</b>			
		81	M9T 870	06.14→	4	DBJ	<b>0 445 110 375</b>	<b>0 986 435 205</b>			<b>F 00V C17 504</b>
								<b>0 986 435 234</b>			
		92/107	M9T 6...	04.10→	4	DBJ	<b>0 445 110 375</b>	<b>0 986 435 205</b>			<b>F 00V C17 504</b>
								<b>0 986 435 234</b>			
			M9T 8...	10.12→	4	DBJ	<b>0 445 110 375</b>	<b>0 986 435 205</b>			<b>F 00V C17 504</b>
								<b>0 986 435 234</b>			
<b>CDTI RWD [B]</b>	2,3	74/92/107	M9T 69...	04.10→	4	DBJ	<b>0 445 110 375</b>	<b>0 986 435 205</b>			<b>F 00V C17 504</b>
								<b>0 986 435 234</b>			



2.3 CDTi RWD [B]	2,3	74/92/107	M9T 89...	10.12→	4	DBJ	0 445 110 375	0 986 435 205 0 986 435 234	F 00V C17 504
2.5 DTi [A]	2,5	73-74	G9U-754 <ECC99/102A>	10.01-03.10	4		0 445 110 141	0 986 435 086 0 986 435 239	
		74/88/107	G9U-632; G9U-650	08.06-06.10	4	DBB	0 445 110 265	0 986 435 170 0 986 435 236 0 986 435 275	
	84		G9U-7... <ECC99/102A> Mot.-Typ 724 Mot.-Typ 754	10.01-10.07	4		0 445 110 141	0 986 435 086 0 986 435 239	
			Mot.-Typ 750 Mot.-Typ 720	10.01-10.07	4	DBB	0 445 110 087	0 986 435 079 0 986 435 235 0 986 435 274	

**Vivaro**

1.6 CDTi, CDTi BiTurbo [B]	1,6	66/70/85/88/92/103/107	R9M Mot.-Typ R9M-MA Mot.-Typ R9M-MB Mot.-Typ R9M-MC Mot.-Typ R9M-MG Mot.-Typ R9M-MH Mot.-Typ R9M-MD Mot.-Typ R9M-ME	10.14→	4	DBB,TW	0 445 110 569		
1.9 CDTi, DTi [A]	1,9	60/74	F9Q-760; F9Q-762	03.01-08.06	4	DBB	0 445 110 146	0 986 435 007	
2.0 CDTi [A]	2,0	66/84	M9R 6... M9R 78... Mot.-Typ M9R 780 Mot.-Typ M9R 782 Mot.-Typ M9R 784 Mot.-Typ M9R 786 Mot.-Typ M9R 788	12.10-08.14	4	DBJ	0 445 110 375	0 986 435 205 0 986 435 234	
			Mot.-Typ M9R 780	08.06-08.14	4	DBB	0 445 115 007	0 986 435 350	
			Mot.-Typ M9R 782						
			Mot.-Typ M9R 784						
			Mot.-Typ M9R 786	08.06-08.14	4	DBJ	0 445 110 338	0 986 435 202	F 00V C17 504
			Mot.-Typ M9R 788						
2.5 CDTi [A]	2,5	84/107	G9U 630; G9U-630,G9M86 <Turbo>	08.06-08.14	4	DBB	0 445 110 265	0 986 435 170 0 986 435 236 0 986 435 275	
	99		G9U-730 <Turbo>	09.02-08.06	4	DBB	0 445 110 087	0 986 435 079 0 986 435 235 0 986 435 274	



**PAZ PAVLOVO**

**Serie 3000**

3237	3,9	110	ISBe 150.30 <Euro 3>	01.00→	4	DBJ	0 445 120 273	0 986 435 571	
-03,-09	4,5	117,7/136	4ISBe 160B <Euro 3>; 4ISBe 185B <Euro 3>	06.09→	4	DBJ	0 445 120 123		

**Serie 4000**

4230	4,5	136	4ISBe 185B <Euro 3>	06.09→	4	DBJ	0 445 120 123		
4234	4,8	100	D 245.9 E4 <Euro 4>	12.11→	4	DBJ	0 445 120 245		
		110	D 245.9 E3 <Euro 3>	01.08→	4	DBJ	0 445 120 141		

**Serie 32000**

32053	4,8	100	D 245.9 E4 <Euro 2>	12.11→	4	DBJ	0 445 120 245		
		110	D 245.9 E3 <Euro 3>	01.08→	4	DBJ	0 445 120 141		

**Serie 320000**

320301-03	4,5	136	4ISBe 185B <Euro 3>	06.09→	4	DBJ	0 445 120 123		
-----------	-----	-----	---------------------	--------	---	-----	---------------	--	--

**PEUGEOT**

**Boxer**

2.0 HDi [U3]	2,0	62	RHV <DW10TD>	09.01-02.02	4	DBB	0 445 110 076	0 986 435 077	
HDi [U5]	2,0	62	RHV <DW10TD>	02.02-05.06	4	DBB	0 445 110 076	0 986 435 077	
2.2 HDi [U5]	2,2	74	4HY <DW12TED>	02.02-12.06	4	DBB	0 445 110 076	0 986 435 077	
2.8 HDi [U3]	2,8	94	8140.43S	09.00-02.02	4	DBJ	0 445 120 002	0 986 435 501	



◀ PEUGEOT

<b>2.8</b> HDi [U5]	2,8	94/107	8140 43N <SOFIM 2800 HDi>; 8140.43S	02.02-05.06	4	DBJ	<b>0 445 120 002</b>	<b>0 986 435 501</b>	
HDi	2,8	93	8140.43S	09.05-09.09	4	DBJ	<b>0 445 120 002</b>	<b>0 986 435 501</b>	
<b>3.0</b> HDi [U9]	3,0	107/115/ 130	F1CE3481... <30 DT PEF EURO5 155>; F1CE3481E <30 DT PEF EURO5 175>; F1CE3481N <30 DT PEF EURO5 145>	01.10→	4	DBJ	<b>0 445 116 059</b>	<b>0 986 435 395</b>	
		116	F1CE0481D <SOFIM F 30DT/PEF>	06.06-12.11	4	DBJ	<b>0 445 110 248</b>	<b>0 986 435 163</b>	

**RENAULT**

**Kerax**

<b>270</b>	11,1	195	dCi 11 l <Euro 3>	01.01-04.06	6	DBJ	<b>0 445 120 014</b>	<b>0 986 435 515</b>	
<b>320</b>	11,1	230	dCi 11 G <Euro 3>	01.01-04.06	6	DBJ	<b>0 445 120 014</b>	<b>0 986 435 515</b>	
<b>370</b>	11,1	266	dCi 11 E <Euro 3> Mot.-Typ Variante 14102→	11.01-04.06	6	DBJ	<b>0 445 120 019</b>	<b>0 986 435 523</b>	
<b>420</b>	11,1	303	dCi 11 C <Euro 3>	01.01-04.06	6	DBJ	<b>0 445 120 019</b>	<b>0 986 435 523</b>	

**Mascott**

<b>110</b>	2,8	78	8140.43B.3586/3588	01.01-06.04	4	DBJ	<b>0 445 120 002</b>	<b>0 986 435 501</b>	
<b>120</b>	3,0	85	DXi 3-120 ZD3 600	05.04-05.07	4	DBJ	<b>0 445 110 168</b>	<b>0 986 435 175</b>	
								<b>0 986 435 293</b>	
<b>130</b>	2,8	92	8140.43S.2585; 8140.43S.3585	01.99-06.04	4	DBJ	<b>0 445 120 002</b>	<b>0 986 435 501</b>	
<b>140</b>	2,8	103	8140.43K.2585	01.01-06.04	4	DBJ	<b>0 445 120 002</b>	<b>0 986 435 501</b>	
<b>150</b>	2,8	107	8140.43N.3585	10.01-06.04	4	DBJ	<b>0 445 120 002</b>	<b>0 986 435 501</b>	
<b>160</b>	3,0	115	DXi 3-160 ZD3 604	05.04-05.07	4	DBJ	<b>0 445 110 169</b>	<b>0 986 435 176</b>	

**Master**

<b>2.3</b> dCi 16V [ADCU]	2,3	96	M9T...	03.12→	4	TW	<b>0 445 110 141</b>	<b>0 986 435 086</b>	
					4	TW	<b>0 445 110 634</b>	<b>0 986 435 239</b>	
<b>2.5</b> dCi 16V [ADCU]	2,5	85	G9U-724	10.04-02.12	4		<b>0 445 110 141</b>	<b>0 986 435 086</b>	<b>1 987 972 078</b>
								<b>0 986 435 239</b>	

**Master II**

<b>1.9</b> dCi 80	1,9	60	F9Q 772	05.00-03.03	4	DBB	<b>0 445 110 146</b>	<b>0 986 435 007</b>	<b>1 987 972 077</b>
			F9Q 774	10.03-10.06	4	DBB	<b>0 445 110 110</b>	<b>0 986 435 080</b>	<b>1 987 972 077</b>
<b>2.2</b> dCi 90	2,2	66	G9T 720	01.00-09.03	4	DBB	<b>0 445 110 063</b>	<b>0 986 435 075</b>	<b>1 987 972 078</b>
			G9T 722	05.00-09.03	4	DBB	<b>0 445 110 102</b>	<b>0 986 435 106</b>	<b>1 987 972 078</b>
			G9T 750	10.03-10.06	4	DBB	<b>0 445 110 102</b>	<b>0 986 435 106</b>	<b>1 987 972 078</b>
<b>2.5</b> dCi 100	2,5	74	G9U 650 (M2) <120BN, Euro 4>	11.06-04.10	4	DBB	<b>0 445 110 265</b>	<b>0 986 435 170</b>	<b>1 987 972 078</b>
								<b>0 986 435 236</b>	
								<b>0 986 435 275</b>	
dCi 100, dCi 110, dCi 120	2,5	73/81/84	G9U 724; G9U 754	07.02-01.10	4		<b>0 445 110 141</b>	<b>0 986 435 086</b>	<b>1 987 972 077</b>
								<b>0 986 435 239</b>	
dCi 120	2,5	84	G9U 720	05.00-09.03	4	DBB	<b>0 445 110 087</b>	<b>0 986 435 079</b>	<b>1 987 972 078</b>
								<b>0 986 435 235</b>	
								<b>0 986 435 274</b>	
			G9U 750	10.03-01.10	4	DBB	<b>0 445 110 087</b>	<b>0 986 435 079</b>	<b>1 987 972 078</b>
								<b>0 986 435 235</b>	
								<b>0 986 435 274</b>	
		88	G9U 650 (M1) <120BO, Euro 4>	11.06-04.10	4	DBB	<b>0 445 110 265</b>	<b>0 986 435 170</b>	<b>1 987 972 078</b>
								<b>0 986 435 236</b>	
								<b>0 986 435 275</b>	
dCi 120 FAP	2,5	88	G9U 632 (M1) <120BQ, Euro 4>	11.06-04.10	4	DBB	<b>0 445 110 265</b>	<b>0 986 435 170</b>	<b>1 987 972 078</b>
								<b>0 986 435 236</b>	
								<b>0 986 435 275</b>	
dCi 150 FAP	2,5	107	G9U 632 (MY) <Euro 4>	11.06-04.10	4	DBB	<b>0 445 110 265</b>	<b>0 986 435 170</b>	<b>1 987 972 078</b>
								<b>0 986 435 236</b>	
								<b>0 986 435 275</b>	
<b>3.0</b> dCi 140	3,0	100	ZD3 200 <Euro 3>; ZD3 202 <Euro 3>	10.03-10.06	4	DBJ	<b>0 445 110 168</b>	<b>0 986 435 175</b>	<b>0 986 435 293</b>





Master III										
2.3 dCi, dCi 100 FWD, dCi 100 RWD, dCi 110, dCi 125 FWD, dCi 125 RWD, dCi 150 FWD, dCi 150 RWD	2,3	74-92/96-107/110	M9T...; M9T 6... <120CG/CH/CK>; M9T 69... <120CD/CE/CL>; M9T 670 <120BU/BV>; M9T 672 <120CA/CB>; M9T 676 <120BX/BY>; M9T 678 <120BZ>; M9T 694 <120CJ>; M9T 870; M9T 876; M9T 880; M9T 890; M9T 898	02.10→	4					F 00V C17 504
dCi 110, dCi 135, dCi 145, dCi 165, dCi 170	2,3	81/96-100/107/120/125	M9T 7...; M9T 704	05.14→	4					1987 972 077

Midlum										
150	4,0	112	dCI 4B <Euro 3>	07.01-04.06	4	DBJ	0 445 120 016	0 986 435 531		
180	4,0	128	dCI 4C <Euro 3>	07.01-04.06	4	DBJ	0 445 120 016	0 986 435 531		
210	6,2	157	dCI 6AE <Euro 3>	07.01-02.02	6	DBJ	0 445 120 012	0 986 435 525		
			Mot.-Typ 13113	03.02-12.05	6	DBJ	0 445 120 012	0 986 435 525		
			Mot.-Typ 13116	03.02-12.05	6	DBJ	0 445 120 016	0 986 435 531		
220 4x2, 4x4	6,2	158/162	dCI 6W <Euro 3>	07.01-04.06	6	DBJ	0 445 120 012	0 986 435 525		
260	6,2	195	dCI 6AF <Euro 3>	07.01-02.02	6	DBJ	0 445 120 012	0 986 435 525		
			Mot.-Typ 13113	03.02-12.05	6	DBJ	0 445 120 012	0 986 435 525		
			Mot.-Typ 13116	03.02-12.05	6	DBJ	0 445 120 016	0 986 435 531		
270	6,2	195	dCI 6A <Euro 3>	07.01-04.06	6	DBJ	0 445 120 012	0 986 435 525		

Midlum II									
160	4,8	118	DXi 5 160 <Euro 3/4>	05.06-03.09	4	DBB,EU3	0 445 120 074	0 986 435 536	2 430 105 049
					4	DBJ,EU4	0 445 120 064	0 986 435 529	2 430 105 049
180	4,8	132	DXi 5 180 <Euro 5>	04.09-12.14	4	DBJ	0 445 120 064	0 986 435 529	2 430 105 049
190	4,8	140	DXi 5 190 <Euro 3/4>	05.06-03.09	4	DBB,EU3	0 445 120 074	0 986 435 536	2 430 105 049
					4	DBJ,EU4	0 445 120 064	0 986 435 529	2 430 105 049
220	4,8	158	DXi 5 220 <Euro 3/4>	05.06-03.09	4	DBB,EU3	0 445 120 074	0 986 435 536	2 430 105 049
					4	DBJ,EU4	0 445 120 064	0 986 435 529	2 430 105 049
			DXi 5 220 <Euro 5>	03.07-03.09	4	DBB,EU3	0 445 120 074	0 986 435 536	2 430 105 049
					4	DBJ,EU4	0 445 120 064	0 986 435 529	2 430 105 049
					4	DBB,EU3	0 445 120 074	0 986 435 536	2 430 105 049
		162	DXi 5 220 <Euro 5>	04.09-12.14	4	DBJ	0 445 120 064	0 986 435 529	2 430 105 049
240	7,2	177	DXi 7 240 <Euro 3/4>	05.06-03.09	6	DBB,EU3	0 445 120 074	0 986 435 536	2 430 105 049
					6	DBJ,EU4	0 445 120 064	0 986 435 529	2 430 105 049
270	7,2	199	DXi 7 270 <Euro 5>	04.09-12.14	6	DBJ	0 445 120 064	0 986 435 529	2 430 105 049
280	7,2	206	DXi 7 280 <Euro 3/4>; DXi 7 280 <Euro 5>	05.06-03.09	6	DBB,EU3	0 445 120 074	0 986 435 536	2 430 105 049
					6	DBJ,EU4	0 445 120 064	0 986 435 529	2 430 105 049
300	7,2	221	DXi 7 300 <Euro 5>	04.09-12.14	6	DBJ	0 445 120 064	0 986 435 529	2 430 105 049

Premium										
220 Distribution	6,2	158	dCI 6W <Euro 3>	11.00-04.06	6	DBJ	0 445 120 012	0 986 435 525		
270 Distribution, Lander	6,2	195	dCI 6A <Euro 3>	11.00-04.06	6	DBJ	0 445 120 012	0 986 435 525		
320 Distribution, Lander, Route	11,1	229	dCI 11 G <Euro 3>	01.00-04.06	6	DBJ	0 445 120 014	0 986 435 515		
370 Distribution, Lander, Route	11,1	266	dCI 11 E <Euro 3>							
			Mot.-Typ Variante 14102→	11.01-04.06	6	DBJ	0 445 120 019	0 986 435 523		
420 Distribution, Lander, Route	11,1	303	dCI 11 C <Euro 3>	11.00-04.06	6	DBJ	0 445 120 019	0 986 435 523		
			dCI 06.23.56 B43 <Euro 3>	01.00-09.01	6	DBJ	0 445 120 003	0 986 435 509		0 986 435 524

Premium II									
240 Distribution	7,2	177	DXi 7 240 <122CX, Euro 4>	06.06-03.09	6	DBJ	0 445 120 064	0 986 435 529	2 430 105 049
270 Distribution, Lander	7,2	199	DXi 7 270 <Euro 5>	04.09-12.14	6	DBJ	0 445 120 064	0 986 435 529	2 430 105 049
280 Distribution	7,2	206	DXi 7 280 <122CW, Euro 4>	06.06-03.09	6	DBJ	0 445 120 064	0 986 435 529	2 430 105 049
Distribution, Lander	7,2	206	DXi 7 280 <Euro 5>	03.07-03.09	6	DBJ	0 445 120 064	0 986 435 529	2 430 105 049
Lander	7,2	206	DXi 7 280 <122CW, Euro 4>	03.07-03.09	6	DBB	0 445 120 074	0 986 435 536	2 430 105 049
310 Distribution, Lander	7,2	228	DXi 7 310 <Euro 5>	04.09-12.14	6	DBJ	0 445 120 064	0 986 435 529	2 430 105 049
320 Distribution	7,2	235	DXi 7 320 <122CY, Euro 4>	05.06-03.09	6	DBJ	0 445 120 064	0 986 435 529	2 430 105 049
Distribution, Lander	7,2	235	DXi 7 320 <Euro 5>	03.07-03.09	6	DBJ	0 445 120 064	0 986 435 529	2 430 105 049
Lander	7,2	235	DXi 7 320 <122CY, Euro 4>	03.07-03.09	6	DBB	0 445 120 074	0 986 435 536	2 430 105 049
340 Distribution, Lander	7,2	250	DXi 7 340 <Euro 5>	04.09-12.14	6	DBJ	0 445 120 064	0 986 435 529	2 430 105 049





◀ RENAULT

Trafic II									
1.9 dCi [EL/FL/JL]	1,9	60	F9Q 762	05.01-12.06	4	DBB	0 445 110 146	0 986 435 007	1 987 972 077
		74	F9Q 760	06.01-12.06	4	DBB	0 445 110 146	0 986 435 007	1 987 972 077
		75	F9Q 760	01.06-12.14	4	DBB	0 445 110 146	0 986 435 007	
2.0 dCi [EL/FL/JL]	2,0	66/84	M9R 6...; M9R 630	05.10-12.14	4				F 00V C17 504
		66/85	M9R 780	01.06-12.14	4	DBB	0 445 115 007	0 986 435 350	1 987 972 077
		85	M9R 782	01.06-12.14	4	DBB	0 445 115 007	0 986 435 350	1 987 972 077
2.5 dCi [EL/FL/JL]	2,5	84-107	G9U 630	01.06-12.14	4	DBJ	0 445 110 338	0 986 435 202	F 00V C17 504
		98	G9U 730	06.02-12.06	4	DBB	0 445 110 265	0 986 435 170	1 987 972 078
							0 986 435 236		
							0 986 435 275		
							0 986 435 235		
							0 986 435 274		

Trafic III									
1.6 dCi [EG/FG/JG]	1,6	66/85	R9M 408	05.14→	4	DBB	0 445 110 414	0 986 435 211	1 987 972 077
		70/89	R9M 413	08.15→	4	DBB	0 445 110 546	0 986 435 273	1 987 972 077
		88/103/107	R9M 450	05.14→	4	DBB	0 445 110 569		1 987 972 077
		92	R9M 452	08.15→	4	DBB	0 445 110 569		1 987 972 077

**TATA (TELCO)**

Marcopolo									
1628	Divo	6,7	210	ISBe 285 <Euro 3>	04.11→	6	DBJ	0 445 120 123	
Prima K									
3138	8x4	8,9	272	CUM ISLe_EU3	04.11→	6	DBJ	0 445 120 121	0 986 AD1 047

**TEMSA**

Avenue									
Diesel	6,7	184	ISB 6.7 250 <Euro 5>	10.09→	6	DBJ	0 445 120 161		
			ISBe4 250 <Euro 4>	11.08→	6	DBJ	0 445 120 250	0 986 435 533	
Diamant									
13,14	10,5	324	D 2066 LOH04 <Euro 4>	08.06-03.09	6	DBJ	0 445 120 217	0 986 435 526	F 00R J02 175
				08.06→	6	DBJ	0 445 120 217	0 986 435 526	F 00R J02 175
			12,4	353	D 2676 LOH	10.06→	6	DBJ	0 445 120 219
Diamond									
14	12,4	353	D 2676 LOH	10.10→	6	DBJ	0 445 120 202	0 986 435 570	F 00R J02 175
MD									
9	6,9	184/213	D 0836 LOH64 <Euro 5>; D 0836 LOH65 <Euro 5/EEV>	10.10→	6	DBJ	0 445 120 162	0 986 435 565	F 00R J02 175
MD 9									
6.9	6,9	213	D 0836 LOH72 <Euro 6>	06.14→	6	DBJ	0 445 120 162	0 986 435 565	F 00R J02 175
Metropol									
	6,9	177	D 0836 LOH52 <Euro 4/OBD1>	01.07-07.08	6	DBJ	0 445 120 147	0 986 435 562	2 430 105 049
				01.07-10.09	6	DBJ	0 445 120 147	0 986 435 562	2 430 105 049
				08.08-10.09	6	DBJ	0 445 120 147	0 986 435 562	F 00R J02 175
Opalin									
8	4,6	152	D0834 LFL51/52 <Euro 4>	01.07-11.08	4	DBJ	0 445 120 147	0 986 435 562	2 430 105 049
				01.07→	4	DBJ	0 445 120 147	0 986 435 562	2 430 105 049
				12.08→	4	DBJ	0 445 120 147	0 986 435 562	F 00R J02 175
9	6,9	176/177	D 0836 LOH52 <Euro 4>; D 0836 LOH56 <Euro 4/OBD1>	09.05→	6	DBJ	0 445 120 147	0 986 435 562	F 00R J02 175
			184	D 0836 LOH65 <Euro 5/EEV>	11.09→	6	DBJ	0 445 120 162	0 986 435 565
Powerbus									
	4,6	152	D 0834 LFL51 <Euro 4/OBD1>	02.07-12.07	4	DBJ	0 445 120 147	0 986 435 562	2 430 105 049
				02.07→	4	DBJ	0 445 120 147	0 986 435 562	2 430 105 049
				01.08→	4	DBJ	0 445 120 147	0 986 435 562	F 00R J02 175
Prestij									
	3,0	107	4M42 <Euro 4>	01.10→	4	DBJ	0 445 120 073	0 986 435 550	



Safari										
12,13 [RD]	10,5	265	D 2066 LOH06 <Euro 4/OBD1>	02.07→	6	DBJ	0 445 120 217	0 986 435 526		
Tourmalin DD										
12,13	6,7	221	ISBe5 <Euro 5>	08.09→	6	DBJ	0 445 120 161			

## TONAR

24t										
5422	11,1	303	650.10 <Euro 3>	01.10→	6	DBJ	0 445 120 142			
6428	11,1	303	650.10 <Euro 3>	01.10→	6	DBJ	0 445 120 142			
6528	11,1	303	650.10 <Euro 3>	01.10→	6	DBJ	0 445 120 142			

## URAL AUTOMOBIL PLANT

18t										
6367 -31	11,1	266	6501.10 <Euro 3>	12.09→	6	DBJ	0 445 120 142			
29t										
6470	11,1	303	650 DCi 11 <Euro 3>	01.08→	6	DBJ	0 445 120 142			
33t										
63621	11,1	303	650.10 <Euro 3>	01.08→	6	DBJ	0 445 120 142			
65685	11,1	303	650 DCi 11 <Euro 3>	01.08→	6	DBJ	0 445 120 142			
41t										
6563	11,1	303	650 DCi 11 <Euro 3>	01.08→	6	DBJ	0 445 120 142			

## VAUXHALL

Movano										
1.9 DTI [A]	1,9	60	F9Q-772	10.01-10.05	4	DBJ	0 445 110 021			
			F9Q-774	10.01-10.05	4	DBJ,TW	0 445 110 021			
2.2 DTI [A]	2,2	66	G9T-720	01.01-10.05	4	DBB	0 445 110 063	0 986 435 075		
			G9T-722; G9T-750	03.02-10.05	4	DBB	0 445 110 102	0 986 435 106		
2.3 CDTI FFW [B]	2,3	81	M9T 870	06.14→	4	DBJ	0 445 110 375	0 986 435 205	F 00V C17 504	
								0 986 435 234		
CDTI FWD [B]	2,3	74	M9T 87...	10.12→	4	DBJ	0 445 110 375	0 986 435 205	F 00V C17 504	
								0 986 435 234		
		74/92	M9T 67...	04.10→	4	DBJ	0 445 110 375	0 986 435 205	F 00V C17 504	
								0 986 435 234		
		92/107	M9T 6...	04.10→	4	DBJ	0 445 110 375	0 986 435 205	F 00V C17 504	
								0 986 435 234		
			M9T 8...	10.12→	4	DBJ	0 445 110 375	0 986 435 205	F 00V C17 504	
								0 986 435 234		
CDTI RWD [B]	2,3	74/92/ 107	M9T 69...	04.10→	4	DBJ	0 445 110 375	0 986 435 205	F 00V C17 504	
								0 986 435 234		
			M9T 89...	10.12→	4	DBJ	0 445 110 375	0 986 435 205	F 00V C17 504	
								0 986 435 234		
2.5 DTI [A]	2,5	74-84	G9U-75... <Turbo>; G9U-724 <Turbo>	10.03-03.10	4		0 445 110 141	0 986 435 086		
								0 986 435 239		
		74-88/ 107	G9U-6... <Turbo>; G9U-632 <Turbo>	08.06-03.10	4	DBB	0 445 110 265	0 986 435 170		
								0 986 435 236		
								0 986 435 275		
		84	G9U 7...	10.01-03.07	4		0 445 110 141	0 986 435 086		
								0 986 435 239		
					4	DBB,TW	0 445 110 087	0 986 435 079		
								0 986 435 235		
								0 986 435 274		







◀ VAUXHALL

Vivaro										
1.6 CDTI [B]	1,6	70/92	R9M							
			Mot.-Typ R9M-MA	11.15→	4	DBB,TW	0 445 110 569			
			Mot.-Typ R9M-MB							
			Mot.-Typ R9M-MC							
			Mot.-Typ R9M-MG							
			Mot.-Typ R9M-MH							
			Mot.-Typ R9M-MD	11.15→	4	DBB,TW	0 445 110 414	0 986 435 211		
			Mot.-Typ R9M-ME							
Vivaro										
1.6 CDTI [B]	1,6	66/85/88/103/107	R9M							
			Mot.-Typ R9M-MA	10.14→	4	DBB,TW	0 445 110 569			
			Mot.-Typ R9M-MB							
			Mot.-Typ R9M-MC							
			Mot.-Typ R9M-MG							
			Mot.-Typ R9M-MH							
			Mot.-Typ R9M-MD	10.14→	4	DBB,TW	0 445 110 414	0 986 435 211		
			Mot.-Typ R9M-ME							
1.9 DI, DTI [A]	1,9	59-60/74	F9Q-760; F9Q-762	03.01-08.06	4	DBJ	0 445 110 021			
2.0 CDTI [A]	2,0	66/84	M9R 6...	12.10-08.14	4	DBJ	0 445 110 375	0 986 435 205		
			M9R 78...					0 986 435 234		
			Mot.-Typ M9R 780	08.06-08.14	4	DBB	0 445 115 007	0 986 435 350		
			Mot.-Typ M9R 782							
			Mot.-Typ M9R 784							
			Mot.-Typ M9R 786	08.06-08.14	4	DBJ	0 445 110 338	0 986 435 202		F 00VC17 504
			Mot.-Typ M9R 788							
2.5 CDTI [A]	2,5	84	G9U 630							
			Mot.-Typ 630	08.06-06.08	4	DBB	0 445 110 265	0 986 435 170		
								0 986 435 236		
								0 986 435 275		
			Mot.-Typ 730	08.06-06.08	4	DBB	0 445 110 087	0 986 435 079		
								0 986 435 235		
								0 986 435 274		
		107	G9U 630	08.06-08.14	4	DBB	0 445 110 265	0 986 435 170		
								0 986 435 236		
								0 986 435 275		
DTI [A]	2,5	99	G9U-730 <Turbo>	04.04-08.06	4	DBB	0 445 110 087	0 986 435 079		
								0 986 435 235		
								0 986 435 274		



**VOLVO**

FE									
240	7,1	177	D7E240; D7F240	05.06→	6	DBJ	0 445 120 064	0 986 435 529	2 430 105 049
260	7,1	191	D7F260	05.09→	6	DBJ	0 445 120 064	0 986 435 529	2 430 105 049
280	7,1	206	D7E280	05.06→	6	DBJ	0 445 120 064	0 986 435 529	2 430 105 049
300	7,1	221	D7F300	05.09→	6	DBJ	0 445 120 064	0 986 435 529	2 430 105 049
320	7,1	235	D7E320	05.06→	6	DBJ	0 445 120 064	0 986 435 529	2 430 105 049
340	7,1	250	D7F340	05.09→	6	DBJ	0 445 120 064	0 986 435 529	2 430 105 049
FL									
240	7,1	177	D7E240; D7F240	05.06→	6	DBJ	0 445 120 064	0 986 435 529	2 430 105 049
260	7,1	191	D7F260	04.09→	6	DBJ	0 445 120 064	0 986 435 529	2 430 105 049
280	7,1	206	D7E280	05.06→	6	DBJ	0 445 120 064	0 986 435 529	2 430 105 049
290	7,1	213	D7F290	04.09→	6	DBJ	0 445 120 064	0 986 435 529	2 430 105 049
320	7,1	236	D7E320	05.06→	6	DBJ	0 445 120 064	0 986 435 529	2 430 105 049



VW (VOLKSWAGEN)

California T5											
2.0 TDI [7E]	2,0	62	CAAA <D54>	09.09-08.15	4	DBJ	0 445 116 034	0 986 435 369	F 00V P01 004		
		75	CAAB <D55>	09.09-08.15	4	DBJ	0 445 116 034	0 986 435 369	F 00V P01 004		
		84	CAAD <DK3>	05.11-08.15	4	DBJ	0 445 116 034	0 986 435 369	F 00V P01 004		
TDI, TDI 4Motion [7E]	2,0	100	CAAE <D94>	06.10-08.15	4	DBJ	0 445 116 034	0 986 435 369	F 00V P01 004		
			CCHB <D94>	06.10-08.15	4	DBJ	0 445 116 034	0 986 435 369	F 00V P01 004		
		103	CAAC <D94>	09.09-08.15	4	DBJ	0 445 116 034	0 986 435 369	F 00V P01 004		
			CCHA <D91>	09.09-08.15	4	DBJ	0 445 116 034	0 986 435 369	F 00V P01 004		
		132	CFCA <D49>	09.09-08.15	4	DBJ	0 445 116 034	0 986 435 369	F 00V P01 004		
California T6											
2.0 TDI [SG]	2,0	75	CAAB <D55>	04.15→	4	DBJ	0 445 116 034	0 986 435 369	F 00V P01 004		
TDI, TDI 4Motion [SG]	2,0	103	CAAC <D94>	04.15→	4	DBJ	0 445 116 034	0 986 435 369	F 00V P01 004		
		132	CFCA <D49>	04.15→	4	DBJ	0 445 116 034	0 986 435 369	F 00V P01 004		
Caravelle T5											
2.0 TDI [7E]	2,0	62	CAAA <D54>	09.09-08.15	4	DBJ	0 445 116 034	0 986 435 369	F 00V P01 004		
		75	CAAB <D55>	09.09-08.15	4	DBJ	0 445 116 034	0 986 435 369	F 00V P01 004		
		84	CAAD <DK3>	05.11-08.15	4	DBJ	0 445 116 034	0 986 435 369	F 00V P01 004		
TDI, TDI 4Motion [7E]	2,0	100	CAAE <D94>	06.10-08.15	4	DBJ	0 445 116 034	0 986 435 369	F 00V P01 004		
			CCHB <D94>	06.10-08.15	4	DBJ	0 445 116 034	0 986 435 369	F 00V P01 004		
		103	CAAC <D94>	09.09-08.15	4	DBJ	0 445 116 034	0 986 435 369	F 00V P01 004		
			CCHA <D91>	09.09-08.15	4	DBJ	0 445 116 034	0 986 435 369	F 00V P01 004		
		132	CFCA <D49>	09.09-08.15	4	DBJ	0 445 116 034	0 986 435 369	F 00V P01 004		
Caravelle T6											
2.0 TDI [SG]	2,0	62	CAAA <D54>	04.15-06.16	4	DBJ	0 445 116 034	0 986 435 369	F 00V P01 004		
		75	CAAB <D55>	04.15→	4	DBJ	0 445 116 034	0 986 435 369	F 00V P01 004		
TDI, TDI 4Motion [SG]	2,0	103	CAAC <D94>	04.15→	4	DBJ	0 445 116 034	0 986 435 369	F 00V P01 004		
		132	CFCA <D49>	04.15→	4	DBJ	0 445 116 034	0 986 435 369	F 00V P01 004		
Crafter 30											
2.0 BitDI [2E, 2F]	2,0	105/120	CKUB <D92>; CKUC <D46>	07.11-12.16	4	DBJ,EU4,EU5	0 445 110 646	0 986 435 166	F 00V P01 004		
								0 986 435 167			
				4	DBJ,EU6	0 445 110 550	0 986 435 276	F 00V P01 004			
		120	CSNA	10.13-12.16	4	DBJ	0 445 110 550	0 986 435 276	F 00V P01 004		
		TDI [2E, 2F]	2,0	80	CKTB <DK2>	05.11-12.16	4	DBJ,EU4,EU5	0 445 110 646	0 986 435 166	F 00V P01 004
										0 986 435 167	
				4	DBJ,EU6	0 445 110 550	0 986 435 276	F 00V P01 004			
				4	DBJ	0 445 110 550	0 986 435 276	F 00V P01 004			
				84	CSLB <DK3>	10.13-12.16	4	DBJ	0 445 110 550	0 986 435 276	F 00V P01 004
				100	CKTC <D94>	05.11-12.16	4	DBJ,EU4,EU5	0 445 110 646	0 986 435 166	F 00V P01 004
					4	DBJ,EU6	0 445 110 550	0 986 435 276	F 00V P01 004		
		103	CSLC <D91>	11.15-12.16	4	DBJ	0 445 110 550	0 986 435 276	F 00V P01 004		
Crafter 35											
2.5 TDI [2E, 2F]	2,5	65	BJJ <D5K>	04.06-07.11	5	DBJ	0 445 115 028	0 986 435 352	F 00V C17 505		
								0 986 435 352			
				5	DBJ	0 445 115 028	0 986 435 352	F 00V C17 505			
				5	DBJ	0 445 115 028	0 986 435 352	F 00V C17 505			
				80	BJK <D5L>	04.06-05.13	5	DBJ	0 445 115 028	0 986 435 352	F 00V C17 505
					CEBB <D5L>	05.09-07.11	5	DBJ	0 445 115 028	0 986 435 352	F 00V C17 505
				100	BJL <D5M>	04.06-05.13	5	DBJ	0 445 115 028	0 986 435 352	F 00V C17 505
					CECA <D5M>	05.09-07.11	5	DBJ	0 445 115 028	0 986 435 352	F 00V C17 505
				120	BJM <D5N>	04.06-07.11	5	DBJ	0 445 115 028	0 986 435 352	F 00V C17 505
					CECB <D5N>	05.09-07.11	5	DBJ	0 445 115 028	0 986 435 352	F 00V C17 505
Crafter 35											
2.0 BitDI [2E, 2F]	2,0	105/120	CKUB <D92>; CKUC <D46>	07.11-12.16	4	DBJ,EU4,EU5	0 445 110 646	0 986 435 166	F 00V P01 004		
								0 986 435 167			
				4	DBJ,EU6	0 445 110 550	0 986 435 276	F 00V P01 004			
		BitDI, TDI [2E, 2F]	2,0	84/120	CSLB <DK3>; CSNA	05.13-12.16	4	DBJ	0 445 110 550	0 986 435 276	F 00V P01 004
		TDI [2E, 2F]	2,0	80	CKTB <DK2>	05.11-12.16	4	DBJ,EU4,EU5	0 445 110 646	0 986 435 166	F 00V P01 004
										0 986 435 167	
				4	DBJ,EU6	0 445 110 550	0 986 435 276	F 00V P01 004			
				4	DBJ	0 445 110 550	0 986 435 276	F 00V P01 004			
					CSLA <DK2>	11.15-12.16	4	DBJ	0 445 110 550	0 986 435 276	F 00V P01 004





◀ VW

2.0 TDI [2E, 2F]	2,0	100	CKTC <D94>	05.11-12.16	4	DBJ,EU4,EU5	0 445 110 646	0 986 435 166	F 00V P01 004
							0 986 435 167		
		103	CSLC <D91>	11.15-12.16	4	DBJ	0 445 110 550	0 986 435 276	F 00V P01 004
2.5 TDI [2E, 2F]	2,5	65	BJJ <D5K>	04.06-07.11	5	DBJ	0 445 115 028	0 986 435 352	F 00V C17 505
			CEBA <D5K>	05.09-07.11	5	DBJ	0 445 115 028	0 986 435 352	F 00V C17 505
		80	BJK <D5L>	04.06-05.13	5	DBJ	0 445 115 028	0 986 435 352	F 00V C17 505
			CEBB <D5L>	05.09-05.13	5	DBJ	0 445 115 028	0 986 435 352	F 00V C17 505
		100	BJL <D5M>	04.06-05.13	5	DBJ	0 445 115 028	0 986 435 352	F 00V C17 505
			CECA <D5M>	05.09-05.13	5	DBJ	0 445 115 028	0 986 435 352	F 00V C17 505
			120	BJM <D5N>	04.06-07.11	5	DBJ	0 445 115 028	0 986 435 352
			CECB <D5N>	05.09-07.11	5	DBJ	0 445 115 028	0 986 435 352	F 00V C17 505

**Crafter 50**

2.0 BitDI [2E, 2F]	2,0	105/120	CKUB <D92>; CKUC <D46>	07.11-12.16	4	DBJ,EU4,EU5	0 445 110 646	0 986 435 166	F 00V P01 004		
							0 986 435 167				
		120	CSNA	10.13-12.16	4	DBJ	0 445 110 550	0 986 435 276	F 00V P01 004		
TDI [2E, 2F]	2,0	80	CKTB <DK2>	05.11-12.16	4	DBJ,EU4,EU5	0 445 110 646	0 986 435 166	F 00V P01 004		
							0 986 435 167				
					CSLA <DK2>	11.15-12.16	4	DBJ	0 445 110 550	0 986 435 276	F 00V P01 004
				84	CSLB <DK3>	10.13-12.16	4	DBJ	0 445 110 550	0 986 435 276	F 00V P01 004
				100	CKTC <D94>	05.11-12.16	4	DBJ,EU4,EU5	0 445 110 646	0 986 435 166	F 00V P01 004
					0 986 435 167						
									0 445 110 550	0 986 435 276	F 00V P01 004
2.5 TDI [2E, 2F]	2,5	80	BJK <D5L>	04.06-05.13	5	DBJ	0 445 115 028	0 986 435 352	F 00V C17 505		
			CEBB <D5L>	05.09-05.13	5	DBJ	0 445 115 028	0 986 435 352	F 00V C17 505		
		100	BJL <D5M>	04.06-05.13	5	DBJ	0 445 115 028	0 986 435 352	F 00V C17 505		
			CECA <D5M>	05.09-05.13	5	DBJ	0 445 115 028	0 986 435 352	F 00V C17 505		
			120	BJM <D5N>	04.06-07.11	5	DBJ	0 445 115 028	0 986 435 352	F 00V C17 505	
			CECB <D5N>	05.09-07.11	5	DBJ	0 445 115 028	0 986 435 352	F 00V C17 505		

**LT**

28 2.8 TDI [2D, 2H]	2,8	116	AUH	02.02-04.06	4	DBB	0 445 110 081	0 986 435 252	F 00V C17 504
			BCQ				06.03-04.06	4	
35 2.8 TDI [2D, 2H]	2,8	116	AUH	02.02-04.06	4	DBB	0 445 110 081	0 986 435 252	F 00V C17 504
			BCQ				06.03-04.06	4	
46 2.8 TDI [2D, 2H]	2,8	116	AUH	02.02-04.06	4	DBB	0 445 110 081	0 986 435 252	F 00V C17 504

**Multivan T5**

2.0 TDI [7E]	2,0	62	CAAA <D54>	09.09-08.15	4	DBJ	0 445 116 034	0 986 435 369	F 00V P01 004					
			75				CAAB <D55>	09.09-08.15		4	DBJ	0 445 116 034	0 986 435 369	F 00V P01 004
			84				CAAD <DK3>	05.11-08.15		4	DBJ	0 445 116 034	0 986 435 369	F 00V P01 004
TDI, TDI 4Motion [7E]	2,0	100	CAAE <D94>	06.10-08.15	4	DBJ	0 445 116 034	0 986 435 369	F 00V P01 004					
			CCHB <D94>				06.10-08.15	4		DBJ	0 445 116 034	0 986 435 369	F 00V P01 004	
		103	CAAC <D94>	09.09-08.15	4	DBJ	0 445 116 034	0 986 435 369	F 00V P01 004					
			CCHA <D91>	09.09-08.15	4	DBJ	0 445 116 034	0 986 435 369	F 00V P01 004					
			132	CFCA <D49>	09.09-08.15	4	DBJ	0 445 116 034	0 986 435 369	F 00V P01 004				

**Multivan T6**

2.0 TDI [SG]	2,0	75	CAAB <D55>	04.15→	4	DBJ	0 445 116 034	0 986 435 369	F 00V P01 004
			103				CAAC <D94>	04.15→	
TDI, TDI 4Motion [SG]	2,0	132	CFCA <D49>	04.15→	4	DBJ	0 445 116 034	0 986 435 369	F 00V P01 004
TDI 4Motion [SSG]	2,0	103	CAAC <D94>	04.15→	4	DBJ	0 445 116 034	0 986 435 369	F 00V P01 004

**Transporter T5**

2.0 TDI [7E]	2,0	62	CAAA <D54>	09.09-08.15	4	DBJ	0 445 116 034	0 986 435 369	F 00V P01 004					
			75				CAAB <D55>	09.09-08.15		4	DBJ	0 445 116 034	0 986 435 369	F 00V P01 004
			84				CAAD <DK3>	05.11-08.15		4	DBJ	0 445 116 034	0 986 435 369	F 00V P01 004
TDI [7F]	2,0	62	CAAA <D54>	09.09-08.15	4	DBJ	0 445 116 034	0 986 435 369	F 00V P01 004					
			75				CAAB <D55>	09.09-08.15		4	DBJ	0 445 116 034	0 986 435 369	F 00V P01 004
				84	CAAD <DK3>	05.11-08.15	4	DBJ	0 445 116 034	0 986 435 369	F 00V P01 004			
TDI, TDI 4Motion [7E]	2,0	100	CAAE <D94>	06.10-08.15	4	DBJ	0 445 116 034	0 986 435 369	F 00V P01 004					
			CCHB <D94>				06.10-08.15	4		DBJ	0 445 116 034	0 986 435 369	F 00V P01 004	
				103	CAAC <D94>	09.09-08.15	4	DBJ	0 445 116 034	0 986 435 369	F 00V P01 004			



2.0 TDI, TDI 4Motion [7E]	2,0	103	CCHA <D91>	09.09-08.15	4	DBJ	<b>0 445 116 034</b>	<b>0 986 435 369</b>	<b>F 00V P01 004</b>
		132	CFCA <D49>	09.09-08.15	4	DBJ	<b>0 445 116 034</b>	<b>0 986 435 369</b>	<b>F 00V P01 004</b>
TDI, TDI 4Motion [7F]	2,0	100	CAAE <D94>	06.10-08.15	4	DBJ	<b>0 445 116 034</b>	<b>0 986 435 369</b>	<b>F 00V P01 004</b>
		103	CAAC <D94>	09.09-08.15	4	DBJ	<b>0 445 116 034</b>	<b>0 986 435 369</b>	<b>F 00V P01 004</b>
			CCHA <D91>	05.11-08.15	4	DBJ	<b>0 445 116 034</b>	<b>0 986 435 369</b>	<b>F 00V P01 004</b>
		132	CFCA <D49>	09.09-08.15	4	DBJ	<b>0 445 116 034</b>	<b>0 986 435 369</b>	<b>F 00V P01 004</b>
TDI 4Motion [7F]	2,0	100	CCHB <D94>	05.11-08.15	4	DBJ	<b>0 445 116 034</b>	<b>0 986 435 369</b>	<b>F 00V P01 004</b>
<b>Transporter T6</b>									
2.0 TDI [SF]	2,0	62	CAAA <D54>	04.15→	4	DBJ	<b>0 445 116 034</b>	<b>0 986 435 369</b>	<b>F 00V P01 004</b>
		75	CAAB <D55>	04.15→	4	DBJ	<b>0 445 116 034</b>	<b>0 986 435 369</b>	<b>F 00V P01 004</b>
TDI [SG]	2,0	62	CAAA <D54>	04.15-06.16	4	DBJ	<b>0 445 116 034</b>	<b>0 986 435 369</b>	<b>F 00V P01 004</b>
		75	CAAB <D55>	04.15→	4	DBJ	<b>0 445 116 034</b>	<b>0 986 435 369</b>	<b>F 00V P01 004</b>
TDI, TDI 4Motion [SF]	2,0	103	CAAC <D94>	04.15→	4	DBJ	<b>0 445 116 034</b>	<b>0 986 435 369</b>	<b>F 00V P01 004</b>
		132	CFCA <D49>	04.15→	4	DBJ	<b>0 445 116 034</b>	<b>0 986 435 369</b>	<b>F 00V P01 004</b>
TDI, TDI 4Motion [SG]	2,0	103	CAAC <D94>	04.15→	4	DBJ	<b>0 445 116 034</b>	<b>0 986 435 369</b>	<b>F 00V P01 004</b>
		132	CFCA <D49>	04.15→	4	DBJ	<b>0 445 116 034</b>	<b>0 986 435 369</b>	<b>F 00V P01 004</b>

ZIL

<b>4331</b>									
433185	7,1	169	D 260.5 E3 <Euro 3>	05.08→	6	DBJ	<b>0 445 120 141</b>		
<b>4334</b>									
4334B1	4,8	115	D 245.30 E3 <Euro 3>	05.08→	4	DBJ	<b>0 445 120 141</b>		
<b>5301</b>									
5301EE	4,8	96	D 245.9 E3 <Euro 3>	01.10→	4	DBJ	<b>0 445 120 141</b>		





## CASE

Serie 1000										
1150K	6,7	88	<Tier 3>	10.06-12.13	6	DBJ	0 445 120 212	0 986 435 508		
SN										
580	4,5	71	445TA <Tier 3>	03.12→	4	DBJ	0 445 120 054	0 986 435 545		
590	4,5	81	445TA <Tier 3>	03.12→	4	DBJ	0 445 120 054	0 986 435 545		
SR										
220	3,4	61	F5HFL413A <Tier 4>	01.13-12.14	4	DBJ	0 445 110 457	0 986 435 254		
250	3,4	67	F5HFL413A <Tier 4>	07.12-03.16	4	DBJ	0 445 110 457	0 986 435 254		
580	4,5	71	445TA <Tier 3>	03.08-12.10	4	DBJ	0 445 120 054	0 986 435 545		
590	4,5	81	445TA <Tier 3>	01.07-12.10	4	DBJ	0 445 120 054	0 986 435 545		
695	4,5	81	445TA <Tier 3>	01.07-12.10	4	DBJ	0 445 120 054	0 986 435 545		
ST										
580	4,5	71	445TA <Tier 3>	10.10→	4	DBJ	0 445 120 054	0 986 435 545		
590	4,5	81	445TA <Tier 3>	10.10→	4	DBJ	0 445 120 054	0 986 435 545		
695	4,5	81	445TA <Tier 3>	10.10→	4	DBJ	0 445 120 054	0 986 435 545		
SV										
250	3,4	61	F5HFL413A <Tier 4>	01.13→	4	DBJ	0 445 110 457	0 986 435 254		
300	3,4	67	F5H <Stage 3b/Tier 4f>	09.15→	4	DBJ	0 445 110 457	0 986 435 254		
TR										
320	3,4	67	F5HFL413A <Tier 4>	07.12-09.16	4	DBJ	0 445 110 457	0 986 435 254		
TV										
380	3,4	66	F5H <Stage 3b/Tier 4f>	09.15→	4	DBJ	0 445 110 457	0 986 435 254		

## CASE IH (CASE INTERNATIONAL)

Maxxum MXU										
110 24X24	4,5	85		07.03-12.07	4	DBJ	0 445 120 273	0 986 435 571		
125 24X24	6,7	92		07.03-12.07	6	DBJ	0 445 120 273	0 986 435 571		
135 24X24	6,7	99		07.03-12.07	6	DBJ	0 445 120 273	0 986 435 571		

## FENDT

Serie C										
5270	7,4	199	74 CTA	09.06-12.11	6	DBJ	0 445 120 340	0 986 435 547		
5275	7,4	202	74 AWI <Stage 3b/Tier 4>	09.10-12.14	6	DBJ	0 445 120 235			
6300	8,4	224	84 CTA	09.06-12.11	6	DBJ	0 445 120 340	0 986 435 547		
6335	8,4	247	84 AWI <Stage 3b/Tier 4>	09.10-12.14	6	DBJ	0 445 120 235			
Serie E										
5220	6,6	162	66 AWI <Stage 3b/Tier 4>	09.11-12.15	6	DBJ	0 445 120 235			
Serie L										
5255	6,6	188	66 AWI <Stage 3b/Tier 4>	09.10-12.14	6	DBJ	0 445 120 235			
6270	7,4	199	74 CTA	09.14→	6	DBJ	0 445 120 340	0 986 435 547		
6275	7,4	202	74 AWI <Stage 3b/Tier 4>	09.10-12.14	6	DBJ	0 445 120 235			
Serie P										
8370	8,4	272	84 CTA	09.07-12.11	6	DBJ	0 445 120 340	0 986 435 547		
		275	84 AWI <Stage 3b/Tier 4>	09.10-12.13	6	DBJ	0 445 120 235			
8400	8,4	297	84 AWI <Stage 3b/Tier 4>	09.10-12.13	6	DBJ	0 445 120 235			
			84 CTA	09.07-12.11	6	DBJ	0 445 120 340	0 986 435 547		
Serie R										
9300	8,4	221	84 CTA	09.08-12.12	6	DBJ	0 445 120 340	0 986 435 547		
9350	8,4	258	84 CTA	09.08-12.12	6	DBJ	0 445 120 340	0 986 435 547		
9390	8,4	287	84 AWI <Stage 3b/Tier 4>	09.08-12.12	6	DBJ	0 445 120 235			
9480	9,8	353	98 ATI	09.08-12.12	7	DBJ	0 445 120 235			
Serie X										
9470	9,8	346	98 ATI	09.09-12.13	7	DBJ	0 445 120 235			
			98 CTA	09.09-12.13	7	DBJ	0 445 120 340	0 986 435 547		
Serie 200 Vario										
207	3,3	52,2	33CTA	09.10→	3	DBJ	0 445 110 381	0 986 435 206		





208	3,3	60	33CTA	09.10→	3	DBJ	0 445 110 381	0 986 435 206
209	3,3	67	33CTA	09.10→	3	DBJ	0 445 110 381	0 986 435 206
210	3,3	73	33CTA	09.10→	3	DBJ	0 445 110 381	0 986 435 206
211	3,3	74-81	33CTA	09.10→	3	DBJ	0 445 110 381	0 986 435 206
<b>Serie 300 Vario</b>								
306	4,0	68	TCD 4.1 L4 <Stage 4/Tier 4i>	09.12→	4	DBJ	0 445 120 065	0 986 435 559
310	4,0	76	TCD 4.1 L4 <Stage 4/Tier 4i>	09.12→	4	DBJ	0 445 120 065	0 986 435 559
311	4,0	83	TCD 4.1 L4 <Stage 4/Tier 4i>	09.12→	4	DBJ	0 445 120 065	0 986 435 559
312	4,0	90	TCD 4.1 L4 <Stage 4/Tier 4i>	09.12→	4	DBJ	0 445 120 065	0 986 435 559
<b>Serie 400 Vario</b>								
411	4,0	85	TCD 2012 L04 <Tier 4>	09.10→	4	DBJ	0 445 120 065	0 986 435 559
412	4,0	92	TCD 2012 L04 <Tier 4>	09.10→	4	DBJ	0 445 120 065	0 986 435 559
413	4,0	99	TCD 2012 L04 <Tier 4>	09.10→	4	DBJ	0 445 120 065	0 986 435 559
414	4,0	107	TCD 2012 L04 <Tier 4>	09.10→	4	DBJ	0 445 120 065	0 986 435 559
415	4,0	114	TCD 2012 L04 <Tier 4>	09.10→	4	DBJ	0 445 120 065	0 986 435 559
<b>Serie 700 Vario</b>								
712	6,1	97	TCD 2012 L06-2V <Stage 3a/Tier 3>	09.10-12.14	6	DBJ	0 445 120 065	0 986 435 559
714	6,1	107	TCD 2012 L06-2V <Stage 3a/Tier 3>	09.10-12.14	6	DBJ	0 445 120 065	0 986 435 559
716	6,1	120	TCD 2012 L06-2V <Stage 3a/Tier 3>	09.10-12.14	6	DBJ	0 445 120 065	0 986 435 559
718	6,1	133	TCD 2012 L06-2V <Stage 3a/Tier 3>	09.10-12.14	6	DBJ	0 445 120 065	0 986 435 559
<b>Serie 8000</b>								
8300	8,4	224	84 CTA	09.07-12.12	6	DBJ	0 445 120 340	0 986 435 547
8350	8,4	258	84 CTA	09.07-12.12	6	DBJ	0 445 120 340	0 986 435 547

KOMATSU

**BR-Serie**

380JG-1E0	6,7	140-149	SAA6D107 Fg.-Nr. 2616→2001→ Mot.-Nr. 26500006→ 26546230→	06.13→	6	DBJ,TW	0 445 120 059	0 986 435 597
-----------	-----	---------	---	--------	---	--------	---------------	---------------

**D-Serie**

31	3,3	58-60	SAA4D95LE-5 Fg.-Nr. 60001→ Mot.-Nr. 503228→	05.14→	4	DBB	0 445 110 307	0 986 435 196
37	3,3	66-68	SAA4D95LE-5 Fg.-Nr. 60001→ Mot.-Nr. 503228→	05.14→	4	DBB	0 445 110 307	0 986 435 196
39EX-22	4,5	79	SAA4D107 Fg.-Nr. 3001→ Mot.-Nr. 26513014→	01.13→	4	DBJ,TW	0 445 120 059	0 986 435 597
39PX-22	4,5	79	SAA4D107 Fg.-Nr. 3001→ Mot.-Nr. 26513014→	01.13→	4	DBJ,TW	0 445 120 059	0 986 435 597
65-17	8,3	153-164	SAA6D114 Fg.-Nr. 1001→ Mot.-Nr. 26900001→	09.10→	6	DBJ	0 445 120 305	

**GD-Serie**

555-5	6,7	144-146	SAA6D107 Fg.-Nr. 55001→ Mot.-Nr. 26540713→	08.11→	6	DBJ,TW	0 445 120 059	0 986 435 597
655-5	6,7	163-165	SAA6D107 Fg.-Nr. 55001→B40001→ Mot.-Nr. 26540705→	04.14→	6	DBJ	0 445 120 059	0 986 435 597

**HB-Serie**

205LC-1	4,5	104-110	SAA4D107 Fg.-Nr. 10001→ Mot.-Nr. 102262→	03.11→	4	DBJ	0 445 120 059	0 986 435 597
205-1	4,5	104-110	SAA4D107 Fg.-Nr. 1001→ Mot.-Nr. 26554518→	03.11→	4	DBJ	0 445 120 059	0 986 435 597







◀ KOMATSU

<b>215LC-1</b>	4,5	104-110	SAA4D107 Fg.-Nr. 1001→ Mot.-Nr. 26554518→ Fg.-Nr. 10001→ Mot.-Nr. 102262→	03.11→	4	DBJ	<b>0 445 120 059</b>	<b>0 986 435 597</b>	
<b>PC-Serie</b>									
<b>70-8</b>	3,3	48-50	SAA4D95LE-5 Fg.-Nr. 10011→ Mot.-Nr. 500001→	06.11→	4	DBB	<b>0 445 110 307</b>	<b>0 986 435 196</b>	
<b>78-8</b>	3,3	41-42	SAA4D95LE-5 Fg.-Nr. 15001→ Mot.-Nr. 504574→	10.08→	4	DBB	<b>0 445 110 307</b>	<b>0 986 435 196</b>	
<b>88MR-8</b>	3,3	49-50	SAA4D95LE-5 Fg.-Nr. 5001→ Mot.-Nr. 502711→	04.13→	4	DBB	<b>0 445 110 307</b>	<b>0 986 435 196</b>	
<b>130-8</b>	3,3	68-72	SAA4D95LE-5 Fg.-Nr. 80001→ Mot.-Nr. 501795→ Fg.-Nr. C30001→ Mot.-Nr. 502660→ Fg.-Nr. B10001→ Mot.-Nr. 26501795→	05.13→	4	DBB	<b>0 445 110 307</b>	<b>0 986 435 196</b>	
<b>138UD-8</b>	3,3	68-72	SAA4D95LE-5 Fg.-Nr. 24510→ Mot.-Nr. 500001→ Fg.-Nr. 20001→24509 20001→	03.12→	4	DBB	<b>0 445 110 307</b>	<b>0 986 435 196</b>	
<b>138USLC-8</b>	3,3	68-72	SAA4D95LE-5 Fg.-Nr. 24510→ Mot.-Nr. 500001→ Fg.-Nr. 20001→24509 20001→	03.12→	4	DBB	<b>0 445 110 307</b>	<b>0 986 435 196</b>	
<b>160LC-7</b>	4,5	86-90	SAA4D107 Fg.-Nr. 20001→ Mot.-Nr. 26503098→	01.10→	4	DBJ,TW	<b>0 445 120 059</b>	<b>0 986 435 597</b>	
<b>160LC-8</b>	4,5	86-90	SAA4D107 Fg.-Nr. C20001→ Mot.-Nr. 26527701→ Fg.-Nr. 20551→ Mot.-Nr. 21872538→ Fg.-Nr. K50001→	08.12→	4	DBJ,TW	<b>0 445 120 059</b>	<b>0 986 435 597</b>	
<b>190LC/NLC-8</b>	4,5	92-97	SAA4D107 Mot.-Nr. 21872538→	08.12→	4	DBJ	<b>0 445 120 059</b>	<b>0 986 435 597</b>	
<b>200LC-8</b>	6,7	110-116	SAA6D107 Fg.-Nr. 350001→ Mot.-Nr. 541137→ Fg.-Nr. 315646→ Mot.-Nr. 26594007→ Fg.-Nr. 400001→ Mot.-Nr. 26500006→ Fg.-Nr. 310001→315645 300001→	11.14→	6	DBJ,TW	<b>0 445 120 059</b>	<b>0 986 435 597</b>	
<b>200LC-8EO</b>	4,5	86-90	SAA4D107 Fg.-Nr. 1118→ Mot.-Nr. 541103→ Fg.-Nr. 1001→	01.08→	4	DBJ	<b>0 445 120 059</b>	<b>0 986 435 597</b>	
<b>200LC-8MO</b>	6,7	103-110	SAA6D107	12.15→	6	DBJ	<b>0 445 120 059</b>	<b>0 986 435 597</b>	





<b>200-8</b>	6,7	110-116	SAA6D107 Fg.-Nr. 350001→ Mot.-Nr. 541137→ Fg.-Nr. 315646→ Mot.-Nr. 26594007→ Fg.-Nr. 400001→ Mot.-Nr. 26500006→ Fg.-Nr. 310001→315645 300001→	11.14→	6	DBJ,TW	<b>0 445 120 059</b>	<b>0 986 435 597</b>
<b>200-8E0</b>	4,5	86-90	SAA4D107 Fg.-Nr. 1118→ Mot.-Nr. 541103→ Fg.-Nr. 1001→	01.08→	4	DBJ	<b>0 445 120 059</b>	<b>0 986 435 597</b>
<b>200-8M0</b>	6,7	103-110	SAA6D107	12.15→	6	DBJ	<b>0 445 120 059</b>	<b>0 986 435 597</b>
<b>220LC-8</b>	6,7	125-134	SAA6D107 Fg.-Nr. 80377→ Mot.-Nr. 26542663→ Fg.-Nr. 85001→ Mot.-Nr. 26598590→ Fg.-Nr. 100001→ Mot.-Nr. 26500006→ Fg.-Nr. 80001→70001→ A88001→	06.13→	6	DBJ,TW	<b>0 445 120 059</b>	<b>0 986 435 597</b>
<b>220LC-8M0</b>	6,7	123-129	SAA6D107	09.14→	6	DBJ	<b>0 445 120 059</b>	<b>0 986 435 597</b>
<b>220-8</b>	6,7	125-134	SAA6D107 Fg.-Nr. 80377→ Mot.-Nr. 26542663→ Fg.-Nr. 85001→ Mot.-Nr. 26598590→ Fg.-Nr. 100001→ Mot.-Nr. 26500006→ Fg.-Nr. 80001→70001→ A88001→	06.13→	6	DBJ,TW	<b>0 445 120 059</b>	<b>0 986 435 597</b>
<b>220-8M0</b>	6,7	123-129	SAA6D107	09.14→	6	DBJ	<b>0 445 120 059</b>	<b>0 986 435 597</b>
<b>228USCL-8</b>	6,7	110-116	SAA6D107 Fg.-Nr. 50001→ Mot.-Nr. 26547615→	09.13→	6	DBJ	<b>0 445 120 059</b>	<b>0 986 435 597</b>
<b>228USLC-3E0</b>	6,7	110-116	SAA6D107 Fg.-Nr. 40001→ Mot.-Nr. 26500006→	04.08→	6	DBJ,TW	<b>0 445 120 059</b>	<b>0 986 435 597</b>
<b>228US-3E0</b>	6,7	110-116	SAA6D107 Fg.-Nr. 40001→ Mot.-Nr. 26500006→	04.08→	6	DBJ,TW	<b>0 445 120 059</b>	<b>0 986 435 597</b>
<b>228US-8</b>	6,7	110-116	SAA6D107 Fg.-Nr. 50001→ Mot.-Nr. 26547615→	09.13→	6	DBJ	<b>0 445 120 059</b>	<b>0 986 435 597</b>
<b>240LC-8</b>	6,7	125-134	SAA6D107 Fg.-Nr. B10001→ Mot.-Nr. 26542663→	09.10→	6	DBJ,TW	<b>0 445 120 059</b>	<b>0 986 435 597</b>
<b>270LC-8</b>	6,7	140-149	SAA6D107 Fg.-Nr. 30117→30001→30116 20001→A87001→ Mot.-Nr. 26537659→26500006→	07.08→	6	DBJ	<b>0 445 120 059</b>	<b>0 986 435 597</b>
<b>270LC-8N1-W1</b>	6,7	140-149	SAA6D107 Fg.-Nr. 30117→30001→30116 20001→A87001→ Mot.-Nr. 26537659→26500006→	09.13→	6	DBJ,TW	<b>0 445 120 059</b>	<b>0 986 435 597</b>
<b>270-8</b>	6,7	140-149	SAA6D107 Fg.-Nr. 30117→30001→30116 20001→A87001→ Mot.-Nr. 26537659→26500006→	07.08→	6	DBJ,TW	<b>0 445 120 059</b>	<b>0 986 435 597</b>





◀ KOMATSU

<b>360LC/NLC-10</b>	8,3	192-202	SAA6D114 Fg.-Nr. 70001→ Mot.-Nr. 26900005→ Fg.-Nr. K60001→ Mot.-Nr. 21857369→	02.12→	6	DBJ	<b>0 445 120 305</b>		
<b>380USLC-3E0</b>	6,7	140-149	SAA6D107 Fg.-Nr. 30242→ Mot.-Nr. 537218→	03.13→	6	DBJ	<b>0 445 120 059</b>	<b>0 986 435 597</b>	
<b>WA-Serie</b>									
<b>150-6</b>	3,3	73-74	SAA4D95LE-5 Fg.-Nr. 80001→ Mot.-Nr. 506848→	02.09→	4	DBB	<b>0 445 110 307</b>	<b>0 986 435 196</b>	
<b>200PZ-6</b>	4,5	94-95	SAA4D107	11.07→	4	DBJ,TW	<b>0 445 120 059</b>	<b>0 986 435 597</b>	
<b>200-6</b>	4,5	94-95	SAA4D107 Fg.-Nr. 70001→ Mot.-Nr. 26508146→ Fg.-Nr. 70883→ Mot.-Nr. 26537379→ Fg.-Nr. C10001→ Mot.-Nr. 26503098→ Fg.-Nr. 70001→70882 H00051→ 70136→70342	06.15→	4	DBJ,TW	<b>0 445 120 059</b>	<b>0 986 435 597</b>	
<b>250PZ-6</b>	6,7	104	SAA6D107 Fg.-Nr. 75750→ Mot.-Nr. 26506237→ Fg.-Nr. 75753→ Mot.-Nr. 26500006→ Fg.-Nr. 75001→ 75001→75749 H00051→ 75160→75467	02.13→	6	DBJ,TW	<b>0 445 120 059</b>	<b>0 986 435 597</b>	
<b>250-6</b>	6,7	103-104	SAA6D107 Fg.-Nr. 75750→ Mot.-Nr. 26506237→ Fg.-Nr. 75753→ Mot.-Nr. 26500006→ Fg.-Nr. 75001→ 75001→75749 H00051→ 75160→75467	03.13→	6	DBJ,TW	<b>0 445 120 0590</b>	<b>986 435 597</b>	
<b>320PZ-6</b>	6,7	125-127	SAA6D107 Fg.-Nr. 70291→ Mot.-Nr. 26534228→ Fg.-Nr. 70452→ Mot.-Nr. 26500006→ Fg.-Nr. 70001→70451 70001→70290 H00059→H00256 H62051→	02.13→	6	DBJ,TW	<b>0 445 120 059</b>	<b>0 986 435 597</b>	
<b>320-6</b>	6,7	125-127	SAA6D107 Fg.-Nr. 70291→ Mot.-Nr. 26534228→ Fg.-Nr. 70452→ Mot.-Nr. 26500006→ Fg.-Nr. 70001→70451 70001→70290 H00059→H00256 H62051→	02.13→	6	DBJ,TW	<b>0 445 120 059</b>	<b>0 986 435 597</b>	
<b>380Z-6</b>	6,7	141-143	SAA6D107	08.12→	6	DBJ	<b>0 445 120 059</b>	<b>0 986 435 597</b>	





380-6	6,7	142-143	SAA6D107							
			Fg.-Nr. 65949→	02.13→	6	DBJ,TW	0 445 120 059	0 986 435 597		
			Mot.-Nr. 537463→							
			Fg.-Nr. 66847→							
			Mot.-Nr. 26580638→							
			Fg.-Nr. 65001→65948							
			Mot.-Nr. 26500006→							

**MASSEY FERGUSON (MF)**

<b>Activa</b>										
7244	6,6	166	66 AWI <Stage 3b/Tier 4>	01.11-12.15	6	DBJ	0 445 120 235			
<b>Activa S</b>										
7247	7,4	202	74 CTA	01.08-12.11	6	DBJ	0 445 120 340	0 986 435 547		
7345/MCS	6,6	175-179	66 AWI <Stage 3b/Tier 4>	01.11-12.14	6	DBJ	0 445 120 235			
<b>Beta</b>										
7260/AL	7,4	202	74 CTA	01.07-12.11	6	DBJ	0 445 120 340	0 986 435 547		
7270/AL	8,4	247	84 CTA	01.07-12.11	6	DBJ	0 445 120 340	0 986 435 547		
7360/PL	7,4	203	74 AWI <Stage 3b/Tier 4>	01.11-12.14	6	DBJ,TW	0 445 120 235			
7370/PL	8,4	221-247	84 AWI <Stage 3b/Tier 4>	01.11-12.14	6	DBJ,TW	0 445 120 235			
<b>Centora</b>										
7280/AL	8,4	278	84 AWI <Stage 3b/Tier 4>	01.11-12.13	6	DBJ	0 445 120 235			
			84 CTA	01.08-12.11	6	DBJ	0 445 120 340	0 986 435 547		
7282/AL	8,4	304	84 AWI <Stage 3b/Tier 4>	01.11-12.13	6	DBJ	0 445 120 235			
			84 CTA	01.08-12.11	6	DBJ	0 445 120 340	0 986 435 547		
<b>Cerea</b>										
7274	8,4	221	84 CTA	01.05-12.11	6	DBJ	0 445 120 340	0 986 435 547		
7278	8,4	258	84 CTA	01.05-12.11	6	DBJ	0 445 120 340	0 986 435 547		
<b>Delta</b>										
9280/AL	9,8	353	98 ATI	01.10-12.13	7	DBJ,TW	0 445 120 235			
			98 CTA							
			Mot.-Nr. →63011	01.10-12.13	7	DBJ	0 445 120 340	0 986 435 547		
<b>Fortina</b>										
9695	8,4	221	84 CTA	08.08-12.11	6	DBJ	0 445 120 340	0 986 435 547		
		243	84 WI <Tier 3>	08.08-12.11	6	DBJ	0 445 120 235			
9795	8,4	258	84 CTA	08.08-12.14	6	DBJ	0 445 120 340	0 986 435 547		
	9,8	280	98 ATI	08.08-12.14	7	DBJ	0 445 120 235			
9895	9,8	313	98 ATI	08.08-12.14	7	DBJ	0 445 120 235			
<b>T7</b>										
	8,4	276	84 AWI <Stage 3b/Tier 4>	01.13→	6	DBJ	0 445 120 235			
<b>WR</b>										
9740	4,9	101	49 AWI <Stage 3b/Tier 4>	09.13→	4	DBJ	0 445 120 235			
9760	4,9	138	49 AWI <Stage 3b/Tier 4>	09.13→	4	DBJ	0 445 120 235			
9770	6,6	162	66 AWI <Stage 3b/Tier 4>	09.13→	6	DBJ	0 445 120 235			
9840	4,4	103-110	44 AWF <Stage 4/Tier 4>	09.13→	4	DBJ	0 445 120 235			
9860	4,9	147-155	49 AWF <Stage 4/Tier 4>	09.13→	4	DBJ	0 445 120 235			
<b>3600-Serie</b>										
3630	3,3	56	33 DTA	05.11→	3	DBJ	0 445 110 381	0 986 435 206		
3640 4x4	3,3	63	33CTA	05.11→	3	DBJ	0 445 110 381	0 986 435 206		
3650 4x4	3,3	68-70	33CTA	05.11→	3	DBJ	0 445 110 381	0 986 435 206		
3660 4x4	3,3	76	33CTA	05.11→	3	DBJ	0 445 110 381	0 986 435 206		
<b>4600-Serie</b>										
4607 , M	3,3	52,3/52,5	33 AWF <Stage 4/Tier 4>; 33 AWI <Stage 3b/Tier 4>	09.12→	3	DBJ	0 445 110 408			
4608	3,3	60	33 AWI <Stage 3b/Tier 4>	09.12-08.15	3	DBJ	0 445 110 408			
4609	3,3	67	33 AWF <Stage 4/Tier 4>; 33 AWI <Stage 3b/Tier 4>	09.12→	3	DBJ	0 445 110 408			
4610 , M	3,3	74/74,6	33 AWF <Stage 4/Tier 4>; 33 AWI <Stage 3b/Tier 4>	09.12→	3	DBJ	0 445 110 408			
<b>4700-Serie</b>										
4707	3,3	55	33 AWI <Stage 3b/Tier 4>; 33 CWC	01.14→	3	DBJ	0 445 110 408			





◀ MASSEY FERGUSON

4708	3,3	63	33 AWF <Stage 4/Tier 4>; 33 AWI <Stage 3b/Tier 4>; 33 CWC	01.14→	3	DBJ	0 445 110 408		
4709	3,3	70	33 AWF <Stage 4/Tier 4>; 33 AWI <Stage 3b/Tier 4>; 33 CWC	01.14→	3	DBJ	0 445 110 408		
<b>5400-Serie</b>									
5460	4,4	85	44 CWA	01.07-12.12	4	DBJ	0 445 120 340	0 986 435 547	
5465	6,6	88	66CTA	01.07-12.12	6	DBJ	0 445 120 340	0 986 435 547	
5470	4,4	99	44 CWA	01.07-12.12	4	DBJ	0 445 120 340	0 986 435 547	
5475	6,6	97	66CTA	01.07-12.12	6	DBJ	0 445 120 340	0 986 435 547	
5480	4,9	99	49 CWA	01.07-12.12	4	DBJ	0 445 120 340	0 986 435 547	
<b>5600-Serie</b>									
5608	3,3	63	AGCO POWER 33 AWI	01.12→	3	DBJ	0 445 110 408		
5609	3,3	71	AGCO POWER 33 AWI	01.12→	3	DBJ	0 445 110 408		
5610	3,3	78	AGCO POWER 33 AWI	01.12→	3	DBJ	0 445 110 408		
5611	4,4	81	AGCO POWER 44 AWI	01.13→	4	DBJ	0 445 110 408		
5612	4,4	88	AGCO POWER 44 AWI	01.13→	4	DBJ	0 445 110 408		
5613	4,4	92	AGCO POWER 44 AWI	01.13→	4	DBJ	0 445 110 408		
<b>5700-Serie</b>									
5412 SL	4,4	85-88	44 AWF <Stage 4/Tier 4>	01.15→	4	DBJ	0 445 110 408		
5710	4,4	74	44 AWF <Stage 4/Tier 4>	01.15→	4	DBJ,TW	0 445 110 408		
5711	4,4	77-81	44 AWF <Stage 4/Tier 4>	01.15→	4	DBJ	0 445 110 408		
5713 SL	4,4	92-96	44 AWF <Stage 4/Tier 4>	01.15→	4	DBJ	0 445 110 408		
<b>6400-Serie</b>									
6465	6,6	88	66CTA	01.10-12.12	6	DBJ	0 445 120 340	0 986 435 547	
6475	6,6	97	66CTA	01.10-12.12	6	DBJ	0 445 120 340	0 986 435 547	
6480	6,6	108	66CTA	01.10-12.12	6	DBJ	0 445 120 340	0 986 435 547	
6485 Dyna-6	6,6	118	66CTA	01.06-12.11	6	DBJ	0 445 120 340	0 986 435 547	
6490 Dyna-6	6,6	125	66CTA	01.06-12.11	6	DBJ	0 445 120 340	0 986 435 547	
6495 Dyna-6	6,6	136	66CTA	01.06-12.11	6	DBJ	0 445 120 340	0 986 435 547	
6497 Dyna-6	7,4	147	74 CTA	01.06-12.11	6	DBJ	0 445 120 340	0 986 435 547	
6499 Dyna-6	7,4	158	74 CTA	01.06-12.11	6	DBJ	0 445 120 340	0 986 435 547	
<b>6600-Serie</b>									
6612	4,9	88	49 AWI <Stage 3b/Tier 4>	01.12-12.16	4	DBJ	0 445 120 235		
6613	4,9	92	49 AWI <Stage 3b/Tier 4>	01.12-12.16	4	DBJ	0 445 120 235		
6614	4,9	103	49 AWI <Stage 3b/Tier 4>	01.12-12.16	4	DBJ	0 445 120 235		
6615	4,9	107-110	49 AWI <Stage 3b/Tier 4>	01.12-12.16	4	DBJ	0 445 120 235		
6616	4,9	118	49 AWI <Stage 3b/Tier 4>	01.12-12.16	4	DBJ	0 445 120 235		
<b>6700-Serie</b>									
6711	4,4	77-81	44 CWC	01.15→	4	DBJ,TW	0 445 110 408		
6712	4,4	85-88	44 AWF <Stage 4/Tier 4>	01.15→	4	DBJ	0 445 110 408		
			44 CWC	01.15→	4	DBJ,TW	0 445 110 408		
6713	4,4	92-96	44 AWF <Stage 4/Tier 4>	01.15→	4	DBJ	0 445 110 408		
			44 CWC	01.15→	4	DBJ,TW	0 445 110 408		
<b>7400-Serie</b>									
7465	6,6	75	66CTA	01.07-12.12	6	DBJ	0 445 120 340	0 986 435 547	
7475	6,6	82	66CTA	01.07-12.12	6	DBJ	0 445 120 340	0 986 435 547	
7480	6,6	90	66CTA	01.07-12.12	6	DBJ	0 445 120 340	0 986 435 547	
7485	6,6	97	66CTA	01.04-12.12	6	DBJ	0 445 120 340	0 986 435 547	
7490	6,6	104	66CTA	01.04-12.12	6	DBJ	0 445 120 340	0 986 435 547	
7495	6,6	116	66CTA	01.04-12.12	6	DBJ	0 445 120 340	0 986 435 547	
7497	6,6	151	66CTA	01.07-12.12	6	DBJ	0 445 120 340	0 986 435 547	
7499	7,4	162	74 CTA	01.07-12.12	6	DBJ	0 445 120 340	0 986 435 547	
<b>7600-Serie</b>									
7614	6,6	103	AGCO POWER e3 SCR	01.12→	6	DBJ	0 445 120 235		
7615	6,6	110	AGCO POWER e3 SCR	01.12→	6	DBJ	0 445 120 235		
7616	6,6	118	AGCO POWER e3 SCR	01.12→	6	DBJ	0 445 120 235		
7618	6,6	129	AGCO POWER e3 SCR	01.12→	6	DBJ	0 445 120 235		
7619	6,6	136	AGCO POWER e3 SCR	01.12→	6	DBJ	0 445 120 235		
7620	6,6	147	AGCO POWER e3 SCR	01.12→	6	DBJ	0 445 120 235		
7622 Dyna-VT	6,6	158	AGCO POWER e3 SCR	01.12→	6	DBJ	0 445 120 235		
7624	7,4	173	AGCO POWER e3 SCR	01.12→	6	DBJ	0 445 120 235		
7626	7,4	188	AGCO POWER e3 SCR	01.12→	6	DBJ	0 445 120 235		





8400-Serie										
8450	7,4	158	74 CTA	01.06-12.08	6	DBJ	0 445 120 340	0 986 435 547		
8460	7,4	173	74 CTA	01.06-12.08	6	DBJ	0 445 120 340	0 986 435 547		
8470	8,4	191	84 CTA	01.06-12.08	6	DBJ	0 445 120 340	0 986 435 547		
8480	8,4	213	84 CTA	01.04-12.07	6	DBJ	0 445 120 340	0 986 435 547		
8600-Serie										
8650	8,4	199	84 AWI <Stage 3b/Tier 4>	01.11-12.14	6	DBJ	0 445 120 235			
			84 CTA	01.08-12.11	6	DBJ	0 445 120 340	0 986 435 547		
8660	8,4	217	84 AWI <Stage 3b/Tier 4>	01.11-12.14	6	DBJ	0 445 120 235			
			84 CTA	01.08-12.11	6	DBJ	0 445 120 340	0 986 435 547		
8670	8,4	236	84 AWI <Stage 3b/Tier 4>	01.11-12.14	6	DBJ	0 445 120 235			
			84 CTA	01.08-12.11	6	DBJ	0 445 120 340	0 986 435 547		
8680	8,4	258	84 AWI <Stage 3b/Tier 4>	01.11-12.14	6	DBJ	0 445 120 235			
			84 CTA	01.08-12.11	6	DBJ	0 445 120 340	0 986 435 547		
8690	8,4	272	84 AWI <Stage 3b/Tier 4>	01.11-12.14	6	DBJ	0 445 120 235			
		280	84 CTA	01.08-12.11	6	DBJ	0 445 120 340	0 986 435 547		
9000-Serie										
9520	8,4	234	84 AWI <Stage 3b/Tier 4>	01.12-12.14	6	DBJ	0 445 120 235			
9530	8,4	255	84 AWI <Stage 3b/Tier 4>	01.12-12.14	6	DBJ	0 445 120 235			
9540	9,8	276	98 ATI	01.12-12.14	7	DBJ	0 445 120 235			
9550	9,8	300	98 ATI	01.12-12.14	7	DBJ	0 445 120 235			
9560	9,8	343	98 ATI	01.12-12.14	7	DBJ	0 445 120 235			
9690	8,4	224	84 CTA	09.05-12.08	6	DBJ	0 445 120 340	0 986 435 547		
9790	8,4	258	84 CTA	09.05-12.08	6	DBJ	0 445 120 340	0 986 435 547		

## MTZ (MINSK TRAKTOR WERK)

Belarus										
1025	4,8	105	D 245 E3 <Euro 3>	01.08→	4	DBJ	0 445 120 141			

## NEW HOLLAND

Serie B										
100 B, BLR, BTC	4,5	74	445TA <Tier 3>	02.08-12.12	4	DBJ	0 445 120 054	0 986 435 545		
110 , B, BTC	4,5	79/81	445T <Tier 3>; 445TA <Tier 3>	02.07-12.12	4	DBJ	0 445 120 054	0 986 435 545		
115 , B	4,5	85	445T <Tier 3>; 445TA <Tier 3>	02.07-12.12	4	DBJ	0 445 120 054	0 986 435 545		
Serie 200										
C232	3,2	56	F5CE5454B <Tier 3>	04.11→	4	DBJ	0 445 110 457	0 986 435 254		
C238	3,2	62	F5CE5454B <Tier 3>	04.11-12.13	4	DBJ	0 445 110 457	0 986 435 254		
L230	3,4	62	F5HFL413A <Tier 4>	07.12-12.15	4	DBJ	0 445 110 457	0 986 435 254		
TD5										
.105	3,4	79	F5DFL413H	10.14→	4	DBJ	0 445 110 457	0 986 435 254		
.115	3,4	84	F5DFL413H	10.14→	4	DBJ	0 445 110 457	0 986 435 254		
.85	3,4	63	F5DFL413H	10.14→	4	DBJ	0 445 110 457	0 986 435 254		
.95	3,4	73	F5DFL413H	10.14→	4	DBJ	0 445 110 457	0 986 435 254		
TD4000F										
4.100	3,4	54	F5DFL413K <Tier 4>	05.17→	4	DBJ	0 445 110 540			
4.80	3,4	40	F5DFL413B <Tier 4>	05.17→	4	DBJ	0 445 110 540			
4.90	3,4	46	F5DFL413L <Tier 4>	05.17→	4	DBJ	0 445 110 540			
TS										
110A 4.5 16x16	4,5	81	F4DFE413E <Tier 4a>	12.03-12.07	4	DBJ	0 445 120 212	0 986 435 508		
125A 12x12	6,7	93	NEF	07.03-12.07	6	DBJ	0 445 120 212	0 986 435 508		
135A 16x16	6,7	100	NEF	07.03-12.07	6	DBJ	0 445 120 212	0 986 435 508		
T4										
.100 F	3,4	73	F5DFL413K <Tier 4>	03.16→	4	DBJ,TW	0 445 110 457	0 986 435 254		F 00V C17 504
					4	DBJ,TW	0 445 110 540			F 00V C17 504
.100 LP	3,4	73	F5DFL413K <Tier 4>	05.17→	4	DBJ,TW	0 445 110 457	0 986 435 254		F 00V C17 504
					4	DBJ,TW	0 445 110 540			F 00V C17 504
.100 N	3,4	73	F5DFL413K <Tier 4>	04.17→	4	DBJ,TW	0 445 110 457	0 986 435 254	TW	F 00V C17 504
					4	DBJ,TW	0 445 110 540		TW	F 00V C17 504







◀ NEW HOLLAND

<b>.100 V</b>	3,4	73	F5DFL413K <Tier 4>	04.17→	4	DBJ,TW	<b>0 445 110 457</b>	<b>0 986 435 254</b>	TW	<b>F 00V C17 504</b>
					4	DBJ,TW	<b>0 445 110 540</b>		TW	<b>F 00V C17 504</b>
<b>.105</b>	3,4	79	F5DFL413... <Tier 4a>	12.12→	4	DBJ	<b>0 445 110 457</b>	<b>0 986 435 254</b>		
<b>.110 F</b>	3,4	79	F5DFL413J <Tier 4a>	03.16→	4	DBJ,TW	<b>0 445 110 457</b>	<b>0 986 435 254</b>		<b>F 00V C17 504</b>
					4	DBJ,TW	<b>0 445 110 540</b>			<b>F 00V C17 504</b>
<b>.110 LP</b>	3,4	79	F5DFL413J <Tier 4a>	05.17→	4	DBJ,TW	<b>0 445 110 457</b>	<b>0 986 435 254</b>		<b>F 00V C17 504</b>
					4	DBJ,TW	<b>0 445 110 540</b>			<b>F 00V C17 504</b>
<b>.110 N</b>	3,4	79	F5DFL413J <Tier 4a>	04.17→	4	DBJ,TW	<b>0 445 110 457</b>	<b>0 986 435 254</b>	TW	<b>F 00V C17 504</b>
					4	DBJ,TW	<b>0 445 110 540</b>		TW	<b>F 00V C17 504</b>
<b>.110 V</b>	3,4	79	F5DFL413J <Tier 4a>	04.17→	4	DBJ,TW	<b>0 445 110 457</b>	<b>0 986 435 254</b>	TW	<b>F 00V C17 504</b>
					4	DBJ,TW	<b>0 445 110 540</b>		TW	<b>F 00V C17 504</b>
<b>.115</b>	3,4	85	F5DFL413... <Tier 4a>	06.13→	4	DBJ	<b>0 445 110 457</b>	<b>0 986 435 254</b>		
<b>.75</b>	3,4	55	F5DFL413... <Tier 4a>	06.13→	4	DBJ	<b>0 445 110 457</b>	<b>0 986 435 254</b>		
<b>.80 F</b>	3,4	55	F5DFL413... <Tier 4a>	03.16→	4	DBJ,TW	<b>0 445 110 457</b>	<b>0 986 435 254</b>		<b>F 00V C17 504</b>
					4	DBJ,TW	<b>0 445 110 540</b>			<b>F 00V C17 504</b>
<b>.80 LP</b>	3,4	55	F5DFL413... <Tier 4a>	05.17→	4	DBJ,TW	<b>0 445 110 457</b>	<b>0 986 435 254</b>		<b>F 00V C17 504</b>
					4	DBJ,TW	<b>0 445 110 540</b>			<b>F 00V C17 504</b>
<b>.80 N</b>	3,4	55	F5DFL413... <Tier 4a>	04.17→	4	DBJ,TW	<b>0 445 110 457</b>	<b>0 986 435 254</b>	TW	<b>F 00V C17 504</b>
					4	DBJ,TW	<b>0 445 110 540</b>		TW	<b>F 00V C17 504</b>
<b>.80 V</b>	3,4	55	F5DFL413... <Tier 4a>	04.17→	4	DBJ,TW	<b>0 445 110 457</b>	<b>0 986 435 254</b>	TW	<b>F 00V C17 504</b>
					4	DBJ,TW	<b>0 445 110 540</b>		TW	<b>F 00V C17 504</b>
<b>.85</b>	3,4	63	F5DFL413... <Tier 4a>	12.12→	4	DBJ	<b>0 445 110 457</b>	<b>0 986 435 254</b>		
<b>.90 F</b>	3,4	63	F5DFL413L <Tier 4>	03.16→	4	DBJ,TW	<b>0 445 110 457</b>	<b>0 986 435 254</b>		<b>F 00V C17 504</b>
					4	DBJ,TW	<b>0 445 110 540</b>			<b>F 00V C17 504</b>
<b>.90 LP</b>	3,4	63	F5DFL413L <Tier 4>	05.17→	4	DBJ,TW	<b>0 445 110 457</b>	<b>0 986 435 254</b>		<b>F 00V C17 504</b>
					4	DBJ,TW	<b>0 445 110 540</b>			<b>F 00V C17 504</b>
<b>.90 N</b>	3,4	63	F5DFL413L <Tier 4>	04.17→	4	DBJ,TW	<b>0 445 110 457</b>	<b>0 986 435 254</b>	TW	<b>F 00V C17 504</b>
					4	DBJ,TW	<b>0 445 110 540</b>		TW	<b>F 00V C17 504</b>
<b>.90 V</b>	3,4	63	F5DFL413L <Tier 4>	04.17→	4	DBJ,TW	<b>0 445 110 457</b>	<b>0 986 435 254</b>	TW	<b>F 00V C17 504</b>
					4	DBJ,TW	<b>0 445 110 540</b>		TW	<b>F 00V C17 504</b>
<b>.95</b>	3,4	73	F5DFL413... <Tier 4a>	12.12→	4	DBJ	<b>0 445 110 457</b>	<b>0 986 435 254</b>		
<b>T4 Powerstar</b>										
<b>.55</b>	3,4	43	F5DFL463... <Tier 4a>	05.14→	4	DBJ	<b>0 445 110 540</b>			<b>F 00V C17 504</b>
<b>.65</b>	3,4	48	F5DFL463... <Tier 4a>	05.14→	4	DBJ	<b>0 445 110 540</b>			<b>F 00V C17 504</b>
<b>.75</b>	3,4	55	F5DFL463A <Tier 4a>	05.14→	4	DBJ	<b>0 445 110 540</b>			<b>F 00V C17 504</b>
<b>T5</b>										
<b>.100</b>	3,4	74	F5GFL413A	11.15→	4	DBJ	<b>0 445 110 657</b>			
<b>.105</b>	3,4	79	F5DFL413... <Tier 4a>	07.12→	4	DBJ	<b>0 445 110 457</b>	<b>0 986 435 254</b>		
<b>.110</b>	3,4	81	F5GFL413A	11.15→	4	DBJ	<b>0 445 110 657</b>			
<b>.115</b>	3,4	84	F5DFL413... <Tier 4a>	07.12→	4	DBJ	<b>0 445 110 457</b>	<b>0 986 435 254</b>		
<b>.120</b>	3,4	88	F5GFL413A	11.15→	4	DBJ	<b>0 445 110 657</b>			
<b>.75</b>	3,4	55	F5DFL413A <Tier 4a>	04.17→	4	DBJ	<b>0 445 110 457</b>	<b>0 986 435 254</b>		
<b>.85</b>	3,4	63	F5DFL413L <Tier 4>	04.17→	4	DBJ	<b>0 445 110 457</b>	<b>0 986 435 254</b>		
<b>.95</b>	3,4	73	F5DFL413... <Tier 4a>	01.12→	4	DBJ	<b>0 445 110 457</b>	<b>0 986 435 254</b>		
<b>T6</b>										
<b>.120 16x16</b>	4,5	89	F4DFE413E <Tier 4a>	02.12→	4	DBJ	<b>0 445 120 075</b>	<b>0 986 435 530</b>		
<b>.125 16x16</b>	4,5	92	F4DFE41... <Tier 4b>	03.15→	4	DBJ	<b>0 445 120 351</b>			
<b>.140 16x16</b>	4,5	105	F4DFE413C <Tier 4a>	02.12-12.15	4	DBJ	<b>0 445 120 075</b>	<b>0 986 435 530</b>		
<b>.145 16x16</b>	4,5	107	F4DFE4134 <Tier 4b>	03.15→	4	DBJ	<b>0 445 120 351</b>			
<b>.150 16x16</b>	4,5	113	F4DFE413B <Tier 4a>	02.12-12.15	4	DBJ	<b>0 445 120 075</b>	<b>0 986 435 530</b>		
<b>.155 16x16</b>	4,5	114	F4DFE4133 <Tier 4b>	03.15→	4	DBJ	<b>0 445 120 351</b>			
	6,7	113	F4DFE613F <Tier 4a>	02.12-12.15	6	DBJ	<b>0 445 120 075</b>	<b>0 986 435 530</b>		
<b>.160 16x16</b>	4,5	120	F4DFE413A <Tier 4a>	02.12-12.15	4	DBJ	<b>0 445 120 075</b>	<b>0 986 435 530</b>		
<b>.165 16x16</b>	4,5	121	F4DFE4132 <Tier 4b>	03.15→	4	DBJ	<b>0 445 120 351</b>			
	6,7	121	F4DFE6132 <Tier 4a>	02.12-12.15	6	DBJ	<b>0 445 120 075</b>	<b>0 986 435 530</b>		
<b>.175 16x16</b>	4,5	129	F4DFE4131 <Tier 4b>	03.15→	4	DBJ	<b>0 445 120 351</b>			
	6,7	129	F4DFE613E <Tier 4a>	02.12-12.15	6	DBJ	<b>0 445 120 075</b>	<b>0 986 435 530</b>		
<b>.180 16x16</b>	6,7	132	F4DFE6132 <Tier 4a>	03.15→	6	DBJ	<b>0 445 120 351</b>			
<b>T7</b>										
<b>.170 CVT</b>	6,7	126	F4DFE613B	12.10-12.14	6	DBJ	<b>0 445 120 075</b>	<b>0 986 435 530</b>		
<b>.175 CVT</b>	6,7	129	F4DFE613... <Tier 4b>	04.14→	6	DBJ	<b>0 445 120 351</b>			
<b>.185 CVT</b>	6,7	138	F4DFE613B	12.10-12.14	6	DBJ	<b>0 445 120 075</b>	<b>0 986 435 530</b>		
<b>.190 CVT</b>	6,7	140	F4DFE613N	04.14→	6	DBJ	<b>0 445 120 351</b>			





.200 CVT	6,7	149	F4DFE613B	12.10-12.14	6	DBJ	0 445 120 075	0 986 435 530
.210 CVT	6,7	154	F4DFE613M	04.14→	6	DBJ	0 445 120 351	
		156	F4DFE613B	12.10-12.14	6	DBJ	0 445 120 075	0 986 435 530
.220 CVT	6,7	160	F4DFE613J	12.10-12.14	6	DBJ	0 445 120 075	0 986 435 530
.225 CVT	6,7	165	F4DFE613K	04.14→	6	DBJ	0 445 120 351	
.230 CVT	6,7	165	F4DFE613K	04.14→	6	DBJ	0 445 120 351	
.235 CVT	6,7	172	F4DFE613J	12.10-12.14	6	DBJ	0 445 120 075	0 986 435 530
.245 CVT	6,7	180	F4DFE613J	04.14→	6	DBJ	0 445 120 351	
.250 CVT	6,7	184	F4DFE613J	12.10-12.14	6	DBJ	0 445 120 075	0 986 435 530
.260 CVT	6,7	191	F4DFE613H; F4DFE613J	12.10→	6	DBJ	0 445 120 075	0 986 435 530
.270 CVT	6,7	198	F4DFE613B; F4DFE613J	12.10→	6	DBJ	0 445 120 075	0 986 435 530
.275	6,7	202	F4DFE617L <Tier 4b>	08.17→	6	DBJ	0 445 120 346	0 986 435 662
.290 CVT	6,7	213	F4DFE617M <Tier 4b>	10.15→	6	DBJ	0 445 120 346	0 986 435 662
.315 CVT	6,7	230	F4DFE617L <Tier 4b>	10.15→	6	DBJ	0 445 120 346	0 986 435 662
<b>T8</b>								
.275 CVT	8,7	201	F2CFE613F	02.13-12.14	6	DBJ	0 445 120 157	0 986 435 564
.300 CVT	8,7	219	F2CFE613F	02.13-12.14	6	DBJ	0 445 120 157	0 986 435 564
.320 CVT	8,7	235	F2CFE613G	04.14→	6	DBJ	0 445 120 157	0 986 435 564
.330 CVT	8,7	241	F2CFE613F	02.13-12.14	6	DBJ	0 445 120 157	0 986 435 564
.350 CVT	8,7	258	F2CFE614G	04.14→	6	DBJ	0 445 120 157	0 986 435 564
.360 CVT	8,7	263	F2CFE613F	02.13-12.14	6	DBJ	0 445 120 157	0 986 435 564
.380 CVT	8,7	281	F2CFE614D	04.14→	6	DBJ	0 445 120 157	0 986 435 564
.390 CVT	8,7	286	F2CFE613F	02.13-12.14	6	DBJ	0 445 120 157	0 986 435 564
.410 CVT	8,7	301	F2CFE614C	04.14→	6	DBJ	0 445 120 157	0 986 435 564
.420 CVT	8,7	308	F2CFE613F	02.13-12.14	6	DBJ	0 445 120 157	0 986 435 564
.435 CVT	8,7	320	F2CFE614A	04.14→	6	DBJ	0 445 120 157	0 986 435 564
<b>T9</b>								
.390	8,7	287	F2CFE614A	02.11-12.14	6	DBJ	0 445 120 157	0 986 435 564
.435	8,7	320	F2CFE614A	10.14→	6	DBJ	0 445 120 157	0 986 435 564
.454	12,9	345	F3HFE613B					
			Mot.-Nr. →19968	10.14→	6	DBJ	0 445 124 015	0 986 435 663
			Mot.-Nr. 19969→	10.14→	6	DBJ	0 445 124 036	0 986 435 674
.455	12,9	386	F3HFE613B					
			Mot.-Nr. →19968	10.14→	6	DBJ	0 445 124 015	0 986 435 663
			Mot.-Nr. 19969→	10.14→	6	DBJ	0 445 124 036	0 986 435 674
.565	12,9	410	F3HFE613B					
			Mot.-Nr. →19968	10.14→	6	DBJ	0 445 124 015	0 986 435 663
			Mot.-Nr. 19969→	10.14→	6	DBJ	0 445 124 036	0 986 435 674
.600	12,9	451	F3DFE613F	10.14→	6	DBJ	0 445 124 027	
.615	12,7	451	F3DFE613B	04.11-11.17	6	DBJ	0 445 124 014	0 986 435 655
		451	F3DFA613A	03.14-11.17	6	DBJ	0 445 124 014	0 986 435 655
.645	12,9	476	F3DFE613F	10.14→	6	DBJ	0 445 124 027	
.670	12,7	492	F3DFE613A	04.11-11.17	6	DBJ	0 445 124 014	0 986 435 655
		492	F3DFA613A	03.14-11.17	6	DBJ	0 445 124 014	0 986 435 655
.700	12,9	509	F3DFE613F	10.14→	6	DBJ	0 445 124 027	
<b>T6000</b>								
6020	4,5	82	N45MNT <FPT>	01.07-11.16	4	DBJ	0 445 120 075	0 986 435 530
6030 12x12	6,7	86	N67ENT <6.7LI6DTA>	01.07-09.13	6	DBJ	0 445 120 057	0 986 435 552
6040	4,5	90	N45MNT <FPT>	01.07-11.13	4	DBJ	0 445 120 057	0 986 435 552
6050 16x16	6,7	93	N67ENT <6.7LI6DTA>	01.07→	6	DBJ	0 445 120 057	0 986 435 552
6060	4,5	97	N45MNT <FPT>	01.07-08.16	4	DBJ	0 445 120 057	0 986 435 552
6070 16x16	6,7	104	N67ENT <6.7LI6DTA>	01.07→	6	DBJ	0 445 120 057	0 986 435 552
6080 Power Command	6,7	114	N67ENT <6.7LI6DTA>	12.07→	6	DBJ	0 445 120 057	0 986 435 552
6090 Power Command	6,7	121	N67ENT <6.7LI6DTA>	11.09→	6	DBJ	0 445 120 057	0 986 435 552
<b>T7000</b>								
T7030 CVT	6,7	158	N67ENT <6.7LI6DTA>	01.07-12.11	6	DBJ	0 445 120 075	0 986 435 530
T7040 CVT, Power Command	6,7	134/172	N67ENT <6.7LI6DTA>	01.06-12.11	6	DBJ	0 445 120 075	0 986 435 530
T7050 CVT, Power Command	6,7	145/177	N67ENT <6.7LI6DTA>	01.06-12.11	6	DBJ	0 445 120 075	0 986 435 530
T7060 CVT	6,7	179	N67ENT <6.7LI6DTA>	01.07-12.11	6	DBJ	0 445 120 075	0 986 435 530
T7070 CVT	6,7	187	N67ENT <6.7LI6DTA>	06.09-12.11	6	DBJ	0 445 120 075	0 986 435 530



## KAMAZ

### Serie 740

<b>740.60</b> -360	11,8	265	740.72-360 <Euro 4>	08.08→	8	DBJ	<b>0 445 120 153</b>
<b>740.61</b> -320	11,8	236	740.71-320 <Euro 4>	08.08→	8	DBJ	<b>0 445 120 153</b>
<b>740.62</b> -280	11,8	206	740.70-280 <Euro 4>	08.08→	8	DBJ	<b>0 445 120 153</b>
<b>740.63</b> -400	11,8	294	740.73-400 <Euro 4>	08.08→	8	DBJ	<b>0 445 120 153</b>
<b>740.64</b> -420	11,8	309	740.74-420 <Euro 4>	08.08→	8	DBJ	<b>0 445 120 153</b>
<b>740.65</b> -240	11,8	324	740.75-440 <Euro 4>	08.08→	8	DBJ	<b>0 445 120 153</b>

## MMZ (MINSK MOTOREN WERK)

### D Serie

4,8	90/100/ 130	D 245.35 E4 <Euro 4>; D 245.7 E4 <Euro 4>; D 245.9 E4 <Euro 4>	12.11→	4	DBJ	<b>0 445 120 245</b>
-----	----------------	---	--------	---	-----	----------------------

### Serie D

<b>245</b> .30 E3, .35 E3, .7 E3, .9 E3	4,8	90/100/ 115/125	D 245.30 E3 <Euro 3>; D 245.35 E3 <Euro 3>; D 245.7 E3 <Euro 3>; D 245.9 E3 <Euro 3>	01.08→	4	DBJ	<b>0 445 120 141</b>
<b>249</b>	4,8	140	D 249 <Euro 3>	10.07→	4	DBJ	<b>0 445 120 141</b>
<b>260</b> E3	7,1	169	D 260 E3 <Euro 3>	01.08→	6	DBJ	<b>0 445 120 141</b>
<b>262</b> S2	7,9	220,5	D 262 S2 <Euro 3>	10.07→	6	DBJ	<b>0 445 120 141</b>
<b>263</b> .1 E3	8,7	257,4	D 263.1 E3 <Euro 3>	10.07→	6	DBJ	<b>0 445 120 141</b>

## YAMZ (YAROSLAWL MOTORENWERKE)

### Serie 650

<b>650</b> .10	11,1	303	650.10 <Euro 3>	11.08→	6	DBJ	<b>0 445 120 142</b>
<b>6501</b> .10	11,1	266	6501.10 <Euro 3>	11.08→	6	DBJ	<b>0 445 120 142</b>
<b>6502</b> .10	11,1	230	6502.10 <Euro 3>	11.08→	6	DBJ	<b>0 445 120 142</b>





## ALFA ROMEO

ALFA ROMEO							
<b>Brera</b>							
2.0 JTDM [939]	2,0	120/125	844 A2.000; 939 B3.000 <M120>		02.09-12.10		0 445 010 302 0 986 437 094
2.4 JTDM 20V [939]	2,4	147	939 A3.000 <M95>		04.06-12.10		0 445 010 123
		154	939 A9.000		05.07-12.10		0 445 010 309
<b>Giulia</b>							
2.2 Multijet, Multijet Q4 [952]	2,1	100/110/132/154	5526...; 55266388; 55268818		02.16→		0 445 010 747
<b>Giulietta</b>							
1.6 JTDM [940]	1,6	77	940 A3.000		05.10-12.15	EU5	0 445 010 305 0 986 437 094
							EU6
2.0 JTDM [940]	2,0	85/88	940 C1.000; 940 C5.000		04.15→		0 445 010 466 0 986 437 095
			940 C3.000; 940 C4.000		04.15→		0 445 010 466 0 986 437 095
		100/120	940...; 940 A7.000		04.10-12.15	EU5	0 445 010 305 0 986 437 094
						EU6	0 445 010 466 0 986 437 095
		103	940 A5.000		05.10-12.14	EU5	0 445 010 305 0 986 437 094
						EU6	0 445 010 466 0 986 437 095
110/120/129	940 B4.000; 940 B5.000; 940 B9.000		08.13→	EU5	0 445 010 305 0 986 437 094		
125	940 A4.000		05.10-12.14	EU5	0 445 010 305 0 986 437 094		
				EU6	0 445 010 466 0 986 437 095		
<b>GT</b>							
1.9 JTD 16V [937]	1,9	110	937 A5.000 <M15>		10.03-12.10		0 445 010 071
		110/125	937 A5.000 <M92>; 937 A.6000 <M94>		01.04-12.10		0 445 010 302 0 986 437 094
<b>MiTo</b>							
1.3 JTD [955]	1,2	62	199 B4.000		03.11-12.15	TW	0 445 010 310 0 986 437 038
	1,3	66	...		10.08→	TW	0 445 010 293 0 986 437 036
							0 445 010 425 0 986 437 097
		70	199 B1.000 <M95>		10.08-12.15	TW	0 445 010 310 0 986 437 038
							0 445 010 425 0 986 437 097
JTDM [955]	1,3	59	199 B8.000		12.13-12.15	TW	0 445 010 310 0 986 437 038
							0 445 010 425 0 986 437 097
SDE [955]	1,3	70	330 A1.000		05.16→	TW	0 445 010 310 0 986 437 038
							0 445 010 425 0 986 437 097
1.6 JTD [955]	1,6	85	955 A4.000 <M87>		09.08-12.15	SSJ	0 445 010 302 0 986 437 094
							SSJ
		88	955 A3.000 <M88>		08.08-12.15	N5P,SSJ	0 445 010 302 0 986 437 094
							SSJ
						5PL,SSJ	0 445 010 466 0 986 437 095
<b>Spider</b>							
2.0 JTDM [939]	2,0	120/125	844 A2.000; 939 B3.000 <M120>		04.09-12.10		0 445 010 302 0 986 437 094
2.4 JTDM 20V [939]	2,4	147/154	939 A3.000 <M95>; 939 A9.000		03.07-12.10		0 445 010 123
<b>Stelvio</b>							
2.2 Multijet, Multijet Q4	2,1	110/132/154	552...; 55271838		11.16→		0 445 010 747
<b>145</b>							
1.9 JTD [930 MY97]	1,9	76	AR 32302 <M20>		05.98-02.99		0 445 010 007 0 986 437 002
JTD [930 MY99]	1,9	76	AR 32302 <M20>		02.99-12.00		0 445 010 007 0 986 437 002
<b>146</b>							
1.9 JTD [930 MY97]	1,9	77	AR 32302 <M13>		05.98-02.99		0 445 010 007 0 986 437 002
JTD [930 MY99]	1,9	77	AR 32302 <W4 M20>		02.99-12.00		0 445 010 007 0 986 437 002
<b>147</b>							
1.9 JTD [937]	1,9	74	182B9000 <M14>		06.03-10.06		0 445 010 007 0 986 437 002
		81-85	937 A.2000 <M15>		11.00-03.05		0 445 010 007 0 986 437 002
JTDM [937]	1,9	85/88	937 A.3000 <M88>; 939 A7.000 <M87>		04.05-12.10		0 445 010 286 0 986 437 035
JTDM 16V [937]	1,9	93/103	192A5000 <M17>; 937 A.4000 <M16>		10.02-09.06		0 445 010 071
		100/110	192 B1.000 <M18>; 937 A5.000 <M19>		02.04-02.06		0 445 010 071
		100/110/125	192 B1.000 <M91>; 937 A5.000 <M92>; 937 A.6000 <M94>		01.06-12.10		0 445 010 302 0 986 437 094













◀ ALFA ROMEO

156 Berlina							
1.9 JTD [932]	1,9	74	182 B9.000 <M24>	06.03-12.04		0 445 010 007	0 986 437 002
		76/81-85	AR32302 <M1>; AR37101 / 937A2.000 <M3/M5>; 937 A2.000 <M25>	09.97-10.05		0 445 010 007	0 986 437 002
JTD 16V [932]	1,9	93	937 A4.000 <M26>	06.03-10.05		0 445 010 071	
		100	192 B1.000 <M29>	10.04-10.05		0 445 010 071	
		103	192 A5.000 <M27>	10.02-10.05		0 445 010 071	
		110	937 A5.000 <M82>	07.04-12.05		0 445 010 302	0 986 437 094
2.4 JTD [932]	2,4	100/110	AR32501 <M2>; 839 A6.000 <M4>; 841 C.000 <M30>	09.97-10.05		0 445 010 006	0 986 437 001
JTD, JTD 20V [932]	2,4	120/129	841 G.000 <M31>; 841 M.000 <M33>	06.03-10.05		0 445 010 072	
156 Sportwagon							
1.9 JTD [932]	1,9	74	182 B9.000 <M24>	06.03-12.04		0 445 010 007	0 986 437 002
		76/80-85	AR32302 CF2 <M1>; AR37101 / 937A2.000 <M3/M5 CF3>; 937 A2.000 <M25>	05.00-12.05		0 445 010 007	0 986 437 002
		93	937 A4.000 <M26/M90>	06.03-10.05		0 445 010 071	
		93/110	937 A4.000 <M90>; 937 A5.000 <M82>	10.03-12.05		0 445 010 286	0 986 437 035
		100	192 B1.000 <M29>	10.04-10.05		0 445 010 071	
		103	192 A5.000 <M27>	10.02-12.05		0 445 010 071	
JTD Q4 [932]	1,9	110	937 A5.000 <M28/M92>	07.04-12.05	EU3	0 445 010 071	
					EU4	0 445 010 286	0 986 437 035
2.4 JTD [932]	2,4	100/110	AR32501 CF2 <M2>; 839 A6.000 <M4, CF3>; 841 C.000 <M30>	05.00-10.05		0 445 010 006	0 986 437 001
		120/129	841 G.000 <M31>; 841 M.000 <M33>	06.03-12.05		0 445 010 072	
159 Berlina							
1.9 JTDM 8V [939]	1,9	85	939 A7.000 <M87>	01.06-12.08		0 445 010 286	0 986 437 035
		88	939 A1.000 <M88>	06.05-12.08		0 445 010 286	0 986 437 035
JTDM 16V [939]	1,9	100	937 A8.000 <M91>	01.06-12.08		0 445 010 302	0 986 437 094
		110	939 A2.000 <M92>	06.05-12.08		0 445 010 302	0 986 437 094
2.0 JTDM [939]	2,0	100/120/125	844 A2.000; 939 B3.000 <M120>; 939 B4.000	05.09-12.11		0 445 010 302	0 986 437 094
2.4 JTD, JTD Q4 [939]	2,4	154	939 A9.000	09.06-12.08		0 445 010 309	
JTDM [939]	2,4	147	939 A3.000 <M95>	06.05-12.08		0 445 010 123	
159 Sportwagon							
1.9 JTDM [939]	1,9	85/88/100/110	937 A8.000 <M91>; 939 A1.000 <M88>; 939 A2.000 <M92>; 939 A7.000 <M87>	03.06-12.08		0 445 010 286	0 986 437 035
2.0 JTDM [939]	2,0	100/120/125	844 A2.000; 939 B3.000 <M120>; 939 B4.000	05.09-12.11		0 445 010 302	0 986 437 094
2.4 JTD, JTD Q4 [939]	2,4	154	939 A9.000	09.06-12.08		0 445 010 309	
JTDM [939]	2,4	147	939 A3.000 <M95>	03.06-12.08		0 445 010 123	
166							
2.4 JTD [936]	2,4	100-110	AR 34202 <M20>; 839 A6.000/841 C.000 <M21/M22>	09.98-10.07		0 445 010 006	0 986 437 001
JTD 20V [936]	2,4	120/128/129	841 G.000/841 H.000 <M25/M26>; 841 M.000 <M27>; 841 N.000 <M28>	06.03-10.07		0 445 010 072	
JTDM 20V [936]	2,4	132-136	936 B.000 <M99>	10.05-10.07		0 445 010 123	



**AUDI**

A1								
1.6 TDI [8X]	1,6	85	CXMA <DK8>	11.14→		0 445 010 570	0 986 437 440	
2.0 TDI [8X]	2,0	100/105	CFHB <D94>; CFHD <D92>	09.11-04.15		0 445 010 565	0 986 437 405	
A1 Sportback								
1.6 TDI [8X]	1,6	85	CXMA <DK8>	11.14→		0 445 010 570	0 986 437 440	
2.0 TDI [8X]	2,0	100/105	CFHB <D94>; CFHD <D92>	09.11-04.15		0 445 010 565	0 986 437 405	
A3								
1.6 TDI [8V1]	1,6	81	CRKB <DK5>	09.13-05.15		0 445 010 570	0 986 437 440	
			CXXB <DK5>; DBKA <DK5>	05.15-04.16	ULT	0 445 010 570	0 986 437 440	
			85 DDYA <DK8>	03.17-07.18	ULT	0 445 010 583	0 986 437 440	
2.0 TDI [8V1]	1,6	77	CLHA <D38>	09.12-05.15		0 445 010 570	0 986 437 440	
			81/105	CRFA <DN1>; CRFC <DN6>	01.13→		0 445 010 583	0 986 437 440
			110	CRUA <DN4>	05.14-05.15		0 445 010 583	0 986 437 440

										
2.0 TDI, TDI quattro [8P1]	2,0	100/103/125	CBAA <D94>; CBAB <D91>; CBBB <D93>	07.08-05.10				0 445 010 543	0 986 437 410	
			CFFA <D94>; CFFB <D91>; CFGB <D93>; CLJA <D91>	11.09-03.13				0 445 010 565	0 986 437 405	
TDI, TDI quattro [8V1]	2,0	100/135/110	CRBD <DE9>; CRLC <DE9>; CUNA <DK7>	05.13-05.17				0 445 010 570	0 986 437 440	
			CRBC <DN4>	04.12-05.15				0 445 010 570	0 986 437 440	
			CRLB <DN4>	10.12-08.16					0 445 010 570	0 986 437 440
			DBGA <DN4>; DEJA <DN4>	05.15→					0 445 010 583	0 986 437 440
			DCYA <DN4>; DGCA <DK7>	05.17→					0 445 010 570	0 986 437 440
		110/135	DFGA <DN4>; DJGA <DK7>	07.18→				0 445 010 583	0 986 437 440	
<b>A3 Cabriolet</b>										
1.6 TDI [8V7]	1,6	81	CRKB <DK5>	02.14-05.15				0 445 010 570	0 986 437 440	
2.0 TDI [8P7]	2,0	100/103	CBAA <D94>; CBAB <D91>	04.08-05.10				0 445 010 543	0 986 437 410	
			CFFA <D94>; CFFB <D91>	11.09-05.13				0 445 010 565	0 986 437 405	
TDI, TDI quattro [8V7]	2,0	100/110/135	CRLB <DN4>; CRLC <DE9>; CUNA <DK7>; DCYA <DN4>; DGCA <DK7>	10.13→				0 445 010 570	0 986 437 440	
<b>A3 Limousine</b>										
1.6 TDI [8VS]	1,6	77/81	CLHA <D38>; CRKB <DK5>	09.13-05.15				0 445 010 570	0 986 437 440	
			DDYA <DK8>	03.17-07.18	ULT			0 445 010 583	0 986 437 440	
TDI, TDI quattro [8VS]	1,6	81	CXXB <DK5>; DBKA <DK5>	05.15-04.16	ULT			0 445 010 570	0 986 437 440	
2.0 TDI [8VS]	2,0	81	CRFA <DN1>	05.13→				0 445 010 583	0 986 437 440	
			CRBD <DE9>	05.13-05.14				0 445 010 570	0 986 437 440	
			CRLC <DE9>	05.13-08.16					0 445 010 570	0 986 437 440
			105/110	CRFC <DN6>; CRUA <DN4>	10.13→				0 445 010 583	0 986 437 440
TDI, TDI quattro [8VS]	2,0	110	CRBC <DN4>	10.13-05.15				0 445 010 570	0 986 437 440	
			CRLB <DN4>	05.13-08.16				0 445 010 570	0 986 437 440	
			DBGA <DN4>; DEJA <DN4>	05.15→					0 445 010 583	0 986 437 440
			110/135	DCYA <DN4>; DGCA <DK7>	05.17→				0 445 010 570	0 986 437 440
				DFGA <DN4>; DJGA <DK7>	07.18→				0 445 010 583	0 986 437 440
		135	CUNA <DK7>	05.14-05.17				0 445 010 570	0 986 437 440	
<b>A3 Sportback</b>										
1.6 TDI [8VA]	1,6	77/81	CLHA <D38>; CRKB <DK5>	01.13-05.15				0 445 010 570	0 986 437 440	
			DDYA <DK8>	03.17-07.18	ULT			0 445 010 583	0 986 437 440	
TDI, TDI quattro [8VA]	1,6	81	CXXB <DK5>; DBKA <DK5>	05.15-04.16	ULT			0 445 010 570	0 986 437 440	
2.0 TDI [8VA]	2,0	81/105	CRFA <DN1>; CRFC <DN6>	03.13→				0 445 010 583	0 986 437 440	
			CRUA <DN4>	05.14-05.15				0 445 010 583	0 986 437 440	
TDI, TDI quattro [8PA]	2,0	100/103/125	CBAA <D94>; CBAB <D91>; CBBB <D93>; CBEA	07.08-08.13				0 445 010 543	0 986 437 410	
			CFFA <D94>; CFFB <D91>; CFGB <D93>; CLJA <D91>	11.09-03.13				0 445 010 565	0 986 437 405	
TDI, TDI quattro [8VA]	2,0	100/135/110	CRBD <DE9>; CRLC <DE9>; CUNA <DK7>	05.13-05.17				0 445 010 570	0 986 437 440	
			CRBC <DN4>	09.12-05.15				0 445 010 570	0 986 437 440	
			CRLB <DN4>	10.12-08.16					0 445 010 570	0 986 437 440
			DBGA <DN4>; DEJA <DN4>	05.15→					0 445 010 583	0 986 437 440
			110/135	DCYA <DN4>; DGCA <DK7>	05.17→				0 445 010 570	0 986 437 440
			DFGA <DN4>; DJGA <DK7>	07.18→				0 445 010 583	0 986 437 440	
<b>A4</b>										
2.0 TDI [8K2; B8]	2,0	100	CJCB <D94>	11.10-03.12				0 445 010 565	0 986 437 405	
				04.12-12.15				0 445 010 568	0 986 437 434	
TDI [8W2; B9]	2,0	100	DEUB <D94>	05.15→				0 445 010 570	0 986 437 440	
TDI, TDI quattro [8K2; B8]	2,0	88/100/105/120/125	CAGA <D92>; CAGB <D94>; CAGC <D90>; CAHA <D93>; CAHB <D95>; CMEA <D92>	11.07-03.12				0 445 010 543	0 986 437 410	
			88/105/120/130	CGLC <DE2>; CGLD <D95>; CJCA <D92>; CJCC <D90>; CMFA <D92>	11.11-12.15				0 445 010 568	0 986 437 434
			100/110/120/140	CNHA <DE5>; CNHC <D95>; CSUA <DN4>; CSUB <D94>	09.13-12.15				0 445 010 570	0 986 437 440
			110	CJCD <DN4>; CMFB <DN4>	05.13-12.15				0 445 010 568	0 986 437 434
			90/120	DETB <DE5>; DEUC <D45>	05.16→				0 445 010 570	0 986 437 440
TDI, TDI quattro [8W2; B9]	2,0	110/140	DEUA <DN4>	05.15→				0 445 010 570	0 986 437 440	
			CZHA <DN4>; DESA <DE5>	05.15→				0 445 010 583	0 986 437 440	
			140	DETA <DE5>	05.15→				0 445 010 570	0 986 437 440
2.7 TDI [8EC; B7]	2,7	120	BSG <D1W>							
				Fg.-Nr. →8E..6..184 000→8E..6..800 880	11.05-02.06			0 445 010 343	0 986 437 348	
				Fg.-Nr. 8E..6..184 001→8E..6..800 881→	03.06-06.08			0 445 010 331	0 986 437 093	







◀ AUDI

2.7 TDI [8EC; B7]	2,7	132	BPP <D1N> Fg.-Nr. →8E..6..184 000 →8E..6..800 880 Fg.-Nr. 8E..6..184 001 → 8E..6..800 881→	11.05-02.06 03.06-06.08	<b>0 445 010 343</b> <b>0 445 010 331</b>	<b>0 986 437 348</b> <b>0 986 437 093</b>
TDI [8K2; B8]	2,7	120/140	CAMA <D4V>; CAMB <D1W>; CGKA <D4V>; CGKB <D1W>	11.07-03.12	<b>0 445 010 685</b>	<b>0 986 437 404</b>
3.0 TDI [8K2; B8]	3,0	150	CLAB <D1Q>	11.11-12.15	<b>0 445 010 676</b>	<b>0 986 437 435</b>
TDI quattro [8EC; B7]	3,0	150	BKN Fg.-Nr. →8E..6..184 000 →8E..6..800 880 Fg.-Nr. 8E..6..184 001 → 8E..6..800 881→	01.05-12.05 01.06-05.06	<b>0 445 010 343</b> <b>0 445 010 331</b>	<b>0 986 437 348</b> <b>0 986 437 093</b>
		171	ASB <D1D>	01.06-06.08	<b>0 445 010 331</b>	<b>0 986 437 093</b>
TDI quattro [8K2; B8]	3,0	155/176 176	CCWA <D50>; CCWB <D1V> CAPA <D50> Fg.-Nr. →8K..8A040 000 →8K..8M015 000 Fg.-Nr. 8K..8A040 001 → 8K..8N015 001→	06.08-03.12 11.07-03.08 04.08-05.08	<b>0 445 010 685</b> <b>0 445 010 331</b> <b>0 445 010 685</b>	<b>0 986 437 404</b> <b>0 986 437 093</b> <b>0 986 437 404</b>
			CCLA <D50>	11.09-10.10	<b>0 445 010 694</b>	
		180	CDUC <D43> CKVB <D43>; CKVC <D43>	11.11-12.15 01.12-12.15	<b>0 445 010 685</b> <b>0 445 010 682</b>	<b>0 986 437 404</b> <b>0 986 437 454</b>
TDI quattro [8W2; B9]	3,0	200	CRTC <DJ3>	05.15-05.17 06.17→	<b>0 445 010 813</b> <b>0 445 010 824</b>	<b>0 986 437 456</b>
TDI, TDI quattro [8W2; B9]	3,0	160	CSWB <DD5>	09.15-05.17 06.17→	<b>0 445 010 813</b> <b>0 445 010 824</b>	<b>0 986 437 456</b>

**A4 Allroad**

2.0 TDI [8KH]	2,0	100/105/ 110/120/ 130	CGLC <DE2>; CGLD <D95>; CJCA <D92>; CJCB <D94>; CJCD <DN4>	11.11-04.16	<b>0 445 010 568</b>	<b>0 986 437 434</b>
		100/105/ 120/125	CAGA <D92>; CAGB <D94>; CAHA <D93>; CAHB <D95>	04.09-01.12	<b>0 445 010 543</b>	<b>0 986 437 410</b>
		100/110/ 120/140	CNHA <DE5>; CNHC <D95>; CSUA <DN4>; CSUB <D94>	09.13-05.16	<b>0 445 010 570</b>	<b>0 986 437 440</b>
TDI [8WH]	2,0	100/110/ 120	DETB <DE5>; DEUA <DN4>; DEUB <D94>	05.16→	<b>0 445 010 570</b>	<b>0 986 437 440</b>
		110	CZHA <DN4>	11.16→	<b>0 445 010 583</b>	<b>0 986 437 440</b>
		140	DESA <DE5>; DFVA <DE5> DETA <DE5>	01.16→ 01.16→	<b>0 445 010 583</b> <b>0 445 010 570</b>	<b>0 986 437 440</b> <b>0 986 437 440</b>
3.0 TDI [8KH]	3,0	176 180	CCWA <D50> CDUC <D43> CKVB <D43> CKVC <D43>	04.09-01.12 01.12-04.16 01.12-05.13 05.13-04.16	<b>0 445 010 685</b> <b>0 445 010 682</b> <b>0 445 010 676</b> <b>0 445 010 676</b>	<b>0 986 437 404</b> <b>0 986 437 454</b> <b>0 986 437 435</b> <b>0 986 437 435</b>
TDI [8WH]	3,0	160/200	CRTC <DJ3>; CSWB <DD5>	01.16→	<b>0 445 010 813</b>	<b>0 986 437 456</b>

**A4 Avant**

2.0 TDI [8K5; B8]	2,0	100	CJCB <D94>	11.10-12.15	<b>0 445 010 565</b>	<b>0 986 437 405</b>
TDI [8W5; B9]	2,0	100	DEUB <D94>	05.15→	<b>0 445 010 570</b>	<b>0 986 437 440</b>
TDI, TDI quattro [8K5; B8]	2,0	88/100/ 105/120/ 125	CAGA <D92>; CAGB <D94>; CAGC <D90>; CAHA <D93>; CAHB <D95>; CMEA <D92>	04.08-03.12	<b>0 445 010 543</b>	<b>0 986 437 410</b>
		88/105/ 110/120/ 130	CGLC <DE2>; CGLD <D95>; CJCA <D92>; CJCC <D90>; CJCD <DN4>; CMFA <D92>; CMFB <DN4>	11.11-12.15	<b>0 445 010 568</b>	<b>0 986 437 434</b>
		100/110/ 120/140	CNHA <DE5>; CNHC <D95>; CSUA <DN4>; CSUB <D94>	09.13-12.15	<b>0 445 010 570</b>	<b>0 986 437 440</b>
TDI, TDI quattro [8W5; B9]	2,0	90/120 110 110/140 140	DETB <DE5>; DEUC <D45> DEUA <DN4> CZHA <DN4>; DESA <DE5> DETA <DE5>	05.16→ 05.15→ 05.15→ 05.15→	<b>0 445 010 570</b> <b>0 445 010 570</b> <b>0 445 010 583</b> <b>0 445 010 570</b>	<b>0 986 437 440</b> <b>0 986 437 440</b> <b>0 986 437 440</b> <b>0 986 437 440</b>
2.7 TDI [8ED, B7]	2,7	132	BPP <D1N> Fg.-Nr. →8E..6..184 000 →8E..6..800 880 Fg.-Nr. 8E..6..184 001 → 8E..6..800 881→	11.05-02.06 03.06-06.08	<b>0 445 010 343</b> <b>0 445 010 331</b>	<b>0 986 437 348</b> <b>0 986 437 093</b>
TDI [8ED; B7]	2,7	120	BSG <D1W> Fg.-Nr. →8E..6..184 000 →8E..6..800 880 Fg.-Nr. 8E..6..184 001 → 8E..6..800 881→	11.05-02.06 03.06-06.08	<b>0 445 010 343</b> <b>0 445 010 331</b>	<b>0 986 437 348</b> <b>0 986 437 093</b>
TDI [8K5; B8]	2,7	120/140	CAMA <D4V>; CAMB <D1W>; CGKA <D4V>; CGKB <D1W>	04.08-03.12	<b>0 445 010 685</b>	<b>0 986 437 404</b>



<b>3.0</b> TDI [8K5; B8]	3,0	150	CLAB <D1Q>	11.11-12.15	<b>0 445 010 676</b>	<b>0 986 437 435</b>
TDI quattro [8ED; B7]	3,0	150	BKN			
			Fg.-Nr. →8E..6..184 000 →8E..6..800 880	01.05-12.05	<b>0 445 010 343</b>	<b>0 986 437 348</b>
			Fg.-Nr. 8E..6..184 001 →8E..6..800 881→	01.06-05.06	<b>0 445 010 331</b>	<b>0 986 437 093</b>
		171	ASB <D1D>	01.06-06.08	<b>0 445 010 331</b>	<b>0 986 437 093</b>
TDI quattro [8K5; B8]	3,0	155/176	CAPA <D50>; CCWA <D50>; CCWB <D1V>	04.08-03.12	<b>0 445 010 685</b>	<b>0 986 437 404</b>
		176	CCLA <D50>	11.09-03.10	<b>0 445 010 694</b>	
				11.10-03.12	<b>0 445 010 685</b>	<b>0 986 437 404</b>
		180	CDUC <D43>	11.11-12.15	<b>0 445 010 682</b>	<b>0 986 437 454</b>
			CKVB <D43>; CKVC <D43>	01.12-12.15	<b>0 445 010 676</b>	<b>0 986 437 435</b>
TDI quattro [8W5; B9]	3,0	200	CRTC <DJ3>	05.15-05.17	<b>0 445 010 813</b>	<b>0 986 437 456</b>
				06.17→	<b>0 445 010 824</b>	
TDI, TDI quattro [8W5; B9]	3,0	160	CSWB <DD5>	09.15-05.17	<b>0 445 010 813</b>	<b>0 986 437 456</b>
				06.17→	<b>0 445 010 824</b>	
<b>A4 Cabriolet</b>						
<b>2.7</b> TDI [8HE; B7]	2,7	132	BPP <D1N>	11.05-03.09	<b>0 445 010 331</b>	<b>0 986 437 093</b>
<b>3.0</b> TDI quattro [8HE; B7]	3,0	150/171	ASB <D1D>; BKN	01.06-03.09	<b>0 445 010 331</b>	<b>0 986 437 093</b>
<b>A4 Sportback</b>						
<b>2.0</b> TDI quattro [8TA]	2,0	130	CGLC <DE2>	01.12-01.17	<b>0 445 010 568</b>	<b>0 986 437 434</b>
<b>A5 Cabriolet</b>						
<b>2.0</b> TDI [8F7]	2,0	120/125	CAHA <D93>; CAHB <D95>	05.09-03.12	<b>0 445 010 543</b>	<b>0 986 437 410</b>
TDI quattro [A57]	2,0	140	DETA <DE5>	03.17→	<b>0 445 010 570</b>	<b>0 986 437 440</b>
TDI, TDI quattro [F57]	2,0	110/140	DESA <DE5>; DETA <DE5>; DEUA <DN4>	03.17→	<b>0 445 010 570</b>	<b>0 986 437 440</b>
TDI, TDI quattro [8F7]	2,0	105/110/ 120/130	CGLC <DE2>; CGLD <D95>; CJCA <D92>; CJCD <DN4>	10.11-01.17	<b>0 445 010 568</b>	<b>0 986 437 434</b>
		110/140	CNHA <DE5>; CSUA <DN4>	09.13-01.17	<b>0 445 010 570</b>	<b>0 986 437 440</b>
<b>2.7</b> TDI [8F7]	2,7	120/140	CGKA <D4V>; CGKB <D1W>	03.09-03.12	<b>0 445 010 685</b>	<b>0 986 437 404</b>
<b>3.0</b> TDI [8F7]	3,0	150	CLAB <D1Q>	09.11-01.17	<b>0 445 010 676</b>	<b>0 986 437 435</b>
TDI quattro [F57]	3,0	210	DCPC <DV8>	11.16→	<b>0 445 010 824</b>	
TDI quattro [8F7]	3,0	160/180	CKVC <D43>; CKVD <DD5>	06.13-01.17	<b>0 445 010 676</b>	<b>0 986 437 435</b>
		176	CCWA <D50>	03.09-03.12	<b>0 445 010 685</b>	<b>0 986 437 404</b>
		180	CDUC <D43>	10.11-01.17	<b>0 445 010 682</b>	<b>0 986 437 454</b>
TDI, TDI quattro [F57]	3,0	160	CSWB <DD5>	12.16-05.17	<b>0 445 010 813</b>	<b>0 986 437 456</b>
				06.17→	<b>0 445 010 824</b>	
<b>A5 Coupé</b>						
<b>2.0</b> TDI, TDI quattro [F53]	2,0	100/110/ 140	CZHA <DN4>; DESA <DE5>; DETA <DE5>; DEUA <DN4>; DEUB <D94>; DFVA <DE5>	06.16→	<b>0 445 010 570</b>	<b>0 986 437 440</b>
TDI, TDI quattro [8T3]	2,0	120/125	CAHA <D93>; CAHB <D95>	01.08-03.12	<b>0 445 010 543</b>	<b>0 986 437 410</b>
		120/130	CGLC <DE2>; CGLD <D95>	08.11-01.17	<b>0 445 010 568</b>	<b>0 986 437 434</b>
		120/140	CNHA <DE5>; CNHC <D95>	09.13-01.17	<b>0 445 010 570</b>	<b>0 986 437 440</b>
<b>2.7</b> TDI [8T3]	2,7	120/140	CAMA <D4V>; CAMB <D1W>; CGKA <D4V>; CGKB <D1W>	07.07-03.12	<b>0 445 010 685</b>	<b>0 986 437 404</b>
<b>3.0</b> TDI quattro [F53]	3,0	200	CRTC <DJ3>	02.17-05.17	<b>0 445 010 813</b>	<b>0 986 437 456</b>
				06.17→	<b>0 445 010 824</b>	
		210	DCPC <DV8>	10.16→	<b>0 445 010 824</b>	
TDI quattro [8T3]	3,0	155	CCWB <D1V>	03.08-05.10	<b>0 445 010 685</b>	<b>0 986 437 404</b>
		176	CAPA <D50>			
			Fg.-Nr. →8T..8..044 600	06.07-03.08	<b>0 445 010 331</b>	<b>0 986 437 093</b>
			Fg.-Nr. 8T..8..044 601→	04.08-03.12	<b>0 445 010 685</b>	<b>0 986 437 404</b>
			CCWA <D50>			
			Fg.-Nr. →8T..8..044 600	03.08-04.08	<b>0 445 010 331</b>	<b>0 986 437 093</b>
			Fg.-Nr. 8T..8..044 601→	05.08-03.12	<b>0 445 010 685</b>	<b>0 986 437 404</b>
		180	CDUC <D43>	08.11-01.17	<b>0 445 010 682</b>	<b>0 986 437 454</b>
			CKVB <D43>	08.11-12.15	<b>0 445 010 676</b>	<b>0 986 437 435</b>
TDI, TDI quattro [F53]	3,0	160	CSWB <DD5>	06.16→	<b>0 445 010 813</b>	<b>0 986 437 456</b>
TDI, TDI quattro [8T3]	3,0	150/160/ 180	CKVC <D43>; CKVD <DD5>; CLAB <D1Q>	10.11-01.17	<b>0 445 010 676</b>	<b>0 986 437 435</b>
<b>A5 Sportback</b>						
<b>2.0</b> TDI [8TA]	2,0	100/105/ 110/120/ 130	CGLC <DE2>; CGLD <D95>; CJCA <D92>; CJCB <D94>; CJCD <DN4>; CMFA <D92>; CMFB <DN4>	08.11-01.17	<b>0 445 010 568</b>	<b>0 986 437 434</b>
TDI, TDI quattro [F5A]	2,0	100/110/ 140	CZHA <DN4>; DESA <DE5>; DETA <DE5>; DEUA <DN4>; DEUB <D94>; DFVA <DE5>	06.16→	<b>0 445 010 570</b>	<b>0 986 437 440</b>





◀ AUDI

2.0 TDI, TDI quattro [8TA]	2,0	100/105/120/125	CAGA <D92>; CAGB <D94>; CAHA <D93>; CAHB <D95>; CMEA <D92>	09.09-03.12	0 445 010 543	0 986 437 410
		100/110/120/140	CNHA <DE5>; CNHC <D95>; CSUA <DN4>; CSUB <D94>	09.13-01.17	0 445 010 570	0 986 437 440
2.7 TDI [8TA]	2,7	120/140	CAMA <D4V>; CGKA <D4V>; CGKB <D1W>	09.09-03.12	0 445 010 685	0 986 437 404
TDI [8T3]	2,7	120	CAMB <D1W>	09.09-03.12	0 445 010 685	0 986 437 404
3.0 TDI quattro [F5A]	3,0	200	CRTC <DJ3>	02.17-05.17	0 445 010 813	0 986 437 456
				06.17→	0 445 010 824	
		210	DCPC <DV8>	10.16→	0 445 010 824	
TDI quattro [8F7]	3,0	160	CKVD <DD5>	05.15-01.17	0 445 010 676	0 986 437 435
TDI quattro [8TA]	3,0	155/176	CAPA <D50>; CCWA <D50>; CCWB <D1V>	05.09-03.12	0 445 010 685	0 986 437 404
		180	CDUC <D43>	08.11-01.17	0 445 010 682	0 986 437 454
			CKVB <D43>	08.11-06.14	0 445 010 676	0 986 437 435
TDI, TDI quattro [F5A]	3,0	160	CSWB <DD5>	02.17→	0 445 010 813	0 986 437 456
TDI, TDI quattro [8TA]	3,0	150/180	CKVC <D43>; CLAB <D1Q>	10.11-01.17	0 445 010 676	0 986 437 435

**A6**

2.0 TDI [4G; C7]	2,0	100/120/130	CGLC <DE2>; CGLD <D95>; CGLE <D94>; CMGB <DE2>	02.11-04.15	0 445 010 568	0 986 437 434
		140	CZJA <DE5>	05.15→	0 445 010 583	0 986 437 440
TDI, TDI e [4F2; C6]	2,0	100/120/125	CAGB <D94>; CAHA <D93>; CAHB <D95>	10.08-08.11	0 445 010 543	0 986 437 410
TDI, TDI quattro [4G; C7]	2,0	100/110/140	CNHA <DE5>; CSUD <DN4>; CSUE <D94>	11.13→	0 445 010 570	0 986 437 440
			DDCA <D94>; DDCB <DN4>; DDDA <DE5>	05.16→	0 445 010 570	0 986 437 440
2.7 TDI, TDI quattro [4F2; C6]	2,7	120	BSG <D1W>			
			Fg.-Nr. →4F..6..132 000	11.04-12.05	0 445 010 343	0 986 437 348
			Fg.-Nr. 4F..6..132 001→	01.06-10.08	0 445 010 331	0 986 437 093
		120/140	CANA <D4V>; CANB; CANC <D4V>; CAND <D1W>	10.08-08.11	0 445 010 685	0 986 437 404
		132	BPP <D1N>			
			Fg.-Nr. →4F..6..132 000	11.04-12.05	0 445 010 343	0 986 437 348
			Fg.-Nr. 4F..6..132 001→	01.06-10.08	0 445 010 331	0 986 437 093
3.0 TDI [4G; C7]	3,0	155	CZVD <D1V>	08.15-05.17	0 445 010 813	0 986 437 456
				06.17→	0 445 010 824	
		155/160	CTCB <TH1>; CTCC <TH1>	09.14-07.15	0 445 010 676	0 986 437 435
		160	CZVB <DD5>	08.15-05.17	0 445 010 813	0 986 437 456
				06.17→	0 445 010 824	
TDI quattro [4F2; C6]	3,0	155	BNG <D1V>			
			Fg.-Nr. →4F..6..132 000	04.04-12.05	0 445 010 343	0 986 437 348
			Fg.-Nr. 4F..6..132 001→	01.06-10.08	0 445 010 331	0 986 437 093
		155/176	CDYA <D50>; CDYB <D1V>; CDYC <D50>	10.08-08.11	0 445 010 685	0 986 437 404
		165	BMK			
			Fg.-Nr. →4F..6..132 000	04.04-12.05	0 445 010 343	0 986 437 348
			Fg.-Nr. 4F..6..132 001→	01.06-05.06	0 445 010 331	0 986 437 093
		171	ASB <D1D>	06.06-10.08	0 445 010 331	0 986 437 093
TDI quattro [4G; C7]	3,0	155/160	CRTE <DD5>; CRTF <D1V>	09.14-11.15	0 445 010 813	0 986 437 456
		160	CZVA <DD5>	11.15-05.17	0 445 010 813	0 986 437 456
				06.17→	0 445 010 824	
		176	CPNB <D50>	05.13→	0 445 010 692	0 986 437 435
		180	CDUC <D43>	11.10-05.12	0 445 010 682	0 986 437 454
	CDUD <D43>		04.12-06.16	0 445 010 682	0 986 437 454	
			CKVB <D43>	11.11-05.12	0 445 010 692	0 986 437 435
			CKVC <D43>	04.12-04.15	0 445 010 692	0 986 437 435
		200	CRTD <DJ3>	09.14-05.17	0 445 010 813	0 986 437 456
					06.17→	0 445 010 824
		230	CGQB <DD3>	12.11-04.15	0 445 010 690	0 986 437 463
		235/240	CVUA <TG1>; CVUB <DD6>	09.14→	0 445 010 690	0 986 437 463
TDI, TDI quattro [4G; C7]	3,0	150	CLAA <D1Q>; CLAB <D1Q>	11.10-04.15	0 445 010 676	0 986 437 435
		155	CZVC <D1V>	11.15-05.17	0 445 010 813	0 986 437 456
				06.17→	0 445 010 824	

**A6 Allroad**

2.7 TDI [4FH; C6]	2,7	120/132	BPP <D1N>; BSG <D1W>	05.06-10.08	0 445 010 331	0 986 437 093
		120/140	CANC <D4V>; CAND <D1W>	10.08-08.11	0 445 010 685	0 986 437 404
3.0 TDI [4FH; C6]	3,0	155/171	ASB <D1D>; BNG <D1V>	05.06-10.08	0 445 010 331	0 986 437 093
		155/176	CDYA <D50>; CDYB <D1V>; CDYC <D50>	10.08-08.11	0 445 010 685	0 986 437 404



<b>3.0 TDI [4G; C7]</b>	3,0	140	CZVF <DJ0>	11.15-05.17	<b>0 445 010 813</b>	<b>0 986 437 456</b>	
				06.17→	<b>0 445 010 824</b>		
			150/180	CKVC <D43>; CLAA <D1Q>	01.12-12.14	<b>0 445 010 676</b>	<b>0 986 437 435</b>
			155	CRTF <D1V>	09.14-05.17	<b>0 445 010 813</b>	<b>0 986 437 456</b>
					06.17→	<b>0 445 010 824</b>	
				CZVC <D1V>	11.15-05.17	<b>0 445 010 813</b>	<b>0 986 437 456</b>
					06.17→	<b>0 445 010 824</b>	
			160	CRTE <DD5>	09.14-05.17	<b>0 445 010 813</b>	<b>0 986 437 456</b>
					06.17→	<b>0 445 010 824</b>	
				CZVA <DD5>	11.15-05.17	<b>0 445 010 813</b>	<b>0 986 437 456</b>
					06.17→	<b>0 445 010 824</b>	
	180	CDUD <D43>	01.12-06.16	<b>0 445 010 682</b>	<b>0 986 437 454</b>		
	200	CRTD <DJ3>	09.14-05.17	<b>0 445 010 813</b>	<b>0 986 437 456</b>		
			06.17→	<b>0 445 010 824</b>			
	230	CGQB <DD3>	01.12-12.14	<b>0 445 010 690</b>	<b>0 986 437 463</b>		
	235	CVUA <TG1>	09.14→	<b>0 445 010 690</b>	<b>0 986 437 463</b>		

**A6 Avant**

<b>2.0 TDI [4G; C7]</b>	2,0	100/120/	CGLC <DE2>; CGLD <D95>; CGLE <D94>;	05.11-04.15	<b>0 445 010 568</b>	<b>0 986 437 434</b>
		130	CMGB <DE2>			
		140	CZJA <DE5>			
TDI, TDI e [4F5; C6]	2,0	100/120/	CAGB <D94>; CAHA <D93>; CAHB <D95>	10.08-08.11	<b>0 445 010 543</b>	<b>0 986 437 410</b>
		125				
TDI, TDI quattro [4G; C7]	2,0	100/110/	CNHA <DE5>; CSUD <DN4>; CSUE <D94>	11.13→	<b>0 445 010 570</b>	<b>0 986 437 440</b>
		140	DDCA <D94>; DDCB <DN4>; DDDA <DE5>	05.16→	<b>0 445 010 570</b>	<b>0 986 437 440</b>

<b>2.7 TDI, TDI quattro [4F5; C6]</b>	2,7	120	BSG <D1W>					
				Fg.-Nr. →4F..6..132 000	03.05-12.05	<b>0 445 010 343</b>	<b>0 986 437 348</b>	
				Fg.-Nr. 4F..6..132 001→	01.06-05.06	<b>0 445 010 331</b>	<b>0 986 437 093</b>	
					01.06-10.08	<b>0 445 010 331</b>	<b>0 986 437 093</b>	
				120/140	CANA <D4V>; CANB; CANC <D4V>; CAND <D1W>	10.08-08.11	<b>0 445 010 685</b>	<b>0 986 437 404</b>
				132	BPP <D1N>			
			Fg.-Nr. →4F..6..132 000	11.04-12.05	<b>0 445 010 343</b>	<b>0 986 437 348</b>		
			Fg.-Nr. 4F..6..132 001→	01.06-10.08	<b>0 445 010 331</b>	<b>0 986 437 093</b>		

<b>3.0 TDI [4G; C7]</b>	3,0	155	CZVD <D1V>	08.15-05.17	<b>0 445 010 813</b>	<b>0 986 437 456</b>			
					06.17→	<b>0 445 010 824</b>			
				155/160	CTCB <TH1>; CTCC <TH1>	09.14-07.15	<b>0 445 010 676</b>	<b>0 986 437 435</b>	
			TDI quattro [4F5; C6]	3,0	155	BNG <D1V>			
						Fg.-Nr. →4F..6..132 000	03.05-12.05	<b>0 445 010 343</b>	<b>0 986 437 348</b>
						Fg.-Nr. 4F..6..132 001→	01.06-10.08	<b>0 445 010 331</b>	<b>0 986 437 093</b>
					155/176	CDYA <D50>; CDYB <D1V>; CDYC <D50>	10.08-08.11	<b>0 445 010 685</b>	<b>0 986 437 404</b>
					165	BMK			
						Fg.-Nr. →4F..6..132 000	03.05-12.05	<b>0 445 010 343</b>	<b>0 986 437 348</b>
						Fg.-Nr. 4F..6..132 001→	01.06-05.06	<b>0 445 010 331</b>	<b>0 986 437 093</b>
			TDI quattro [4G; C7]	3,0	155/160	CRTE <DD5>; CRTF <D1V>	09.14-11.15	<b>0 445 010 813</b>	<b>0 986 437 456</b>
160	CZVA <DD5>	11.15-05.17				<b>0 445 010 813</b>	<b>0 986 437 456</b>		
		06.17→				<b>0 445 010 824</b>			
	180	CDUC <D43>				05.11-05.12	<b>0 445 010 682</b>	<b>0 986 437 454</b>	
		CDUD <D43>				04.12-06.16	<b>0 445 010 682</b>	<b>0 986 437 454</b>	
		CKVB <D43>				11.11-05.12	<b>0 445 010 692</b>	<b>0 986 437 435</b>	
		CKVC <D43>				04.12-04.15	<b>0 445 010 692</b>	<b>0 986 437 435</b>	
	200	CRTD <DJ3>				09.14-05.17	<b>0 445 010 813</b>	<b>0 986 437 456</b>	
						06.17→	<b>0 445 010 824</b>		
	230	CGQB <DD3>				12.11-04.15	<b>0 445 010 690</b>	<b>0 986 437 463</b>	
	235/240	CVUA <TG1>; CVUB <DD6>				09.14→	<b>0 445 010 690</b>	<b>0 986 437 463</b>	
TDI, TDI quattro [4G; C7]	3,0	150	CLAA <D1Q>; CLAB <D1Q>	05.11-04.15	<b>0 445 010 676</b>	<b>0 986 437 435</b>			
			155	CZVC <D1V>	11.15-05.17	<b>0 445 010 813</b>	<b>0 986 437 456</b>		
					06.17→	<b>0 445 010 824</b>			
			160	CZVB <DD5>	08.15-05.17	<b>0 445 010 813</b>	<b>0 986 437 456</b>		
			06.17→	<b>0 445 010 824</b>					

**A7 Sportback**

<b>3.0 TDI quattro [4G, C7]</b>	3,0	155	CZVC <D1V>	11.15-05.17	<b>0 445 010 813</b>	<b>0 986 437 456</b>	
					06.17-05.18	<b>0 445 010 824</b>	
			155/160	CRTE <DD5>; CRTF <D1V>	07.14-11.15	<b>0 445 010 813</b>	<b>0 986 437 456</b>





◀ AUDI

3.0 TDI quattro [4G; C7]	3,0	160	CZVA <DD5>	11.15-05.17	0 445 010 813	0 986 437 456	
				06.17-05.18	0 445 010 824		
			176	CPNB <D50>	05.13-06.17	0 445 010 692	0 986 437 435
			180	CDUD <D43>; CKVC <D43>	05.12-05.16	0 445 010 682	0 986 437 454
			200	CRTD <DJ3>	05.14-05.17	0 445 010 813	0 986 437 456
				06.17-05.18	0 445 010 824		
			230	CGQB <DD3>	11.11-03.15	0 445 010 690	0 986 437 463
			235	CVUA <TG1>	05.14-05.18	0 445 010 690	0 986 437 463
			240	CVUB <DD6>	09.14-05.18	0 445 010 690	0 986 437 463
			TDI, TDI quattro [4G; C7]	3,0	140	CZVE <DJ0>	11.15-05.17
	06.17-05.18	0 445 010 824					
	CZVF <DJ0>	11.15-05.17				0 445 010 813	0 986 437 456
	06.17-05.18	0 445 010 824					
150/180	CDUC <D43>; CKVB <D43>; CLAA <D1Q>; CLAB <D1Q>	07.10-03.15				0 445 010 676	0 986 437 435
155	CZVD <D1V>	08.15-05.17				0 445 010 813	0 986 437 456
	06.17-05.18	0 445 010 824					
155/160	CTCB <TH1>; CTCC <TH1>	07.14-11.15				0 445 010 676	0 986 437 435
160	CZVB <DD5>	08.15-05.17				0 445 010 813	0 986 437 456
	06.17-05.18	0 445 010 824					

**A8**

3.0 TDI quattro [4E; D3]	3,0	155	BNG <D1V>						
				Fg.-Nr. →4E..6..011 520	11.03-09.05	0 445 010 343	0 986 437 348		
				Fg.-Nr. 4E..6..011 521→	10.05-07.10	0 445 010 331	0 986 437 093		
			171	ASB <D1D>					
				Fg.-Nr. →4E..6..011 520	01.04-09.05	0 445 010 343	0 986 437 348		
				Fg.-Nr. 4E..6..011 521→	10.05-07.10	0 445 010 331	0 986 437 093		
TDI quattro [4H; D4]	3,0	150/184	CLAB <D1Q>; CMHA <D13>	09.11-04.14	0 445 010 676	0 986 437 435			
			155	CTBB <TH1>	09.13-01.18	0 445 010 676	0 986 437 435		
			155/184	CDTA <D51>; CDTB <D1V>	07.10-04.14	0 445 010 682	0 986 437 454		
			176	CPNA <TH1>; CPNB <D50>	11.12-06.16	0 445 010 692	0 986 437 435		
			184	CDTC <TF1>	09.13-01.18	0 445 010 682	0 986 437 454		
			190/193	CTBA <DD7>; CTBD <DV7>	10.13-01.18	0 445 010 676	0 986 437 435		
3.3 TDI quattro [4D2; D2]	3,3	165	AKF	12.99-08.02		0 986 437 316			
4.0 TDI quattro [4E; D3]	4,0	202	ASE	05.03-07.05	0 445 010 358	0 986 437 346			
4.2 TDI quattro [4E; D3]	4,2	235/240	BMC; BVN	01.05-07.10	0 445 010 340	0 986 437 344			
			TDI quattro [4H; D4]	4,2	258	CDSB <DD2>	11.09-04.14	0 445 010 801	0 986 437 418
					283	CTEC <TE5>	10.13-01.18	0 445 010 675	0 986 437 418

**A8 50**

3.0 TDI quattro [4H; D4]	3,0	210	DDVC <DV8>	08.17→	0 445 010 824	
--------------------------	-----	-----	------------	--------	---------------	--

**Q2**

2.0 TDI, TDI quattro [GAB]	2,0	105/110/ 140	CRFC <DN6>; DCYA <DN4>; DFCA <DN4>; DFHA <DE5>	07.16→	0 445 010 570	0 986 437 440
----------------------------	-----	-----------------	--	--------	---------------	---------------

**Q3**

2.0 TDI [8U]	2,0	110	DBBA <DN4>	11.15→	0 445 010 583	0 986 437 440	
TDI, TDI quattro [8U]	2,0	88/100/ 110/135	CUVB <TL4>; CUVC <DN4>; CUVD <D90>; CUWA <DK7>; CYLA <DK7>; DFTA <DN4>; DFTB <DE9>; DFTC <D90>; DFUA <DK7>	11.14→	0 445 010 570	0 986 437 440	
			100/103/ 120/130	CFFA <D94>; CFFB <D91>; CFGC <DE2>; CFGD <D95>; CLJA <D91>; CLLB <DE2>	06.11-04.15	0 445 010 568	0 986 437 434

**Q5**

2.0 TDI quattro [8RB]	2,0	100/105/ 120/125	CAGA <D92>; CAGB <D94>; CAHA <D93>; CAHB <D95>	11.08-09.10	0 445 010 543	0 986 437 410
TDI, TDI quattro [FYB]	2,0	100/110/ 120/140	DESA <DE5>; DETA <DE5>; DETB <DE5>; DEUA <DN4>; DEUB <D94>	05.16→	0 445 010 583	0 986 437 440
			100/105/ 110/120/ 125/130	CGLA <D95>; CGLB <D93>; CGLC <DE2>; CGLD <D95>; CJCA <D92>; CJCB <D94>; CJCD <DN4>; CMGA <D93>; CMGB <DE2>	05.10-05.17	0 445 010 568
TDI, TDI quattro [8RB]	2,0	100/110/ 120/140	CNHA <DE5>; CNHC <D95>; CSUA <DN4>; CSUB <D94>	04.14-05.17	0 445 010 570	0 986 437 440
3.0 TDI quattro [FYB]	3,0	210	DCPC <DV8>	09.17→	0 445 010 824	
TDI quattro [8RB]	3,0	155/176	CCWA <D50>; CCWB <D1V>	11.08-09.12	0 445 010 685	0 986 437 404
			176	CPNB <D50>	09.13-05.17	0 445 010 692



<b>3.0</b> TDI quattro [8RB]	3,0	180	CDUD <D43>	06.12-05.17	<b>0 445 010 682</b>	<b>0 986 437 454</b>
		184/190	CTBA <DD7>; CTBC <D51>	11.13-05.17	<b>0 445 010 676</b>	<b>0 986 437 435</b>
<b>Q7</b>						
<b>3.0</b> TDI [4LB]	3,0	150/176	CJGA <D50>; CJGC <D1Q>	05.10-05.11	<b>0 445 010 676</b>	<b>0 986 437 435</b>
		150/180	CJGD <D43>; CJMA <D1Q>; CLZB <D43>; CRCA <D43>	11.10-08.15	<b>0 445 010 676</b>	<b>0 986 437 435</b>
		155/171	BUG <D1D>; BUN <D1V>	03.06-05.08	<b>0 445 010 331</b>	<b>0 986 437 093</b>
		155/176	CASA <D50>; CASB <D1V>	09.07-05.10	<b>0 445 010 685</b>	<b>0 986 437 404</b>
		165	CATA <D1T>	11.08-10.10	<b>0 445 010 694</b>	
		176	CCMA <D50>	06.09-10.10	<b>0 445 010 694</b>	
		CNRB <D50>	11.10-05.11	ASB <b>0 445 010 656</b>		
			05.12-08.15	<b>0 445 010 692</b>	<b>0 986 437 435</b>	
TDI [4MB]	3,0	155/160/ 183/190/ 200	CRTC <DJ3>; CRTE <DD5>; CUEA <DD7>; CVMD <DD9>; CZZA <DD5>; CZZB <D1V>	01.15→	<b>0 445 010 813</b>	<b>0 986 437 456</b>
<b>4.2</b> TDI [4LB]	4,1	250	CCFC <D57>	05.10-08.15	<b>0 445 010 664</b>	<b>0 986 437 416</b>
		240	BTR <D1S>	03.07-06.09	<b>0 445 010 340</b>	<b>0 986 437 344</b>
		250	CCFA <D57>	06.09-05.10	<b>0 445 010 664</b>	<b>0 986 437 416</b>
<b>6.0</b> TDI [4LB]	6,0	368	CCGA <D56>	09.08-04.12	<b>0 445 010 663</b>	<b>0 986 437 414</b>
<b>SQ5</b>						
<b>3.0</b> TDI quattro [8RB]	3,0	230/240	CGQB <DD3>; CVUB <DD6>; CVUC <DD3>	12.12-05.17	<b>0 445 010 690</b>	<b>0 986 437 463</b>
		250	DEHA <DD4>	11.15-05.17	<b>0 445 010 830</b>	
<b>SQ7</b>						
<b>4.0</b> TDI quattro [4MB]	4,0	310	DCDB <DJ7>	07.16-10.17	<b>0 445 010 826</b>	
				11.17→	<b>0 445 010 838</b>	
		320	CZAC <DK4>	04.16-10.17	<b>0 445 010 826</b>	
			11.17→	<b>0 445 010 838</b>		
<b>TT Coupé</b>						
<b>2.0</b> TDI quattro [8J3]	2,0	125	CBBB <D93>	06.08-06.10	<b>0 445 010 543</b>	<b>0 986 437 410</b>
			CFGB <D93>	05.10-06.14	<b>0 445 010 565</b>	<b>0 986 437 405</b>
TDI, TDI quattro [FV3]	2,0	135	CUNA <DK7>	07.14→	<b>0 445 010 570</b>	<b>0 986 437 440</b>
<b>TT Roadster</b>						
<b>2.0</b> TDI quattro [8J9]	2,0	125	CBBB <D93>	06.08-06.10	<b>0 445 010 543</b>	<b>0 986 437 410</b>
			CFGB <D93>	05.10-06.14	<b>0 445 010 565</b>	<b>0 986 437 405</b>
TDI, TDI quattro [FV9]	2,0	135	CUNA <DK7>	11.14→	<b>0 445 010 570</b>	<b>0 986 437 440</b>

**BENTLEY**

<b>Bentayga</b>						
<b>4.0</b> TDI	4,0	310/320	CZAA; CZAC <DK4>	11.16→	<b>0 445 010 826</b>	

**BMW**

<b>Serie M</b>										
<b>M 550</b> d xDrive [F 10]	3,0	280	N57 D30C	03.12-10.16	<b>0 445 010 672</b>	<b>0 986 437 458</b>				
<b>M 550</b> Touring d xDrive [F 11]	3,0	280	N57 D30C	03.12-12.16	<b>0 445 010 672</b>	<b>0 986 437 458</b>				
				01.17-02.17	<b>0 445 010 848</b>					
<b>X 5 M</b> 50 d xDrive [E 70]	3,0	280	N57 D30C	04.12-06.13	<b>0 445 010 672</b>	<b>0 986 437 458</b>				
				50 d xDrive [F 15]	3,0	280	N57 D30C	11.13-12.16	<b>0 445 010 672</b>	<b>0 986 437 458</b>
				01.17→	<b>0 445 010 848</b>					
<b>X 6 M</b> 50 d [F 16]	3,0	280	N57 D30C	11.14-12.16	<b>0 445 010 672</b>	<b>0 986 437 458</b>				
				01.17→	<b>0 445 010 848</b>					
50 d xDrive [E 71]	3,0	280	N57 D30C	04.12-06.14	<b>0 445 010 672</b>	<b>0 986 437 458</b>				
<b>Serie M5</b>										
<b>550</b> d xDrive [G 30]	3,0	294	B57 D30C	06.17→	<b>0 445 010 856</b>					
<b>Serie X1</b>										
<b>16</b> d sDrive [E 84]	2,0	85	N47 D20C	07.12-06.15	<b>0 445 010 554</b>	<b>0 986 437 425</b>				
				d sDrive [F 48]	1,5	85	B37 C15A	11.15-09.16	<b>0 445 010 587</b>	<b>0 986 437 452</b>
							10.16→	<b>0 445 010 767</b>		
			B37 C15A <B37B>	02.18→	<b>0 445 010 776</b>					







◀ BMW

<b>18</b>	d sDrive [E 84]	2,0	105	N47 D20C <N47N>	07.12-06.15	<b>0 445 010 554</b>	<b>0 986 437 425</b>
	d sDrive, d xDrive [E 84]	2,0	100-105	N47 D20C	11.09-06.12	<b>0 445 010 558</b>	<b>0 986 437 426</b>
	d sDrive, d xDrive [F 48]	2,0	100-110	B47 C20A	10.15-09.16	<b>0 445 010 587</b>	<b>0 986 437 452</b>
			110	B47 C20B <B47B>	10.16→	<b>0 445 010 767</b>	
					02.18→	<b>0 445 010 776</b>	
<b>20</b>	d sDrive, d xDrive [E 84]	2,0	120-130	N47 D20C	10.09-06.12	<b>0 445 010 558</b>	<b>0 986 437 426</b>
	d sDrive, d xDrive [F 48]	2,0	120-140	B47 C20A	10.15-09.16	<b>0 445 010 587</b>	<b>0 986 437 452</b>
					10.16→	<b>0 445 010 767</b>	
			140	B47 C20B <B47D>	11.17→	<b>0 445 010 774</b>	
	d sDrive, ed sDrive, s xDrive [E 84]	2,0	120/135	N47 D20C <N47N>	09.11-06.15	<b>0 445 010 573</b>	<b>0 986 437 424</b>
<b>23</b>	d xDrive [E 84]	2,0	150	N47 D20D	10.09-06.12	<b>0 445 010 547</b>	
<b>25</b>	d sDrive [E 84]	2,0	160	N47 D20D	07.12-06.15	<b>0 445 010 561</b>	<b>0 986 437 401</b>
	d xDrive [F 48]	2,0	170	B47 C20B <B47>	10.15-09.16	<b>0 445 010 732</b>	
					10.16→	<b>0 445 010 769</b>	
<b>Serie X2</b>							
<b>18</b>	d sDrive [F 39]	2,0	110	B47 C20A	01.18→	<b>0 445 010 767</b>	
	d sDrive, d xDrive [F 39]	2,0	110	B47 C20B <B47B>	01.18→	<b>0 445 010 776</b>	
<b>20</b>	d xDrive [F 39]	2,0	140	B47 C20A	01.18→	<b>0 445 010 767</b>	
				B47 C20B <B47D>	01.18→	<b>0 445 010 774</b>	
<b>25</b>	d xDrive [F 39]	2,0	170	B47 C20B <B47>	01.18→	<b>0 445 010 769</b>	
<b>Serie X3</b>							
<b>2.0</b>	d [E 83]	2,0	110	20 4D 4 <M 47N>	10.04-09.07	<b>0 445 010 126</b>	<b>0 986 437 323</b>
			130	N47 D20A	09.07-08.08	<b>0 445 010 580</b>	<b>0 986 437 402</b>
<b>3.0</b>	d [E 83]	3,0	150	30 6D 2 <M 57N>	01.04-09.05	<b>0 445 010 073</b>	<b>0 986 437 320</b>
	d, sd [E 83]	3,0	160/210	30 6D 3 <M 57N2>; 30 6D 5	09.05-08.08	<b>0 445 010 126</b>	<b>0 986 437 323</b>
<b>18</b>	d sDrive [F 25]	2,0	105/110	N47 D20C	10.12-11.14	<b>0 445 010 573</b>	<b>0 986 437 424</b>
			110	B47 D20A	11.14-09.16	<b>0 445 010 587</b>	<b>0 986 437 452</b>
					10.16-08.17	<b>0 445 010 767</b>	
	d sDrive [G 01]	2,0	110	B47 D20A	03.18→	<b>0 445 010 767</b>	
	d xDrive [E 83]	2,0	105	N47 D20C	05.09-08.10	<b>0 445 010 580</b>	<b>0 986 437 402</b>
<b>20</b>	d xDrive [E 83]	2,0	120-130	N47 D20...	09.08-08.10	<b>0 445 010 580</b>	<b>0 986 437 402</b>
	d xDrive [F 25]	2,0	120-135	N47 D20C	10.10-11.16	<b>0 445 010 573</b>	<b>0 986 437 424</b>
					12.16-08.17	<b>0 445 010 794</b>	
			120-155	B47 D20A	04.14-09.16	<b>0 445 010 587</b>	<b>0 986 437 452</b>
					10.16-08.17	<b>0 445 010 767</b>	
	d xDrive [G 01]	2,0	140	B47 D20A	11.17→	<b>0 445 010 767</b>	
<b>25</b>	d xDrive [G 01]	2,0	170	B47 D20B <B47>	03.18→	<b>0 445 010 769</b>	
<b>30</b>	d xDrive [E 83]	3,0	155-160	30 6D 3 <M 57N2>	09.08-08.10	<b>0 445 010 126</b>	<b>0 986 437 323</b>
	d xDrive [F 25]	3,0	155-210	N57 D30A	04.11-10.16	<b>0 445 010 678</b>	<b>0 986 437 429</b>
					11.16-08.17	<b>0 445 010 852</b>	
	d xDrive [G 01]	3,0	195	B57 D30A	11.17→	<b>0 445 010 840</b>	
<b>35</b>	d xDrive [E 83]	3,0	210	30 6D 5	09.08-08.10	<b>0 445 010 126</b>	<b>0 986 437 323</b>
	d xDrive [F 25]	3,0	230	N57 D30B <N57Z>	09.11-10.16	<b>0 445 010 668</b>	<b>0 986 437 453</b>
					11.16-08.17	<b>0 445 010 854</b>	
<b>Serie X4</b>							
<b>20</b>	d xDrive [F 26]	2,0	120-140	B47 D20A	06.14-09.16	<b>0 445 010 587</b>	<b>0 986 437 452</b>
					10.16→	<b>0 445 010 767</b>	
	d xDrive [G 02]	2,0	140	B47 D20A	06.18→	<b>0 445 010 767</b>	
<b>25</b>	d xDrive [G 02]	2,0	170	B47 D20B <B47>	06.18→	<b>0 445 010 769</b>	
<b>30</b>	d xDrive [F 26]	3,0	155-210	N57 D30A	06.14-10.16	<b>0 445 010 678</b>	<b>0 986 437 429</b>
					11.16→	<b>0 445 010 852</b>	
<b>35</b>	d xDrive [F 26]	3,0	230	N57 D30B	06.14-10.16	<b>0 445 010 668</b>	<b>0 986 437 453</b>
					11.16→	<b>0 445 010 854</b>	
<b>Serie X4 M</b>							
<b>40</b>	d xDrive [G 02]	3,0	240	B57 D30B	06.18→	<b>0 445 010 840</b>	
<b>Serie X5</b>							
<b>3.0</b>	d [E 53]	3,0	135	30 6D 1 <M 57 D 30>	03.01-09.03	<b>0 445 010 009</b>	<b>0 986 437 004</b>
	d xDrive, sd xDrive [E 70]	3,0	155-173/210	30 6D 3 <M 57N2>; 30 6D 5	03.07-09.08	<b>0 445 010 126</b>	<b>0 986 437 323</b>
<b>25</b>	d sDrive, d xDrive [F 15]	2,0	160	N47 D20D	12.13-07.15	<b>0 445 010 561</b>	<b>0 986 437 401</b>
			170	B47 D20B <B47>	07.15-09.16	<b>0 445 010 732</b>	
					10.16→	<b>0 445 010 769</b>	
	d xDrive [F 15]	3,0	160	N57 D30A <N57>	07.15→	<b>0 445 010 678</b>	<b>0 986 437 429</b>





30	d xDrive [E 70]	3,0	155-190	N57 D30A	04.10-06.13	0 445 010 688	0 986 437 427
			173	30 6D 3 <M 57N2>	10.08-03.10	0 445 010 126	0 986 437 323
	d xDrive [F 15]	3,0	190-210	N57 D30A <N57Z>	11.13-10.16	0 445 010 678	0 986 437 429
					11.16→	0 445 010 852	
35	d xDrive [E 70]	3,0	210	30 6D 5	10.08-03.10	0 445 010 126	0 986 437 323
40	d xDrive [E 70]	3,0	225	N57 D30B <N57Z>	04.10-06.13	0 445 010 665	0 986 437 428
	d xDrive [F 15]	3,0	230	N57 D30B	03.14-10.16	0 445 010 668	0 986 437 453
							11.16→

**Serie X6**

30	d xDrive [E 71]	3,0	155-180	N57 D30A	04.10-06.14	0 445 010 688	0 986 437 427
			173	30 6D 3 <M 57N2>	05.08-03.10	0 445 010 126	0 986 437 323
	d xDrive [F 16]	3,0	155-210	N57 D30A	11.14-10.16	0 445 010 678	0 986 437 429
					11.16→	0 445 010 852	
35	d xDrive [E 71]	3,0	210	30 6D 5	05.08-03.10	0 445 010 126	0 986 437 323
40	d xDrive [E 71]	3,0	225	N57 D30B <N57Z>	04.10-06.14	0 445 010 665	0 986 437 428
	d xDrive [F 16]	3,0	230	N57 D30B	12.14-10.16	0 445 010 668	0 986 437 453
					11.16→	0 445 010 854	

**Serie 1**

114	d [F 20]	1,5	70	B37 D15A	07.15-09.16	0 445 010 587	0 986 437 452	
					10.16→	0 445 010 767		
			1,6	70	N47 D16A	11.12-05.15	0 445 010 572	0 986 437 403
	d [F 21]	1,5	70	B37 D15A	07.15-09.16	0 445 010 587	0 986 437 452	
					10.16→	0 445 010 767		
			1,6	70	N47 D16A	11.12-05.15	0 445 010 572	0 986 437 403
116	d [E 81]	2,0	66-85	N47 D20...	03.09-12.11	0 445 010 580	0 986 437 402	
	d [E 87]	2,0	66-85	N47 D20...	03.09-06.11	0 445 010 580	0 986 437 402	
	d [F 20]	2,0	85	N47 D20C	09.11-02.15	0 445 010 554	0 986 437 425	
	d [F 21]	2,0	85	N47 D20C	09.12-02.15	0 445 010 554	0 986 437 425	
	d, d ed [F 20]	1,5	85	B37 D15A	03.15-09.16	0 445 010 587	0 986 437 452	
							10.16→	0 445 010 767
	d, d ed [F 21]	1,5	85	B37 D15A	03.15-09.16	0 445 010 587	0 986 437 452	
					10.16→	0 445 010 767		
	d ed [F 20]	1,6	85	N47 D16A	03.12-02.15	0 445 010 572	0 986 437 403	
	d ed [F 21]	1,6	85	N47 D16A	09.12-02.15	0 445 010 572	0 986 437 403	
118	d [E 81]	2,0	100-105	N47 D20...	05.07-12.11	0 445 010 580	0 986 437 402	
	d [E 87]	2,0	90	20 4D 4 <M 47N>	09.04-03.07	0 445 010 126	0 986 437 323	
			100-105	N47 D20...	03.07-06.11	0 445 010 580	0 986 437 402	
	d [F 21]	2,0	110	B47 D20A	03.15-09.16	0 445 010 587	0 986 437 452	
					10.16→	0 445 010 767		
	d, d xDrive [F 20]	2,0	105	N47 D20C	09.11-02.15	0 445 010 554	0 986 437 425	
			110	B47 D20A	03.15-09.16	0 445 010 587	0 986 437 452	
					10.16→	0 445 010 767		
	d, d xDrive [F 21]	2,0	105	N47 D20C	09.12-02.15	0 445 010 554	0 986 437 425	
120	d [E 81]	2,0	120-130	N47 D20...	05.07-12.11	0 445 010 580	0 986 437 402	
	d [E 87]	2,0	120	20 4D 4 <M 47N>	09.04-03.07	0 445 010 126	0 986 437 323	
			120-130	N47 D20...	03.07-06.11	0 445 010 580	0 986 437 402	
	d, d xDrive [F 20]	2,0	135-147	N47 D20C	09.11-02.15	0 445 010 573	0 986 437 424	
			140-151	B47 D20A	03.15-09.16	0 445 010 587	0 986 437 452	
					10.16→	0 445 010 767		
	d, d xDrive [F 21]	2,0	135-147	N47 D20C	11.12-02.15	0 445 010 573	0 986 437 424	
			140-151	B47 D20A	03.15-09.16	0 445 010 587	0 986 437 452	
					10.16→	0 445 010 767		
123	d [E 81]	2,0	150	N47 D20...	09.07-12.11	0 445 010 581	0 986 437 455	
	d [E 87]	2,0	150	N47 D20...	09.07-06.11	0 445 010 581	0 986 437 455	
125	d [F 20]	2,0	155-160	N47 D20D	03.12-02.15	0 445 010 561	0 986 437 401	
			165	B47 D20B <B47>	03.15-09.16	0 445 010 732		
					10.16→	0 445 010 769		
	d [F 21]	2,0	155-160	N47 D20D	09.12-02.15	0 445 010 561	0 986 437 401	
			165	B47 D20B <B47>	03.15-09.16	0 445 010 732		
					10.16→	0 445 010 769		

**Serie 1 Cabrio**

118	d [E 88]	2,0	100-105	N47 D20...	09.08-10.13	0 445 010 580	0 986 437 402
120	d [E 88]	2,0	120-130	N47 D20...	03.08-10.13	0 445 010 580	0 986 437 402























◀ BMW









123 d [E 88]	2,0	150	N47 D20...	09.08-09.13	0 445 010 581	0 986 437 455
<b>Serie 1 Coupé</b>						
118 d [E 82]	2,0	100-105	N47 D20C	09.09-10.13	0 445 010 580	0 986 437 402
120 d [E 82]	2,0	120-130	N47 D20...	10.07-10.13	0 445 010 580	0 986 437 402
123 d [E 82]	2,0	150	N47 D20...	10.07-09.13	0 445 010 581	0 986 437 455
<b>Serie 2 Active Tourer</b>						
214 d [F 45]	1,5	70	B37 C15A	03.15-09.16	0 445 010 587	0 986 437 452
				10.16→	0 445 010 767	
216 d [F 45]	1,5	85	B37 C15A	11.14-09.16	0 445 010 587	0 986 437 452
				10.16→	0 445 010 767	
			B37 C15A <B37B>	02.18→	0 445 010 776	
218 d [F 45]	2,0	100-110	B47 C20A	09.14-09.16	0 445 010 587	0 986 437 452
				10.16→	0 445 010 767	
d, d xDrive [F 45]	2,0	110	B47 C20B <B47B>	02.18→	0 445 010 776	
220 d, d xDrive [F 45]	2,0	120-140	B47 C20A	11.14-09.16	0 445 010 587	0 986 437 452
				10.16→	0 445 010 767	
		140	B47 C20B <B47D>	02.18→	0 445 010 774	
<b>Serie 2 Cabrio</b>						
218 d [F 23]	2,0	100-110	B47 D20A	07.15-09.16	0 445 010 587	0 986 437 452
				10.16→	0 445 010 767	
220 d [F 23]	2,0	120-155	B47 D20A	11.14-09.16	0 445 010 587	0 986 437 452
				10.16→	0 445 010 767	
225 d [F 23]	2,0	165	B47 D20B <B47>	07.15-09.16	0 445 010 732	
				10.16→	0 445 010 769	
<b>Serie 2 Coupé</b>						
218 d [F 22]	2,0	100-110	B47 D20A	07.15-09.16	0 445 010 587	0 986 437 452
				10.16→	0 445 010 767	
		105	N47 D20C	03.14-06.15	0 445 010 554	0 986 437 425
220 d [F 22]	2,0	120-147	N47 D20C	03.14-10.14	0 445 010 573	0 986 437 424
d, d xDrive [F 22]	2,0	120-155	B47 D20A	11.14-09.16	0 445 010 587	0 986 437 452
				10.16→	0 445 010 767	
225 d [F 22]	2,0	160	N47 D20D	03.14-06.15	0 445 010 561	0 986 437 401
		165	B47 D20B <B47>	07.15-09.16	0 445 010 732	
				10.16→	0 445 010 769	
<b>Serie 2 Grand Tourer</b>						
214 d [F 46]	1,5	70	B37 C15A	07.15-09.16	0 445 010 587	0 986 437 452
				10.16→	0 445 010 767	
215 d [F 46]	1,5	85	B37 C15A	06.15-09.16	0 445 010 587	0 986 437 452
				10.16→	0 445 010 767	
216 d [F 46]	1,5	85	B37 C15A <B37B>	02.18→	0 445 010 776	
218 d, d xDrive [F 46]	2,0	100-110	B47 C20A	06.15-09.16	0 445 010 587	0 986 437 452
				10.16→	0 445 010 767	
		110	B47 C20B <B47B>	02.18→	0 445 010 776	
220 d, d xDrive [F 46]	2,0	120-140	B47 C20A	06.15-09.16	0 445 010 587	0 986 437 452
				10.16→	0 445 010 767	
		140	B47 C20B <B47D>	02.18→	0 445 010 774	
<b>Serie 3</b>						
316 d [E 90]	2,0	85	N47 D20C	09.09-02.10	0 445 010 580	0 986 437 402
				03.10-10.11	0 445 010 554	0 986 437 425
d [F 30]	2,0	85	B47 D20A	03.15-09.16	0 445 010 587	0 986 437 452
				10.16→	0 445 010 767	
			N47 D20C	03.12-02.15	0 445 010 554	0 986 437 425
318 d [E 46]	2,0	85	20 4D 4 <M 47N>	03.03-03.05	0 445 010 126	0 986 437 323
d [E 90]	2,0	90	20 4D 4 <M 47N>	09.05-09.07	0 445 010 126	0 986 437 323
		100-105	N47 D20...	09.07-02.10	0 445 010 580	0 986 437 402
				03.10-10.11	0 445 010 554	0 986 437 425
d, d xDrive [F 30]	2,0	105	N47 D20C	03.12-06.15	0 445 010 554	0 986 437 425
		110	B47 D20A	07.15-09.16	0 445 010 587	0 986 437 452
				10.16→	0 445 010 767	
320 d [E 46]	2,0	110	20 4D 4 <M 47N>	09.01-03.05	0 445 010 126	0 986 437 323
d [E 90]	2,0	110/120	20 4D 4 <M 47N>	03.05-09.07	0 445 010 126	0 986 437 323
d, ded, d xDrive [E 90]	2,0	120-135	N47 D20C <N47N>	03.10-12.11	0 445 010 573	0 986 437 424



									
<b>320 d, d ed, d xDrive [F 30]</b>	2,0	120/135-147	N47 D20C		02.12-03.16			<b>0 445 010 573</b>	<b>0 986 437 424</b>
		120/140	B47 D20A		07.15-09.16			<b>0 445 010 587</b>	<b>0 986 437 452</b>
					10.16→			<b>0 445 010 767</b>	
d, d xDrive [E 90]	2,0	120-130	N47 D20...; N47 D20C		09.07-03.10			<b>0 445 010 580</b>	<b>0 986 437 402</b>
<b>323 d [F 30]</b>	2,0	160	N47 D20D		03.13-02.16			<b>0 445 010 561</b>	<b>0 986 437 401</b>
<b>325 d [E 90]</b>	3,0	145	30 6D 3 <M 57N2>		09.06-02.10			<b>0 445 010 126</b>	<b>0 986 437 323</b>
		150	N57 D30A		03.10-10.11			<b>0 445 010 688</b>	<b>0 986 437 427</b>
D [F 30]	2,0	165	B47 D20B <B47>		03.16-09.16			<b>0 445 010 732</b>	
					10.16→			<b>0 445 010 769</b>	
<b>330 d [F 30]</b>	3,0	190-210	N57 D30A		07.12-10.16			<b>0 445 010 678</b>	<b>0 986 437 429</b>
					11.16→			<b>0 445 010 852</b>	
d, d xDrive [E 90]	3,0	180	N57 D30A		09.08-12.11			<b>0 445 010 688</b>	<b>0 986 437 427</b>
d, xd [E 46]	3,0	135	30 6D 1 <M 57 D 30>		10.99-04.03			<b>0 445 010 009</b>	<b>0 986 437 004</b>
		150	30 6D 2 <M 57N>		03.03-03.05			<b>0 445 010 073</b>	<b>0 986 437 320</b>
d, xd [E 90]	3,0	170	30 6D 3 <M 57N2>		09.05-08.08			<b>0 445 010 126</b>	<b>0 986 437 323</b>
<b>335 d [E 90]</b>	3,0	210	30 6D 5		09.06-10.11			<b>0 445 010 126</b>	<b>0 986 437 323</b>
d xDrive [F 30]	3,0	230	N57 D30B <N57Z>		07.13-10.16			<b>0 445 010 668</b>	<b>0 986 437 453</b>
					11.16→			<b>0 445 010 854</b>	
<b>Serie 3 Cabrio</b>									
<b>320 d [E 46]</b>	2,0	110	20 4D 4 <M 47N>		01.05-08.06			<b>0 445 010 126</b>	<b>0 986 437 323</b>
d [E 93]	2,0	120-135	N47 D20C <N47N>		03.10-10.13			<b>0 445 010 573</b>	<b>0 986 437 424</b>
		130	N47 D20...		03.08-02.10			<b>0 445 010 580</b>	<b>0 986 437 402</b>
<b>325 d [E 93]</b>	3,0	145	30 6D 3 <M 57N2>		09.07-02.10			<b>0 445 010 126</b>	<b>0 986 437 323</b>
		150	N57 D30A		03.10-09.13			<b>0 445 010 688</b>	<b>0 986 437 427</b>
<b>330 d [E 46]</b>	3,0	150	30 6D 2 <M 57N>		04.05-08.06			<b>0 445 010 073</b>	<b>0 986 437 320</b>
d [E 93]	3,0	170	30 6D 3 <M 57N2>		03.07-02.09			<b>0 445 010 126</b>	<b>0 986 437 323</b>
		180	N57 D30A		03.09-09.13			<b>0 445 010 688</b>	<b>0 986 437 427</b>
<b>Serie 3 Compact</b>									
<b>318 td [E 46]</b>	2,0	85	20 4D 4 <M 47N>		03.03-12.04			<b>0 445 010 126</b>	<b>0 986 437 323</b>
<b>320 td [E 46]</b>	2,0	110	20 4D 4 <M 47N>		09.01-12.04			<b>0 445 010 126</b>	<b>0 986 437 323</b>
<b>Serie 3 Coupé</b>									
<b>320 d [E 46]</b>	2,0	110	20 4D 4 <M 47N>		09.03-05.06			<b>0 445 010 126</b>	<b>0 986 437 323</b>
d, d xDrive [E 92]	2,0	120-135	N47 D20C <N47N>		03.10-06.13			<b>0 445 010 573</b>	<b>0 986 437 424</b>
		130	N47 D20...; N47 D20C		03.07-02.10			<b>0 445 010 580</b>	<b>0 986 437 402</b>
<b>325 d [E 92]</b>	3,0	145	30 6D 3 <M 57N2>		03.07-02.10			<b>0 445 010 126</b>	<b>0 986 437 323</b>
		150	N57 D30A		03.10-06.13			<b>0 445 010 688</b>	<b>0 986 437 427</b>
<b>330 d [E 46]</b>	3,0	150	30 6D 2 <M 57N>		03.03-05.06			<b>0 445 010 073</b>	<b>0 986 437 320</b>
d, d xDrive [E 92]	3,0	180	N57 D30A		09.08-06.13			<b>0 445 010 688</b>	<b>0 986 437 427</b>
d, xd [E 92]	3,0	170	30 6D 3 <M 57N2>		09.06-08.08			<b>0 445 010 126</b>	<b>0 986 437 323</b>
<b>335 d [E 92]</b>	3,0	210	30 6D 5		09.06-03.13			<b>0 445 010 126</b>	<b>0 986 437 323</b>
<b>Serie 3 GT</b>									
<b>318 d [F 34]</b>	2,0	105	N47 D20C		06.13-06.15			<b>0 445 010 554</b>	<b>0 986 437 425</b>
		110	B47 D20A		07.15-09.16			<b>0 445 010 587</b>	<b>0 986 437 452</b>
					10.16→			<b>0 445 010 767</b>	
<b>320 d [F 34]</b>	2,0	120-135	N47 D20C		06.13-06.15			<b>0 445 010 573</b>	<b>0 986 437 424</b>
d, d xDrive [F 34]	2,0	120-140	B47 D20A		07.15-09.16			<b>0 445 010 587</b>	<b>0 986 437 452</b>
					10.16→			<b>0 445 010 767</b>	
d xDrive [F 34]	2,0	120-135	N47 D20C		07.13-06.15			<b>0 445 010 554</b>	<b>0 986 437 425</b>
<b>325 d [F 34]</b>	2,0	160	N47 D20D		07.13-06.16			<b>0 445 010 561</b>	<b>0 986 437 401</b>
		165	B47 D20B <B47>		07.16-09.16			<b>0 445 010 732</b>	
					10.16→			<b>0 445 010 769</b>	
<b>330 d, d xDrive [F 34]</b>	3,0	190-210	N57 D30A <N57>		03.14-10.16			<b>0 445 010 678</b>	<b>0 986 437 429</b>
					11.16→			<b>0 445 010 852</b>	
<b>335 d xDrive [F 34]</b>	3,0	230	N57 D30B		03.14-10.16			<b>0 445 010 668</b>	<b>0 986 437 453</b>
					11.16→			<b>0 445 010 854</b>	
<b>Serie 3 Touring</b>									
<b>316 d [E 91]</b>	2,0	85	N47 D20C <N47N>		03.10-05.12			<b>0 445 010 554</b>	<b>0 986 437 425</b>
d [F 31]	2,0	85	B47 D20A		03.15-09.16			<b>0 445 010 587</b>	<b>0 986 437 452</b>
					10.16→			<b>0 445 010 767</b>	
			N47 D20C		11.12-02.15			<b>0 445 010 554</b>	<b>0 986 437 425</b>
<b>318 d [E 46]</b>	2,0	85	20 4D 4 <M 47N>		03.03-09.05			<b>0 445 010 126</b>	<b>0 986 437 323</b>
d [E 91]	2,0	90	20 4D 4 <M 47N>		03.06-09.07			<b>0 445 010 126</b>	<b>0 986 437 323</b>



									
<b>◀ BMW</b>									
<b>318 d [E 91]</b>	2,0	100-105	N47 D20...		09.07-02.10			<b>0 445 010 580</b>	<b>0 986 437 402</b>
					03.10-05.12			<b>0 445 010 554</b>	<b>0 986 437 425</b>
d, d xDrive [F 31]	2,0	105	N47 D20C		11.12-06.15			<b>0 445 010 554</b>	<b>0 986 437 425</b>
		110	B47 D20A		07.15-09.16			<b>0 445 010 587</b>	<b>0 986 437 452</b>
					10.16→			<b>0 445 010 767</b>	
<b>320 d [E 46]</b>	2,0	110	20 4D 4 <M 47N>		09.01-09.05			<b>0 445 010 126</b>	<b>0 986 437 323</b>
d [E 91]	2,0	110/120	20 4D 4 <M 47N>		09.05-08.07			<b>0 445 010 126</b>	<b>0 986 437 323</b>
d, d ed, d xDrive [E 91]	2,0	120-135	N47 D20C <N47N>		03.10-05.12			<b>0 445 010 573</b>	<b>0 986 437 424</b>
d, d ed, d xDrive [F 31]	2,0	120/135-	N47 D20C		09.12-02.16			<b>0 445 010 573</b>	<b>0 986 437 424</b>
		147							
		120/140	B47 D20A		07.15-09.16			<b>0 445 010 587</b>	<b>0 986 437 452</b>
					10.16→			<b>0 445 010 767</b>	
d, d xDrive [E 91]	2,0	120-130	N47 D20...; N47 D20C		09.07-02.10			<b>0 445 010 580</b>	<b>0 986 437 402</b>
<b>325 d [E 91]</b>	3,0	145	30 6D 3 <M 57N2>		09.06-02.10			<b>0 445 010 126</b>	<b>0 986 437 323</b>
		150	N57 D30A		03.10-05.12			<b>0 445 010 688</b>	<b>0 986 437 427</b>
d [F 31]	2,0	160	N47 D20D		03.13-02.16			<b>0 445 010 561</b>	<b>0 986 437 401</b>
		165	B47 D20B <B47>		03.16-09.16			<b>0 445 010 732</b>	
					10.16→			<b>0 445 010 769</b>	
<b>330 d, d xDrive [E 91]</b>	3,0	180	N57 D30A		09.08-05.12			<b>0 445 010 688</b>	<b>0 986 437 427</b>
d, d xDrive [F 31]	3,0	190-210	N57 D30A		09.12-10.16			<b>0 445 010 678</b>	<b>0 986 437 429</b>
					11.16→			<b>0 445 010 852</b>	
d, xd [E 46]	3,0	135	30 6D 1 <M 57 D 30>		10.99-03.03			<b>0 445 010 009</b>	<b>0 986 437 004</b>
		150	30 6D 2 <M 57N>		03.03-09.05			<b>0 445 010 073</b>	<b>0 986 437 320</b>
d, xd [E 91]	3,0	170	30 6D 3 <M 57N2>		09.05-08.08			<b>0 445 010 126</b>	<b>0 986 437 323</b>
<b>335 d [E 91]</b>	3,0	210	30 6D 5		09.06-05.12			<b>0 445 010 126</b>	<b>0 986 437 323</b>
d xDrive [F 31]	3,0	230	N57 D30B		11.13-10.16			<b>0 445 010 668</b>	<b>0 986 437 453</b>
					11.16→			<b>0 445 010 854</b>	
<b>Serie 4 Cabrio</b>									
<b>420 d [F 33]</b>	2,0	120-135	N47 D20C		03.14-06.15			<b>0 445 010 573</b>	<b>0 986 437 424</b>
		120-140	B47 D20A		07.15-09.16			<b>0 445 010 587</b>	<b>0 986 437 452</b>
					10.16→			<b>0 445 010 767</b>	
<b>425 d [F 33]</b>	2,0	160	N47 D20D		06.14-02.16			<b>0 445 010 561</b>	<b>0 986 437 401</b>
		165	B47 D20B <B47>		03.16-09.16			<b>0 445 010 732</b>	
					10.16→			<b>0 445 010 769</b>	
<b>430 d [F 33]</b>	3,0	190-210	N57 D30A		06.14-10.16			<b>0 445 010 678</b>	<b>0 986 437 429</b>
					11.16→			<b>0 445 010 852</b>	
<b>435 d [F 33]</b>	3,0	230	N57 D30B		06.14-10.16			<b>0 445 010 668</b>	<b>0 986 437 453</b>
					11.16→			<b>0 445 010 854</b>	
<b>Serie 4 Coupé</b>									
<b>418 d [F 32]</b>	2,0	100-110	B47 D20A		03.15-09.16			<b>0 445 010 587</b>	<b>0 986 437 452</b>
					10.16→			<b>0 445 010 767</b>	
<b>420 d [F 32]</b>	2,0	120-140	B47 D20A		03.15-09.16			<b>0 445 010 587</b>	<b>0 986 437 452</b>
					10.16→			<b>0 445 010 767</b>	
d, d xDrive [F 32]	2,0	120-135	N47 D20C		09.13-02.15			<b>0 445 010 573</b>	<b>0 986 437 424</b>
<b>425 d [F 32]</b>	2,0	160	N47 D20D		03.14-02.16			<b>0 445 010 561</b>	<b>0 986 437 401</b>
		165	B47 D20B <B47>		03.16-09.16			<b>0 445 010 732</b>	
					10.16→			<b>0 445 010 769</b>	
<b>430 d [F 32]</b>	3,0	190-210	N57 D30A		11.13-10.16			<b>0 445 010 678</b>	<b>0 986 437 429</b>
					11.16→			<b>0 445 010 852</b>	
d xDrive [F 32]	3,0	190-210	N57 D30A <N57>		03.14-10.16			<b>0 445 010 678</b>	<b>0 986 437 429</b>
					11.16→			<b>0 445 010 852</b>	
<b>435 d xDrive [F 32]</b>	3,0	230	N57 D30B <N57Z>		11.13-10.16			<b>0 445 010 668</b>	<b>0 986 437 453</b>
					11.16→			<b>0 445 010 854</b>	
<b>Serie 4 GC</b>									
<b>418 d [F 36]</b>	2,0	100-105	N47 D20C		05.14-06.15			<b>0 445 010 554</b>	<b>0 986 437 425</b>
		100-110	B47 D20A		07.15-09.16			<b>0 445 010 587</b>	<b>0 986 437 452</b>
					10.16→			<b>0 445 010 767</b>	
<b>420 d, d xDrive [F 36]</b>	2,0	120-135	N47 D20C		05.14-03.15			<b>0 445 010 573</b>	<b>0 986 437 424</b>
		120-140	B47 D20A		03.15-09.16			<b>0 445 010 587</b>	<b>0 986 437 452</b>
					10.16→			<b>0 445 010 767</b>	
<b>425 d [F 36]</b>	2,0	165	B47 D20B <B47>		03.16-09.16			<b>0 445 010 732</b>	
					10.16→			<b>0 445 010 769</b>	

									
<b>430 d</b> [F 36]	3,0	190-210	N57 D30A		06.14-10.16		<b>0 445 010 678</b>	<b>0 986 437 429</b>	
					11.16→		<b>0 445 010 852</b>		
d xDrive [E 36]	3,0	190-210	N57 D30A		06.14-10.16		<b>0 445 010 678</b>	<b>0 986 437 429</b>	
					11.16→		<b>0 445 010 852</b>		
<b>435 d xDrive</b> [F 36]	3,0	230	N57 D30B		06.14-10.16		<b>0 445 010 668</b>	<b>0 986 437 453</b>	
					11.16→		<b>0 445 010 854</b>		
<b>Serie 5</b>									
<b>518 d</b> [F 10]	2,0	100-105	N47 D20C <N47N>		07.13-06.14		<b>0 445 010 573</b>	<b>0 986 437 424</b>	
		100-110	B47 D20A		06.14-09.16		<b>0 445 010 587</b>	<b>0 986 437 452</b>	
					10.16-10.16		<b>0 445 010 767</b>		
d [G 30]	2,0	140	B47 D20B <B47D>		06.18→		<b>0 445 010 776</b>		
<b>520 d</b> [E 60]	2,0	110/120	20 4D 4 <M 47N>		09.05-02.08		<b>0 445 010 126</b>	<b>0 986 437 323</b>	
		120-130	N47 D20...		09.07-02.10		<b>0 445 010 582</b>	<b>0 986 437 406</b>	
d, d ed, d xDrive [F 10]	2,0	135	N47 D20C <N47N>		05.10-10.16		<b>0 445 010 573</b>	<b>0 986 437 424</b>	
d, d ed, d xDrive [G 30]	2,0	140	B47 D20A		02.17→		<b>0 445 010 767</b>		
d, d xDrive [F 10]	2,0	120-155	B47 D20A		06.14-09.16		<b>0 445 010 587</b>	<b>0 986 437 452</b>	
					10.16-10.16		<b>0 445 010 767</b>		
d, d xDrive [G 30]	2,0	140	B47 D20B <B47D>		06.18→		<b>0 445 010 774</b>		
<b>525 d</b> [E 39]	2,5	120	25 6D 1		04.00-07.03		<b>0 445 010 009</b>	<b>0 986 437 004</b>	
d [E 60]	2,5	120/130	25 6D 2		05.04-03.07		<b>0 445 010 073</b>	<b>0 986 437 320</b>	
d [F 10]	3,0	150	N57 D30A		03.10-08.11		<b>0 445 010 688</b>	<b>0 986 437 427</b>	
d [G 30]	2,0	170	B47 D20B <B47>		06.17→		<b>0 445 010 769</b>		
d, d xDrive [F 10]	2,0	160	N47 D20D <N47S1>		09.11-10.16		<b>0 445 010 561</b>	<b>0 986 437 401</b>	
d, d xDrive, xd [E 60]	3,0	145	30 6D 3 <M 57N2>		03.07-02.10		<b>0 445 010 126</b>	<b>0 986 437 323</b>	
<b>530 d</b> [E 39]	3,0	135-142	30 6D 1 <M 57 D 30>		08.98-07.03		<b>0 445 010 009</b>	<b>0 986 437 004</b>	
d [E 60]	3,0	155-160	30 6D 2 <M 57N>		07.03-09.05		<b>0 445 010 073</b>	<b>0 986 437 320</b>	
d [F 10]	3,0	180	N57 D30A <N57>		03.10-08.11		<b>0 445 010 688</b>	<b>0 986 437 427</b>	
d, d xDrive [F 10]	3,0	190-210	N57 D30A		03.11-10.16		<b>0 445 010 678</b>	<b>0 986 437 429</b>	
d, d xDrive [G 30]	3,0	195	B57 D30A		02.17→		<b>0 445 010 840</b>		
d, d xDrive, xd [E 60]	3,0	170/173	30 6D 3 <M 57N2>		09.05-02.10		<b>0 445 010 126</b>	<b>0 986 437 323</b>	
<b>535 d</b> [E 60]	3,0	200	30 6D 4		09.04-03.07		<b>0 445 010 073</b>	<b>0 986 437 320</b>	
		210	30 6D 5		03.07-02.10		<b>0 445 010 126</b>	<b>0 986 437 323</b>	
d [F 10]	3,0	220	N57 D30B <N57S>		09.10-08.11		<b>0 445 010 665</b>	<b>0 986 437 428</b>	
d, d xDrive [F 10]	3,0	230	N57 D30B <N57Z>		09.11-10.16		<b>0 445 010 668</b>	<b>0 986 437 453</b>	
<b>540 d xDrive</b> [G 30]	3,0	235	B57 D30B		06.17→		<b>0 445 010 840</b>		
<b>Serie 5 GT</b>									
<b>520 d</b> [F 07]	2,0	120-135	N47 D20C		07.12-11.16		<b>0 445 010 573</b>	<b>0 986 437 424</b>	
					12.16-02.17		<b>0 445 010 794</b>		
<b>530 d</b> [F 07]	3,0	155	N57 D30A		09.10-06.12		<b>0 445 010 688</b>	<b>0 986 437 427</b>	
d, d xDrive [F 07]	3,0	180	N57 D30A <N57>		10.09-06.12		<b>0 445 010 688</b>	<b>0 986 437 427</b>	
		190	N57 D30A		07.12-10.16		<b>0 445 010 678</b>	<b>0 986 437 429</b>	
					11.16-02.17		<b>0 445 010 852</b>		
<b>535 d, d xDrive</b> [F 07]	3,0	220	N57 D30B <N57S>		03.10-06.12		<b>0 445 010 665</b>	<b>0 986 437 428</b>	
		230	N57 D30B <N57Z>		07.12-10.16		<b>0 445 010 668</b>	<b>0 986 437 453</b>	
					11.16-02.17		<b>0 445 010 854</b>		
<b>Serie 5 Touring</b>									
<b>M 550 d xDrive</b> [G 31]	3,0	294	B57 D30C		11.17→		<b>0 445 010 856</b>		
<b>518 d</b> [F 11]	2,0	100-105	N47 D20C <N47N>		07.13-06.14		<b>0 445 010 573</b>	<b>0 986 437 424</b>	
		100-110	B47 D20A		06.14-09.16		<b>0 445 010 587</b>	<b>0 986 437 452</b>	
					10.16-02.17		<b>0 445 010 767</b>		
d [G 31]	2,0	140	B47 D20B <B47D>		06.18→		<b>0 445 010 776</b>		
<b>520 d</b> [E 61]	2,0	110/120	20 4D 4 <M 47N>		09.05-02.08		<b>0 445 010 126</b>	<b>0 986 437 323</b>	
		120-130	N47 D20...		09.07-08.10		<b>0 445 010 582</b>	<b>0 986 437 406</b>	
d, d xDrive [F 11]	2,0	120-140	B47 D20A		06.14-09.16		<b>0 445 010 587</b>	<b>0 986 437 452</b>	
					10.16-02.17		<b>0 445 010 767</b>		
		135	N47 D20C <N47N>		09.10-10.16		<b>0 445 010 573</b>	<b>0 986 437 424</b>	
d, d xDrive [G 31]	2,0	140	B47 D20A		06.17→		<b>0 445 010 767</b>		
			B47 D20B <B47D>		06.18→		<b>0 445 010 774</b>		
<b>525 d</b> [E 39]	2,5	120	25 6D 1		04.00-05.04		<b>0 445 010 009</b>	<b>0 986 437 004</b>	
d [E 61]	2,5	120/130	25 6D 2		05.04-03.07		<b>0 445 010 073</b>	<b>0 986 437 320</b>	
d [F 11]	3,0	150	N57 D30A		09.10-08.11		<b>0 445 010 688</b>	<b>0 986 437 427</b>	
d, d xDrive [F 11]	2,0	155-160	N47 D20D <N47S1>		09.11-11.16		<b>0 445 010 561</b>	<b>0 986 437 401</b>	
					12.16-02.17		<b>0 445 010 784</b>		







◀ BMW

525 d, d xDrive, xd [E 61]	3,0	145	30 6D 3 <M 57N2>	03.07-08.10	0 445 010 126	0 986 437 323
528 d [G 31]	2,0	170	B47 D20B <B47>	06.17→	0 445 010 769	
530 d [E 39]	3,0	135-142	30 6D 1 <M 57 D 30>	08.98-05.04	0 445 010 009	0 986 437 004
d [E 61]	3,0	160	30 6D 2 <M 57N>	05.04-09.05	0 445 010 073	0 986 437 320
d [F 11]	3,0	180	N57 D30A <N57>	09.10-08.11	0 445 010 688	0 986 437 427
d, d xDrive [F 11]	3,0	190-210	N57 D30A	03.11-10.16	0 445 010 678	0 986 437 429
				11.16-02.17	0 445 010 852	
d, d xDrive [G 31]	3,0	195	B57 D30A	06.17→	0 445 010 840	
d, d xDrive, xd [E 61]	3,0	155-170/ 173	30 6D 3 <M 57N2>	09.05-08.10	0 445 010 126	0 986 437 323
535 d [E 61]	3,0	200	30 6D 4	09.04-03.07	0 445 010 073	0 986 437 320
		210	30 6D 5	03.07-08.10	0 445 010 126	0 986 437 323
d [F 11]	3,0	220	N57 D30B <N57S>	09.10-08.11	0 445 010 665	0 986 437 428
d, d xDrive [F 11]	3,0	230	N57 D30B <N57Z>	09.11-10.16	0 445 010 668	0 986 437 453
				11.16-02.17	0 445 010 854	
540 d [G 31]	3,0	235	B57 D30B	06.17→	0 445 010 840	
<b>Serie 6</b>						
635 d [E 63]	3,0	210	30 6D 5	09.07-07.10	0 445 010 126	0 986 437 323
<b>Serie 6 Cabrio</b>						
635 d [E 64]	3,0	210	30 6D 5	09.07-07.10	0 445 010 126	0 986 437 323
640 d, d xDrive [F 12]	3,0	230	N57 D30B <N57Z>	09.11-10.16	0 445 010 668	0 986 437 453
				11.16→	0 445 010 854	
<b>Serie 6 Coupé</b>						
640 d, d xDrive [F 13]	3,0	230	N57 D30B <N57Z>	10.11-10.16	0 445 010 668	0 986 437 453
				11.16→	0 445 010 854	
<b>Serie 6 GC</b>						
640 d, d xDrive [F 06]	3,0	230	N57 D30B <N57Z>	05.12-10.16	0 445 010 668	0 986 437 453
				11.16→	0 445 010 854	
<b>Serie 6 GT</b>						
620 d, d xDrive [G 32]	2,0	140	B47 D20B <B47D>	06.18→	0 445 010 774	
630 d xDrive [G 32]	3,0	195	B57 D30A	10.17→	0 445 010 840	
640 d xDrive [G 32]	3,0	235	B57 D30B	10.17→	0 445 010 840	
<b>Serie 7</b>						
725 d [G 11]	2,0	170	B47 D20B <B47>	06.17→	0 445 010 769	
Ld [G 12]	2,0	170	B47 D20B <B47>	06.17→	0 445 010 769	
730 d [E 38]	3,0	135-142	30 6D 1 <M 57 D 30>	08.98-12.01	0 445 010 009	0 986 437 004
d [E 65]	3,0	160	30 6D 2 <M 57N>	10.02-03.05	0 445 010 073	0 986 437 320
		170	30 6D 3 <M 57N2>	04.05-10.08	0 445 010 126	0 986 437 323
d [F 01]	3,0	155-180	N57 D30A	11.08-06.12	0 445 010 688	0 986 437 427
d, d xDrive [F 01]	3,0	155-190	N57 D30A	07.12-05.15	0 445 010 678	0 986 437 429
d, d xDrive [G 11]	3,0	155-195	B57 D30A	09.15→	0 445 010 840	
Ld [E 66]	3,0	170	30 6D 3 <M 57N2>	09.05-10.08	0 445 010 126	0 986 437 323
Ld [F 02]	3,0	180	N57 D30A	03.09-06.12	0 445 010 688	0 986 437 427
		180-190	N57 D30A	07.12-05.15	0 445 010 678	0 986 437 429
Ld, Ld xDrive [G 12]	3,0	155-195	B57 D30A	09.15→	0 445 010 840	
740 d [E 38]	3,9	180	39 8D 1 <M 67>	10.98-12.01	0 445 010 012	0 986 437 313
d [E 65]	3,9	190	39 8D 1 <M 67>	10.02-03.05	0 445 010 074	0 986 437 314
d, d xDrive [F 01]	3,0	225	N57 D30B <N57Z>	09.09-06.12	0 445 010 665	0 986 437 428
		230	N57 D30B <N57Z>	07.12-05.15	0 445 010 668	0 986 437 453
d xDrive [G 11]	3,0	235	B57 D30B	11.15→	0 445 010 840	
Ld xDrive [G 12]	3,0	235	B57 D30B	11.15→	0 445 010 840	
745 d [E 65]	4,4	220/242	44 8D 1	03.05-10.08	0 445 010 108	0 986 437 315
750 d xDrive [F 01]	3,0	280	N57 D30C	07.12-05.15	0 445 010 672	0 986 437 458
d xDrive [G 11]	3,0	294	B57 D30C	07.16-09.16	0 445 010 828	
				10.16→	0 445 010 856	
Ld xDrive [F 02]	3,0	280	N57 D30C	07.12-05.15	0 445 010 672	0 986 437 458
Ld xDrive [G 12]	3,0	294	B57 D30C	07.16-09.16	0 445 010 828	
				10.16→	0 445 010 856	





**CADILLAC**

**BLS**

1.9	1,9	110	Z 19 DTH				
			Mot.-Nr. →17126571	10.05-08.09	LLE	0 445 010 097	0 986 437 025
			Mot.-Nr. 17129340→	10.05-08.09	RLE	0 445 010 287	0 986 437 026
			Mot.-Nr. 171126572→	10.05-08.09	LLE	0 445 010 288	0 986 437 025

**CHEVROLET**

**Aveo**

1.3 D [T300]	1,2	55	A 13 DTC <LDV>	09.11-12.17	EU4	0 445 010 293	0 986 437 036
					EU5	0 445 010 381	0 986 437 072
		70	A 13 DT... <LSF>	09.11-12.17	EU4	0 445 010 293	0 986 437 036
					EU5	0 445 010 381	0 986 437 072

**Aveo Hatchback**

1.3 D [T300]	1,2	55	A 13 DTC <LDV>	09.11-12.17	EU4	0 445 010 293	0 986 437 036
					EU5	0 445 010 381	0 986 437 072
		70	A 13 DT... <LSF>	09.11-12.17	EU4	0 445 010 293	0 986 437 036
					EU5	0 445 010 381	0 986 437 072

**Blazer**

2.8 D Electronic	2,8	103	4.07 TCE <Sprint Euro 3>	08.05-05.09		0 445 010 115	
------------------	-----	-----	--------------------------	-------------	--	---------------	--

**Captiva**

2.0 CDRI, CDRI 4x4 [C100]	2,0	93/110	Z20S				
			Fg.-Nr. →169709	10.06-12.08		0 445 010 142	0 986 437 032
			Fg.-Nr. 169710→	01.08-02.11		0 445 010 332	

**Cruze**

2.0 CDI [J300]	2,0	110	Z20S1	05.09-12.11		0 445 010 332	
----------------	-----	-----	-------	-------------	--	---------------	--

**Epica**

2.0 CDRI [V250]	2,0	110	Z20S				
			Fg.-Nr. →090446	09.06-12.11		0 445 010 142	0 986 437 032
			Fg.-Nr. 090447→	09.06-12.11		0 445 010 332	

**Lacetti**

2.0 D [J200]	2,0	89	Z20S				
			Fg.-Nr. →092448	09.06-04.13		0 445 010 142	0 986 437 032
			Fg.-Nr. 092449→	09.06-04.13		0 445 010 332	

**Malibu**

2.0 CDRI [V300]	2,0	118	LBS <Euro 5>	06.12-12.12		0 445 010 441	0 986 437 047
				01.13-12.15	AG,TW	0 445 010 387	
						0 445 010 441	0 986 437 047
					GS	0 445 010 443	0 986 437 027

**Nubira**

2.0 D [J200]	2,0	89	Z20S				
			Fg.-Nr. →092448	09.06-04.13		0 445 010 142	0 986 437 032
			Fg.-Nr. 092449→	09.06-04.13		0 445 010 332	

**Nubira Wagon**

2.0 D [J200]	2,0	89	Z20S				
			Fg.-Nr. →092448	09.06-04.13		0 445 010 142	0 986 437 032
			Fg.-Nr. 092449→	09.06-04.13		0 445 010 332	

**CHRYSLER**

**Grand Voyager**

2.8 [RS]	2,8	120	ENS	09.08→		0 445 010 152	
----------	-----	-----	-----	--------	--	---------------	--

**PT Cruiser**

2.2 CRD [PT]	2,2	89/110	EDJ	09.02-12.06		0 445 010 270	0 986 437 102
--------------	-----	--------	-----	-------------	--	---------------	---------------

**Voyager**

2.8 CRD [RT]	2,8	120	ENS	09.08→		0 445 010 152	
--------------	-----	-----	-----	--------	--	---------------	--





**CITROEN**

<b>Berlingo</b>							
1.6 BlueHDi [B9]	1,6	55/73/88	BHW <DV6FE>; BHY <DV6FD>; BHZ <DV6FC>	12.14→		<b>0 445 010 738</b>	<b>0 986 437 445</b>
Hdi [B9]	1,6	55/66/68	9HF <DV6DTEd>; 9HJ <DV6DTEd M>; 9HK <DV6ETED M>; 9HN <DV6ETED4>; 9HP <DV6DTEd>	07.10-12.16		<b>0 445 010 552</b>	<b>0 986 437 430</b>
		55-66/80	9HS <DV6TEd4BU/FAP>; 9HT <DV6B/DV6BUTED4>; 9HV <DV6TEd4/FAP>; 9HX <DV6ATED4/DV6AUTED4>; 9HZ <DV6TEd4>	05.08-11.11		<b>0 445 010 296</b>	<b>0 986 437 028</b>
Hdi [M59]	1,6	55/66	9HW <DV6B>; 9HX <DV6ATED4>	07.05-10.11		<b>0 445 010 296</b>	<b>0 986 437 028</b>
<b>2.0 HDi [M49]</b>							
Hdi	2,0	66	RHY <DW10TD> Org.-Nr. →8994 Org.-Nr. 8995→	12.99-06.01 BO 07.01-11.02 BO		<b>0 445 010 010</b>	<b>0 986 437 005</b>
Hdi	2,0	66	DW10TD	10.00→		<b>0 445 010 010</b>	<b>0 986 437 005</b>
<b>C-Crosser</b>							
2.2 HDi 4x4 [I4]	2,2	115	4HK <DW12ME5>; 4HN <DW12METED4/FAP>	09.07-01.13		<b>0 445 010 367</b>	<b>0 986 437 034</b>
<b>C-Elysee</b>							
1.5 Blue HDi	1,5	75	YHY <DV5RD>	04.18→		<b>0 445 010 760</b>	
1.6 BlueHDi	1,6	73	BHY <DV6FD>	04.15→		<b>0 445 010 738</b>	<b>0 986 437 445</b>
Hdi	1,6	68	9HJ <DV6DTEd M>; 9HP <DV6DTEd>	09.12→		<b>0 445 010 552</b>	<b>0 986 437 430</b>
<b>C2</b>							
1.4 HDi [A6]	1,4	50	8H... <DV4TD>	09.03-12.09 BO		<b>0 445 010 296</b>	<b>0 986 437 028</b>
1.6 HDi [A6]	1,6	80	9HZ <DV6TEd4>	07.07-05.09		<b>0 445 010 296</b>	<b>0 986 437 028</b>
<b>C3</b>							
1.4 Hdi	1,4	52	8HW <DV4TD>	07.03-07.12 BO		<b>0 445 010 296</b>	<b>0 986 437 028</b>
Hdi [A31]	1,4	50	8HZ <DV4TD>	09.05-09.09 BO		<b>0 445 010 296</b>	<b>0 986 437 028</b>
Hdi [A51]	1,4	50	8H... <DV4C> 8HZ <DV4TD>	06.10-12.15 09.09-12.15		<b>0 445 010 552</b>	<b>0 986 437 430</b>
						<b>0 445 010 296</b>	<b>0 986 437 028</b>
1.5 Blue HDi [B618]	1,5	75	YHY <DV5RD>	04.18→		<b>0 445 010 760</b>	
1.6 BlueHDi [A51]	1,6	55/73	BHW <DV6FE>; BHY <DV6FD>	04.14-12.16		<b>0 445 010 738</b>	<b>0 986 437 445</b>
BlueHDi [B618]	1,6	55/73	BHW <DV6FE>; BHY <DV6FD>	07.16→		<b>0 445 010 738</b>	<b>0 986 437 445</b>
Hdi [A31]	1,6	66/80	9HX <DV6ATED4>; 9HZ <DV6TEd4>	09.05-12.09		<b>0 445 010 296</b>	<b>0 986 437 028</b>
Hdi [A51]	1,6	55/68	9HJ <DV6DTEd M>; 9HK <DV6ETED M>; 9HP <DV6DTEd>	01.10-12.15		<b>0 445 010 552</b>	<b>0 986 437 430</b>
		66	9HX <DV6ATED4>	09.09-12.14		<b>0 445 010 296</b>	<b>0 986 437 028</b>
Hdi [B618]	1,6	66	9HJ <DV6DTEd M>	09.16→		<b>0 445 010 552</b>	<b>0 986 437 430</b>
<b>C3 Aircross</b>							
1.6 BlueHDi [A88]	1,6	73/85/88	BHX <DV6FC>; BHY <DV6FD>; BHZ <DV6FC>	06.17→		<b>0 445 010 738</b>	<b>0 986 437 445</b>
Hdi [A88]	1,6	68	9HP <DV6DTEd>	10.17→		<b>0 445 010 552</b>	<b>0 986 437 430</b>
<b>C3 Picasso</b>							
1.6 BlueHDi [A58]	1,6	73	BHY <DV6FD>	01.15→		<b>0 445 010 738</b>	<b>0 986 437 445</b>
Hdi [A58]	1,6	66/80	9HX <DV6ATED4>; 9HZ <DV6TEd4 FAP>	02.09-12.11		<b>0 445 010 296</b>	<b>0 986 437 028</b>
		68	9HP <DV6DTEd>	03.10→		<b>0 445 010 552</b>	<b>0 986 437 430</b>
<b>C3-Pluriel</b>							
1.4 HDi [A42]	1,4	50	8H... <DV4TD>	10.03-01.10 BO		<b>0 445 010 296</b>	<b>0 986 437 028</b>
<b>C4</b>							
1.6 BlueHDi [B71]	1,6	73/85/88	BHX <DV6FC>; BHY <DV6FD>; BHZ <DV6FC>	04.14→		<b>0 445 010 738</b>	<b>0 986 437 445</b>
Hdi [B5]	1,6	66/80	9H... <DV6TEd4>; 9HV <DV6TEd4/FAP>; 9HX <DV6ATED4>; 9HZ <DV6TEd4 FAP>	11.04-12.10		<b>0 445 010 296</b>	<b>0 986 437 028</b>
Hdi [B71]	1,6	68	9HJ <DV6DTEd M>; 9HP <DV6DTEd>	09.10→		<b>0 445 010 552</b>	<b>0 986 437 430</b>
2.0 HDi [B5]	2,0	80	RHZ <DW10ATED>	07.06-12.10		<b>0 445 010 046</b>	<b>0 986 437 017</b>
<b>C4 Cactus</b>							
1.5 Blue HDi [E3]	1,5	75	YHY <DV5RD>	04.18→		<b>0 445 010 760</b>	
1.6 Blue HDi [E3]	1,6	73	BHY <DV6FD>	02.14→		<b>0 445 010 738</b>	<b>0 986 437 445</b>
Hdi [E3]	1,6	68	9HP <DV6DTEd>	02.14→		<b>0 445 010 552</b>	<b>0 986 437 430</b>
<b>C4 Coupé</b>							
1.6 HDi [B5]	1,6	66/80	9H... <DV6TEd4>; 9HV <DV6TEd4/FAP>; 9HX <DV6ATED4>	11.04-07.10		<b>0 445 010 296</b>	<b>0 986 437 028</b>
<b>C4 Grand Picasso</b>							
1.6 BlueHDi [B78]	1,6	73/85/88	BHX <DV6FC>; BHY <DV6FD>; BHZ <DV6FC>	04.14→		<b>0 445 010 738</b>	<b>0 986 437 445</b>
Hdi [B58]	1,6	80	9H... <DV6TEd4>	10.06-12.11		<b>0 445 010 296</b>	<b>0 986 437 028</b>





1.6 HDi [B78]	1,6	68	9HP <DV6DTE4>	07.13→	0 445 010 552	0 986 437 430
<b>C4 Picasso</b>						
1.6 BlueHDi [B78]	1,6	73/85/88	BHX <DV6FC>; BHY <DV6FD>; BHZ <DV6FC>	04.14→	0 445 010 738	0 986 437 445
HDi [B58]	1,6	80	9H... <DV6TED4>	02.07-12.11	0 445 010 296	0 986 437 028
HDi [B78]	1,6	68	9HP <DV6DTE4>	02.13→	0 445 010 552	0 986 437 430
<b>C4 Spacetourer</b>						
1.6 BlueHDi [B78]	1,6	73/85/88	BHX <DV6FC>; BHY <DV6FD>; BHZ <DV6FC>	04.18→	0 445 010 738	0 986 437 445
<b>C5</b>						
1.6 HDi [X3]	1,6	80	9H... <DV6TED4>	10.04-03.08	0 445 010 296	0 986 437 028
HDi [X7]	1,6	80	9HZ <DV6TED4>	04.08-07.10	0 445 010 296	0 986 437 028
2.0 HDi [X4]	2,0	66	RHY <DW10TD>			
			Org.-Nr. →8945	03.01-05.01 BO	0 445 010 010	0 986 437 005
			Org.-Nr. 8946→	06.01-09.04 BO	0 445 010 046	0 986 437 017
		79	RHS <DW10ATED/FAP>			
			Org.-Nr. →8945	03.01-05.01	0 445 010 010	0 986 437 005
			Org.-Nr. 8946→	06.01-09.04	0 445 010 046	0 986 437 017
		80	RHZ <DW10ATED>			
			Org.-Nr. →8945	03.01-05.01	0 445 010 010	0 986 437 005
			Org.-Nr. 8946→	06.01-09.04	0 445 010 046	0 986 437 017
2.2 HDi [X3]	2,2	98	4HX <DW12TED4>	10.04-09.05	0 445 010 021	0 986 437 012
		120-125	4H... <DW12BTED4>	03.06-03.08	0 445 010 367	0 986 437 034
HDi [X4]	2,2	98	4HX <DW12TED4>	03.01-09.04	0 445 010 021	0 986 437 012
HDi [X7]	2,2	120-125	4H... <DW12BTED4>	04.08-09.09	0 445 010 367	0 986 437 034
		150	4HL <DW12C>	07.10-05.15	0 445 010 367	0 986 437 034
3.0 HDi 24V [X7]	3,0	177	X8Z <DT20C>	07.09-04.14	0 445 010 832	
<b>C5 Break</b>						
1.6 HDi [X3]	1,6	80	9H... <DV6TED4>	10.04-03.08	0 445 010 296	0 986 437 028
2.0 HDi [X4]	2,0	66	RHY <DW10TD>	06.01-09.04 BO	0 445 010 046	0 986 437 017
		79/80	RHS <DW10ATED/FAP>; RHZ <DW10ATED>	06.01-09.04	0 445 010 046	0 986 437 017
2.2 HDi [X3]	2,2	98	4HX <DW12TED4>	10.04-09.05	0 445 010 021	0 986 437 012
		120-125	4H... <DW12BTED4>	04.06-03.08	0 445 010 367	0 986 437 034
HDi [X4]	2,2	98	4HX <DW12TED4>	06.01-09.04	0 445 010 021	0 986 437 012
<b>C5 Tourer</b>						
1.6 HDi [X7]	1,6	80	9HZ <DV6TED4>	04.08-07.10	0 445 010 296	0 986 437 028
2.2 HDi [X7]	2,2	120-125	4H... <DW12BTED4>	04.08-09.09	0 445 010 367	0 986 437 034
		150	4HL <DW12C>	07.10-05.15	0 445 010 367	0 986 437 034
3.0 HDi 24V [X7]	3,0	177	X8Z <DT20C>	07.09-04.14	0 445 010 832	
<b>C6</b>						
2.2 HDi [X6]	2,2	120-125	4H... <DW12BTED4>	06.06-07.10	0 445 010 367	0 986 437 034
3.0 HDi 24V [X6]	3,0	177	X8Z <DT20C>	07.09-12.12	0 445 010 832	
<b>C8</b>						
2.0 HDi [V3]	2,0	81	RH... <DW10ATED4/FAP>; RHW <DW10ATED4>	06.02-12.06	0 445 010 021	0 986 437 012
2.2 HDi [V3]	2,2	94	4HW <DW12TED4/FAP>	06.02-07.06	0 445 010 021	0 986 437 012
		120-125	4H... <DW12BTED4>	09.07-05.10	0 445 010 367	0 986 437 034
<b>DS3</b>						
1.4 HDi 8V [A55]	1,4	50	8H... <DV4C>	03.10-04.15	0 445 010 552	0 986 437 430
1.6 BlueHDi [A55]	1,6	55/73/85/88	BHW <DV6FE>; BHX <DV6FC>; BHY <DV6FD>; BHZ <DV6FC>	10.13-04.15	0 445 010 738	0 986 437 445
HDi [A55]	1,6	68	9HP <DV6DTE4>	01.10-04.15	0 445 010 552	0 986 437 430
<b>DS3 Cabrio</b>						
1.6 BlueHDi [A56]	1,6	73/85/88	BHX <DV6FC>; BHY <DV6FD>; BHZ <DV6FC>	10.13-04.15	0 445 010 738	0 986 437 445
HDi [A56]	1,6	68	9HP <DV6DTE4>	07.12-04.15	0 445 010 552	0 986 437 430
<b>DS4</b>						
1.6 BlueHDi, HDi [B75]	1,6	73/85/88	BHX <DV6FC>; BHY <DV6FD>; BHZ <DV6FC>	04.14-09.15	0 445 010 738	0 986 437 445
HDi 16V [B75]	1,6	68	9HP <DV6DTE4>	03.11-09.15	0 445 010 552	0 986 437 430
<b>DS5</b>						
1.6 BlueHDi [B81]	1,6	85/88	BHX <DV6FC>; BHZ <DV6FC>	09.13-04.15	0 445 010 578	0 986 437 445
<b>Evasion</b>						
2.0 HDi [U60]	2,0	80	RHZ <DW10ATED>			
			Org.-Nr. →9008	01.99-07.01	0 445 010 010	0 986 437 005
			Org.-Nr. 9009→	08.01-07.02	0 445 010 046	0 986 437 017
		81	RHW <DW10ATED4/L4>	06.00-07.02	0 445 010 021	0 986 437 012





◀ CITROEN

Grand C4 Spacetourer							
1.6 BlueHDi [B78]	1,6	73/85/88	BHX <DV6FC>; BHY <DV6FD>; BHZ <DV6FC>	04.18→		0 445 010 738	0 986 437 445
Jumpy							
1.6 BlueHDi [K0]	1,6	70/85	BHS <DV6FDU>; BHV <DV6FDU>; BHX <DV6FCU>	03.16→		0 445 010 738	0 986 437 445
HDi [G9]	1,6	66	9HH <DV6DU M>; 9HM <DV6U C>	12.10-12.16		0 445 010 552	0 986 437 430
			9HU <DV6UTED4>	02.07-12.16		0 445 010 296	0 986 437 028
2.0 HDi [U64]	2,0	70	RHX <DW10BTED>				
			Org.-Nr. →9008	10.99-07.01		0 445 010 010	0 986 437 005
			Org.-Nr. 9009→10558	08.01-10.05		0 445 010 046	0 986 437 017
			Org.-Nr. 10559→	11.05-01.07		0 445 010 132	0 986 437 018
		80	RHZ <DW10ATED>				
			Org.-Nr. →9008	10.99-07.01		0 445 010 010	0 986 437 005
			Org.-Nr. 9009→	08.01-01.07		0 445 010 046	0 986 437 017
		81	RHW <DW10ATED4>	06.00-01.07		0 445 010 021	0 986 437 012
Nemo							
1.3 HDi [A9]	1,3	59	FHY <F 13DTE6>	09.15→		0 445 010 425	0 986 437 097
1.4 HDi [A9]	1,4	50	8HS <DV4TED>	02.08→		0 445 010 296	0 986 437 028
SpaceTourer							
1.6 BlueHDi [K0]	1,6	70/85	BHS <DV6FDU>; BHV <DV6FDU>; BHX <DV6FCU>	03.16→		0 445 010 738	0 986 437 445
Xantia							
2.0 HDi [X2]	2,0	66/81	RHY <DW10TD>; RHZ <DW10ATED>	10.98-12.01		0 445 010 010	0 986 437 005
Xantia Break							
2.0 HDi [X2]	2,0	66/81	RHY <DW10TD>; RHZ <DW10ATED>	10.98-12.01		0 445 010 010	0 986 437 005
Xsara							
1.4 HDi [N7]	1,4	50	8HZ <DV4TD>				
			Org.-Nr. →10100	01.03-07.04		0 445 010 042	0 986 437 309
			Org.-Nr. 10101→	08.04-12.05		0 445 010 296	0 986 437 028
2.0 HDi [N6]	2,0	66	RHY <DW10TD>	02.99-08.00		0 445 010 010	0 986 437 005
HDi [N7]	2,0	66	RHY <DW10TD>				
			Org.-Nr. →8945	09.00-05.01 BO		0 445 010 010	0 986 437 005
			Org.-Nr. 8946→	06.01-12.05 BO		0 445 010 046	0 986 437 017
		80	RHZ <DW10ATED>				
			Org.-Nr. →8945	09.00-05.01		0 445 010 010	0 986 437 005
			Org.-Nr. 8946→	06.01-12.05		0 445 010 046	0 986 437 017
Xsara Break							
1.4 HDi [N7]	1,4	50	8HZ <DV4TD>				
			Org.-Nr. →10100	01.03-07.04		0 445 010 042	0 986 437 309
			Org.-Nr. 10101→	08.04-12.05		0 445 010 296	0 986 437 028
2.0 HDi [N6]	2,0	66	RHY <DW10TD>	02.99-08.00		0 445 010 010	0 986 437 005
HDi [N7]	2,0	66	RHY <DW10TD>				
			Org.-Nr. →8945	09.00-05.01 BO		0 445 010 010	0 986 437 005
			Org.-Nr. 8946→	06.01-03.10 BO		0 445 010 046	0 986 437 017
		80	RHZ <DW10ATED>				
			Org.-Nr. →8945	09.00-05.01		0 445 010 010	0 986 437 005
			Org.-Nr. 8946→	06.01-03.10		0 445 010 046	0 986 437 017
Xsara Coupé							
1.4 HDi [N7]	1,4	50	8H... <DV4TD>				
			Org.-Nr. →10100	01.03-07.04		0 445 010 042	0 986 437 309
			Org.-Nr. 10101→	08.04-12.05		0 445 010 296	0 986 437 028
2.0 HDi [N6]	2,0	66	RHY <DW10TD>	02.99-08.00		0 445 010 010	0 986 437 005
HDi [N7]	2,0	66	RHY <DW10TD>				
			Org.-Nr. →8945	09.00-05.01 BO		0 445 010 010	0 986 437 005
			Org.-Nr. 8946→	06.01-12.05 BO		0 445 010 046	0 986 437 017
		80	RHZ <DW10ATED>				
			Org.-Nr. →8945	09.00-05.01		0 445 010 010	0 986 437 005
			Org.-Nr. 8946→	06.01-12.05		0 445 010 046	0 986 437 017
Xsara Picasso							
1.6 HDi [N68]	1,6	66	9HX <DV6ATED4>	09.05-04.10		0 445 010 296	0 986 437 028
		80	9H... <DV6TED4>				
			Org.-Nr. →10261	05.04-12.04 MPR		0 445 010 089	0 986 437 322
			Org.-Nr. →10465	05.04-07.05 MPR		0 445 010 089	0 986 437 322
			Org.-Nr. 10262→	01.05-04.10 MPR		0 445 010 296	0 986 437 028
			Org.-Nr. 10466→	08.05-04.10 MPR		0 445 010 296	0 986 437 028





2.0 HDi	2,0	80	<DW10>	10.00-06.12	0 445 010 010	0 986 437 005
HDi [N68]	2,0	66	RHY <DW10TD>			
			Org.-Nr. →8945	01.00-05.01	0 445 010 010	0 986 437 005
			Org.-Nr. 8946→10262	06.01-12.04	0 445 010 046	0 986 437 017
			Org.-Nr. 10263→	01.05-04.10	0 445 010 132	0 986 437 018

## DACIA

<b>Dokker</b>						
1.5 dCi [FE/FK]	1,5	55/66	K9K 612	07.12-07.13	0 445 010 530	0 986 437 439
				08.13→	0 445 010 704	0 986 437 442
dCi [FE/KE]	1,5	55/66	K9K 626	05.15→	0 445 010 704	0 986 437 442
<b>Duster</b>						
1.5 dCi [HS]	1,5	66	K9K 612; K9K 626	09.13-05.18	0 445 010 704	0 986 437 442
<b>Lodgy</b>						
1.5 dCi [JS]	1,5	66	K9K 612	03.12-07.13	0 445 010 530	0 986 437 439
				08.13→	0 445 010 704	0 986 437 442
			K9K 626	05.15→	0 445 010 704	0 986 437 442
<b>Logan</b>						
1.5 dCi [L8]	1,5	55/66	K9K 612	08.12-07.13	0 445 010 530	0 986 437 439
				08.13→	0 445 010 704	0 986 437 442
<b>Logan MCV</b>						
1.5 dCi [K8]	1,5	55	K9K 612	03.13-07.13	0 445 010 530	0 986 437 439
				08.13→	0 445 010 704	0 986 437 442
		66	K9K 6...	03.13-07.13	0 445 010 530	0 986 437 439
				08.13→	0 445 010 704	0 986 437 442
<b>Sandero</b>						
1.5 dCi [B8]	1,5	55/66	K9K 612	08.12-07.13	0 445 010 530	0 986 437 439
				08.13→	0 445 010 704	0 986 437 442

## DAEWOO

<b>Winstorm Max</b>						
2.0 TD [C100]	2,0	110	Z20S1	06.06-08.07	0 445 010 142	0 986 437 032

## DODGE

<b>Grand Caravan</b>						
2.8 CRD [RT]	2,8	110	ENS	09.07-08.11	0 445 010 152	
<b>Nitro</b>						
2.8 CRD, CRD 4x4 [KA]	2,8	130	EN...	09.06-08.09	0 445 010 152	
<b>Ram 2500 Pickup</b>						
5.9 , 4x4	5,9	239/242		09.02-08.08	0 445 020 039	
<b>Ram 3500 Pickup</b>						
5.9	5,9	242	ETH	09.03-08.08	0 445 020 039	
, 4x4	5,9	160-175		09.02-08.04	0 445 020 039	
4x4	5,9			09.03-08.08	0 445 020 039	
6.7	6,7	261		09.06-08.07	0 445 020 072	F 00E 200 424
						0 986 437 333
				09.06-08.08	0 445 020 146	0 986 437 334
				09.07-08.08	0 445 020 039	













**DS (CITROEN)**

<b>DS</b>							
1.6 BlueHDi [B81]	1,6	85	BHX <DV6FC>		05.15→	0 445 010 578	0 986 437 445
<b>DS3</b>							
1.4 HDi 8V [A55]	1,4	50	8H... <DV4C>		05.15-12.15	0 445 010 552	0 986 437 430
1.6 BlueHDi [A55]	1,6	55/73/85/88	BHW <DV6FE>; BHX <DV6FC>; BHY <DV6FD>; BHZ <DV6FC>		05.15→	0 445 010 738	0 986 437 445
HDi [A55]	1,6	68	9HP <DV6DTED>		05.15-12.15	0 445 010 552	0 986 437 430
<b>DS3 Cabrio</b>							
1.6 BlueHDi [A56]	1,6	73/85/88	BHX <DV6FC>; BHY <DV6FD>; BHZ <DV6FC>		05.15→	0 445 010 738	0 986 437 445
HDi [A56]	1,6	68	9HP <DV6DTED>		05.15-12.15	0 445 010 552	0 986 437 430
<b>DS4</b>							
1.6 BlueHDi [B75]	1,6	73/85/88	BHX <DV6FC>; BHY <DV6FD>; BHZ <DV6FC>		10.15→	0 445 010 738	0 986 437 445
<b>DS5</b>							
1.6 BlueHDi [B81]	1,6	88	BHZ <DV6FC>		05.15→	0 445 010 578	0 986 437 445
<b>DS7</b>							
21.5 BlueHDi	1,5	96	YHZ <DV5RC>		09.17→	0 445 010 760	

**FIAT**

<b>Albea</b>							
1.3 JTD 16V [172]	1,3	52	188 A9.000 <M40>		07.03-12.12	0 445 010 276	0 986 437 023
<b>Brava</b>							
1.9 JTD [182]	1,9	74/77	182 B4.000 <M25>; 182 B9.000 <M26>		11.98-09.01	0 445 010 007	0 986 437 002
<b>Bravo</b>							
1.6 Multijet [198]	1,6	66	198 A6.000		02.09-12.09	0 445 010 305	0 986 437 094
					03.10-12.14	N5P 5PL	0 445 010 305 0 986 437 094 0 445 010 466 0 986 437 095
		77	198 A3.000		01.10-09.13		0 445 010 305 0 986 437 094
			844 A3.000		10.13-12.14		0 445 010 466 0 986 437 095
		77/85/88	198 A2.000 <M78>; 198 A3.000 <M76>; 955 A4.000		10.07-12.09		0 445 010 305 0 986 437 094
		88	198 A2.000		03.10-12.14	N5P 5PL	0 445 010 305 0 986 437 094 0 445 010 466 0 986 437 095
1.9 JTD [182]	1,9	74/77	182 B4.000 <M25>; 182 B9.000 <M26>		11.98-09.01	0 445 010 007	0 986 437 002
Multijet [198]	1,9	66/85/88	192 A8.000 <M88>; 192 B4.000 <M87>; 192 B5.000 <M83>		03.07-12.09	0 445 010 286	0 986 437 035
		110	937 A5.000 <M92>		04.07-12.09	0 445 010 305	0 986 437 094
2.0 Multijet [198]	2,0	120	844 A2.000		10.08-12.09	0 445 010 305	0 986 437 094
					03.10-12.14	0 445 010 305	0 986 437 094
		120-121	198 A...		03.10-12.14	0 445 010 305	0 986 437 094
		121	198 A5.000 <M120>		10.08-12.09	0 445 010 305	0 986 437 094
<b>Croma</b>							
1.9 JTD 8V [194]	1,9	85/88	939 A1.000 <M88>; 939 A7.000 <M87>		06.05-12.10	0 445 010 286	0 986 437 035
JTD 16V [194]	1,9	100/110	939 A2.000 <M92>; 939 A8.000 <M91>		06.05-12.10	0 445 010 305	0 986 437 094
2.4 JTD [194]	2,4	147	939 A3.000 <M95>		06.05-12.10	0 445 010 123	
<b>Doblo</b>							
1.3 JTD 16V [223]	1,3	51	188 A9.000 <M20>		02.04-09.05	0 445 010 276	0 986 437 023
Multijet [223]	1,3	55	199 A2.000 <M73>		10.05-08.16	0 445 010 276	0 986 437 023
		62	223 A9.000 <M71>		10.05-12.10	0 445 010 293	0 986 437 036
Multijet [263]	1,3	66	199 A3.000 <M72 (ECOCF4)>		02.10→	SSJ	0 445 010 293 0 986 437 036
			Fg.-Nr. →9524020		02.10→	SSJ	0 445 010 310 0 986 437 038
			Fg.-Nr. 9524021→		02.10→	SSJ	0 445 010 425 0 986 437 097
			263 A2.000 <M72>				
			Fg.-Nr. →9524020		02.10→	0 445 010 310	0 986 437 038
			Fg.-Nr. 9524021→		02.10→	0 445 010 425	0 986 437 097
Multijet [263]	1,3	70	330 A1.000		04.16→	0 445 010 425	0 986 437 097
1.6 Multijet [263]	1,6	66	263 A...		02.10→	N5P 5PL	0 445 010 305 0 986 437 094 0 445 010 466 0 986 437 095



										
1.6 Multijet [263]	1,6	74	263 A3.000 <M76>	02.10→	N5P	0 445 010 305	0 986 437 094			
			5PL	0 445 010 466	0 986 437 095					
	77	198 A3.000 <M76>	02.10→	N5P	0 445 010 305	0 986 437 094				
					5PL	0 445 010 466	0 986 437 095			
Multijet, MultiJet [263]	1,6	70/74/77/88	263 A7.000; 263 A8.000; 263 A9.000; 940 C1.000	04.15→		0 445 010 466	0 986 437 095			
1.9 JTD [223]	1,9	74/77	182 B9.000 <M15>; 223 A7.000 <M16/M30>	10.01-09.05		0 445 010 007	0 986 437 002			
Multijet [223]	1,9	74/77	223 B1.000 <M84>; 223 B2.000 <M86>	10.05-12.10		0 445 010 071				
			88	186 A9.000 <M88>	10.05-12.10		0 445 010 286	0 986 437 035		
2.0 Multijet [263]	2,0	99	263 A1.000 <M120>	02.10→	N5P	0 445 010 305	0 986 437 094			
					5PL	0 445 010 466	0 986 437 095			
<b>Doblo Cargo</b>										
1.3 JTD 16V [223]	1,3	51	188 A9.000 <M20>	02.04-09.05		0 445 010 276	0 986 437 023			
Multijet [223]	1,3	55	199 A2.000 <M73>	10.05-08.16		0 445 010 276	0 986 437 023			
			62	223 A9.000 <M71>	10.05-12.10		0 445 010 293	0 986 437 036		
MultiJet [263]	1,3	55	263 A6.000							
			Fg.-Nr. →9524020	01.14→	SSJ	0 445 010 425	0 986 437 097			
					SSJ	0 445 010 310	0 986 437 038			
			Fg.-Nr. 9524021→	01.14→		0 445 010 425	0 986 437 097			
			59/70	225 A2.000; 330 A1.000	04.16→		0 445 010 425	0 986 437 097		
			66	199 A3.000 <M72 (ECOFC4)>	02.10→	SSJ	0 445 010 293	0 986 437 036		
				Fg.-Nr. →9524020	02.10→	SSJ	0 445 010 310	0 986 437 038		
				Fg.-Nr. 9524021→	02.10→	SSJ	0 445 010 425	0 986 437 097		
		263 A2.000 <M72>								
		Fg.-Nr. →9524020	02.10→			0 445 010 310	0 986 437 038			
		Fg.-Nr. 9524021→	02.10→			0 445 010 425	0 986 437 097			
1.6 MultiJet [263]	1,6	66	263 A...	02.10→	N5P	0 445 010 305	0 986 437 094			
					5PL	0 445 010 466	0 986 437 095			
			74	263 A3.000 <M76>	02.10→	N5P	0 445 010 305	0 986 437 094		
					5PL	0 445 010 466	0 986 437 095			
			74/77/88	263 A8.000; 263 A9.000; 940 C1.000	04.15→		0 445 010 466	0 986 437 095		
			77	198 A3.000 <M76>	02.10→	N5P	0 445 010 305	0 986 437 094		
					5PL	0 445 010 466	0 986 437 095			
1.9 JTD [223]	1,9	74/77	182 B9.000 <M15>; 223 A7.000 <M16/M30>	10.01-09.05		0 445 010 007	0 986 437 002			
Multijet [223]	1,9	74/77	223 B1.000 <M84>; 223 B2.000 <M86>	10.05-12.10		0 445 010 071				
			88	186 A9.000 <M88>	10.05-12.10		0 445 010 286	0 986 437 035		
2.0 MultiJet [263]	2,0	99	263 A1.000 <M120>	02.10→	N5P	0 445 010 305	0 986 437 094			
					5PL	0 445 010 466	0 986 437 095			
<b>Fiorino</b>										
1.3 Multijet [225]	1,3	55	199 A2.000 <M73>	12.07→		0 445 010 276	0 986 437 023			
			199 A9.000 <ECOFC5>	06.10-05.12		0 445 010 310	0 986 437 038			
				06.12→		0 445 010 425	0 986 437 097			
			59/70	225 A2.000; 330 A1.000	03.15→		0 445 010 425	0 986 437 097		
			70	199 B1.000	09.10-05.12		0 445 010 310	0 986 437 038		
				06.12→		0 445 010 425	0 986 437 097			
<b>Freemont</b>										
2.0 Multijet, Multijet 4x4 [345]	2,0	100-103/120-125	939 B5.000	06.11-12.15		0 445 010 466	0 986 437 095			
<b>Grande Punto</b>										
1.3 MultiJet [199]	1,3	51/55	199 A2.000 <M73>; 199 B2.000 <ECOFC4>	10.05-12.11		0 445 010 276	0 986 437 023			
			55/62	199 A9.000 <ECOFC5>; 199 B4.000 <ECOFC5>	09.08-12.11		0 445 010 310	0 986 437 038		
			66	199 A3.000 <M72 (ECOFC4)>	10.05-12.09		0 445 010 293	0 986 437 036		
1.6 MultiJet [199]	1,6	88	955 A3.000 <M78>	08.08-12.09		0 445 010 305	0 986 437 094			
1.9 MultiJet [199]	1,9	85/88/96	199 A5.000 <M89>; 939 A1.000 <M88>;	10.05-12.09		0 445 010 286	0 986 437 035			
			939 A7.000 <M87>							
<b>Idea</b>										
1.3 MultiJet [350]	1,3	51	188 A9.000 <M30>	01.04-11.10		0 445 010 276	0 986 437 023			
			66	199 A3.000 <M72 (ECOFC4)>	11.04-11.10		0 445 010 293	0 986 437 036		
			70	199 B1.000	05.08-12.12		0 445 010 310	0 986 437 038		
1.6 MultiJet [350]	1,6	85-88	350 A...	04.08-12.12		0 445 010 305	0 986 437 094			
1.9 MultiJet [350]	1,9	74	188 B2.000 <M40>	01.04-12.12		0 445 010 071				
<b>Linea</b>										
1.2 TD [110]	1,3	67	199 A3.000	01.09→		0 445 010 293	0 986 437 036			





◀ FIAT

<b>1.3</b> MultiJet [323]	1,3	66	199 A3.000 <M72 (ECOCF4)>	03.07→	<b>0 445 010 293</b>	<b>0 986 437 036</b>
		70	199 B1.000	09.09→	<b>0 445 010 425</b>	<b>0 986 437 097</b>
<b>1.6</b> MultiJet [323]	1,6	77	198 A3.000 <M76>	10.08→	<b>0 445 010 305</b>	<b>0 986 437 094</b>
<b>Marea</b>						
<b>1.9</b> JTD, JTD S.W. [185]	1,9	74/77/81	182 B4.000 <M1>; 182 B9.000 <M5>; 186 A6.000 <M4>	03.99-09.02	<b>0 445 010 007</b>	<b>0 986 437 002</b>
<b>2.4</b> JTD [185]	2,4	100	185 A6.000 <M3>	03.99-09.02	<b>0 445 010 006</b>	<b>0 986 437 001</b>
<b>Marengo</b>						
<b>1.9</b> JTD [285]	1,9	77/81	182 B4.000 <M1>; 186 A6.000 <M4>	03.99-09.02	<b>0 445 010 007</b>	<b>0 986 437 002</b>
<b>Multipia</b>						
<b>1.9</b> JTD [186]	1,9	77/81/85	182 B4.000 <M5>; 186 A6.000 <M6>; 186 A8.000 <M7/EU3>	01.99-06.10	<b>0 445 010 007</b>	<b>0 986 437 002</b>
		85/88	186 A8.000 <M87/EU4>; 186 A9.000 <M88>	10.03-12.10	<b>0 445 010 286</b>	<b>0 986 437 035</b>
<b>Palio</b>						
<b>1.3</b> d 16V, JTD 16V [178]	1,3	52/56	188 A9.000; 188 A9.000 <M40>	07.03→	<b>0 445 010 276</b>	<b>0 986 437 023</b>
<b>Palio Weekend</b>						
<b>1.9</b> JTD [178]	1,9	57/80	188 A2.000 <M30>	10.01-12.08	<b>0 445 010 007</b>	<b>0 986 437 002</b>
<b>Panda</b>						
<b>1.3</b> JTD, JTD 4x4 [169]	1,3	52/55	169 A1.000 <M73>; 188 A8.000 <ECOCF4>; 188 A8.000 <M10>	01.04-09.10	<b>0 445 010 276</b>	<b>0 986 437 023</b>
MultiJet, MultiJet 4x4 [169]	1,3	55	169 A5.000 <ECOCF5>	03.10-12.12	<b>0 445 010 310</b>	<b>0 986 437 038</b>
MultiJet, MultiJet 4x4 [312]	1,3	55/59/70	199 A9.000 <ECOCF5>; 225 A2.000; 312 A8.000; 312 B1.000; 312 B2.000; 330 A1.000	02.12→	<b>0 445 010 425</b>	<b>0 986 437 097</b>
<b>Punto</b>						
<b>1.3</b> JTD 16V [188]	1,3	51-52	188 A9.000 <M20>	06.03-12.10	<b>0 445 010 276</b>	<b>0 986 437 023</b>
MultiJet [199]	1,3	55	199 A2.000 <ECOCF4>	01.12-08.13	<b>0 445 010 276</b>	<b>0 986 437 023</b>
			199 A9.000 <ECOCF5>	01.12-12.16	<b>0 445 010 425</b>	<b>0 986 437 097</b>
		59/62	199 B4.000 <ECOCF5>; 199 B8.000	01.12-12.16 TW	<b>0 445 010 310</b>	<b>0 986 437 038</b>
					<b>0 445 010 425</b>	<b>0 986 437 097</b>
		66/70	330 A1.000; 955 B2.000	05.16→	<b>0 445 010 425</b>	<b>0 986 437 097</b>
		70	199 B1.000	01.12-04.16 TW	<b>0 445 010 310</b>	<b>0 986 437 038</b>
					<b>0 445 010 425</b>	<b>0 986 437 097</b>
<b>1.9</b> JTD [188]	1,9	59/63	188 A2.000 <M5>; 188 A7.000 <M6>	07.99-06.03	<b>0 445 010 007</b>	<b>0 986 437 002</b>
JTD 8V [188]	1,9	63	188 A7.000 <M25>	07.03-12.10	<b>0 445 010 007</b>	<b>0 986 437 002</b>
		74	188 B2.000 <M30>	06.03-12.10	<b>0 445 010 071</b>	
<b>Punto Evo</b>						
<b>1.3</b> MultiJet [199]	1,3	51/55-56	199 A2.000 <ECOCF4>; 199 B2.000 <ECOCF4>	10.09-12.11	<b>0 445 010 276</b>	<b>0 986 437 023</b>
		55-56/62/	199 A9.000 <ECOCF5>; 199 B1.000; 199 B4.000	10.09-12.11	<b>0 445 010 310</b>	<b>0 986 437 038</b>
		68-70	<ECOCF5>			
		66	199 A3.000 <M72 (ECOCF4)>	10.09-12.11	<b>0 445 010 293</b>	<b>0 986 437 036</b>
<b>1.6</b> MultiJet [199]	1,6	88	955 A3.000 <M78>	10.09-12.11	<b>0 445 010 305</b>	<b>0 986 437 094</b>
<b>Punto Van</b>						
<b>1.3</b> JTD 16V [288]	1,3	51	188 A9.000 <M20>	07.03-12.10	<b>0 445 010 276</b>	<b>0 986 437 023</b>
<b>1.9</b> JTD, JTD 8V [288]	1,9	63	188 A7.000 <M6>; 188 A7.000 <M25>	05.99-12.10	<b>0 445 010 007</b>	<b>0 986 437 002</b>
<b>Qubo</b>						
<b>1.3</b> MultiJet [300]	1,3	55	199 A2.000 <M73>	09.08→	<b>0 445 010 276</b>	<b>0 986 437 023</b>
			199 A9.000 <ECOCF5>	06.10-05.12	<b>0 445 010 310</b>	<b>0 986 437 038</b>
				06.12→	<b>0 445 010 425</b>	<b>0 986 437 097</b>
		59/70	225 A2.000; 330 A1.000	03.15→	<b>0 445 010 425</b>	<b>0 986 437 097</b>
		70	199 B1.000	09.10-05.12	<b>0 445 010 310</b>	<b>0 986 437 038</b>
				06.12→	<b>0 445 010 425</b>	<b>0 986 437 097</b>
<b>Scudo</b>						
<b>1.6</b> MultiJet [270]	1,6	66	9HU <M1 - Euro 4>	01.07-04.16	<b>0 445 010 296</b>	<b>0 986 437 028</b>
MultiJet [270]	1,6	66	9H07 <M2 - Euro 5>	03.12-04.16	<b>0 445 010 552</b>	<b>0 986 437 430</b>
<b>2.0</b> 8V JTD [222]	2,0	70/81	RHX <M7/M14>; RHZ <M13>			
			Ricam.Nr 10560→	11.05-01.07	<b>0 445 010 132</b>	<b>0 986 437 018</b>
16V JTD [220]	2,0	81	RHW <M11>	09.00-05.04	<b>0 445 010 021</b>	<b>0 986 437 012</b>
16V JTD [222]	2,0	81	RHM <M11>	06.04-01.07	<b>0 445 010 021</b>	<b>0 986 437 012</b>
<b>Sedici</b>						
<b>1.9</b> JTD, JTD 4x4 [189]	1,9	88	D19AA <M88>			
			Mot.-Nr. →5016433	05.06-09.09	<b>0 445 010 097</b>	<b>0 986 437 025</b>
			Mot.-Nr. 5016434→	05.06-09.09	<b>0 445 010 288</b>	<b>0 986 437 025</b>
<b>2.0</b> JTD, JTD 4x4 [189]	2,0	99	D20AA <M120>	08.09-12.14	<b>0 445 010 184</b>	





<b>Stilo</b>							
1.9 JTD	1,9	85			06.02-12.07	0 445 010 007	0 986 437 002
JTD 8V [192]	1,9	59/74/85	192 A1.000 <M50>; 192 A3.000 <M40>; 192 A9.000 <M45>		10.01-12.07	0 445 010 007	0 986 437 002
		66	192 B5.000 <M83>		10.05-12.07	0 445 010 286	0 986 437 035
		85/88	192 A8.000 <M88>; 937 A7.000 <M87>		07.05-12.07	0 445 010 286	0 986 437 035
JTD 16V [192]	1,9	93/100/ 103	192 A5.000 <M60>; 192 B1.000 <M62>; 937 A4.000 <M61>		01.04-12.07	0 445 010 071	
		110	937 A5.000 <M92>		07.05-12.07	0 445 010 305	0 986 437 094
<b>Stilo Multi Wagon</b>							
1.9 JTD 8V [192]	1,9	59/85	192 A1.000 <M50>; 192 A3.000 <M40>		10.02-12.07	0 445 010 007	0 986 437 002
		66	192 B5.000 <M83>		10.05-12.07	0 445 010 286	0 986 437 035
		74	192 A9.000 <M45>		09.04-12.07	0 445 010 007	0 986 437 002
		85/88	192 A8.000 <M88>; 937 A7.000 <M87>		07.05-12.07	0 445 010 286	0 986 437 035
JTD 16V [192]	1,9	93/100	192 B1.000 <M62>; 937 A4.000 <M61>		09.04-12.07	0 445 010 071	
		103	192 A5.000 <M60>		01.04-12.07	0 445 010 071	
		110	937 A5.000 <M92>		07.05-12.07	0 445 010 305	0 986 437 094
<b>Strada</b>							
1.3 JTD [278]	1,3	63	223 A9.000 <M71>		07.05-12.11	0 445 010 293	0 986 437 036
MultiJet [278]	1,3	70	199 B1.000		12.11-12.14	0 445 010 425	0 986 437 097
1.9 JTD [278]	1,9	59	188 A2.000 <M50>		04.03-06.05	0 445 010 007	0 986 437 002
<b>Tipo</b>							
1.3 MultiJet [356]	1,3	70	199 B1.000		11.15→ TW	0 445 010 425	0 986 437 097
			55266963		11.15→	0 445 010 425	0 986 437 097
1.6 MultiJet [356]	1,6	88	940 C1.000		11.15→ TW	0 445 010 455	
						0 445 010 466	0 986 437 095
<b>Tipo Hatchback</b>							
1.3 MultiJet [356]	1,3	70	55266963		05.16→	0 445 010 425	0 986 437 097
1.6 MultiJet [356]	1,6	88	55260384		05.16→ TW	0 445 010 455	
						0 445 010 466	0 986 437 095
<b>Tipo Station Wagon</b>							
1.3 MultiJet [356]	1,3	70	55266963		06.16→	0 445 010 425	0 986 437 097
1.6 MultiJet [356]	1,6	88	55260384		06.16→ TW	0 445 010 455	
						0 445 010 466	0 986 437 095
<b>Ulysse</b>							
2.0 JTD 16V [220]	2,0	80	RHW <M11>		11.00-09.02	0 445 010 021	0 986 437 012
16V JTD [179]	2,0	79/80	RHM <M7>; RHW <M5>		10.02-01.06	0 445 010 021	0 986 437 012
2.2 16V JTD [179]	2,2	94	4HW <M10>		10.02-09.07	0 445 010 021	0 986 437 012
		120/125	4H... <DW12BTED4>; 4HT <M11,M12,M13>		10.07-12.10	0 445 010 367	0 986 437 034
<b>500</b>							
1.3 MultiJet [312]	1,3	55	169 A1.000 <M73>		07.07-12.12	0 445 010 276	0 986 437 023
		57/70	312 B1.000; 312 B5.000		01.16→	0 445 010 425	0 986 437 097
		70	199 B1.000 <M95>		01.10-12.15 TW	0 445 010 310	0 986 437 038
						0 445 010 425	0 986 437 097
<b>500C</b>							
1.3 MultiJet [312]	1,3	55	169 A1.000		07.09-12.12	0 445 010 276	0 986 437 023
		70	199 B1.000		01.10-12.15 TW	0 445 010 310	0 986 437 038
						0 445 010 425	0 986 437 097
MultiJet [312]	1,3	57/70	312 B1.000; 312 B5.000		01.16→	0 445 010 425	0 986 437 097
<b>500L</b>							
1.3 MultiJet [199]	1,3	62/70	199 B4.000 <ECOCF5>; 330 A1.000		09.12→	0 445 010 425	0 986 437 097
1.6 MultiJet, MultiJet [199]	1,6	77/88	199 B5.000; 940 C1.000; 955 A3.000		03.13→	0 445 010 466	0 986 437 095
<b>500X</b>							
1.3 MultiJet [334]	1,3	70	55266963		07.15→	0 445 010 425	0 986 437 097
1.6 MultiJet [334]	1,6	84-88	55260384		11.14→	0 445 010 466	0 986 437 095
2.0 MultiJet 4x4 [334]	2,0	100-103	5526308...		11.14→	0 445 010 466	0 986 437 095





**FORD**

<b>B-MAX</b>							
1.5 TDCi [12]	1,5	55	UGJC <Euro5>		08.12-06.15	0 445 010 576	0 986 437 449
		55/70	XUJ... <Euro 6>; XVJ... <Euro 6>		05.15→	0 445 010 591	0 986 437 446
1.6 TDCi [12]	1,6	70	T3J... <Euro5>		08.12-06.15	0 445 010 576	0 986 437 449
<b>C-MAX</b>							
1.5 TDCi, TDCi ECOnetic [15]	1,5	70/77/88	AEDA <Euro 6>; XWD... <Euro 6>; XXD... <Euro 6>		04.15→	0 445 010 591	0 986 437 446
1.6 TDCi [07]	1,6	66/74-80	G8D... <Euro4>; HHD... <Euro4>		03.07-07.10	0 445 010 296	0 986 437 028
<b>EcoSport</b>							
1.5 TDCi [14]	1,5	67	UGJE <Euro 5>		10.13-10.17	0 445 010 576	0 986 437 449
		70	XVJD <Euro 6>		06.15-10.17	0 445 010 591	0 986 437 446
		74	XUJH <Euro 6>		11.17→	0 445 010 548	0 986 437 448
TDCi EcoBlue 4x4 [14]	1,5	92	ZTJA <Euro 6>		11.17→	0 445 010 591	0 986 437 446
<b>Endeavour</b>							
3.0 Turbo intercooled 4WD [U268]	3,0	115	WEC		02.08→	0 445 010 213	
<b>Fiesta V</b>							
1.6 TDCi [02]	1,6	66	HHJ... <Euro3/Euro4>		11.04-09.08	0 445 010 296	0 986 437 028
<b>Fiesta VI</b>							
1.4 TDCi [08]	1,4	51	KVJA <Euro5>		09.10-06.11	0 445 010 552	0 986 437 430
					07.11-11.12	0 445 010 571	0 986 437 460
1.6 TDCi [08]	1,6	55/66	HHJ... <Euro4>; HHJF <Euro4>		07.08-11.12	0 445 010 296	0 986 437 028
		55/70	TZJ... <Euro5>; UBJA <Euro5>		03.10-11.12	0 445 010 552	0 986 437 430
		70	T3JA <Euro5>		02.12-11.12	0 445 010 571	0 986 437 460
<b>Fiesta VII</b>							
1.5 TDCi [13]	1,5	55	UGJ... <Euro4>		11.12→	TW	0 445 010 548
							0 986 437 448
		55/70	XUJ... <Euro 6>; XVJ... <Euro 6>		02.15→	0 445 010 591	0 986 437 446
1.6 TDCi, TDCi ECOnetic [13]	1,6	70	TZJ... <Euro5>; T3JA <Euro5>		11.12→	0 445 010 576	0 986 437 449
<b>Fiesta VIII</b>							
1.5 TDCi [17]	1,5	63/88	XUJ... <Euro 6>; XWJ... <Euro 6>		05.17→	0 445 010 591	0 986 437 446
<b>Focus C-MAX</b>							
1.6 TDCi [04]	1,6	66	... <Euro3>		11.04-03.07	0 445 010 296	0 986 437 028
		80	G8D... <Euro3>		06.03-04.05	0 445 010 089	0 986 437 322
					05.05-03.07	0 445 010 296	0 986 437 028
<b>Focus II</b>							
1.6 TDCi [04]	1,6	66	HHD... <Euro3>		07.04-01.08	0 445 010 296	0 986 437 028
		74-80	G8D... <Euro3>		07.04-04.05	0 445 010 089	0 986 437 322
					05.05-01.08	0 445 010 296	0 986 437 028
TDCi [08]	1,6	66/74-80	GPD... <Euro4/Euro5>; G8D... <Euro4>; G8D... <Euro4/Euro5>; HHD... <Euro3>		12.07-12.11	0 445 010 296	0 986 437 028
<b>Focus II Turnier</b>							
1.6 TDCi [04]	1,6	66	HHD... <Euro4>		07.04-01.08	0 445 010 296	0 986 437 028
		80	G8D... <Euro3>		07.04-04.05	0 445 010 089	0 986 437 322
					05.05-01.08	0 445 010 296	0 986 437 028
TDCi [08]	1,6	66/74-80	GPD... <Euro4/Euro5>; G8D... <Euro3/Euro4/Euro5>; HHD... <Euro3>		12.07-12.11	0 445 010 296	0 986 437 028
<b>Focus III</b>							
1.6 TDCi ECOnetic [11]	1,6	77	NGD... <Euro5>		06.12-12.14	0 445 010 569	0 986 437 459
<b>Focus III Turnier</b>							
1.6 TDCi ECOnetic [11]	1,6	77	NGD... <Euro5>		06.12-12.14	0 445 010 569	0 986 437 459
<b>Focus IV</b>							
1.5 TDCi, TDCi ECOnetic [15]	1,5	70/77/88	AEDA <Euro 6>; XWD... <Euro 6>; XXD... <Euro 6>		10.14→	0 445 010 591	0 986 437 446
<b>Focus IV Turnier</b>							
1.5 TDCi, TDCi ECOnetic [15]	1,5	70/77/88	AEDA <Euro 6>; XWD... <Euro 6>; XXD... <Euro 6>		10.14→	0 445 010 591	0 986 437 446
<b>Fusion</b>							
1.6 TDCi [02]	1,6	66	HHJ... <Euro3/Euro4>		11.04-06.12	0 445 010 296	0 986 437 028
<b>Galaxy</b>							
2.2 TDCi [06]	2,2	129/147	KNW... <Euro5>; Q4WA <Euro4>		03.08-12.14	0 445 010 367	0 986 437 034





<b>Ka</b>							
1.3 TDCi [08]	1,3	55	169 A... <Euro4/Euro5>		09.08-10.10	0 445 010 276	0 986 437 023
					11.10-02.12	0 445 010 310	0 986 437 038
					03.12-12.14	0 445 010 265	0 986 437 097
<b>Kuga</b>							
1.5 TDCi [13]	1,5	88	XWM... <Euro 6>		09.16→	0 445 010 591	0 986 437 446
<b>Mondeo IV</b>							
2.2 TDCi [07]	2,2	129/147	KNB... <Euro 5>; Q4BA <Euro4>		03.08-12.14	0 445 010 367	0 986 437 034
<b>Mondeo IV Turnier</b>							
2.2 TDCi [07]	2,2	129/147	KNB... <Euro 5>; Q4BA <Euro4>		03.08-12.14	0 445 010 367	0 986 437 034
<b>Mondeo V</b>							
1.5 TDCi, TDCi ECOnetic [15]	1,5	88	UGCC <Euro 6>; XUCA <Euro 6>		05.15→	0 445 010 591	0 986 437 446
1.6 TDCi, TDCi ECOnetic [15]	1,6	85	NGCA <Euro 5>; U3CA <Euro 5>		09.14→	0 445 010 569	0 986 437 459
<b>Mondeo V Turnier</b>							
1.5 TDCi, TDCi ECOnetic [15]	1,5	88	UGCC <Euro 6>; XUCA <Euro 6>		05.15→	0 445 010 591	0 986 437 446
1.6 TDCi, TDCi ECOnetic [15]	1,6	85	NGCA <Euro 5>; U3CA <Euro 5>		09.14→	0 445 010 569	0 986 437 459
<b>S-MAX</b>							
2.2 TDCi [06]	2,2	129/147	KNW... <Euro5>; Q4WA <Euro4>		03.08-12.14	0 445 010 367	0 986 437 034
<b>Tourneo Connect</b>							
1.5 TDCi [13]	1,5	55/74/88	XUGA <Euro 6>; XVG... <Euro 6>; XWG... <Euro 6>		06.15→	0 445 010 591	0 986 437 446
<b>Tourneo Courier</b>							
1.5 TDCi [14]	1,5	55	UGC... <Euro 5>		04.14-12.17	0 445 010 576	0 986 437 449
		55/70	XUC... <Euro 6>; XVC... <Euro 6>		06.15→	0 445 010 591	0 986 437 446
1.6 TDCi [14]	1,6	70	T3C... <Euro 5>		04.14-12.17	0 445 010 576	0 986 437 449

**GMC (GENERAL MOTORS CORP.)**

<b>Sierra 2500 HD</b>							
6.6	6,6	231	LLY		09.04-08.05	0 445 020 030	0 986 437 308

**GREAT WALL**

<b>Hover CUV</b>							
2.8 T	2,8	85	GW2.8TCL_EU3		01.04-02.11	0 445 010 159	

**HONDA**

<b>Accord Sedan</b>								
2.2 CTDi [CN1]	2,2	103	N22A1		01.05-06.08	0 445 010 141	0 986 437 356	
			i-DTEC [CU3]	N22B1		07.08-12.15	0 445 010 612	0 986 437 465
			i-DTEC Type S [CU3]	N22B2		07.09-12.15	0 445 010 635	
<b>Accord Tourer</b>								
2.2 CTDi [CN2]	2,2	103	N22A1		01.05-08.08	0 445 010 141	0 986 437 356	
			i-DTEC [CW3]	N22B1		09.08-12.15	0 445 010 612	0 986 437 465
			i-DTEC Type S [CW3]	N22B2		09.09-12.15	0 445 010 635	
<b>Civic Hatchback</b>								
1.6 i-DTEC [FK/FN]	1,6	88	N16A1		12.12-02.17	0 445 010 734	0 986 437 451	
2.2 CTDi [FK/FN]	2,2	103	N22A2		09.05-12.11	0 445 010 141	0 986 437 356	
			i-DTEC [FK/FN]	N22B4		09.11-12.13	0 445 010 635	
<b>Civic Tourer</b>								
1.6 i-DTEC [FK]	1,6	88	N16A1		12.13→	0 445 010 734	0 986 437 451	
<b>CR-V</b>								
1.6 i-DTEC [RE]	1,6	88	N16A2		09.13-08.14	0 445 010 734	0 986 437 451	
					09.14→	0 445 010 734	0 986 437 451	
					03.15→	0 445 010 734	0 986 437 451	
2.2 CTDi 4x4 [RD]	2,2	103	N22A2		02.05-09.06	0 445 010 141	0 986 437 356	
			CTDi 4x4 [RE]	N22A2		01.07-12.09	0 445 010 141	0 986 437 356
			i-DTEC [RE]	N22B4		10.12-12.14	0 445 010 635	
			i-DTEC 4x4 [RE]	N22B3		01.10-12.12	0 445 010 612	0 986 437 465







◀ HONDA

<b>FR-V</b>									
2.2	CTDi [BE]	2,2	103	N22A1		07.05-06.09		0 445 010 141	0 986 437 356
<b>HR-V</b>									
1.6	i-DETEC [RU]	1,6	88	N16A3		08.15→		0 445 010 734	0 986 437 451

**HYUNDAI**

<b>Accent</b>									
1.5	CRDi [LC]	1,5	57-60	D3-EA		01.02-06.06		0 445 010 280	0 986 437 021
	CRDi [MC, MCT]	1,5	81	D4FA <(1B) U15>		04.06-06.08		0 445 010 289	0 986 437 030
						07.08-02.12		0 445 010 290	0 986 437 042
<b>Accent blue</b>									
1.6	CRDi [RB]	1,6	94	D4FB <(1E) U162>		01.11-09.14		0 445 010 290	0 986 437 042
						10.14→		0 445 010 595	0 986 437 447
<b>Accent Hatchback</b>									
1.5	CRDi [LC]	1,5	57-60	D3-EA		01.02-06.06		0 445 010 280	0 986 437 021
	CRDi [MC, MCT]	1,5	81	D4FA <(1B) U15>		04.06-06.08		0 445 010 289	0 986 437 030
						07.08-02.12		0 445 010 290	0 986 437 042
<b>Elantra</b>									
1.6	CRDi [AD]	1,6	100	D4FB <(1E) U162>		03.16→		0 445 010 595	0 986 437 447
	CRDi [HD]	1,6	85	D4FB <(1C) U16>		08.06-06.08		0 445 010 289	0 986 437 030
						07.08-06.11		0 445 010 290	0 986 437 042
	CRDi [MD, UD]	1,6	94	D4FB <(1E) U162>		01.14-11.15		0 445 010 290	0 986 437 042
2.0	CRDi	2,0	83	D4EA		04.04-12.08		0 445 010 279	0 986 437 020
	CRDi [XD]	2,0	83	D4EA <(2B) D20>		06.01-08.06		0 445 010 279	0 986 437 020
<b>Elantra Hatchback</b>									
2.0	CRDi [XD]	2,0	83	D4EA <(2B) D20>		06.01-08.06		0 445 010 279	0 986 437 020
<b>Getz</b>									
1.5	CRDi [TB]	1,5	60	D3-EA <TCI>		05.03-08.05		0 445 010 280	0 986 437 021
			65	D4FA-L <TDI>		09.05-06.08		0 445 010 289	0 986 437 030
						07.08-06.09		0 445 010 290	0 986 437 042
			81	D4FA <TDI>		09.05-06.08		0 445 010 289	0 986 437 030
						07.08-06.09		0 445 010 290	0 986 437 042
	CRDi 16V [TB]	1,5	81	D4FA		09.07-02.10		0 445 010 290	0 986 437 042
<b>Grand Santa Fe</b>									
2.2	CRDi 4WD [NC]	2,2	145-147	D4HB <(2F) R22>		08.13→	EU6,TW	0 445 010 740	0 986 437 444
							TW	0 445 010 544	0 986 437 431
<b>Grandeur</b>									
2.2	CRDi [TG]	2,2	110-114	D4EB <(2D) D22>		07.06-11.10		0 445 010 342	0 986 437 354
<b>ix20</b>									
1.4	CRDi [JC]	1,4	57/66	D4FC <(1G) U142>; D4FC-M <(1G) U142>		03.15→		0 445 010 595	0 986 437 447
1.6	CRDi [JC]	1,6	85/94	D4FB <(1E) U162>		05.11-02.15		0 445 010 290	0 986 437 042
						03.15→		0 445 010 595	0 986 437 447
<b>ix35</b>									
1.7	CRDi [LM, EL]	1,7	85	D4FD <(1F) U172>		09.10-07.15		0 445 010 290	0 986 437 042
2.0	CRDi, CRDi 4x4 [LM, EL]	2,0	100/129-135	D4HA <(2E) R20>		01.10-07.15		0 445 010 544	0 986 437 431
<b>ix55</b>									
3.0	V6 CRDi 4x4 [EN]	3,0	176	D6EA <(9B) S30>		04.09-12.12		0 445 010 347	
			184	D6EB <(9C) S32>		07.11-12.12		0 445 010 385	
<b>i10</b>									
1.1	CRDi [PA]	1,1	55	D3FA <(1A) U11>		03.08-06.08		0 445 010 289	0 986 437 030
						07.08-12.10		0 445 010 290	0 986 437 042
<b>i20</b>									
1.4	[GB]	1,4	66	D4FC <1G U2>		11.14→		0 445 010 595	0 986 437 447
	CRDi [PB/PBT]	1,4	55/66	D4FC <(1D) U14/(1G) U142>		10.08-12.14	EU4	0 445 010 290	0 986 437 042
1.6	CRDi [PB/PBT]	1,6	85/94	D4FB <(1E) U162>		01.09-03.12		0 445 010 290	0 986 437 042
<b>i20 Active</b>									
1.4	CRDi [GB]	1,4	66	D4FC <1G U2>		01.16→		0 445 010 595	0 986 437 447
<b>i20 Coupé</b>									
1.4	[GB]	1,4	66	D4FC <1G U2>		04.15→		0 445 010 595	0 986 437 447





<b>i30</b>							
1.4 CRDi [GD]	1,4	66	D4FC <(1G) U142>	03.15→		0 445 010 595	0 986 437 447
1.6 CRDi [FD/FDH]	1,6	66/81-85	D4FB <(1C) U16/ (1E) U162>	09.07-08.12	TW	0 445 010 289	0 986 437 030
		94	D4FB <(1E) U162>	11.08-12.11		0 445 010 290	0 986 437 042
CRDi [GD]	1,6	81/94-100	D4FB <(1E) U162>	12.11-02.15		0 445 010 290	0 986 437 042
				03.15→		0 445 010 595	0 986 437 447
CRDi [PD]	1,6	70/81/100	D4FB <1600 U2>	12.16→		0 445 010 595	0 986 437 447
CRDi [GD]	1,6	100	D4FB <(1E) U162>	02.16→		0 445 010 595	0 986 437 447
2.0 CRDi [FD/FDH]	2,0	100-103	D4EA <(2B) D20>	09.07-03.11		0 445 010 342	0 986 437 354
<b>i30 Coupé</b>							
1.4 CRDi [GD]	1,4	66	D4FC <(1G) U142>	03.15→		0 445 010 595	0 986 437 447
1.6 CRDi [GD]	1,6	81/94	D4FB <(1E) U162>	02.13-02.15		0 445 010 290	0 986 437 042
				03.15→		0 445 010 595	0 986 437 447
CRDi [GD]	1,6	100	D4FB	11.15→		0 445 010 595	0 986 437 447
<b>i30 CW</b>							
1.4 CRDi [GD]	1,4	66	D4FC <(1G) U142>	03.15→		0 445 010 595	0 986 437 447
1.6 CRDi [FD/FDH]	1,6	66/85	D4FB <(1C) U16/ (1E) U162>	02.08-09.12	TW	0 445 010 289	0 986 437 030
		94	D4FB <(1E) U162>	11.08-09.12		0 445 010 290	0 986 437 042
CRDi [GD]	1,6	81/94	D4FB <(1E) U162>	03.12-02.15		0 445 010 290	0 986 437 042
				03.15→		0 445 010 595	0 986 437 447
CRDi [PD]	1,6	81/100	D4FB <1600 U2>	03.17→		0 445 010 595	0 986 437 447
CRDi [GD]	1,6	100	D4FB <(1E) U162>	02.16→		0 445 010 595	0 986 437 447
2.0 CRDi [FD/FDH]	2,0	100-103	D4EA <(2B) D20>	03.08-03.11		0 445 010 342	0 986 437 354
<b>i40</b>							
1.7 CRDi [VF]	1,7	85/100-104	D4FD <(1F) U172>	04.11-02.15		0 445 010 290	0 986 437 042
				03.15→		0 445 010 595	0 986 437 447
<b>i40 CW</b>							
1.7 CRDi [VF]	1,7	85/100-104	D4FD <(1F) U172>	04.11-02.15		0 445 010 290	0 986 437 042
				03.15→		0 445 010 595	0 986 437 447
<b>Matrix</b>							
1.5 CRDi [FC]	1,5	60	D3-EA <TCI>	07.01-01.06		0 445 010 280	0 986 437 021
		75	D4FA <TDI>	02.05-08.06		0 445 010 355	0 986 437 369
		81	D4FA-G <TDI>	09.06-06.08		0 445 010 289	0 986 437 030
				07.08-04.10		0 445 010 290	0 986 437 042
<b>Santa Fe</b>							
2.0 CRDi [DM]	2,0	83	D4EA	04.01-12.05		0 445 010 279	0 986 437 020
CRDi, CRDi 4WD [DM]	2,0	110/135	D4HA <(2E) R20>	09.12-04.15		0 445 010 544	0 986 437 431
				05.15→		0 445 010 740	0 986 437 444
CRDi, CRDi 4x4 [CM]	2,0	110	D4HA <(2E) R20>	09.10-12.12		0 445 010 544	0 986 437 431
CRDi, CRDi 4x4 [SM]	2,0	83	<DOHC>; D4EA <(2B) D20>	06.00-12.05		0 445 010 279	0 986 437 020
CRDi-VGT 4x4 [SM]	2,0	92-107	D4EA-V	08.03-12.05		0 445 010 281	0 986 437 022
2.2 CRDi, CRDi 4WD [DM]	2,2	145-147	D4HB <(2F) R22>	09.12-04.15		0 445 010 544	0 986 437 431
				05.15→		0 445 010 740	0 986 437 444
CRDi, CRDi 4x4 [CM]	2,2	110-114	D4EB <(2D) D22>	03.06-11.09		0 445 010 342	0 986 437 354
		145	D4HB <(2F) R22>	11.09-12.12		0 445 010 544	0 986 437 431
VGT CRDi	2,2	153	HTI	11.05-12.12		0 445 010 342	0 986 437 354
<b>Sante Fe</b>							
2.0 CRDi [DM]	2,0	135	D4HA <(2E) R20>	07.13-04.15		0 445 010 544	0 986 437 431
				05.15→		0 445 010 740	0 986 437 444
<b>Sonata</b>							
2.0 CRDi [NF]	2,0	100-105/110	D4EA <(2B) D20>	01.06-12.10		0 445 010 342	0 986 437 354
<b>Trajet</b>							
2.0 CRDi [FO]	2,0	83-92	D4EA <(2B) D20>	01.01-06.07		0 445 010 279	0 986 437 020
<b>Trajet XG</b>							
2.0 VGT CRDi	2,0	93	D4EA	01.99-12.07		0 445 010 079	0 986 437 022
<b>Tucson</b>							
1.7 CRDi [TL]	1,7	104	D4FD	03.16→		0 445 010 595	0 986 437 447
2.0 CRDi, CRDi 4x4 [JM]	2,0	83	D4EA <(2B) D20>	08.04-12.06	N25	0 445 010 279	0 986 437 020
					N25	0 445 010 342	0 986 437 354





## ◀ HYUNDAI

2.0 CRDi, CRDi 4x4 [JM]	2,0	100-103	D4EA...	09.05-03.10	N25	0 445 010 279	0 986 437 020
					N25	0 445 010 342	0 986 437 354
		110	D4EA <(2B) D20>	01.09-03.10	N25	0 445 010 279	0 986 437 020
					N25	0 445 010 342	0 986 437 354
VGT CRDi [JM]	2,0	115		12.05→		0 445 010 342	0 986 437 354
<b>Tucson</b>							
1.7 CRDi [TL]	1,7	85	D4FD	06.15→		0 445 010 595	0 986 437 447
2.0 CRDi, CRDi 4WD [TL]	2,0	100/136	D4HA <(2E) R20>	06.15→		0 445 010 740	0 986 437 444
<b>Veracruz D</b>							
3.0 TCI-S2 AWD [EN]	3,0	177	D6EA <(9B) S30>	09.06→		0 445 010 347	
<b>Verna</b>							
1.5 CRDi [MC]	1,5	82	D4FA	09.05-06.08		0 445 010 289	0 986 437 030
				07.08-05.11		0 445 010 290	0 986 437 042

## INFINITI

<b>EX 30</b>							
3.0 d 4x4 [J50]	3,0	175	V9X	04.10-06.14		0 445 010 324	
<b>FX 30</b>							
3.0 d 4x4 [S51]	3,0	175	V9X	03.10-12.13		0 445 010 324	
<b>M 30</b>							
3.0 d [Y51]	3,0	175	V9X	07.10-12.13		0 445 010 324	
<b>Q 70</b>							
3.0 CDi [Y51]	3,0	175	V9X	10.13-12.15		0 445 010 324	
<b>QX 50</b>							
3.0 4x4	3,0	175	V9X	10.13→	TW	0 445 010 324	
<b>QX 70</b>							
3.0 CDi AWD [S51]	3,0	175	V9X	11.13-12.16		0 445 010 324	

## IVECO

<b>Massif</b>							
3.0 D	3,0	107/130	F1CE0481F*..; F1CE0481H*..	06.08-12.12		0 445 020 046	0 986 437 321

## JAGUAR

<b>E-Pace</b>							
D150, AWD [X540]	2,0	110	204DTD	09.17→		0 445 010 705	0 986 437 462
D180 AWD [X540]	2,0	132	204DTD	09.17→		0 445 010 705	0 986 437 462
<b>F-Pace</b>							
E-Performance [X761]	2,0	120	204DTD	02.17→		0 445 010 705	0 986 437 462
2.0 D AWD [X761]	2,0	132	204DTD	04.16→		0 445 010 705	0 986 437 462
3.0 TDV6 AWD [X761]	3,0	221	306DT	04.16→		0 445 010 820	
<b>XE</b>							
2.0 E-performance	2,0	120	204PT	06.15→		0 445 010 705	0 986 437 462
20d, AWD	2,0	132	204DTD; 204PT	06.15→		0 445 010 705	0 986 437 462
<b>XF</b>							
2.0 E-Performance [X260]	2,0	120	204PT	10.15→		0 445 010 705	0 986 437 462
2.2 D [X250]	2,2	120-147	224DT	09.11-10.15		0 445 010 298	
3.0 D, D V6, D V6S [X250]	3,0	155/177/202	AJV6D	03.09-10.15		0 445 010 832	0 986 437 432
20d, AWD [X260]	2,0	132-177	204DTD	10.15→		0 445 010 705	0 986 437 462
30d [X260]	3,0	221	306DT	10.15→		0 445 010 820	
<b>XF Sportbrake</b>							
2.2 D	2,2	120-147	224DT	09.12-04.14		0 445 010 298	
3.0 D	3,0	177/202	AJV6D	09.12-04.14		0 445 010 832	0 986 437 432
20d [X260]	2,0	132	204DTD	07.17→		0 445 010 705	0 986 437 462



<b>XJ</b>						
3.0 DV6 [X351]	3,0	202	AJV6D			
			Fg.-Nr. V90866→	08.10-07.15	<b>0 445 010 820</b>	
			Fg.-Nr. →V90865	08.10-07.15	<b>0 445 010 832</b>	<b>0 986 437 432</b>
DV6 S [X351]	3,0	221	306DT			
			Fg.-Nr. V90866→	04.15→	<b>0 445 010 820</b>	
			Fg.-Nr. →V90865	04.15→	<b>0 445 010 832</b>	<b>0 986 437 432</b>

**JEEP**

<b>Commander</b>						
3.0 CRD 4x4 [XH]	3,0	160-165	EXL	01.08-08.11	<b>0 445 010 356</b>	<b>0 986 437 365</b>
<b>Grand Cherokee</b>						
3.0 CRDi 4x4 [WK2]	3,0	140/177/184	...; VM-23D	04.11→	<b>0 445 010 684</b>	<b>0 986 437 468</b>
<b>Liberty</b>						
2.8 CRD 4x4 [KK]	2,8	130/147	ENS	01.09-12.13	<b>0 445 010 152</b>	
<b>Renegade</b>						
1.6 MultiJet	1,6	70-77/84-88	55260384	07.14→	<b>0 445 010 466</b>	<b>0 986 437 095</b>
2.0 MultiJet 4x4	2,0	88/103/125	5526308...; 55263087; 55263088	07.14→	<b>0 445 010 466</b>	<b>0 986 437 095</b>
4x4	2,0	125	ECD	04.15→	<b>0 445 010 463</b>	
<b>Wrangler</b>						
2.8 CRD [JK]	2,8	130-147	ENS	01.07-12.07	<b>0 445 010 152</b>	

**KIA**

<b>Carens</b>						
1.6 CRDi [UN]	1,6	85/94	D4FB <1600 U2>	09.10→	<b>0 445 010 290</b>	<b>0 986 437 042</b>
1.7 CRDi [RP]	1,7	85/100-103	D4FD	01.13-07.16	<b>0 445 010 290</b>	<b>0 986 437 042</b>
				08.16→	<b>0 445 010 595</b>	<b>0 986 437 447</b>
2.0 CRDi, CRDi VGT [FJ]	2,0	83/103	D4EA	04.02-08.06	<b>0 445 010 279</b>	<b>0 986 437 020</b>
CRDi, CRDi VGT [UN]	2,0	85/100/103	D4EA; D4EA-L; D4EA-W	09.06→	<b>0 445 010 342</b>	<b>0 986 437 354</b>
<b>Carnival</b>						
2.2 CRDi [MB]	2,2	110/143	D4HB <2.2L-R>	10.09-12.12	<b>0 445 010 544</b>	<b>0 986 437 431</b>
<b>Cee'd</b>						
1.4 CRDi [JD]	1,4	66	D4FC <1G U2>	06.15→	<b>0 445 010 595</b>	<b>0 986 437 447</b>
1.6 CRDi [ED/FF2]	1,6	66	D4FB-L	11.06-01.09	<b>0 445 010 289</b>	<b>0 986 437 030</b>
				02.09-12.12	<b>0 445 010 290</b>	<b>0 986 437 042</b>
		85	D4FB <1600 U2>	11.06-01.09	<b>0 445 010 289</b>	<b>0 986 437 030</b>
				02.09-12.12	<b>0 445 010 290</b>	<b>0 986 437 042</b>
		94	D4FB <1600 U2>	09.10-12.12	<b>0 445 010 290</b>	<b>0 986 437 042</b>
CRDi [JD]	1,6	81	D4FB <1600 U2>	05.12-05.15	<b>0 445 010 290</b>	<b>0 986 437 042</b>
				06.15→	<b>0 445 010 595</b>	<b>0 986 437 447</b>
		94	D4FB <1600 U2>	05.12→	<b>0 445 010 290</b>	<b>0 986 437 042</b>
		100	D4FB	07.15→	<b>0 445 010 595</b>	<b>0 986 437 447</b>
2.0 CRDi [ED/FF2]	2,0	103	D4EA-F	09.07-12.12	<b>0 445 010 342</b>	<b>0 986 437 354</b>
<b>Cee'd Sporty Wagon</b>						
1.4 [JD]	1,4	66	D4FC <1G U2>	06.15→	<b>0 445 010 595</b>	<b>0 986 437 447</b>
1.6 [JD]	1,6	81/94	D4FB <1600 U2>	08.12-05.15	<b>0 445 010 290</b>	<b>0 986 437 042</b>
				06.15→	<b>0 445 010 595</b>	<b>0 986 437 447</b>
CRDi [ED/FF2]	1,6	66	D4FB-L	09.07-01.09	<b>0 445 010 289</b>	<b>0 986 437 030</b>
				02.09-12.12	<b>0 445 010 290</b>	<b>0 986 437 042</b>
		85	D4FB <1600 U2>	09.07-01.09	<b>0 445 010 289</b>	<b>0 986 437 030</b>
				02.09-12.12	<b>0 445 010 290</b>	<b>0 986 437 042</b>
		94	D4FB <1600 U2>	09.10-12.12	<b>0 445 010 290</b>	<b>0 986 437 042</b>
CRDi [JD]	1,6	100	D4FB	07.15→	<b>0 445 010 595</b>	<b>0 986 437 447</b>
2.0 CRDi [ED/FF2]	2,0	103	D4EA-F	09.07-12.12	<b>0 445 010 342</b>	<b>0 986 437 354</b>





◀ KIA

Cerato													
1.5 CRDi [FE]	1,5	75	D4FA		06.05-11.09		0 445 010 355	0 986 437 369					
1.6 CRDi [FE]	1,6	85	D4FB <1600 U2>		06.05-08.06		0 445 010 289	0 986 437 030					
					09.06-06.08		0 445 010 289	0 986 437 030					
					07.08-11.09		0 445 010 290	0 986 437 042					
2.0 CRDi [FE]	2,0	83	D4EA		04.04-11.09		0 445 010 279	0 986 437 020					
Cerato Hatchback													
1.5 CRDi [FE]	1,5	75	D4FA		06.05-11.09		0 445 010 355	0 986 437 369					
1.6 CRDi [FE]	1,6	85	D4FB <1600 U2>		06.05-08.06		0 445 010 289	0 986 437 030					
					09.06-06.08		0 445 010 289	0 986 437 030					
					07.08-11.09		0 445 010 290	0 986 437 042					
2.0 CRDi [FE]	2,0	83	D4EA		04.04-11.09		0 445 010 279	0 986 437 020					
Magentis													
2.0 CRDi [GE]	2,0	103/110	D4EA		02.06-04.10		0 445 010 342	0 986 437 354					
Mohave													
3.0 CRDi	3,0	184	<3.0S/ 3.0S2>		01.09→	EU3	0 445 010 347						
						EU4	0 445 010 385						
Optima													
1.7 CRDi [JF]	1,7	104	D4FD <1,7-U2>		07.16→		0 445 010 595	0 986 437 447					
					CRDi [TF]	1,7	100-103	D4FD <1,7-U2>	09.11→		0 445 010 290	0 986 437 042	
Picanto													
1.1 CRDi [SA]	1,1	55	D3FA <1H U2>		11.05-06.08		0 445 010 289	0 986 437 030					
					07.08-01.11		0 445 010 290	0 986 437 042					
Pro Cee'd													
1.4 CRDi [JD]	1,4	66	D4FC <1G U2>		06.15→		0 445 010 595	0 986 437 447					
1.6 CRDi [ED]	1,6	66	D4FB-FL		03.08-01.09		0 445 010 289	0 986 437 030					
					02.09-12.12		0 445 010 290	0 986 437 042					
					03.08-01.09		0 445 010 289	0 986 437 030					
					02.09-12.12		0 445 010 290	0 986 437 042					
					09.10-12.12		0 445 010 290	0 986 437 042					
					01.13-05.15		0 445 010 290	0 986 437 042					
CRDi [JD]	1,6	81	D4FB <1600 U2>		06.15→		0 445 010 595	0 986 437 447					
					01.13→		0 445 010 290	0 986 437 042					
					07.15→		0 445 010 595	0 986 437 447					
					03.08-12.12		0 445 010 342	0 986 437 354					
2.0 CRDi [ED]	2,0	103	D4EA		03.08-12.12		0 445 010 342	0 986 437 354					
Rio													
1.5 CRDi [JB, DE]	1,5	65	D4FA		09.08-10.10		0 445 010 290	0 986 437 042					
					03.05-09.11	TW	0 445 010 289	0 986 437 030					
							0 445 010 290	0 986 437 042					
Rio Hatchback													
1.4 CRDi [UB]	1,4	66	D4FC <1G U2>		11.14→		0 445 010 595	0 986 437 447					
					CRDi [YB]	1,4	57/66	D4FC <1G U2>	02.17→		0 445 010 595	0 986 437 447	
1.5 CRDi [JB, DE]	1,5	65/81	D4FA		03.05-09.11	TW	0 445 010 289	0 986 437 030					
							0 445 010 290	0 986 437 042					
Sorento													
2.0 CRDi, CRDi 4x4 [XM]	2,0	110	D4HA		10.10→		0 445 010 544	0 986 437 431					
					CRDi 4x4 [UM]	2,0	136	D4HA	02.15→		0 445 010 597	0 986 437 444	
2.2 CRDi, CRDi 4x4 [UM]	2,2	147	D4HB <2.2L-R>		02.15→		0 445 010 597	0 986 437 444					
					CRDi, CRDi 4x4 [XM]	2,2	145	D4HB <2.2L-R>	09.09→		0 445 010 544	0 986 437 431	
2.5 CRDi [BL]	2,5	107	D4CB		12.03-12.09		0 445 010 101	0 986 437 369					
					CRDi [JC, BL]	2,5	103	D4CB	07.02-12.03		0 445 010 354		
								01.04-08.09		0 445 010 355	0 986 437 369		
								120-125	D4CB	03.06-08.09	TW	0 445 010 333	
							0 445 010 355	0 986 437 369					
							0 445 010 399	0 986 437 029					
Soul													
1.6 CRDi [AM]	1,6	85/94	D4FB <1600 U2>		02.09-12.14		0 445 010 290	0 986 437 042					
					CRDi [PS]	1,6	94-100	D4FB	03.14-07.16		0 445 010 290	0 986 437 042	
								08.16→		0 445 010 595	0 986 437 447		
Sportage													
1.7 CRDi [QL]	1,7	85/104	D4FD		01.16→		0 445 010 595	0 986 437 447					
					CRDi [SL]	1,7	85	D4FD	09.10→	EU5	0 445 010 290	0 986 437 042	
									EU6	0 445 010 595	0 986 437 447		





<b>2.0</b> CRDi, CRDi, CRDi 4x4 [SL]	2,0	100/135	D4HA		07.10→		<b>0 445 010 544</b>	<b>0 986 437 431</b>
CRDi, CRDi 4x4 [KM]	2,0	83	D4EA		09.04-04.07		<b>0 445 010 279</b>	<b>0 986 437 020</b>
		100-103	D4EA...; D4EA-V		01.06-04.07		<b>0 445 010 342</b>	<b>0 986 437 354</b>
		110	D4EA		05.07-05.10	EU3	<b>0 445 010 279</b>	<b>0 986 437 020</b>
						EU4	<b>0 445 010 342</b>	<b>0 986 437 354</b>
CRDi, CRDi 4x4 [QL]	2,0	100/136	D4HA		01.16→		<b>0 445 010 597</b>	<b>0 986 437 444</b>
<b>Stinger</b>								
<b>2.2</b> CRDi, CRDi AWD [CK]	2,2	147	D4HC		10.17→		<b>0 445 010 597</b>	<b>0 986 437 444</b>
<b>Stonic</b>								
<b>1.6</b> CRDi [YB]	1,6	81	D4FB		10.17→		<b>0 445 010 595</b>	<b>0 986 437 447</b>
<b>Venga</b>								
<b>1.4</b> CRDi [YN]	1,4	55-57/66	D4FC <1G U2>		12.09→	TW	<b>0 445 010 595</b>	<b>0 986 437 447</b>
<b>1.6</b> CRDi [YN]	1,6	85/94	D4FB <1600 U2>		12.09→	TW	<b>0 445 010 290</b>	<b>0 986 437 042</b>
							<b>0 445 010 595</b>	<b>0 986 437 447</b>

## LANCIA

<b>Delta</b>								
<b>1.6</b> MultiJet [844]	1,6	77	844 A3.000; 944 A3.000		04.11-08.14	N5P	<b>0 445 010 303</b>	<b>0 986 437 094</b>
						5PL	<b>0 445 010 397</b>	<b>0 986 437 095</b>
		85	955 A4.000		07.08-12.14	N5P	<b>0 445 010 303</b>	<b>0 986 437 094</b>
						5PL	<b>0 445 010 397</b>	<b>0 986 437 095</b>
		88	198 A2.000 <M78>		07.08-12.14	N5P	<b>0 445 010 303</b>	<b>0 986 437 094</b>
						5PL	<b>0 445 010 397</b>	<b>0 986 437 095</b>
<b>1.9</b> MultiJet [844]	1,9	140	844 A1.000 <M94>		08.08-08.14		<b>0 445 010 309</b>	
<b>2.0</b> MultiJet [844]	2,0	120/121	198 A5.000 <M120>; 844 A2.000		08.08-08.14		<b>0 445 010 303</b>	<b>0 986 437 094</b>
<b>Kappa Berlina</b>								
<b>2.4</b> JTD [838]	2,4	100	838A8.000 <M3>		03.98-12.00		<b>0 445 010 006</b>	<b>0 986 437 001</b>
<b>Kappa Station Wagon</b>								
<b>2.4</b> JTD [838]	2,4	100	838A8.000 <M3>		03.98-12.00		<b>0 445 010 006</b>	<b>0 986 437 001</b>
<b>Lybra Berlina</b>								
<b>1.9</b> JTD [839]	1,9	77/80/85	AR32302 <M1 CF2>; AR37101 <M2 CF3>; 937 A2.000 <M3 CF3>		10.99-11.06		<b>0 445 010 007</b>	<b>0 986 437 002</b>
<b>2.4</b> JTD [839]	2,4	98/103/ 110	839A5.000/AR32501 <M6/M5 CF2>; 839A6.000 <M7 CF3>; 841C000 <M8 CF3>		10.99-09.05		<b>0 445 010 006</b>	<b>0 986 437 001</b>
<b>Lybra Station Wagon</b>								
<b>1.9</b> JTD [839]	1,9	77/80/85	AR32302 <M1 CF2>; AR37101 <M2 CF3>; 937 A2.000 <M3 CF3>		10.99-11.06		<b>0 445 010 007</b>	<b>0 986 437 002</b>
<b>2.4</b> JTD [839]	2,4	98/103/ 110	839A5.000/AR32501 <M6/M5 CF2>; 839A6.000 <M7 CF3>; 841C000 <M8 CF3>		10.99-09.05		<b>0 445 010 006</b>	<b>0 986 437 001</b>
<b>Musa</b>								
<b>1.3</b> MultiJet [350]	1,3	51-55	188 A9.000 <M30>		10.04-11.10		<b>0 445 010 276</b>	<b>0 986 437 023</b>
		66	199 A3.000 <M72 (ECO CF4)>		09.05-11.10		<b>0 445 010 293</b>	<b>0 986 437 036</b>
		70	199 B1.000		03.09-12.12		<b>0 445 010 310</b>	<b>0 986 437 038</b>
<b>1.6</b> MultiJet [350]	1,6	85/88	350 A2.000; 350 A3.000		10.07-12.12	SSJ	<b>0 445 010 303</b>	<b>0 986 437 094</b>
						SSJ	<b>0 445 010 310</b>	<b>0 986 437 038</b>
<b>1.9</b> MultiJet [350]	1,9	74	188 B2.000 <M40>		10.04-12.12		<b>0 445 010 071</b>	
<b>Phedra</b>								
<b>2.0</b> JTD 16V [179]	2,0	80	RHM <M7>; RHW <M5>		09.02-03.06		<b>0 445 010 021</b>	<b>0 986 437 012</b>
<b>2.2</b> JTD 16V [179]	2,2	95	4HW <M10>		09.02-09.07		<b>0 445 010 021</b>	<b>0 986 437 012</b>
		120/125	4HP <DW12BTED4>; 4HT <M11,M12,M13>		10.07-12.10		<b>0 445 010 367</b>	<b>0 986 437 034</b>
<b>Thema</b>								
<b>3.0</b> CRD	3,0	140/176			07.11-12.14		<b>0 445 010 689</b>	
<b>Thesis</b>								
<b>2.4</b> JTD 10V [841]	2,4	110	841C.000 <M20>		04.02-02.05		<b>0 445 010 006</b>	<b>0 986 437 001</b>
JTD 20V [841]	2,4	120/129	841G.000 <M24>; 841H.000 <M25>; 841M.000 <M22>; 841N.000 <M23>		06.03-02.06		<b>0 445 010 072</b>	
		136	841 P.000 <M99 CF4>		03.06-12.09		<b>0 445 010 285</b>	
<b>Ypsilon</b>								
<b>1.3</b> JTD, MultiJet [843]	1,3	51/55	188 A9.000 <M15>; 199 A2.000 <M73>		06.03-12.09		<b>0 445 010 276</b>	<b>0 986 437 023</b>
MultiJet [312]	1,3	57/70	312 B1.000; 312 B5.000		05.15→		<b>0 445 010 425</b>	<b>0 986 437 097</b>





◀ LANCIA

<b>1.3</b> MultiJet [312]	1,3	70	199 B1.000	06.11-02.12	<b>0 445 010 310</b>	<b>0 986 437 038</b>
				03.12-12.16	<b>0 445 010 425</b>	<b>0 986 437 097</b>
MultiJet [843]	1,3	55/66/77	199 A2.000 <ECOFC4>; 199 A3.000 <M72 (ECOFC4)>; 199 A3.000 <M105>; 199 A9.000 <ECOFC5>	10.06-11.11	<b>0 445 010 293</b>	<b>0 986 437 036</b>

**Zeta**

<b>2.0</b> JTD [122]	2,0	80	RHW <M11>	10.00-06.02	<b>0 445 010 021</b>	<b>0 986 437 012</b>
----------------------	-----	----	-----------	-------------	----------------------	----------------------

**LAND ROVER GROUP**

**Discovery IV**

<b>3.0</b> TDV6 [LA]	3,0	155/180-	306DT Fg.-Nr. CA632231→	09.09→	<b>0 445 010 832</b>	<b>0 986 437 432</b>
		184				
		155/180-	306DT Fg.-Nr. →CA632230	09.09→	<b>0 445 010 832</b>	<b>0 986 437 432</b>
		200				
		180-200	306DT Fg.-Nr. CA632231→	09.10→	<b>0 445 010 832</b>	<b>0 986 437 432</b>
			Fg.-Nr. GA000001→	09.10→	<b>0 445 010 820</b>	

**Discovery Sport**

<b>2.0</b> TD4 [B5,L550]	2,0	110/132	AJ200 <204DTD>	09.15→	<b>0 445 010 705</b>	<b>0 986 437 462</b>
<b>2.2</b> SD4 AWD, TD4 [B5,L550]	2,2	110/140	224DT	09.14→	<b>0 445 010 298</b>	

**Discovery V**

<b>2.0</b> Sd4 AWD [LR,B6]	2,0	177	204DTA	04.17→	<b>0 445 010 753</b>	
Td4 AWD [LR,B6]	2,0	132	AJ200 <204DTD>	04.17→	<b>0 445 010 705</b>	<b>0 986 437 462</b>
<b>3.0</b> Td6 AWD [LR,B6]	3,0	155-190	306DTX	04.17→	<b>0 445 010 820</b>	

**Freelander I**

<b>2.0</b> TD4 [LN]	2,0	80-82	TD4 204D3	09.01-10.06	<b>0 445 010 011</b>	<b>0 986 437 006</b>
---------------------	-----	-------	-----------	-------------	----------------------	----------------------

**Freelander II**

<b>2.2</b> eD4, SD4, Td4 [LF]	2,2	110-118/ 140	DW12BTED4; 224DT	10.06-11.14	<b>0 445 010 367</b>	<b>0 986 437 034</b>
-------------------------------	-----	-----------------	------------------	-------------	----------------------	----------------------

**Range Rover Evoque**

<b>2.0</b> eD4, TD4 AWD [LV]	2,0	110/132	AJ200 <204DTD>	09.15→	<b>0 445 010 705</b>	<b>0 986 437 462</b>
SD4 AWD [LV]	2,0	177	204DTA	08.17→	<b>0 445 010 753</b>	
<b>2.2</b> eD4, SD4 AWD, TD4 AWD [LV]	2,2	110/140	224DT	09.11-08.16	<b>0 445 010 298</b>	

**Range Rover Evoque Cabrio**

<b>2.0</b> SD4	2,0	177	204DTA	08.17→	<b>0 445 010 753</b>	
TD4 AWD	2,0	110/132	AJ200 <204DTD>	03.16→	<b>0 445 010 705</b>	<b>0 986 437 462</b>

**Range Rover III**

<b>3.0</b> Td6 [LM,L322]	2,9	130	M57 D30 <30 6D 1>	03.02-09.06	<b>0 445 010 009</b>	<b>0 986 437 004</b>
<b>4.4</b> TDV8 [LM,L322]	4,4	230	4,4	09.10-01.13	<b>0 445 010 666</b>	

**Range Rover IV**

<b>3.0</b> TD AWD [LG,L405]	3,0	155	306DT Fg.-Nr. GA000001→	10.13→	<b>0 445 010 820</b>	
			Fg.-Nr. →FA999999	10.13→	<b>0 445 010 820</b>	
		155-190	306DT	02.13→	<b>0 445 010 832</b>	<b>0 986 437 432</b>
<b>4.4</b> SD AWD [LG,L405]	4,4	250	448DT	01.14→	<b>0 445 010 666</b>	

**Range Rover Sport**

<b>2.0</b> SD4 [LW,L494]	2,0	177	AJ200 <204DTD>	09.16→	<b>0 445 010 753</b>	
<b>3.0</b> SDV6 [LW,L494]	3,0	215-225	306DT	09.13→	<b>0 445 010 832</b>	<b>0 986 437 432</b>
SDV6, TDV6 [LS,L320]	3,0	155-188	306DT	09.09-08.13	<b>0 445 010 832</b>	<b>0 986 437 432</b>
TDV6 [LW,L494]	3,0	183-190	306DTX	09.13→	<b>0 445 010 820</b>	
<b>4.4</b> SDV8 [LW,L494]	4,4	250	448DT	01.14→	<b>0 445 010 666</b>	

**Range Rover Velar**

<b>D180</b> AWD [LS560]	2,0	132	204DTD	08.17→	<b>0 445 010 705</b>	<b>0 986 437 462</b>
<b>D240</b> AWD [LS560]	2,0	177	204DTA	08.17→	<b>0 445 010 753</b>	
<b>D300</b> AWD [LS560]	3,0	221	306DT	08.17→	<b>0 445 010 820</b>	



**LUFENG**

<b>Landwind</b>						
2.5 D	2,5	156	VM_EU3		10.06-02.07	0 445 010 191

**MAHINDRA**

<b>Scorpio</b>						
2.2 D 4x4, TD [MI]	2,2	87	mHAWK		11.07→	0 445 010 419
2.6 CRDe	2,6	85	SZ CRDe		02.05-06.09	0 445 010 420
<b>Thar</b>						
2.5 D 4x4	2,5	77	NEF CRDe		12.10→	0 445 010 420
<b>XUV500</b>						
2.2 D, D 4x4	2,2	103	mHAWK		09.11→	0 445 010 419

**MAZDA**

<b>BT-50</b>						
2.5 D Turbo, D Turbo 4x4 [UN]	2,5	105	WLC <DuraTORQ TDCi>		03.06-01.08 02.08-07.12	0 445 010 107 0 986 437 385 0 445 010 213
3.0 D Turbo [UN]	3,0	115	WEC <DuraTORQ TDCi>		03.06-07.08 TW 03.06→ TW	0 445 010 107 0 986 437 385 0 445 010 213
D Turbo 4x4 [UN]	3,0	115	WEC <DuraTORQ TDCi>		03.06-01.08 02.08-07.12	0 445 010 107 0 986 437 385 0 445 010 213
<b>2</b>						
1.6 CD [DE]	1,6	66	Y6 Fg.-Nr. →DEA4**400000 →DEA3**300000		11.08-07.10	0 445 010 296 0 986 437 028
<b>3</b>						
1.6 MZ-CD [BK]	1,6	80	Y6		12.03-12.08 TW	0 445 010 089 0 986 437 322 0 445 010 296 0 986 437 028
MZR-CD [BL]	1,6	80-81	Y6		12.08-07.11	0 445 010 296 0 986 437 028
<b>3 Hatchback</b>						
1.6 MZ-CD [BK]	1,6	66/80	Y6		12.03-12.08 TW	0 445 010 089 0 986 437 322 0 445 010 296 0 986 437 028
MZR-CD [BL]	1,6	80-81	Y6		12.08-07.11	0 445 010 296 0 986 437 028



**MERCEDES-BENZ**

<b>Serie A</b>						
160 CDI [168]	1,7	44/55	OM 668.940 <DE 17 LA>; OM 668.941 <DE 17 A>		09.98-08.04	0 445 010 268 0 986 437 100
170 CDI [168]	1,7	66/70	OM 668.940 <DE 17 LA>; OM 668.942 <DE 17 LA>		07.98-08.04	0 445 010 268 0 986 437 100
<b>Serie C</b>						
30 AMG CDI [203]	3,0	170	OM 612.990 <DE 30 LA AMG>		01.03-08.04	0 445 010 334 0 986 437 360
200 CDI [202]	2,2	75	OM 611.960 <DE LA>		03.98-04.00	RAP 0 445 010 268 0 986 437 100 RAP 0 445 010 274 0 986 437 100
CDI [203]	2,2	85	OM 611.962 <DE LA>		10.00-05.03	RAP 0 445 010 268 0 986 437 100 RAP 0 445 010 274 0 986 437 100
220 CDI [202]	2,2	92	OM 611.960 <DE LA>		12.97-04.00	RAP 0 445 010 268 0 986 437 100 RAP 0 445 010 274 0 986 437 100
CDI [203]	2,2	100-105	OM 611.962 <DE LA>		05.00-02.03	RAP 0 445 010 268 0 986 437 100 RAP 0 445 010 274 0 986 437 100
270 CDI [203]	2,7	125	OM 612.962 <DE LA>		12.00-08.04	0 445 010 271 0 986 437 104
350 CDI [204]	3,0	195	OM 642.834 Mot.-Nr. ...41581598→ Mot.-Nr. ...41620114 Mot.-Nr. ...41776848 Mot.-Nr. ...41784298		04.14-12.14 SSJ	0 445 010 322 0 986 437 374
<b>Serie C (Sportcoupe)</b>						
30 AMG CDI [203]	3,0	170	OM 612.990 <DE 30 LA AMG>		09.02-08.04	0 445 010 334 0 986 437 360



◀ MERCEDES-BENZ

220 CDI [203]	2,2	105	OM 611.962 <DE LA>	01.01-04.04	RAP	0 445 010 268	0 986 437 100
					RAP	0 445 010 274	0 986 437 100
<b>Serie C (T-Modell)</b>							
30 AMG CDI [203]	3,0	170	OM 612.990 <DE 30 LA AMG>	01.03-08.04		0 445 010 334	0 986 437 360
200 CDI [202]	2,2	75	OM 611.960 <DE LA>	03.98-02.01	RAP	0 445 010 268	0 986 437 100
					RAP	0 445 010 274	0 986 437 100
CDI [203]	2,2	85	OM 611.962 <DE LA>	10.01-05.03	RAP	0 445 010 268	0 986 437 100
					RAP	0 445 010 274	0 986 437 100
220 CDI [202]	2,2	92	OM 611.960 <DE LA>	12.97-02.01	RAP	0 445 010 268	0 986 437 100
					RAP	0 445 010 274	0 986 437 100
CDI [203]	2,2	105	OM 611.962 <DE LA>	01.01-02.03	RAP	0 445 010 268	0 986 437 100
					RAP	0 445 010 274	0 986 437 100
270 CDI [203]	2,7	125	OM 612.962 <DE LA>	01.01-08.04		0 445 010 271	0 986 437 104
350 CDI [204]	3,0	195	OM 642.834				
			Mot.-Nr...41581598→	04.14-12.14	SSJ	0 445 010 322	0 986 437 374
			Mot.-Nr...41620114				
			Mot.-Nr...41776848				
			Mot.-Nr...41784298				
<b>Serie CLK (Coupé)</b>							
270 CDI [209]	2,7	125	OM612962... <DE LA>	09.02-03.05		0 445 010 271	0 986 437 104
<b>Serie CLS (Coupé)</b>							
350 BlueTec [218]	3,0	185	OM 642.85... <D 30>				
			Mot.-Nr...41581598→	04.14-03.15		0 445 010 322	0 986 437 374
			Mot.-Nr...41620114				
			Mot.-Nr...41776848				
			Mot.-Nr...41784298				
BlueTec, CDI [218]	3,0	185-190/ 195	OM 642.853 <D 30>				
			Mot.-Nr...41581598→	04.14-02.16		0 445 010 322	0 986 437 374
			Mot.-Nr...41620114				
			Mot.-Nr...41776848				
			Mot.-Nr...41784298				
CDI 4MATIC [218]	3,0	195	OM 642.854 <D 30>				
			Mot.-Nr...41581598→	04.14-12.15		0 445 010 322	0 986 437 374
			Mot.-Nr...41620114				
			Mot.-Nr...41776848				
			Mot.-Nr...41784298				
d [218]	3,0	190	OM 642.853 <D 30>	03.16→		0 445 010 322	0 986 437 374
d 4MATIC [218]	3,0	190	OM 642.85... <D 30>	04.15→		0 445 010 322	0 986 437 374
d 4MATIC [257]	2,9	210	OM 656.929 <DE29 LHD>	12.17→		0 445 010 836	
400 d 4MATIC [257]	2,9	250	OM 656.929 <DE29 LHD>	12.17→		0 445 010 836	
<b>Serie CLS (Shooting Brake)</b>							
350 BlueTec, BlueTec 4MATIC [218]	3,0	185/190	OM 642.85... <D 30>	05.14-02.16	SSJ	0 445 010 322	0 986 437 374
CDI [218]	3,0	195	OM 642.853 <D 30>				
			Mot.-Nr...41581598→	04.14-02.16	SSJ	0 445 010 322	0 986 437 374
			Mot.-Nr...41620114				
			Mot.-Nr...41776848				
			Mot.-Nr...41784298				
CDI 4MATIC [218]	3,0	195	OM 642.854 <D 30>				
			Mot.-Nr...41581598→	04.14-03.15	SSJ	0 445 010 322	0 986 437 374
			Mot.-Nr...41620114				
			Mot.-Nr...41776848				
			Mot.-Nr...41784298				
d [218]	3,0	190	OM 642.853 <D 30>	03.16→	SSJ	0 445 010 322	0 986 437 374
d 4MATIC [218]	3,0	185-190	OM 642.854 <D 30>	04.15→	SSJ	0 445 010 322	0 986 437 374
<b>Serie E</b>							
200 CDI [210]	2,1	85	OM 611.961 <DE LA>	08.99-03.02	RAP	0 445 010 268	0 986 437 100
					RAP	0 445 010 274	0 986 437 100
	2,2	75	OM 611.961 <DE LA>	07.98-03.02	RAP	0 445 010 268	0 986 437 100
					RAP	0 445 010 274	0 986 437 100
d [213]	2,0	110	OM 654.920 <DE 20>	06.16→	WAS	0 445 010 735	
					WAS	0 445 010 757	
220 CDI [210]	2,1	100-105	OM 611.961 <DE LA>	08.99-03.02	RAP	0 445 010 268	0 986 437 100
					RAP	0 445 010 274	0 986 437 100





<b>220</b> CDI [210]	2,2	92	OM 611.961 <DE LA>	07.98-07.99	RAP	<b>0 445 010 268</b>	<b>0 986 437 100</b>
					RAP	<b>0 445 010 274</b>	<b>0 986 437 100</b>
d, d 4MATIC [213]	2,0	143	OM 654.920 <DE 20>	01.16→	WAS	<b>0 445 010 735</b>	
					WAS	<b>0 445 010 757</b>	
<b>270</b> CDI [210]	2,7	125	OM 612.961 <DE LA>	08.99-03.02		<b>0 445 010 271</b>	<b>0 986 437 104</b>
<b>300</b> BlueTec [212]	3,0	170	OM 642.852 <D 30>	04.14-08.16	SSJ	<b>0 445 010 322</b>	<b>0 986 437 374</b>
			Mot.-Nr. ...41581598→				
			Mot.-Nr. ...41620114				
			Mot.-Nr. ...41776848				
			Mot.-Nr. ...41784298				
CDI [212]	3,0	150	OM 642.850 <D 30>	12.09-12.10	SGJ,WAS	<b>0 445 010 322</b>	<b>0 986 437 374</b>
		170	OM 642.850 <D 30>	07.10-12.13	WAS	<b>0 445 010 322</b>	<b>0 986 437 374</b>
d [213]	2,0	180	OM 654.920 <DE 20>	02.18→	ERL	<b>0 445 010 778</b>	
					LEN,WAS	<b>0 445 010 735</b>	
					LEN,WAS	<b>0 445 010 757</b>	
<b>320</b> CDI [210]	3,2	145-146	OM 613.961 <DE LA>	08.99-03.02		<b>0 445 010 270</b>	<b>0 986 437 102</b>
<b>350</b> BlueTec, BlueTec 4MATIC [212]	3,0	185-190	OM 642.85... <D 30>; OM 642.852 <D 30>	04.14-08.16	SSJ	<b>0 445 010 322</b>	<b>0 986 437 374</b>
			Mot.-Nr. ...41581598→				
			Mot.-Nr. ...41620114				
			Mot.-Nr. ...41776848				
			Mot.-Nr. ...41784298				
CDI, CDI 4MATIC [212]	3,0	170	OM 642.850 <D 30>; OM 642.856 <D 30>	08.08-11.10	WAS	<b>0 445 010 322</b>	<b>0 986 437 374</b>
d, d 4MATIC [213]	3,0	190	OM 642.855 <D 30>; OM 642.873 <D30 LHD>	01.16→		<b>0 445 010 322</b>	<b>0 986 437 374</b>
<b>400</b> CDI [211]	4,0	191	OM 628.961 <DE 40 LA>	02.03-04.05		<b>0 445 010 334</b>	<b>0 986 437 360</b>
<b>Serie E (All-Terrain)</b>							
<b>220</b> d 4MATIC [213]	2,0	143	OM 654.920 <DE 20>	01.17→	WAS	<b>0 445 010 735</b>	
					WAS	<b>0 445 010 757</b>	
<b>Serie E (Cabrio)</b>							
<b>220</b> d [238]	2,0	143	OM 654.920 <DE 20>	06.17→	WAS	<b>0 445 010 735</b>	
					WAS	<b>0 445 010 757</b>	
<b>350</b> BlueTec [207]	3,0	185-190	OM 642.838 <D 30>	01.13-08.15	TW	<b>0 445 010 322</b>	<b>0 986 437 374</b>
d 4MATIC [238]	3,0	190	OM 642.873 <D30 LHD>	09.17→		<b>0 445 010 322</b>	<b>0 986 437 374</b>
<b>Serie E (Coupé)</b>							
<b>220</b> d, d 4MATIC [238]	2,0	143	OM 654.920 <DE 20>	12.16→	WAS	<b>0 445 010 735</b>	
					WAS	<b>0 445 010 757</b>	
<b>350</b> BlueTec [207]	3,0	185-190	OM 642.838 <D 30>	01.13-08.15	TW	<b>0 445 010 322</b>	<b>0 986 437 374</b>
d 4MATIC [238]	3,0	190	OM 642.873 <D30 LHD>	06.17→		<b>0 445 010 322</b>	<b>0 986 437 374</b>
<b>Serie E (T-Modell)</b>							
<b>200</b> d [213]	2,0	110	OM 654.920 <DE 20>	06.16→	WAS	<b>0 445 010 735</b>	
					WAS	<b>0 445 010 757</b>	
<b>220</b> CDI [210]	2,1	100-105	OM 611.961 <DE LA>	08.99-01.03	RAP	<b>0 445 010 268</b>	<b>0 986 437 100</b>
					RAP	<b>0 445 010 274</b>	<b>0 986 437 100</b>
	2,2	92	OM 611.961 <DE LA>	07.98-07.99	RAP	<b>0 445 010 268</b>	<b>0 986 437 100</b>
					RAP	<b>0 445 010 274</b>	<b>0 986 437 100</b>
d, d 4MATIC [213]	2,0	120-143	OM 654.920 <DE 20>	06.16→	WAS	<b>0 445 010 735</b>	
					WAS	<b>0 445 010 757</b>	
<b>270</b> CDI [210]	2,7	125	OM 612.961 <DE LA>	08.99-01.03		<b>0 445 010 271</b>	<b>0 986 437 104</b>
<b>300</b> BlueTec [212]	3,0	170	OM 642.852 <D 30>	04.14-08.16	SSJ	<b>0 445 010 322</b>	<b>0 986 437 374</b>
			Mot.-Nr. ...41581598→				
			Mot.-Nr. ...41620114				
			Mot.-Nr. ...41776848				
			Mot.-Nr. ...41784298				
CDI [212]	3,0	150/170	OM 642.850 <D 30>	12.09-12.13	SGJ,WAS	<b>0 445 010 322</b>	<b>0 986 437 374</b>
d [213]	2,0	180	OM 654.920 <DE 20>	02.18→	ERL	<b>0 445 010 778</b>	
					LEN,WAS	<b>0 445 010 735</b>	
					LEN,WAS	<b>0 445 010 757</b>	
<b>320</b> CDI [210]	3,2	145	OM 613.961 <DE LA>	08.99-01.03		<b>0 445 010 270</b>	<b>0 986 437 102</b>
<b>350</b> BlueTec [212]	3,0	155	OM 642.850 <D 30>	08.09-12.13	SGJ,WAS	<b>0 445 010 322</b>	<b>0 986 437 374</b>
BlueTec, BlueTec 4MATIC [212]	3,0	185-190	OM 642.85... <D 30>; OM 642.852 <D 30>	04.14-08.16	SSJ	<b>0 445 010 322</b>	<b>0 986 437 374</b>
			Mot.-Nr. ...41581598→				
			Mot.-Nr. ...41620114				
			Mot.-Nr. ...41776848				
			Mot.-Nr. ...41784298				





◀ MERCEDES-BENZ

<b>350 CDI [212]</b>	3,0	170	OM 642.850 <D 30>	08.09-11.10	WAS	<b>0 445 010 322</b>	<b>0 986 437 374</b>
CDI 4MATIC [212]	3,0	170	OM 642.856 <D 30>	08.09-11.10	WAS	<b>0 445 010 322</b>	<b>0 986 437 374</b>
d, d All-Terrain 4Matic [213]	3,0	190	OM 642.855 <D 30>; OM 642.873 <D30 LHD>	06.16→		<b>0 445 010 322</b>	<b>0 986 437 374</b>
<b>Serie G</b>							
<b>270 CDI [463]</b>	2,7	115	OM 612.965 <DE LA>	10.01-08.06		<b>0 445 010 271</b>	<b>0 986 437 104</b>
CDI 4MATIC [461]	2,7	115	OM 612.966 <612 DE>	01.03-12.07		<b>0 445 010 271</b>	<b>0 986 437 104</b>
<b>300 CDI [461]</b>	3,0	135	OM 642.884 <OM642>	09.09→		<b>0 445 010 322</b>	<b>0 986 437 374</b>
<b>400 CDI [463]</b>	4,0	184	OM 628.962 <DE40LARL>	12.00-08.06		<b>0 445 010 334</b>	<b>0 986 437 360</b>
<b>Serie GL</b>							
<b>350 CDI BlueTec 4MATIC [166]</b>	3,0	190	OM 642.826 <D 30>				
			Mot.-Nr...41581598→	04.14-12.15	SSJ	<b>0 445 010 322</b>	<b>0 986 437 374</b>
			Mot.-Nr...41620114				
			Mot.-Nr...41776848				
			Mot.-Nr...41784298				
<b>Serie GLC</b>							
<b>350 d 4MATIC [253]</b>	3,0	190	OM 642.873 <D30 LHD>	09.16→		<b>0 445 010 322</b>	<b>0 986 437 374</b>
<b>Serie GLC (Coupé)</b>							
<b>350 d 4MATIC [253]</b>	3,0	190	OM 642.873 <D30 LHD>	10.16→		<b>0 445 010 322</b>	<b>0 986 437 374</b>
<b>Serie GLE</b>							
<b>350 d 4MATIC [166]</b>	3,0	190	OM 642.826 <D 30>	04.15→	SCJ,SSJ	<b>0 445 010 322</b>	<b>0 986 437 374</b>
<b>Serie GLE (Coupé)</b>							
<b>350 d 4MATIC [292]</b>	3,0	190	OM 642.826 <D 30>	04.15→	SCJ,SSJ	<b>0 445 010 322</b>	<b>0 986 437 374</b>
<b>Serie GLK</b>							
<b>350 CDI 4MATIC [204]</b>	3,0	195	OM 642.835 <D 30>				
			Mot.-Nr...41581598→	04.14-08.15	SSJ	<b>0 445 010 322</b>	<b>0 986 437 374</b>
			Mot.-Nr...41620114				
			Mot.-Nr...41776848				
			Mot.-Nr...41784298				
<b>Serie GLS</b>							
<b>350 d [166]</b>	3,0	190	OM 642.826 <D 30>	09.15→	SCJ,SSJ	<b>0 445 010 322</b>	<b>0 986 437 374</b>
<b>Serie ML</b>							
<b>270 CDI [163]</b>	2,7	120	OM 612.963 <DE LA>	11.99-06.05		<b>0 445 010 271</b>	<b>0 986 437 104</b>
<b>300 CDI 4MATIC [164]</b>	3,0	150	OM 642.820 <D 30>	05.09-07.11	SCJ,WAS	<b>0 445 010 322</b>	<b>0 986 437 374</b>
<b>350 BlueTec 4MATIC [166]</b>	3,0	190	OM 642.826 <D 30>				
			Mot.-Nr...41581598→	04.14-08.15	SSJ	<b>0 445 010 322</b>	<b>0 986 437 374</b>
			Mot.-Nr...41620114				
			Mot.-Nr...41776848				
			Mot.-Nr...41784298				
CDI 4MATIC [164]	3,0	170	OM 642.820 <D 30>	02.10-08.11	SCJ,WAS	<b>0 445 010 322</b>	<b>0 986 437 374</b>
<b>400 CDI [163]</b>	4,0	184	OM 628.963 <DE 40 LA LL>	09.01-06.05		<b>0 445 010 334</b>	<b>0 986 437 360</b>
<b>Serie S</b>							
<b>320 CDI [220]</b>	3,2	145	OM 613.960 <DE 32 LA>	06.99-08.02		<b>0 445 010 270</b>	<b>0 986 437 102</b>
<b>350 BlueTec [222]</b>	3,0	190	OM 642.861 <D 30>	05.13-08.15	WAS	<b>0 445 010 322</b>	<b>0 986 437 374</b>
			Mot.-Nr...41581598→	05.13-08.15	WAS	<b>0 445 010 322</b>	<b>0 986 437 374</b>
BlueTec 4MATIC [222]	3,0	185-190	OM 642.867 <D 30>	02.14-08.15	WAS	<b>0 445 010 322</b>	<b>0 986 437 374</b>
			Mot.-Nr...41581598→	02.14-08.15	WAS	<b>0 445 010 322</b>	<b>0 986 437 374</b>
d [222]	3,0	190	OM 642.861 <D 30>	09.15→		<b>0 445 010 322</b>	<b>0 986 437 374</b>
d, d 4MATIC [222]	2,9	210	OM 656.929 <DE29 LHD>	05.17→		<b>0 445 010 836</b>	
d 4MATIC [222]	3,0	190	OM 642.867 <D 30>	09.15→		<b>0 445 010 322</b>	<b>0 986 437 374</b>
<b>400 CDI [220]</b>	4,0	184/191	OM 628.960 <DE 40 LA>	06.99-08.05		<b>0 445 010 334</b>	<b>0 986 437 360</b>
d, d 4MATIC [222]	2,9	250	OM 656.929 <DE29 LHD>	05.17→		<b>0 445 010 836</b>	
<b>Vaneo</b>							
<b>1.7 CDI [414]</b>	1,7	55/67	OM 668.914 <DE 17 LA>	02.02-08.05		<b>0 445 010 268</b>	<b>0 986 437 100</b>



**MG**

<b>MG 6</b>							
<b>1.9 DTI</b>	1,8	110		09.12→		<b>0 445 010 377</b>	
<b>ZT 135</b>							
<b>2.0 CDTi</b>	2,0	96	20 4D 2 <M47R>	10.02-05.05		<b>0 445 010 011</b>	<b>0 986 437 006</b>
<b>ZT 190</b>							
<b>2.0 CDT</b>	2,0	85	20 4D 2 <M47R>	10.01-05.05		<b>0 445 010 011</b>	<b>0 986 437 006</b>



<b>ZT-Tourer 135</b>							
2.0 CDTi	2,0	96	20 4D 2 <M47R>		10.02-05.05	0 445 010 011	0 986 437 006
<b>ZT-Tourer 190</b>							
2.0 CDT	2,0	85	20 4D 2 <M47R>		10.01-05.05	0 445 010 011	0 986 437 006

**MINI (BMW)**

<b>Cooper</b>							
1.5 D [F 55]	1,5	85	B37 C15A		10.14-09.16	0 445 010 587	0 986 437 452
					10.16→	0 445 010 767	
D [F 56]	1,5	85	B37 C15A		03.14-09.16	0 445 010 587	0 986 437 452
					10.16→	0 445 010 767	
1.6 D [R 56]	1,6	80	9HZ		03.07-07.10	0 445 010 296	0 986 437 028
		82	N47 C16A		08.10-11.13	0 445 010 554	0 986 437 425
2.0 D, SD [R 56]	2,0	82/100-105	N47 C20A		03.11-11.13	0 445 010 554	0 986 437 425
SD [F 55]	2,0	120-125	B47 C20A		10.14-09.16	0 445 010 587	0 986 437 452
					10.16→	0 445 010 767	
SD [F 56]	2,0	120-125	B47 C20A		07.14-09.16	0 445 010 587	0 986 437 452
					10.16→	0 445 010 767	
<b>Cooper Cabrio</b>							
1.5 D [F 57]	1,5	85	B37 C15A		03.16-09.16	0 445 010 587	0 986 437 452
					10.16→	0 445 010 767	
1.6 D [R 57]	1,6	82	N47 C16A		09.10-05.15	0 445 010 554	0 986 437 425
2.0 D, SD [R 57]	2,0	82/100-105	N47 C20A		03.11-05.15	0 445 010 554	0 986 437 425
SD [F 57]	2,0	120-125	B47 C20A		03.16-09.16	0 445 010 587	0 986 437 452
					10.16→	0 445 010 767	
<b>Cooper Clubman</b>							
1.6 D [R 55]	1,6	80	9HZ		11.07-07.10	0 445 010 296	0 986 437 028
		82	N47 C16A		09.10-06.14	0 445 010 554	0 986 437 425
2.0 D, SD [R 55]	2,0	82/100-105	N47 C20A		03.11-06.14	0 445 010 554	0 986 437 425
D, SD, SD ALL4 [F 54]	2,0	100-110/120-140	B47 C20A		10.15-09.16	0 445 010 587	0 986 437 452
					10.16→	0 445 010 767	
<b>Cooper Clubvan</b>							
1.6 D [R 55]	1,6	82	N47 C16A		02.13-06.14	0 445 010 554	0 986 437 425
2.0 D [R 55]	2,0	82	N47 C20A		02.13-06.14	0 445 010 554	0 986 437 425
<b>Cooper Countryman</b>							
1.6 D, D ALL4 [R 60]	1,6	82	N47 C16A		09.10-10.16	0 445 010 554	0 986 437 425
2.0 D, D ALL4, SD, SD ALL4 [F 60]	2,0	100-110/120-140	B47 C20A		02.17→	0 445 010 767	
D, D ALL4, SD, SD ALL4 [R 60]	2,0	82/100-105	N47 C20A		03.11-10.16	0 445 010 554	0 986 437 425
<b>Cooper Coupé</b>							
2.0 SD [R 58]	2,0	100-105	N47 C20A		09.11-05.15	0 445 010 554	0 986 437 425
<b>Cooper One</b>							
1.5 [F 55]	1,5	70	B37 C15A		11.14-09.16	0 445 010 587	0 986 437 452
					10.16→	0 445 010 767	
D [F 56]	1,5	70	B37 C15A		03.14-09.16	0 445 010 587	0 986 437 452
					10.16→	0 445 010 767	
1.6 D [R 56]	1,6	66	N47 C16A		08.10-11.13	0 445 010 554	0 986 437 425
			9HZ		09.09-07.10	0 445 010 296	0 986 437 028
<b>Cooper One Clubman</b>							
1.5 [F 54]	1,5	85	B37 C15A		11.15-09.16	0 445 010 587	0 986 437 452
					10.16→	0 445 010 767	
1.6 D [R 55]	1,6	66	N47 C16A		09.10-06.14	0 445 010 554	0 986 437 425
<b>Cooper One Countryman</b>							
1.5 D [F 60]	1,5	85	B37 C15A		07.17→	0 445 010 767	
1.6 D [R 60]	1,6	66	N47 C16A		09.10-10.16	0 445 010 554	0 986 437 425
<b>Cooper Paceman</b>							
1.6 D, D ALL4 [R 61]	1,6	82	N47 C16A		03.13-09.16	0 445 010 554	0 986 437 425







◀ MINI

2.0 D, D ALL4, SD, SD ALL4 [R 61]	2,0	82/100-105	N47 C20A	03.13-09.16	0 445 010 554	0 986 437 425
<b>Cooper Roadster</b>						
2.0 SD [R 59]	2,0	100-105	N47 C20A	02.12-04.15	0 445 010 554	0 986 437 425

**NISSAN**

<b>Navara</b>						
3.0 dCi 4x4 [D40]	3,0	170	V9X	05.10-06.14	0 445 010 324	
DCi 4x4 [D40M]	3,0	170	V9X	05.15-→	0 445 010 324	
<b>Pathfinder</b>						
3.0 dCi 4x4 [R51]	3,0	170	V9X	05.10-11.14	0 445 010 324	
<b>Patrol GR</b>						
3.0 dCi 4x4 [Y61]	3,0	118	ZD30DDTI	01.07-03.10	0 445 010 136	0 986 437 031
<b>Qashqai</b>						
2.0 dCi, dCi 4x4 [J10]	2,0	110	M9R	04.07-10.08	0 445 010 170	0 986 437 044
				11.08-12.13	0 445 010 223	0 986 437 044
<b>Qashqai+2</b>						
2.0 dCi, dCi 4x4 [JJ10]	2,0	110	M9R	08.08-10.08	0 445 010 170	0 986 437 044
				11.08-12.13	0 445 010 223	0 986 437 044
<b>X-Trail</b>						
2.0 dCi, dCi 4x4 [T31]	2,0	110/127	M9R	04.07-10.08	0 445 010 170	0 986 437 044
				11.08-04.14	0 445 010 223	0 986 437 044
dCi 4x4 [T31R]	2,0	110/127	M9R	02.10-12.14	0 445 010 223	0 986 437 044

**OPEL**

<b>Agila</b>						
1.3 CDTI [A]	1,3	51	Z 13 DT <Ecotec>	08.03-02.08	0 445 010 278	0 986 437 024
CDTI [B]	1,2	55	Z 13 DTJ	07.08-08.15	0 445 010 278	0 986 437 024
<b>Antara</b>						
2.0 CDTI, CDTI 4x4	2,0	93/110	Z 20 DM; Z 20 DMH	05.06-12.11	0 445 010 332	0 986 437 032
CDTI, CDTI 4x4	2,0	125	B 20 DTH	03.16-12.17	AG 0 445 010 773	
					GS 0 445 010 759	
<b>Astra</b>						
1.3 CDTI [H]	1,2	66	Z 13 DTH <Ecotec>	08.05-03.10	0 445 010 293	0 986 437 036
CDTI [J]	1,2	66-70	A 13 DTE <ecoFLEX>	09.09-→	SSJ 0 445 010 293	0 986 437 036
					SSJ 0 445 010 381	0 986 437 072
1.7 CDTI [G]	1,7	59	Z 17 DTL <Turbo Ecotec>	03.03-01.04	0 445 010 086	0 986 437 317
CDTI [H]	1,7	59/74	Z 17 DTH; Z 17 DTL <Turbo Ecotec>	03.04-08.09	0 445 010 086	0 986 437 317
1.9 CDTI [H]	1,9	74/88	Z 19 DT <Ecotec>; Z 19 DTJ <Turbo Ecotec>;	04.04-03.10	LLE 0 445 010 288	0 986 437 025
			Z 19 DTL <Ecotec>		RLE 0 445 010 287	0 986 437 026
		110	Z 19 DTH <Ecotec>	04.04-03.10	LLE 0 445 010 288	0 986 437 025
			Mot.-Nr. →17579269	04.04-03.10	RLE 0 445 010 287	0 986 437 026
			Mot.-Nr. 17579270-→	04.04-03.10	RLE 0 445 010 441	0 986 437 047
2.0 CDTI [J]	2,0	118/121	A 20 DTH <ecoFlex>	09.09-→	SSJ 0 445 010 441	0 986 437 047
					SSJ 0 445 010 443	0 986 437 027
		143	A 20 DTR <Ecotec>	08.12-→	0 445 010 550	
<b>Astra Cabrio</b>						
1.7 CDTI [G]	1,7	59	Z 17 DTL <Turbo Ecotec>	03.03-08.05	0 445 010 086	0 986 437 317
<b>Astra Caravan</b>						
1.3 CDTI [H]	1,2	66	Z 13 DTH <Ecotec>	08.05-03.10	0 445 010 293	0 986 437 036
1.7 CDTI [G]	1,7	59	Z 17 DTL <Turbo Ecotec>	03.03-07.09	0 445 010 086	0 986 437 317
CDTI [H]	1,7	59/74	Z 17 DTH; Z 17 DTL <Turbo Ecotec>	08.04-08.09	0 445 010 086	0 986 437 317
1.9 CDTI [H]	1,9	74/88	Z 19 DT <Ecotec>; Z 19 DTL <Ecotec>	09.05-07.10	LLE 0 445 010 288	0 986 437 025
					RLE 0 445 010 287	0 986 437 026
		88	Z 19 DTJ <Turbo Ecotec>	08.04-03.10	LLE 0 445 010 288	0 986 437 025
					RLE 0 445 010 287	0 986 437 026
		110	Z 19 DTH <Ecotec>	09.04-03.10	LLE 0 445 010 288	0 986 437 025
			Mot.-Nr. →17579269	09.04-03.10	RLE 0 445 010 287	0 986 437 026
			Mot.-Nr. 17579270-→	09.04-03.10	RLE 0 445 010 441	0 986 437 047



<b>Astra Coupé</b>										
1.7 CDTI [G]	1,7	59	Z 17 DTL <Turbo Ecotec>	03.03-02.05		0 445 010 086	0 986 437 317			
<b>Astra GTC</b>										
1.3 CDTI [H]	1,2	66	Z 13 DTH <Ecotec>	06.05-02.09		0 445 010 293	0 986 437 036			
1.7 CDTI [H]	1,7	59/74	Z 17 DTH; Z 17 DTL <Turbo Ecotec>	03.05-08.09		0 445 010 086	0 986 437 317			
1.9 CDTI [H]	1,9	74	Z 19 DTL <Ecotec>	07.05-07.10	LLE	0 445 010 288	0 986 437 025			
					RLE	0 445 010 287	0 986 437 026			
	88	Z 19 DT <Ecotec>	07.05-07.10	LLE	0 445 010 288	0 986 437 025				
				RLE	0 445 010 287	0 986 437 026				
			Z 19 DTJ <Turbo Ecotec>	03.05-03.08	LLE	0 445 010 288	0 986 437 025			
					RLE	0 445 010 287	0 986 437 026			
	110	Z 19 DTH <Ecotec>	03.05-09.09	LLE	0 445 010 288	0 986 437 025				
		Mot.-Nr. →17579269	03.05-09.09	RLE	0 445 010 287	0 986 437 026				
		Mot.-Nr. 17579270→	03.05-09.09	RLE	0 445 010 441	0 986 437 047				
2.0 CDTI [J]	2,0	96	Z 20 DTJ	03.12→		0 445 010 387				
			121	A 20 DTH <ecoFlex>	09.11→	SSJ	0 445 010 441	0 986 437 047		
						SSJ	0 445 010 443	0 986 437 027		
	143	A 20 DTR <Ecotec>	08.12→			0 445 010 550				
<b>Astra Sports Tourer</b>										
1.3 CDTI [J]	1,2	67-70	A 13 DTE <ecoFLEX>	09.10→	SSJ	0 445 010 293	0 986 437 036			
					SSJ	0 445 010 381	0 986 437 072			
2.0 CDTI [J]	2,0	96	Mot.-Nr. →17D20229	06.15→		0 445 010 387				
			Mot.-Nr. 17D20230→	06.15→		0 445 010 445				
			118/121	A 20 DTH <ecoFlex>	09.10→	SSJ	0 445 010 441	0 986 437 047		
						SSJ	0 445 010 443	0 986 437 027		
	143	A 20 DTR <Ecotec>	08.12→			0 445 010 550				
<b>Astra TwinTop</b>										
1.9 CDTI [H]	1,9	110	Z 19 DTH <Ecotec>	09.05-10.10	LLE	0 445 010 288	0 986 437 025			
			Mot.-Nr. →17579269	09.05-10.10	RLE	0 445 010 287	0 986 437 026			
			Mot.-Nr. 17579270→	09.05-10.10	RLE	0 445 010 441	0 986 437 047			
<b>Cascada</b>										
2.0 CDTI	2,0	121	A 20 DTH <ecoFlex>	03.13→	AG	0 445 010 441	0 986 437 047			
					GS	0 445 010 443	0 986 437 027			
				125	B 20 DTH	09.15→		0 445 010 759		
	143	A 20 DTR <Ecotec>	03.13→			0 445 010 550				
<b>Combo</b>										
1.3 [D]	1,3	70		07.16→	TW	0 445 010 310	0 986 437 038			
						0 445 010 425	0 986 437 097			
CDTI [C]	1,3	51/55	Y 13 DT <Ecotec>; Z 13 DT <Ecotec>; Z 13 DTJ <Ecotec>	09.04-01.12		0 445 010 278	0 986 437 024			
CDTI [D]	1,2	66	A 13 FD <ecoFLEX>	02.12→	TW	0 445 010 310	0 986 437 038			
						0 445 010 425	0 986 437 097			
1.6 CDTI [D]	1,6	66	A 16 FDL <ecoFLEX>	02.12→	EU5	0 445 010 305	0 986 437 094			
					5PL,EU6	0 445 010 466	0 986 437 095			
				70/88		10.15→	EU5	0 445 010 305	0 986 437 094	
					5PL,EU6		0 445 010 466	0 986 437 095		
				74/77	A 16 FDH <ecoFLEX>	02.12→	EU5	0 445 010 305	0 986 437 094	
			5PL,EU6		0 445 010 466	0 986 437 095				
2.0 CDTI [D]	2,0	99	A 20 FD <ecoFLEX>	02.12→	EU6	0 445 010 466	0 986 437 095			
					5PL,EU5	0 445 010 305	0 986 437 094			
<b>Corsa</b>										
1.3 [E]	1,2	55/70	B 13 DTC; B 13 DTE; B 13 DTR	10.14→		0 445 010 425	0 986 437 097			
CDTI [C]	1,3	51/55	Y 13 DT <Ecotec>; Z 13 DT <Ecotec>; Z 13 DTJ <Ecotec>	09.03-09.06		0 445 010 278	0 986 437 024			
CDTI [D]	1,2	55	A 13 DTC <Ecotec>	01.11-08.14	SSJ	0 445 010 381	0 986 437 072			
					Fg.-Nr. D4000001→D6000001→	01.11-08.14	SSJ	0 445 010 293	0 986 437 036	
					Fg.-Nr. →C4999999→C6999999	01.11-08.14	SSJ	0 445 010 278	0 986 437 024	
					Z 13 DTJ <Ecotec>	07.06-06.10		0 445 010 278	0 986 437 024	
					66	A 13 DTH <Ecotec>; Z 13 DTH <Ecotec>	07.06-07.10		0 445 010 293	0 986 437 036
					70	A 13 DT...; Z 13 DTE	12.09-08.14	SSJ	0 445 010 293	0 986 437 036
					SSJ	0 445 010 381	0 986 437 072			





◀ OPEL

Insignia										
2.0 CDTI [A]	2,0	81	A 20 DT... <Ecotec>	09.08-12.17	SSJ	0 445 010 441	0 986 437 047			
						SSJ	0 445 010 443	0 986 437 027		
			88/103	A 20 DTE	09.13-12.17	SSJ	0 445 010 441	0 986 437 047		
		2,0	118	A 20 DT... <ecoFlex>	09.08-12.17	SSJ	0 445 010 441	0 986 437 047		
						SSJ	0 445 010 443	0 986 437 027		
	CDTI, CDTI 4x4 [A]			A 20 DTH <ecoFlex>	09.08-12.17		0 445 010 445			
			125 B 20 DTH	01.15-12.17		0 445 010 759				
			140-143 A 20 DTR <Ecotec>							
			Fg.-Nr. D1000001→	07.09-12.17		0 445 010 550				
			Fg.-Nr. →C1999999	07.09-12.17		0 445 010 550				
Insignia Grand Sport										
2.0 , 4x4 [B]	2,0	125/154	<LFO>; <LFS>	03.17→		0 445 010 759				
Insignia Sports Tourer										
2.0 , 4x4 [B]	2,0	125/154	<LFO>; <LFS>	03.17→		0 445 010 759				
CDTI [A]	2,0	81	A 20 DT... <Ecotec>	02.09-12.17	SSJ	0 445 010 441	0 986 437 047			
						SSJ	0 445 010 443	0 986 437 027		
			88/103	A 20 DTE	09.13-12.17	SSJ	0 445 010 441	0 986 437 047		
		2,0	118	A 20 DT... <ecoFlex>	02.09-12.17	SSJ	0 445 010 441	0 986 437 047		
						SSJ	0 445 010 443	0 986 437 027		
	CDTI, CDTI 4x4 [A]			A 20 DTH <ecoFlex>	02.09-12.17	SSJ	0 445 010 441	0 986 437 047		
			140-143 A 20 DTR <Ecotec>							
			Fg.-Nr. D1000001→	07.09-12.17		0 445 010 550				
			Fg.-Nr. →C1999999	07.09-12.17		0 445 010 550				
Meriva										
1.3 CDTI [A]	1,3	51/55	Y 13 DT <Ecotec>; Z 13 DT <Ecotec>; Z 13 DTJ <Ecotec>	09.03-03.10		0 445 010 278	0 986 437 024			
			CDTI [B]	1,2	55	A 13 DTC <Ecotec>				
			Fg.-Nr. A4192110→	04.10-12.17		0 445 010 293	0 986 437 036			
			Fg.-Nr. →A4192109	04.10-12.17		0 445 010 278	0 986 437 024			
			70 A 13 DTE <ecoFLEX>	04.10-12.17	SSJ	0 445 010 293	0 986 437 036			
					SSJ	0 445 010 381	0 986 437 072			
Omega										
2.5 DTI Turbo [B]	2,5	110	Y 25 TD	06.01-09.03		0 445 010 009	0 986 437 004			
Signum										
1.9 CDTI	1,9	74	Z 19 DTL <Ecotec>	08.05-09.08	LLE	0 445 010 288	0 986 437 025			
						RLE	0 445 010 287	0 986 437 026		
			88	Z 19 DT <Ecotec>	04.04-09.08	LLE	0 445 010 288	0 986 437 025		
		110	Z 19 DTH <Ecotec>			RLE	0 445 010 287	0 986 437 026		
					LLE	0 445 010 288	0 986 437 025			
					RLE	0 445 010 287	0 986 437 026			
			Mot.-Nr. →17579269	04.04-09.08	RLE	0 445 010 287	0 986 437 026			
			Mot.-Nr. 17579270→	04.04-09.08	RLE	0 445 010 441	0 986 437 047			
Tigra TwinTop										
1.3 CDTI [B]	1,3	51	Z 13 DT <Ecotec>	06.04-03.09		0 445 010 278	0 986 437 024			
Vectra										
1.9 CDTI, CDTI GTS [C]	1,9	74/88	Z 19 DT <Ecotec>; Z 19 DTL <Ecotec>	04.04-10.08	LLE	0 445 010 288	0 986 437 025			
						RLE	0 445 010 287	0 986 437 026		
		110	Z 19 DTH <Ecotec>			LLE	0 445 010 288	0 986 437 025		
					RLE	0 445 010 287	0 986 437 026			
			Mot.-Nr. →17579269	04.04-03.08	RLE	0 445 010 287	0 986 437 026			
			Mot.-Nr. 17579270→	04.04-03.08	RLE	0 445 010 441	0 986 437 047			
Vectra Caravan										
1.9 CDTI [C]	1,9	74/88	Z 19 DT <Ecotec>; Z 19 DTL <Ecotec>	04.04-10.08	LLE	0 445 010 288	0 986 437 025			
						RLE	0 445 010 287	0 986 437 026		
		110	Z 19 DTH <Ecotec>			LLE	0 445 010 288	0 986 437 025		
					RLE	0 445 010 287	0 986 437 026			
			Mot.-Nr. →17579269	04.04-03.08	RLE	0 445 010 287	0 986 437 026			
			Mot.-Nr. 17579270→	04.04-03.08	RLE	0 445 010 441	0 986 437 047			
Zafira										
1.9 CDTI [B]	1,9	74	Z 19 DTL <Ecotec>	07.05-03.08	LLE	0 445 010 288	0 986 437 025			
					RLE	0 445 010 287	0 986 437 026			





1.9 CDTi [B]	1,9	88	Z 19 DT <Ecotec>	07.05-12.10	LLE	0 445 010 288	0 986 437 025	
					RLE	0 445 010 287	0 986 437 026	
			110	Z 19 DTH <Ecotec>	07.05-12.10	LLE	0 445 010 288	0 986 437 025
				Mot.-Nr. →17579269	07.05-12.10	RLE	0 445 010 287	0 986 437 026
			Mot.-Nr. 17579270→	07.05-12.10	RLE	0 445 010 441	0 986 437 047	
2.0 CDTi [C]	2,0	81	A 20 DTL <Ecotec>	01.12→		0 445 010 441	0 986 437 047	
			96	A 20 DT <ecoFlex>	01.12→	SSJ	0 445 010 441	0 986 437 047
						SSJ	0 445 010 443	0 986 437 027
				Z 20 DTJ	03.12→	TW	0 445 010 387	
							0 445 010 445	
			96/125	B 20 DTH; B 20 DTJ	02.15→		0 445 010 759	
			121	A 20 DTH <ecoFlex>	01.12→	SSJ	0 445 010 441	0 986 437 047
			SSJ	0 445 010 443	0 986 437 027			
143	A 20 DTR <Ecotec>	08.12→		0 445 010 550				

PEUGEOT

**Bipper**

1.3 HDi [A9]	1,3	59	FHY <F 13DTE6>	09.15→		0 445 010 425	0 986 437 097
1.4 HDi [A9]	1,4	50	8HS <DV4TED>	02.08→		0 445 010 296	0 986 437 028

**Expert**

1.6 BlueHdi [K0]	1,6	70/85	BHS <DV6FDU>; BHV <DV6FDU>; BHX <DV6FCU>	02.16→		0 445 010 738	0 986 437 445	
HDi [G9]	1,6	66	9HH <DV6DU M>; 9HM <DV6U C>	12.10→		0 445 010 552	0 986 437 430	
			9HU <DV6UTED4>	02.07→		0 445 010 296	0 986 437 028	
2.0 HDi [U64]	2,0	70	RHX <DW10BTED>					
				Org.-Nr. →9008	10.99-07.01		0 445 010 010	0 986 437 005
				Org.-Nr. 9009→10558	08.01-10.05		0 445 010 046	0 986 437 017
				Org.-Nr. 10559→	11.05-01.07		0 445 010 132	0 986 437 018
			80	RHZ <DW10ATED>				
				Org.-Nr. →9008	10.99-07.01		0 445 010 010	0 986 437 005
				Org.-Nr. 9009→	08.01-01.07		0 445 010 046	0 986 437 017
81	RHW <DW10ATED4/L4>	06.00-01.07		0 445 010 021	0 986 437 012			

**Partner**

1.6 BlueHdi [B9]	1,6	55/73/88	BHW <DV6FE>; BHY <DV6FD>; BHZ <DV6FC>	12.14→		0 445 010 738	0 986 437 445	
HDi [B9]	1,6	55/66/68	9HF <DV6DTE4>; 9HJ <DV6DTE4 M>;	07.10-04.15		0 445 010 552	0 986 437 430	
			9HK <DV6ETED M>; 9HN <DV6ETED4>;					
			9HP <DV6DTE4>					
		55/66/80-	9HS <DV6TED4BU/FAP>; 9HT <DV6B/DV6BUTED4>;	05.08-02.12		0 445 010 296	0 986 437 028	
		81	9HV <DV6TED4/FAP>; 9HX <DV6ATED4/DV6AUTED4>;					
			9HZ <DV6TED4/FAP>					
HDi [M5]	1,6	55/66	9HW <DV6BTED4>; 9HX <DV6ATED4>	07.05-10.11		0 445 010 296	0 986 437 028	
2.0 HDi [M4]	2,0	66	RHY <DW10TD>					
				Org.-Nr. →8994	12.99-06.01	BO	0 445 010 010	0 986 437 005
				Org.-Nr. 8995→	07.01-08.02	BO	0 445 010 046	0 986 437 017
HDi	2,0	66	DW10TD	05.02-08.06		0 445 010 010	0 986 437 005	

**Traveller**

1.6 BlueHdi [K0]	1,6	70/85	BHS <DV6FDU>; BHV <DV6FDU>; BHX <DV6FCU>	03.16→		0 445 010 738	0 986 437 445
------------------	-----	-------	--	--------	--	---------------	---------------

**206**

1.4 HDi [T1]	1,4	50	8H... <DV4TD>					
				Org.-Nr. →10100	09.01-06.04		0 445 010 042	0 986 437 309
				Org.-Nr. 10101→	07.04-02.09		0 445 010 296	0 986 437 028
HDi 16V [T1]	1,4	50	8H... <DV4TD>	09.08-12.10		0 445 010 296	0 986 437 028	
1.6 HDi [T1]	1,6	80	9H... <DV6TED4>					
				Org.-Nr. →10247	05.04-11.04		0 445 010 089	0 986 437 322
				Org.-Nr. 10248→	12.04-03.07		0 445 010 296	0 986 437 028
2.0 HDi [T1]	2,0	66	RHY <DW10TD>					
				Org.-Nr. →8945	04.99-05.01		0 445 010 010	0 986 437 005
				Org.-Nr. 8946→10262	06.01-12.04		0 445 010 046	0 986 437 017
				Org.-Nr. 10263→	01.05-10.05		0 445 010 132	0 986 437 018

**206+**

1.4 HDi [T3E]	1,4	50	8HR <DV4C>	06.10-05.13		0 445 010 552	0 986 437 430
				8HZ <DV4TD>	03.09-05.10		0 445 010 296





◀ PEUGEOT

206 CC							
1.6 HDi [T1]	1,6	80	9H... <DV6TED4>		06.05-03.07	0 445 010 296	0 986 437 028
206 SW							
1.4 HDi [T1]	1,4	50	8H... <DV4TD>				
			Org.-Nr. →10100		03.02-06.04	0 445 010 042	0 986 437 309
			Org.-Nr. 10101→		07.04-12.06	0 445 010 296	0 986 437 028
1.6 HDi [T1]	1,6	80	9H... <DV6TED4>				
			Org.-Nr. →10247		05.04-11.04	0 445 010 089	0 986 437 322
			Org.-Nr. 10248→		12.04-12.06	0 445 010 296	0 986 437 028
2.0 HDi [T1]	2,0	66	RHY <DW10TD>				
			Org.-Nr. →10262		03.02-12.04	0 445 010 046	0 986 437 017
			Org.-Nr. 10263→		01.05-10.05	0 445 010 132	0 986 437 018
207							
1.4 HDi [A7]	1,4	50	8HR <DV4C>		05.10-12.11	0 445 010 552	0 986 437 430
			8HZ <DV4TD>		05.06-04.10	0 445 010 296	0 986 437 028
1.6 HDi [A7]	1,6	66/80	9H... <DV6TED4>; 9HV <DV6TED4/FAP>; 9HX <DV6ATED4>		05.06-04.11	0 445 010 296	0 986 437 028
		68	9HP <DV6DTED>		04.10-04.12	0 445 010 552	0 986 437 430
207+							
1.4 HDi	1,4	50	8HR <DV4C>		11.12-06.15	0 445 010 552	0 986 437 430
207 CC							
1.6 HDi [A7]	1,6	80	9H... <DV6TED4>		03.07-02.11	0 445 010 296	0 986 437 028
207 SW							
1.6 HDi [A7]	1,6	66/80	9H... <DV6TED4>; 9HV <DV6TED4/FAP>; 9HX <DV6ATED4>		06.07-04.11	0 445 010 296	0 986 437 028
		68	9HP <DV6DTED>		04.10-07.13	0 445 010 552	0 986 437 430
208							
1.4 HDi	1,4	50	8H... <DV4C>		01.12-04.15	0 445 010 552	0 986 437 430
1.5 BlueHDi	1,5	75	YHY <DV5RD>		10.17→	0 445 010 760	
1.6 BlueHDi, HDi	1,6	55/68-73/ 85/88	BHW <DV6FE>; BHX <DV6FC>; BHY <DV6FD>; BHZ <DV6FC>		03.14→	0 445 010 738	0 986 437 445
HDi	1,6	55/68	9HJ <DV6DTED M>; 9HK <DV6ETED M>; 9HP <DV6DTED>		01.12→	0 445 010 552	0 986 437 430
301							
1.6 Blue HDi [M3]	1,6	73	BHY <DV6FD>		04.15→	0 445 010 738	0 986 437 445
HDi [M3]	1,6	68	9HJ <DV6DTED M>; 9HP <DV6DTED>		09.12→	0 445 010 552	0 986 437 430
306							
2.0 HDi [N5]	2,0	66	RHY <DW10TD>				
			Org.-Nr. →9015		06.99-07.01	0 445 010 010	0 986 437 005
			Org.-Nr. 9016→		08.01-10.03	0 445 010 046	0 986 437 017
306 Break							
2.0 HDi [N5]	2,0	66	RHY <DW10TD>				
			Org.-Nr. →9015		06.99-07.01	0 445 010 010	0 986 437 005
			Org.-Nr. 9016→		08.01-03.02	0 445 010 046	0 986 437 017
307							
1.4 HDi [T5]	1,4	50	8HZ <DV4TD>				
			Org.-Nr. →10100		10.01-06.04	0 445 010 042	0 986 437 309
			Org.-Nr. 10101→		07.04-05.05	0 445 010 296	0 986 437 028
1.6 HDi [T5]	1,6	66	9HX <DV6ATED4>		02.04-05.05	0 445 010 296	0 986 437 028
		80	9H... <DV6TED4>				
			Org.-Nr. →10191		02.04-10.04	0 445 010 089	0 986 437 322
			Org.-Nr. 10192→		11.04-05.05	0 445 010 296	0 986 437 028
HDi [T6]	1,6	66/80	9H... <DV6TED4>; 9HV <DV6TED4/FAP>; 9HX <DV6ATED4>		06.05-08.07	0 445 010 296	0 986 437 028
2.0 HDi [T5]	2,0	66	RHY <DW10TD>				
			Org.-Nr. →8973		08.00-06.01 BO	0 445 010 010	0 986 437 005
			Org.-Nr. 8974→10264		07.01-12.04 BO	0 445 010 046	0 986 437 017
			Org.-Nr. 10265→		01.05-05.05 BO	0 445 010 132	0 986 437 018
		79	RHS <DW10ATED/FAP>				
			Org.-Nr. →10262		03.02-12.04	0 445 010 046	0 986 437 017
			Org.-Nr. 10263→		01.05-05.05	0 445 010 132	0 986 437 018





307 Break/SW									
1.4 HDi [T5]	1,4	50	8HZ <DV4TD>						
			Org.-Nr. →10100		03.02-06.04			0 445 010 042	0 986 437 309
			Org.-Nr. 10101→		07.04-05.05			0 445 010 296	0 986 437 028
1.6 HDi [T5]	1,6	66	9HX <DV6ATED4>		02.04-05.05			0 445 010 296	0 986 437 028
		80	9H... <DV6TED4>						
			Org.-Nr. →10191		02.04-10.04			0 445 010 089	0 986 437 322
			Org.-Nr. 10192→		11.04-05.05			0 445 010 296	0 986 437 028
HDi [T6]	1,6	66/80	9H... <DV6TED4>; 9HV <DV6TED4/FAP>; 9HX <DV6ATED4>		06.05-05.08			0 445 010 296	0 986 437 028
2.0 HDi [T5]	2,0	66	RHY <DW10TD>						
			Org.-Nr. →10264		03.02-12.04	BO		0 445 010 046	0 986 437 017
			Org.-Nr. 10265→		01.05-05.05	BO		0 445 010 132	0 986 437 018
		79	RHS <DW10ATED/FAP>						
			Org.-Nr. →10262		03.02-12.04			0 445 010 046	0 986 437 017
			Org.-Nr. 10263→		01.05-05.05			0 445 010 132	0 986 437 018
308									
1.5 BlueHdi [T9]	1,5	96	YHZ <DV5RC>		06.17→			0 445 010 760	
1.6 Blue HDi [T9]	1,6	73/85/88	BH... <DV6FC>; BHX <DV6FC>; BHY <DV6FD>		01.14→			0 445 010 578	0 986 437 445
HDi [T7]	1,6	66/80	9H... <DV6TED4>; 9HV <DV6TED4/FAP>; 9HX <DV6ATED4>		09.07-03.10			0 445 010 296	0 986 437 028
		68	9HJ <DV6DTED M>; 9HP <DV6DTED>		04.10-06.13			0 445 010 552	0 986 437 430
HDi [T9]	1,6	68	9HP <DV6DTED>		07.13→			0 445 010 552	0 986 437 430
308 SW									
1.5 BlueHdi [T9]	1,5	96	YHZ <DV5RC>		06.17→			0 445 010 760	
1.6 Blue HDi [T9]	1,6	73/85/88	BH... <DV6FC>; BHX <DV6FC>; BHY <DV6FD>		01.14→			0 445 010 578	0 986 437 445
HDi [T7]	1,6	66/80	9H... <DV6TED4>; 9HV <DV6TED4/FAP>; 9HX <DV6ATED4>		05.08-03.10			0 445 010 296	0 986 437 028
		68	9HJ <DV6DTED M>; 9HP <DV6DTED>		06.10-01.14			0 445 010 552	0 986 437 430
HDi [T9]	1,6	68	9HP <DV6DTED>		01.14→			0 445 010 552	0 986 437 430
406									
2.0 HDi [D8]	2,0	80	RHZ <DW10ATED>		10.98-03.99			0 445 010 010	0 986 437 005
HDi [D9]	2,0	66	RHY <DW10TD>						
			Org.-Nr. →8945		04.99-05.01	BO		0 445 010 010	0 986 437 005
			Org.-Nr. 8946→		06.01-06.04	BO		0 445 010 046	0 986 437 017
		79	RHS <DW10ATED/FAP>		08.01-06.04			0 445 010 046	0 986 437 017
		80	RHZ <DW10ATED>						
			Org.-Nr. →8945		04.99-05.01			0 445 010 010	0 986 437 005
			Org.-Nr. 8946→		06.01-06.04			0 445 010 046	0 986 437 017
2.2 HDi [D9]	2,2	98	4HX <DW12TED4>		03.00-06.04			0 445 010 021	0 986 437 012
406 Break									
2.0 HDi [D8]	2,0	80	RHZ <DW10ATED>		10.98-03.99			0 445 010 010	0 986 437 005
HDi [D9]	2,0	66	RHY <DW10TD>						
			Org.-Nr. →8945		04.99-05.01	BO		0 445 010 010	0 986 437 005
			Org.-Nr. 8946→		06.01-06.04	BO		0 445 010 046	0 986 437 017
		79	RHS <DW10ATED/FAP>		08.01-06.04			0 445 010 046	0 986 437 017
		80	RHZ <DW10ATED>						
			Org.-Nr. →8945		04.99-05.01			0 445 010 010	0 986 437 005
			Org.-Nr. 8946→		06.01-06.04			0 445 010 046	0 986 437 017
2.2 HDi [D9]	2,2	98	4HX <DW12TED4>		03.00-06.04			0 445 010 021	0 986 437 012
406 Coupé									
2.2 HDi [D9]	2,2	98	4HX <DW12TED4>		03.00-02.05			0 445 010 021	0 986 437 012
407									
1.6 HDi [D2]	1,6	80	9H... <DV6TED4>		05.04-02.11	MPR		0 445 010 296	0 986 437 028
			Org.-Nr. →10247		05.04-11.04	MPR		0 445 010 089	0 986 437 322
			Org.-Nr. 10248→		12.04-02.11	MPR		0 445 010 296	0 986 437 028
2.2 HDi [D2]	2,2	120-125	4H... <DW12BTED4>		05.06-07.10			0 445 010 367	0 986 437 034
407 Coupé									
3.0 HDi 24V [D2]	3,0	177	X8Z <DT20C>		07.09-12.11			0 445 010 832	
407 SW									
1.6 HDi [D2]	1,6	80	9H... <DV6TED4>		05.04-02.11	MPR		0 445 010 296	0 986 437 028
			Org.-Nr. →10247		05.04-11.04	MPR		0 445 010 089	0 986 437 322
			Org.-Nr. 10248→		12.04-02.11	MPR		0 445 010 296	0 986 437 028







◀ PEUGEOT

<b>2.2</b> HDi [D2]	2,2	120-125	4H... <DW12BTED4>	09.06-07.10	<b>0 445 010 367</b>	<b>0 986 437 034</b>
<b>508</b>						
<b>1.6</b> BlueHDi [W2]	1,6	85/88	BHX <DV6FC>; BHZ <DV6FC>	10.14→	<b>0 445 010 738</b>	<b>0 986 437 445</b>
<b>2.2</b> HDi [W2]	2,2	150	4HL <DW12C>	10.10→	<b>0 445 010 367</b>	<b>0 986 437 034</b>
<b>508 SW</b>						
<b>1.6</b> BlueHDi [W2]	1,6	85/88	BHX <DV6FC>; BHZ <DV6FC>	10.14→	<b>0 445 010 738</b>	<b>0 986 437 445</b>
<b>2.2</b> HDi [W2]	2,2	150	4HL <DW12C>	10.10→	<b>0 445 010 367</b>	<b>0 986 437 034</b>
<b>607</b>						
<b>2.0</b> HDi [Z8]	2,0	79/80	RHS <DW10ATED/FAP>; RHZ <DW10ATED>	03.00-11.04	<b>0 445 010 046</b>	<b>0 986 437 017</b>
HDi [Z9]	2,0	79	RHS <DW10ATED/FAP>	12.04-12.07	<b>0 445 010 046</b>	<b>0 986 437 017</b>
<b>2.2</b> HDi [Z8]	2,2	98	4HX <DW12TED4>	03.00-11.04	<b>0 445 010 021</b>	<b>0 986 437 012</b>
HDi [Z9]	2,2	98	4HX <DW12TED4>	12.04-12.07	<b>0 445 010 021</b>	<b>0 986 437 012</b>
		125	4H... <DW12BTED4>	05.06-04.09	<b>0 445 010 367</b>	<b>0 986 437 034</b>
<b>806</b>						
<b>2.0</b> HDi [U60]	2,0	80	RHZ <DW10ATED>			
			Org.-Nr. →9008	08.99-07.01	<b>0 445 010 010</b>	<b>0 986 437 005</b>
			Org.-Nr. 9009→	08.01-08.02	<b>0 445 010 046</b>	<b>0 986 437 017</b>
		81	RHW <DW10ATED4/L4>	06.00-08.02	<b>0 445 010 021</b>	<b>0 986 437 012</b>
<b>807</b>						
<b>2.0</b> HDi [V2]	2,0	81	RH... <DW10ATED4/FAP>; RHW <DW10ATED4>	06.02-12.06	<b>0 445 010 021</b>	<b>0 986 437 012</b>
<b>2.2</b> HDi [V2]	2,2	94	4HW <DW12TED4/FAP>	06.02-07.06	<b>0 445 010 021</b>	<b>0 986 437 012</b>
		120-125	4H... <DW12BTED4>	09.07-05.10	<b>0 445 010 367</b>	<b>0 986 437 034</b>
<b>1007</b>						
<b>1.6</b> HDi [A8]	1,6	80	9HZ <DV6TED4>	03.07-02.11	<b>0 445 010 296</b>	<b>0 986 437 028</b>
<b>2008</b>						
<b>1.4</b> HDi [A94]	1,4	50	8H... <DV4C>	03.13→	<b>0 445 010 552</b>	<b>0 986 437 430</b>
<b>1.6</b> BlueHDi, HDi [A94]	1,6	55/73/85/88	BHW <DV6FE>; BHX <DV6FC>; BHY <DV6FD>; BHZ <DV6FC>	03.14→	<b>0 445 010 738</b>	<b>0 986 437 445</b>
HDi [A94]	1,6	68	9HP <DV6DTE4>	03.13→	<b>0 445 010 552</b>	<b>0 986 437 430</b>
<b>3008</b>						
<b>1.5</b> BlueHDi [P84]	1,5	96	YHZ <DV5RC>	10.17→	<b>0 445 010 760</b>	
<b>1.6</b> Blue HDi [T8]	1,6	85/88	BHX <DV6FC>; BHZ <DV6FC>	03.14-12.16	<b>0 445 010 738</b>	<b>0 986 437 445</b>
BlueHDi [P84]	1,6	85/88/100	BHX <DV6FC>; BHY <DV6FD>; BHZ <DV6FC>	07.16→	<b>0 445 010 738</b>	<b>0 986 437 445</b>
HDi [T8]	1,6	80	9HZ <DV6TED4/FAP>	05.09-12.16	<b>0 445 010 296</b>	<b>0 986 437 028</b>
<b>4007</b>						
<b>2.2</b> HDi 4x4 [I3]	2,2	115	4HK <DW12ME5>; 4HN <DW12METED4/FAP>	09.07-11.12	<b>0 445 010 367</b>	<b>0 986 437 034</b>
<b>5008</b>						
<b>1.5</b> BlueHDi [P87]	1,5	96	YHZ <DV5RC>	10.17→	<b>0 445 010 760</b>	
<b>1.6</b> Blue HDi [P87]	1,6	73/85/88	BHX <DV6FC>; BHY <DV6FD>; BHZ <DV6FC>	01.17→	<b>0 445 010 738</b>	<b>0 986 437 445</b>
HDi [T8]	1,6	80	9HZ... <DV6TED4/FAP>	09.09-12.10	<b>0 445 010 296</b>	<b>0 986 437 028</b>
		85/88	BHX <DV6FC>; BHZ <DV6FC>	03.14→	<b>0 445 010 738</b>	<b>0 986 437 445</b>



**PIAGGIO**

<b>Porter</b>						
<b>1.2</b> D	1,2	47	P120	01.11→	<b>0 445 020 143</b>	
<b>Porter Maxxi</b>						
<b>1.2</b> D	1,2	47	P120	01.11→	<b>0 445 020 143</b>	

**PORSCHE**

<b>Cayenne</b>						
<b>3.0</b> Diesel [92A]	3,0	155/180/184/193	MCR.CA <D43>; MCR.CB <D51, D59>; MCV.VA <DD7>; MCV.VB <D51>; MCV.VC <D1V>	06.11-08.17	<b>0 445 010 676</b>	<b>0 986 437 435</b>
		176	M05.9E			
			Mot.-Nr. CAS 135 906→	09.10-08.11	<b>0 445 010 685</b>	<b>0 986 437 404</b>
<b>Cayenne S</b>						
<b>4.2</b> [92A]	4,1	283	MCU.DC <DD8>	09.14→	<b>0 445 010 675</b>	<b>0 986 437 418</b>
	4,2	281-285	MCU.DB	09.12-08.14	<b>0 445 010 675</b>	<b>0 986 437 418</b>



<b>Cayenne S4</b>						
3.0 Diesel [92A]	3,0	180	MCN.RB <D50>		09.11→	0 445 010 676 0 986 437 435
<b>Macan S</b>						
3.0 Diesel [95B]	3,0	155/184/190	MCT.BA <DD7>; MCT.BB <D1V>; MCT.BC		03.14→	0 445 010 676 0 986 437 435
		176	MCN.RB <D50>; MCP.NB <D50>		09.15→	0 445 010 676 0 986 437 435
		180	MCD.UJ <D43>		03.14→	0 445 010 682 0 986 437 454
<b>Panamera</b>						
3.0 Diesel [970]	3,0	155/185	MCR.CB <D51, D59>; MCR.CC <D51, D59>		08.11-08.16	0 445 010 676 0 986 437 435
		221	MCW.JA <DJ5>		07.13-10.16	0 445 010 690 0 986 437 463
<b>Panamera Sport Turismo 4S</b>						
4.0 Diesel [971]	4,0	310	MDB.U... <DJ7>		03.17→	0 445 010 826
<b>Panamera 4S</b>						
4.0 Diesel [971]	4,0	310	MDB.U... <DJ7>		11.16→	0 445 010 826

## RENAULT

<b>Avantime</b>						
2.2 DCI [XEO]	2,2	110	G9T 712		12.01-12.03	0 445 010 033 0 986 437 302
<b>Captur</b>						
1.5 dCi [J5]	1,5	66	K9K 62...		03.15→	0 445 010 704 0 986 437 442
			K9K 608		01.13-07.13	0 445 010 530 0 986 437 439
					08.13→	0 445 010 704 0 986 437 442
			K9K 609		01.13-07.13	0 445 010 530 0 986 437 439
					08.13→	0 445 010 704 0 986 437 442
<b>Clio IV</b>						
1.5 dCi [BH]	1,5	55	K9K 612		05.12-07.13	0 445 010 530 0 986 437 439
					08.13→	0 445 010 704 0 986 437 442
		66	K9K 60...		05.12-07.13	0 445 010 530 0 986 437 439
					08.13→	0 445 010 704 0 986 437 442
			K9K 62...		01.16→	0 445 010 704 0 986 437 442
<b>Clio IV Grandtour</b>						
1.5 dCi [KH]	1,5	55	K9K 612		11.12-07.13	0 445 010 530 0 986 437 439
					08.13→	0 445 010 704 0 986 437 442
		55/66	K9K 62...; K9K 628		01.16→	0 445 010 704 0 986 437 442
		66	K9K 60...		11.12-07.13	0 445 010 530 0 986 437 439
					08.13→	0 445 010 704 0 986 437 442
<b>Duster</b>						
1.5 dCi [HS]	1,5	66	K9K 612		09.13→	0 445 010 704 0 986 437 442
<b>Espace III</b>						
2.2 dCi [JEO]	2,2	85-95	G9T...		07.00-10.02	0 445 010 028 0 986 437 015
<b>Espace IV</b>						
1.9 dCi [JK]	1,9	88	F9Q 680; F9Q 820; F9Q 826		11.02-12.15	0 445 010 075 0 986 437 301
2.0 dCi [JK]	2,0	96/110/127	M9R 8...; M9R 81...; M9R 812		01.12-12.15	0 445 010 223 0 986 437 044
			M9R 740; M9R 760; M9R 761		05.05-12.15	0 445 010 099 0 986 437 355
2.2 dCi [JK]	2,2	102/110	G9T 642; G9T 645		11.02-12.15	0 445 010 081
		110	G9T 742; G9T 743		11.02-12.06	0 445 010 033 0 986 437 302
<b>Espace V</b>						
1.6 dCi 130 [JR]	1,6	96	R9M 409		04.15→	0 445 010 404 0 986 437 070
dCi 160 [JR]	1,6	118	R9M 452		04.15→	0 445 010 406 0 986 437 071
<b>Fluence</b>						
1.6 dCi [L3]	1,6	96	R9M 402		11.12-12.16	0 445 010 404 0 986 437 070
<b>Grand Scenic II</b>						
1.9 dCi [JM]	1,9	81/96	F9Q 803; F9Q 804		05.03-04.09	0 445 010 087
		88	F9Q 812		05.03-04.09	0 445 010 075 0 986 437 301
		96	F9Q 816; F9Q 818		10.07-11.08	0 445 010 218 0 986 437 043
2.0 dCi [JM]	2,0	110	M9R 700; M9R 721; M9R 722		09.04-04.09	0 445 010 099 0 986 437 355
<b>Grand Scenic III</b>						
1.6 dCi [JZ]	1,6	96	R9M 402		03.11-12.16	0 445 010 404 0 986 437 070
1.9 dCi [JZ]	1,9	96	F9Q 870		05.09-12.16	0 445 010 216
			F9Q 872		05.09-12.16	0 445 010 218 0 986 437 043
2.0 dCi [JZ]	2,0	110/118	M9R 610; M9R 615		05.09-12.16	0 445 010 208





◀ RENAULT

Grand Scenic IV								
1.6 dCi [R9]	1,6	96	R9M 409	11.16→	0 445 010 404	0 986 437 070		
		118	R9M 452				11.16→	0 445 010 406
Grans Scenic III								
1.6 dCi [JZ]	1,6	96	R9M 414	02.16-12.16	0 445 010 404	0 986 437 070		
Kadjar								
1.6 dCi 130, dCi 130 4x4 [HL]	1,6	96	R9M 41...	06.15→	0 445 010 404	0 986 437 070		
Kangoo I								
1.9 dCi, dCi 4x4 [FC./KC.]	1,9	59-62	F9Q 790	05.00-12.07	0 445 010 018	0 986 437 010		
Kangoo II								
1.5 dCi [FW/KW]	1,5	55/66	K9K 628	06.15→	0 445 010 704	0 986 437 442		
Koleos								
1.6 dCi [HC]	1,6	96	R9M 4...	09.17→	0 445 010 404	0 986 437 070		
2.0 dCi [HC]	2,0	128	M9R 86...; M9R 868	09.17→	0 445 010 406	0 986 437 071		
				09.13-12.16	0 445 010 223	0 986 437 044		
dCi [HY]	2,0	127	M9R 86...	09.08-10.08	0 445 010 170	0 986 437 044		
dCi, dCi 4x4 [HY]	2,0	110	M9R 832	11.08-12.16	0 445 010 223	0 986 437 044		
				09.08-10.08	0 445 010 170	0 986 437 044		
				11.08-12.16	0 445 010 223	0 986 437 044		
				09.08-10.08	0 445 010 170	0 986 437 044		
dCi 4x4 [HY]	2,0	110	M9R 835	09.08-12.16	0 445 010 223	0 986 437 044		
				09.08-10.08	0 445 010 170	0 986 437 044		
				11.08-12.16	0 445 010 223	0 986 437 044		
dCi 4x4 [HY]	2,0	127	M9R 830	09.08-10.08	0 445 010 170	0 986 437 044		
				11.08-12.16	0 445 010 223	0 986 437 044		
Laguna I								
1.9 dCi [B56]	1,9	80	F9Q 718	09.99-02.01	0 445 010 018	0 986 437 010		
Laguna I Grandtour								
1.9 dCi [K56]	1,9	80	F9Q 718	09.99-02.01	0 445 010 018	0 986 437 010		
Laguna II								
1.9 dCi [BG.]	1,9	68/81/88	F9Q 650; F9Q 664; F9Q 670; F9Q 674; F9Q 750	03.01-09.07	0 445 010 075	0 986 437 301		
		74	F9Q 752; F9Q 754	03.01-09.07	0 445 010 018	0 986 437 010		
		96	F9Q 758; F9Q 759	01.05-09.07	0 445 010 087			
2.0 dCi [BG.]	2,0	110/127	M9R 740; M9R 760	09.04-09.07	0 445 010 099	0 986 437 355		
2.2 dCi [BG.]	2,2	102/110	G9T 600; G9T 605	07.02-09.07	0 445 010 081			
		110	G9T 700; G9T 702; G9T 703; G9T 706; G9T 707	03.01-09.07	0 445 010 033	0 986 437 302		
Laguna II Grandtour								
1.9 dCi [KG.]	1,9	68/81	F9Q 664; F9Q 670; F9Q 674	01.05-09.07	0 445 010 075	0 986 437 301		
		74-79	F9Q 752; F9Q 754	03.01-12.05	0 445 010 018	0 986 437 010		
		88	F9Q 650; F9Q 750	03.01-09.07	0 445 010 075	0 986 437 301		
		96	F9Q 758; F9Q 759	04.04-09.07	0 445 010 087			
2.0 dCi [KG.]	2,0	110/127	M9R 740; M9R 760	09.04-09.07	0 445 010 099	0 986 437 355		
2.2 dCi [KG.]	2,2	102/110	G9T 600; G9T 605	07.02-09.07	0 445 010 081			
		110	G9T 700; G9T 702; G9T 703; G9T 706; G9T 707	03.01-09.07	0 445 010 033	0 986 437 302		
Laguna III								
2.0 dCi [BT]	2,0	96/110	M9R 802	10.07-10.08	0 445 010 170	0 986 437 044		
				11.08-12.16	0 445 010 223	0 986 437 044		
		96/110/127/131	M9R 828; M9R 857; M9R 858	12.11-12.16	0 445 010 250	0 986 437 045		
		110	M9R 742	10.07-12.16	0 445 010 099	0 986 437 355		
			M9R 754	06.09-12.16	0 445 010 223	0 986 437 044		
			M9R 805	10.07-10.08	0 445 010 170	0 986 437 044		
				11.08-12.16	0 445 010 223	0 986 437 044		
		127	M9R 800	10.07-10.08	0 445 010 170	0 986 437 044		
				11.08-12.16	0 445 010 223	0 986 437 044		
				131	M9R 816	02.08-10.08	0 445 010 170	0 986 437 044
				11.08-12.16	0 445 010 223	0 986 437 044		
3.0 dCi [BT]	3,0	173	V9X 891	02.08→	0 445 010 324			
Laguna III Coupé								
2.0 dCi [DT]	2,0	110	M9R 742	02.08-10.08	0 445 010 170	0 986 437 044		
				11.08-12.16	0 445 010 223	0 986 437 044		
					M9R 802	02.08-10.08	0 445 010 170	0 986 437 044
						11.08-12.16	0 445 010 223	0 986 437 044
					M9R 805	02.08-10.08	0 445 010 170	0 986 437 044
						11.08-12.16	0 445 010 223	0 986 437 044
		110/127	M9R 857; M9R 858	12.11-12.16	0 445 010 250	0 986 437 045		





2.0 dCi [DT]	2,0	127	M9R 800	02.08-10.08	0 445 010 170	0 986 437 044	
				11.08-12.16	0 445 010 223	0 986 437 044	
3.0 dCi [DT]	3,0	131	M9R 816	02.08-10.08	0 445 010 170	0 986 437 044	
				11.08-12.16	0 445 010 223	0 986 437 044	
		173	V9X 791; V9X 891	02.08-12.16	0 445 010 324		
<b>Laguna III Grandtour</b>							
2.0 dCi [KT]	2,0	96/110	M9R 802	10.07-10.08	0 445 010 170	0 986 437 044	
				11.08-12.16	0 445 010 223	0 986 437 044	
		110	M9R 858	12.11-12.16	0 445 010 250	0 986 437 045	
				M9R 742	10.07-12.16	0 445 010 099	0 986 437 355
				M9R 805	10.07-10.08	0 445 010 170	0 986 437 044
		127	M9R 8...	11.08-12.16	0 445 010 223	0 986 437 044	
				M9R 800	12.11-12.16	0 445 010 223	0 986 437 044
					10.07-10.08	0 445 010 170	0 986 437 044
					11.08-12.16	0 445 010 223	0 986 437 044
		131	M9R 816	02.08-10.08	0 445 010 170	0 986 437 044	
				11.08-12.16	0 445 010 223	0 986 437 044	
3.0 dCi [KT]	3,0	173	V9X 891	02.08-12.16	0 445 010 324		
<b>Latitude</b>							
2.0 dCi [L7]	2,0	96	M9R 846	02.13-12.16	0 445 010 250	0 986 437 045	
		110	M9R 8...	09.10-12.16	0 445 010 223	0 986 437 044	
		127	M9R 8...	09.10-12.16	0 445 010 223	0 986 437 044	
					0 445 010 250	0 986 437 045	
3.0 dCi [L7]	3,0	177	V9X 891	09.10-12.16	0 445 010 324		
<b>Logan MCV</b>							
1.5 dCi [K8]	1,5	55/66	K9K 612	09.15→	0 445 010 704	0 986 437 442	
<b>Megane I</b>							
1.9 DCI [X64]	1,9	72-75	F9Q 732; F9Q 733; F9Q 738	03.99-10.02	0 445 010 018	0 986 437 010	
<b>Megane I Classic</b>							
1.9 DCI [X64]	1,9	72-75	F9Q 732; F9Q 733; F9Q 738	04.99-09.03	0 445 010 018	0 986 437 010	
<b>Megane I Coupé</b>							
1.9 DCI [X64]	1,9	72-75	F9Q 732; F9Q 733	03.99-10.02	0 445 010 018	0 986 437 010	
<b>Megane I Grandtour</b>							
1.9 DCI [X64]	1,9	72-75	F9Q 732; F9Q 733; F9Q 738	03.99-09.03	0 445 010 018	0 986 437 010	
<b>Megane II</b>							
1.9 dCi [LM]	1,9	68/88	F9Q 800; F9Q 808	10.03-10.09	0 445 010 075	0 986 437 301	
		96	F9Q 803; F9Q 804	09.04-10.09	0 445 010 087		
2.0 dCi [LM]	2,0	110	M9R 700	09.04-10.09	0 445 010 099	0 986 437 355	
<b>Megane II Cabrio</b>							
1.9 dCi [EM]	1,9	88	F9Q 800	10.03-03.10	0 445 010 075	0 986 437 301	
		96	F9Q 803; F9Q 804; F9Q 814	05.04-03.10	0 445 010 087		
2.0 dCi [EM]	2,0	110	M9R 700; M9R 722	09.04-03.10	0 445 010 099	0 986 437 355	
<b>Megane II Grandtour</b>							
1.9 dCi [KM.]	1,9	68/88	F9Q 800; F9Q 808	10.03-05.09	0 445 010 075	0 986 437 301	
		96	F9Q 803; F9Q 804	09.04-05.09	0 445 010 087		
2.0 dCi [KM.]	2,0	110	M9R 700; M9R 722	09.04-05.09	0 445 010 099	0 986 437 355	
<b>Megane II Hatchback</b>							
1.9 dCi [BM./CM./GM./SM.]	1,9	68/88	F9Q 800; F9Q 808	11.02-10.08	0 445 010 075	0 986 437 301	
		96	F9Q 803; F9Q 804	09.04-10.08	0 445 010 087		
			F9Q 816	10.07-10.08	0 445 010 218	0 986 437 043	
2.0 dCi, dCi Sport [BM./CM./GM./SM.]	2,0	110/127	M9R 700; M9R 722; M9R 724	09.04-10.08	0 445 010 099	0 986 437 355	
<b>Megane III CC</b>							
1.6 dCi [EZ]	1,6	96	R9M 402	11.12-12.16	0 445 010 404	0 986 437 070	
1.9 dCi [EZ]	1,9	96	F9Q 870	10.10-12.16	0 445 010 216		
2.0 dCi [EZ]	2,0	118	M9R 610	10.10-12.16	0 445 010 208		
<b>Megane III Coupé</b>							
1.6 dCi [DZ]	1,6	96	R9M 402	01.12-05.13	0 445 010 250	0 986 437 045	
				06.13-12.16	0 445 010 404	0 986 437 070	
1.9 dCi [DZ]	1,9	96	F9Q 870	01.09-12.16	0 445 010 216		
				F9Q 872	01.09-12.16	0 445 010 218	0 986 437 043
2.0 dCi [DZ]	2,0	110/118/120	M9R 610; M9R 615	01.09-12.16	0 445 010 208		





◀ RENAULT

Megane III Grandtour							
1.6 dCi [KZ]	1,6	96	R9M 402		01.12-12.15	0 445 010 404	0 986 437 070
1.9 dCi [KZ]	1,9	96	F9Q 870		06.09-12.15	0 445 010 216	
			F9Q 872		06.09-12.15	0 445 010 218	0 986 437 043
2.0 dCi [KZ]	2,0	110/118/120	M9R 610; M9R 615		06.09-12.15	0 445 010 208	
Megane III Hatchback							
1.6 dCi [BZ]	1,6	96	R9M 402		01.12-12.16	0 445 010 404	0 986 437 070
1.9 dCi [BZ]	1,9	96	F9Q 870		11.08-12.16	0 445 010 216	
			F9Q 872		11.08-12.16	0 445 010 218	0 986 437 043
2.0 dCi [BZ]	2,0	110/118/120	M9R 610; M9R 615		11.08-12.16	0 445 010 208	
Megane IV							
1.6 [B9]	1,6	121	R9M 452		12.15→	0 445 010 406	0 986 437 071
dCi [B9]	1,6	96	R9M 4...		12.15→	0 445 010 404	0 986 437 070
Megane IV Grand Coupé							
1.6 dCi [LV]	1,6	96	R9M 4...		02.17→	0 445 010 404	0 986 437 070
Megane IV Grandtour							
1.6 dCi [B9]	1,6	96	R9M 4...		04.16→	0 445 010 404	0 986 437 070
		121	R9M 452		04.16→	0 445 010 406	0 986 437 071
Scenic I							
1.9 dCi, DCI RX4 [JA]	1,9	75	F9Q 732; F9Q 733; F9Q 738; F9Q 740; F9Q 746; F9Q 748; F9Q 796		06.97-04.03	0 445 010 018	0 986 437 010
Scenic II							
1.9 dCi [JM]	1,9	81/96	F9Q 803; F9Q 804		05.03-04.09	0 445 010 087	
		88	F9Q 812		05.03-04.09	0 445 010 075	0 986 437 301
		96	F9Q 816; F9Q 818		10.07-11.08	0 445 010 218	0 986 437 043
2.0 dCi [JM]	2,0	110	M9R 700; M9R 721; M9R 722		09.04-04.09	0 445 010 099	0 986 437 355
Scenic III							
1.6 dCi [JZ]	1,6	96	R9M 402; R9M 414		03.11-12.16	0 445 010 404	0 986 437 070
1.9 dCi [JZ]	1,9	96	F9Q 870		05.09-12.16	0 445 010 216	
			F9Q 872		05.09-12.16	0 445 010 218	0 986 437 043
2.0 dCi [JZ]	2,0	110/118	M9R 610; M9R 615		05.09-12.16	0 445 010 208	
Scenic IV							
1.6 dCi [J9]	1,6	96	R9M 409		11.16→	0 445 010 404	0 986 437 070
		118	R9M 452		11.16→	0 445 010 406	0 986 437 071
Symbol							
1.5 dCi [L8]	1,5	55/66	K9K 612		03.13-07.13	0 445 010 530	0 986 437 439
					08.13→	0 445 010 704	0 986 437 442
Talisman							
1.6 dCi [LP]	1,6	96	R9M 409		12.15→	0 445 010 404	0 986 437 070
		118	R9M 452		12.15→	0 445 010 406	0 986 437 071
Talisman Grandtour							
1.6 dCi [KP]	1,6	96	R9M 409		03.16→	0 445 010 404	0 986 437 070
		118	R9M 452		03.16→	0 445 010 406	0 986 437 071
Vel Satis							
2.0 DCI [BJ]	2,0	110/127	M9R 760		08.05-12.09	0 445 010 099	0 986 437 355
2.2 DCI [BJ]	2,2	102/110	G9T 600; G9T 606; G9T 607		09.02-12.09	0 445 010 081	
		110	G9T 702; G9T 703		04.02-12.09	0 445 010 033	0 986 437 302



ROVER							
75							
2.0 CDT, CDTi	2,0	85/96	20 4D 2 <M 47 D 20>		01.99-05.05	0 445 010 011	0 986 437 006
75 Tourer							
2.0 CDT, CDTi	2,0	85/96	20 4D 2 <M 47 D 20>		01.01-05.05	0 445 010 011	0 986 437 006



l/ccm



kW/(PS)



Typ



eXchange

## SAAB (SAAB AUTOMOBILE AB)

9-3									
1.9 TID [9440]	1,9	88/110	Z 19 DT; Z 19 DTH		09.04-12.10	LLE	0 445 010 288	0 986 437 025	
						RLE	0 445 010 287	0 986 437 026	
TTiD [9440]	1,9	96/118/132	A19DTR (130); A19DTR (160); Z 19 DTR		02.08-06.12		0 445 010 173		
9-3 Cabriolet									
1.9 TID [9440]	1,9	110	Z 19 DTH		01.06-09.10	LLE	0 445 010 288	0 986 437 025	
						RLE	0 445 010 287	0 986 437 026	
TTiD [9440]	1,9	118/132	A19DTR (160); Z 19 DTR		02.08-06.12		0 445 010 173		
9-3 Kombi									
1.9 TID [9440]	1,9	88	Z 19 DT		03.05-09.10	LLE	0 445 010 288	0 986 437 025	
						RLE	0 445 010 287	0 986 437 026	
		110	Z 19 DTH		03.05-09.10	LLE	0 445 010 288	0 986 437 025	
						RLE	0 445 010 287	0 986 437 026	
TTiD [9440]	1,9	96/118/132	A19DTR (130); A19DTR (160); Z 19 DTR		02.08-06.12		0 445 010 173		
9-3X									
1.9 TTiD [9440]	1,9	132	Z 19 DTR		03.10-06.12		0 445 010 173		
9-5									
1.9 TID [9600]	1,9	110	Z 19 DTH		09.05-02.10	LLE	0 445 010 288	0 986 437 025	
						RLE	0 445 010 287	0 986 437 026	
2.0 TiD4 [650]	2,0	118	A 20 DTH		03.10-06.12	SSJ	0 445 010 371	0 986 437 047	
						SSJ	0 445 010 382	0 986 437 027	
TTiD4, TTiD4 XWD [650]	2,0	140	A 20 DTR		03.10-06.12		0 445 010 550		
9-5 Kombi									
1.9 TID [9600]	1,9	110	Z 19 DTH		01.06-02.10	LLE	0 445 010 288	0 986 437 025	
						RLE	0 445 010 287	0 986 437 026	
		129	Z 19 DTH		01.07-02.10	LLE	0 445 010 184		
						RLE	0 445 010 183	0 986 437 048	

## SEAT

Alhambra									
2.0 TDI, TDI 4Drive [710]	2,0	85/100/103/125/130	CFFA; CFFB <D91>; CFFE <DE4>; CFGB <D93>; CFGC <DE2>		05.10-07.15		0 445 010 567	0 986 437 438	
TDI, TDI 4Drive [711]	2,0	85/110/135	CUVA <DE4>; CUVC <DN4>; CUWA <DK7>; DFLA <DN4>; DFLD <DE4>; DFMA <DK7>		05.15→		0 445 010 570	0 986 437 440	
Altea									
2.0 TDI [5P1]	2,0	103/125	CFHC <D91>; CEQA <D93>		09.10-07.15		0 445 010 565	0 986 437 405	
					03.09-05.10		0 445 010 543	0 986 437 410	
Altea Freerack									
2.0 TDI 4WD [5P5/5P8]	2,0	103/125/125	CFHC <D91>; CFJA <D93>; CEQA <D93>		09.10-07.15		0 445 010 565	0 986 437 405	
					03.09-10.10		0 445 010 543	0 986 437 410	
Altea XL									
2.0 TDI [5P5]	2,0	125	CEQA <D93>		03.09-05.10		0 445 010 543	0 986 437 410	
TDI, TDI 4WD [5P5]	2,0	103	CFHC <D91>		10.10-07.15		0 445 010 565	0 986 437 405	
Ateca									
2.0 TDI, TDI 4Drive [KH7]	2,0	110/140	DFFA <DN4>; DFHA <DE5>		04.16→		0 445 010 570	0 986 437 440	
Exeo									
2.0 TDI [3R2]	2,0	88/105/125	CAGA <D92>; CAGC <D90>; CAHA <D93>; CGLB <D93>; CJCA <D92>; CJCC <D90>		12.08-12.11		0 445 010 543	0 986 437 410	
					01.12-08.13		0 445 010 562	0 986 437 434	
Exeo ST									
2.0 TDI [3R5]	2,0	88/105/125	CAGA <D92>; CAGC <D90>; CAHA <D93>; CGLB <D93>; CJCA <D92>; CJCC <D90>		06.09-12.11		0 445 010 543	0 986 437 410	
					01.12-08.13		0 445 010 562	0 986 437 434	
Ibiza									
2.0 TDI [6J5]	2,0	105	CFHD <D92>		01.10-05.15		0 445 010 565	0 986 437 405	
Ibiza SC									
2.0 TDI [6J1]	2,0	105	CFHD <D92>		01.10-05.15		0 445 010 565	0 986 437 405	





◀ SEAT

Leon										
1.6 TDI [5F1]	1,6	66	CLHB <D36>	11.12-10.14	EU6,TW	0 445 010 570	0 986 437 440			
				11.12-05.15	EU5	0 445 010 570	0 986 437 440			
				PR-Code FM1 PR-Code FM3	05.15-05.15	EU6	0 445 010 570	0 986 437 440		
				CXXA <D36>	05.15-12.16	EU5	0 445 010 570	0 986 437 440		
				PR-Code FM1 PR-Code FM3	05.15-12.16	EU6	0 445 010 570	0 986 437 440		
	66/85		DDYA <DK8>; DDYB <D36>							
				PR-Code FM1 PR-Code FM3	11.16->		0 445 010 583	0 986 437 440		
	77		CLHA <D38>	09.12-10.14	EU6,TW	0 445 010 570	0 986 437 440			
				PR-Code FM1 PR-Code FM3	09.12-05.15	EU5	0 445 010 570	0 986 437 440		
				PR-Code FM1 PR-Code FM3	05.15-05.15	EU6	0 445 010 570	0 986 437 440		
	81		CRKB <DK5>	08.13-10.14	EU6,TW	0 445 010 570	0 986 437 440			
				PR-Code FM1 PR-Code FM3	08.13-10.16	EU5	0 445 010 570	0 986 437 440		
				PR-Code FM1 PR-Code FM3	05.15-10.16	EU6	0 445 010 570	0 986 437 440		
				CXXB <DK5>	11.14-10.16	EU5	0 445 010 570	0 986 437 440		
				PR-Code FM1 PR-Code FM3	05.15-10.16	EU6	0 445 010 570	0 986 437 440		
				DBKA <DK5>	05.15-10.16	EU5	0 445 010 570	0 986 437 440		
				PR-Code FM1 PR-Code FM3	05.15-10.16	EU6	0 445 010 570	0 986 437 440		
	2.0 TDI [1P1]	2,0	103	CFHC <D91>	05.10-05.11		0 445 010 565	0 986 437 405		
				CLCB <D91>	06.11-12.12		0 445 010 568	0 986 437 434		
				125	CEGA <D93>	03.09-12.12		0 445 010 543	0 986 437 410	
				CFJA <D93>	05.10-12.12		0 445 010 551	0 986 437 405		
TDI [5F1]	2,0	81	CRVA <DN1>	08.13-12.16	EU4	0 445 010 583	0 986 437 440			
					EU4	0 445 010 570	0 986 437 440			
			105/110	CKFC <DN4>; CRVC <DN6>	10.12->	EU4	0 445 010 583	0 986 437 440		
						EU4	0 445 010 570	0 986 437 440		
			110	CRMB <DN4>	08.13->	EU4	0 445 010 583	0 986 437 440		
						EU4	0 445 010 570	0 986 437 440		
			135	CUNA <DK7>	08.13->	EU4	0 445 010 583	0 986 437 440		
						EU4	0 445 010 570	0 986 437 440		
				CUPA <DK7>	08.13-12.16	EU4	0 445 010 583	0 986 437 440		
						EU4	0 445 010 570	0 986 437 440		
Leon SC										
1.6 TDI [5F5]	1,6	66	CLHB <D36>	02.13-10.14	EU6,TW	0 445 010 570	0 986 437 440			
				02.13-05.15	EU5	0 445 010 570	0 986 437 440			
				PR-Code FM1 PR-Code FM3	05.15-05.15	EU6	0 445 010 570	0 986 437 440		
				CXXA <D36>	05.15-10.16	EU5	0 445 010 570	0 986 437 440		
				PR-Code FM1 PR-Code FM3	05.15-10.16	EU6	0 445 010 570	0 986 437 440		
	66/85		DDYA <DK8>; DDYB <D36>							
				PR-Code FM1 PR-Code FM3	11.16->		0 445 010 583	0 986 437 440		
	77		CLHA <D38>	02.13-10.14	EU6,TW	0 445 010 570	0 986 437 440			
				PR-Code FM1 PR-Code FM3	02.13-05.15	EU5	0 445 010 570	0 986 437 440		
				PR-Code FM1 PR-Code FM3	05.15-05.15	EU6	0 445 010 570	0 986 437 440		
	81		CRKB <DK5>	08.13-10.14	EU6,TW	0 445 010 570	0 986 437 440			
				PR-Code FM1 PR-Code FM3	08.13-10.16	EU5	0 445 010 570	0 986 437 440		
				PR-Code FM1 PR-Code FM3	05.15-10.16	EU6	0 445 010 570	0 986 437 440		
				CXXB <DK5>	11.14-10.16	EU5	0 445 010 570	0 986 437 440		
				PR-Code FM1 PR-Code FM3	05.15-10.16	EU6	0 445 010 570	0 986 437 440		
				DBKA <DK5>	05.15-10.16	EU5	0 445 010 570	0 986 437 440		
				PR-Code FM1 PR-Code FM3	05.15-10.16	EU6	0 445 010 570	0 986 437 440		
	2.0 TDI [5F5]	2,0	81	CRVA <DN1>	08.13-12.16	EU4	0 445 010 583	0 986 437 440		
						EU4	0 445 010 570	0 986 437 440		
				105	CRVC <DN6>	08.13->	EU4	0 445 010 583	0 986 437 440	
						EU4	0 445 010 570	0 986 437 440		
			110	CKFC <DN4>	02.13-12.16	EU4	0 445 010 583	0 986 437 440		
						EU4	0 445 010 570	0 986 437 440		
				CRMB <DN4>	08.13->	EU4	0 445 010 583	0 986 437 440		
						EU4	0 445 010 570	0 986 437 440		
			135	CUNA <DK7>	08.13->	EU4	0 445 010 583	0 986 437 440		
						EU4	0 445 010 570	0 986 437 440		
			CUPA <DK7>	08.13-12.16	EU4	0 445 010 583	0 986 437 440			
					EU4	0 445 010 570	0 986 437 440			





Leon ST									
1.6 TDI [5F8]	1,6	66	CLHB <D36>	08.13-10.14	EU6,TW	0 445 010 570	0 986 437 440		
				08.13-05.15	EU5	0 445 010 570	0 986 437 440		
				PR-Code FM1 PR-Code FM3	05.15-05.15	EU6	0 445 010 570	0 986 437 440	
			CXXA <D36>	05.15-10.16	EU5	0 445 010 570	0 986 437 440		
			PR-Code FM1 PR-Code FM3	05.15-10.16	EU6	0 445 010 570	0 986 437 440		
	66/85		DDYA <DK8>; DDYB <D36>						
			PR-Code FM1 PR-Code FM3	11.16→			0 445 010 583	0 986 437 440	
	81		CRKB <DK5>	08.13-10.14	EU6,TW	0 445 010 570	0 986 437 440		
				08.13-10.16	EU5	0 445 010 570	0 986 437 440		
			CXXB <DK5>	11.14-10.16	EU5	0 445 010 570	0 986 437 440		
			PR-Code FM1 PR-Code FM3	05.15-10.16	EU6	0 445 010 570	0 986 437 440		
			DBKA <DK5>	05.15-10.16	EU5	0 445 010 570	0 986 437 440		
			PR-Code FM1 PR-Code FM3	05.15-10.16	EU6	0 445 010 570	0 986 437 440		
	TDI, TDI 4Drive [5F8]	1,6	77	CLHA <D38>	08.13-10.14	EU6,TW	0 445 010 570	0 986 437 440	
08.13-05.15					EU5	0 445 010 570	0 986 437 440		
			PR-Code FM1 PR-Code FM3	05.15-05.15	EU6	0 445 010 570	0 986 437 440		
81			CRKB <DK5>						
			PR-Code FM1 PR-Code FM3	05.15-10.16	EU6	0 445 010 570	0 986 437 440		
TDI 4Drive [5F8]		1,6	81	CRKB <DK5>	11.14-10.16	EU5	0 445 010 570	0 986 437 440	
2.0 TDI [5F8]	2,0	81	CRVA <DN1>	08.13-12.16	EU4	0 445 010 583	0 986 437 440		
					EU4	0 445 010 570	0 986 437 440		
	105		CRVC <DN6>	08.13→	EU4	0 445 010 583	0 986 437 440		
					EU4	0 445 010 570	0 986 437 440		
	110		CKFC <DN4>	08.13-12.16	EU4	0 445 010 583	0 986 437 440		
					EU4	0 445 010 570	0 986 437 440		
	135		CUPA <DK7>	08.13-12.16	EU4	0 445 010 583	0 986 437 440		
					EU4	0 445 010 570	0 986 437 440		
	TDI, TDI 4Drive [5F8]	2,0	81/110	CRLD <DN1>; DCYA <DN4>	01.17→		0 445 010 583	0 986 437 440	
					05.14→	EU4	0 445 010 583	0 986 437 440	
				110	CRLB <DN4>		EU4	0 445 010 570	0 986 437 440
					CRMB <DN4>	08.13→	EU4	0 445 010 583	0 986 437 440
						EU4	0 445 010 570	0 986 437 440	
			135	CUNA <DK7>	08.13→	EU4	0 445 010 583	0 986 437 440	
				EU4	0 445 010 570	0 986 437 440			
TDI 4Drive, TSI [5F8]	2,0	110	CRBC <DN4>	08.13-12.16	EU4	0 445 010 583	0 986 437 440		
					EU4	0 445 010 570	0 986 437 440		
Toledo									
1.6 TDI [KG3]	1,6	85	CXMA <DK8>	05.15→		0 445 010 570	0 986 437 440		
2.0 TDI [5P2]	2,0	125	CEGA <D93>	03.09-05.09		0 445 010 543	0 986 437 410		

## SKODA

Karoq								
2.0 TDI 4x4 [NU7]	2,0	110	DFFA <DN4>	07.17→		0 445 010 583	0 986 437 440	
Kodiaq								
2.0 TDI, TDI 4x4 [NS7]	2,0	110/140	DBGA <DN4>; DBGC <DN4>; DFGA <DN4>; DFHA <DE5>	03.17→		0 445 010 583	0 986 437 440	
Octavia								
1.6 TDI [5E3]	1,6	66	CXXA <D36>	05.15→	5PL	0 445 010 583	0 986 437 440	
			66/81	CLHB <D36>; CRKB <DK5>	11.12-05.15	BO	0 445 010 583	0 986 437 440
			66/85	DDYA <DK8>; DDYB <D36>	02.17→	GNL	0 445 010 583	0 986 437 440
			77	CLHA <D38>	11.12-05.15	BO	0 445 010 583	0 986 437 440
TDI, TDI 4x4 [5E3]	1,6	81	CXXB <DK5>; DBKA <DK5>	05.15→	GNL	0 445 010 583	0 986 437 440	
TDI 4x4 [5E3]	1,6	77	CLHA <D38>	09.14-05.15		0 445 010 583	0 986 437 440	
2.0 TDI [5E3]	2,0	105	CKFB <DN6>	11.12-06.13		0 445 010 583	0 986 437 440	
			CRVC <DN6>	05.13→		0 445 010 583	0 986 437 440	
TDI, TDI 4x4 [1Z3]	2,0	81/103	CFHC <D91>; CFHF <D96>; CLCA <D96>; CLCB <D91>	02.10-06.13		0 445 010 565	0 986 437 405	
TDI, TDI 4x4 [5E3]	2,0	110	CKFC <DN4>	11.12-05.15		0 445 010 583	0 986 437 440	
			CRMB <DN4>	08.14→	EU4	0 445 010 583	0 986 437 440	
					5PL,6PL	0 445 010 583	0 986 437 440	



## ◀ SKODA

2.0 TDI, TDI 4x4 [5E3]	2,0	110	DCYA <DN4>	02.17→		0 445 010 583	0 986 437 440
TDI 4x4 [5E3]	2,0	135	CUPA <DK7>	09.14-05.15		0 445 010 583	0 986 437 440
<b>Octavia Combi</b>							
1.6 TDI [5E5]	1,6	66	CXXA <D36>	05.15→	5PL	0 445 010 583	0 986 437 440
		66/85	DDYA <DK8>; DDYB <D36>	02.17→	GNL	0 445 010 583	0 986 437 440
TDI, TDI 4x4 [5E5]	1,6	66/77/81	CLHA <D38>; CLHB <D36>; CRKB <DK5>	11.12-05.15	BO	0 445 010 583	0 986 437 440
		81	CXXB <DK5>; DBKA <DK5>	05.15→	GNL	0 445 010 583	0 986 437 440
2.0 TDI, TDI 4x4 [1Z5]	2,0	81/103	CFHC <D91>; CFHF <D96>; CLCA <D96>; CLCB <D91>	02.10-06.13		0 445 010 565	0 986 437 405
TDI, TDI 4x4 [5E5]	2,0	105/110	CKFB <DN6>; CKFC <DN4>; CRVC <DN6>	11.12→		0 445 010 583	0 986 437 440
		110	CRMB <DN4>	08.14→	EU4	0 445 010 583	0 986 437 440
					5PL,6PL	0 445 010 583	0 986 437 440
			DCYA <DN4>	02.17→		0 445 010 583	0 986 437 440
TDI 4x4 [5E5]	2,0	135	CUPA <DK7>	09.14-05.15		0 445 010 583	0 986 437 440
<b>Octavia Combi RS</b>							
2.0 FSI, TDI, TDI 4x4 [5E5]	2,0	135	CUNA <DK7>; CUPA <DK7>	05.13→		0 445 010 583	0 986 437 440
TDI [1Z5]	2,0	125	CEGA <D93>	05.08-02.13		0 445 010 546	0 986 437 410
<b>Octavia RS</b>							
2.0 TDI [1Z3]	2,0	125	CEGA <D93>	05.08-02.13		0 445 010 546	0 986 437 410
TDI, TDI 4x4 [5E3]	2,0	135	CUNA <DK7>; CUPA <DK7>	05.13→		0 445 010 583	0 986 437 440
<b>Rapid</b>							
1.6 TDI [NH3]	1,6	85	CXMA <DK8>	05.15→		0 445 010 583	0 986 437 440
<b>Rapid Spaceback</b>							
1.6 TDI [NH1]	1,6	85	CXMA <DK8>	05.15→		0 445 010 583	0 986 437 440
<b>Superb</b>							
1.6 TDI [3V3]	1,6	88	DCXA <DK5>; DCZA <DN8>	05.15→		0 445 010 583	0 986 437 440
2.0 TDI, TDI 4x4 [3T4]	2,0	103/125	CFFB <D91>; CFGB <D93>; CLJA <D91>	02.10-05.15		0 445 010 565	0 986 437 405
		125	CBBB <D93>	06.08-05.10		0 445 010 546	0 986 437 410
TDI, TDI 4x4 [3V3]	2,0	110/140	CRLB <DN4>; DDAA <DE5>; DFCA <DE5>; DFEA <DN4>; DFGA <DN4>; DFHA <DE5>	05.15→		0 445 010 583	0 986 437 440
<b>Superb Combi</b>							
1.6 TDI [3V5]	1,6	88	DCXA <DK5>; DCZA <DN8>	05.15→		0 445 010 583	0 986 437 440
2.0 TDI [3V5]	2,0	125	CFGB <D93>	05.10-05.15		0 445 010 565	0 986 437 405
TDI, TDI 4x4 [3T5]	2,0	103/125	CFFB <D91>; CFGB <D93>; CLJA <D91>	02.10-05.15		0 445 010 565	0 986 437 405
		125	CBBB <D93>	09.09-05.10		0 445 010 546	0 986 437 410
TDI, TDI 4x4 [3V5]	2,0	110/140	CRLB <DN4>; DDAA <DE5>; DFCA <DE5>; DFEA <DN4>; DFGA <DN4>; DFHA <DE5>	05.15→		0 445 010 583	0 986 437 440
<b>Yeti</b>							
2.0 TDI, TDI 4x4 [5L7]	2,0	81/103/125	CFHA <D96>; CFHC <D91>; CFHF <D96>; CFJA <D93>; CLCA <D96>; CLCB <D91>	11.09-12.17		0 445 010 565	0 986 437 405
		81/110	CUUA <DN1>; CUUB <DN4>; DFSA <DN1>; DFSB <DN4>	05.15-12.17		0 445 010 583	0 986 437 440
TDI 4x4 [5L7]	2,0	103/125	CBDB <D91>; CEGA <D93>	05.09-05.10		0 445 010 546	0 986 437 410

## SMART (MCC)

<b>Fortwo Cabrio</b>							
0.8 cdi [450]	0,8	30	OM 660.940	02.04-03.07		0 445 010 273	0 986 437 019
<b>Fortwo Coupé</b>							
0.8 cdi [450]	0,8	30	OM 660.940	02.04-03.07		0 445 010 273	0 986 437 019
<b>Smart Cabrio</b>							
0.8 cdi [450]	0,8	30	OM 660.940	03.01-01.04		0 445 010 273	0 986 437 019
<b>Smart Coupé</b>							
0.8 cdi [450]	0,8	30	OM 660.940	11.99-01.04		0 445 010 273	0 986 437 019

## SUBARU

<b>Trezia</b>							
1.4 D [NLP]	1,4	66	1NDTV	03.11-12.14		0 445 010 214	0 986 437 338



## SUZUKI

## Grand Vitara

1.9 DDiS 4x4 [JT]	1,9	95	F9Q			
				Fg.-Nr. →00250000	10.05-12.14	0 445 010 087
				Fg.-Nr. 00250001→00610000	10.05-12.14	0 445 010 148
				Fg.-Nr. 00610001→	10.05-12.14	0 445 010 218 0 986 437 043

2.0 D Turbo [FT]	2,0	80	RHW		11.00-12.05	0 445 010 021 0 986 437 012
			RHZ		11.00-12.05	0 445 010 010 0 986 437 005
TDi XL-7 [HT]	2,0	80	RHW		06.01-10.05	0 445 010 021 0 986 437 012

## Ignis Hatchback

1.3 DDiS Turbo	1,3	51	Z13DT		10.03-12.07	0 445 010 278 0 986 437 024
----------------	-----	----	-------	--	-------------	-----------------------------

## Swift Hatchback

1.3 DDiS [FZ/NZ]	1,2	55	D13AA		09.10-12.14	0 445 010 310 0 986 437 038
DDiS D Turbo [FZ/NZ]	1,2	55	D13A <DPF>		09.10-12.14	0 445 010 293 0 986 437 036
DDiS D Turbo [MZ/EZ]	1,3	51-55	Z13DT			
				Fg.-Nr. →00500000	08.05-12.14	0 445 010 278 0 986 437 024

## SX4 Hatchback

1.6 DDiS	1,6	66	9HX		04.07-08.09	0 445 010 296 0 986 437 028
2.0 DDiS, DDiS 4WD	2,0	99	D20AA <DPF>		09.09-12.13	0 445 010 241

## SX4 S-Cross

1.6 DDiS, DDiS 4WD	1,6	88	D16AA		10.13-07.16	0 445 010 414
--------------------	-----	----	-------	--	-------------	---------------

## Vitara

1.6 DDiS, DDiS 4x4 [LY]	1,6	88	D16AA		02.15→	0 445 010 414
-------------------------	-----	----	-------	--	--------	---------------

## Wagon R+

1.3 DDiS D Turbo [MM]	1,3	51	Z13DT		09.03-03.06	0 445 010 277 0 986 437 024 0 986 437 201
-----------------------	-----	----	-------	--	-------------	--

## TATA (TELCO)

## Indica Vista

1.2 D [X1]	1,2	55	Quadrajel		08.08→	0 445 010 413
------------	-----	----	-----------	--	--------	---------------

## TOYOTA

## Auris

1.4 D-4D [E15, JTN]	1,4	66	1NDTV		10.06-01.09	0 445 010 105 0 986 437 335
					02.09-08.12	0 445 010 214 0 986 437 338
D-4D [E15, NMT, SB1]	1,4	66	1NDTV		02.07-01.09	0 445 010 105 0 986 437 335
					02.09-10.12	0 445 010 214 0 986 437 338
D-4D [E18]	1,4	66	1NDTV		10.12-05.15	LLE 0 445 010 258 0 986 437 338
						RLE 0 445 010 392 0 986 437 338
					06.15→	0 445 010 460

## Auris Touring Sports

1.4 D-4D [E18]	1,4	66	1NDTV		07.13-05.15	LLE 0 445 010 258 0 986 437 338
						RLE 0 445 010 392 0 986 437 338
					06.15→	0 445 010 460

## Corolla

1.4 D Turbo [E12]	1,4	66	1NDTV		01.04-02.07	0 445 010 105 0 986 437 335
D-4D [E15]	1,4	66	1NDTV		11.06-11.08	0 445 010 105 0 986 437 335
					12.08-04.13	0 445 010 214 0 986 437 338
D-4D [E18]	1,4	66	1NDTV		06.13-05.15	SSJ 0 445 010 214 0 986 437 338
						SSJ 0 445 010 392 0 986 437 338
					06.13→	0 445 010 214 0 986 437 338
					06.15→	0 445 010 460

## Corolla Hatchback

1.4 D Turbo [E12, SB1]	1,4	66	1NDTV		09.02-12.07	0 445 010 105 0 986 437 335
TD [E12, JTD]	1,4	66	1NDTV		08.04-12.06	0 445 010 105 0 986 437 335

## Corolla Wagon

1.4 D Turbo [E12]	1,4	66	1NDTV		04.04-02.07	0 445 010 105 0 986 437 335
-------------------	-----	----	-------	--	-------------	-----------------------------





◀ TOYOTA









iQ							
1.4	1,4	66	1NDTV		11.08-05.12	0 445 010 214	0 986 437 338
Urban Cruiser							
1.4 D-4D, D-4D 4x4 [P1]	1,4	66	1NDTV		01.09-12.16	0 445 010 214	0 986 437 338
Verso-S							
1.4 D-4D	1,4	66	1ND-TV		11.10-12.15	0 445 010 214	0 986 437 338
Yaris							
1.4 D Turbo [P1]	1,4	55	1ND-TV		10.01-08.05	0 445 010 113	
			1NDTV		02.03-08.06	WW	0 445 010 112
							0 445 010 113
D-4D [P9, VNK]	1,4	66	1NDTV		11.08-10.10	0 445 010 214	0 986 437 338
					11.10-07.11	0 445 010 258	0 986 437 338
			Mot.-Nr. Dxxxxxx→Fxxxxxx		11.05-10.08	0 445 010 134	0 986 437 372
			Mot.-Nr. Oxxxxxx→9xxxxxx		11.05-10.08	0 445 010 105	0 986 437 335
D-4D [P13, VNK]	1,4	66	1NDTV		07.11-06.14	0 445 010 214	0 986 437 338
					07.14-05.15	0 445 010 258	0 986 437 338
					06.15→	0 445 010 460	
Yaris Verso							
1.4 D Turbo [P2]	1,4	55	1NDTV		08.01-09.05	0 445 010 113	

**UAZ**

Patriot							
2.2 TD 4x4	2,3	85	F1AE0481B		01.07→	0 445 010 181	0 986 437 085

**VAUXHALL**

Agila							
1.3 CDTI [B]	1,2	55	Z 13 DTJ		07.08-08.15	0 445 010 278	0 986 437 024
Antara							
2.0 CDTI 4x4	2,0	93/110	Z 20 DM <Ecotec>; Z 20 DMH <Ecotec>		11.06-12.11	0 445 010 332	0 986 437 032
Astra							
1.3 CDTI [J]	1,2	70	A 13 DTE <ecoFlex>		09.09-08.16	SSJ	0 445 010 293
						SSJ	0 445 010 381
1.7 CDTI [H]	1,7	59/74	Z 17 DTH <Turbo Ecotec>; Z 17 DTL <Turbo Ecotec>		03.04-08.09	0 445 010 086	0 986 437 317
CDTI 16V [G]	1,7	59	Z 17 DTL <Turbo Ecotec>		03.03-08.05	0 445 010 086	0 986 437 317
1.9 CDTI [H]	1,9	74	Z 19 DTL <Turbo Ecotec>		09.05-03.10	LLE	0 445 010 288
			Mot.-Nr. →17579269		09.05-03.10	RLE	0 445 010 287
			Mot.-Nr. 17579270→		09.05-03.10	RLE	0 445 010 441
		88	Z 19 DT <Turbo Ecotec>		09.05-03.10	LLE	0 445 010 288
			Mot.-Nr. →17579269		09.05-03.10	RLE	0 445 010 287
			Mot.-Nr. 17579270→		09.05-03.10	RLE	0 445 010 441
			Z 19 DTJ <Turbo Ecotec>		03.04-03.10	LLE	0 445 010 288
						RLE	0 445 010 287
		110	Z 19 DTH <Ecotec>		03.04-03.10	LLE	0 445 010 288
			Mot.-Nr. →17579269		03.04-03.10	RLE	0 445 010 287
			Mot.-Nr. 17579270→		03.04-03.10	RLE	0 445 010 441
2.0 CDTI [J]	2,0	118/121	A 20 DTH <Ecotec>		09.09-08.16	SSJ	0 445 010 441
						SSJ	0 445 010 443
CDTI, GTC [J]	2,0	143	A 20 DTR <Ecotec>		08.12→	0 445 010 550	
Astra Estate							
1.7 CDTI [G]	1,7	59	Z 17 DTL <Turbo Ecotec>		03.03-08.05	0 445 010 086	0 986 437 317
CDTI [H]	1,7	59/74	Z 17 DTH <Turbo Ecotec>; Z 17 DTL <Turbo Ecotec>		08.04-08.09	0 445 010 086	0 986 437 317
1.9 CDTI [H]	1,9	74	Z 19 DTL <Turbo Ecotec>		09.05-03.10	LLE	0 445 010 288
			Mot.-Nr. →17579269		09.05-03.10	RLE	0 445 010 287
			Mot.-Nr. 17579270→		09.05-03.10	RLE	0 445 010 441
		88	Z 19 DT <Turbo Ecotec>		09.05-03.10	LLE	0 445 010 288
			Mot.-Nr. →17579269		09.05-03.10	RLE	0 445 010 287
			Mot.-Nr. 17579270→		09.05-03.10	RLE	0 445 010 441
			Z 19 DTJ <Turbo Ecotec>		08.04-03.10	LLE	0 445 010 288
						RLE	0 445 010 287

											
1.9 CDTi [H]	1,9	110	Z 19 DTH <Ecotec>	08.04-03.10	LLE		0 445 010 288	0 986 437 025			
			Mot.-Nr. →17579269	08.04-03.10	RLE		0 445 010 287	0 986 437 026			
			Mot.-Nr. 17579270→	08.04-03.10	RLE		0 445 010 441	0 986 437 047			
<b>Astra GTC</b>											
1.7 CDTi [H]	1,7	59/74	Z 17 DTH <Turbo Ecotec>; Z 17 DTL <Turbo Ecotec>	06.05-08.09			0 445 010 086	0 986 437 317			
1.9 CDTi [H]	1,9	88	Z 19 DTJ <Turbo Ecotec>	06.05-03.09	LLE		0 445 010 288	0 986 437 025			
					RLE		0 445 010 287	0 986 437 026			
			Z 19 DTH <Ecotec>	06.05-12.09	LLE		0 445 010 288	0 986 437 025			
			Mot.-Nr. →17579269	06.05-12.09	RLE		0 445 010 287	0 986 437 026			
			Mot.-Nr. 17579270→	06.05-12.09	RLE		0 445 010 441	0 986 437 047			
2.0 [J]	2,0	121	A 20 DTH <Ecotec>	09.11→	<del>SSJ</del>		0 445 010 441	0 986 437 047			
					SSJ		0 445 010 443	0 986 437 027			
<b>Astra Sports Tourer</b>											
1.3 CDTi [J]	1,2	70	A 13 DTE <ecoFlex>	09.10-08.16	<del>SSJ</del>		0 445 010 293	0 986 437 036			
					SSJ		0 445 010 381	0 986 437 072			
2.0 CDTi [J]	2,0	118/121	A 20 DTH <Ecotec>	09.10-08.16	<del>SSJ</del>		0 445 010 441	0 986 437 047			
					SSJ		0 445 010 443	0 986 437 027			
			143	A 20 DTR <Ecotec>	08.12-08.16			0 445 010 550			
<b>Astra TwinTop</b>											
1.9 CDTi [H]	1,9	110	Z 19 DTH <Ecotec>	09.05-12.09	LLE		0 445 010 288	0 986 437 025			
			Mot.-Nr. →17579269	09.05-12.09	RLE		0 445 010 287	0 986 437 026			
			Mot.-Nr. 17579270→	09.05-12.09	RLE		0 445 010 441	0 986 437 047			
<b>Astra Van</b>											
1.7 CDTi [G]	1,7	59	Z 17 DTL <Turbo Ecotec>	03.03-08.05			0 445 010 086	0 986 437 317			
<b>Cascada</b>											
2.0 CDTi	2,0	121	A 20 DTH <Ecotec>	04.13→	AG		0 445 010 441	0 986 437 047			
					GS		0 445 010 443	0 986 437 027			
			125	B 20 DTH	07.15→			0 445 010 759			
		143	A 20 DTR <Ecotec>	04.13→			0 445 010 550				
<b>Combo</b>											
1.3 [D]	1,2	66	A 13 FD <ecoFLEX>	02.12→	TW		0 445 010 310	0 986 437 038			
							0 445 010 425	0 986 437 097			
			1,3	70		07.16→	TW		0 445 010 310	0 986 437 038	
							0 445 010 425	0 986 437 097			
CDTi [Tour]	1,3	51/55	Y 13 DT <Turbo>; Z 13 DT <Ecotec>; Z 13 DTJ <Turbo>	09.04-01.12			0 445 010 278	0 986 437 024			
1.6 [D]	1,6	66	A 16 FDL <ecoFLEX>	02.12→	EU5,SSJ		0 445 010 303	0 986 437 094			
					EU5,SSJ		0 445 010 305	0 986 437 094			
					EU6		0 445 010 466	0 986 437 095			
					5PL,SSJ		0 445 010 307	0 986 437 095			
					5PL,SSJ		0 445 010 397	0 986 437 095			
					74/77	A 16 FDH <ecoFLEX>	02.12→	EU5,SSJ		0 445 010 303	0 986 437 094
								EU5,SSJ		0 445 010 305	0 986 437 094
								EU6		0 445 010 466	0 986 437 095
								5PL,SSJ		0 445 010 307	0 986 437 095
								5PL,SSJ		0 445 010 397	0 986 437 095
2.0 [D]	2,0	99	A 20 FD <ecoFLEX>	02.12→	EU6		0 445 010 466	0 986 437 095			
					5PL,EU5		0 445 010 305	0 986 437 094			
<b>Corsa</b>											
1.3 [E]	1,2	55/70	B 13 DTC; B 13 DTE; B 13 DTR	10.14→			0 445 010 425	0 986 437 097			
CDTi [C]	1,3	51/55	Y 13 DT <Turbo Ecotec>; Z 13 DT <Ecotec>; Z 13 DTJ <Turbo Ecotec>	09.03-09.06			0 445 010 278	0 986 437 024			
CDTi [D]	1,2	55	A 13 DTC <Ecotec>	01.11-08.14	SSJ		0 445 010 381	0 986 437 072			
			Fg.-Nr. D4000001→D6000001→	01.11-08.14	<del>SSJ</del>		0 445 010 293	0 986 437 036			
			Fg.-Nr. →C4999999→C6999999	01.11-08.14	<del>SSJ</del>		0 445 010 278	0 986 437 024			
			Z 13 DTJ <Turbo Ecotec>	07.06-03.09			0 445 010 278	0 986 437 024			
			66	Z 13 DTH <Turbo Ecotec>	07.06-07.10			0 445 010 293	0 986 437 036		
			70	A 13 DT... <ecoFlex>	01.11-08.14	<del>SSJ</del>		0 445 010 293	0 986 437 036		
							SSJ		0 445 010 381	0 986 437 072	
						Z 13 DTE <eco Flex>	12.09-09.10	<del>SSJ</del>		0 445 010 293	0 986 437 036
								SSJ		0 445 010 381	0 986 437 072
				1,3	55	A 13 DTJ <Turbo Ecotec>	10.06-02.09			0 445 010 278	0 986 437 024
		66	A 13 DTH <Turbo Ecotec>	10.06-02.09			0 445 010 293	0 986 437 036			







◀ VAUXHALL

Insignia											
2.0 CDTI [A]	2,0	81/96	A 20 DT... <Ecotec>	11.08-12.17	SSJ	0 445 010 441	0 986 437 047				
						SSJ	0 445 010 443	0 986 437 027			
		88/103	A 20 DTE	09.13-12.17	SSJ	0 445 010 441	0 986 437 047				
						SSJ	0 445 010 443	0 986 437 027			
CDTI, CDTI 4x4 [A]	2,0	118	A 20 DTH <Ecotec>	11.08-12.17		0 445 010 445					
		125	B 20 DTH	01.15-12.17		0 445 010 759					
		140-143	A 20 DTR <Ecotec>								
			Fg.-Nr. D1000001→	07.09-12.17		0 445 010 550					
		Fg.-Nr. →C1999999	07.09-12.17		0 445 010 550						
Insignia Grand Sport											
2.0 , 4x4 [B]	2,0	125/154	<LFO>; <LFS>	03.17→		0 445 010 759					
Insignia Sports Tourer											
2.0 , 4x4 [B]	2,0	125/154	<LFO>; <LFS>	03.17→		0 445 010 759					
CDTI [A]	2,0	81/96	A 20 DT... <Ecotec>	02.09-12.17	SSJ	0 445 010 441	0 986 437 047				
						SSJ	0 445 010 443	0 986 437 027			
		88/103	A 20 DTE	09.13-12.17	SSJ	0 445 010 441	0 986 437 047				
						SSJ	0 445 010 443	0 986 437 027			
CDTI, CDTI 4x4 [A]	2,0	118	A 20 DTH <Ecotec>	02.09-12.17	SSJ	0 445 010 441	0 986 437 047				
		125	B 20 DTH	01.15-12.17		0 445 010 759					
		140-143	A 20 DTR <Ecotec>								
			Fg.-Nr. D1000001→	07.09-12.17		0 445 010 550					
		Fg.-Nr. →C1999999	07.09-12.17		0 445 010 550						
Meriva											
1.3 CDTI [A]	1,3	51/55	Y 13 DT <Ecotec>; Z 13 DT <Ecotec>; Z 13 DTJ <Ecotec>	09.03-03.10		0 445 010 278	0 986 437 024				
			CDTI [B]	1,2	55	A 13 DTC <Ecotec>	06.10-12.17	0 445 010 293	0 986 437 036		
						Fg.-Nr. A4192110→	06.10-12.17	0 445 010 278	0 986 437 024		
		70	A 13 DTE <ecoFlex>	06.10-12.17	SSJ	0 445 010 293	0 986 437 036				
					SSJ	0 445 010 381	0 986 437 072				
Omega											
2.5 TDI [B]	2,5	110	Y 25 TD <Turbo>	09.01-09.04		0 445 010 009	0 986 437 004				
Signum											
1.9 CDTI	1,9	74	Z 19 DTL <Ecotec>	09.05-09.08	LLE	0 445 010 288	0 986 437 025				
						RLE	0 445 010 287	0 986 437 026			
		88	Z 19 DT <Ecotec>	04.04-09.08	LLE	0 445 010 288	0 986 437 025				
						RLE	0 445 010 287	0 986 437 026			
		110	Z 19 DTH <Ecotec>	04.04-09.08	LLE	0 445 010 288	0 986 437 025				
			Mot.-Nr. →17579269	04.04-09.08	RLE	0 445 010 287	0 986 437 026				
		Mot.-Nr. 17579270→	04.04-09.08	RLE	0 445 010 441	0 986 437 047					
Tigra TwinTop											
1.3 CDTI [B]	1,3	51	Z 13 DT <Ecotec>	06.04-03.09		0 445 010 278	0 986 437 024				
Vectra											
1.9 CDTI [C]	1,9	74/88	Z 19 DT <Ecotec>; Z 19 DTL <Ecotec>	04.04-10.08	LLE	0 445 010 097	0 986 437 025				
		110	Z 19 DTH <Ecotec>	04.04-03.08	LLE	0 445 010 288	0 986 437 025				
			Mot.-Nr. →17579269	04.04-03.08	RLE	0 445 010 287	0 986 437 026				
			Mot.-Nr. 17579270→	04.04-03.08	RLE	0 445 010 441	0 986 437 047				
Vectra Estate											
1.9 CDTI [C]	1,9	74/88	Z 19 DT <Ecotec>; Z 19 DTL <Ecotec>	04.04-10.08	LLE	0 445 010 097	0 986 437 025				
		110	Z 19 DTH <Ecotec>	04.04-03.08	LLE	0 445 010 288	0 986 437 025				
			Mot.-Nr. →17579269	04.04-03.08	RLE	0 445 010 287	0 986 437 026				
			Mot.-Nr. 17579270→	04.04-03.08	RLE	0 445 010 441	0 986 437 047				
Zafira											
1.9 CDTI [B]	1,9	74	Z 19 DTL <Ecotec>	07.05-03.08	LLE	0 445 010 288	0 986 437 025				
						RLE	0 445 010 287	0 986 437 026			
		88	Z 19 DT <Ecotec>	07.05-12.10	LLE	0 445 010 288	0 986 437 025				
						RLE	0 445 010 287	0 986 437 026			
		110	Z 19 DTH <Ecotec>	07.05-12.10	LLE	0 445 010 288	0 986 437 025				
			Mot.-Nr. →17579269	07.05-12.10	RLE	0 445 010 287	0 986 437 026				
		Mot.-Nr. 17579270→	07.05-12.10	RLE	0 445 010 441	0 986 437 047					
2.0 CDTI [C]	2,0	81	A 20 DTL <Ecotec>	01.12→		0 445 010 441	0 986 437 047				



2.0 CDTI [C]	2,0	96	A 20 DT <ecoFLEX>	01.12→	SSJ	0 445 010 441	0 986 437 047
					SSJ	0 445 010 443	0 986 437 027
		121	A 20 DTH <Ecotec>	01.12→	SSJ	0 445 010 441	0 986 437 047
					SSJ	0 445 010 443	0 986 437 027
		125	B 20 DTH	02.15→		0 445 010 759	
	143	A 20 DTR <Ecotec>	01.13→		0 445 010 550		

## VOLVO

## C30

1.6 D DRIVE [P14]	1,6	79-80	D4164TDRIVE	10.06-07.11		0 445 010 296	0 986 437 028
2.0 D3 [P14]	2,0	110	D5204T5	08.10→	EU3	0 445 010 110	0 986 437 325
					EU4,EU5	0 445 010 680	0 986 437 423
D4 [P14]	2,0	130	D5204T	08.10→	EU3	0 445 010 110	0 986 437 325
					EU4,EU5	0 445 010 680	0 986 437 423
2.4 D5 [P14]	2,4	120/131-132	D5244T9; D5244T13	10.06-07.10		0 445 010 110	0 986 437 325

## C70 II Cabrio

2.0 D3, D4	2,0	110/130	D5204T; D5204T5	10.10-07.13		0 445 010 680	0 986 437 423
2.4 D, D5	2,4	120/132	D5244T9; D5244T13	08.06-07.10		0 445 010 110	0 986 437 325

## S40 II

1.6 D DRIVE [P11]	1,6	80-81	D4164TDRIVE				
			Fg.-Nr. →178843	11.04-08.12	0 445 010 089	0 986 437 322	
			Fg.-Nr. 178844→	11.04-08.12		0 445 010 296	0 986 437 028
2.0 D3, D4 [P11]	2,0	110/130	D5204T; D5204T5	08.10-08.12		0 445 010 680	0 986 437 423
2.4 D5 [P11]	2,4	120/132	D5244T9; D5244T13	03.06-07.10		0 445 010 110	0 986 437 325

## S60 Cross Country

2.4 D5 AWD	2,4	140	D5244T21	08.15→		0 445 010 680	0 986 437 423
------------	-----	-----	----------	--------	--	---------------	---------------

## S60 I

2.4 D	2,4	85/96/120	D5244T; D5244T2; D5244T3	08.01-07.06		0 445 010 043	0 986 437 312
D, D5	2,4	90/93/120/136	D5244T4; D5244T5; D5244T6; D5244T7	08.05-07.09		0 445 010 110	0 986 437 325

## S60 II

2.0 D3, D4	2,0	100/120	D5204T2; D5204T3; D5204T7	08.10-12.15		0 445 010 680	0 986 437 423
2.4 D4 AWD, D5, D5 AWD	2,4	140/151/158/169	D5244T10; D5244T11; D5244T15; D5244T21; D5244T23	08.10→		0 445 010 680	0 986 437 423

## S80 I

2.4 D, D5	2,4	96/120	D5244T; D5244T2	08.01-07.06		0 445 010 043	0 986 437 312
-----------	-----	--------	-----------------	-------------	--	---------------	---------------

## S80 II

1.6 D DRIVE	1,6	80	D4164T	08.09-07.11		0 445 010 296	0 986 437 028
2.0 D3, D4	2,0	100/120	D5204T2; D5204T3; D5204T7	08.10-08.16		0 445 010 680	0 986 437 423
2.4 D, D5, D5 AWD	2,4	120/129/151/158	D5244T10; D5244T11; D5244T14; D5244T15;	11.08-08.16		0 445 010 680	0 986 437 423
			D5244T19				
		120/136	D5244T4; D5244T5	03.06-07.09		0 445 010 110	0 986 437 325

## V40 Cross Country

2.0 D3, D4	2,0	110/130	D5204T4; D5204T6	01.13-08.17		0 445 010 680	0 986 437 423
------------	-----	---------	------------------	-------------	--	---------------	---------------

## V40 II

2.0 D3, D4	2,0	110/130	D5204T4; D5204T6	09.12-08.15		0 445 010 680	0 986 437 423
------------	-----	---------	------------------	-------------	--	---------------	---------------

## V50

1.6 D DRIVE [P12]	1,6	80-81	D4164TDRIVE				
			Fg.-Nr. →181239	11.04-07.10	0 445 010 089	0 986 437 322	
			Fg.-Nr. 181240→	11.04-07.10		0 445 010 296	0 986 437 028
2.0 D3, D4 [P12]	2,0	110/130	D5204T; D5204T5	08.10-12.12		0 445 010 680	0 986 437 423
2.4 D5 [P12]	2,4	120/132	D5244T9; D5244T13	04.06-07.10		0 445 010 110	0 986 437 325

## V60

2.0 D3, D4	2,0	100/120	D5204T2; D5204T3; D5204T7	09.10-08.15		0 445 010 680	0 986 437 423
2.4 D4 AWD, D5, D5 AWD	2,4	120/133/140/151/158/169	D5244T10; D5244T11; D5244T12; D5244T15;	09.10→		0 445 010 680	0 986 437 423
			D5244T17; D5244T21; D5244T23				

## V60 Cross Country

2.4 D5 AWD	2,4	140	D5244T21	08.15→		0 445 010 680	0 986 437 423
------------	-----	-----	----------	--------	--	---------------	---------------





◀ VOLVO

V70 II							
2.4 D, D AWD, D5, D5 AWD	2,4	96/120/136	D5244T; D5244T2; D5244T3		08.01-07.06	0 445 010 043	0 986 437 312
D, D5, D5 AWD	2,4	90/93/120/136	D5244T4; D5244T5; D5244T6; D5244T7		08.06-07.07	0 445 010 110	0 986 437 325
V70 III							
1.6 D DRIVE	1,6	80	D4164T		01.10-07.11	0 445 010 296	0 986 437 028
2.0 D3, D3/D4	2,0	100/120	D5204T2; D5204T3; D5204T7		08.10-07.15	0 445 010 680	0 986 437 423
2.4 D, D4 AWD, D5, D5 AWD	2,4	120/129/133/151/158	D5244T10; D5244T11; D5244T12; D5244T14; D5244T15; D5244T17		08.09-07.16	0 445 010 680	0 986 437 423
D, D5, D5 AWD	2,4	120/132-136	D5244T4; D5244T5		08.07-07.09	0 445 010 110	0 986 437 325
XC60 I							
2.0 D3, D3 DRIVE, D4	2,0	100/120	D5204T2; D5204T3; D5204T7		08.10-07.15	0 445 010 680	0 986 437 423
2.4 D AWD, D DRIVE, D3 AWD, D4 AWD, D5 AWD	2,4	120/129/133/140/151/158/162/169	D 5244 T1...; D5244T2...; D5244T10; D5244T12; D5244T14; D5244T16; D5244T17; D5244T21; D5244T23		08.09-02.17	0 445 010 680	0 986 437 423
D AWD, D5 AWD	2,4	120/136	D5244T4; D5244T5		03.09-07.09	0 445 010 110	0 986 437 325
XC70 I							
2.4 D AWD	2,4	120	D5244T		08.02-07.06	0 445 010 043	0 986 437 312
D5 AWD	2,4	136	D5244T4		12.05-07.07	0 445 010 110	0 986 437 325
XC70 II							
2.0 D3 DRIVE	2,0	120	D5204T2; D5204T3		08.10-07.15	0 445 010 680	0 986 437 423
2.4 D AWD, D DRIVE, D3 AWD, D4 AWD, D5 AWD	2,4	120/129/133/151/158	D5244T10; D5244T11; D5244T12; D5244T14; D5244T15; D5244T16; D5244T17		08.09-07.16	0 445 010 680	0 986 437 423
D AWD, D5 AWD	2,4	120/136	D5244T4; D5244T5		08.07-07.09	0 445 010 110	0 986 437 325
XC90 I							
2.4 D3, D5 AWD	2,4	120/136/147	D5244T; D5244T4; D5244T5; D5244T18		01.03-07.15	0 445 010 110	0 986 437 325



**VW (VOLKSWAGEN)**

Amarok							
2.0 BITDI [2H, S1]	2,0	120-132	CDCA <D46>		09.10-05.12	0 445 010 507	0 986 437 410
BITDI 4Motion [2H, S1]	2,0	120-132	CDCA <D46>		09.10-05.12	0 445 010 543	0 986 437 410
TDI, TDI 4Motion [S6, S7]	2,0	103/132	CNEA <D49>; CNFB <D91>; CSHA <D49>		06.16->	0 445 010 565	0 986 437 405
TDI, TDI 4Motion [2H, S1]	2,0	90-103/90/103/132	CDBA <D45>; CNEA <D49>; CNFA <D45>; CNFB <D91>; CSHA <D49>		09.10-10.12/11.11-10.16	0 445 010 543	0 986 437 410/0 445 010 565
3.0 TDI, TDI 4Motion [S6, S7]	3,0	120	DDXA <DJ1>		06.16-05.17/06.17->	0 445 010 813	0 986 437 456/0 445 010 824
TDI 4Motion [S6, S7]	3,0	150/165	DDXB <D1Q>; DDXC <D4E>		06.16-05.17/06.16-05.17/06.17->	0 445 010 813	0 986 437 456/0 445 010 824
TDI 4MOTION [S6, S7]	3,0	165	DDXD <D4E>		03.17-05.17/06.17->	0 445 010 813	0 986 437 456/0 445 010 824
Arteon							
2.0 TDI [3H7]	2,0	110	DFGA <DN4>		03.17->	0 445 010 583	0 986 437 440
TDI, TDI 4Motion [3H7]	2,0	110/140	DBGFA <DN4>; DFHA <DE5>		05.17->	0 445 010 583	0 986 437 440
TDI 4Motion [3H7]	2,0	176	CUAA <DK9>		03.17->	0 445 010 811	
Beetle							
2.0 TDI [5C1]	2,0	81/110/103	CUUA <DN1>; CUUB <DN4>; CFFB <D91>		12.14-06.16/04.12-06.16	0 445 010 583	0 986 437 440/0 445 010 565
TDI [5C2]	2,0	81/110	CUUA <DN1>; CUUB <DN4>		07.16->	0 445 010 583	0 986 437 440
Beetle Cabriolet							
2.0 TDI [5C7]	2,0	81/110/103	CUUA <DN1>; CUUB <DN4>; CFFB <D91>		12.14-07.16/01.13-07.16	0 445 010 583	0 986 437 440/0 445 010 565



<b>2.0 TDI [5C8]</b>	2,0	81/110	CUUA <DN1>; CUUB <DN4>	07.16→		<b>0 445 010 583</b>	<b>0 986 437 440</b>
<b>Caddy</b>							
<b>2.0 TDI, TDI 4Motion [SA]</b>	2,0	55/75/90/110	CUUB <DN4>; CUUC <DS2>; CUUD <MOH>; CUUE <DN9>; CUUF <DS2>	05.15-12.15		<b>0 445 010 583</b>	<b>0 986 437 440</b>
			DFSB <DN4>; DFSC <DS2>; DFSD <MOH>; DFSE <DN9>; DFSF <DS2>	11.15→		<b>0 445 010 583</b>	<b>0 986 437 440</b>
<b>TDI, TDI 4Motion [2C]</b>	2,0	81/103/125	CFHC <D91>; CFHF <D96>; CLCA <D96>	05.15→		<b>0 445 010 565</b>	<b>0 986 437 405</b>
			CFHC <D91>; CFHE; CFHF <D96>; CFJA <D93>; CLCA <D96>; CLCB <D91>	08.10-05.15		<b>0 445 010 565</b>	<b>0 986 437 405</b>
<b>CC</b>							
<b>2.0 TDI [358]</b>	2,0	110/135	CUVC <DN4>; CUWA <DK7>	05.15-12.16		<b>0 445 010 583</b>	<b>0 986 437 440</b>
<b>TDI, TDI 4Motion [358]</b>	2,0	100/103/125/130	CFFA <D94>; CFFB <D91>; CFGB <D93>; CFGC <DE2>; CLLA <D93>	11.11-12.16		<b>0 445 010 565</b>	<b>0 986 437 405</b>
<b>Eos</b>							
<b>2.0 TDI [1F7]</b>	2,0	103	CBAB <D91>	05.08-11.10		<b>0 445 010 543</b>	<b>0 986 437 410</b>
<b>TDI [1F8]</b>	2,0	100/103	CFFA <D94>; CFFB <D91>	11.10-08.15		<b>0 445 010 565</b>	<b>0 986 437 405</b>
<b>Golf Alltrack</b>							
<b>1.6 TDI 4Motion [BA5]</b>	1,6	81	CRKB <DK5>; CXXB <DK5>	11.14-03.17	EU5	<b>0 445 010 583</b>	<b>0 986 437 440</b>
<b>2.0 GTD 4Motion, TDI, TDI 4Motion [BV5]</b>	2,0	110/135	CRLB <DN4>; DCYA <DN4>; DGCA <DK7>	11.16→		<b>0 445 010 583</b>	<b>0 986 437 440</b>
<b>GTD 4Motion, TDI 4Motion [BA5]</b>	2,0	110/135	CRBC <DN4>; CRLB <DN4>; CUNA <DK7>	12.14-03.17		<b>0 445 010 583</b>	<b>0 986 437 440</b>
<b>Golf Plus</b>							
<b>2.0 TDI [521]</b>	2,0	81/100/103	CBDA <D94>; CBDB <D91>; CBDC <D96>	01.09-05.10		<b>0 445 010 543</b>	<b>0 986 437 410</b>
			CFHB <D94>; CFHC <D91>; CLCA <D96>	11.09-12.13		<b>0 445 010 565</b>	<b>0 986 437 405</b>
<b>Golf Sportsvan</b>							
<b>1.6 TDI [AM1]</b>	1,6	66	CRKA <D36>	02.14-10.14	EU6	<b>0 445 010 583</b>	<b>0 986 437 440</b>
				02.14-11.14	EU5	<b>0 445 010 583</b>	<b>0 986 437 440</b>
			CXXA <D36>	11.14-10.16	EU5	<b>0 445 010 583</b>	<b>0 986 437 440</b>
			PR-Code FM1	11.14-10.16	EU6	<b>0 445 010 583</b>	<b>0 986 437 440</b>
		66/85	DDYA <DK8>; DDYB <D36>				
			PR-Code FM1	11.16→		<b>0 445 010 583</b>	<b>0 986 437 440</b>
		81	CRKB <DK5>	02.14-10.14	EU6	<b>0 445 010 583</b>	<b>0 986 437 440</b>
				02.14-11.14	EU5	<b>0 445 010 583</b>	<b>0 986 437 440</b>
			CXXB <DK5>	11.14-10.16	EU5	<b>0 445 010 583</b>	<b>0 986 437 440</b>
			PR-Code FM1	11.14-10.16	EU6	<b>0 445 010 583</b>	<b>0 986 437 440</b>
			DBKA <DK5>	05.15-11.17	EU5	<b>0 445 010 583</b>	<b>0 986 437 440</b>
			PR-Code FM1	05.15-11.17	EU6	<b>0 445 010 583</b>	<b>0 986 437 440</b>
<b>2.0 TDI [AM1]</b>	2,0	81/110	CRLB <DN4>; CRLD <DN1>; CRVA <DN1>; DCYA <DN4>; DCYB <DN1>	02.14→		<b>0 445 010 583</b>	<b>0 986 437 440</b>
<b>Golf V Variant</b>							
<b>2.0 TDI [1K5]</b>	2,0	100/103	CBDA <D94>; CBDB <D91>	07.08-07.09		<b>0 445 010 543</b>	<b>0 986 437 410</b>
<b>Golf VI</b>							
<b>2.0 TDI, TDI 4Motion [5K1]</b>	2,0	81/100/103/125	CBAA <D94>; CBAB <D91>; CBBB <D93>; CBDC <D96>; CJAA <D91>	10.08-11.12		<b>0 445 010 543</b>	<b>0 986 437 410</b>
			CFFA <D94>; CFFB <D91>; CFGB <D93>; CLCA <D96>	11.09-11.12		<b>0 445 010 565</b>	<b>0 986 437 405</b>
<b>Golf VI Cabriolet</b>							
<b>2.0 TDI [517]</b>	2,0	81/110/103	CUUA <DN1>; CUUB <DN4>	05.15-05.16		<b>0 445 010 583</b>	<b>0 986 437 440</b>
			CFHC <D91>	11.11-05.16		<b>0 445 010 565</b>	<b>0 986 437 405</b>
<b>Golf VI Variant</b>							
<b>2.0 TDI [AJ5]</b>	2,0	81/100/103	CFHB <D94>; CFHC <D91>; CLCA <D96>	07.09-04.13		<b>0 445 010 565</b>	<b>0 986 437 405</b>
		100/103	CBDA <D94>; CBDB <D91>	07.09-04.13		<b>0 445 010 543</b>	<b>0 986 437 410</b>
<b>Golf VII</b>							
<b>1.6 TDI [BQ1]</b>	1,6	66/77/85	CLHA <D38>; DDYB <D36>	11.16→		<b>0 445 010 583</b>	<b>0 986 437 440</b>
			DDYA <DK8>				
			PR-Code FM1	11.16→		<b>0 445 010 583</b>	<b>0 986 437 440</b>
<b>TDI [5G1]</b>	1,6	66	CLHB <D36>	04.13-10.14	EU6	<b>0 445 010 583</b>	<b>0 986 437 440</b>
				04.13-12.15	EU4,EU5	<b>0 445 010 583</b>	<b>0 986 437 440</b>
			CRKA <D36>	04.13-10.14	EU6	<b>0 445 010 583</b>	<b>0 986 437 440</b>
				04.13-12.15	EU4,EU5	<b>0 445 010 583</b>	<b>0 986 437 440</b>





◀ VW

1.6 TDI [5G1]	1,6	66	CXXA <D36>	08.14-10.14 EU6	0 445 010 583	0 986 437 440	
				08.14-03.17 EU5	0 445 010 583	0 986 437 440	
			81	DBKA <DK5>	05.15-03.17 EU5	0 445 010 583	0 986 437 440
				PR-Code FM1	05.15-03.17 EU6	0 445 010 583	0 986 437 440
TDI, TDI 4Motion [5G1]	1,6	77	CLHA <D38>	08.12-10.14 EU6	0 445 010 583	0 986 437 440	
				08.12-03.17 EU4,EU5	0 445 010 583	0 986 437 440	
			81	CRKB <DK5>	01.13-10.14 EU6	0 445 010 583	0 986 437 440
				01.13-03.17 EU5	0 445 010 583	0 986 437 440	
			CXXB <DK5>	11.14-03.17 EU5	0 445 010 583	0 986 437 440	
2.0 GTD, TDI, TDI 4Motion [BQ1]	2,0	81/110/135	CRBC <DN4>; CRLB <DN4>; CRLD <DN1>; CYKB <DN1>; DCYA <DN4>; DCYB <DN1>; DEJA <DN4>; DEJB <DN1>; DGCA <DK7>	11.16->	0 445 010 583	0 986 437 440	
GTD, TDI, TDI 4Motion, TSI 4Motion [5G1]	2,0	81/105/110/135	CRBB <DN6>; CRBC <DN4>; CRLB <DN4>; CRVA <DN1>; CRVC <DN6>; CUNA <DK7>; CYKB <DN1>; DEJA <DN4>; DEJB <DN1>	08.12-03.17	0 445 010 583	0 986 437 440	

**Golf VII Variant**

1.6 TDI [BA5]	1,6	66	CLHB <D36>	05.13-10.14 EU6	0 445 010 583	0 986 437 440	
				05.13-03.17 EU4,EU5	0 445 010 583	0 986 437 440	
				CRKA <D36>	05.13-10.14 EU6	0 445 010 583	0 986 437 440
				05.13-12.15 EU5	0 445 010 583	0 986 437 440	
			81	CRKB <DK5>	05.13-10.14 EU6	0 445 010 583	0 986 437 440
				05.13-03.17 EU4,EU5	0 445 010 583	0 986 437 440	
			DBKA <DK5>	05.15-03.17 EU5	0 445 010 583	0 986 437 440	
			PR-Code FM1	05.15-03.17 EU6	0 445 010 583	0 986 437 440	
TDI [BV5]	1,6	66	DDYB <D36>	11.16->	0 445 010 583	0 986 437 440	
		85	DDYA <DK8>				
			PR-Code FM1	11.16->	0 445 010 583	0 986 437 440	
TDI, TDI 4Motion [BA5]	1,6	66/81	CXXA <D36>; CXXB <DK5>	11.14-03.17 EU5	0 445 010 583	0 986 437 440	
				05.13-10.14 EU6	0 445 010 583	0 986 437 440	
				05.13-03.17 EU4,EU5	0 445 010 583	0 986 437 440	
TDI 4Motion [BA5]	1,6	81	CRKB <DK5>	05.14-10.14 EU6	0 445 010 583	0 986 437 440	
				05.14-03.17 EU5	0 445 010 583	0 986 437 440	
2.0 GTD, TDI, TDI 4Motion [BV5]	2,0	81/110/135	CRBC <DN4>; CRLB <DN4>; CRLD <DN1>; CYKB <DN1>; DCYA <DN4>; DCYB <DN1>; DEJA <DN4>; DEJB <DN1>; DGCA <DK7>	11.16->	0 445 010 583	0 986 437 440	
TDI [BA5]	2,0	81	CRVA <DN1>	05.13-03.17	0 445 010 583	0 986 437 440	
TDI, TDI 4Motion [BA5]	2,0	81/110/135	CRLD <DN1>; CUNA <DK7>; CYKB <DN1>; DEJA <DN4>; DEJB <DN1>	11.14-03.17	0 445 010 583	0 986 437 440	
				04.13-03.17 EU4,EU5	0 445 010 583	0 986 437 440	
				05.13-03.17 EU4,EU5	0 445 010 583	0 986 437 440	
		110	CKFC <DN4>; CRBC <DN4>				
			CRLB <DN4>				

**Jetta**

2.0 D	2,0	81	CLC	03.10-08.11	0 445 010 566	0 986 437 405		
						0 986 437 420		
TDI [1K2]	2,0	81	CLCA <D96>	01.10-10.10	0 445 010 565	0 986 437 405		
				100/103/125	CBDA <D94>; CBDB <D91>; CEGA <D93>	07.08-10.10	0 445 010 543	0 986 437 410
TDI [162]	2,0	103	CFFB <D91>; CFHC <D91>; CLCB <D91>	10.10-07.14	0 445 010 565	0 986 437 405		
TDI [163]	2,0	81	CLCA <D96>	07.14-12.17	0 445 010 565	0 986 437 405		
				81/110	CUUA <DN1>; CUUB <DN4>	07.14-12.17	0 445 010 583	0 986 437 440
				103	CFFB <D91>; CLCB <D91>	08.14-12.17	0 445 010 565	0 986 437 405

**Passat**

1.6 TDI [3G2]	1,6	88	DCXA <DK5>; DCZA <DN8>	08.14->	0 445 010 583	0 986 437 440
2.0 TDI [A32]	2,0		CKRA	09.11-08.14	0 445 010 565	0 986 437 405
TDI, TDI 4Motion [3C2]	2,0	81/100/103/105/125	CBAA <D94>; CBAB <D91>; CBAC <D92>;	05.08-11.10	0 445 010 543	0 986 437 410
			CBBB <D93>; CBDC <D96>			
TDI, TDI 4Motion [3G2]	2,0	81/110/135/140	CRLD <DN1>; CUPA <DK7>; DBGA <DN4>; DFCA <DE5>; DFEA <DN4>; DFGA <DN4>; DFHA <DE5>	05.15->	0 445 010 583	0 986 437 440
				08.14->	0 445 010 583	0 986 437 440
				11.14->	0 445 010 583	0 986 437 440
				110	CRLB <DN4>	
		140	DDAA <DE5>			
TDI, TDI 4Motion [362]	2,0	100/103/125/130	CFFA <D94>; CFFB <D91>; CFGB <D93>; CFGC <DE2>; CLLA <D93>	08.10-12.14	0 445 010 565	0 986 437 405



<b>2.0</b>	TDI 4Motion [3G2]	2,0	176	CUAA <DK9>	08.14→	<b>0 445 010 811</b>	
<b>Passat Alltrack</b>							
<b>2.0</b>	TDI, TDI 4Motion [3G5]	2,0	110/140	DFGA <DN4>; DFHA <DE5>	11.17→	<b>0 445 010 583</b>	<b>0 986 437 440</b>
	TDI, TDI 4Motion [365]	2,0	103/125/130	CFFB <D91>; CFGB <D93>; CFGC <DE2>	01.12-12.14	<b>0 445 010 565</b>	<b>0 986 437 405</b>
	TDI 4Motion [3G5]	2,0	110/135/140	CRLB <DN4>; CUPA <DK7>; DDAA <DE5>; DFCA <DE5>; DFEA <DN4>	05.15→	<b>0 445 010 583</b>	<b>0 986 437 440</b>
			176	CUAA <DK9>	05.15→	<b>0 445 010 811</b>	
<b>Passat CC</b>							
<b>2.0</b>	TDI, TDI 4Motion [357]	2,0	100/103/105/125	CBAA <D94>; CBAB <D91>; CBAC <D92>; CBBB <D93>	05.08-11.10	<b>0 445 010 543</b>	<b>0 986 437 410</b>
			100/103/125	CFFA <D94>; CFFB <D91>; CFGB <D93>	11.10-05.12	<b>0 445 010 565</b>	<b>0 986 437 405</b>
<b>Passat Variant</b>							
<b>1.6</b>	TDI [3G5]	1,6	88	DCXA <DK5>; DCZA <DN8>	11.14→	<b>0 445 010 583</b>	<b>0 986 437 440</b>
<b>2.0</b>	TDI, TDI 4Motion [3C5]	2,0	81/100/103/105/125	CBAA <D94>; CBAB <D91>; CBAC <D92>; CBBB <D93>; CBDC <D96>	01.08-11.10	<b>0 445 010 543</b>	<b>0 986 437 410</b>
	TDI, TDI 4Motion [3G5]	2,0	81/110/135/140	CRLB <DN4>; CRLD <DN1>; CUPA <DK7>; DBGA <DN4>; DDAA <DE5>; DFCA <DE5>; DFEA <DN4>; DFGA <DN4>; DFHA <DE5>	11.14→	<b>0 445 010 583</b>	<b>0 986 437 440</b>
	TDI, TDI 4Motion [365]	2,0	100/103/125/130	CFFA <D94>; CFFB <D91>; CFGB <D93>; CFGC <DE2>; CLLA <D93>	08.10-12.14	<b>0 445 010 565</b>	<b>0 986 437 405</b>
	TDI 4Motion [3G5]	2,0	176	CUAA <DK9>	08.14→	<b>0 445 010 811</b>	
<b>Phaeton</b>							
<b>3.0</b>	TDI 4Motion [3D]	3,0	165/171/176/180	BMK CARA; CEXA <D50>; CEXB <D43>	09.04-05.07 06.07-03.16	<b>0 445 010 343</b> <b>0 445 010 685</b>	<b>0 986 437 348</b> <b>0 986 437 404</b>
<b>Scirocco III</b>							
<b>2.0</b>	TDI [137]	2,0	100/103/125/130	CFGB <D93>; CFGC <DE2>; CFHB <D94>; CFHC <D91>	11.10-05.14	<b>0 445 010 565</b>	<b>0 986 437 405</b>
			103/125	CBBB <D93>; CBDB <D91>	10.08-11.10	<b>0 445 010 543</b>	<b>0 986 437 410</b>
	TDI [138]	2,0	110/132/135	CUUB <DN4>; CUWA <DK7>; CUXA <DN4>	05.14-11.17	<b>0 445 010 583</b>	<b>0 986 437 440</b>
<b>Sharan</b>							
<b>2.0</b>	TDI [7N1]	2,0	85/125/130	CFFE <DE4> CFGB <D93> CFGC <DE2>	05.11-05.11 06.11-11.15 08.10-05.11 06.11-01.13 01.13-11.15	<b>0 445 010 565</b> <b>0 445 010 567</b> <b>0 445 010 565</b> <b>0 445 010 567</b> <b>0 445 010 567</b>	<b>0 986 437 405</b> <b>0 986 437 438</b> <b>0 986 437 405</b> <b>0 986 437 438</b> <b>0 986 437 438</b>
	TDI, TDI 4Motion [7N1]	2,0	100/103	CFFA <D94> CFFB <D91>	05.10-05.11 06.11-05.12 06.11-11.15 05.10-05.11 06.11-11.15	<b>0 445 010 565</b> <b>0 445 010 567</b> <b>0 445 010 567</b> <b>0 445 010 565</b> <b>0 445 010 567</b>	<b>0 986 437 405</b> <b>0 986 437 438</b> <b>0 986 437 438</b> <b>0 986 437 405</b> <b>0 986 437 438</b>
	TDI, TDI 4Motion [7N2]	2,0	85/110/135	CUVA <DE4>; CUVC <DN4>; CUWA <DK7>; DFLA <DN4>; DFLD <DE4>; DFMA <DK7>	05.15→	<b>0 445 010 583</b>	<b>0 986 437 440</b>
<b>Tiguan</b>							
<b>1.6</b>	TDI [AD1]	1,6	85	DGDB <DK8>	05.16→	<b>0 445 010 583</b>	<b>0 986 437 440</b>
<b>2.0</b>	TDI, TDI 4Motion [AD1]	2,0	81/110/85/110/140	CYKC <DN1>; DBGC <DN4> DFGA <DN4>; DFGC <DE4>; DFHA <DE5>	10.16→ 01.16→	<b>0 445 010 583</b> <b>0 445 010 583</b>	<b>0 986 437 440</b> <b>0 986 437 440</b>
	TDI, TDI 4Motion [5N1]	2,0	81/100/103/125	CFFA <D94>; CFFB <D91>; CFFD <D96>; CFGB <D93>	11.09-05.11	<b>0 445 010 565</b>	<b>0 986 437 405</b>
			100/103/120/125	CBAA <D94>; CBAB <D91>; CBBA <D95>; CBBB <D93>	11.07-05.11	<b>0 445 010 543</b>	<b>0 986 437 410</b>
	TDI, TDI 4Motion [5N2]	2,0	81/100/103/130	CFFA <D94>; CFFB <D91>; CFFD <D96>; CFGC <DE2>; CLJA <D91>	05.11-12.16	<b>0 445 010 562</b>	<b>0 986 437 434</b>
			81/110/135	CUVC <DN4>; CUVE <DN1>; CUWA <DK7>	05.15-12.16	<b>0 445 010 583</b>	<b>0 986 437 440</b>
	TDI 4Motion [AD1]	2,0	176	CUAA <DK9>	05.16→	<b>0 445 010 811</b>	
	TDI 4Motion [BT1]	2,0	110	DBGC <DN4>	10.16→	<b>0 445 010 583</b>	<b>0 986 437 440</b>
	TDI 4Motion [5N1]	2,0	103	CLJA <D91>	11.10-05.11	<b>0 445 010 562</b>	<b>0 986 437 434</b>







◀ VW

2.0 TDI 4Motion [5N2]	2,0	103	CBAB <D91>	05.11-12.16	0 445 010 543	0 986 437 410
		125	CFGB <D93>	05.11-05.13	0 445 010 562	0 986 437 434

**Tiguan Allspace**

2.0 TDI, TDI 4Motion [BW2]	2,0	110/140	DBGC <DN4>; DFGA <DN4>; DFHA <DE5>	06.17→	0 445 010 583	0 986 437 440
TDI 4Motion [BW2]	2,0	176	CUAA <DK9>	06.17→	0 445 010 811	

**Touareg**

3.0 TDI [CR7]	3,0	183/190/210	CVMC <DD7>; CVMD <DD9>; DENA <DV8>	11.17→	0 445 010 824		
TDI [7LA]	3,0	155	BUN	04.06-11.06	0 445 010 331	0 986 437 093	
		165	BKS				
			Fg.-Nr. →7L..6..040 000	11.04-11.05	0 445 010 343	0 986 437 348	
			Fg.-Nr. 7L..6..040 001→	12.05-11.06	0 445 010 331	0 986 437 093	
TDI [7L6]	3,0	155/165	BKS; BUN	12.06-05.08	0 445 010 331	0 986 437 093	
		155/176	CASA <D50>; CASB; CASC	11.07-05.10	0 445 010 685	0 986 437 404	
		165	CATA	05.09-04.10	0 445 010 694		
				05.10-05.10	0 445 010 685	0 986 437 404	
TDI [7P5]	3,0	150/176	CASA <D50>; CASD <D1Q>	01.10-05.11	0 445 010 685	0 986 437 404	
		150/180	CJMA; CRCA <D43>	05.11-12.14	0 445 010 676	0 986 437 435	
TDI [7P6]	3,0	150	CVVA <D1Q>	08.14→	UV2	0 445 010 692	0 986 437 435
					6PL,EU6	0 445 010 676	0 986 437 435
		150/180	CJMA <D1Q>; CRCA <D43>	08.14→		0 445 010 676	0 986 437 435
		193	CVVA <DV7>	08.14→	UV2	0 445 010 692	0 986 437 435
				6PL,EU6	0 445 010 676	0 986 437 435	

4.2 TDI [7P5]	4,2	250	CKDA <D57>	01.10-12.14	0 445 010 801	0 986 437 418
TDI [7P6]	4,2	250	CKDA <D57>	08.14→	0 445 010 801	0 986 437 418

**Touran**

1.6 TDI [5T1]	1,6	81/85	CRKB <DK5>; DGDA <DK8>	05.15→	0 445 010 583	0 986 437 440
2.0 TDI [1T3]	2,0	81/103/125/130	CFHC <D91>; CFHF <D96>; CFJA <D93>; CFJB <DE2>; CLCA <D96>	05.10-05.15	0 445 010 565	0 986 437 405
		81/110/140	CRVA <DN1>; CYKB <DN1>; DFEA <DN4>; DFEB <DN1>; DFGA <DN4>; DFGB <DN1>; DFHA <DE5>	05.15→	0 445 010 583	0 986 437 440

**T-Roc**

2.0 TDI, TDI 4Motion [A11]	2,0	110	DFFA <DN4>	09.17→	0 445 010 583	0 986 437 440
----------------------------	-----	-----	------------	--------	---------------	---------------





**AMUR (AUTOM.AND MOTOR OF URAL)**

10t						
531320	4,8	100	D 245.9 E3 <Euro 3>		01.08→	0 445 020 088
11t						
341240	4,8	111,4	D 245.30 E3 <Euro 3>		04.09→	0 445 020 088
541340	4,8	111,4	D 245.30 E3 <Euro 3>		04.09→	0 445 020 088

**ASTRA**

HD9C-Serie						
HD9	12,9	368/412	F3HFE611A+; F3HFE611B+		10.15→	0 445 020 195 0 986 437 512

**BAW**

Fenix						
1044	3,2	76	CA4DC2-10E3 <Euro 3>		04.08-12.11	0 445 010 158
1065	3,2	88	CA4DC2-12E3 <Euro 3>		04.08-12.11	0 445 010 158

**CITROEN**

Jumper						
2.0 HDi [U5]	2,0	62	RHV <DW10TD>		02.02-05.06	0 445 010 046 0 986 437 017
HDi [23]	2,0	62	RHV <DW10TD>		03.01-02.02	0 445 010 046 0 986 437 017
2.2 HDi [U5]	2,2	74	4HY <DW12TED>		02.02-12.06	0 445 010 046 0 986 437 017
2.8 HDi [U5]	2,8	94	8140.43S		02.02-05.06	0 445 020 002 0 986 437 501
			8140 43N <SOFIM 2800 HDi>		08.04-05.06	0 445 020 006 0 986 437 502
			8140.43S		09.00-02.02	0 445 020 002 0 986 437 501
HDi [23]	2,8	94	8140.43S		09.00-02.02	0 445 020 002 0 986 437 501
HDI	2,8	93	8140.43S		09.05-09.09	0 445 020 002 0 986 437 501
3.0 HDi [U6]	3,0	130	F1CE3481E <30 DT PEF EURO5 175>		03.11→	0 445 010 559 0 986 437 437
			F1CE3481... <30 DT PEF EURO5 155>; F1CE3481N <30 DT PEF EURO5 145>		01.10→	0 445 010 559 0 986 437 437
			F1CE0481D <SOFIM F 30DT/ PEF>			
			Mot.-Nr. →980091		06.06-12.11	0 445 020 046 0 986 437 321
			Mot.-Nr. 980092→		06.06-12.11	0 445 010 559 0 986 437 437

**DAF**

CF						
65 .180, .220, .250	5,9	136/162/184	CE 136 <Euro3>; CE 162 <Euro3>; CE 184 C <Euro3>		01.01-01.07	0 445 020 007 0 986 437 341
.220, .250	6,7	165/184	GR 165 <Euro 4/5/EEV>; GR 184 <Euro 4/5/EEV>		04.06→ TW	0 445 020 045 0 986 437 342 0 445 020 137 0 986 437 319
.280	6,7	210	GR 210 <Euro 4/5>		04.07→ EU4	0 445 020 045 0 986 437 342
.300	6,7	220	GR 220 <Euro 5/EEV>		07.09→ EU5	0 445 020 137 0 986 437 319 0 445 020 137 0 986 437 319
LF						
45 .130	3,9	99	BE 99 <Euro 3>		11.01-09.06	0 445 020 007 0 986 437 341
.140	4,5	103	FR 103 <Euro 4/5>		07.06→ TW	0 445 020 045 0 986 437 342 0 445 020 137 0 986 437 319
.150	3,9	110	BE 110 C <Euro 3>		04.01-10.07	0 445 020 007 0 986 437 341
.160	4,5	118	FR 118 <Euro 4/5/EEV>		05.06→ TW	0 445 020 045 0 986 437 342 0 445 020 137 0 986 437 319
.170	3,9	123	BE 123 C <Euro 3>		04.01-12.07 TW	0 445 020 007 0 986 437 341 0 445 020 045 0 986 437 342





◀ DAF

45	.180	4,5	136	FR 136 <Euro 4/5>	05.06→	TW	0 445 020 045	0 986 437 342
							0 445 020 137	0 986 437 319
		5,9	136	CE 136 C <Euro 3>	07.01-12.08		0 445 020 007	0 986 437 341
	.210	4,5	152	FR 152 <Euro 5/EEV>	09.09→		0 445 020 137	0 986 437 319
	.220	5,9	162	CE 162 C <Euro 3>	11.01-01.09	TW	0 445 020 007	0 986 437 341
		6,7	165	GR 165 <Euro 4/5/EEV>	09.06→	TW	0 445 020 045	0 986 437 342
							0 445 020 137	0 986 437 319
	.250	6,7	184	GR 184 <Euro 4/5/EEV>	09.06→	TW	0 445 020 045	0 986 437 342
								0 445 020 137
55	.180	4,5	136	FR 136 <Euro 4/5>	04.06→	TW	0 445 020 045	0 986 437 342
							0 445 020 137	0 986 437 319
		5,9	136	CE 136 C <Euro 3>	04.01-08.08		0 445 020 007	0 986 437 341
	.210	4,5	152	FR 152 <Euro 5/EEV>	02.09→		0 445 020 137	0 986 437 319
	.220	5,9	162	CE 162 C <Euro 3>	04.01-08.08	TW	0 445 020 007	0 986 437 341
		6,7	165	GR 165 <Euro 4/5/EEV>	04.06→	TW	0 445 020 045	0 986 437 342
							0 445 020 137	0 986 437 319
	.250	5,9	184	CE 184 C <Euro3>	04.01-08.08	TW	0 445 020 007	0 986 437 341
			6,7	184	GR 184 <Euro 4/5/EEV>	04.06→	TW	0 445 020 045
							0 445 020 137	0 986 437 319
	.280	6,7	210	GR 210 <Euro 4/5>	04.06→	TW	0 445 020 045	0 986 437 342
							0 445 020 137	0 986 437 319
	.300	6,7	220	GR 220 <Euro 5/EEV>	02.09→		0 445 020 137	0 986 437 319

**DODGE**

**Ram 4500**

6.7		6,7		ETJ	09.08-08.10		0 445 020 146	0 986 437 334
-----	--	-----	--	-----	-------------	--	---------------	---------------

**Sprinter 2500**

2.7 [VA]		2,7	115	OM 612	01.03-12.03		0 445 010 270	0 986 437 102
							0 445 010 275	0 986 437 106

**FIAT**

**Ducato Cargo**

2.8 JTD		2,8	93	8140.43S	06.05-08.09		0 445 020 002	0 986 437 501
---------	--	-----	----	----------	-------------	--	---------------	---------------

**Ducato Maxi 17**

120 Multijet [250]		2,3	88	F1AE0481D <M94>	06.06-12.14		0 445 010 318	0 986 437 085
130 Multijet [250]		2,3	96	F1AE0481N <M95>	06.06-12.14		0 445 010 318	0 986 437 085
160 Multijet [250]		3,0	116	F1CE0481D <M96>				
				Mot.-Nr. →980092	06.06-12.14	0 445 020 046	0 986 437 321	
				Mot.-Nr. 980093→	06.06-12.14		0 445 010 222	

**Ducato Maxi 20**

120 Multijet [250]		2,3	88	F1AE0481D <M94>	06.06-12.14		0 445 010 318	0 986 437 085
130 Multijet [250]		2,3	96	F1AE0481N <M95>	06.06-12.14		0 445 010 318	0 986 437 085
160 Multijet [250]		3,0	116	F1CE0481D <M96>				
				Mot.-Nr. →980092	06.06-12.14	0 445 020 046	0 986 437 321	
				Mot.-Nr. 980093→	06.06-12.14		0 445 010 222	

**Ducato Minibus**









2.8 JTD		2,8	93	8140.43S	06.05-08.09		0 445 020 002	0 986 437 501
---------	--	-----	----	----------	-------------	--	---------------	---------------

**Ducato 10**

2.8 JTD, JTD EGR, JTD EGR 4x4, JTD 4x4 [230]		2,8	94	8140.43S <M13>; 8140.43S <M14>	08.00-03.02		0 445 020 002	0 986 437 501
--	--	-----	----	--------------------------------	-------------	--	---------------	---------------

**Ducato 11**

2.3 JTD [244]		2,3	81	F1AE0481C <M10>	04.02-08.06		0 445 020 008	0 986 437 318
				Mot.-Nr. →1484468	01.08-12.11		0 445 010 318	0 986 437 085
				Mot.-Nr. 1484469→	01.08-12.11		0 445 010 401	
JTD EGR [244]		2,3	81	F1AE0481C <M11>	04.02-08.06		0 445 020 008	0 986 437 318

									
<b>2.8</b> JTD, JTD EGR, JTD EGR 4x4, JTD 4x4 [244]	2,8	94	8140.43S <M15>		04.02-08.06			<b>0 445 020 002</b>	<b>0 986 437 501</b>
<b>110</b> Multijet [250]	2,3	83	F1AE3481G		10.11-12.14			<b>0 445 010 320</b>	<b>0 986 437 096</b>
<b>115</b> Multijet [250]	2,0	85	250 A1.000		06.11-09.14			<b>0 445 010 466</b>	<b>0 986 437 095</b>
					10.14-12.14			<b>0 445 010 438</b>	
<b>120</b> Multijet [250]	2,3	88	F1AE0481D <M94>		06.06-12.14			<b>0 445 010 318</b>	<b>0 986 437 085</b>
<b>130</b> Multijet [250]	2,3	96	F1AE0481N <M95>		06.06-12.14			<b>0 445 010 318</b>	<b>0 986 437 085</b>
			F1AE3481D		06.11-12.14			<b>0 445 010 320</b>	<b>0 986 437 096</b>
<b>150</b> Multijet [250]	2,3	109	F1AE3481E		06.11-12.14			<b>0 445 010 320</b>	<b>0 986 437 096</b>
<b>160</b> Multijet [250]	3,0	116	F1CE0481D <M96>						
			Mot.-Nr. →980092		06.06-12.14			<b>0 445 020 046</b>	<b>0 986 437 321</b>
			Mot.-Nr. 980093→		06.06-12.14			<b>0 445 010 222</b>	
<b>180</b> Multijet [250]	3,0	130	F1CE3481E		06.11-12.14			<b>0 445 010 545</b>	<b>0 986 437 437</b>
<b>Ducato 14</b>									
<b>2.8</b> JTD, JTD EGR, JTD EGR 4x4, JTD 4x4 [230]	2,8	94	8140.43S <M13>; 8140.43S <M14>		08.00-03.02			<b>0 445 020 002</b>	<b>0 986 437 501</b>
<b>110</b> MultiJet [290]	2,3	83	F1AE3481G		05.14-11.16 TW			<b>0 445 010 320</b>	<b>0 986 437 096</b>
								<b>0 445 010 452</b>	
<b>115</b> MultiJet [290]	2,0	85	250 A1.000		05.14-09.14			<b>0 445 010 466</b>	<b>0 986 437 095</b>
					10.14-06.16			<b>0 445 010 438</b>	
			250 A2.000		07.16→			<b>0 445 010 438</b>	
<b>130</b> MultiJet [290]	2,3	96	F1AE3481D		05.14-11.16 TW			<b>0 445 010 320</b>	<b>0 986 437 096</b>
								<b>0 445 010 452</b>	
			F1AGL411...		06.16→			<b>0 445 010 320</b>	<b>0 986 437 096</b>
<b>150</b> EcoJet, MultiJet [290]	2,3	110	F1AGL411A; F1AGL411C		06.15→			<b>0 445 010 320</b>	<b>0 986 437 096</b>
MultiJet [290]	2,3	109	F1AE3481E		05.14-11.16 TW			<b>0 445 010 320</b>	<b>0 986 437 096</b>
								<b>0 445 010 452</b>	
<b>180</b> MultiJet [290]	2,3	130	F1AGL411B		06.16→			<b>0 445 010 465</b>	
	3,0	130	F1CE3481E		05.14-11.16			<b>0 445 010 545</b>	<b>0 986 437 437</b>
<b>Ducato 15</b>									
<b>2.3</b> JTD [244]	2,3	81	F1AE0481C <M10>		04.02-08.06			<b>0 445 020 008</b>	<b>0 986 437 318</b>
			Mot.-Nr. →1484468		01.08-12.11			<b>0 445 010 318</b>	<b>0 986 437 085</b>
			Mot.-Nr. 1484469→		01.08-12.11			<b>0 445 010 401</b>	
JTD EGR [244]	2,3	81	F1AE0481C <M11>		04.02-08.06			<b>0 445 020 008</b>	<b>0 986 437 318</b>
			Mot.-Nr. →1484468		01.08-12.11			<b>0 445 010 318</b>	<b>0 986 437 085</b>
			Mot.-Nr. 1484469→		01.08-12.11			<b>0 445 010 401</b>	
<b>2.8</b> JTD CGV [244]	2,8	107	8140.43N <M22>		04.04-08.06			<b>0 445 020 006</b>	<b>0 986 437 502</b>
JTD, JTD EGR, JTD EGR 4x4, JTD 4x4 [244]	2,8	94	8140.43S <M15>		04.02-08.06			<b>0 445 020 002</b>	<b>0 986 437 501</b>
<b>120</b> Multijet [250]	2,3	88	F1AE0481D <M94>		06.06-12.14			<b>0 445 010 318</b>	<b>0 986 437 085</b>
<b>130</b> Multijet [250]	2,3	96	F1AE0481N <M95>		06.06-12.14			<b>0 445 010 318</b>	<b>0 986 437 085</b>
<b>160</b> Multijet [250]	3,0	116	F1CE0481D <M96>						
			Mot.-Nr. →980092		06.06-12.14			<b>0 445 020 046</b>	<b>0 986 437 321</b>
			Mot.-Nr. 980093→		06.06-12.14			<b>0 445 010 222</b>	
<b>Ducato 17</b>									
<b>120</b> Multijet [250]	2,3	88	F1AE0481D <M94>		06.06-12.14			<b>0 445 010 318</b>	<b>0 986 437 085</b>
<b>130</b> Multijet [250]	2,3	96	F1AE0481N <M95>		06.06-12.14			<b>0 445 010 318</b>	<b>0 986 437 085</b>
<b>150</b> Multijet [250]	3,0	107	F1CE3481N <M97>		04.10-12.14			<b>0 445 010 545</b>	<b>0 986 437 437</b>
<b>160</b> Multijet [250]	3,0	116	F1CE0481D <M96>						
			Mot.-Nr. →980092		06.06-12.14			<b>0 445 020 046</b>	<b>0 986 437 321</b>
			Mot.-Nr. 980093→		06.06-12.14			<b>0 445 010 222</b>	
<b>Ducato 18</b>									
<b>2.3</b> JTD [244]	2,3	81	F1AE0481C <M10>		04.02-08.06			<b>0 445 020 008</b>	<b>0 986 437 318</b>
			Mot.-Nr. →1484468		01.08-12.11			<b>0 445 010 318</b>	<b>0 986 437 085</b>
			Mot.-Nr. 1484469→		01.08-12.11			<b>0 445 010 401</b>	
JTD EGR [244]	2,3	81	F1AE0481C <M11>		04.02-08.06			<b>0 445 020 008</b>	<b>0 986 437 318</b>
			Mot.-Nr. →1484468		01.08-12.11			<b>0 445 010 318</b>	<b>0 986 437 085</b>
			Mot.-Nr. 1484469→		01.08-12.11			<b>0 445 010 401</b>	
<b>2.8</b> JTD CGV [244]	2,8	107	8140.43N <M22>		04.04-08.06			<b>0 445 020 006</b>	<b>0 986 437 502</b>
JTD, JTD EGR, JTD EGR 4x4, JTD 4x4 [230]	2,8	94	8140.43S <M13>; 8140.43S <M14>		08.00-03.02			<b>0 445 020 002</b>	<b>0 986 437 501</b>
JTD, JTD EGR, JTD EGR 4x4, JTD 4x4 [244]	2,8	94	8140.43S <M15>		04.02-08.06			<b>0 445 020 002</b>	<b>0 986 437 501</b>





◀ FIAT

Ducato 20							
150 Multijet [250]	3,0	107	F1CE3481N <M97>		09.10-12.14	0 445 010 545	0 986 437 437
160 Multijet [250]	3,0	115	F1CE3481M <M99>		09.10-12.14	0 445 010 545	0 986 437 437

**FORD**

Cargo							
1830	7,3	221	ECOTORQ 300 <Euro 3>		08.03-11.06	0 445 020 019	
2524	7,3	176	ECOTORQ 240 <Euro 3>		08.03-11.06	0 445 020 019	
2530	7,3	221	ECOTORQ 300 <Euro 3>		08.03-11.06	0 445 020 019	
3230	7,3	221	ECOTORQ 300 <Euro 3>		08.03-11.06	0 445 020 019	
Transit Connect							
1.5 TDCi [13]	1,5	55/74/88	XUGA <Euro 6>; XVG... <Euro 6>; XWG... <Euro 6>; XXGA <Euro 6>		06.15→	0 445 010 591	0 986 437 446
Transit Courier							
1.5 TDCi [14]	1,5	55	UGC... <Euro 5>		04.14-12.17	0 445 010 576	0 986 437 449
		55/70	XUC... <Euro 6>; XVC... <Euro 6>		06.15→	0 445 010 591	0 986 437 446
	1,6	70	T3C... <Euro 5>		04.14-12.17	0 445 010 576	0 986 437 449

**GALICH CRANE PLANT**

50t							
KS-64713 -2	11,1	303	650.10 <Euro 3>		01.10→	0 445 020 086	

**GAZ**

GAZelle							
2.7 TD [2705,3221,3302]	2,7	80	ADCR110 <Euro 4>		01.07-03.13	0 445 010 177	
2.8 TD [2705,3221,3302]	2,8	102,7	ISF 2.8s3148T <Euro 3>		08.10-03.13	0 445 020 119	
		88,3	ISF 2.8s3129T <Euro 3>		08.10-03.13	0 445 020 119	
GAZon							
4.8 TD [3309]	4,8	90-92,2	D 245.7 E3 <Euro 3>; D 245.7 E4 <Euro 4>		01.08→	0 445 020 088	
Sadko							
4.8 TD [3308]	4,8	87-90	D 245.7 E3 <Euro 3>; D 245.7 E4 <Euro 4>		01.08→	0 445 020 088	
Sobol							
2.8 TD [2217,2310,2752]	2,8	88,3/ 102,7	ISF 2.8s3129T <Euro 3>; ISF 2.8s3148T <Euro 3>		08.10→	0 445 020 119	
Valday							
3.8 TD [3310]	3,8	125	ISF 3.8 <Euro 3>		12.11→	0 445 020 045	0 986 437 342
4.8 TD [3310]	4,8	90-92,2	D 245.7 E3 <Euro 3>; D 245.7 E4 <Euro 4>		01.08→	0 445 020 088	

**HEULIEZ**

Access` Bus GX							
427	7,8	280	F2CFE612C <EEV>		09.07-12.13 TW	0 445 020 093	0 986 437 389
						0 445 020 175	0 986 437 341
GX Acces Bus							
127, 127 L	5,9	194	F4AE3682 <EEV>		06.09→	0 445 020 175	0 986 437 341
GX Access Bus							
127, 127 L	5,9	160	F4AE3682 <Euro 4/5>		03.06→	0 445 020 175	0 986 437 341
Serie GX							
Access` Bus 137, 137 L, 337, 337 L	6,7	184/210- 213	F4AFE612F <Tector 7 - Euro 6>		09.15→	0 445 020 175	0 986 437 341
Access` Bus 437, 437 L	8,7	265/294	F2CFE612A <Cursor 9 - Euro 6>; F2CFE612B <Cursor 9 - Euro 6>		09.15→	0 445 020 093	0 986 437 389



## HYUNDAI

H-1						
2.5 CRDi	2,5	81/103	D4CB		12.01-05.04	0 445 010 354
					06.04-12.06	0 445 010 355 0 986 437 369
					01.07-12.07	0 445 010 399 0 986 437 029
H-1 Cargo						
2.5 CRDi	2,5	81-85/ 100	D4CB... <(6A) A25/(6B) A25B>; D4CB <(6A) A25/(6B) A25B>		12.08-10.10	0 445 010 333
		120-125	D4CB... <(6A) A25>		03.08-05.08	0 445 010 399 0 986 437 029
					06.08-10.10	0 445 010 333
H-1 Travel						
2.5 CRDi	2,5	81-85/ 100	D4CB... <(6A) A25/(6B) A25B>; D4CB <(6A) A25/(6B) A25B>		07.08-10.10	0 445 010 333
		120-125	D4CB <(6A) A25>		03.08-05.08	0 445 010 399 0 986 437 029
					06.08-10.10	0 445 010 333
H100						
2.5 CRDi	2,5	95	D4CB <(6A) A25/(6B) A25B>		01.09-12.11	EU6 0 445 010 333
Starex						
2.5 CRDi	2,5	103	D4CB		10.02-05.04	0 445 010 354
					06.04-01.07	0 445 010 355 0 986 437 369
		107	D4CB		12.03-05.07	0 445 010 101 0 986 437 369

## IRISBUS

Proway						
	5,9	160	F4AE3681 <Euro 4/5>		06.06-12.13	0 445 020 175 0 986 437 341

## IVECO

CityClass						
2.8 D	2,8	92	8140.43S		10.05-07.07	0 445 020 002 0 986 437 501
45 S 17	3,0	125	F1CDS <Euro 5 / P-7 (EGR)>		10.12→	0 445 010 559 0 986 437 437
55 S 17	3,0	125	F1CDS <Euro 5 / P-7 (EGR)>		10.12→	0 445 010 559 0 986 437 437
Crossway						
6.7	6,7	210/235	F4AFE612D <Tector 7 - Euro 6>; F4AFE612F <Tector 7 - Euro 6>		07.14→	0 445 020 175 0 986 437 341
8.7	8,7	265/294	F2CFE612A <Cursor 9 - Euro 6>; F2CFE612B <Cursor 9 - Euro 6>		07.14→	0 445 020 093 0 986 437 389
Crossway LE						
6.7	6,7	210/235	F4AFE612D <Tector 7 - Euro 6>; F4AFE612F <Tector 7 - Euro 6>		07.14→	0 445 020 175 0 986 437 341
8.7	8,7	265/294	F2CFE612A <Cursor 9 - Euro 6>; F2CFE612B <Cursor 9 - Euro 6>		07.14→	0 445 020 093 0 986 437 389
Daily						
29 L 9, 13 [00]	2,8	66/92	8140.43R.43...; 8140.43S		10.00-03.06	0 445 020 002 0 986 437 501
10, 12, 14 [00]	2,3	70/85/ 100	F1AE0481A...; F1AE0481B...; F1AE0481M..		09.02-03.06	0 445 020 008 0 986 437 318
10, 12, 14 [06]	2,3	71/85/ 100	F1AE0481F*...; F1AE0481G*...; F1AE0481H*...		04.06-12.11	0 445 010 318 0 986 437 085
11, 13, 15 [12]	2,3	78/93/ 146	F1AE3481A*A0...; F1AE3481B*A0...; F1AE3481C..		07.11-07.14	0 445 010 320 0 986 437 096
30 S 18 [14]	3,0	132	F1CFL411W <Euro 6>		07.17→	0 445 010 593 0 986 437 461
33 S 11, 13, 15 [14]	2,3	78/93/ 107	F1AFL411A*A; F1AFL411B*A; F1AFL411C*A		05.14→	0 445 010 320 0 986 437 096
33-120 [16]	2,3	85	F1AGL411H <Euro 6>		07.16→	0 445 010 320 0 986 437 096
33-140 [16]	2,3	100	F1AGL411J <Euro 6>		07.16→	0 445 010 320 0 986 437 096
33-160 [16]	2,3	110- 114,6	F1AGL411... <Euro 6>		07.16→	0 445 010 320 0 986 437 096





◀ IVECO

<b>35 13</b>	2,8	92	8140.43S		10.05-07.07	<b>0 445 020 002</b>	<b>0 986 437 501</b>
<b>35 C 9 [00]</b>	2,8	66	8140.43R...		08.01-09.04	<b>0 445 020 002</b>	<b>0 986 437 501</b>
10, 12, 14 [00]	2,3	70/85/100	F1AE0481A*; F1AE0481B*; F1AE0481M..		09.02-03.06	<b>0 445 020 008</b>	<b>0 986 437 318</b>
10, 12, 14 [06]	2,3	71/85/100	F1AE0481F*B...; F1AE0481G*...; F1AE0481H...; F1AE0481R..		04.06-12.11	<b>0 445 010 318</b>	<b>0 986 437 085</b>
11 [12]	2,3	78	F1AE3481A*A0...aa		07.11-07.14	<b>0 445 010 320</b>	<b>0 986 437 096</b>
11, 13 [00]	2,8	78/92	8140.43B.43...; 8140.43S...		05.99-09.04	<b>0 445 020 002</b>	<b>0 986 437 501</b>
11, 13 [09]	2,3	78/93	F1AE0481U*...; F1AE0481V*...		06.09-12.11	<b>0 445 010 318</b>	<b>0 986 437 085</b>
11, 13, 15 [14]	2,3	78/93/107	F1AFL411A*A; F1AFL411B*A; F1AFL411C*A		05.14→	<b>0 445 010 320</b>	<b>0 986 437 096</b>
13 [12]	2,3	93	F1AE3481B*A0...		07.11-07.14 TW	<b>0 445 010 320</b>	<b>0 986 437 096</b>
						<b>0 445 010 559</b>	<b>0 986 437 437</b>
14, 17 [00]	3,0	100/122	F1CE0481A...; F1CE0481B		09.04-03.06	<b>0 445 010 098</b>	<b>0 986 437 386</b>
14, 17 [09]	3,0	103/125	F1CE3481C*...; F1CE3481L*C..		06.09-12.11	<b>0 445 010 559</b>	<b>0 986 437 437</b>
15 [00]	2,8	108	8140.43N.43...		05.01-09.04	<b>0 445 020 040</b>	
15 [12]	2,3	107	F1AE3481C*A034		07.12-07.14	<b>0 445 010 320</b>	<b>0 986 437 096</b>
15, 17 [14]	3,0	107/125	F1CFL411E*C; F1CFL411F*C		05.14→	<b>0 445 010 593</b>	<b>0 986 437 461</b>
15, 17, 21 [12]	3,0	107/125/150	F1CE3481...; F1CE3481D*B13...		07.11-07.14	<b>0 445 010 559</b>	<b>0 986 437 437</b>
15, 17, 21 [14]	3,0	107/125/150	F1CFL411G*C; F1CFL411H*C; F1CFL411J*C		05.14→	<b>0 445 010 559</b>	<b>0 986 437 437</b>
15, 18 [06]	3,0	107/130	F1CE0481F*...; F1CE0481H*...		04.06-12.11	<b>0 445 020 046</b>	<b>0 986 437 321</b>
<b>35 S 9 [00]</b>	2,8	66	8140.43R...		08.01-03.06	<b>0 445 020 002</b>	<b>0 986 437 501</b>
10, 12, 14 [00]	2,3	70/85/100	F1AE0481A*; F1AE0481B...; F1AE0481M..		09.02-03.06	<b>0 445 020 008</b>	<b>0 986 437 318</b>
10, 12, 14 [06]	2,3	71/85/100	F1AE0481F*...; F1AE0481G...; F1AE0481H*...; F1AE0481R..		04.06-12.11	<b>0 445 010 318</b>	<b>0 986 437 085</b>
11, 13 [00]	2,8	78/92	8140.43B.43...; 8140.43S...		05.99-03.06	<b>0 445 020 002</b>	<b>0 986 437 501</b>
11, 13 [09]	2,3	78/93	F1AE0481U*...; F1AE0481V*...		06.09-12.11	<b>0 445 010 318</b>	<b>0 986 437 085</b>
11, 13, 15 [12]	2,3	78/93/107	F1AE3481A...; F1AE3481B*A0...; F1AE3481C..		07.11-07.14	<b>0 445 010 320</b>	<b>0 986 437 096</b>
11, 13, 15 [14]	2,3	78/93/107	F1AFL411A*A; F1AFL411B*A; F1AFL411C*A		05.14→	<b>0 445 010 320</b>	<b>0 986 437 096</b>
14	3,0	100	F1CE0481 <Euro 3>		08.07-03.12	<b>0 445 020 046</b>	<b>0 986 437 321</b>
14, 17 [00]	3,0	100/122	F1CE0481A...; F1CE0481B		09.04-03.06	<b>0 445 010 098</b>	<b>0 986 437 386</b>
14, 17 [09]	3,0	103/125	F1CE3481C*...; F1CE3481L*C..		06.09-12.11	<b>0 445 010 559</b>	<b>0 986 437 437</b>
15 [00]	2,8	108	8140.43N.43... 8140.43N.43...		05.03-09.06 05.01-03.06	<b>0 445 020 040</b> <b>0 445 020 040</b>	
15, 17 [14]	3,0	107/125	F1CFL411E*C; F1CFL411F*C		05.14→	<b>0 445 010 593</b>	<b>0 986 437 461</b>
15, 17, 21 [12]	3,0	107/125/150	F1CE3481...; F1CE3481D..		07.11-07.14	<b>0 445 010 559</b>	<b>0 986 437 437</b>
15, 17, 21 [14]	3,0	107/125/150	F1CFL411G*C; F1CFL411H*C; F1CFL411J*C		05.14→	<b>0 445 010 559</b>	<b>0 986 437 437</b>
15, 18 [06]	3,0	107/130	F1CE0481...; F1CE0481H*...		04.06-12.11	<b>0 445 020 046</b>	<b>0 986 437 321</b>
18 [09]	3,0	130	F1CE3481H..		11.10-12.11	<b>0 445 020 046</b>	<b>0 986 437 321</b>
<b>35-120 [16]</b>	2,3	85	F1AGL411H <Euro 6>		07.16→	<b>0 445 010 320</b>	<b>0 986 437 096</b>
<b>35-130 [16]</b>	2,3	93	F1AFL411B*A		07.17→	<b>0 445 010 320</b>	<b>0 986 437 096</b>
<b>35-140 [16]</b>	2,3	100	F1AGL411... <EURO 6>		07.16→	<b>0 445 010 320</b>	<b>0 986 437 096</b>
<b>35-150 [16]</b>	3,0	110	F1C... <Euro 6>		07.16→	<b>0 445 010 593</b>	<b>0 986 437 461</b>
<b>35-160 [16]</b>	2,3	110-114,6	F1AGL411... <Euro 6>; F1AGL411... <EURO 6>		07.16→	<b>0 445 010 320</b>	<b>0 986 437 096</b>
<b>35-180 [16]</b>	3,0	132	F1C... <Euro 6>		07.16→	<b>0 445 010 593</b>	<b>0 986 437 461</b>
<b>35-210 [16]</b>	3,0	150	F1CGL411C <Euro 6>		07.16→	<b>0 445 010 593</b>	<b>0 986 437 461</b>
<b>38 13</b>	2,8	92	8140.43S		10.05-07.07	<b>0 445 020 002</b>	<b>0 986 437 501</b>
<b>40 13</b>	2,8	92	8140.43S		10.05-07.07	<b>0 445 020 002</b>	<b>0 986 437 501</b>
<b>40 C 10, 12 [06]</b>	2,3	71/85	F1AE0481F...; F1AE0481G..		04.06-05.09	<b>0 445 010 318</b>	<b>0 986 437 085</b>
11, 13 [09]	2,3	78/93	F1AE0481U...; F1AE0481V..		06.09-12.11	<b>0 445 010 318</b>	<b>0 986 437 085</b>
11, 13 [12]	2,3	78/93	F1AE3481A*A00...; F1AE3481B*A00...		01.12-07.14	<b>0 445 010 320</b>	<b>0 986 437 096</b>
13 [00]	2,8	92	8140.43S...		01.01-09.04	<b>0 445 020 002</b>	<b>0 986 437 501</b>
14, 17 [00]	3,0	100/122	F1CE0481A...; F1CE0481B		09.04-03.06	<b>0 445 010 098</b>	<b>0 986 437 386</b>











									
	l/ccm	kW/(PS)	Typ						eXchange
<b>40 C</b> 14, 17 [09]	3,0	103/125	F1CE3481C...; F1CE3481C*..		06.09-12.11			<b>0 445 010 559</b>	<b>0 986 437 437</b>
15 [00]	2,8	108	8140.43N.43..		04.03-09.04			<b>0 445 020 040</b>	
15, 17 [14]	3,0	107/125	F1CFL411E*C; F1CFL411F*C		05.14→			<b>0 445 010 593</b>	<b>0 986 437 461</b>
15, 17, 21 [12]	3,0	107/125/150	F1CE3481...; F1CE3481D*B13...		01.12-07.14			<b>0 445 010 559</b>	<b>0 986 437 437</b>
15, 17, 21 [14]	3,0	107/125/150	F1CFL411G*C; F1CFL411H*C; F1CFL411J*C		05.14→			<b>0 445 010 559</b>	<b>0 986 437 437</b>
15, 18 [06]	3,0	107/130	F1CE0481...; F1CE0481H..		04.06-12.11			<b>0 445 020 046</b>	<b>0 986 437 321</b>
<b>40 S</b> 16	3,0	114	F1CE0481 <Euro 3>		08.07-03.12			<b>0 445 020 046</b>	<b>0 986 437 321</b>
<b>40-150</b> [16]	3,0	110	F1C... <Euro 6>		07.16→			<b>0 445 010 593</b>	<b>0 986 437 461</b>
<b>40-160</b> [16]	2,3	110-114,6	F1AGL411... <Euro 6>		07.17→			<b>0 445 010 320</b>	<b>0 986 437 096</b>
<b>40-180</b> [16]	3,0	132	F1C... <Euro 6>		07.16→			<b>0 445 010 593</b>	<b>0 986 437 461</b>
<b>40-210</b> [16]	3,0	150	F1CGL411C <Euro 6>		07.16→			<b>0 445 010 593</b>	<b>0 986 437 461</b>
<b>45 C</b> 13 [00]	2,8	92	8140.43S		01.01-09.04			<b>0 445 020 002</b>	<b>0 986 437 501</b>
14 [09]	3,0	103	F1CE3481L..		05.10-12.11			<b>0 445 010 559</b>	<b>0 986 437 437</b>
15, 18 [06]	3,0	107/130	F1CE0481F...; F1CE0481H..		04.06-12.11			<b>0 445 020 046</b>	<b>0 986 437 321</b>
<b>45 S</b> 17	3,0	125	F1CDS <Euro 5 / P-7 (EGR)>		04.12→			<b>0 445 010 559</b>	<b>0 986 437 437</b>
<b>50</b> 13	2,8	92	8140.43S		10.05-07.07			<b>0 445 020 002</b>	<b>0 986 437 501</b>
<b>50 C</b> 11, 13 [00]	2,8	78/92	8140.43B.43...; 8140.43S...		05.99-09.04			<b>0 445 020 002</b>	<b>0 986 437 501</b>
12 [00]	2,3	85	F1AE0481B..		09.02-03.06			<b>0 445 020 008</b>	<b>0 986 437 318</b>
12 [06]	2,3	85	F1AE0481G..		04.06-12.11			<b>0 445 010 318</b>	<b>0 986 437 085</b>
14, 17 [00]	3,0	100/122	F1CE0481A...; F1CE0481B		09.04-03.06			<b>0 445 010 098</b>	<b>0 986 437 386</b>
14, 17 [09]	3,0	103/125	F1CE3481C*...; F1CE3481L*C..		06.09-12.11			<b>0 445 010 559</b>	<b>0 986 437 437</b>
15 [00]	2,8	108	8140.43N.43...		05.01-09.04			<b>0 445 020 040</b>	
15, 17 [14]	3,0	107/125	F1CFL411E*C; F1CFL411F*C		05.14→			<b>0 445 010 593</b>	<b>0 986 437 461</b>
15, 17, 21 [12]	3,0	107/125/150	F1CE3481...; F1CE3481D*B13...		07.11-07.14			<b>0 445 010 559</b>	<b>0 986 437 437</b>
15, 17, 21 [14]	3,0	107/125/150	F1CFL411G*C; F1CFL411H*C; F1CFL411J*C		05.14→			<b>0 445 010 559</b>	<b>0 986 437 437</b>
15, 18 [06]	3,0	107/130	F1CE0481...; F1CE0481H..		04.06-12.11			<b>0 445 020 046</b>	<b>0 986 437 321</b>
<b>50-150</b> [16]	3,0	110	F1C... <Euro 6>		07.16→			<b>0 445 010 593</b>	<b>0 986 437 461</b>
<b>50-160</b> [16]	2,3	110-114,6	F1AGL411... <Euro 6>		07.17→			<b>0 445 010 320</b>	<b>0 986 437 096</b>
<b>50-180</b> [16]	3,0	132	F1C... <Euro 6>		07.16→			<b>0 445 010 593</b>	<b>0 986 437 461</b>
<b>50-210</b> [16]	3,0	150	F1CGL411C <Euro 6>		07.16→			<b>0 445 010 593</b>	<b>0 986 437 461</b>
<b>55 C</b> 16	3,0	114	F1CE0481 <Euro 3>		08.07-03.12			<b>0 445 020 046</b>	<b>0 986 437 321</b>
17	3,0	125	F1CDS <Euro 5 / P-7 (EGR)>		04.12→			<b>0 445 010 559</b>	<b>0 986 437 437</b>
<b>55 S</b> 15 [14]	3,0	107	F1CE3481J*B..		09.15→			<b>0 445 010 559</b>	<b>0 986 437 437</b>
17 [09]	3,0	125	F1CE3481C*..		06.09-12.11			<b>0 445 010 559</b>	<b>0 986 437 437</b>
17 [12]	3,0	125	F1CE3481...		07.11-07.14			<b>0 445 010 559</b>	<b>0 986 437 437</b>
17 [14]	3,0	125	F1CFL411F*C		09.15→			<b>0 445 010 593</b>	<b>0 986 437 461</b>
18 [06]	3,0	130	F1CE0481H..		04.06-12.11			<b>0 445 020 046</b>	<b>0 986 437 321</b>
<b>55-180</b> [16]	3,0	132	F1C... <Euro 6>		07.16→			<b>0 445 010 593</b>	<b>0 986 437 461</b>
<b>60 C</b> 14 [09]	3,0	103	F1CE3481L..		11.10-12.11			<b>0 445 010 559</b>	<b>0 986 437 437</b>
15, 17, 21 [12]	3,0	107/125/150	F1CE3481...; F1CE3481D*B...; F1CE3481J*B..		07.11-07.14			<b>0 445 010 559</b>	<b>0 986 437 437</b>
15, 18 [06]	3,0	107/130	F1CE0481F...; F1CE0481H..		04.06-12.11			<b>0 445 020 046</b>	<b>0 986 437 321</b>
17 [14]	3,0	107/125	F1CFL411E*C; F1CFL411F*C		05.14→			<b>0 445 010 593</b>	<b>0 986 437 461</b>
<b>60-150</b> [16]	3,0	110	F1C... <Euro 6>		02.17→			<b>0 445 010 593</b>	<b>0 986 437 461</b>
<b>60-180</b> [16]	3,0	132	F1C... <Euro 6>		02.17→			<b>0 445 010 593</b>	<b>0 986 437 461</b>
<b>65 C</b> 13, 15 [00]	2,8	108	8140.43N.43...; 8140.43N.43...		05.00-09.04			<b>0 445 020 040</b>	
14, 17 [00]	3,0	100/122	F1CE0481A...; F1CE0481B		09.04-03.06			<b>0 445 010 098</b>	<b>0 986 437 386</b>
14, 17 [09]	3,0	103/125	F1CE3481C*...; F1CE3481L*C..		06.09-12.11			<b>0 445 010 559</b>	<b>0 986 437 437</b>
15, 17 [14]	3,0	107/125	F1CFL411E*C; F1CFL411F*C		05.14→			<b>0 445 010 593</b>	<b>0 986 437 461</b>
15, 17, 21 [12]	3,0	107/125/150	F1CE3481...; F1CE3481D*B134		07.11-07.14			<b>0 445 010 559</b>	<b>0 986 437 437</b>
15, 17, 21 [14]	3,0	107/125/150	F1CFL411G*C; F1CFL411H*C; F1CFL411J*C		05.14→			<b>0 445 010 559</b>	<b>0 986 437 437</b>
15, 18 [06]	3,0	107/130	F1CE0481F...; F1CE0481H..		04.06-12.11			<b>0 445 020 046</b>	<b>0 986 437 321</b>
<b>65-150</b> [16]	3,0	110	F1C... <Euro 6>		07.16→			<b>0 445 010 593</b>	<b>0 986 437 461</b>
<b>65-180</b> [16]	3,0	132	F1C... <Euro 6>		07.16→			<b>0 445 010 593</b>	<b>0 986 437 461</b>
<b>65-210</b> [16]	3,0	150	F1CGL411C <Euro 6>		07.16→			<b>0 445 010 593</b>	<b>0 986 437 461</b>



◀ IVECO

<b>70</b>	13	2,8	92	8140.43S		10.05-07.07	<b>0 445 020 002</b>	<b>0 986 437 501</b>
<b>70C</b>	14, 17 [09]	3,0	103/125	F1CE3481C...; F1CE3481L..		11.10-12.11	<b>0 445 010 559</b>	<b>0 986 437 437</b>
	15, 17 [14]	3,0	107/125	F1CFL411E*C; F1CFL411F*C		05.14→	<b>0 445 010 593</b>	<b>0 986 437 461</b>
	15, 17, 21 [12]	3,0	107/125/150	F1CE3481...; F1CE3481D*B13...		07.11-07.14	<b>0 445 010 559</b>	<b>0 986 437 437</b>
	15, 17, 21 [14]	3,0	107/125/150	F1CFL411G*C; F1CFL411H*C; F1CFL411J*C		05.14→	<b>0 445 010 559</b>	<b>0 986 437 437</b>
	15, 18 [09]	3,0	107/130	F1CE...; F1CE3481H..		06.10-12.11	<b>0 445 020 046</b>	<b>0 986 437 321</b>
	17	3,0	125	F1C DS <Euro 5 / P-7 (EGR)>		04.12→	<b>0 445 010 559</b>	<b>0 986 437 437</b>
<b>70-150</b>	[16]	3,0	110	F1C... <Euro 6>		07.16→	<b>0 445 010 593</b>	<b>0 986 437 461</b>
<b>70-180</b>	[16]	3,0	132	F1C... <Euro 6>		07.16→	<b>0 445 010 593</b>	<b>0 986 437 461</b>
<b>70-210</b>	[16]	3,0	150	F1CGL411C <Euro 6>		07.16→	<b>0 445 010 593</b>	<b>0 986 437 461</b>
<b>EuroCargo</b>								
<b>60E</b>	14, 16 [03]	3,9	103/118	F4AE3481C*S; F4AE3481D*S		05.09-01.14	<b>0 445 020 175</b>	<b>0 986 437 341</b>
<b>65E</b>	13, 14, 15, 16 [03]	3,9	95/103/110/118	F4AE0481C*C...; F4AE0481D*C; F4AE3481C*P; F4AE3481D*P		09.03-08.06	<b>0 445 020 175</b>	<b>0 986 437 341</b>
	13, 15	3,9	95/110	F4AE0481C*C...; F4AE0481D*C		08.00-08.03	<b>0 445 020 175</b>	<b>0 986 437 341</b>
	14, 16 [03]	3,9	103/118	F4AE3481C*S; F4AE3481D*S		05.10-01.14	<b>0 445 020 175</b>	<b>0 986 437 341</b>
<b>75E</b>	13, 14, 15, 16, 17, 18 [03]	3,9	95/103/110/118/125/130	F4AE0481A*C...; F4AE0481C*C...; F4AE0481D*C; F4AE3481B*...; F4AE3481C*...; F4AE3481D*...		09.03-01.14	<b>0 445 020 175</b>	<b>0 986 437 341</b>
	13, 15, 17	3,9	95/110/125	F4AE0481A*C...; F4AE0481C*CC; F4AE0481D*C		09.00-08.03	<b>0 445 020 175</b>	<b>0 986 437 341</b>
	16, 19, 21 [14]	4,5	118/137/152	F4AFE411... <Tector 5>; F4AFE411C* <Tector 5>		09.13→	<b>0 445 020 175</b>	<b>0 986 437 341</b>
	18	5,9	134	F4AE0681E*C...		09.00-08.03	<b>0 445 020 175</b>	<b>0 986 437 341</b>
	18 [03]	5,9	134	F4AE0681E*C...		09.03-08.05	<b>0 445 020 175</b>	<b>0 986 437 341</b>
<b>80E</b>	15, 16, 17, 18 [03]	3,9	110/118/125/130	F4AE0481A*C...; F4AE0481C*C...; F4AE3481B*...; F4AE3481D*...		09.03-01.14	<b>0 445 020 175</b>	<b>0 986 437 341</b>
	15, 17	3,9	110/125	F4AE0481A*C...; F4AE0481C*..		09.00-08.03	<b>0 445 020 175</b>	<b>0 986 437 341</b>
	18, 21	5,9	134/154	F4AE0681D*C...; F4AE0681E*C..		09.00-08.03	<b>0 445 020 175</b>	<b>0 986 437 341</b>
	18, 21, 22 [03]	5,9	134/154/160	F4AE0681D*C...; F4AE0681E*C...; F4AE3681B*...		09.03-01.14	<b>0 445 020 175</b>	<b>0 986 437 341</b>
<b>90E</b>	17	3,9	125	F4AE0481A*C..		09.00-08.03	<b>0 445 020 175</b>	<b>0 986 437 341</b>
	17, 18 [03]	3,9	125/130	F4AE0481A*C...; F4AE3481B*...		09.03-01.14	<b>0 445 020 175</b>	<b>0 986 437 341</b>
	18, 19, 22 [03]	5,9	134/154/160	F4AE0681D*C...; F4AE0681E*C...; F4AE3681B*..		09.03-01.14	<b>0 445 020 175</b>	<b>0 986 437 341</b>
	18, 21	5,9	134/154	F4AE0681D*C...; F4AE0681E*C..		09.00-08.03	<b>0 445 020 175</b>	<b>0 986 437 341</b>
<b>100E</b>	17	3,9	125	F4AE0481A*C...		09.00-08.03	<b>0 445 020 175</b>	<b>0 986 437 341</b>
	17 [03]	3,9	125	F4AE0481A*C..		09.03-08.05	<b>0 445 020 175</b>	<b>0 986 437 341</b>
	18 [03]	3,9	130	F4AE3481B*...		09.06-01.14	<b>0 445 020 175</b>	<b>0 986 437 341</b>
	18, 21	5,9	134/154	F4AE0681D*C...; F4AE0681E*C...		09.00-08.03	<b>0 445 020 175</b>	<b>0 986 437 341</b>
	18, 21, 22 [03]	5,9	134/135/154/160	F4AE0681D*C...; F4AE0681E*C...; F4AE3681B*...; F4AE3681C*...		09.03-01.14	<b>0 445 020 175</b>	<b>0 986 437 341</b>
	19, 21 [14]	4,5	137/152	F4AFE411... <Tector 5>; F4AFE411C* <Tector 5>		09.13→	<b>0 445 020 175</b>	<b>0 986 437 341</b>
	22 [14]	6,7	162	F4AFE611A* <Tector 7>		09.13→	<b>0 445 020 175</b>	<b>0 986 437 341</b>
<b>110E</b>	18, 22 [16]	5,9	132/162	F4AEE681 <Tector 6 - Euro 3>		01.18→	<b>0 445 020 175</b>	<b>0 986 437 341</b>
	22 [14]	6,7	162	F4AFE611A* <Tector 7>		07.14→	<b>0 445 020 175</b>	<b>0 986 437 341</b>
	22, 25 [03]	5,9	160/185	F4AE3681B*...; F4AE3681D*..		09.07-01.14	<b>0 445 020 175</b>	<b>0 986 437 341</b>
<b>120E</b>	17	3,9	125	F4AE0481A*C...		09.00-08.03	<b>0 445 020 175</b>	<b>0 986 437 341</b>
	17, 18 [03]	3,9	125/134	F4AE0481A*C...; F4AE3481A*...		09.03-01.14	<b>0 445 020 175</b>	<b>0 986 437 341</b>
	18, 21, 22, 24, 25, 28 [03]	5,9	134/154/160/176/185/202/205	F4AE0681A*C...; F4AE0681B*C...; F4AE0681D*C...; F4AE0681E*C...; F4AE3681B*...; F4AE3681D*...;		09.03-01.14	<b>0 445 020 175</b>	<b>0 986 437 341</b>
	18, 21, 24, 28	5,9	134/154/176/202	F4AE0681A*C...; F4AE0681B*C...; F4AE0681D*C...; F4AE0681E*C..		09.00-08.03	<b>0 445 020 175</b>	<b>0 986 437 341</b>
	18, 22 [16]	5,9	132/162	F4AEE681 <Tector 6 - Euro 3>		01.18→	<b>0 445 020 175</b>	<b>0 986 437 341</b>
	19, 21 [14]	4,5	137/152	F4AFE411... <Tector 5>; F4AFE411C* <Tector 5>		09.13→	<b>0 445 020 175</b>	<b>0 986 437 341</b>
	22 [14]	6,7	162	F4AFE611A* <Tector 7>		09.13→	<b>0 445 020 175</b>	<b>0 986 437 341</b>
<b>120EL</b>	18 [03]	3,9	130	F4AE3481B*P		09.05-01.14	<b>0 445 020 175</b>	<b>0 986 437 341</b>
	22 [03]	5,9	160	F4AE3681B*...		05.09-01.14	<b>0 445 020 175</b>	<b>0 986 437 341</b>
<b>130E</b>	18 [03]	3,9	134	F4AE3481A*P		09.05-01.14	<b>0 445 020 175</b>	<b>0 986 437 341</b>

								
<b>130 E</b> 18, 21, 24, 25, 28 [03]	5,9	134/154/176/185/202	F4AE0681A*C...; F4AE0681B*C...; F4AE0681D*C...; F4AE0681E*C...; F4AE3681D*..	09.03-01.14			<b>0 445 020 175</b>	<b>0 986 437 341</b>
18, 21, 24, 28	5,9	134/154/176/202	F4AE0681A*C...; F4AE0681B*C...; F4AE0681D*C...; F4AE0681E*C...	09.00-08.03			<b>0 445 020 175</b>	<b>0 986 437 341</b>
<b>140 E</b> 18 [03]	3,9	134	F4AE3481A*..	09.05-01.14			<b>0 445 020 175</b>	<b>0 986 437 341</b>
18, 21, 22, 24, 25, 28 [03]	5,9	134/154/160/176/185/202/205	F4AE0681A*C...; F4AE0681B*C...; F4AE0681D*C...; F4AE0681E*C...; F4AE3681B*...; F4AE3681D*...; F4AE3681E*..	09.03-01.14			<b>0 445 020 175</b>	<b>0 986 437 341</b>
18, 24	5,9	134/176	F4AE0681B*C...; F4AE0681E*C..	09.00-08.03			<b>0 445 020 175</b>	<b>0 986 437 341</b>
19, 21 [14]	4,5	137/152	F4AFE411... <Tector 5>; F4AFE411C* <Tector 5>	09.13→			<b>0 445 020 175</b>	<b>0 986 437 341</b>
22, 24, 25, 28 [16]	5,9	162/176/185/202	F4AEE681 <Tector 6 - Euro 3>; F4AE3681D*..	01.18→			<b>0 445 020 175</b>	<b>0 986 437 341</b>
22, 25, 28 [14]	6,7	162/185/206	F4AFE611A* <Tector 7>; F4AFE611C* <Tector 7>; F4AFE611E* <Tector 7>	09.13→			<b>0 445 020 175</b>	<b>0 986 437 341</b>
<b>150 E</b> 18 [03]	3,9	134	F4AE3481A*..	09.05-01.14			<b>0 445 020 175</b>	<b>0 986 437 341</b>
18, 21, 22, 24, 25, 28, 30 [03]	5,9	134/154/160/176/185/202/205/220	F4AE0681A*C...; F4AE0681B*C...; F4AE0681D*C...; F4AE0681E*C...; F4AE3681A*...; F4AE3681B*...; F4AE3681E*..	09.03-01.14			<b>0 445 020 175</b>	<b>0 986 437 341</b>
18, 21, 24, 28	5,9	134/154/176/202	F4AE0681A*C...; F4AE0681B*C...; F4AE0681D*C...; F4AE0681E*C...	09.00-08.03			<b>0 445 020 175</b>	<b>0 986 437 341</b>
22, 25, 28, 32 [14]	6,7	162/185/206/235	F4AFE611A* <Tector 7>; F4AFE611C* <Tector 7>; F4AFE611D* <Tector 7>; F4AFE611E* <Tector 7>	09.13→			<b>0 445 020 175</b>	<b>0 986 437 341</b>
24, 25, 28 [16]	5,9	176/185/202	F4AEE681 <Tector 6 - Euro 3>; F4AE3681D*..	01.18→			<b>0 445 020 175</b>	<b>0 986 437 341</b>
<b>160 E</b> 18 [03]	3,9	134	F4AE3481A*..	09.05-01.14			<b>0 445 020 175</b>	<b>0 986 437 341</b>
19, 21 [14]	4,5	137/152	F4AFE411... <Tector 5>; F4AFE411C* <Tector 5>	09.13→			<b>0 445 020 175</b>	<b>0 986 437 341</b>
21, 22, 24, 25, 28, 30 [03]	5,9	154/160/176/185/202/205/220	F4AE0681A*C...; F4AE0681B*C...; F4AE0681D*C...; F4AE0681E*C...; F4AE3681A*...; F4AE3681B*...; F4AE3681D*...; F4AE3681E*..	09.03-01.14			<b>0 445 020 175</b>	<b>0 986 437 341</b>
22, 24, 25, 28 [16]	5,9	162/176/185/202	F4AEE681 <Tector 6 - Euro 3>; F4AE3681D*..	01.18→			<b>0 445 020 175</b>	<b>0 986 437 341</b>
22, 25, 28, 32 [14]	6,7	162/185/206/235	F4AFE611A* <Tector 7>; F4AFE611C* <Tector 7>; F4AFE611D* <Tector 7>; F4AFE611E* <Tector 7>	09.13→			<b>0 445 020 175</b>	<b>0 986 437 341</b>
<b>180 E</b> 21, 24, 25, 28, 30 [03]	5,9	154/176/185/202/205/220	F4AE0681A*C...; F4AE0681B*C...; F4AE0681D*C...; F4AE0681E*C...; F4AE3681A*...; F4AE3681D*...; F4AE3681E*..	09.03-01.14			<b>0 445 020 175</b>	<b>0 986 437 341</b>
21, 24, 28	5,9	154/176/202	F4AE0681A*C...; F4AE0681B*C...; F4AE0681D*C...	09.00-08.03			<b>0 445 020 175</b>	<b>0 986 437 341</b>
24, 25, 28 [16]	5,9	176/185/202	F4AEE681 <Tector 6 - Euro 3>; F4AE3681D*..	01.18→			<b>0 445 020 175</b>	<b>0 986 437 341</b>
25, 28, 32 [14]	6,7	185/206/235	F4AFE611C* <Tector 7>; F4AFE611D* <Tector 7>; F4AFE611E* <Tector 7>	09.13→			<b>0 445 020 175</b>	<b>0 986 437 341</b>
<b>260 E</b> 28 [03]	5,9	202	F4AE0681A*C..	09.03-08.05			<b>0 445 020 175</b>	<b>0 986 437 341</b>
<b>320 E</b> 28	5,9	202	F4AE0681A*C..	09.00-08.03			<b>0 445 020 175</b>	<b>0 986 437 341</b>
<b>Eurofire</b>								
<b>150 E</b> 32	6,7	235	F4AFE611D* <Tector 7>	09.15→			<b>0 445 020 175</b>	<b>0 986 437 341</b>
<b>EuroFire</b>								
<b>140 E</b> 25	6,7	185	F4AFE611E* <Tector 7>	09.13→			<b>0 445 020 175</b>	<b>0 986 437 341</b>
<b>160 E</b> 32	6,7	235	F4AFE611D* <Tector 7>	09.15→			<b>0 445 020 175</b>	<b>0 986 437 341</b>
<b>Euromidi CC</b>								
<b>100 E</b> 22	5,9	162	F4AEE681 <Tector 6 - Euro 3>	07.13→			<b>0 445 020 175</b>	<b>0 986 437 341</b>
22, 25	6,7	162/185	F4AFE611C* <Tector 7>; F4AFE611E* <Tector 7>	12.13→			<b>0 445 020 175</b>	<b>0 986 437 341</b>
<b>150 E</b> 25	6,7	185	F4AFE611E* <Tector 7>	09.13→			<b>0 445 020 175</b>	<b>0 986 437 341</b>
<b>Iveco</b>								
<b>2.8 D</b>	2,8	125	Sofim	12.04→			<b>0 445 020 002</b>	<b>0 986 437 501</b>
<b>Magelys</b>								
	8,7	294	F2CFE612A <Cursor 9 - Euro 6>	07.14→			<b>0 445 020 093</b>	<b>0 986 437 389</b>
<b>Scudato</b>								
<b>70 C</b> 17	3,0	125	F1CDS <Euro 5 / P-7 (EGR)>	04.12→			<b>0 445 010 559</b>	<b>0 986 437 437</b>





◀ IVECO

Stralis Hi-Way							
310	8,7	228	F2CFE611D*C <CURSOR 9>	07.13→		0 445 020 093	0 986 437 389
[16]	8,7	228	F2CFE611D*C <CURSOR 9>	01.17→		0 445 020 093	0 986 437 389
330	8,7	243	F2CFE611C*C <CURSOR 9>	07.13→		0 445 020 093	0 986 437 389
[16]	8,7	243	F2CFE611C*C <CURSOR 9>	01.17→		0 445 020 093	0 986 437 389
360	8,7	265	F2CFE611B <Euro 6>	07.13→		0 445 020 093	0 986 437 389
[16]	8,7	265	F2CFE611B <Euro 6>	08.16→		0 445 020 093	0 986 437 389
400	8,7	294	F2CFE611A <Euro 6>	07.13→		0 445 020 093	0 986 437 389
[16]	8,7	294	F2CFE611A <Euro 6>	08.16→		0 445 020 093	0 986 437 389
420	11,1	309	F3GFE611D* <Cursor 11>	07.13→		0 445 020 195	0 986 437 512
[16]	11,1	309	F3GFE611F <Euro 6>	08.16→		0 445 020 195	0 986 437 512
460	11,1	338	F3GFE611B* <Cursor 11>	07.13→		0 445 020 195	0 986 437 512
[16]	11,1	338	F3GFE611E <Euro 6>	08.16→		0 445 020 195	0 986 437 512
480	11,1	353	F3GFE611A* <Cursor 11>	07.13→		0 445 020 195	0 986 437 512
[16]	12,9	358	F3GF... <Euro 6>; F3GFL611D <Euro 6>	08.16→		0 445 020 195	0 986 437 512
500	12,9	368	F3HFE611B* <Cursor 13>	07.13→		0 445 020 195	0 986 437 512
[16]	12,9	368	F3HFE611B* <Cursor 13>	08.16→		0 445 020 195	0 986 437 512
510 [16]	12,9	375	F3HFE611G <Euro 6>	08.16→		0 445 020 195	0 986 437 512
560	12,9	412	F3HFE611A* <Cursor 13>	07.13→		0 445 020 195	0 986 437 512
[16]	8,7	228	F2CFE611D*C <CURSOR 9>	01.17→		0 445 020 093	0 986 437 389
	12,9	412	F3HFE611A* <Cursor 13>	08.16→		0 445 020 195	0 986 437 512
570 [16]	12,9	420	F3HF... <Cursor 13>	08.16→		0 445 020 195	0 986 437 512
Stralis X-Way							
330	8,7	243	F2CFE611C*C <CURSOR 9>	01.18→		0 445 020 093	0 986 437 389
360	8,7	265	F2CFE611B <Euro 6>	08.17→		0 445 020 093	0 986 437 389
400	8,7	294	F2CFE611A <Euro 6>	08.17→		0 445 020 093	0 986 437 389
420	11,1	309	F3GFE611F <Euro 6>	08.17→		0 445 020 195	0 986 437 512
460	11,1	338	F3GFE611E <Euro 6>	08.17→		0 445 020 195	0 986 437 512
480	11,1	358	F3GF... <Euro 6>; F3GFE611G <Euro 6>	08.17→		0 445 020 195	0 986 437 512
	12,9	358	F3GF... <Euro 6>	08.17→		0 445 020 195	0 986 437 512
510	12,9	375	F3HFE611G <Euro 6>	08.17→		0 445 020 195	0 986 437 512
570	12,9	420	F3HF... <Cursor 13>	08.17→		0 445 020 195	0 986 437 512
			F3HF... <Euro 6>	01.18→		0 445 020 195	0 986 437 512
Trakker							
190T 31, 33, 36 [13]	8,7	228/243/265	F2CFE611B <Euro 6>; F2CFE611C*C <CURSOR 9>; F2CFE611D*C <CURSOR 9>	11.13→		0 445 020 093	0 986 437 389
41, 45 [13]	12,9	302/331	F3HFE611C*C <CURSOR 13>; F3HFE611D*C <CURSOR 13>	11.13→		0 445 020 195	0 986 437 512
260T 33, 36, 41 [13]	8,7	243/265/302	F2CFE611A <Euro 6>; F2CFE611B <Euro 6>; F2CFE611C*C <CURSOR 9>	11.13→		0 445 020 093	0 986 437 389
41 [13]	12,9	302	F3HFE611D*C <CURSOR 13>	11.13→	TW	0 445 020 093	0 986 437 389
						0 445 020 195	0 986 437 512
45, 50 [13]	12,9	331/368	F3HFE611... <Cursor 13>; F3HFE611C*C <CURSOR 13>	11.13→		0 445 020 195	0 986 437 512
340T 36, 40 [13]	8,7	265/294	F2CFE611A <Euro 6>; F2CFE611B <Euro 6>	11.13→		0 445 020 093	0 986 437 389
41, 45, 50 [13]	12,9	302/331/368	F3HFE611... <Cursor 13>; F3HFE611C*C <CURSOR 13>; F3HFE611D*C <CURSOR 13>	11.13→		0 445 020 195	0 986 437 512
380T 36 [13]	8,7	265	F2CFE611B <Euro 6>	11.13→		0 445 020 093	0 986 437 389
41, 45, 50 [13]	12,9	302/331/368	F3HFE611... <Cursor 13>; F3HFE611C*C <CURSOR 13>; F3HFE611D*C <CURSOR 13>	11.13→		0 445 020 195	0 986 437 512
400T 36 [13]	8,7	265	F2CFE611B <Euro 6>	11.13→		0 445 020 093	0 986 437 389
41, 45, 50 [13]	12,9	302/331/368	F3HFE611... <Cursor 13>; F3HFE611C*C <CURSOR 13>; F3HFE611D*C <CURSOR 13>	11.13→		0 445 020 195	0 986 437 512
410T 36 [13]	8,7	265	F2CFE611B <Euro 6>	11.13→		0 445 020 093	0 986 437 389
41, 45, 50 [13]	12,9	302/331/368	F3HFE611... <Cursor 13>; F3HFE611C*C <CURSOR 13>; F3HFE611D*C <CURSOR 13>	11.13→		0 445 020 195	0 986 437 512
440T 41, 45, 50 [13]	12,9	302/331/368	F3HFE611... <Cursor 13>; F3HFE611C*C <CURSOR 13>; F3HFE611D*C <CURSOR 13>	11.13→		0 445 020 195	0 986 437 512
720T 41, 45, 50 [13]	12,9	302/331/368	F3HFE611... <Cursor 13>; F3HFE611C*C <CURSOR 13>; F3HFE611D*C <CURSOR 13>	11.13→		0 445 020 195	0 986 437 512
Urbanway							
12	8,7	228/294	F2CFE612A <Cursor 9 - Euro 6>; F2CFE612D <Cursor 9 - Euro 6>	06.13→		0 445 020 093	0 986 437 389





18	8,7	228/294	F2CFE612A <Cursor 9 - Euro 6>; F2CFE612D <Cursor 9 - Euro 6>	06.13→	0 445 020 093	0 986 437 389
----	-----	---------	--	--------	---------------	---------------

## KAVZ KURGAN

Serie 4000						
4235	3,9	110	ISBe 150 31 <Euro 3>	09.08→	0 445 020 045	0 986 437 342
	4,5	136	4ISBe185B <Euro 3>	09.08→	0 445 020 045	0 986 437 342
4238	6,7	155	6ISBe 210 <Euro 3>	09.08→	0 445 020 045	0 986 437 342
Serie 320000						
324410	4,8	115	D 245.30 E3 <Euro 3>	01.08→	0 445 020 088	

## LDV GROUP LIMITED

Maxus						
2.5 CRD	2,5	70-88	VM39C; VM40C	01.05-06.11	0 445 010 034	

## LIAZ LIKINSKI (RUS)

Serie 6000						
6212	11,1	303	650 DCi 11 <Euro 3>	06.08→	0 445 020 086	

## MAHINDRA

Genio						
2.5 D	2,5	56	mDI CRDe	02.11→	0 445 010 420	

## MAN

Bus						
19.290 HOCLN-LE [RC3]	6,9	213	D 0836 LOH64 <Euro 5>	04.14→	TW	0 445 020 206 0 986 437 359 0 445 020 207
26.430 HOCLN-SD [RR4]	10,5	316	D 2066 LOH10 <Euro 3>	05.13→		0 445 020 023 0 986 437 351
26.440 HOCLN-SD [RR4]	12,4	324	D 2676 LOH26 <Euro 5/EEV/OBD2>	08.14→		0 445 020 277 0 986 437 383
26.480 HOCLN-DD [RR6]	12,4	353	D 2676 LOH04 <Euro 4/OBD1>	02.12→		0 445 020 208 0 986 437 350
HOCLN-SD [RR4]	12,4	353	D 2676 LOH04 <Euro 4/OBD1>	04.13→		0 445 020 208 0 986 437 350
			D 2676 LOH27 <Euro 5/EEV/OBD2>	06.09→		0 445 020 277 0 986 437 383
			D 2676 LOH31 <Euro 6>	04.13→		0 445 020 277 0 986 437 383
			D 2676 LOH33 <Euro 4>; D 2676 LOH34 <Euro 5/EEV>	03.15→		0 445 020 208 0 986 437 350
26.500 HOCLN-DD [RR6]	12,4	371	D 2676 LOH28 <EEV/OBD2>	03.09→		0 445 020 277 0 986 437 383
Bus 12t						
12.240 HOCL-NL [A76]	6,9	176	D 0836 LOH41 <Euro 3>	03.05-09.08	MPR	0 445 020 053
			D 0836 LOH52 <Euro 4/OBD1>; D 0836 LOH56 <Euro 4/OBD1>; D 0836 LOH58 <Euro 4>	02.06-09.09	MPR	0 445 020 203 0 986 437 352
HOCL-NL-CIB [A80]	6,9	177	D 0836 LOH56 <Euro 4>	03.07→		0 445 020 203 0 986 437 352
12.250 HOCL-NL-CIB [A80]	6,9	184	D 0836 LOH 65 <Euro 5>	02.10→		0 445 020 206 0 986 437 359
12.280 HOCL-NL-CIB [A80]	6,9	206	D 0836 LOH55 <Euro 4/OBD1>	04.08→		0 445 020 203 0 986 437 352
Bus 14t						
14.240 HOCL-NL [A66]	6,9	176	D 0836 LOH41 <Euro 3>	01.04-09.08	MPR	0 445 020 053
			D 0836 LOH52 <Euro 4/OBD1>; D 0836 LOH56 <Euro 4/OBD1>; D 0836 LOH58 <Euro 4>	01.06-09.09	MPR	0 445 020 203 0 986 437 352
14.250 HOCL-NL [A66]	6,9	184	D 0836 LOH61 <Euro 5/EEV/OBD2>; D 0836 LOH65 <Euro 5/EEV>	01.09→		0 445 020 206 0 986 437 359
14.260 HOCL-NL [A66]	6,9	191	D 0836 LOH62 <Euro 4>	02.10→	TW	0 445 020 203 0 986 437 352 0 445 020 206 0 986 437 359







◀ MAN

<b>14.280</b> HOCL-NL [A66]	6,9	206	D 0836 LOH51 <Euro 4>; D 0836 LOH55 <Euro 4/OBD1>; D 0836 LOH57 <Euro 4>	09.05-09.10		<b>0 445 020 203</b>	<b>0 986 437 352</b>
HOCL-SR [A67]	6,9	206	D 0836 LOH51 <Euro 4>; D 0836 LOH55 <Euro 4/OBD1>	02.06-09.10		<b>0 445 020 203</b>	<b>0 986 437 352</b>
<b>14.290</b> HOCL-NL [A66]	6,9	213	D 0836 LOH60	06.11→		<b>0 445 020 206</b>	<b>0 986 437 359</b>
HOCL-SR [A67]	6,9	213	D 0836 LOH64 <Euro 5>	02.10→	TW	<b>0 445 020 206</b>	<b>0 986 437 359</b>
							<b>0 445 020 207</b>
<b>Bus 18t</b>							
<b>18.240</b> HOCL-NL [A69]	6,9	176	D 0836 LOH41 <Euro 3>	03.05-09.08	MPR	<b>0 445 020 053</b>	
						MPR	<b>0 445 020 203</b>
						<b>0 986 437 352</b>	
			D 0836 LOH52 <Euro 4/OBD1>; D 0836 LOH56 <Euro 4/OBD1>	03.06-09.09		<b>0 445 020 203</b>	<b>0 986 437 352</b>
<b>18.250</b> HOCLR-CIB [A94]	6,9	184	D 0836 LOH65 <Euro 5/EEV>	01.12→		<b>0 445 020 206</b>	<b>0 986 437 359</b>
<b>18.260</b> HOCL-NL [A69]	6,9	191	D 0836 LOH62 <Euro 4>	02.11→	TW	<b>0 445 020 203</b>	<b>0 986 437 352</b>
						<b>0 445 020 206</b>	<b>0 986 437 359</b>
<b>18.280</b> HOCL-R-NL-CIB [A84]	6,9	206	D 0836 LOH40 <Euro 3>	03.07→	MPR	<b>0 445 020 053</b>	
						MPR	<b>0 445 020 203</b>
						<b>0 986 437 352</b>	
<b>18.290</b> HOCL-NL [A69]	6,9	213	D 0836 LOH60	03.11→		<b>0 445 020 206</b>	<b>0 986 437 359</b>
			D 0836 LOH64 <Euro 5>	02.10→	TW	<b>0 445 020 206</b>	<b>0 986 437 359</b>
							<b>0 445 020 207</b>
HOCLR-CIB [A94]	6,9	213	D 0836 LOH64 <Euro 5>	01.14→	TW	<b>0 445 020 206</b>	<b>0 986 437 359</b>
							<b>0 445 020 207</b>
<b>18.310</b> HOCL-NL [A69]	10,5	228	D 2066 LUH12 <Euro 4>; D 2066 LUH22 <Euro 4/OBD1>	03.06-05.09		<b>0 445 020 208</b>	<b>0 986 437 350</b>
<b>18.320</b> HOCLN [R33]	10,5	235	D 2066 LOH01 <Euro 4>	10.06→		<b>0 445 020 208</b>	<b>0 986 437 350</b>
HOCL-NL [A69]	10,5	235	D 2066 LUH32 <V6400, Euro5>	09.10→		<b>0 445 020 277</b>	<b>0 986 437 383</b>
<b>18.350</b> HOCLN [R33]	10,5	257	D 2066 LOH12 <Euro 3>	09.08-09.12		<b>0 445 020 023</b>	<b>0 986 437 351</b>
HOCL-R CIB [R38]	10,5	257	D 2066 LOH12 <Euro 3>	06.09→		<b>0 445 020 023</b>	<b>0 986 437 351</b>
<b>18.360</b> HOCLN [R33]	10,5	265	D 2066 LOH02 <Euro 4>; D 2066 LOH06 <Euro 4/OBD1>	10.06→		<b>0 445 020 208</b>	<b>0 986 437 350</b>
			D 2066 LOH27 <Euro5/EEV/OBD2>	09.09→		<b>0 445 020 277</b>	<b>0 986 437 383</b>
<b>18.400</b> HOCLN [R33]	10,5	294	D 2066 LOH03 <Euro 4>; D 2066 LOH07 <Euro 4/OBD1>	10.06→		<b>0 445 020 208</b>	<b>0 986 437 350</b>
			D 2066 LOH28 <Euro5/EEV/OBD2>	09.09→		<b>0 445 020 277</b>	<b>0 986 437 383</b>
HOCL-R LBC [A82]	10,5	294	D 2066 LF06 <Euro 2>	04.06-05.09		<b>0 445 020 023</b>	<b>0 986 437 351</b>
<b>18.430</b> HOCLN [R33]	10,5	316	D 2066 LOH10 <Euro 3>	03.08→		<b>0 445 020 023</b>	<b>0 986 437 351</b>
HOCL-R CIB [R39]	10,5	316	D 2066 LOH10 <Euro 3>	07.07→		<b>0 445 020 023</b>	<b>0 986 437 351</b>
<b>18.440</b> HOCLN [R33]	10,5	324	D 2066 LOH04 <Euro 4>; D 2066 LOH08 <Euro 4/OBD1>	10.06→		<b>0 445 020 208</b>	<b>0 986 437 350</b>
			D 2676 LOH26 <Euro 5/EEV/OBD2>	09.09→		<b>0 445 020 277</b>	<b>0 986 437 383</b>
HOCL-R CIB [R39]	10,5	324	D 2066 LOH08 <Euro 4/OBD1>	03.11→		<b>0 445 020 208</b>	<b>0 986 437 350</b>
<b>18.480</b> HOCLN [R33]	12,4	353	D 2676 LOH02 <Euro 4>; D 2676 LOH04 <Euro 4/OBD1>	09.05-09.09		<b>0 445 020 208</b>	<b>0 986 437 350</b>
			D 2676 LOH27 <Euro 5/EEV/OBD2>	09.09→		<b>0 445 020 277</b>	<b>0 986 437 383</b>
HOCL-R CIB [R39]	12,4	353	D 2676 LOH04 <Euro 4/OBD1>	02.11→		<b>0 445 020 208</b>	<b>0 986 437 350</b>
<b>Bus 19t</b>							
<b>19.250</b> HOCL-LE-SD, HOCL-LE-SD [RC2]	6,9	184	D 0836 LOH65 <Euro 5/EEV>; D 0836 LOH73 <Euro 6>	01.15→		<b>0 445 020 206</b>	<b>0 986 437 359</b>
HOCL-LS-SD [RR8]	6,9	184	D 0836 LOH65 <Euro 5/EEV>	02.13→		<b>0 445 020 206</b>	<b>0 986 437 359</b>
HOCL-ÜL-CIB [RR9]	6,9	184	D 0836 LOH65 <Euro 5/EEV>	05.13→		<b>0 445 020 206</b>	<b>0 986 437 359</b>
<b>19.280</b> HOCL-LS-SD [RR8]	6,9	206	D 0836 LOH40 <Euro 3>	07.13→	MPR	<b>0 445 020 053</b>	
						MPR	<b>0 445 020 203</b>
						<b>0 986 437 352</b>	
			D 0836 LOH55 <Euro 4/OBD1>	02.08→		<b>0 445 020 203</b>	<b>0 986 437 352</b>
<b>19.290</b> HOCL-LE-SD [RC2]	6,9	213	D 0836 LOH64 <Euro 5>	01.15→	TW	<b>0 445 020 206</b>	<b>0 986 437 359</b>
							<b>0 445 020 207</b>
			D 0836 LOH72 <Euro 6>	01.15→		<b>0 445 020 206</b>	<b>0 986 437 359</b>
HOCL-LS-SD [RR8]	6,9	213	D 0836 LOH64 <Euro 5>	03.08→	TW	<b>0 445 020 206</b>	<b>0 986 437 359</b>
							<b>0 445 020 207</b>
			D 0836 LOH72 <Euro 6>	02.14→		<b>0 445 020 206</b>	<b>0 986 437 359</b>
<b>19.310</b> HOCL-LE-SD [RC2]	10,5	228	D 2066 LUH22 <Euro 4/OBD1>	02.14→		<b>0 445 020 208</b>	<b>0 986 437 350</b>
<b>19.320</b> HOCL-LE-SD [RC2]	10,5	235	D 2066 LUH32 <V6400, Euro5>	01.09→		<b>0 445 020 277</b>	<b>0 986 437 383</b>
HOCL-LS-SD [RR8]	10,5	235	D 2066 LUH32 <V6400, Euro5>	07.11→		<b>0 445 020 277</b>	<b>0 986 437 383</b>
<b>19.360</b> HOCL-LS-SD [RR8]	10,5	265	D 2066 LUH33 <V6400, Euro5>	01.13→		<b>0 445 020 277</b>	<b>0 986 437 383</b>





<b>19.430</b> HOCL-CIB [RR3]	10,5	316	D 2066 LOH10 <Euro 3>	01.14→		<b>0 445 020 023</b>	<b>0 986 437 351</b>
<b>Bus 24t</b>							
<b>24.320</b> HOCLN [R37]	10,5	235	D 2066 LOH01 <Euro 4>	10.06→		<b>0 445 020 208</b>	<b>0 986 437 350</b>
<b>24.360</b> HOCLN [R37]	10,5	265	D 2066 LOH02 <Euro 4>	10.06→		<b>0 445 020 208</b>	<b>0 986 437 350</b>
<b>24.400</b> HOCLN [R37]	10,5	294	D 2066 LOH03 <Euro 4>	10.06→		<b>0 445 020 208</b>	<b>0 986 437 350</b>
<b>24.440</b> HOCLN [R37]	10,5	324	D 2066 LOH04 <Euro 4>	10.06→		<b>0 445 020 208</b>	<b>0 986 437 350</b>
<b>24.460</b> HOCLN CIB [R40]	12,4	338	D 2676 LOH10 <Euro 3>	04.11→		<b>0 445 020 208</b>	<b>0 986 437 350</b>
HOCLN/R [R37]	12,4	338	D 2676 LOH10 <Euro 3>	09.11→		<b>0 445 020 208</b>	<b>0 986 437 350</b>
<b>24.480</b> HOCLN CIB [R40]	12,4	353	D 2676 LOH04 <Euro 4/OBD1>	02.12→		<b>0 445 020 208</b>	<b>0 986 437 350</b>
HOCLN/R [R37]	12,4	353	D 2676 LOH02 <Euro 4>; D 2676 LOH04 <Euro 4/OBD1>	03.06-09.09		<b>0 445 020 208</b>	<b>0 986 437 350</b>
			D 2676 LOH27 <Euro 5/EEV/OBD2>	09.09→		<b>0 445 020 277</b>	<b>0 986 437 383</b>
<b>Lion's City</b>							
[A37]	6,9	176/206	D 0836 LOH50 <Euro 4>; D 0836 LOH51 <Euro 4>; D 0836 LOH52 <Euro 4>	08.05→		<b>0 445 020 203</b>	<b>0 986 437 352</b>
		184/213	D 0836 LOH60; D 0836 LOH61 <Euro 5/EEV/OBD2>	02.09→		<b>0 445 020 206</b>	<b>0 986 437 359</b>
		191	D 0836 LOH62 <Euro 4>	07.06→	TW	<b>0 445 020 203</b>	<b>0 986 437 352</b>
						<b>0 445 020 206</b>	<b>0 986 437 359</b>
		191/206	D 0836 LOH55 <Euro 4/OBD1>; D 0836 LOH63 <Euro 4>	04.07→		<b>0 445 020 203</b>	<b>0 986 437 352</b>
<b>C</b> [A36]	10,5	264	D 2066 LUH48 <Euro 5/EEV/OBD2>	03.13→		<b>0 445 020 277</b>	<b>0 986 437 383</b>
<b>CLE</b> [A45]	10,5	264	D 2066 LUH48 <Euro 5/EEV/OBD2>	02.13→		<b>0 445 020 277</b>	<b>0 986 437 383</b>
<b>LLE</b> [A44]	10,5	235	D 2066 LUH47 <Euro 5/EEV/OBD2>	06.12→		<b>0 445 020 277</b>	<b>0 986 437 383</b>
<b>Lion's City / NL</b>							
[A21]	6,9	176	D 0836 LUH41 <Euro 3>	06.04-09.06	MPR	<b>0 445 020 053</b>	
					MPR	<b>0 445 020 203</b>	<b>0 986 437 352</b>
		206	D 0836 LUH40 <Euro 3>	06.04-09.06	TW	<b>0 445 020 053</b>	
						<b>0 445 020 203</b>	<b>0 986 437 352</b>
	10,5	199/228	D 2066 LUH16 <Euro 4/OBD1>; D 2066 LUH17 <Euro 4/OBD1>; D 2066 LUH21 <Euro 4/OBD1>; D 2066 LUH22 <Euro 4/OBD1>	08.06→		<b>0 445 020 208</b>	<b>0 986 437 350</b>
		199/228/257	D 2066 LUH23 <Euro 4/OBD1>; D 2066 LUH26 <Euro 4/OBD1>; D 2066 LUH27 <Euro 4/OBD1>	05.07→		<b>0 445 020 208</b>	<b>0 986 437 350</b>
		206	D 2066 LUH41 <Euro 5/EEV/OBD2>	04.07→		<b>0 445 020 277</b>	<b>0 986 437 383</b>
		206/235/264	D 2066 LUH42 <Euro 5/EEV>; D 2066 LUH43 <Euro 5/EEV>; D 2066 LUH46 <Euro 5/EEV/OBD2>; D 2066 LUH47 <Euro 5/EEV/OBD2>; D 2066 LUH48 <Euro 5/EEV/OBD2>	07.07→		<b>0 445 020 277</b>	<b>0 986 437 383</b>
<b>NL 243</b> [A37]	6,9	176	D 0836 LOH41 <Euro 3>	01.02-09.06	MPR	<b>0 445 020 053</b>	
					MPR	<b>0 445 020 203</b>	<b>0 986 437 352</b>
<b>NL 283</b> [A37]	6,9	206	D 0836 LOH40 <Euro 3>	01.02-09.06	MPR	<b>0 445 020 053</b>	
					MPR	<b>0 445 020 203</b>	<b>0 986 437 352</b>
<b>Lion's City DD / ND</b>							
<b>ND 313</b> [A39]	10,5	228/257	D 2066 LUH12 <Euro 4>; D 2066 LUH13 <Euro 4>; D 2066 LUH17 <Euro 4/OBD1>; D 2066 LUH27 <Euro 4/OBD1>	04.06-08.14		<b>0 445 020 208</b>	<b>0 986 437 350</b>
		235	D 2066 LUH47 <Euro 5/EEV/OBD2>	01.09-08.14		<b>0 445 020 277</b>	<b>0 986 437 383</b>
<b>ND 363</b> [A39]	10,5	264	D 2066 LUH48 <Euro 5/EEV/OBD2>	01.09-08.14		<b>0 445 020 277</b>	<b>0 986 437 383</b>
<b>Lion's City G / GL</b>							
[A23]	10,5	199/228/257	D 2066 LUH02 <Euro 4>; D 2066 LUH11 <Euro 4>; D 2066 LUH12 <Euro 4>; D 2066 LUH13 <Euro 4>; D 2066 LUH17 <Euro 4/OBD1>; D 2066 LUH22 <Euro 4/OBD1>; D 2066 LUH27 <Euro 4/OBD1>	10.06→		<b>0 445 020 208</b>	<b>0 986 437 350</b>
		199/257	D 2066 LUH21 <Euro 4/OBD1>; D 2066 LUH23 <Euro 4/OBD1>	08.07→		<b>0 445 020 208</b>	<b>0 986 437 350</b>
		206/235/264	D 2066 LUH46 <Euro 5/EEV/OBD2>; D 2066 LUH47 <Euro 5/EEV/OBD2>; D 2066 LUH48 <Euro 5/EEV/OBD2>	03.09→		<b>0 445 020 277</b>	<b>0 986 437 383</b>
		235/264	D 2066 LUH42 <Euro 5/EEV>; D 2066 LUH43 <Euro 5/EEV>	07.07→		<b>0 445 020 277</b>	<b>0 986 437 383</b>
<b>Lion's City GL</b>							
[A40]	10,5	235/264	D 2066 LUH47 <Euro 5/EEV/OBD2>; D 2066 LUH48 <Euro 5/EEV/OBD2>	06.11→		<b>0 445 020 277</b>	<b>0 986 437 383</b>





◀ MAN

<b>LE</b> [A49]	10,5	264	D 2066 LUH48 <Euro 5/EEV/OBD2>	05.12→		<b>0 445 020 277</b>	<b>0 986 437 383</b>
<b>Lion's City LL / NL</b>							
[A26]	10,5	228/257	D 2066 LUH12 <Euro 4>; D 2066 LUH17 <Euro 4/OBD1>; D 2066 LUH22 <Euro 4/OBD1>; D 2066 LUH23 <Euro 4/OBD1>	02.06→		<b>0 445 020 208</b>	<b>0 986 437 350</b>
		235	D 2066 LUH42 <Euro 5/EEV>	07.07→		<b>0 445 020 277</b>	<b>0 986 437 383</b>
		235/264/265	D 2066 LUH43 <Euro 5/EEV>; D 2066 LUH47 <Euro 5/EEV/OBD2>; D 2066 LUH48 <Euro 5/EEV/OBD2>	02.09→		<b>0 445 020 277</b>	<b>0 986 437 383</b>
		257	D 2066 LUH28 <Euro 4/OBD1>	01.08→		<b>0 445 020 208</b>	<b>0 986 437 350</b>
<b>Lion's City M / NM</b>							
[A47]	6,9	176/206	D 0836 LOH51 <Euro 4>; D 0836 LOH52 <Euro 4>	01.06-08.09		<b>0 445 020 203</b>	<b>0 986 437 352</b>
		184/213	D 0836 LOH60; D 0836 LOH61 <Euro 5/EEV/OBD2>; D 0836 LOH66 <Euro 6>; D 0836 LOH67 <Euro 6>	09.09→		<b>0 445 020 206</b>	<b>0 986 437 359</b>
		191	D 0836 LOH62 <Euro 4>	03.07→	TW	<b>0 445 020 203</b>	<b>0 986 437 352</b>
						<b>0 445 020 206</b>	<b>0 986 437 359</b>
			D 0836 LOH63 <Euro 4>	03.07→		<b>0 445 020 203</b>	<b>0 986 437 352</b>
		206	D 0836 LOH40 <Euro 3>	04.05→	MPR	<b>0 445 020 053</b>	
					MPR	<b>0 445 020 203</b>	<b>0 986 437 352</b>
<b>Lion's City T / TÛ / EL</b>							
[A78]	6,9	191	D 0836 LOH62 <Euro 4>	04.07→	TW	<b>0 445 020 203</b>	<b>0 986 437 352</b>
						<b>0 445 020 206</b>	<b>0 986 437 359</b>
		206	D 0836 LOH40 <Euro 3>	05.08→	MPR	<b>0 445 020 053</b>	
					MPR	<b>0 445 020 203</b>	<b>0 986 437 352</b>
			D 0836 LOH50 <Euro 4>; D 0836 LOH51 <Euro 4>	05.05→		<b>0 445 020 203</b>	<b>0 986 437 352</b>
			D 0836 LOH55 <Euro 4/OBD1>	07.07→		<b>0 445 020 203</b>	<b>0 986 437 352</b>
		213	D 0836 LOH60	04.09→		<b>0 445 020 206</b>	<b>0 986 437 359</b>
<b>Lion's City Ü</b>							
[A21]	10,5	199/228	D 2066 LUH11 <Euro 4>; D 2066 LUH12 <Euro 4>	10.06-12.09		<b>0 445 020 208</b>	<b>0 986 437 350</b>
<b>Lion's City Ü / NÜ</b>							
[A20]	6,9	176	D 0836 LUH41 <Euro 3>	06.04-09.06	MPR	<b>0 445 020 053</b>	
					MPR	<b>0 445 020 203</b>	<b>0 986 437 352</b>
		206	D 0836 LUH40 <Euro 3>	06.04-09.06	TW	<b>0 445 020 053</b>	
						<b>0 445 020 203</b>	<b>0 986 437 352</b>
	10,5	199	D 2066 LUH26 <Euro 4/OBD1>	03.08→		<b>0 445 020 208</b>	<b>0 986 437 350</b>
		199/228/257	D 2066 LUH13 <Euro 4>; D 2066 LUH16 <Euro 4/OBD1>; D 2066 LUH17 <Euro 4/OBD1>; D 2066 LUH22 <Euro 4/OBD1>; D 2066 LUH23 <Euro 4/OBD1>; D 2066 LUH27 <Euro 4/OBD1>	05.06→		<b>0 445 020 208</b>	<b>0 986 437 350</b>
		199/257	D 2066 LUH21 <Euro 4/OBD1>; D 2066 LUH28 <Euro 4/OBD1>	01.08→		<b>0 445 020 208</b>	<b>0 986 437 350</b>
		206	D 2066 LUH41 <Euro 5/EEV/OBD2>	02.08→		<b>0 445 020 277</b>	<b>0 986 437 383</b>
		206/235/264	D 2066 LUH46 <Euro 5/EEV/OBD2>; D 2066 LUH47 <Euro 5/EEV/OBD2>; D 2066 LUH48 <Euro 5/EEV/OBD2>	03.09→		<b>0 445 020 277</b>	<b>0 986 437 383</b>
		235	D 2066 LUH42 <Euro 5/EEV>	07.07→		<b>0 445 020 277</b>	<b>0 986 437 383</b>
<b>Lion's City ÜLL / NÜ</b>							
<b>NÜ 313</b> [A25]	10,5	228	D 2066 LUH12 <Euro 4>	05.06-05.08		<b>0 445 020 208</b>	<b>0 986 437 350</b>
<b>NÜ 353</b> [A25]	10,5	257	D 2066 LUH13 <Euro 4>	02.06-05.08		<b>0 445 020 208</b>	<b>0 986 437 350</b>
<b>Lion's Coach</b>							
[R07,R08,R09]	10,5	294	D 2066 LOH28 <Euro 5/EEV/OBD2>; D 2066 LOH32 <Euro 6>	01.09→		<b>0 445 020 277</b>	<b>0 986 437 383</b>
		294/324	D 2066 LOH03 <Euro 4>; D 2066 LOH07 <Euro 4/OBD1>; D 2066 LOH08 <Euro 4/OBD1>	10.06→		<b>0 445 020 208</b>	<b>0 986 437 350</b>
<b>C.L</b> [R07,R08,R09]							
	10,5	324	D 2066 LOH04 <Euro 4>	09.05-12.09		<b>0 445 020 208</b>	<b>0 986 437 350</b>
	12,4	324/353	D 2676 LOH26 <Euro 5/EEV/OBD2>; D 2676 LOH27 <Euro 5/EEV/OBD2>; D 2676 LOH30 <Euro 6>; D 2676 LOH31 <Euro 6>	08.08→		<b>0 445 020 277</b>	<b>0 986 437 383</b>
		338	D 2676 LOH01 <Euro 4>	09.05-09.06		<b>0 445 020 208</b>	<b>0 986 437 350</b>
		353	D 2676 LOH02 <Euro 4>; D 2676 LOH04 <Euro 4/OBD1>	03.07→		<b>0 445 020 208</b>	<b>0 986 437 350</b>
<b>Lion's Coach RHC</b>							
<b>RHC 464</b> [R07,R08,R09]	10,5	316	D 2066 LOH10 <Euro 3>	01.09→		<b>0 445 020 023</b>	<b>0 986 437 351</b>





<b>Lion's Intercity</b>									
<b>ÜL</b> [R60]	6,9	213	D 0836 LOH64 <Euro 5>	01.13→	TW	<b>0 445 020 206</b>	<b>0 986 437 359</b>		
			D 0836 LOH72 <Euro 6>	01.14→		<b>0 445 020 207</b>	<b>0 986 437 359</b>		
[R62]	6,9	213	D 0836 LOH72 <Euro 6>	09.15→		<b>0 445 020 206</b>	<b>0 986 437 359</b>		
<b>Lion's Intercity C</b>									
<b>ÜL</b> [R61]	6,9	213	D 0836 LOH64 <Euro 5>	01.13→	TW	<b>0 445 020 206</b>	<b>0 986 437 359</b>		
			D 0836 LOH72 <Euro 6>	01.13→		<b>0 445 020 207</b>	<b>0 986 437 359</b>		
<b>Lion's Regio</b>									
[R12,R13,R14]	10,5	228/257/287	D 2066 LUH08 <V6400, Euro3>; D 2066 LUH12 <Euro 4>; D 2066 LUH13 <Euro 4>; D 2066 LUH14 <Euro4>; D 2066 LUH22 <Euro 4/OBD1>; D 2066 LUH23 <Euro 4/OBD1>; D 2066 LUH24 <Euro 4/OBD1>	01.06→		<b>0 445 020 208</b>	<b>0 986 437 350</b>		
		235/264/265/294	D 2066 LUH32 <V6400, Euro5>; D 2066 LUH33 <V6400, Euro5>; D 2066 LUH34 <V6400, Euro5>; D 2066 LUH47 <Euro 5/EEV/OBD2>; D 2066 LUH48 <Euro 5/EEV/OBD2>	01.06→		<b>0 445 020 277</b>	<b>0 986 437 383</b>		
		316	D 2066 LUH15 <Euro 3>	01.07-09.10		<b>0 445 020 208</b>	<b>0 986 437 350</b>		
<b>Lion's Regio C</b>									
[R12,R13,R14]	10,5	228/257/287	D 2066 LUH01 <Euro4>; D 2066 LUH02 <Euro 4>; D 2066 LUH03 <Euro 4>	10.06-05.07		<b>0 445 020 208</b>	<b>0 986 437 350</b>		
<b>Lion's Regio L</b>									
[R12,R13,R14]	10,5	228/257/287	D 2066 LUH01 <Euro4>; D 2066 LUH02 <Euro 4>; D 2066 LUH03 <Euro 4>	10.06-05.07		<b>0 445 020 208</b>	<b>0 986 437 350</b>		
<b>ND-Serie</b>									
<b>ND 323 FR</b> [A95]	10,5	235	D 2066 LUH32 <V6400, Euro5>	01.13→		<b>0 445 020 277</b>	<b>0 986 437 383</b>		
<b>ND 363 FR</b> [A95]	10,5	265	D 2066 LUH33 <V6400, Euro5>	01.14→		<b>0 445 020 277</b>	<b>0 986 437 383</b>		
<b>NG-Serie</b>									
<b>NG 313 F</b> [A24]	10,5	228	D 2066 LUH22 <Euro 4/OBD1>	07.07→		<b>0 445 020 208</b>	<b>0 986 437 350</b>		
<b>NG 323 F</b> [A24]	10,5	235	D 2066 LUH47 <Euro 5/EEV/OBD2>	03.10→		<b>0 445 020 277</b>	<b>0 986 437 383</b>		
<b>NG 353 F</b> [A24]	10,5	257	D 2066 LUH13 <Euro 4>; D 2066 LUH23 <Euro 4/OBD1>	03.07→		<b>0 445 020 208</b>	<b>0 986 437 350</b>		
<b>NG 363 F</b> [A24]	10,5	264/265	D 2066 LUH33 <V6400, Euro5>; D 2066 LUH48 <Euro 5/EEV/OBD2>	07.09→		<b>0 445 020 277</b>	<b>0 986 437 383</b>		
<b>NL-Serie</b>									
<b>NL 243 F</b> [A38]	6,9	176	D 0836 LOH41 <Euro 3>	06.03-04.06	MPR	<b>0 445 020 053</b>			
					MPR	<b>0 445 020 203</b>	<b>0 986 437 352</b>		
<b>NL 273 F</b> [A22]	10,5	199	D 2066 LUH11 <Euro 4>	04.06→		<b>0 445 020 208</b>	<b>0 986 437 350</b>		
<b>NL 283 F</b> [A22]	10,5	206	D 2066 LUH46 <Euro 5/EEV/OBD2>	01.09→		<b>0 445 020 277</b>	<b>0 986 437 383</b>		
F [A38]	6,9	206	D 0836 LOH40 <Euro 3>	06.04-04.06	MPR	<b>0 445 020 053</b>			
					MPR	<b>0 445 020 203</b>	<b>0 986 437 352</b>		
<b>NL 313 F</b> [A22]	10,5	228	D 0836 LOH51 <Euro 4>	01.06-03.07		<b>0 445 020 203</b>	<b>0 986 437 352</b>		
			D 2066 LUH12 <Euro 4>; D 2066 LUH22 <Euro 4/OBD1>	01.07→		<b>0 445 020 208</b>	<b>0 986 437 350</b>		
<b>NL 323 F</b> [A22]	10,5	235	D 2066 LUH32 <V6400, Euro5>; D 2066 LUH47 <Euro 5/EEV/OBD2>	01.09→		<b>0 445 020 277</b>	<b>0 986 437 383</b>		
<b>NM-Serie</b>									
<b>NM 243 F</b> [A35]	6,9	176	D 0836 LOH52 <Euro 4/OBD1>; D 0836 LOH56 <Euro 4/OBD1>	01.06-09.09		<b>0 445 020 203</b>	<b>0 986 437 352</b>		
<b>NM 253 F</b> [A35]	6,9	184	D 0836 LOH61 <Euro 5/EEV/OBD2>	01.09→		<b>0 445 020 206</b>	<b>0 986 437 359</b>		
<b>NM 263 F</b> [A35]	6,9	191	D 0836 LOH62 <Euro 4>	01.09→	TW	<b>0 445 020 203</b>	<b>0 986 437 352</b>		
						<b>0 445 020 206</b>	<b>0 986 437 359</b>		
<b>NM 283 F</b> [A35]	6,9	206	D 0836 LOH55 <Euro 4/OBD1>; D 0836 LOH57 <Euro 4>	03.07-09.10		<b>0 445 020 203</b>	<b>0 986 437 352</b>		
<b>NM 293 F</b> [A35]	6,9	213	D 0836 LOH60	07.08-12.13		<b>0 445 020 206</b>	<b>0 986 437 359</b>		
<b>RR2</b>									
<b>350</b>	10,5	257	D 2066 LOH12 <Euro 3>	05.13→		<b>0 445 020 023</b>	<b>0 986 437 351</b>		
<b>360</b>	10,5	265	D 2066 LOH27 <Euro5/EEV/OBD2>	05.10→		<b>0 445 020 277</b>	<b>0 986 437 383</b>		
<b>400</b>	10,5	294	D 2066 LOH28 <Euro5/EEV/OBD2>	05.10→		<b>0 445 020 277</b>	<b>0 986 437 383</b>		
<b>440</b>	12,4	324	D 2676 LOH26 <Euro 5/EEV/OBD2>	07.09→		<b>0 445 020 277</b>	<b>0 986 437 383</b>		
<b>480</b>	12,4	353	D 2676 LOH27 <Euro 5/EEV/OBD2>	03.12→		<b>0 445 020 277</b>	<b>0 986 437 383</b>		





◀ MAN

SL							
313 F [A89]	10,5	228	D 2066 LUH12 <Euro 4>	02.06-12.09	0 445 020 208	0 986 437 350	
353 F [A89]	10,5	257	D 2066 LUH13 <Euro 4>; D 2066 LUH23 <Euro 4/OBD1>	02.07-12.10	0 445 020 208	0 986 437 350	
363 F [A89]	10,5	265	D 2066 LUH33 <V6400, Euro5>	02.09-04.14	0 445 020 277	0 986 437 383	
Sü							
363 F [A91]	10,5	265	D 2066 LUH33 <V6400, Euro5>	09.08-09.13	0 445 020 277	0 986 437 383	
SÜ							
243 F [A91]	6,9	176	D 0836 LOH56 <Euro 4/OBD1>	02.07-09.09	0 445 020 203	0 986 437 352	
253 F [A91]	6,9	184	D 0836 LOH 65 <Euro 5>	09.08-09.13	0 445 020 206	0 986 437 359	
263 F [A91]	6,9	191	D 0836 LOH63 <Euro 4>	01.08->	0 445 020 203	0 986 437 352	
283 F [A91]	6,9	206	D 0836 LOH51 <Euro 4>; D 0836 LOH55 <Euro 4/OBD1>	06.04-09.13	0 445 020 203	0 986 437 352	
293 F [A91]	6,9	213	D 0836 LOH64 <Euro 5>	09.07-09.13 TW	0 445 020 206	0 986 437 359	
313 F [A91]	10,5	228	D 2066 LUH12 <Euro 4>; D 2066 LUH22 <Euro 4/OBD1>	02.06-09.13	0 445 020 208	0 986 437 350	
323 F [A91]	10,5	235	D 2066 LUH32 <V6400, Euro5>	09.08-09.13	0 445 020 277	0 986 437 383	
353 F [A91]	10,5	257	D 2066 LUH13 <Euro 4>; D 2066 LUH23 <Euro 4/OBD1>	09.06-09.13	0 445 020 208	0 986 437 350	
TAG							
24.430 FN, FP	10,5	316	D 2066 LF01 <Euro 3>	09.04-09.06	0 445 020 023	0 986 437 351	
TGA							
18.310 FA, FH, FC, FK, FL	10,5	228	D 2066 LF04 <V5500, Euro 3>; D 2066 LF14 <V5500, Euro 4>	03.04-09.07	0 445 020 023	0 986 437 351	
18.320 F, FL, FA, FC, FK, FL, FC, FK, FL	10,5	235	D 2066 LF20 <Euro 5/OBD1>; D 2066 LF28 <Euro 5/OBD1>; D 2066 LF30 <Euro 5/OBD1>; D 2066 LF35 <V5500, Euro 4>; D 2066 LF39 <Euro 4/OBD1>	07.06-03.09	0 445 020 208	0 986 437 350	
18.350 FA, FA, FC, FK, FL, FA, FH, FC, FK, FL	10,5	257	D 2066 LF03 <Euro 3>; D 2066 LF13 <V5500, Euro 4>	03.04-08.08	0 445 020 023	0 986 437 351	
18.360 F, FL, FA, FC, FK, FL	10,5	265	D 2066 LF19 <Euro 5/OBD1>; D 2066 LF27 <Euro 5/OBD1>; D 2066 LF29 <V5500, Euro 5>; D 2066 LF33 <V5500, Euro 4>; D 2066 LF38 <Euro 4/OBD1>	07.06-03.09	0 445 020 208	0 986 437 350	
18.390 FA, FH, FA, FL, FC, FK, FL	10,5	287	D 2066 LF02 <Euro 3>; D 2066 LF12 <Euro 4>	03.04-08.08	0 445 020 023	0 986 437 351	
18.400 F, FL, FA, FC, FK, FL, FC, FK, FL	10,5	294	D 2066 LF18 <Euro 5/OBD1>; D 2066 LF22 <V5500, Euro 5>; D 2066 LF24 <Euro 5/OBD1>; D 2066 LF26 <Euro 5/OBD1>; D 2066 LF32 <Euro 4/OBD1>; D 2066 LF37 <Euro 4/OBD1>	01.06-03.09	0 445 020 208	0 986 437 350	
18.430 FA, FH, FC, FK, FL	10,5	316	D 2066 LF01 <Euro 3>; D 2066 LF11 <V5500, Euro 4>	03.04-08.08	0 445 020 023	0 986 437 351	
18.440 F, FL, FA, FC, FH, FK, FL, FA, FC, FK, FL, FC, FK, FL	10,5	321/324	D 2066 LF17 <Euro 5/OBD1>; D 2066 LF21 <V5500, Euro 5>; D 2066 LF23 <Euro 5/OBD1>; D 2066 LF25 <Euro 5/OBD1>; D 2066 LF31 <Euro 4/OBD1>; D 2066 LF36 <Euro 4/OBD1>	01.06-03.09	0 445 020 208	0 986 437 350	
18.480 F, FA, FC, FK, FL	12,8	353	D 2876 LF12 <V5300, Euro 3>	10.02-09.06	0 445 020 018	0 986 437 353	
F, FL, FA, FC, FH, FK, FL	12,4	353	D 2676 LF01 <Euro4/OBD1>; D 2676 LF05 <Euro 4/OBD1>; D 2676 LF12 <Euro5/OBD1>; D 2676 LF14 <Euro 5/OBD1>; D 2676 LF16 <Euro 5/OBD1>	04.06-03.09	0 445 020 208	0 986 437 350	
18.530 F, FL, FC, FK, FL	12,8	390	D 2876 LF13 <V5300, Euro 3>	10.02-09.06	0 445 020 018	0 986 437 353	
18.540 F, FL	12,4	397	D 2676 LF11 <Euro 5/OBD1>; D 2676 LF13 <Euro 5/OBD1>; D 2676 LF15 <Euro 5/OBD1>	02.07-08.08	0 445 020 208	0 986 437 350	
19.350 FL-, FC-, FK-WW	10,5	258	D 2066 LF03 <Euro 3>	07.06-05.10	0 445 020 023	0 986 437 351	
19.360 FL-, FC-, FK-WW	10,5	265	D 2066 LF07 <Euro 2>	07.06-05.10	0 445 020 023	0 986 437 351	
19.390 FL-, FC-, FK-WW	10,5	287	D 2066 LF02 <Euro 3>	07.06-05.10	0 445 020 023	0 986 437 351	
19.400 FL-, FC-, FK-WW	10,5	294	D 2066 LF06 <Euro 2>	07.06-05.10	0 445 020 023	0 986 437 351	
19.430 FL-, FC-, FK-WW	10,5	316	D 2066 LF01 <Euro 3>	07.06-05.10	0 445 020 023	0 986 437 351	
19.440 FL-, FC-, FK-WW	12,4	324	D 2676 LF04 <Euro 2>	07.06-05.10	0 445 020 208	0 986 437 350	
19.480 FL-, FC-, FK-WW	12,4	353	D 2676 LF02 <Euro 3>; D 2676 LF03 <Euro 2>	07.06-05.10	0 445 020 208	0 986 437 350	
24.350 FN, FP	10,5	257	D 2066 LF03 <Euro 3>; D 2066 LF13 <V5500, Euro 4>	09.04-09.06	0 445 020 023	0 986 437 351	





								
<b>24.360</b> DF, FN	10,5	265	D 2066 LF19 <Euro 5/OBD1>; D 2066 LF27 <Euro 5/OBD1>; D 2066 LF29 <V5500, Euro 5>; D 2066 LF33 <V5500, Euro 4>; D 2066 LF38 <Euro 4/OBD1>	07.06-03.09			<b>0 445 020 208</b>	<b>0 986 437 350</b>
<b>24.390</b> FN, FP	10,5	287	D 2066 LF02 <Euro 3>; D 2066 LF12 <Euro 4>	09.04-09.06			<b>0 445 020 023</b>	<b>0 986 437 351</b>
<b>24.400</b> DF, FN	10,5	294	D 2066 LF18 <Euro 5/OBD1>; D 2066 LF22 <V5500, Euro 5>; D 2066 LF24 <Euro 5/OBD1>; D 2066 LF26 <Euro 5/OBD1>; D 2066 LF32 <Euro 4/OBD1>; D 2066 LF37 <Euro 4/OBD1>	07.06-03.09			<b>0 445 020 208</b>	<b>0 986 437 350</b>
<b>24.430</b> FN, FP	10,5	316	D 2066 LF11 <V5500, Euro 4>	10.04-09.06			<b>0 445 020 023</b>	<b>0 986 437 351</b>
<b>24.440</b> DF, FD, FN, FN, FP	10,5	321/324	D 2066 LF17 <Euro 5/OBD1>; D 2066 LF21 <V5500, Euro 5>; D 2066 LF23 <Euro 5/OBD1>; D 2066 LF25 <Euro 5/OBD1>; D 2066 LF31 <Euro 4/OBD1>; D 2066 LF36 <Euro 4/OBD1>	07.06-03.09			<b>0 445 020 208</b>	<b>0 986 437 350</b>
<b>24.480</b> DF, FN	12,4	353	D 2676 LF01 <Euro4/OBD1>; D 2676 LF05 <Euro 4/OBD1>; D 2676 LF12 <Euro5/OBD1>; D 2676 LF14 <Euro 5/OBD1>; D 2676 LF16 <Euro 5/OBD1>	07.06-03.09			<b>0 445 020 208</b>	<b>0 986 437 350</b>
FN, FP, FV	12,8	353	D 2876 LF12 <V5300, Euro 3>	06.03-09.06			<b>0 445 020 018</b>	<b>0 986 437 353</b>
<b>24.530</b> FN, FP, FV	12,8	390	D 2876 LF13 <V5300, Euro 3>	12.02-09.06			<b>0 445 020 018</b>	<b>0 986 437 353</b>
<b>24.540</b> DF	12,4	397	D 2676 LF11 <Euro 5/OBD1>; D 2676 LF13 <Euro 5/OBD1>; D 2676 LF15 <Euro 5/OBD1>	02.07-08.08			<b>0 445 020 208</b>	<b>0 986 437 350</b>
<b>26.280</b> DF	6,9	206	D 0836 LF41 <V5200, Euro 3>	03.03-02.05			<b>0 445 020 053</b>	
<b>26.310</b> FD, FH, FN, FV, FD, FV	10,5	228	D 2066 LF04 <V5500, Euro 3>; D 2066 LF14 <V5500, Euro 4>	03.04-09.07			<b>0 445 020 023</b>	<b>0 986 437 351</b>
<b>26.320</b> FD, FH, FN, FV	10,5	235	D 2066 LF20 <Euro 5/OBD1>; D 2066 LF28 <Euro 5/OBD1>; D 2066 LF30 <Euro 5/OBD1>; D 2066 LF35 <V5500, Euro 4>; D 2066 LF39 <Euro 4/OBD1>	07.06-09.08			<b>0 445 020 208</b>	<b>0 986 437 350</b>
<b>26.330</b> DA	6,9	240	D 0836 LF44 <V5200, Euro 3>	03.03-02.05			<b>0 445 020 053</b>	
<b>26.350</b> FD, FH, FN, FV, FD, FV	10,5	257	D 2066 LF03 <Euro 3>; D 2066 LF13 <V5500, Euro 4>	03.04-09.06			<b>0 445 020 023</b>	<b>0 986 437 351</b>
<b>26.360</b> FD, FH, FN, FV	10,5	265	D 2066 LF19 <Euro 5/OBD1>; D 2066 LF27 <Euro 5/OBD1>; D 2066 LF29 <V5500, Euro 5>; D 2066 LF33 <V5500, Euro 4>; D 2066 LF38 <Euro 4/OBD1>	07.06-09.08			<b>0 445 020 208</b>	<b>0 986 437 350</b>
<b>26.390</b> FD, FFD, FD, FFD, FV, FD, FH, FN, FV	10,5	287	D 2066 LF02 <Euro 3>; D 2066 LF12 <Euro 4>	03.04-09.06			<b>0 445 020 023</b>	<b>0 986 437 351</b>
<b>26.400</b> FD, FH, FN, FV	10,5	294	D 2066 LF18 <Euro 5/OBD1>; D 2066 LF22 <V5500, Euro 5>; D 2066 LF24 <Euro 5/OBD1>; D 2066 LF26 <Euro 5/OBD1>; D 2066 LF32 <Euro 4/OBD1>; D 2066 LF37 <Euro 4/OBD1>	01.06-09.08			<b>0 445 020 208</b>	<b>0 986 437 350</b>
<b>26.430</b> FD, FD, FH, FN, FV	10,5	316	D 2066 LF01 <Euro 3>; D 2066 LF11 <V5500, Euro 4>	03.04-09.06			<b>0 445 020 023</b>	<b>0 986 437 351</b>
<b>26.440</b> F, FL, FD, FH, FN, FV	10,5	321/324	D 2066 LF17 <Euro 5/OBD1>; D 2066 LF21 <V5500, Euro 5>; D 2066 LF23 <Euro 5/OBD1>; D 2066 LF25 <Euro 5/OBD1>; D 2066 LF31 <Euro 4/OBD1>; D 2066 LF36 <Euro 4/OBD1>	01.06-03.09			<b>0 445 020 208</b>	<b>0 986 437 350</b>
<b>26.480</b> DA, FD, FN, FP, FV	12,8	353	D 2876 LF12 <V5300, Euro 3>	09.02-09.06			<b>0 445 020 018</b>	<b>0 986 437 353</b>
FD, FH, FN, FV	12,4	353	D 2676 LF01 <Euro4/OBD1>; D 2676 LF05 <Euro 4/OBD1>; D 2676 LF12 <Euro5/OBD1>; D 2676 LF14 <Euro 5/OBD1>; D 2676 LF16 <Euro 5/OBD1>	07.06-03.09			<b>0 445 020 208</b>	<b>0 986 437 350</b>
<b>26.530</b> DA, FD, FN, FP, FV	12,8	390	D 2876 LF13 <V5300, Euro 3>	09.02-09.06			<b>0 445 020 018</b>	<b>0 986 437 353</b>
<b>26.540</b> FD, FH, FN, FV	12,4	397	D 2676 LF11 <Euro 5/OBD1>; D 2676 LF13 <Euro 5/OBD1>; D 2676 LF15 <Euro 5/OBD1>	02.07-08.08			<b>0 445 020 208</b>	<b>0 986 437 350</b>
<b>28.310</b> DF, FN	10,5	228	D 2066 LF04 <V5500, Euro 3>; D 2066 LF14 <V5500, Euro 4>	03.04-06.07			<b>0 445 020 023</b>	<b>0 986 437 351</b>
<b>28.320</b>	10,5	235	D 2066 LF86 <Euro 6/OBDC>	09.16→			<b>0 445 020 277</b>	<b>0 986 437 383</b>
DF, FN	10,5	235/236	D 2066 LF20 <Euro 5/OBD1>; D 2066 LF28 <Euro 5/OBD1>; D 2066 LF30 <Euro 5/OBD1>; D 2066 LF35 <V5500, Euro 4>; D 2066 LF39 <Euro 4/OBD1>	04.06-08.08			<b>0 445 020 208</b>	<b>0 986 437 350</b>







◀ MAN

<b>28.350</b> DF, FN	10,5	257	D 2066 LF03 <Euro 3>; D 2066 LF13 <V5500, Euro 4>	03.04-09.06	<b>0 445 020 023</b>	<b>0 986 437 351</b>
<b>28.360</b> DF, FN	10,5	265	D 2066 LF19 <Euro 5/OBD1>; D 2066 LF27 <Euro 5/OBD1>; D 2066 LF29 <V5500, Euro 5>; D 2066 LF33 <V5500, Euro 4>; D 2066 LF38 <Euro 4/OBD1>	07.06-08.08	<b>0 445 020 208</b>	<b>0 986 437 350</b>
<b>28.390</b> FN	10,5	287	D 2066 LF02 <Euro 3>; D 2066 LF12 <Euro 4>	03.04-09.06	<b>0 445 020 023</b>	<b>0 986 437 351</b>
<b>28.400</b> FN	10,5	294	D 2066 LF18 <Euro 5/OBD1>; D 2066 LF22 <V5500, Euro 5>; D 2066 LF24 <Euro 5/OBD1>; D 2066 LF26 <Euro 5/OBD1>; D 2066 LF32 <Euro 4/OBD1>; D 2066 LF37 <Euro 4/OBD1>	07.06-08.08	<b>0 445 020 208</b>	<b>0 986 437 350</b>
<b>28.430</b> FN	10,5	316	D 2066 LF01 <Euro 3>; D 2066 LF11 <V5500, Euro 4>	03.04-09.06	<b>0 445 020 023</b>	<b>0 986 437 351</b>
<b>28.440</b> DF, FN	10,5	321/324	D 2066 LF17 <Euro 5/OBD1>; D 2066 LF21 <V5500, Euro 5>; D 2066 LF23 <Euro 5/OBD1>; D 2066 LF25 <Euro 5/OBD1>; D 2066 LF31 <Euro 4/OBD1>; D 2066 LF36 <Euro 4/OBD1>	01.06-08.08	<b>0 445 020 208</b>	<b>0 986 437 350</b>
<b>28.480</b> DF	12,8	353	D 2876 LF12 <V5300, Euro 3>	06.03-09.06	<b>0 445 020 018</b>	<b>0 986 437 353</b>
FN	12,4	353	D 2676 LF01 <Euro4/OBD1>; D 2676 LF05 <Euro 4/OBD1>; D 2676 LF12 <Euro5/OBD1>; D 2676 LF14 <Euro 5/OBD1>; D 2676 LF16 <Euro 5/OBD1>	07.06-08.08	<b>0 445 020 208</b>	<b>0 986 437 350</b>
<b>28.530</b> DF	12,8	390	D 2876 LF13 <V5300, Euro 3>	09.02-09.06	<b>0 445 020 018</b>	<b>0 986 437 353</b>
<b>28.540</b> FN	12,4	397	D 2676 LF11 <Euro 5/OBD1>; D 2676 LF13 <Euro 5/OBD1>; D 2676 LF15 <Euro 5/OBD1>	02.07-08.08	<b>0 445 020 208</b>	<b>0 986 437 350</b>
<b>32.350</b> FFD	10,5	257	D 2066 LF03 <Euro 3>; D 2066 LF13 <V5500, Euro 4>	06.04-09.06	<b>0 445 020 023</b>	<b>0 986 437 351</b>
<b>32.360</b> FFD	10,5	265	D 2066 LF33 <V5500, Euro 4>; D 2066 LF38 <Euro 4/OBD1>	07.06-08.08	<b>0 445 020 208</b>	<b>0 986 437 350</b>
<b>32.390</b> FFD	10,5	287	D 2066 LF02 <Euro 3>	06.04-09.06	<b>0 445 020 023</b>	<b>0 986 437 351</b>
<b>32.400</b> FFD	10,5	294	D 2066 LF32 <Euro 4/OBD1>; D 2066 LF37 <Euro 4/OBD1>	07.06-08.08	<b>0 445 020 208</b>	<b>0 986 437 350</b>
<b>32.430</b> FFD	10,5	316	D 2066 LF01 <Euro 3>; D 2066 LF11 <V5500, Euro 4>	06.04-09.06	<b>0 445 020 023</b>	<b>0 986 437 351</b>
<b>32.440</b> FFD	10,5	324	D 2066 LF31 <Euro 4/OBD1>; D 2066 LF36 <Euro 4/OBD1>	07.06-08.08	<b>0 445 020 208</b>	<b>0 986 437 350</b>
<b>32.480</b> FFD	12,4	353	D 2676 LF01 <Euro4/OBD1>; D 2676 LF05 <Euro 4/OBD1>	07.06-08.08	<b>0 445 020 208</b>	<b>0 986 437 350</b>
	12,8	352	D 2876 LF12 <V5300, Euro 3>	05.04-01.06	<b>0 445 020 018</b>	<b>0 986 437 353</b>
<b>32.530</b> DA	12,8	390	D 2876 LF13 <V5300, Euro 3>	05.04-09.04	<b>0 445 020 018</b>	<b>0 986 437 353</b>
<b>33.310</b> FFD	10,5	228	D 2066 LF04 <V5500, Euro 3>	03.04-09.06	<b>0 445 020 023</b>	<b>0 986 437 351</b>
<b>33.350</b> DF, FD, FDA, FDA, FD-WW	10,5	257	D 2066 LF03 <Euro 3>; D 2066 LF13 <V5500, Euro 4>	03.04-05.10	<b>0 445 020 023</b>	<b>0 986 437 351</b>
<b>33.360</b> FD	10,5	265	D 2066 LF33 <V5500, Euro 4>	07.06-09.08	<b>0 445 020 208</b>	<b>0 986 437 350</b>
			D 2066 LF38 <Euro 4/OBD1>	10.07-09.08	<b>0 445 020 208</b>	<b>0 986 437 350</b>
FD-, FDA-WW	10,5	265	D 2066 LF07 <Euro 2>	07.06-05.10	<b>0 445 020 023</b>	<b>0 986 437 351</b>
<b>33.390</b> DF, FDA, FD-WW	10,5	287	D 2066 LF02 <Euro 3>; D 2066 LF12 <Euro 4>	03.04-05.10	<b>0 445 020 023</b>	<b>0 986 437 351</b>
<b>33.400</b> FD	10,5	294	D 2066 LF32 <Euro 4/OBD1>	07.06-08.08	<b>0 445 020 208</b>	<b>0 986 437 350</b>
			D 2066 LF37 <Euro 4/OBD1>	10.07-08.08	<b>0 445 020 208</b>	<b>0 986 437 350</b>
FD-, FDA-WW	10,5	294	D 2066 LF06 <Euro 2>	07.06-05.10	<b>0 445 020 023</b>	<b>0 986 437 351</b>
<b>33.430</b> DF, FDA, FD-WW	10,5	316	D 2066 LF01 <Euro 3>; D 2066 LF11 <V5500, Euro 4>	03.04-05.10	<b>0 445 020 023</b>	<b>0 986 437 351</b>
<b>33.440</b> FD	10,5	324	D 2066 LF31 <Euro 4/OBD1>; D 2066 LF36 <Euro 4/OBD1>	07.06-08.08	<b>0 445 020 208</b>	<b>0 986 437 350</b>
FD-, FDA-WW	12,4	324	D 2676 LF04 <Euro 2>	07.06-05.10	<b>0 445 020 208</b>	<b>0 986 437 350</b>
<b>33.480</b> DA, FDA-WW, FD-WW	12,8	352/353	D 2876 LF12 <V5300, Euro 3>; D 2876 LF25 <Euro 2>	10.02-03.09	<b>0 445 020 018</b>	<b>0 986 437 353</b>
FD, FD-, FDA-WW, FD-WW	12,4	353	D 2676 LF01 <Euro4/OBD1>; D 2676 LF02 <Euro 3>; D 2676 LF03 <Euro 2>; D 2676 LF05 <Euro 4/OBD1>	07.06-05.10	<b>0 445 020 208</b>	<b>0 986 437 350</b>
<b>33.530</b> DF	12,8	390	D 2876 LF13 <V5300, Euro 3>	10.02-09.06	<b>0 445 020 018</b>	<b>0 986 437 353</b>
<b>35.350</b> FFD, FV, VF	10,5	257	D 2066 LF03 <Euro 3>; D 2066 LF13 <V5500, Euro 4>	03.04-09.06	<b>0 445 020 023</b>	<b>0 986 437 351</b>



								
<b>35.360</b> FFD	10,5	265	D 2066 LF33 <V5500, Euro 4>; D 2066 LF38 <Euro 4/OBD1>	07.06-08.08			<b>0 445 020 208</b>	<b>0 986 437 350</b>
<b>35.390</b> FFD, FV	10,5	287	D 2066 LF02 <Euro 3>; D 2066 LF12 <Euro 4>	03.04-09.06			<b>0 445 020 023</b>	<b>0 986 437 351</b>
<b>35.400</b> FFD	10,5	294	D 2066 LF32 <Euro 4/OBD1>; D 2066 LF37 <Euro 4/OBD1>	07.06-08.08			<b>0 445 020 208</b>	<b>0 986 437 350</b>
<b>35.430</b> FFD, FV	10,5	316	D 2066 LF01 <Euro 3>; D 2066 LF11 <V5500, Euro 4>	03.04-09.06			<b>0 445 020 023</b>	<b>0 986 437 351</b>
<b>35.440</b> FFD	10,5	324	D 2066 LF31 <Euro 4/OBD1>; D 2066 LF36 <Euro 4/OBD1>	07.06-08.08			<b>0 445 020 208</b>	<b>0 986 437 350</b>
<b>35.480</b> FFD	12,4	353	D 2676 LF01 <Euro4/OBD1>; D 2676 LF05 <Euro 4/OBD1>	07.06-08.08			<b>0 445 020 208</b>	<b>0 986 437 350</b>
	12,8	352/353	D 2876 LF12 <V5300, Euro 3>	06.03-09.06			<b>0 445 020 018</b>	<b>0 986 437 353</b>
<b>35.530</b> FFD	12,8	390	D 2876 LF13 <V5300, Euro 3>	06.04-03.06			<b>0 445 020 018</b>	<b>0 986 437 353</b>
<b>37.350</b> FFD	10,5	257	D 2066 LF03 <Euro 3>; D 2066 LF13 <V5500, Euro 4>	03.04-09.06			<b>0 445 020 023</b>	<b>0 986 437 351</b>
<b>37.360</b> FFD	10,5	265	D 2066 LF33 <V5500, Euro 4>; D 2066 LF38 <Euro 4/OBD1>	07.06-08.08			<b>0 445 020 208</b>	<b>0 986 437 350</b>
<b>37.390</b> FFD	10,5	287	D 2066 LF02 <Euro 3>; D 2066 LF12 <Euro 4>	03.04-09.06			<b>0 445 020 023</b>	<b>0 986 437 351</b>
<b>37.400</b> FFD	10,5	294	D 2066 LF32 <Euro 4/OBD1>; D 2066 LF37 <Euro 4/OBD1>	07.06-08.08			<b>0 445 020 208</b>	<b>0 986 437 350</b>
<b>37.430</b> FFD	10,5	316	D 2066 LF01 <Euro 3>; D 2066 LF11 <V5500, Euro 4>	03.04-09.06			<b>0 445 020 023</b>	<b>0 986 437 351</b>
<b>37.440</b> FFD	10,5	324	D 2066 LF31 <Euro 4/OBD1>; D 2066 LF36 <Euro 4/OBD1>	07.06-08.08			<b>0 445 020 208</b>	<b>0 986 437 350</b>
<b>37.480</b> FFD	12,4	353	D 2676 LF01 <Euro4/OBD1>; D 2676 LF05 <Euro 4/OBD1>	07.06-08.08			<b>0 445 020 208</b>	<b>0 986 437 350</b>
VF	12,8	353	D 2876 LF12 <V5300, Euro 3>	08.04-09.06			<b>0 445 020 018</b>	<b>0 986 437 353</b>
<b>37.530</b> VF	12,8	390	D 2876 LF13 <V5300, Euro 3>	06.03-09.06			<b>0 445 020 018</b>	<b>0 986 437 353</b>
<b>39.390</b> FV	10,5	287	D 2066 LF02 <Euro 3>; D 2066 LF12 <Euro 4>	03.04-09.06			<b>0 445 020 023</b>	<b>0 986 437 351</b>
<b>39.400</b> FFD	10,5	294	D 2066 LF32 <Euro 4/OBD1>; D 2066 LF37 <Euro 4/OBD1>	07.06-08.08			<b>0 445 020 208</b>	<b>0 986 437 350</b>
<b>39.430</b> FFD	10,5	316	D 2066 LF01 <Euro 3>; D 2066 LF11 <V5500, Euro 4>	07.04-09.06			<b>0 445 020 023</b>	<b>0 986 437 351</b>
<b>39.440</b> FFD	10,5	324	D 2066 LF31 <Euro 4/OBD1>; D 2066 LF36 <Euro 4/OBD1>	07.06-08.08			<b>0 445 020 208</b>	<b>0 986 437 350</b>
<b>39.480</b> FFD	12,4	353	D 2676 LF01 <Euro4/OBD1>; D 2676 LF05 <Euro 4/OBD1>	07.06-08.08			<b>0 445 020 208</b>	<b>0 986 437 350</b>
<b>40.390</b> FDA-WW, FD-WW	10,5	287	D 2066 LF02 <Euro 3>	01.05-05.10			<b>0 445 020 023</b>	<b>0 986 437 351</b>
<b>40.400</b> FD-WW	10,5	294	D 2066 LF06 <Euro 2>	07.06-05.10			<b>0 445 020 023</b>	<b>0 986 437 351</b>
			D 2066 LF32 <Euro 4/OBD1>; D 2066 LF37 <Euro 4/OBD1>	09.08-05.10			<b>0 445 020 208</b>	<b>0 986 437 350</b>
<b>40.430</b> FDA-WW, FD-WW	10,5	316	D 2066 LF01 <Euro 3>	07.04-05.10			<b>0 445 020 023</b>	<b>0 986 437 351</b>
<b>40.440</b> FD-WW	10,5	324	D 2066 LF31 <Euro 4/OBD1>; D 2066 LF36 <Euro 4/OBD1>	09.08-05.10			<b>0 445 020 208</b>	<b>0 986 437 350</b>
	12,4	324	D 2676 LF04 <Euro 2>	07.06-05.10			<b>0 445 020 208</b>	<b>0 986 437 350</b>
<b>40.480</b> DF, FD-WW	12,8	353	D 2876 LF12 <V5300, Euro 3>; D 2876 LF25 <Euro 2>	10.04-03.09			<b>0 445 020 018</b>	<b>0 986 437 353</b>
FDA-WW	12,4	353	D 2676 LF02 <Euro 3>; D 2676 LF03 <Euro 2>	07.06-05.10			<b>0 445 020 208</b>	<b>0 986 437 350</b>
<b>41.350</b> FFD, FFD-WW	10,5	257	D 2066 LF03 <Euro 3>; D 2066 LF13 <V5500, Euro 4>	03.04-05.10			<b>0 445 020 023</b>	<b>0 986 437 351</b>
<b>41.360</b> FFD	10,5	265	D 2066 LF33 <V5500, Euro 4>	07.06-08.08			<b>0 445 020 208</b>	<b>0 986 437 350</b>
			D 2066 LF38 <Euro 4/OBD1>	09.07-08.08			<b>0 445 020 208</b>	<b>0 986 437 350</b>
FV-WW	10,5	265	D 2066 LF07 <Euro 2>	07.06-05.10			<b>0 445 020 023</b>	<b>0 986 437 351</b>
<b>41.390</b> FFD, FFD-WW	10,5	287	D 2066 LF02 <Euro 3>; D 2066 LF12 <Euro 4>	03.04-05.10			<b>0 445 020 023</b>	<b>0 986 437 351</b>
<b>41.400</b> FFD	10,5	294	D 2066 LF32 <Euro 4/OBD1>	07.06-08.08			<b>0 445 020 208</b>	<b>0 986 437 350</b>
			D 2066 LF37 <Euro 4/OBD1>	09.07-08.08			<b>0 445 020 208</b>	<b>0 986 437 350</b>
FV-WW	10,5	294	D 2066 LF06 <Euro 2>	07.06-05.10			<b>0 445 020 023</b>	<b>0 986 437 351</b>
<b>41.430</b> FFD, FFD-WW	10,5	316	D 2066 LF01 <Euro 3>; D 2066 LF11 <V5500, Euro 4>	03.04-05.10			<b>0 445 020 023</b>	<b>0 986 437 351</b>
<b>41.440</b> FFD	10,5	324	D 2066 LF31 <Euro 4/OBD1>; D 2066 LF36 <Euro 4/OBD1>	07.06-08.08			<b>0 445 020 208</b>	<b>0 986 437 350</b>
FV-WW	12,4	324	D 2676 LF04 <Euro 2>	07.06-05.10			<b>0 445 020 208</b>	<b>0 986 437 350</b>





◀ MAN

<b>41.480</b>	FFD, FFD-WW	12,8	353	D 2876 LF12 <Euro 3>; D 2876 LF25 <Euro 2>	05.03-03.09	<b>0 445 020 018</b>	<b>0 986 437 353</b>
	FFD, FV-WW	12,4	353	D 2676 LF01 <Euro 4/OBD1>; D 2676 LF02 <Euro 3>; D 2676 LF03 <Euro 2>; D 2676 LF05 <Euro 4/OBD1>	07.06-05.10	<b>0 445 020 208</b>	<b>0 986 437 350</b>
<b>41.530</b>	FFD, FV	12,8	390	D 2876 LF13 <Euro 3>	06.03-09.06	<b>0 445 020 018</b>	<b>0 986 437 353</b>
<b>41.540</b>	FV	12,4	397	D 2676 LF11 <Euro 5/OBD1>; D 2676 LF13 <Euro 5/OBD1>	04.07-07.08	<b>0 445 020 208</b>	<b>0 986 437 350</b>
<b>41.660</b>	VF	18,3	485	D 2840 LF25 <Euro 3>	04.03-09.06	<b>F 00B C00 008</b>	<b>0 986 437 911</b>
<b>TGD</b>							
<b>18.400</b>	WW	10,5	294	D 2066 LF49 <Euro 3>	06.10→	<b>0 445 020 208</b>	<b>0 986 437 350</b>
<b>TGL</b>							
<b>7.150</b>		4,6	110	D 0834 LFLAA <Euro 6/OBDC>; D 0834 LFL66 <Euro 6>	06.13→	<b>0 445 020 206</b>	<b>0 986 437 359</b>
				D 0834 LFL40 <Euro 3>	06.11→	<b>0 445 020 203</b>	<b>0 986 437 352</b>
				D 0834 LFL60 <Euro 5/EEV/OBD2>; D 0834 LFL63 <Euro 5/OBD2>	04.09→	<b>0 445 020 206</b>	<b>0 986 437 359</b>
L		4,6	110	D 0834 LFL40 <Euro 3>	05.05-09.06	<b>0 445 020 203</b>	<b>0 986 437 352</b>
				D 0834 LFL50 <Euro 4/OBD1>	04.06-12.13 TW	<b>0 445 020 203</b>	<b>0 986 437 352</b>
						<b>0 445 020 208</b>	<b>0 986 437 350</b>
				D 0834 LFL53 <Euro 4/OBD1>	09.07→	<b>0 445 020 203</b>	<b>0 986 437 352</b>
<b>7.160</b>		4,6	118	D 0834 LFL77 <Euro 6/OBDC>	09.17→	<b>0 445 020 206</b>	<b>0 986 437 359</b>
<b>7.180</b>		4,6	132	D 0834 LFLAB <Euro 6/OBDC>; D 0834 LFL67 <Euro 6>	06.13→	<b>0 445 020 206</b>	<b>0 986 437 359</b>
				D 0834 LFL41 <Euro 3>	06.11→	<b>0 445 020 203</b>	<b>0 986 437 352</b>
				D 0834 LFL61 <Euro 5/EEV/OBD2>; D 0834 LFL64 <Euro 5/OBD2>	04.09→	<b>0 445 020 206</b>	<b>0 986 437 359</b>
L		4,6	132	D 0834 LFL41 <Euro 3>	05.05-09.06	<b>0 445 020 203</b>	<b>0 986 437 352</b>
				D 0834 LFL51 <Euro 4/OBD1>; D 0834 LFL54 <Euro 4/OBD1>	04.06→	<b>0 445 020 203</b>	<b>0 986 437 352</b>
<b>7.190</b>		4,6	140	D 0834 LFL78 <Euro 6/OBDC>	09.17→	<b>0 445 020 206</b>	<b>0 986 437 359</b>
<b>8.150</b>		4,6	110	D 0834 LFLAA <Euro 6/OBDC>; D 0834 LFL66 <Euro 6>	06.13→	<b>0 445 020 206</b>	<b>0 986 437 359</b>
				D 0834 LFL40 <Euro 3>	06.11→	<b>0 445 020 203</b>	<b>0 986 437 352</b>
				D 0834 LFL60 <Euro 5/EEV/OBD2>; D 0834 LFL63 <Euro 5/OBD2>	04.09→	<b>0 445 020 206</b>	<b>0 986 437 359</b>
L		4,6	110	D 0834 LFL50 <Euro 4/OBD1>	02.07-12.13 TW	<b>0 445 020 203</b>	<b>0 986 437 352</b>
						<b>0 445 020 208</b>	<b>0 986 437 350</b>
				D 0834 LFL53 <Euro 4/OBD1>	09.07→	<b>0 445 020 203</b>	<b>0 986 437 352</b>
<b>8.160</b>		4,6	118	D 0834 LFL77 <Euro 6/OBDC>	09.17→	<b>0 445 020 206</b>	<b>0 986 437 359</b>
<b>8.180</b>		4,6	132	D 0834 LFLAB <Euro 6/OBDC>; D 0834 LFL61 <Euro 5/EEV/OBD2>; D 0834 LFL64 <Euro 5/OBD2>; D 0834 LFL67 <Euro 6>	04.09→	<b>0 445 020 206</b>	<b>0 986 437 359</b>
L		4,6	132	D 0834 LFL41 <Euro 3>; D 0834 LFL51 <Euro 4/OBD1>; D 0834 LFL54 <Euro 4/OBD1>	05.05→	<b>0 445 020 203</b>	<b>0 986 437 352</b>
<b>8.190</b>		4,6	140	D 0834 LFL78 <Euro 6/OBDC>	09.17→	<b>0 445 020 206</b>	<b>0 986 437 359</b>
<b>8.210</b>	L	4,6	151	D 0834 LFL42 <Euro 3>; D 0834 LFL52 <Euro 4/OBD1>; D 0834 LFL55 <Euro 4/OBD1>	05.05→	<b>0 445 020 203</b>	<b>0 986 437 352</b>
<b>8.220</b>		4,6	162	D 0834 LFLAC <Euro 6/OBDC>; D 0834 LFL62 <Euro 5/EEV/OBD2>; D 0834 LFL65 <Euro 5/OBD2>; D 0834 LFL68 <Euro 6>; D 0834 LFL79 <Euro 6/OBDC>	04.09→	<b>0 445 020 206</b>	<b>0 986 437 359</b>
<b>8.240</b>	L	6,9	176	D 0836 LFL40 <Euro 3>	05.05-12.13 TW	<b>0 445 020 203</b>	<b>0 986 437 352</b>
						<b>0 445 020 204</b>	
				D 0836 LFL50 <Euro 4/OBD1>	04.06-05.13 TW	<b>0 445 020 203</b>	<b>0 986 437 352</b>
						<b>0 445 020 204</b>	
					06.13-12.13	<b>0 445 020 204</b>	
				D 0836 LFL53 <Euro 4/OBD1>	09.07-12.13	<b>0 445 020 203</b>	<b>0 986 437 352</b>
<b>8.250</b>		6,9	184	D 0836 LFLAA <Euro 6/OBDC>; D 0836 LFL66 <Euro 6>; D 0836 LFL79 <Euro 6/OBDC>	06.13→	<b>0 445 020 206</b>	<b>0 986 437 359</b>
				D 0836 LFL60 <Euro 5/EEV/OBD2>	04.09-06.16	<b>0 445 020 206</b>	<b>0 986 437 359</b>
				D 0836 LFL63 <Euro 5/OBD2>	04.09→ TW	<b>0 445 020 206</b>	<b>0 986 437 359</b>
						<b>0 445 020 207</b>	





<b>10.180</b>	4,6	132	D 0834 LFLAB <Euro 6/OBDC>; D 0834 LFL61 <Euro 5/EEV/OBD2>; D 0834 LFL64 <Euro 5/OBD2>; D 0834 LFL67 <Euro 6>	04.09→		<b>0 445 020 206</b>	<b>0 986 437 359</b>
L	4,6	132	D 0834 LFL41 <Euro 3>; D 0834 LFL51 <Euro 4/OBD1>; D 0834 LFL54 <Euro 4/OBD1>	05.05→		<b>0 445 020 203</b>	<b>0 986 437 352</b>
<b>10.190</b>	4,6	140	D 0834 LFL78 <Euro 6/OBDC>	09.17→		<b>0 445 020 206</b>	<b>0 986 437 359</b>
<b>10.210 L</b>	4,6	151	D 0834 LFL42 <Euro 3>; D 0834 LFL52 <Euro 4/OBD1>; D 0834 LFL55 <Euro 4/OBD1>	05.05→		<b>0 445 020 203</b>	<b>0 986 437 352</b>
<b>10.220</b>	4,6	162	D 0834 LFLAC <Euro 6/OBDC>; D 0834 LFL62 <Euro 5/EEV/OBD2>; D 0834 LFL65 <Euro 5/OBD2>; D 0834 LFL68 <Euro 6>; D 0834 LFL79 <Euro 6/OBDC>	04.09→		<b>0 445 020 206</b>	<b>0 986 437 359</b>
<b>10.240 L</b>	6,9	176	D 0836 LFL40 <Euro 3>	05.05→	TW	<b>0 445 020 203</b>	<b>0 986 437 352</b>
			D 0836 LFL50 <Euro 4/OBD1>	04.06-05.13	TW	<b>0 445 020 203</b>	<b>0 986 437 352</b>
				06.13-12.13		<b>0 445 020 204</b>	
			D 0836 LFL53 <Euro 4/OBD1>	09.07→		<b>0 445 020 203</b>	<b>0 986 437 352</b>
<b>10.250</b>	6,9	184	D 0836 LFLAA <Euro 6/OBDC>; D 0836 LFL66 <Euro 6>; D 0836 LFL79 <Euro 6/OBDC>	06.13→		<b>0 445 020 206</b>	<b>0 986 437 359</b>
			D 0836 LFL60 <Euro 5/EEV/OBD2>	04.09-06.16		<b>0 445 020 206</b>	<b>0 986 437 359</b>
			D 0836 LFL63 <Euro 5/OBD2>	04.09→	TW	<b>0 445 020 206</b>	<b>0 986 437 359</b>
						<b>0 445 020 207</b>	
<b>12.180</b>	4,6	132	D 0834 LFLAB <Euro 6/OBDC>; D 0834 LFL61 <Euro 5/EEV/OBD2>; D 0834 LFL64 <Euro 5/OBD2>; D 0834 LFL67 <Euro 6>	04.09→		<b>0 445 020 206</b>	<b>0 986 437 359</b>
L	4,6	132	D 0834 LFL41 <Euro 3>; D 0834 LFL51 <Euro 4/OBD1>; D 0834 LFL54 <Euro 4/OBD1>	05.05→		<b>0 445 020 203</b>	<b>0 986 437 352</b>
<b>12.190</b>	4,6	140	D 0834 LFL78 <Euro 6/OBDC>	09.17→		<b>0 445 020 206</b>	<b>0 986 437 359</b>
<b>12.210 L</b>	4,6	151	D 0834 LFL42 <Euro 3>; D 0834 LFL52 <Euro 4/OBD1>; D 0834 LFL55 <Euro 4/OBD1>	05.05→		<b>0 445 020 203</b>	<b>0 986 437 352</b>
<b>12.220</b>	4,6	162	D 0834 LFLAC <Euro 6/OBDC>; D 0834 LFL62 <Euro 5/EEV/OBD2>; D 0834 LFL65 <Euro 5/OBD2>; D 0834 LFL68 <Euro 6>; D 0834 LFL79 <Euro 6/OBDC>	04.09→		<b>0 445 020 206</b>	<b>0 986 437 359</b>
<b>12.240 L</b>	6,9	176	D 0836 LFL40 <Euro 3>	05.05→	TW	<b>0 445 020 203</b>	<b>0 986 437 352</b>
			D 0836 LFL50 <Euro 4/OBD1>	04.06-05.13	TW	<b>0 445 020 203</b>	<b>0 986 437 352</b>
				06.13-12.13		<b>0 445 020 204</b>	
			D 0836 LFL53 <Euro 4/OBD1>	09.07→		<b>0 445 020 203</b>	<b>0 986 437 352</b>
<b>12.250</b>	6,9	184	D 0836 LFLAA <Euro 6/OBDC>; D 0836 LFL66 <Euro 6>; D 0836 LFL79 <Euro 6/OBDC>	06.13→		<b>0 445 020 206</b>	<b>0 986 437 359</b>
			D 0836 LFL60 <Euro 5/EEV/OBD2>	04.09-06.16		<b>0 445 020 206</b>	<b>0 986 437 359</b>
			D 0836 LFL63 <Euro 5/OBD2>	04.09→	TW	<b>0 445 020 206</b>	<b>0 986 437 359</b>
						<b>0 445 020 207</b>	
<b>TGM</b>							
<b>12.240 L</b>	6,9	176	D 0836 LFL50 <Euro 4/OBD1>	04.06-05.13	TW	<b>0 445 020 203</b>	<b>0 986 437 352</b>
				06.13-12.13		<b>0 445 020 204</b>	
			D 0836 LFL53 <Euro 4/OBD1>	09.07→		<b>0 445 020 203</b>	<b>0 986 437 352</b>
<b>12.250</b>	6,9	184	D 0836 LFLAA <Euro 6/OBDC>; D 0836 LFL66 <Euro 6>; D 0836 LFL79 <Euro 6/OBDC>	06.13→		<b>0 445 020 206</b>	<b>0 986 437 359</b>
			D 0836 LFL60 <Euro 5/EEV/OBD2>	04.09-06.16		<b>0 445 020 206</b>	<b>0 986 437 359</b>
			D 0836 LFL63 <Euro 5/OBD2>	04.09→	TW	<b>0 445 020 206</b>	<b>0 986 437 359</b>
						<b>0 445 020 207</b>	
<b>12.280 L</b>	6,9	206	D 0836 LFL51 <Euro 4/OBD1>	04.06-09.07	TW	<b>0 445 020 203</b>	<b>0 986 437 352</b>
			D 0836 LFL54 <Euro 4/OBD1>	09.07→		<b>0 445 020 203</b>	<b>0 986 437 352</b>
<b>12.290</b>	6,9	213	D 0836 LFLAB <Euro 6/OBDC>; D 0836 LFL67 <Euro 6>; D 0836 LFL80 <Euro 6/OBDC>	06.13→		<b>0 445 020 206</b>	<b>0 986 437 359</b>
			D 0836 LFL61 <Euro 5/EEV/OBD2>	04.09→		<b>0 445 020 206</b>	<b>0 986 437 359</b>













◀ MAN

<b>12.290</b>	6,9	213	D 0836 LFL64 <Euro 5/OBD2>	04.09→	TW	<b>0 445 020 206</b>	<b>0 986 437 359</b>
						<b>0 445 020 207</b>	
<b>13.290</b>	6,9	213	D 0836 LFL67 <Euro 6>	06.13-05.17		<b>0 445 020 206</b>	<b>0 986 437 359</b>
<b>13.240 L</b>	6,9	176	D 0836 LFL40 <Euro 3>	10.06→	TW	<b>0 445 020 203</b>	<b>0 986 437 352</b>
						<b>0 445 020 204</b>	
			D 0836 LFL50 <Euro 4/OBD1>	10.06-05.13	TW	<b>0 445 020 203</b>	<b>0 986 437 352</b>
						<b>0 445 020 204</b>	
				06.13-12.13		<b>0 445 020 204</b>	
			D 0836 LFL53 <Euro 4/OBD1>	09.07→		<b>0 445 020 203</b>	<b>0 986 437 352</b>
<b>13.250</b>	6,9	184	D 0836 LFLAA <Euro 6/OBDC>; D 0836 LFL66 <Euro 6>; D 0836 LFL79 <Euro 6/OBDC>	06.13→		<b>0 445 020 206</b>	<b>0 986 437 359</b>
			D 0836 LFL60 <Euro 5/EEV/OBD2>	04.09-06.16		<b>0 445 020 206</b>	<b>0 986 437 359</b>
			D 0836 LFL63 <Euro 5/OBD2>	04.09→	TW	<b>0 445 020 206</b>	<b>0 986 437 359</b>
						<b>0 445 020 207</b>	
<b>13.280 L</b>	6,9	206	D 0836 LFL41 <Euro 3>; D 0836 LFL51 <Euro 4/OBD1>	07.06→	TW	<b>0 445 020 203</b>	<b>0 986 437 352</b>
						<b>0 445 020 204</b>	
			D 0836 LFL54 <Euro 4/OBD1>	09.07→		<b>0 445 020 203</b>	<b>0 986 437 352</b>
<b>13.290</b>	6,9	213	D 0836 LFLAB <Euro 6/OBDC>; D 0836 LFL80 <Euro 6/OBDC>	06.16→		<b>0 445 020 206</b>	<b>0 986 437 359</b>
			D 0836 LFL61 <Euro 5/EEV/OBD2>	04.09→		<b>0 445 020 206</b>	<b>0 986 437 359</b>
			D 0836 LFL64 <Euro 5/OBD2>	04.09→	TW	<b>0 445 020 206</b>	<b>0 986 437 359</b>
						<b>0 445 020 207</b>	
<b>15.240</b>	6,9	176	D 0836 LFL40 <Euro 3>	09.11→	TW	<b>0 445 020 203</b>	<b>0 986 437 352</b>
						<b>0 445 020 204</b>	
L	6,9	176	D 0836 LFL50 <Euro 4/OBD1>	04.06-05.13	TW	<b>0 445 020 203</b>	<b>0 986 437 352</b>
						<b>0 445 020 204</b>	
				06.13-12.13		<b>0 445 020 204</b>	
			D 0836 LFL53 <Euro 4/OBD1>	09.07→		<b>0 445 020 203</b>	<b>0 986 437 352</b>
<b>15.250</b>	6,9	184	D 0836 LFLAA <Euro 6/OBDC>; D 0836 LFL66 <Euro 6>; D 0836 LFL79 <Euro 6/OBDC>	06.13→		<b>0 445 020 206</b>	<b>0 986 437 359</b>
			D 0836 LFL60 <Euro 5/EEV/OBD2>	04.09-06.16		<b>0 445 020 206</b>	<b>0 986 437 359</b>
			D 0836 LFL63 <Euro 5/OBD2>	04.09→	TW	<b>0 445 020 206</b>	<b>0 986 437 359</b>
						<b>0 445 020 207</b>	
<b>15.280</b>	6,9	206	D 0836 LFL41 <Euro 3>	09.11→	TW	<b>0 445 020 203</b>	<b>0 986 437 352</b>
						<b>0 445 020 204</b>	
L	6,9	206	D 0836 LFL51 <Euro 4/OBD1>	04.06-09.07	TW	<b>0 445 020 203</b>	<b>0 986 437 352</b>
						<b>0 445 020 204</b>	
			D 0836 LFL54 <Euro 4/OBD1>	09.07→		<b>0 445 020 203</b>	<b>0 986 437 352</b>
<b>15.290</b>	6,9	213	D 0836 LFLAB <Euro 6/OBDC>; D 0836 LFL67 <Euro 6>; D 0836 LFL80 <Euro 6/OBDC>	06.13→		<b>0 445 020 206</b>	<b>0 986 437 359</b>
			D 0836 LFL61 <Euro 5/EEV/OBD2>	04.09→		<b>0 445 020 206</b>	<b>0 986 437 359</b>
			D 0836 LFL64 <Euro 5/OBD2>	04.09→	TW	<b>0 445 020 206</b>	<b>0 986 437 359</b>
						<b>0 445 020 207</b>	
<b>15.320</b>	6,9	235	D 0836 LFL81 <Euro 6/OBDC>	09.17→		<b>0 445 020 206</b>	<b>0 986 437 359</b>
<b>15.330</b>	6,9	240	D 0836 LFL44 <Euro 3>	09.11→	TW	<b>0 445 020 203</b>	<b>0 986 437 352</b>
						<b>0 445 020 204</b>	
L	6,9	240	D 0836 LFL51 <Euro 4/OBD1>	04.06-09.07	TW	<b>0 445 020 203</b>	<b>0 986 437 352</b>
						<b>0 445 020 204</b>	
			D 0836 LFL55 <Euro 4/OBD1>	09.07→		<b>0 445 020 203</b>	<b>0 986 437 352</b>
<b>15.340</b>	6,9	250	D 0836 LFL62 <Euro 5/EEV/OBD2>	04.09→		<b>0 445 020 206</b>	<b>0 986 437 359</b>
			D 0836 LFL65 <Euro 5/OBD2>	04.09→	TW	<b>0 445 020 206</b>	<b>0 986 437 359</b>
						<b>0 445 020 207</b>	
		250/251	D 0836 LFLAC <Euro 6/OBDC>; D 0836 LFL68 <Euro 6>	06.13→		<b>0 445 020 206</b>	<b>0 986 437 359</b>
<b>18.240 L</b>	6,9	176	D 0836 LFL40 <Euro 3>	10.05→	TW	<b>0 445 020 203</b>	<b>0 986 437 352</b>
						<b>0 445 020 204</b>	
			D 0836 LFL50 <Euro 4/OBD1>	04.06-05.13	TW	<b>0 445 020 203</b>	<b>0 986 437 352</b>
						<b>0 445 020 204</b>	
				06.13-12.13		<b>0 445 020 204</b>	
			D 0836 LFL53 <Euro 4/OBD1>	09.07→		<b>0 445 020 203</b>	<b>0 986 437 352</b>
<b>18.250</b>	6,9	184	D 0836 LFLAA <Euro 6/OBDC>; D 0836 LFL66 <Euro 6>; D 0836 LFL79 <Euro 6/OBDC>	06.13→		<b>0 445 020 206</b>	<b>0 986 437 359</b>
			D 0836 LFL60 <Euro 5/EEV/OBD2>	04.09-06.16		<b>0 445 020 206</b>	<b>0 986 437 359</b>





									
	l/ccm	kW/(PS)	Typ						eXchange
<b>18.250</b>	6,9	184	D 0836 LFL63 <Euro 5/OBD2>	04.09→	TW			<b>0 445 020 206</b>	<b>0 986 437 359</b>
								<b>0 445 020 207</b>	
<b>18.280</b>	6,9	206	D 0836 LFL54 <Euro 4/OBD1>	09.07→				<b>0 445 020 203</b>	<b>0 986 437 352</b>
L	6,9	206	D 0836 LFL41 <Euro 3>	10.05→	TW			<b>0 445 020 203</b>	<b>0 986 437 352</b>
								<b>0 445 020 204</b>	
			D 0836 LFL51 <Euro 4/OBD1>	04.06-05.13	TW			<b>0 445 020 203</b>	<b>0 986 437 352</b>
				06.13-12.13				<b>0 445 020 204</b>	
<b>18.290</b>	6,9	213	D 0836 LFLAB <Euro 6/OBDC>; D 0836 LFL67 <Euro 6>; D 0836 LFL80 <Euro 6/OBDC>	06.13→				<b>0 445 020 206</b>	<b>0 986 437 359</b>
			D 0836 LFL61 <Euro 5/EEV/OBD2>	04.09→				<b>0 445 020 206</b>	<b>0 986 437 359</b>
			D 0836 LFL64 <Euro 5/OBD2>	04.09→	TW			<b>0 445 020 206</b>	<b>0 986 437 359</b>
								<b>0 445 020 207</b>	
<b>18.320</b>	6,9	235	D 0836 LFL81 <Euro 6/OBDC>	09.17→				<b>0 445 020 206</b>	<b>0 986 437 359</b>
	10,5	235	D 2066 LF68 <Euro 6>; D 2066 LF81 <Euro 6>	10.12→				<b>0 445 020 277</b>	<b>0 986 437 383</b>
<b>18.330</b>	6,9	240	D 0836 LFL55 <Euro 4/OBD1>	09.07→				<b>0 445 020 203</b>	<b>0 986 437 352</b>
L	6,9	240	D 0836 LFL44 <Euro 3>	10.05→	TW			<b>0 445 020 203</b>	<b>0 986 437 352</b>
								<b>0 445 020 204</b>	
			D 0836 LFL52 <Euro 4/OBD1>	07.06-05.13	TW			<b>0 445 020 203</b>	<b>0 986 437 352</b>
				06.13-12.13				<b>0 445 020 204</b>	
<b>18.340</b>	6,9	250	D 0836 LFL62 <Euro 5/EEV/OBD2>	04.09→				<b>0 445 020 206</b>	<b>0 986 437 359</b>
			D 0836 LFL65 <Euro 5/OBD2>	04.09→	TW			<b>0 445 020 206</b>	<b>0 986 437 359</b>
								<b>0 445 020 207</b>	
		250/251	D 0836 LFLAC <Euro 6/OBDC>; D 0836 LFL68 <Euro 6>	06.13→				<b>0 445 020 206</b>	<b>0 986 437 359</b>
<b>18.360</b>	10,5	265	D 2066 LF80 <Euro 6>	06.15→				<b>0 445 020 277</b>	<b>0 986 437 383</b>
<b>19.250</b>	6,9	184	D 0836 LFLAA <Euro 6/OBDC>; D 0836 LFL66 <Euro 6>; D 0836 LFL79 <Euro 6/OBDC>	06.13→				<b>0 445 020 206</b>	<b>0 986 437 359</b>
			D 0836 LFL60 <Euro 5/EEV/OBD2>	10.12-06.16				<b>0 445 020 206</b>	<b>0 986 437 359</b>
			D 0836 LFL63 <Euro 5/OBD2>	10.12→	TW			<b>0 445 020 206</b>	<b>0 986 437 359</b>
								<b>0 445 020 207</b>	
<b>19.290</b>	6,9	213	D 0836 LFLAB <Euro 6/OBDC>; D 0836 LFL67 <Euro 6>; D 0836 LFL80 <Euro 6/OBDC>	06.13→				<b>0 445 020 206</b>	<b>0 986 437 359</b>
			D 0836 LFL61 <Euro 5/EEV/OBD2>	10.12→				<b>0 445 020 206</b>	<b>0 986 437 359</b>
			D 0836 LFL64 <Euro 5/OBD2>	10.12→	TW			<b>0 445 020 206</b>	<b>0 986 437 359</b>
								<b>0 445 020 207</b>	
<b>19.320</b>	6,9	235	D 0836 LFL81 <Euro 6/OBDC>	09.17→				<b>0 445 020 206</b>	<b>0 986 437 359</b>
<b>19.340</b>	6,9	250	D 0836 LFL62 <Euro 5/EEV/OBD2>	10.12→				<b>0 445 020 206</b>	<b>0 986 437 359</b>
			D 0836 LFL65 <Euro 5/OBD2>	10.12→	TW			<b>0 445 020 206</b>	<b>0 986 437 359</b>
								<b>0 445 020 207</b>	
		250/251	D 0836 LFLAC <Euro 6/OBDC>; D 0836 LFL68 <Euro 6>	06.13→				<b>0 445 020 206</b>	<b>0 986 437 359</b>
<b>22.240 L</b>	6,9	176	D 0836 LFL53 <Euro 4/OBD1>	09.07→				<b>0 445 020 203</b>	<b>0 986 437 352</b>
<b>22.250</b>	6,9	184	D 0836 LFL60 <Euro 5/EEV/OBD2>	04.09-06.16				<b>0 445 020 206</b>	<b>0 986 437 359</b>
			D 0836 LFL63 <Euro 5/OBD2>	04.09→	TW			<b>0 445 020 206</b>	<b>0 986 437 359</b>
								<b>0 445 020 207</b>	
			D 0836 LFL66 <Euro 6>	06.13-06.16				<b>0 445 020 206</b>	<b>0 986 437 359</b>
<b>22.280</b>	6,9	206	D 0836 LFL54 <Euro 4/OBD1>	09.07→				<b>0 445 020 203</b>	<b>0 986 437 352</b>
<b>22.290</b>	6,9	213	D 0836 LFL61 <Euro 5/EEV/OBD2>	04.09→				<b>0 445 020 206</b>	<b>0 986 437 359</b>
			D 0836 LFL64 <Euro 5/OBD2>	04.09→	TW			<b>0 445 020 206</b>	<b>0 986 437 359</b>
								<b>0 445 020 207</b>	
			D 0836 LFL67 <Euro 6>	06.13-06.16				<b>0 445 020 206</b>	<b>0 986 437 359</b>
<b>26.280 L</b>	6,9	206	D 0836 LFL51 <Euro 4/OBD1>	09.06-05.13	TW			<b>0 445 020 203</b>	<b>0 986 437 352</b>
				06.13-12.13				<b>0 445 020 204</b>	
			D 0836 LFL54 <Euro 4/OBD1>	09.07→				<b>0 445 020 203</b>	<b>0 986 437 352</b>
<b>26.290</b>	6,9	213	D 0836 LFLAB <Euro 6/OBDC>; D 0836 LFL67 <Euro 6>; D 0836 LFL80 <Euro 6/OBDC>	06.13→				<b>0 445 020 206</b>	<b>0 986 437 359</b>
			D 0836 LFL61 <Euro 5/EEV/OBD2>	04.09→				<b>0 445 020 206</b>	<b>0 986 437 359</b>
			D 0836 LFL64 <Euro 5/OBD2>	04.09→	TW			<b>0 445 020 206</b>	<b>0 986 437 359</b>
								<b>0 445 020 207</b>	
<b>26.320</b>	6,9	235	D 0836 LFL81 <Euro 6/OBDC>	09.17→				<b>0 445 020 206</b>	<b>0 986 437 359</b>















◀ MAN

<b>26.330 L</b>	6,9	240	D 0836 LFL52 <Euro 4/OBD1>	07.06-05.13 TW	<b>0 445 020 203</b>	<b>0 986 437 352</b>
				06.13-12.13	<b>0 445 020 204</b>	
			D 0836 LFL55 <Euro 4/OBD1>	09.07→	<b>0 445 020 203</b>	<b>0 986 437 352</b>
<b>26.340</b>	6,9	250	D 0836 LFL62 <Euro 5/EEV/OBD2>	04.09→	<b>0 445 020 206</b>	<b>0 986 437 359</b>
			D 0836 LFL65 <Euro 5/OBD2>	04.09→ TW	<b>0 445 020 206</b>	<b>0 986 437 359</b>
					<b>0 445 020 207</b>	
		250/251	D 0836 LFLAC <Euro 6/OBDC>; D 0836 LFL68 <Euro 6>	06.13→	<b>0 445 020 206</b>	<b>0 986 437 359</b>
<b>TGS</b>						
<b>18.320</b>	10,5	235	D 2066 LF20 <Euro 5/OBD1>; D 2066 LF28 <Euro 5/OBD1>; D 2066 LF39 <Euro 4/OBD1>; D 2066 LF43 <Euro 5/OBD2>; D 2066 LF60 <Euro 5/EEV/OBD2>	10.07→	<b>0 445 020 208</b>	<b>0 986 437 350</b>
			D 2066 LF53 <Euro 5/OBD2>	10.09-06.16	<b>0 445 020 277</b>	<b>0 986 437 383</b>
			D 2066 LF86 <Euro 6/OBDC>	09.16→	<b>0 445 020 277</b>	<b>0 986 437 383</b>
<b>18.350 WW</b>	10,5	257	D 2066 LF03 <Euro 3>	06.10-12.13	<b>0 445 020 023</b>	<b>0 986 437 351</b>
<b>18.360</b>	10,5	265	D 2066 LF19 <Euro 5/OBD1>; D 2066 LF27 <Euro 5/OBD1>; D 2066 LF38 <Euro 4/OBD1>	10.07-06.16	<b>0 445 020 208</b>	<b>0 986 437 350</b>
			D 2066 LF52 <Euro 5/OBD2>	10.09-06.16	<b>0 445 020 277</b>	<b>0 986 437 383</b>
			D 2066 LF59 <Euro 5/EEV/OBD2>	09.09→	<b>0 445 020 208</b>	<b>0 986 437 350</b>
			D 2066 LF67 <Euro 6>	10.12-06.16	<b>0 445 020 277</b>	<b>0 986 437 383</b>
			D 2066 LF85 <Euro 6/OBDC>	09.16→	<b>0 445 020 277</b>	<b>0 986 437 383</b>
, WW	10,5	265	D 2066 LF42 <Euro 5/OBD2>	09.09→	<b>0 445 020 208</b>	<b>0 986 437 350</b>
WW	10,5	265	D 2066 LF48 <Euro 3>; D 2066 LF64 <Euro 4/OBD2>	06.10→	<b>0 445 020 208</b>	<b>0 986 437 350</b>
<b>18.390 WW</b>	10,5	287	D 2066 LF02 <Euro 3>	06.10-12.13	<b>0 445 020 023</b>	<b>0 986 437 351</b>
<b>18.400</b>	10,5	294	D 2066 LF18 <Euro 5/OBD1>; D 2066 LF26 <Euro 5/OBD1>; D 2066 LF37 <Euro 4/OBD1>	10.07-06.16	<b>0 445 020 208</b>	<b>0 986 437 350</b>
			D 2066 LF51 <Euro 5/OBD2>	10.09-06.16 TW	<b>0 445 020 208</b>	<b>0 986 437 350</b>
					<b>0 445 020 277</b>	<b>0 986 437 383</b>
			D 2066 LF58 <Euro 5/EEV/OBD2>	09.09→	<b>0 445 020 208</b>	<b>0 986 437 350</b>
			D 2066 LF61 <Euro 6>	10.12-06.16 TW	<b>0 445 020 208</b>	<b>0 986 437 350</b>
					<b>0 445 020 277</b>	<b>0 986 437 383</b>
	12,4	294	D 2676 LF47 <Euro 6>	03.15→	<b>0 445 020 277</b>	<b>0 986 437 383</b>
, WW	10,5	294	D 2066 LF41 <Euro 5/OBD2>	09.09→	<b>0 445 020 208</b>	<b>0 986 437 350</b>
WW	10,5	294	D 2066 LF63 <Euro 4/OBD2>	06.10→	<b>0 445 020 208</b>	<b>0 986 437 350</b>
<b>18.420</b>	12,4	309	D 2676 LF53 <Euro 6/OBDC>	06.16→	<b>0 445 020 277</b>	<b>0 986 437 383</b>
<b>18.430 WW</b>	10,5	316	D 2066 LF01 <Euro 3>	06.10-12.13	<b>0 445 020 023</b>	<b>0 986 437 351</b>
<b>18.440</b>	12,4	324	D 2676 LF22 <Euro 5/OBD2>	10.09-06.16 TW	<b>0 445 020 208</b>	<b>0 986 437 350</b>
					<b>0 445 020 277</b>	<b>0 986 437 383</b>
			D 2676 LF26 <Euro 6>; D 2676 LF46 <Euro 6>	10.12→	<b>0 445 020 277</b>	<b>0 986 437 383</b>
, WW	10,5	324	D 2066 LF17 <Euro 5/OBD1>; D 2066 LF25 <Euro 5/OBD1>; D 2066 LF36 <Euro 4/OBD1>; D 2066 LF40 <Euro 5/OBD2>; D 2066 LF50 <Euro 3>; D 2066 LF57 <Euro 5/EEV/OBD2>; D 2066 LF62 <Euro 4/OBD2>	10.07→	<b>0 445 020 208</b>	<b>0 986 437 350</b>
<b>18.460</b>	12,4	338	D 2676 LF52 <Euro 6/OBDC>	06.16→	<b>0 445 020 277</b>	<b>0 986 437 383</b>
<b>18.480</b>	12,4	353	D 2676 LF25 <Euro 6>; D 2676 LF45 <Euro 6>	10.12→	<b>0 445 020 277</b>	<b>0 986 437 383</b>
, F, FL	12,4	353	D 2676 LF05 <Euro 4/OBD1>; D 2676 LF14 <Euro 5/OBD1>; D 2676 LF16 <Euro 5/OBD1>	10.07-06.16	<b>0 445 020 208</b>	<b>0 986 437 350</b>
, WW	12,4	353	D 2676 LF02 <Euro 3>; D 2676 LF18 <Euro 5/EEV/OBD2>; D 2676 LF20 <Euro 4/OBD2>	09.09→	<b>0 445 020 208</b>	<b>0 986 437 350</b>
			D 2676 LF07 <Euro 5/OBD2>	09.09→	<b>0 445 020 208</b>	<b>0 986 437 350</b>
<b>18.500</b>	12,4	368	D 2676 LF51 <Euro 6/OBDC>	06.16→	<b>0 445 020 277</b>	<b>0 986 437 383</b>
<b>18.540</b>	12,4	397	D 2676 LF06 <Euro 5/OBD2>; D 2676 LF13 <Euro 5/OBD1>; D 2676 LF15 <Euro 5/OBD1>	10.07→	<b>0 445 020 208</b>	<b>0 986 437 350</b>
<b>19.320 WW</b>	10,5	235	D 2066 LF43 <Euro 5/OBD2>	06.16→	<b>0 445 020 208</b>	<b>0 986 437 350</b>
<b>19.350 WW</b>	10,5	257	D 2066 LF03 <Euro 3>	01.10-12.13	<b>0 445 020 023</b>	<b>0 986 437 351</b>
<b>19.360 WW</b>	10,5	265	D 2066 LF07 <Euro 2>	01.10→	<b>0 445 020 023</b>	<b>0 986 437 351</b>
			D 2066 LF42 <Euro 5/OBD2>; D 2066 LF48 <Euro 3>; D 2066 LF59 <Euro 5/EEV/OBD2>; D 2066 LF64 <Euro 4/OBD2>	02.11→	<b>0 445 020 208</b>	<b>0 986 437 350</b>
<b>19.390 WW</b>	10,5	287	D 2066 LF02 <Euro 3>	01.10-12.13	<b>0 445 020 023</b>	<b>0 986 437 351</b>



									
19.400 WW	10,5	294	D 2066 LF06 <Euro 2>	01.10→				0 445 020 023	0 986 437 351
			D 2066 LF41 <Euro 5/OBD2>; D 2066 LF49 <Euro 3>; D 2066 LF58 <Euro 5/EEV/OBD2>; D 2066 LF63 <Euro 4/OBD2>	02.11→				0 445 020 208	0 986 437 350
19.430 WW	10,5	316	D 2066 LF01 <Euro 3>	01.10-12.13				0 445 020 023	0 986 437 351
19.440 WW	10,5	324	D 2066 LF40 <Euro 5/OBD2>; D 2066 LF50 <Euro 3>; D 2066 LF57 <Euro 5/EEV/OBD2>; D 2066 LF62 <Euro 4/OBD2>	02.11→				0 445 020 208	0 986 437 350
			D 2676 LF04 <Euro 2>	01.10→				0 445 020 208	0 986 437 350
19.480 WW	12,4	353	D 2676 LF02 <Euro 3>; D 2676 LF03 <Euro 2>; D 2676 LF07 <Euro 5/OBD2>; D 2676 LF18 <Euro 5/EEV/OBD2>; D 2676 LF20 <Euro 4/OBD2>	01.10→				0 445 020 208	0 986 437 350
			D 2066 LF43 <Euro 5/OBD2>; D 2066 LF60 <Euro 5/EEV/OBD2>	07.17→				0 445 020 208	0 986 437 350
20.320 , WW	10,5	265	D 2066 LF42 <Euro 5/OBD2>; D 2066 LF59 <Euro 5/EEV/OBD2>	07.17→				0 445 020 208	0 986 437 350
20.360 , WW	10,5	265	D 2066 LF42 <Euro 5/OBD2>; D 2066 LF59 <Euro 5/EEV/OBD2>	07.17→				0 445 020 208	0 986 437 350
20.400 , WW	10,5	294	D 2066 LF41 <Euro 5/OBD2>; D 2066 LF58 <Euro 5/EEV/OBD2>	07.17→				0 445 020 208	0 986 437 350
20.440 , WW	10,5	324	D 2066 LF40 <Euro 5/OBD2>; D 2066 LF57 <Euro 5/EEV/OBD2>	07.17→				0 445 020 208	0 986 437 350
21.320 WW	10,5	235	D 2066 LF43 <Euro 5/OBD2>	06.16→				0 445 020 208	0 986 437 350
21.360 WW	10,5	265	D 2066 LF07 <Euro 2>	05.12→				0 445 020 023	0 986 437 351
			D 2066 LF42 <Euro 5/OBD2>; D 2066 LF59 <Euro 5/EEV/OBD2>; D 2066 LF64 <Euro 4/OBD2>	05.12→				0 445 020 208	0 986 437 350
21.400 WW	10,5	294	D 2066 LF06 <Euro 2>	05.12→				0 445 020 023	0 986 437 351
			D 2066 LF41 <Euro 5/OBD2>; D 2066 LF49 <Euro 3>; D 2066 LF58 <Euro 5/EEV/OBD2>; D 2066 LF63 <Euro 4/OBD2>	05.12→				0 445 020 208	0 986 437 350
21.440 WW	10,5	324	D 2066 LF40 <Euro 5/OBD2>; D 2066 LF50 <Euro 3>; D 2066 LF57 <Euro 5/EEV/OBD2>; D 2066 LF62 <Euro 4/OBD2>	05.12→				0 445 020 208	0 986 437 350
			D 2676 LF04 <Euro 2>	05.12→				0 445 020 208	0 986 437 350
21.480 WW	12,4	353	D 2676 LF02 <Euro 3>; D 2676 LF03 <Euro 2>; D 2676 LF07 <Euro 5/OBD2>; D 2676 LF18 <Euro 5/EEV/OBD2>; D 2676 LF20 <Euro 4/OBD2>	05.12→				0 445 020 208	0 986 437 350
			D 2066 LF86 <Euro 6/OBDC>	07.17→				0 445 020 277	0 986 437 383
23.320	10,5	235	D 2066 LF86 <Euro 6/OBDC>	07.17→				0 445 020 277	0 986 437 383
23.360	10,5	265	D 2066 LF85 <Euro 6/OBDC>	07.17→				0 445 020 277	0 986 437 383
23.420	12,4	309	D 2676 LF53 <Euro 6/OBDC>	07.17→				0 445 020 277	0 986 437 383
23.460	12,4	338	D 2676 LF52 <Euro 6/OBDC>	07.17→				0 445 020 277	0 986 437 383
23.500	12,4	368	D 2676 LF51 <Euro 6/OBDC>	07.17→				0 445 020 277	0 986 437 383
24.230	10,5	235	D 2066 LF81 <Euro 6>	06.15→				0 445 020 277	0 986 437 383
24.320	10,5	235	D 2066 LF20 <Euro 5/OBD1>; D 2066 LF28 <Euro 5/OBD1>; D 2066 LF39 <Euro 4/OBD1>; D 2066 LF43 <Euro 5/OBD2>; D 2066 LF60 <Euro 5/EEV/OBD2>	10.07→				0 445 020 208	0 986 437 350
			D 2066 LF53 <Euro 5/OBD2>; D 2066 LF68 <Euro 6> D 2066 LF86 <Euro 6/OBDC>	10.09-06.16 09.16→				0 445 020 277	0 986 437 383
24.360	10,5	265	D 2066 LF19 <Euro 5/OBD1>; D 2066 LF27 <Euro 5/OBD1>; D 2066 LF38 <Euro 4/OBD1>; D 2066 LF42 <Euro 5/OBD2>; D 2066 LF59 <Euro 5/EEV/OBD2>	10.07→				0 445 020 208	0 986 437 350
			D 2066 LF52 <Euro 5/OBD2>; D 2066 LF67 <Euro 6>; D 2066 LF80 <Euro 6>; D 2066 LF85 <Euro 6/OBDC>	10.09→				0 445 020 277	0 986 437 383
24.400	10,5	294	D 2066 LF18 <Euro 5/OBD1>; D 2066 LF26 <Euro 5/OBD1>; D 2066 LF37 <Euro 4/OBD1>; D 2066 LF41 <Euro 5/OBD2>; D 2066 LF58 <Euro 5/EEV/OBD2>	10.07→				0 445 020 208	0 986 437 350
			D 2066 LF51 <Euro 5/OBD2>; D 2066 LF61 <Euro 6>	10.09-06.16 TW				0 445 020 208	0 986 437 350
24.420	12,4	294	D 2676 LF47 <Euro 6>	03.15→				0 445 020 277	0 986 437 383
			D 2676 LF53 <Euro 6/OBDC>	06.16→				0 445 020 277	0 986 437 383













◀ MAN

<b>24.440</b>	10,5	324	D 2066 LF17 <Euro 5/OBD1>; D 2066 LF25 <Euro 5/OBD1>; D 2066 LF36 <Euro 4/OBD1>; D 2066 LF40 <Euro 5/OBD2>; D 2066 LF57 <Euro 5/EEV/OBD2>	10.07→	<b>0 445 020 208</b>	<b>0 986 437 350</b>
	12,4	324	D 2676 LF22 <Euro 5/OBD2>	10.09-06.16 TW	<b>0 445 020 208</b>	<b>0 986 437 350</b>
			D 2676 LF26 <Euro 6>; D 2676 LF46 <Euro 6>	10.12→	<b>0 445 020 277</b>	<b>0 986 437 383</b>
<b>24.460</b>	12,4	338	D 2676 LF52 <Euro 6/OBDC>	06.16→	<b>0 445 020 277</b>	<b>0 986 437 383</b>
<b>24.480</b>	12,4	353	D 2676 LF25 <Euro 6>; D 2676 LF45 <Euro 6>	10.12→	<b>0 445 020 277</b>	<b>0 986 437 383</b>
, DF	12,4	353	D 2676 LF05 <Euro 4/OBD1>; D 2676 LF07 <Euro 5/OBD2>; D 2676 LF14 <Euro 5/OBD1>; D 2676 LF16 <Euro 5/OBD1>; D 2676 LF18 <Euro 5/EEV/OBD2>	10.07→	<b>0 445 020 208</b>	<b>0 986 437 350</b>
<b>24.500</b>	12,4	368	D 2676 LF51 <Euro 6/OBDC>	06.16→	<b>0 445 020 277</b>	<b>0 986 437 383</b>
<b>24.540</b>	12,4	397	D 2676 LF06 <Euro 5/OBD2>	09.09→	<b>0 445 020 208</b>	<b>0 986 437 350</b>
<b>26.320</b>	10,5	235	D 2066 LF20 <Euro 5/OBD1>; D 2066 LF28 <Euro 5/OBD1>; D 2066 LF39 <Euro 4/OBD1>; D 2066 LF43 <Euro 5/OBD2>; D 2066 LF60 <Euro 5/EEV/OBD2>	10.07→	<b>0 445 020 208</b>	<b>0 986 437 350</b>
			D 2066 LF53 <Euro 5/OBD2>; D 2066 LF68 <Euro 6>; D 2066 LF81 <Euro 6>; D 2066 LF86 <Euro 6/OBDC>	10.09→	<b>0 445 020 277</b>	<b>0 986 437 383</b>
<b>26.350 WW</b>	10,5	257	D 2066 LF03 <Euro 3>	01.10-12.13	<b>0 445 020 023</b>	<b>0 986 437 351</b>
<b>26.360</b>	10,5	265	D 2066 LF19 <Euro 5/OBD1>; D 2066 LF27 <Euro 5/OBD1>; D 2066 LF38 <Euro 4/OBD1>	10.07-06.16	<b>0 445 020 208</b>	<b>0 986 437 350</b>
			D 2066 LF52 <Euro 5/OBD2>	10.09-06.16	<b>0 445 020 277</b>	<b>0 986 437 383</b>
			D 2066 LF59 <Euro 5/EEV/OBD2>	09.09→	<b>0 445 020 208</b>	<b>0 986 437 350</b>
			D 2066 LF67 <Euro 6>; D 2066 LF80 <Euro 6>	10.12→	<b>0 445 020 277</b>	<b>0 986 437 383</b>
			D 2066 LF85 <Euro 6/OBDC>	09.16→	<b>0 445 020 277</b>	<b>0 986 437 383</b>
, WW	10,5	265	D 2066 LF42 <Euro 5/OBD2>	09.09→	<b>0 445 020 208</b>	<b>0 986 437 350</b>
WW	10,5	265	D 2066 LF48 <Euro 3>; D 2066 LF64 <Euro 4/OBD2>	02.11→	<b>0 445 020 208</b>	<b>0 986 437 350</b>
<b>26.390 WW</b>	10,5	287	D 2066 LF02 <Euro 3>	01.10-12.13	<b>0 445 020 023</b>	<b>0 986 437 351</b>
<b>26.400</b>	10,5	294	D 2066 LF18 <Euro 5/OBD1>; D 2066 LF26 <Euro 5/OBD1>; D 2066 LF37 <Euro 4/OBD1>	10.07-06.16	<b>0 445 020 208</b>	<b>0 986 437 350</b>
			D 2066 LF51 <Euro 5/OBD2>	10.09-06.16 TW	<b>0 445 020 208</b>	<b>0 986 437 350</b>
					<b>0 445 020 277</b>	<b>0 986 437 383</b>
			D 2066 LF58 <Euro 5/EEV/OBD2>	09.09→	<b>0 445 020 208</b>	<b>0 986 437 350</b>
			D 2066 LF61 <Euro 6>	10.12-06.16 TW	<b>0 445 020 208</b>	<b>0 986 437 350</b>
					<b>0 445 020 277</b>	<b>0 986 437 383</b>
	12,4	294	D 2676 LF47 <Euro 6>	03.15→	<b>0 445 020 277</b>	<b>0 986 437 383</b>
, WW	10,5	294	D 2066 LF41 <Euro 5/OBD2>	09.09→	<b>0 445 020 208</b>	<b>0 986 437 350</b>
WW	10,5	294	D 2066 LF49 <Euro 3>; D 2066 LF63 <Euro 4/OBD2>	02.11→	<b>0 445 020 208</b>	<b>0 986 437 350</b>
<b>26.420</b>	12,4	309	D 2676 LF53 <Euro 6/OBDC>	06.16→	<b>0 445 020 277</b>	<b>0 986 437 383</b>
<b>26.430 WW</b>	10,5	316	D 2066 LF01 <Euro 3>	01.10-12.13	<b>0 445 020 023</b>	<b>0 986 437 351</b>
<b>26.440</b>	12,4	324	D 2676 LF22 <Euro 5/OBD2>	10.09-06.16 TW	<b>0 445 020 208</b>	<b>0 986 437 350</b>
					<b>0 445 020 277</b>	<b>0 986 437 383</b>
			D 2676 LF26 <Euro 6>; D 2676 LF46 <Euro 6>	10.12→	<b>0 445 020 277</b>	<b>0 986 437 383</b>
, WW	10,5	324	D 2066 LF17 <Euro 5/OBD1>; D 2066 LF25 <Euro 5/OBD1>; D 2066 LF36 <Euro 4/OBD1>; D 2066 LF40 <Euro 5/OBD2>; D 2066 LF44 <Euro 5/OBD2>; D 2066 LF50 <Euro 3>; D 2066 LF57 <Euro 5/EEV/OBD2>; D 2066 LF62 <Euro 4/OBD2>	10.07→	<b>0 445 020 208</b>	<b>0 986 437 350</b>
<b>26.460</b>	12,4	338	D 2676 LF52 <Euro 6/OBDC>	06.16→	<b>0 445 020 277</b>	<b>0 986 437 383</b>
<b>26.480</b>	12,4	353	D 2676 LF05 <Euro 4/OBD1>; D 2676 LF14 <Euro 5/OBD1>; D 2676 LF25 <Euro 6>; D 2676 LF45 <Euro 6>	10.07-06.16	<b>0 445 020 208</b>	<b>0 986 437 350</b>
				10.12→	<b>0 445 020 277</b>	<b>0 986 437 383</b>
, WW	12,4	353	D 2676 LF02 <Euro 3>; D 2676 LF18 <Euro 5/EEV/OBD2>; D 2676 LF20 <Euro 4/OBD2>	09.09→	<b>0 445 020 208</b>	<b>0 986 437 350</b>
			D 2676 LF07 <Euro 5/OBD2>	09.09→	<b>0 445 020 208</b>	<b>0 986 437 350</b>
<b>26.500</b>	12,4	368	D 2676 LF51 <Euro 6/OBDC>	06.16→	<b>0 445 020 277</b>	<b>0 986 437 383</b>
<b>26.540</b>	12,4	397	D 2676 LF06 <Euro 5/OBD2>; D 2676 LF13 <Euro 5/OBD1>; D 2676 LF15 <Euro 5/OBD1>	10.07→	<b>0 445 020 208</b>	<b>0 986 437 350</b>
<b>28.320</b>	10,5	235	D 2066 LF68 <Euro 6>; D 2066 LF81 <Euro 6>	10.12→	<b>0 445 020 277</b>	<b>0 986 437 383</b>



									
<b>28.320</b>		10,5	235/236	D 2066 LF20 <Euro 5/OBD1>; D 2066 LF28 <Euro 5/OBD1>; D 2066 LF39 <Euro 4/OBD1>; D 2066 LF43 <Euro 5/OBD2>; D 2066 LF60 <Euro 5/EEV/OBD2>	09.07→			<b>0 445 020 208</b>	<b>0 986 437 350</b>
<b>28.350 WW</b>		10,5	257	D 2066 LF03 <Euro 3>	04.10-12.13			<b>0 445 020 023</b>	<b>0 986 437 351</b>
<b>28.360</b>		10,5	265	D 2066 LF19 <Euro 5/OBD1>; D 2066 LF27 <Euro 5/OBD1>; D 2066 LF38 <Euro 4/OBD1>	09.07-06.16			<b>0 445 020 208</b>	<b>0 986 437 350</b>
				D 2066 LF67 <Euro 6>; D 2066 LF80 <Euro 6>	10.12→			<b>0 445 020 277</b>	<b>0 986 437 383</b>
				D 2066 LF85 <Euro 6/OBDC>	09.16→			<b>0 445 020 277</b>	<b>0 986 437 383</b>
, WW		10,5	265	D 2066 LF42 <Euro 5/OBD2>	09.09→			<b>0 445 020 208</b>	<b>0 986 437 350</b>
				D 2066 LF48 <Euro 3>; D 2066 LF59 <Euro 5/EEV/OBD2>; D 2066 LF64 <Euro 4/OBD2>	09.09→			<b>0 445 020 208</b>	<b>0 986 437 350</b>
<b>28.390 WW</b>		10,5	287	D 2066 LF02 <Euro 3>	04.10-12.13			<b>0 445 020 023</b>	<b>0 986 437 351</b>
<b>28.400</b>		10,5	294	D 2066 LF18 <Euro 5/OBD1>; D 2066 LF26 <Euro 5/OBD1>; D 2066 LF37 <Euro 4/OBD1>	09.07-06.16			<b>0 445 020 208</b>	<b>0 986 437 350</b>
				D 2066 LF61 <Euro 6>	10.12-06.16 TW			<b>0 445 020 208</b>	<b>0 986 437 350</b>
								<b>0 445 020 277</b>	<b>0 986 437 383</b>
, WW		12,4	294	D 2676 LF47 <Euro 6>	03.15→			<b>0 445 020 277</b>	<b>0 986 437 383</b>
		10,5	294	D 2066 LF41 <Euro 5/OBD2>	09.09→			<b>0 445 020 208</b>	<b>0 986 437 350</b>
				D 2066 LF49 <Euro 3>; D 2066 LF58 <Euro 5/EEV/OBD2>; D 2066 LF63 <Euro 4/OBD2>	09.09→			<b>0 445 020 208</b>	<b>0 986 437 350</b>
<b>28.420</b>		12,4	309	D 2676 LF53 <Euro 6/OBDC>	06.16→			<b>0 445 020 277</b>	<b>0 986 437 383</b>
<b>28.430 WW</b>		10,5	316	D 2066 LF01 <Euro 3>	04.10-12.13			<b>0 445 020 023</b>	<b>0 986 437 351</b>
<b>28.440</b>		12,4	324	D 2676 LF26 <Euro 6>; D 2676 LF46 <Euro 6>	10.12→			<b>0 445 020 277</b>	<b>0 986 437 383</b>
, WW		10,5	324	D 2066 LF17 <Euro 5/OBD1>; D 2066 LF25 <Euro 5/OBD1>; D 2066 LF36 <Euro 4/OBD1>; D 2066 LF40 <Euro 5/OBD2>; D 2066 LF50 <Euro 3>; D 2066 LF57 <Euro 5/EEV/OBD2>; D 2066 LF62 <Euro 4/OBD2>	09.07→			<b>0 445 020 208</b>	<b>0 986 437 350</b>
<b>28.460</b>		12,4	338	D 2676 LF52 <Euro 6/OBDC>	06.16→			<b>0 445 020 277</b>	<b>0 986 437 383</b>
<b>28.480</b>		12,4	353	D 2676 LF05 <Euro 4/OBD1>; D 2676 LF14 <Euro 5/OBD1>; D 2676 LF16 <Euro 5/OBD1>	09.07-06.16			<b>0 445 020 208</b>	<b>0 986 437 350</b>
				D 2676 LF25 <Euro 6>; D 2676 LF45 <Euro 6>	10.12→			<b>0 445 020 277</b>	<b>0 986 437 383</b>
, WW		12,4	353	D 2676 LF02 <Euro 3>; D 2676 LF18 <Euro 5/EEV/OBD2>; D 2676 LF20 <Euro 4/OBD2>	09.09→			<b>0 445 020 208</b>	<b>0 986 437 350</b>
				D 2676 LF07 <Euro 5/OBD2>	09.09→			<b>0 445 020 208</b>	<b>0 986 437 350</b>
<b>28.500</b>		12,4	368	D 2676 LF51 <Euro 6/OBDC>	06.16→			<b>0 445 020 277</b>	<b>0 986 437 383</b>
<b>28.540</b>		12,4	397	D 2676 LF06 <Euro 5/OBD2>; D 2676 LF13 <Euro 5/OBD1>; D 2676 LF15 <Euro 5/OBD1>	09.07→			<b>0 445 020 208</b>	<b>0 986 437 350</b>
<b>31.360 WW</b>		10,5	265	D 2066 LF48 <Euro 3>	05.12→			<b>0 445 020 208</b>	<b>0 986 437 350</b>
<b>32.320</b>		10,5	235	D 2066 LF20 <Euro 5/OBD1>; D 2066 LF28 <Euro 5/OBD1>; D 2066 LF39 <Euro 4/OBD1>; D 2066 LF43 <Euro 5/OBD2>; D 2066 LF60 <Euro 5/EEV/OBD2>	10.07→			<b>0 445 020 208</b>	<b>0 986 437 350</b>
				D 2066 LF53 <Euro 5/OBD2>; D 2066 LF68 <Euro 6>; D 2066 LF81 <Euro 6>; D 2066 LF86 <Euro 6/OBDC>	10.09→			<b>0 445 020 277</b>	<b>0 986 437 383</b>
<b>32.360</b>		10,5	265	D 2066 LF19 <Euro 5/OBD1>; D 2066 LF27 <Euro 5/OBD1>; D 2066 LF38 <Euro 4/OBD1>; D 2066 LF42 <Euro 5/OBD2>; D 2066 LF59 <Euro 5/EEV/OBD2>	10.07→			<b>0 445 020 208</b>	<b>0 986 437 350</b>
				D 2066 LF52 <Euro 5/OBD2>; D 2066 LF67 <Euro 6>; D 2066 LF80 <Euro 6>	10.09→			<b>0 445 020 277</b>	<b>0 986 437 383</b>
				D 2066 LF85 <Euro 6/OBDC>	09.16→			<b>0 445 020 277</b>	<b>0 986 437 383</b>
WW		10,5	265	D 2066 LF48 <Euro 3>	02.16→			<b>0 445 020 208</b>	<b>0 986 437 350</b>
<b>32.400</b>		10,5	294	D 2066 LF18 <Euro 5/OBD1>; D 2066 LF26 <Euro 5/OBD1>; D 2066 LF37 <Euro 4/OBD1>; D 2066 LF41 <Euro 5/OBD2>; D 2066 LF58 <Euro 5/EEV/OBD2>	10.07→			<b>0 445 020 208</b>	<b>0 986 437 350</b>
				D 2066 LF51 <Euro 5/OBD2>; D 2066 LF61 <Euro 6>	10.09→ TW			<b>0 445 020 208</b>	<b>0 986 437 350</b>
								<b>0 445 020 277</b>	<b>0 986 437 383</b>
		12,4	294	D 2676 LF47 <Euro 6>	03.15→			<b>0 445 020 277</b>	<b>0 986 437 383</b>
WW		10,5	294	D 2066 LF49 <Euro 3>	02.16→			<b>0 445 020 208</b>	<b>0 986 437 350</b>
<b>32.420</b>		12,4	309	D 2676 LF53 <Euro 6/OBDC>	06.16→			<b>0 445 020 277</b>	<b>0 986 437 383</b>





◀ MAN

<b>32.440</b>	10,5	324	D 2066 LF17 <Euro 5/OBD1>; D 2066 LF25 <Euro 5/OBD1>; D 2066 LF36 <Euro 4/OBD1>; D 2066 LF40 <Euro 5/OBD2>; D 2066 LF57 <Euro 5/EEV/OBD2>	10.07→		<b>0 445 020 208</b>	<b>0 986 437 350</b>
	12,4	324	D 2676 LF22 <Euro 5/OBD2>	10.09→	TW	<b>0 445 020 208</b>	<b>0 986 437 350</b>
			D 2676 LF26 <Euro 6>; D 2676 LF46 <Euro 6>	06.13→		<b>0 445 020 277</b>	<b>0 986 437 383</b>
<b>32.460</b>	12,4	338	D 2676 LF52 <Euro 6/OBDC>	06.16→		<b>0 445 020 277</b>	<b>0 986 437 383</b>
<b>32.480</b>	12,4	353	D 2676 LF05 <Euro 4/OBD1>; D 2676 LF07 <Euro 5/OBD2>; D 2676 LF14 <Euro 5/OBD1>; D 2676 LF16 <Euro 5/OBD1>; D 2676 LF18 <Euro 5/EEV/OBD2>	10.07→		<b>0 445 020 208</b>	<b>0 986 437 350</b>
			D 2676 LF25 <Euro 6>; D 2676 LF45 <Euro 6>	06.13→		<b>0 445 020 277</b>	<b>0 986 437 383</b>
<b>32.500</b>	12,4	368	D 2676 LF51 <Euro 6/OBDC>	06.16→		<b>0 445 020 277</b>	<b>0 986 437 383</b>
<b>33.320</b>	10,5	235	D 2066 LF20 <Euro 5/OBD1>; D 2066 LF28 <Euro 5/OBD1>; D 2066 LF39 <Euro 4/OBD1>; D 2066 LF43 <Euro 5/OBD2>; D 2066 LF60 <Euro 5/EEV/OBD2>	10.07→		<b>0 445 020 208</b>	<b>0 986 437 350</b>
			D 2066 LF68 <Euro 6>; D 2066 LF81 <Euro 6>; D 2066 LF86 <Euro 6/OBDC>	06.13→		<b>0 445 020 277</b>	<b>0 986 437 383</b>
<b>33.350 WW</b>	10,5	257	D 2066 LF03 <Euro 3>	01.10-09.16		<b>0 445 020 023</b>	<b>0 986 437 351</b>
<b>33.360</b>	10,5	265	D 2066 LF19 <Euro 5/OBD1>; D 2066 LF27 <Euro 5/OBD1>; D 2066 LF38 <Euro 4/OBD1>	10.07-06.16		<b>0 445 020 208</b>	<b>0 986 437 350</b>
			D 2066 LF59 <Euro 5/EEV/OBD2>	09.09→		<b>0 445 020 208</b>	<b>0 986 437 350</b>
			D 2066 LF67 <Euro 6>; D 2066 LF80 <Euro 6>	06.13→		<b>0 445 020 277</b>	<b>0 986 437 383</b>
			D 2066 LF85 <Euro 6/OBDC>	09.16→		<b>0 445 020 277</b>	<b>0 986 437 383</b>
, WW	10,5	265	D 2066 LF42 <Euro 5/OBD2>	09.09→		<b>0 445 020 208</b>	<b>0 986 437 350</b>
WW	10,5	265	D 2066 LF07 <Euro 2>	03.10→		<b>0 445 020 023</b>	<b>0 986 437 351</b>
			D 2066 LF48 <Euro 3>; D 2066 LF64 <Euro 4/OBD2>	02.11→		<b>0 445 020 208</b>	<b>0 986 437 350</b>
<b>33.390 WW</b>	10,5	287	D 2066 LF02 <Euro 3>	01.10-09.16		<b>0 445 020 023</b>	<b>0 986 437 351</b>
<b>33.400</b>	10,5	294	D 2066 LF18 <Euro 5/OBD1>; D 2066 LF26 <Euro 5/OBD1>; D 2066 LF37 <Euro 4/OBD1>	10.07-06.16		<b>0 445 020 208</b>	<b>0 986 437 350</b>
			D 2066 LF58 <Euro 5/EEV/OBD2>	09.09→		<b>0 445 020 208</b>	<b>0 986 437 350</b>
			D 2066 LF61 <Euro 6>	06.13-06.16	TW	<b>0 445 020 208</b>	<b>0 986 437 350</b>
						<b>0 445 020 277</b>	<b>0 986 437 383</b>
	12,4	294	D 2676 LF47 <Euro 6>	03.15→		<b>0 445 020 277</b>	<b>0 986 437 383</b>
, WW	10,5	294	D 2066 LF41 <Euro 5/OBD2>	09.09→		<b>0 445 020 208</b>	<b>0 986 437 350</b>
WW	10,5	294	D 2066 LF06 <Euro 2>	03.10→		<b>0 445 020 023</b>	<b>0 986 437 351</b>
			D 2066 LF49 <Euro 3>; D 2066 LF63 <Euro 4/OBD2>	02.11→		<b>0 445 020 208</b>	<b>0 986 437 350</b>
<b>33.420</b>	12,4	309	D 2676 LF53 <Euro 6/OBDC>	06.16→		<b>0 445 020 277</b>	<b>0 986 437 383</b>
<b>33.430 WW</b>	10,5	316	D 2066 LF01 <Euro 3>	01.10-09.16		<b>0 445 020 023</b>	<b>0 986 437 351</b>
<b>33.440</b>	12,4	324	D 2676 LF26 <Euro 6>; D 2676 LF46 <Euro 6>	06.13→		<b>0 445 020 277</b>	<b>0 986 437 383</b>
, WW	10,5	324	D 2066 LF17 <Euro 5/OBD1>; D 2066 LF25 <Euro 5/OBD1>; D 2066 LF36 <Euro 4/OBD1>; D 2066 LF40 <Euro 5/OBD2>; D 2066 LF50 <Euro 2>; D 2066 LF57 <Euro 5/EEV/OBD2>; D 2066 LF62 <Euro 4/OBD2>	10.07→		<b>0 445 020 208</b>	<b>0 986 437 350</b>
WW	12,4	324	D 2676 LF04 <Euro 2>	03.10→		<b>0 445 020 208</b>	<b>0 986 437 350</b>
<b>33.460</b>	12,4	338	D 2676 LF52 <Euro 6/OBDC>	06.16→		<b>0 445 020 277</b>	<b>0 986 437 383</b>
<b>33.480</b>	12,4	353	D 2676 LF25 <Euro 6>; D 2676 LF45 <Euro 6>	06.13→		<b>0 445 020 277</b>	<b>0 986 437 383</b>
, DF	12,4	353	D 2676 LF05 <Euro 4/OBD1>; D 2676 LF14 <Euro 5/OBD1>; D 2676 LF16 <Euro 5/OBD1>	10.07-06.16		<b>0 445 020 208</b>	<b>0 986 437 350</b>
, WW	12,4	353	D 2676 LF02 <Euro 3>; D 2676 LF03 <Euro 2>; D 2676 LF18 <Euro 5/EEV/OBD2>; D 2676 LF20 <Euro 4/OBD2>	09.09→		<b>0 445 020 208</b>	<b>0 986 437 350</b>
			D 2676 LF07 <Euro 5/OBD2>	09.09→		<b>0 445 020 208</b>	<b>0 986 437 350</b>
<b>33.500</b>	12,4	368	D 2676 LF51 <Euro 6/OBDC>	06.16→		<b>0 445 020 277</b>	<b>0 986 437 383</b>
<b>33.540</b>	12,4	397	D 2676 LF06 <Euro 5/OBD2>; D 2676 LF13 <Euro 5/OBD1>; D 2676 LF15 <Euro 5/OBD1>	10.07→		<b>0 445 020 208</b>	<b>0 986 437 350</b>
<b>35.320</b>	10,5	235	D 2066 LF20 <Euro 5/OBD1>; D 2066 LF28 <Euro 5/OBD1>; D 2066 LF39 <Euro 4/OBD1>; D 2066 LF43 <Euro 5/OBD2>; D 2066 LF60 <Euro 5/EEV/OBD2>	10.07→		<b>0 445 020 208</b>	<b>0 986 437 350</b>







35.320	10,5	235	D 2066 LF53 <Euro 5/OBD2>; D 2066 LF68 <Euro 6>; D 2066 LF81 <Euro 6>; D 2066 LF86 <Euro 6/OBDC>	10.09→		0 445 020 277	0 986 437 383
35.360	10,5	265	D 2066 LF19 <Euro 5/OBD1>; D 2066 LF27 <Euro 5/OBD1>; D 2066 LF38 <Euro 4/OBD1>; D 2066 LF42 <Euro 5/OBD2>; D 2066 LF59 <Euro 5/EEV/OBD2>	10.07→		0 445 020 208	0 986 437 350
			D 2066 LF52 <Euro 5/OBD2>	10.09→		0 445 020 277	0 986 437 383
			D 2066 LF67 <Euro 6>; D 2066 LF80 <Euro 6>; D 2066 LF85 <Euro 6/OBDC>	06.13→		0 445 020 277	0 986 437 383
WW	10,5	265	D 2066 LF64 <Euro 4/OBD2>	02.11-12.13		0 445 020 208	0 986 437 350
35.390 WW	10,5	287	D 2066 LF02 <Euro 3>	06.10-12.13		0 445 020 023	0 986 437 351
35.400	10,5	294	D 2066 LF18 <Euro 5/OBD1>; D 2066 LF26 <Euro 5/OBD1>; D 2066 LF37 <Euro 4/OBD1>; D 2066 LF41 <Euro 5/OBD2>; D 2066 LF58 <Euro 5/EEV/OBD2>	10.07→		0 445 020 208	0 986 437 350
			D 2066 LF51 <Euro 5/OBD2>	10.09→	TW	0 445 020 208	0 986 437 350
			D 2066 LF61 <Euro 6>	06.13-06.16	TW	0 445 020 208	0 986 437 350
						0 445 020 277	0 986 437 383
	12,4	294	D 2676 LF47 <Euro 6>	03.15→		0 445 020 277	0 986 437 383
WW	10,5	294	D 2066 LF49 <Euro 3>; D 2066 LF63 <Euro 4/OBD2>	02.11-12.13		0 445 020 208	0 986 437 350
35.420	12,4	309	D 2676 LF53 <Euro 6/OBDC>	06.16→		0 445 020 277	0 986 437 383
35.430 WW	10,5	316	D 2066 LF01 <Euro 3>	06.10-12.13		0 445 020 023	0 986 437 351
35.440	12,4	324	D 2676 LF22 <Euro 5/OBD2>	10.09→	TW	0 445 020 208	0 986 437 350
						0 445 020 277	0 986 437 383
			D 2676 LF26 <Euro 6>; D 2676 LF46 <Euro 6>	06.13→		0 445 020 277	0 986 437 383
, WW	10,5	324	D 2066 LF17 <Euro 5/OBD1>; D 2066 LF25 <Euro 5/OBD1>; D 2066 LF36 <Euro 4/OBD1>; D 2066 LF40 <Euro 5/OBD2>; D 2066 LF50 <Euro 3>; D 2066 LF57 <Euro 5/EEV/OBD2>; D 2066 LF62 <Euro 4/OBD2>	10.07→		0 445 020 208	0 986 437 350
35.460	12,4	338	D 2676 LF52 <Euro 6/OBDC>	06.16→		0 445 020 277	0 986 437 383
35.480	12,4	353	D 2676 LF25 <Euro 6>; D 2676 LF45 <Euro 6>	06.13→		0 445 020 277	0 986 437 383
, WW	12,4	353	D 2676 LF02 <Euro 3>; D 2676 LF05 <Euro 4/OBD1>; D 2676 LF07 <Euro 5/OBD2>; D 2676 LF14 <Euro 5/OBD1>; D 2676 LF16 <Euro 5/OBD1>; D 2676 LF18 <Euro 5/EEV/OBD2>; D 2676 LF20 <Euro 4/OBD2>	10.07→		0 445 020 208	0 986 437 350
35.500	12,4	368	D 2676 LF51 <Euro 6/OBDC>	06.16→		0 445 020 277	0 986 437 383
35.540	12,4	397	D 2676 LF06 <Euro 5/OBD2>; D 2676 LF13 <Euro 5/OBD1>; D 2676 LF15 <Euro 5/OBD1>	10.07→		0 445 020 208	0 986 437 350
37.320	10,5	235	D 2066 LF20 <Euro 5/OBD1>; D 2066 LF28 <Euro 5/OBD1>; D 2066 LF39 <Euro 4/OBD1>; D 2066 LF43 <Euro 5/OBD2>; D 2066 LF60 <Euro 5/EEV/OBD2>	10.07→		0 445 020 208	0 986 437 350
			D 2066 LF68 <Euro 6>; D 2066 LF81 <Euro 6>; D 2066 LF86 <Euro 6/OBDC>	06.13→		0 445 020 277	0 986 437 383
37.360	10,5	265	D 2066 LF19 <Euro 5/OBD1>; D 2066 LF27 <Euro 5/OBD1>; D 2066 LF38 <Euro 4/OBD1>; D 2066 LF42 <Euro 5/OBD2>; D 2066 LF59 <Euro 5/EEV/OBD2>	10.07→		0 445 020 208	0 986 437 350
			D 2066 LF67 <Euro 6>; D 2066 LF80 <Euro 6>; D 2066 LF85 <Euro 6/OBDC>	06.13→		0 445 020 277	0 986 437 383
37.400	10,5	294	D 2066 LF26 <Euro 5/OBD1>; D 2066 LF37 <Euro 4/OBD1>; D 2066 LF41 <Euro 5/OBD2>; D 2066 LF58 <Euro 5/EEV/OBD2>	10.07→		0 445 020 208	0 986 437 350
			D 2066 LF61 <Euro 6>	06.13-06.16	TW	0 445 020 208	0 986 437 350
						0 445 020 277	0 986 437 383
	12,4	294	D 2676 LF47 <Euro 6>	03.15→		0 445 020 277	0 986 437 383
37.420	12,4	309	D 2676 LF53 <Euro 6/OBDC>	06.16→		0 445 020 277	0 986 437 383















◀ MAN

<b>37.440</b>	10,5	324	D 2066 LF17 <Euro 5/OBD1>; D 2066 LF25 <Euro 5/OBD1>; D 2066 LF36 <Euro 4/OBD1>; D 2066 LF40 <Euro 5/OBD2>; D 2066 LF57 <Euro 5/EEV/OBD2>	10.07→	<b>0 445 020 208</b>	<b>0 986 437 350</b>
	12,4	324	D 2676 LF26 <Euro 6>; D 2676 LF46 <Euro 6>	06.13→	<b>0 445 020 277</b>	<b>0 986 437 383</b>
<b>37.460</b>	12,4	338	D 2676 LF52 <Euro 6/OBDC>	06.16→	<b>0 445 020 277</b>	<b>0 986 437 383</b>
<b>37.480</b>	12,4	353	D 2676 LF05 <Euro 4/OBD1>; D 2676 LF07 <Euro 5/OBD2>; D 2676 LF14 <Euro 5/OBD1>; D 2676 LF16 <Euro 5/OBD1>; D 2676 LF18 <Euro 5/EEV/OBD2>	10.07→	<b>0 445 020 208</b>	<b>0 986 437 350</b>
			D 2676 LF25 <Euro 6>; D 2676 LF45 <Euro 6>	06.13→	<b>0 445 020 277</b>	<b>0 986 437 383</b>
<b>37.500</b>	12,4	368	D 2676 LF51 <Euro 6/OBDC>	06.16→	<b>0 445 020 277</b>	<b>0 986 437 383</b>
<b>37.540</b>	12,4	397	D 2676 LF06 <Euro 5/OBD2>; D 2676 LF13 <Euro 5/OBD1>; D 2676 LF15 <Euro 5/OBD1>	10.07→	<b>0 445 020 208</b>	<b>0 986 437 350</b>
<b>40.360 WW</b>	10,5	265	D 2066 LF07 <Euro 2>	09.11→	<b>0 445 020 023</b>	<b>0 986 437 351</b>
			D 2066 LF42 <Euro 5/OBD2>; D 2066 LF48 <Euro 3>; D 2066 LF64 <Euro 4/OBD2>	09.11→	<b>0 445 020 208</b>	<b>0 986 437 350</b>
<b>40.390 WW</b>	10,5	287	D 2066 LF02 <Euro 3>	03.10-09.16	<b>0 445 020 023</b>	<b>0 986 437 351</b>
<b>40.400 WW</b>	10,5	294	D 2066 LF06 <Euro 2>	03.10→	<b>0 445 020 023</b>	<b>0 986 437 351</b>
			D 2066 LF41 <Euro 5/OBD2>; D 2066 LF49 <Euro 3>; D 2066 LF63 <Euro 4/OBD2>	02.11→	<b>0 445 020 208</b>	<b>0 986 437 350</b>
<b>40.430 WW</b>	10,5	316	D 2066 LF01 <Euro 3>	03.10-09.16	<b>0 445 020 023</b>	<b>0 986 437 351</b>
<b>40.440 WW</b>	10,5	324	D 2066 LF40 <Euro 5/OBD2>; D 2066 LF50 <Euro 3>; D 2066 LF62 <Euro 4/OBD2>	02.11→	<b>0 445 020 208</b>	<b>0 986 437 350</b>
	12,4	324	D 2676 LF04 <Euro 2>	03.10→	<b>0 445 020 208</b>	<b>0 986 437 350</b>
<b>40.480 WW</b>	12,4	353	D 2676 LF02 <Euro 3>; D 2676 LF03 <Euro 2>; D 2676 LF07 <Euro 5/OBD2>; D 2676 LF20 <Euro 4/OBD2>	03.10→	<b>0 445 020 208</b>	<b>0 986 437 350</b>
<b>40.540 WW</b>	12,4	397	D 2676 LF06 <Euro 5/OBD2>; D 2676 LF19 <Euro 4/OBD2>	03.15→	<b>0 445 020 208</b>	<b>0 986 437 350</b>
<b>41.320</b>	10,5	235	D 2066 LF20 <Euro 5/OBD1>; D 2066 LF28 <Euro 5/OBD1>; D 2066 LF39 <Euro 4/OBD1>; D 2066 LF43 <Euro 5/OBD2>; D 2066 LF60 <Euro 5/EEV/OBD2>	10.07→	<b>0 445 020 208</b>	<b>0 986 437 350</b>
			D 2066 LF68 <Euro 6>; D 2066 LF81 <Euro 6>; D 2066 LF86 <Euro 6/OBDC>	06.13→	<b>0 445 020 277</b>	<b>0 986 437 383</b>
<b>41.350 WW</b>	10,5	257	D 2066 LF03 <Euro 3>	01.10-12.13	<b>0 445 020 023</b>	<b>0 986 437 351</b>
<b>41.360</b>	10,5	265	D 2066 LF19 <Euro 5/OBD1>; D 2066 LF27 <Euro 5/OBD1>; D 2066 LF38 <Euro 4/OBD1>	10.07-06.16	<b>0 445 020 208</b>	<b>0 986 437 350</b>
			D 2066 LF59 <Euro 5/EEV/OBD2>	09.09→	<b>0 445 020 208</b>	<b>0 986 437 350</b>
			D 2066 LF67 <Euro 6>; D 2066 LF80 <Euro 6>	06.13→	<b>0 445 020 277</b>	<b>0 986 437 383</b>
			D 2066 LF85 <Euro 6/OBDC>	09.16→	<b>0 445 020 277</b>	<b>0 986 437 383</b>
, WW	10,5	265	D 2066 LF42 <Euro 5/OBD2>	09.09→	<b>0 445 020 208</b>	<b>0 986 437 350</b>
WW	10,5	265	D 2066 LF07 <Euro 2>	01.10→	<b>0 445 020 023</b>	<b>0 986 437 351</b>
			D 2066 LF48 <Euro 3>; D 2066 LF64 <Euro 4/OBD2>	02.11→	<b>0 445 020 208</b>	<b>0 986 437 350</b>
<b>41.390 WW</b>	10,5	287	D 2066 LF02 <Euro 3>	01.10-12.13	<b>0 445 020 023</b>	<b>0 986 437 351</b>
<b>41.400</b>	10,5	294	D 2066 LF18 <Euro 5/OBD1>; D 2066 LF26 <Euro 5/OBD1>; D 2066 LF37 <Euro 4/OBD1>	10.07-06.16	<b>0 445 020 208</b>	<b>0 986 437 350</b>
			D 2066 LF58 <Euro 5/EEV/OBD2>	09.09→	<b>0 445 020 208</b>	<b>0 986 437 350</b>
			D 2066 LF61 <Euro 6>	06.13-06.16 TW	<b>0 445 020 208</b>	<b>0 986 437 350</b>
					<b>0 445 020 277</b>	<b>0 986 437 383</b>
	12,4	294	D 2676 LF47 <Euro 6>	03.15→	<b>0 445 020 277</b>	<b>0 986 437 383</b>
, WW	10,5	294	D 2066 LF41 <Euro 5/OBD2>	09.09→	<b>0 445 020 208</b>	<b>0 986 437 350</b>
WW	10,5	294	D 2066 LF06 <Euro 2>	01.10→	<b>0 445 020 023</b>	<b>0 986 437 351</b>
			D 2066 LF49 <Euro 3>; D 2066 LF63 <Euro 4/OBD2>	02.11→	<b>0 445 020 208</b>	<b>0 986 437 350</b>
<b>41.420</b>	12,4	309	D 2676 LF53 <Euro 6/OBDC>	06.16→	<b>0 445 020 277</b>	<b>0 986 437 383</b>
<b>41.430 WW</b>	10,5	316	D 2066 LF01 <Euro 3>	01.10-12.13	<b>0 445 020 023</b>	<b>0 986 437 351</b>
<b>41.440</b>	12,4	324	D 2676 LF26 <Euro 6>; D 2676 LF46 <Euro 6>	06.13→	<b>0 445 020 277</b>	<b>0 986 437 383</b>
, WW	10,5	324	D 2066 LF17 <Euro 5/OBD1>; D 2066 LF25 <Euro 5/OBD1>; D 2066 LF36 <Euro 4/OBD1>; D 2066 LF40 <Euro 5/OBD2>; D 2066 LF50 <Euro 3>; D 2066 LF57 <Euro 5/EEV/OBD2>; D 2066 LF62 <Euro 4/OBD2>	10.07→	<b>0 445 020 208</b>	<b>0 986 437 350</b>



									
41.440 WW	12,4	324	D 2676 LF04 <Euro 2>		01.10→			0 445 020 208	0 986 437 350
41.460	12,4	338	D 2676 LF52 <Euro 6/OBDC>		06.16→			0 445 020 277	0 986 437 383
41.480	12,4	353	D 2676 LF05 <Euro 4/OBD1>; D 2676 LF14 <Euro 5/OBD1>; D 2676 LF16 <Euro 5/OBD1>		10.07-06.16			0 445 020 208	0 986 437 350
			D 2676 LF25 <Euro 6>; D 2676 LF45 <Euro 6>		06.13→			0 445 020 277	0 986 437 383
, WW	12,4	353	D 2676 LF02 <Euro 3>; D 2676 LF03 <Euro 2>; D 2676 LF18 <Euro 5/EEV/OBD2>; D 2676 LF20 <Euro 4/OBD2>		09.09→			0 445 020 208	0 986 437 350
			D 2676 LF07 <Euro 5/OBD2>		09.09→			0 445 020 208	0 986 437 350
41.500	12,4	368	D 2676 LF51 <Euro 6/OBDC>		06.16→			0 445 020 277	0 986 437 383
41.540	12,4	397	D 2676 LF06 <Euro 5/OBD2>; D 2676 LF13 <Euro 5/OBD1>; D 2676 LF15 <Euro 5/OBD1>		10.07→			0 445 020 208	0 986 437 350
<b>TGX</b>									
18.360	10,5	265	D 2066 LF19 <Euro 5/OBD1>; D 2066 LF27 <Euro 5/OBD1>; D 2066 LF38 <Euro 4/OBD1>; D 2066 LF42 <Euro 5/OBD2>; D 2066 LF59 <Euro 5/EEV/OBD2>		10.07→			0 445 020 208	0 986 437 350
			D 2066 LF67 <Euro 6>; D 2066 LF80 <Euro 6>; D 2066 LF85 <Euro 6/OBDC>		10.12→			0 445 020 277	0 986 437 383
18.400	10,5	294	D 2066 LF18 <Euro 5/OBD1>; D 2066 LF26 <Euro 5/OBD1>; D 2066 LF37 <Euro 4/OBD1>; D 2066 LF41 <Euro 5/OBD2>; D 2066 LF58 <Euro 5/EEV/OBD2>		10.07→			0 445 020 208	0 986 437 350
			D 2066 LF51 <Euro 5/OBD2>; D 2066 LF61 <Euro 6>		10.09-06.16 TW			0 445 020 208	0 986 437 350
								0 445 020 277	0 986 437 383
	12,4	294	D 2676 LF47 <Euro 6>		03.15→			0 445 020 277	0 986 437 383
18.420	12,4	309	D 2676 LF53 <Euro 6/OBDC>		06.16→			0 445 020 277	0 986 437 383
18.440	10,5	324	D 2066 LF17 <Euro 5/OBD1>; D 2066 LF25 <Euro 5/OBD1>; D 2066 LF36 <Euro 4/OBD1>; D 2066 LF40 <Euro 5/OBD2>; D 2066 LF57 <Euro 5/EEV/OBD2>		10.07→			0 445 020 208	0 986 437 350
	12,4	324	D 2676 LF22 <Euro 5/OBD2>		10.09-06.16 TW			0 445 020 208	0 986 437 350
			D 2676 LF26 <Euro 6>; D 2676 LF46 <Euro 6>		10.12→			0 445 020 277	0 986 437 383
18.460	12,4	338	D 2676 LF52 <Euro 6/OBDC>		06.16→			0 445 020 277	0 986 437 383
18.480	12,4	353	D 2676 LF25 <Euro 6>; D 2676 LF45 <Euro 6>		10.12→			0 445 020 277	0 986 437 383
, F, FL	12,4	353	D 2676 LF05 <Euro 4/OBD1>; D 2676 LF07 <Euro 5/OBD2>; D 2676 LF14 <Euro 5/OBD1>; D 2676 LF16 <Euro 5/OBD1>; D 2676 LF18 <Euro 5/EEV/OBD2>		10.07→			0 445 020 208	0 986 437 350
18.500	12,4	368	D 2676 LF51 <Euro 6/OBDC>		06.16→			0 445 020 277	0 986 437 383
18.520	15,2	383	D 3876 LF02 <Euro 6>		10.14-02.17			0 445 020 264	
					03.17→			0 445 020 303	
18.540	12,4	397	D 2676 LF06 <Euro 5/OBD2>; D 2676 LF13 <Euro 5/OBD1>; D 2676 LF15 <Euro 5/OBD1>		10.07→			0 445 020 208	0 986 437 350
	15,2	397	D 3876 LF08 <Euro 6/OBDC>		09.16-02.17			0 445 020 264	
					03.17→			0 445 020 303	
18.560	15,2	412	D 3876 LF01 <Euro 6>		10.14-02.17			0 445 020 264	
					03.17→			0 445 020 303	
18.580	15,2	427	D 3876 LF07 <Euro 6/OBDC>		09.16-02.17			0 445 020 264	
					03.17→			0 445 020 303	
18.640	15,2	471	D 3876 LF09 <Euro 6/OBDC>		04.17→			0 445 020 303	
18.680	16,2	500	D 2868 LF02 <Euro 5/OBD1>; D 2868 LF05 <Euro 5/EEV/OBD2>		01.08-05.14			0 445 020 082	
20.360	10,5	265	D 2066 LF42 <Euro 5/OBD2>; D 2066 LF59 <Euro 5/EEV/OBD2>		07.17→			0 445 020 208	0 986 437 350
20.400	10,5	294	D 2066 LF41 <Euro 5/OBD2>; D 2066 LF58 <Euro 5/EEV/OBD2>		07.17→			0 445 020 208	0 986 437 350
20.440	10,5	324	D 2066 LF40 <Euro 5/OBD2>; D 2066 LF57 <Euro 5/EEV/OBD2>		07.17→			0 445 020 208	0 986 437 350
20.480	12,4	353	D 2676 LF07 <Euro 5/OBD2>; D 2676 LF18 <Euro 5/EEV/OBD2>		07.17→			0 445 020 208	0 986 437 350
20.540	12,4	397	D 2676 LF06 <Euro 5/OBD2>		07.17→			0 445 020 208	0 986 437 350













◀ MAN

<b>24.360</b>	10,5	265	D 2066 LF19 <Euro 5/OBD1>; D 2066 LF27 <Euro 5/OBD1>; D 2066 LF38 <Euro 4/OBD1>; D 2066 LF42 <Euro 5/OBD2>; D 2066 LF59 <Euro 5/EEV/OBD2>	10.07→	<b>0 445 020 208</b>	<b>0 986 437 350</b>
			D 2066 LF67 <Euro 6>; D 2066 LF80 <Euro 6>; D 2066 LF85 <Euro 6/OBDC>	10.12→	<b>0 445 020 277</b>	<b>0 986 437 383</b>
<b>24.400</b>	10,5	294	D 2066 LF18 <Euro 5/OBD1>; D 2066 LF26 <Euro 5/OBD1>; D 2066 LF37 <Euro 4/OBD1>; D 2066 LF41 <Euro 5/OBD2>; D 2066 LF58 <Euro 5/EEV/OBD2>	10.07→	<b>0 445 020 208</b>	<b>0 986 437 350</b>
			D 2066 LF51 <Euro 5/OBD2>; D 2066 LF61 <Euro 6>	10.09-06.16 TW	<b>0 445 020 208</b>	<b>0 986 437 350</b>
	12,4	294	D 2676 LF47 <Euro 6>	03.15→	<b>0 445 020 277</b>	<b>0 986 437 383</b>
<b>24.420</b>	12,4	309	D 2676 LF53 <Euro 6/OBDC>	06.16→	<b>0 445 020 277</b>	<b>0 986 437 383</b>
<b>24.440</b>	10,5	324	D 2066 LF17 <Euro 5/OBD1>; D 2066 LF25 <Euro 5/OBD1>; D 2066 LF36 <Euro 4/OBD1>; D 2066 LF40 <Euro 5/OBD2>; D 2066 LF57 <Euro 5/EEV/OBD2>	10.07→	<b>0 445 020 208</b>	<b>0 986 437 350</b>
	12,4	324	D 2676 LF22 <Euro 5/OBD2>	10.09-06.16 TW	<b>0 445 020 208</b>	<b>0 986 437 350</b>
			D 2676 LF26 <Euro 6>; D 2676 LF46 <Euro 6>	10.12→	<b>0 445 020 277</b>	<b>0 986 437 383</b>
<b>24.460</b>	12,4	338	D 2676 LF52 <Euro 6/OBDC>	06.16→	<b>0 445 020 277</b>	<b>0 986 437 383</b>
<b>24.480</b>	12,4	353	D 2676 LF05 <Euro 4/OBD1>; D 2676 LF07 <Euro 5/OBD2>; D 2676 LF14 <Euro 5/OBD1>; D 2676 LF16 <Euro 5/OBD1>; D 2676 LF18 <Euro 5/EEV/OBD2>	10.07→	<b>0 445 020 208</b>	<b>0 986 437 350</b>
			D 2676 LF25 <Euro 6>; D 2676 LF45 <Euro 6>	10.12→	<b>0 445 020 277</b>	<b>0 986 437 383</b>
<b>24.500</b>	12,4	368	D 2676 LF51 <Euro 6/OBDC>	06.16→	<b>0 445 020 277</b>	<b>0 986 437 383</b>
<b>24.540</b>	12,4	397	D 2676 LF06 <Euro 5/OBD2>	09.09→	<b>0 445 020 208</b>	<b>0 986 437 350</b>
<b>26.360</b>	10,5	265	D 2066 LF19 <Euro 5/OBD1>; D 2066 LF27 <Euro 5/OBD1>; D 2066 LF38 <Euro 4/OBD1>; D 2066 LF42 <Euro 5/OBD2>; D 2066 LF59 <Euro 5/EEV/OBD2>	10.07→	<b>0 445 020 208</b>	<b>0 986 437 350</b>
			D 2066 LF67 <Euro 6>; D 2066 LF80 <Euro 6>; D 2066 LF85 <Euro 6/OBDC>	10.12→	<b>0 445 020 277</b>	<b>0 986 437 383</b>
<b>26.400</b>	10,5	294	D 2066 LF18 <Euro 5/OBD1>; D 2066 LF26 <Euro 5/OBD1>; D 2066 LF37 <Euro 4/OBD1>; D 2066 LF41 <Euro 5/OBD2>; D 2066 LF58 <Euro 5/EEV/OBD2>	10.07→	<b>0 445 020 208</b>	<b>0 986 437 350</b>
			D 2066 LF51 <Euro 5/OBD2>; D 2066 LF61 <Euro 6>	10.09-06.16 TW	<b>0 445 020 208</b>	<b>0 986 437 350</b>
	12,4	294	D 2676 LF47 <Euro 6>	03.15→	<b>0 445 020 277</b>	<b>0 986 437 383</b>
<b>26.420</b>	12,4	309	D 2676 LF53 <Euro 6/OBDC>	06.16→	<b>0 445 020 277</b>	<b>0 986 437 383</b>
<b>26.440</b>	10,5	324	D 2066 LF17 <Euro 5/OBD1>; D 2066 LF25 <Euro 5/OBD1>; D 2066 LF36 <Euro 4/OBD1>; D 2066 LF40 <Euro 5/OBD2>; D 2066 LF57 <Euro 5/EEV/OBD2>	10.07→	<b>0 445 020 208</b>	<b>0 986 437 350</b>
	12,4	324	D 2676 LF22 <Euro 5/OBD2>	10.09-06.16 TW	<b>0 445 020 208</b>	<b>0 986 437 350</b>
			D 2676 LF26 <Euro 6>; D 2676 LF46 <Euro 6>	10.12→	<b>0 445 020 277</b>	<b>0 986 437 383</b>
<b>26.460</b>	12,4	338	D 2676 LF52 <Euro 6/OBDC>	06.16→	<b>0 445 020 277</b>	<b>0 986 437 383</b>
<b>26.480</b>	12,4	353	D 2676 LF05 <Euro 4/OBD1>; D 2676 LF07 <Euro 5/OBD2>; D 2676 LF14 <Euro 5/OBD1>; D 2676 LF16 <Euro 5/OBD1>; D 2676 LF18 <Euro 5/EEV/OBD2>	10.07→	<b>0 445 020 208</b>	<b>0 986 437 350</b>
			D 2676 LF45 <Euro 6>	03.15→	<b>0 445 020 277</b>	<b>0 986 437 383</b>
<b>26.500</b>	12,4	368	D 2676 LF51 <Euro 6/OBDC>	06.16→	<b>0 445 020 277</b>	<b>0 986 437 383</b>
<b>26.520</b>	15,2	383	D 3876 LF02 <Euro 6>	10.14-02.17	<b>0 445 020 264</b>	
				03.17→	<b>0 445 020 303</b>	
<b>26.540</b>	12,4	397	D 2676 LF06 <Euro 5/OBD2>; D 2676 LF13 <Euro 5/OBD1>; D 2676 LF15 <Euro 5/OBD1>	10.07→	<b>0 445 020 208</b>	<b>0 986 437 350</b>
	15,2	397	D 3876 LF08 <Euro 6/OBDC>	09.16-02.17	<b>0 445 020 264</b>	
				03.17→	<b>0 445 020 303</b>	



									
26.560		15,2	412	D 3876 LF01 <Euro 6>			10.14-02.17		<b>0 445 020 264</b>
							03.17→		<b>0 445 020 303</b>
26.580		15,2	427	D 3876 LF07 <Euro 6/OBDC>			09.16-02.17		<b>0 445 020 264</b>
							03.17→		<b>0 445 020 303</b>
26.640		15,2	471	D 3876 LF09 <Euro 6/OBDC>			04.17→		<b>0 445 020 303</b>
28.360		10,5	265	D 2066 LF19 <Euro 5/OBD1>; D 2066 LF27 <Euro 5/OBD1>; D 2066 LF38 <Euro 4/OBD1>; D 2066 LF42 <Euro 5/OBD2>; D 2066 LF59 <Euro 5/EEV/OBD2> D 2066 LF67 <Euro 6>; D 2066 LF80 <Euro 6>; D 2066 LF85 <Euro 6/OBDC>			10.07→		<b>0 445 020 208 0 986 437 350</b>
							10.12→		<b>0 445 020 277 0 986 437 383</b>
28.400		10,5	294	D 2066 LF18 <Euro 5/OBD1>; D 2066 LF26 <Euro 5/OBD1>; D 2066 LF37 <Euro 4/OBD1>; D 2066 LF41 <Euro 5/OBD2>; D 2066 LF58 <Euro 5/EEV/OBD2> D 2066 LF61 <Euro 6>			10.07→		<b>0 445 020 208 0 986 437 350</b>
							10.12-06.16 TW		<b>0 445 020 208 0 986 437 350</b>
									<b>0 445 020 277 0 986 437 383</b>
		12,4	294	D 2676 LF47 <Euro 6>			03.15→		<b>0 445 020 277 0 986 437 383</b>
28.420		12,4	309	D 2676 LF53 <Euro 6/OBDC>			06.16→		<b>0 445 020 277 0 986 437 383</b>
28.440		10,5	324	D 2066 LF17 <Euro 5/OBD1>; D 2066 LF25 <Euro 5/OBD1>; D 2066 LF36 <Euro 4/OBD1>; D 2066 LF40 <Euro 5/OBD2>; D 2066 LF57 <Euro 5/EEV/OBD2>			10.07→		<b>0 445 020 208 0 986 437 350</b>
							10.12→		<b>0 445 020 277 0 986 437 383</b>
28.460		12,4	324	D 2676 LF26 <Euro 6>; D 2676 LF46 <Euro 6>			06.16→		<b>0 445 020 277 0 986 437 383</b>
28.480		12,4	353	D 2676 LF05 <Euro 4/OBD1>; D 2676 LF07 <Euro 5/OBD2>; D 2676 LF14 <Euro 5/OBD1>; D 2676 LF18 <Euro 5/EEV/OBD2> D 2676 LF25 <Euro 6>; D 2676 LF45 <Euro 6>			10.07→		<b>0 445 020 208 0 986 437 350</b>
							10.12→		<b>0 445 020 277 0 986 437 383</b>
28.500		12,4	368	D 2676 LF51 <Euro 6/OBDC>			06.16→		<b>0 445 020 277 0 986 437 383</b>
28.520		15,2	383	D 3876 LF02 <Euro 6>			10.14-02.17		<b>0 445 020 264</b>
							03.17→		<b>0 445 020 303</b>
28.540		12,4	397	D 2676 LF06 <Euro 5/OBD2>; D 2676 LF13 <Euro 5/OBD1>; D 2676 LF15 <Euro 5/OBD1>			10.07→		<b>0 445 020 208 0 986 437 350</b>
							09.16-02.17		<b>0 445 020 264</b>
							03.17→		<b>0 445 020 303</b>
28.560		15,2	412	D 3876 LF01 <Euro 6>			10.14-02.17		<b>0 445 020 264</b>
							03.17→		<b>0 445 020 303</b>
28.580		15,2	427	D 3876 LF07 <Euro 6/OBDC>			09.16-02.17		<b>0 445 020 264</b>
							03.17→		<b>0 445 020 303</b>
28.640		15,2	471	D 3876 LF09 <Euro 6/OBDC>			06.17→		<b>0 445 020 303</b>
33.360		10,5	265	D 2066 LF19 <Euro 5/OBD1>; D 2066 LF27 <Euro 5/OBD1>; D 2066 LF38 <Euro 4/OBD1>; D 2066 LF42 <Euro 5/OBD2>; D 2066 LF59 <Euro 5/EEV/OBD2> D 2066 LF67 <Euro 6>; D 2066 LF80 <Euro 6>; D 2066 LF85 <Euro 6/OBDC>			10.07→		<b>0 445 020 208 0 986 437 350</b>
							06.13→		<b>0 445 020 277 0 986 437 383</b>
33.400		10,5	294	D 2066 LF18 <Euro 5/OBD1>; D 2066 LF26 <Euro 5/OBD1>; D 2066 LF37 <Euro 4/OBD1>; D 2066 LF41 <Euro 5/OBD2>; D 2066 LF58 <Euro 5/EEV/OBD2> D 2066 LF61 <Euro 6>			10.07→		<b>0 445 020 208 0 986 437 350</b>
							06.13-06.16 TW		<b>0 445 020 208 0 986 437 350</b>
									<b>0 445 020 277 0 986 437 383</b>
		12,4	294	D 2676 LF47 <Euro 6>			03.15→		<b>0 445 020 277 0 986 437 383</b>
33.420		12,4	309	D 2676 LF53 <Euro 6/OBDC>			09.16→		<b>0 445 020 277 0 986 437 383</b>
33.440		10,5	324	D 2066 LF17 <Euro 5/OBD1>; D 2066 LF25 <Euro 5/OBD1>; D 2066 LF36 <Euro 4/OBD1>; D 2066 LF40 <Euro 5/OBD2>; D 2066 LF57 <Euro 5/EEV/OBD2>			10.07→		<b>0 445 020 208 0 986 437 350</b>
							06.13→		<b>0 445 020 277 0 986 437 383</b>
33.460		12,4	324	D 2676 LF26 <Euro 6>; D 2676 LF46 <Euro 6>			06.13→		<b>0 445 020 277 0 986 437 383</b>
33.480		12,4	338	D 2676 LF52 <Euro 6/OBDC>			09.16→		<b>0 445 020 277 0 986 437 383</b>
33.480		12,4	353	D 2676 LF25 <Euro 6>; D 2676 LF45 <Euro 6>			06.13→		<b>0 445 020 277 0 986 437 383</b>





◀ MAN

<b>33.480</b> , DF	12,4	353	D 2676 LF05 <Euro 4/OBD1>; D 2676 LF07 <Euro 5/OBD2>; D 2676 LF14 <Euro 5/OBD1>; D 2676 LF16 <Euro 5/OBD1>; D 2676 LF18 <Euro 5/EEV/OBD2>	10.07→	<b>0 445 020 208</b>	<b>0 986 437 350</b>
<b>33.500</b>	12,4	368	D 2676 LF51 <Euro 6/OBDC>	09.16→	<b>0 445 020 277</b>	<b>0 986 437 383</b>
<b>33.520</b>	15,2	383	D 3876 LF02 <Euro 6>	10.14-02.17 03.17→	<b>0 445 020 264</b> <b>0 445 020 303</b>	
<b>33.540</b>	12,4	397	D 2676 LF06 <Euro 5/OBD2>; D 2676 LF13 <Euro 5/OBD1>; D 2676 LF15 <Euro 5/OBD1>	10.07→	<b>0 445 020 208</b>	<b>0 986 437 350</b>
	15,2	397	D 3876 LF08 <Euro 6/OBDC>	09.16-02.17 03.17→	<b>0 445 020 264</b> <b>0 445 020 303</b>	
<b>33.560</b>	15,2	412	D 3876 LF01 <Euro 6>	10.14-02.17 03.17→	<b>0 445 020 264</b> <b>0 445 020 303</b>	
<b>33.580</b>	15,2	427	D 3876 LF07 <Euro 6/OBDC>	09.16-02.17 03.17→	<b>0 445 020 264</b> <b>0 445 020 303</b>	
<b>33.640</b>	15,2	471	D 3876 LF09 <Euro 6/OBDC>	04.17→	<b>0 445 020 303</b>	
<b>33.680</b>	16,2	500	D 2868 LF02 <Euro 5/OBD1>; D 2868 LF05 <Euro 5/EEV/OBD2>	01.08-05.14	<b>0 445 020 082</b>	
<b>35.360</b>	10,5	265	D 2066 LF19 <Euro 5/OBD1>; D 2066 LF27 <Euro 5/OBD1>; D 2066 LF38 <Euro 4/OBD1>; D 2066 LF42 <Euro 5/OBD2>; D 2066 LF59 <Euro 5/EEV/OBD2>	09.07→	<b>0 445 020 208</b>	<b>0 986 437 350</b>
			D 2066 LF67 <Euro 6>; D 2066 LF80 <Euro 6>; D 2066 LF85 <Euro 6/OBDC>	12.13→	<b>0 445 020 277</b>	<b>0 986 437 383</b>
<b>35.400</b>	10,5	294	D 2066 LF18 <Euro 5/OBD1>; D 2066 LF26 <Euro 5/OBD1>; D 2066 LF37 <Euro 4/OBD1>; D 2066 LF41 <Euro 5/OBD2>; D 2066 LF58 <Euro 5/EEV/OBD2>	09.07→	<b>0 445 020 208</b>	<b>0 986 437 350</b>
			D 2066 LF61 <Euro 6>	12.13-06.16 TW	<b>0 445 020 208</b>	<b>0 986 437 350</b>
	12,4	294	D 2676 LF47 <Euro 6>	03.15→	<b>0 445 020 277</b>	<b>0 986 437 383</b>
<b>35.420</b>	12,4	309	D 2676 LF53 <Euro 6/OBDC>	09.16→	<b>0 445 020 277</b>	<b>0 986 437 383</b>
<b>35.440</b>	10,5	324	D 2066 LF17 <Euro 5/OBD1>; D 2066 LF25 <Euro 5/OBD1>; D 2066 LF36 <Euro 4/OBD1>; D 2066 LF40 <Euro 5/OBD2>; D 2066 LF57 <Euro 5/EEV/OBD2>	09.07→	<b>0 445 020 208</b>	<b>0 986 437 350</b>
	12,4	324	D 2676 LF26 <Euro 6>; D 2676 LF46 <Euro 6>	12.13→	<b>0 445 020 277</b>	<b>0 986 437 383</b>
<b>35.460</b>	12,4	338	D 2676 LF52 <Euro 6/OBDC>	09.16→	<b>0 445 020 277</b>	<b>0 986 437 383</b>
<b>35.480</b>	12,4	353	D 2676 LF05 <Euro 4/OBD1>; D 2676 LF07 <Euro 5/OBD2>; D 2676 LF14 <Euro 5/OBD1>; D 2676 LF16 <Euro 5/OBD1>; D 2676 LF18 <Euro 5/EEV/OBD2>	09.07→	<b>0 445 020 208</b>	<b>0 986 437 350</b>
			D 2676 LF25 <Euro 6>; D 2676 LF45 <Euro 6>	12.13→	<b>0 445 020 277</b>	<b>0 986 437 383</b>
<b>35.500</b>	12,4	368	D 2676 LF51 <Euro 6/OBDC>	09.16→	<b>0 445 020 277</b>	<b>0 986 437 383</b>
<b>35.520</b>	15,2	383	D 3876 LF02 <Euro 6>	10.14-02.17 03.17→	<b>0 445 020 264</b> <b>0 445 020 303</b>	
<b>35.540</b>	12,4	397	D 2676 LF06 <Euro 5/OBD2>; D 2676 LF13 <Euro 5/OBD1>; D 2676 LF15 <Euro 5/OBD1>	09.07→	<b>0 445 020 208</b>	<b>0 986 437 350</b>
	15,2	397	D 3876 LF08 <Euro 6/OBDC>	09.16-02.17 03.17→	<b>0 445 020 264</b> <b>0 445 020 303</b>	
<b>35.560</b>	15,2	412	D 3876 LF01 <Euro 6>	10.14-02.17 03.17→	<b>0 445 020 264</b> <b>0 445 020 303</b>	
<b>35.580</b>	15,2	427	D 3876 LF07 <Euro 6/OBDC>	09.16-02.17 03.17→	<b>0 445 020 264</b> <b>0 445 020 303</b>	
<b>35.640</b>	15,2	471	D 3876 LF09 <Euro 6/OBDC>	04.17→	<b>0 445 020 303</b>	
<b>41.540</b>	12,4	397	D 2676 LF06 <Euro 5/OBD2>; D 2676 LF13 <Euro 5/OBD1>; D 2676 LF15 <Euro 5/OBD1>	10.07→	<b>0 445 020 208</b>	<b>0 986 437 350</b>
<b>41.560</b>	15,2	412	D 3876 LF01 <Euro 6>	10.14-02.17 03.17→	<b>0 445 020 264</b> <b>0 445 020 303</b>	
<b>41.580</b>	15,2	427	D 3876 LF07 <Euro 6/OBDC>	09.16-02.17 03.17→	<b>0 445 020 264</b> <b>0 445 020 303</b>	
<b>41.640</b>	15,2	471	D 3876 LF03 <Euro 6>	10.15-02.17 03.17→	<b>0 445 020 264</b> <b>0 445 020 303</b>	





<b>41.640</b>	15,2	471	D 3876 LF09 <Euro 6/OBDC>	09.16-02.17 03.17→	<b>0 445 020 264</b> <b>0 445 020 303</b>
<b>41.680</b>	16,2	500	D 2868 LF03 <Euro 5/OBD1>; D 2868 LF06 <Euro 5/OBD2>	01.08→	<b>0 445 020 082</b>
<b>TRX</b>					
<b>26.480</b>	12,4	353	D 2676 LF25 <Euro 6>	10.12-06.16	<b>0 445 020 277</b> <b>0 986 437 383</b>

**MAZ MINSK**

<b>Serie 100</b>					
<b>103</b>	7,1	161,5/ 169	D 260.5 E2 <Euro 2>; D 260.5 E3 <Euro 3>	01.02→	<b>0 445 020 087</b>
<b>438043</b>	4,8	130	D245.35 E4 <Euro 4>	12.11→	<b>0 445 020 088</b>
<b>457043</b>	4,8	115	D245.30 E3 <Euro 3>	01.08→	<b>0 445 020 088</b>

**MERCEDES-BENZ**

<b>Actros</b>					
<b>1833 L,LS [963]</b>	10,7	240	470.9... <OM470LA Euro 6>	07.12→ TW	<b>0 445 020 235</b> <b>0 986 437 507</b> <b>0 445 020 260</b>
<b>1836 L,LS [963]</b>	10,7	265	470.9... <OM470LA Euro 6>	07.12→ TW	<b>0 445 020 235</b> <b>0 986 437 507</b> <b>0 445 020 260</b>
<b>1840 L,LS [963]</b>	10,7	290	470.9... <OM470LA Euro 6>	07.12→ TW	<b>0 445 020 235</b> <b>0 986 437 507</b> <b>0 445 020 260</b>
<b>1842 L,LS [963]</b>	12,8	310	OM 471.9... <EEV, Euro 5/6>	09.11→ TW	<b>0 445 020 235</b> <b>0 986 437 507</b> <b>0 445 020 260</b>
<b>1843 L,LS [963]</b>	10,7	315	470.9... <OM470LA Euro 6>	07.12→ TW	<b>0 445 020 235</b> <b>0 986 437 507</b> <b>0 445 020 260</b>
<b>1845 L,LS [963]</b>	12,8	330	OM 471.9... <EEV, Euro 5/6>	09.11→ TW	<b>0 445 020 235</b> <b>0 986 437 507</b> <b>0 445 020 260</b>
<b>1848 L,LS [963]</b>	12,8	350	OM 471.9... <Euro 6>	09.11→ TW	<b>0 445 020 235</b> <b>0 986 437 507</b> <b>0 445 020 260</b>
<b>1851 L,LS [963]</b>	12,8	375	OM 471.9... <EEV, Euro 5/6>	09.11→ TW	<b>0 445 020 235</b> <b>0 986 437 507</b> <b>0 445 020 260</b>
<b>1852 L,LS [963]</b>	15,6	380	473.900 <OM473LA Euro 6>	10.13→	<b>0 445 020 235</b> <b>0 986 437 507</b>
<b>1858 L,LS [963]</b>	15,6	425	473.900 <OM473LA Euro 6>	10.13→	<b>0 445 020 235</b> <b>0 986 437 507</b>
<b>1863 L,LS [963]</b>	15,6	460	473.900 <OM473LA Euro 6>	10.13→	<b>0 445 020 235</b> <b>0 986 437 507</b>
<b>2033 L,LS [963]</b>	10,7	240	470.9... <OM470LA Euro 6>	07.12→ TW	<b>0 445 020 235</b> <b>0 986 437 507</b> <b>0 445 020 260</b>
<b>2036 L,LS [963]</b>	10,7	265	470.9... <OM470LA Euro 6>	03.13→ TW	<b>0 445 020 235</b> <b>0 986 437 507</b> <b>0 445 020 260</b>
<b>2040 L,LS [963]</b>	10,7	290	470.9... <OM470LA Euro 6>	03.13→ TW	<b>0 445 020 235</b> <b>0 986 437 507</b> <b>0 445 020 260</b>
<b>2042 L,LS [963]</b>	12,8	310	OM 471.9...	03.13→ TW	<b>0 445 020 235</b> <b>0 986 437 507</b> <b>0 445 020 260</b>
<b>2043 L,LS [963]</b>	10,7	315	470.9... <OM470LA Euro 6>	03.13→ TW	<b>0 445 020 235</b> <b>0 986 437 507</b> <b>0 445 020 260</b>
<b>2045 L,LS [963]</b>	12,8	330	OM 471.9...	09.11→ TW	<b>0 445 020 235</b> <b>0 986 437 507</b> <b>0 445 020 260</b>
<b>2048 L,LS [963]</b>	12,8	350	OM 471.90... <Euro 6>	03.13→ TW	<b>0 445 020 235</b> <b>0 986 437 507</b> <b>0 445 020 260</b>
<b>2051 L,LS [963]</b>	12,8	375	OM 471.90... <Euro 6>	09.11→ TW	<b>0 445 020 235</b> <b>0 986 437 507</b> <b>0 445 020 260</b>
<b>2052 L,LS [963]</b>	15,6	380	473.900 <OM473LA Euro 6>	12.13→	<b>0 445 020 235</b> <b>0 986 437 507</b>
<b>2058 L,LS [963]</b>	15,6	425	473.900 <OM473LA Euro 6>	12.13→	<b>0 445 020 235</b> <b>0 986 437 507</b>
<b>2063 L,LS [963]</b>	15,6	460	473.900 <OM473LA Euro 6>	12.13→	<b>0 445 020 235</b> <b>0 986 437 507</b>
<b>2433 LS [963]</b>	10,7	240	470.9... <OM470LA Euro 6>	07.12→ TW	<b>0 445 020 235</b> <b>0 986 437 507</b> <b>0 445 020 260</b>







◀ MERCEDES-BENZ

2436 LS [963]	10,7	265	470.9... <OM470LA Euro 6>	07.12→	TW	0 445 020 235 0 445 020 260	0 986 437 507
2440 LS [963]	10,7	290	470.9... <OM470LA Euro 6>	07.12→	TW	0 445 020 235 0 445 020 260	0 986 437 507
2442 LS [963]	12,8	310	OM 471.9... <Euro 6>	07.12→	TW	0 445 020 235 0 445 020 260	0 986 437 507
2443 LS [963]	10,7	315	470.9... <OM470LA Euro 6>	07.12→	TW	0 445 020 235 0 445 020 260	0 986 437 507
2445 LS [963]	12,8	330	OM 471.9... <Euro 6>	07.12→	TW	0 445 020 235 0 445 020 260	0 986 437 507
2448 LS [963]	12,8	350	OM 471.9... <Euro 6>	07.12→	TW	0 445 020 235 0 445 020 260	0 986 437 507
2451 LS [963]	12,8	375	OM 471.9... <Euro 6>	07.12→	TW	0 445 020 235 0 445 020 260	0 986 437 507
2452 LS [963]	15,6	380	473.900 <OM473LA Euro 6>	12.13→		0 445 020 235	0 986 437 507
2458 LS [963]	15,6	425	473.900 <OM473LA Euro 6>	12.13→		0 445 020 235	0 986 437 507
2463 LS [963]	15,6	460	473.900 <OM473LA Euro 6>	12.13→		0 445 020 235	0 986 437 507
2533 L,LS [963]	10,7	240	470.9... <OM470LA Euro 6>	07.12→	TW	0 445 020 235 0 445 020 260	0 986 437 507
2536 L,LS [963]	10,7	265	470.9... <OM470LA Euro 6>	07.12→	TW	0 445 020 235 0 445 020 260	0 986 437 507
2540 L,LS [963]	10,7	290	470.9... <OM470LA Euro 6>	07.12→	TW	0 445 020 235 0 445 020 260	0 986 437 507
2542 L,LS [963]	12,8	310	OM 471.9... <EEV, Euro 5/6>	09.11→	TW	0 445 020 235 0 445 020 260	0 986 437 507
2543 L,LS [963]	10,7	315	470.9... <OM470LA Euro 6>	07.12→	TW	0 445 020 235 0 445 020 260	0 986 437 507
2545 L,LS [963]	12,8	330	OM 471.9... <EEV, Euro 5/6>	09.11→	TW	0 445 020 235 0 445 020 260	0 986 437 507
2548 L,LS [963]	12,8	350	OM 471.9... <Euro 6>	09.11→	TW	0 445 020 235 0 445 020 260	0 986 437 507
2551 L,LS [963]	12,8	375	OM 471.9... <EEV, Euro 5/6>	09.11→	TW	0 445 020 235 0 445 020 260	0 986 437 507
2552 L,LS [963]	15,6	380	473.900 <OM473LA Euro 6>	12.13→		0 445 020 235	0 986 437 507
2558 L,LS [963]	15,6	425	473.900 <OM473LA Euro 6>	12.13→		0 445 020 235	0 986 437 507
2563 L,LS [963]	15,6	460	473.900 <OM473LA Euro 6>	12.13→		0 445 020 235	0 986 437 507
2633 L,LS [963]	10,7	240	470.9... <OM470LA Euro 6>	07.12→	TW	0 445 020 235 0 445 020 260	0 986 437 507
2636 L,LS [963]	10,7	265	470.9... <OM470LA Euro 6>	07.12→	TW	0 445 020 235 0 445 020 260	0 986 437 507
2640 L,LS [963]	10,7	290	470.9... <OM470LA Euro 6>	07.12→	TW	0 445 020 235 0 445 020 260	0 986 437 507
2642 L,LS [963]	12,8	310	OM 471.9... <Euro 6>	07.12→	TW	0 445 020 235 0 445 020 260	0 986 437 507
2643 L,LS [963]	10,7	315	470.9... <OM470LA Euro 6>	07.12→	TW	0 445 020 235 0 445 020 260	0 986 437 507
2645 L,LS [963]	12,8	330	OM 471.9... <Euro 6>	07.12→	TW	0 445 020 235 0 445 020 260	0 986 437 507
2648 L,LS [963]	12,8	350	OM 471.9... <Euro 6>	07.12→	TW	0 445 020 235 0 445 020 260	0 986 437 507
2651 L,LS [963]	12,8	375	OM 471.9...	09.11→	TW	0 445 020 235 0 445 020 260	0 986 437 507
2652 L,LS [963]	15,6	380	473.900 <OM473LA Euro 6>	12.13→		0 445 020 235	0 986 437 507
2658 L,LS [963]	15,6	425	473.900 <OM473LA Euro 6>	12.13→		0 445 020 235	0 986 437 507
2663 L,LS [963]	15,6	460	473.900 <OM473LA Euro 6>	12.13→		0 445 020 235	0 986 437 507
3333 L,LS [963]	10,7	240	470.9... <OM470LA Euro 6>	03.13→	TW	0 445 020 235 0 445 020 260	0 986 437 507
3336 L,LS [963]	10,7	265	470.9... <OM470LA Euro 6>	03.13→	TW	0 445 020 235 0 445 020 260	0 986 437 507
3340 L,LS [963]	10,7	290	470.9... <OM470LA Euro 6>	03.13→	TW	0 445 020 235 0 445 020 260	0 986 437 507
3342 L,LS [963]	12,8	310	OM 471.9...	03.13→	TW	0 445 020 235 0 445 020 260	0 986 437 507





3343 L,LS [963]	10,7	315	470.9... <OM470LA Euro 6>	03.13→	TW	0 445 020 235	0 986 437 507
						0 445 020 260	
3345 L,LS [963]	12,8	330	OM 471.9...	03.13→	TW	0 445 020 235	0 986 437 507
						0 445 020 260	
3348 L,LS [963]	12,8	350	OM 471.9...	03.13→	TW	0 445 020 235	0 986 437 507
						0 445 020 260	
3351 L,LS [963]	12,8	375	OM 471.9... <EEV, Euro 5/6>	03.13→	TW	0 445 020 235	0 986 437 507
						0 445 020 260	
3352 L,LS [963]	15,6	380	473.900 <OM473LA Euro 6>	03.13→		0 445 020 235	0 986 437 507
3358 L,LS [963]	15,6	425	473.900 <OM473LA Euro 6>	03.13→		0 445 020 235	0 986 437 507
3363 L,LS [963]	15,6	460	473.900 <OM473LA Euro 6>	03.13→		0 445 020 235	0 986 437 507
<b>Antos</b>							
1833 L,LS	10,7	240	470.9... <OM470LA Euro 6>	09.12→	TW	0 445 020 235	0 986 437 507
						0 445 020 260	
1836 L,LS	10,7	265	470.9... <OM470LA Euro 6>	09.12→	TW	0 445 020 235	0 986 437 507
						0 445 020 260	
1840 L,LS	10,7	290	470.9... <OM470LA Euro 6>	09.12→	TW	0 445 020 235	0 986 437 507
						0 445 020 260	
1842 L,LS	12,8	310	OM 471.9...	09.12→	TW	0 445 020 235	0 986 437 507
						0 445 020 260	
1843 L,LS	10,7	315	470.9... <OM470LA Euro 6>	09.12→	TW	0 445 020 235	0 986 437 507
						0 445 020 260	
1845 L,LS	12,8	330	OM 471.9...	09.12→	TW	0 445 020 235	0 986 437 507
						0 445 020 260	
1848 L,LS	12,8	350	OM 471.9...	09.12→	TW	0 445 020 235	0 986 437 507
						0 445 020 260	
1851 L,LS	12,8	375	OM 471.9... <Euro 6>	09.12→	TW	0 445 020 235	0 986 437 507
						0 445 020 260	
1852 L,LS	15,6	380	473.900 <OM473LA Euro 6>	10.13→		0 445 020 235	0 986 437 507
1858 L,LS	15,6	425	473.900 <OM473LA Euro 6>	10.13→		0 445 020 235	0 986 437 507
1863 L,LS	15,6	460	473.900 <OM473LA Euro 6>	10.13→		0 445 020 235	0 986 437 507
2033 L,LS	10,7	240	470.9... <OM470LA Euro 6>	03.13→	TW	0 445 020 235	0 986 437 507
						0 445 020 260	
2036 L,LS	10,7	265	470.9... <OM470LA Euro 6>	03.13→	TW	0 445 020 235	0 986 437 507
						0 445 020 260	
2040 L,LS	10,7	290	470.9... <OM470LA Euro 6>	03.13→	TW	0 445 020 235	0 986 437 507
						0 445 020 260	
2042 L,LS	12,8	310	OM 471.9...	03.13→	TW	0 445 020 235	0 986 437 507
						0 445 020 260	
2043 L,LS	10,7	315	470.9... <OM470LA Euro 6>	03.13→	TW	0 445 020 235	0 986 437 507
						0 445 020 260	
2045 L,LS	12,8	330	OM 471.9...	03.13→	TW	0 445 020 235	0 986 437 507
						0 445 020 260	
2048 L,LS	12,8	350	OM 471.9...	03.13→	TW	0 445 020 235	0 986 437 507
						0 445 020 260	
2051 L,LS	12,8	375	OM 471.9...	03.13→	TW	0 445 020 235	0 986 437 507
						0 445 020 260	
2052 L,LS	15,6	380	473.900 <OM473LA Euro 6>	12.13→		0 445 020 235	0 986 437 507
2058 L,LS	15,6	425	473.900 <OM473LA Euro 6>	12.13→		0 445 020 235	0 986 437 507
2063 L,LS	15,6	460	473.900 <OM473LA Euro 6>	12.13→		0 445 020 235	0 986 437 507
2433 LS	10,7	240	470.9... <OM470LA Euro 6>	09.12→	TW	0 445 020 235	0 986 437 507
						0 445 020 260	
2436 LS	10,7	265	470.9... <OM470LA Euro 6>	09.12→	TW	0 445 020 235	0 986 437 507
						0 445 020 260	
2440 LS	10,7	290	470.9... <OM470LA Euro 6>	09.12→	TW	0 445 020 235	0 986 437 507
						0 445 020 260	
2442 LS	12,8	310	OM 471.9...	09.12→	TW	0 445 020 235	0 986 437 507
						0 445 020 260	
2443 LS	10,7	315	470.9... <OM470LA Euro 6>	09.12→	TW	0 445 020 235	0 986 437 507
						0 445 020 260	
2445 LS	12,8	330	OM 471.9...	09.12→	TW	0 445 020 235	0 986 437 507
						0 445 020 260	





◀ MERCEDES-BENZ

2448 LS	12,8	350	OM 471.9...	09.12→	TW	0 445 020 235 0 445 020 260	0 986 437 507
2451 LS	12,8	375	OM 471.9...	09.12→	TW	0 445 020 235 0 445 020 260	0 986 437 507
2452 LS	15,6	380	473.900 <OM473LA Euro 6>	12.13→		0 445 020 235	0 986 437 507
2458 LS	15,6	425	473.900 <OM473LA Euro 6>	12.13→		0 445 020 235	0 986 437 507
2463 LS	15,6	460	473.900 <OM473LA Euro 6>	12.13→		0 445 020 235	0 986 437 507
2533 L,LS	10,7	240	470.9... <OM470LA Euro 6>	09.12→	TW	0 445 020 235 0 445 020 260	0 986 437 507
2536 L,LS	10,7	265	470.9... <OM470LA Euro 6>	09.12→	TW	0 445 020 235 0 445 020 260	0 986 437 507
2540 L,LS	10,7	290	470.9... <OM470LA Euro 6>	09.12→	TW	0 445 020 235 0 445 020 260	0 986 437 507
2542 L,LS	12,8	310	OM 471.9...	09.12→	TW	0 445 020 235 0 445 020 260	0 986 437 507
2543 L,LS	10,7	315	470.9... <OM470LA Euro 6>	09.12→	TW	0 445 020 235 0 445 020 260	0 986 437 507
2545 L,LS	12,8	330	OM 471.9...	09.12→	TW	0 445 020 235 0 445 020 260	0 986 437 507
2548 L,LS	12,8	350	OM 471.9...	09.12→	TW	0 445 020 235 0 445 020 260	0 986 437 507
2551 L,LS	12,8	350-375	OM 471.9...	09.12→	TW	0 445 020 235 0 445 020 260	0 986 437 507
2552 L,LS	15,6	380	473.900 <OM473LA Euro 6>	12.13→		0 445 020 235	0 986 437 507
2558 L,LS	15,6	425	473.900 <OM473LA Euro 6>	12.13→		0 445 020 235	0 986 437 507
2563 L,LS	15,6	460	473.900 <OM473LA Euro 6>	12.13→		0 445 020 235	0 986 437 507
2633 L,LS	10,7	240	470.9... <OM470LA Euro 6>	09.12→	TW	0 445 020 235 0 445 020 260	0 986 437 507
2636 L,LS	10,7	265	470.9... <OM470LA Euro 6>	09.12→	TW	0 445 020 235 0 445 020 260	0 986 437 507
2640 L,LS	10,7	290	470.9... <OM470LA Euro 6>	09.12→	TW	0 445 020 235 0 445 020 260	0 986 437 507
2642 L,LS	12,8	310	OM 471.9...	09.12→	TW	0 445 020 235 0 445 020 260	0 986 437 507
2643 L,LS	10,7	315	470.9... <OM470LA Euro 6>	09.12→	TW	0 445 020 235 0 445 020 260	0 986 437 507
2645 L,LS	12,8	330	OM 471.9...	09.12→	TW	0 445 020 235 0 445 020 260	0 986 437 507
2648 L,LS	12,8	350	OM 471.9...	09.12→	TW	0 445 020 235 0 445 020 260	0 986 437 507
2651 L,LS	12,8	375	OM 471.9...	09.12→	TW	0 445 020 235 0 445 020 260	0 986 437 507
2652 L,LS	15,6	380	473.900 <OM473LA Euro 6>	12.13→		0 445 020 235	0 986 437 507
2658 L,LS	15,6	425	473.900 <OM473LA Euro 6>	12.13→		0 445 020 235	0 986 437 507
2663 L,LS	15,6	460	473.900 <OM473LA Euro 6>	12.13→		0 445 020 235	0 986 437 507
3333 L,LS	10,7	240	470.9... <OM470LA Euro 6>	03.13→	TW	0 445 020 235 0 445 020 260	0 986 437 507
3336 L,LS	10,7	265	470.9... <OM470LA Euro 6>	03.13→	TW	0 445 020 235 0 445 020 260	0 986 437 507
3340 L,LS	10,7	290	470.9... <OM470LA Euro 6>	03.13→	TW	0 445 020 235 0 445 020 260	0 986 437 507
3342 L,LS	12,8	310	OM 471.9...	03.13→	TW	0 445 020 235 0 445 020 260	0 986 437 507
3343 L,LS	10,7	315	470.9... <OM470LA Euro 6>	03.13→	TW	0 445 020 235 0 445 020 260	0 986 437 507
3345 L,LS	12,8	330	OM 471.9...	03.13→	TW	0 445 020 235 0 445 020 260	0 986 437 507
3348 L,LS	12,8	350	OM 471.9...	03.13→	TW	0 445 020 235 0 445 020 260	0 986 437 507
3351 L,LS	12,8	375	OM 471.9...	03.13→	TW	0 445 020 235 0 445 020 260	0 986 437 507
3352 L,LS	15,6	380	473.900 <OM473LA Euro 6>	03.13→		0 445 020 235	0 986 437 507
3358 L,LS	15,6	425	473.900 <OM473LA Euro 6>	03.13→		0 445 020 235	0 986 437 507





<b>3363</b> L,LS	15,6	460	473.900 <OM473LA Euro 6>	03.13→		<b>0 445 020 235</b>	<b>0 986 437 507</b>
<b>Arocs</b>							
<b>1833</b> [964]	10,7	240	470.9... <OM470LA Euro 6>	04.13→	TW	<b>0 445 020 235</b>	<b>0 986 437 507</b>
						<b>0 445 020 260</b>	
<b>1836</b> [964]	10,7	265	470.9... <OM470LA Euro 6>	04.13→	TW	<b>0 445 020 235</b>	<b>0 986 437 507</b>
						<b>0 445 020 260</b>	
<b>1840</b> [964]	10,7	290	470.9... <OM470LA Euro 6>	04.13→	TW	<b>0 445 020 235</b>	<b>0 986 437 507</b>
						<b>0 445 020 260</b>	
<b>1842</b> [964]	12,8	310	OM 471.9...	04.13→	TW	<b>0 445 020 235</b>	<b>0 986 437 507</b>
						<b>0 445 020 260</b>	
<b>1843</b> [964]	10,7	315	470.9... <OM470LA Euro 6>	04.13→	TW	<b>0 445 020 235</b>	<b>0 986 437 507</b>
						<b>0 445 020 260</b>	
<b>1845</b> [964]	12,8	330	OM 471.9...	04.13→	TW	<b>0 445 020 235</b>	<b>0 986 437 507</b>
						<b>0 445 020 260</b>	
<b>1848</b> [964]	12,8	350	OM 471.9...	04.13→	TW	<b>0 445 020 235</b>	<b>0 986 437 507</b>
						<b>0 445 020 260</b>	
<b>1851</b> [964]	12,8	375	OM 471.9...	04.13→	TW	<b>0 445 020 235</b>	<b>0 986 437 507</b>
						<b>0 445 020 260</b>	
<b>1852</b> [964]	15,6	380	473.900 <OM473LA Euro 6>	04.13→		<b>0 445 020 235</b>	<b>0 986 437 507</b>
<b>1858</b> [964]	15,6	425	473.900 <OM473LA Euro 6>	04.13→		<b>0 445 020 235</b>	<b>0 986 437 507</b>
<b>1863</b> [964]	15,6	460	473.900 <OM473LA Euro 6>	04.13→		<b>0 445 020 235</b>	<b>0 986 437 507</b>
<b>2033</b> [964]	10,7	240	470.9... <OM470LA Euro 6>	04.13→	TW	<b>0 445 020 235</b>	<b>0 986 437 507</b>
						<b>0 445 020 260</b>	
<b>2036</b> [964]	10,7	265	470.9... <OM470LA Euro 6>	04.13→	TW	<b>0 445 020 235</b>	<b>0 986 437 507</b>
						<b>0 445 020 260</b>	
<b>2040</b> [964]	10,7	290	470.9... <OM470LA Euro 6>	04.13→	TW	<b>0 445 020 235</b>	<b>0 986 437 507</b>
						<b>0 445 020 260</b>	
<b>2042</b> [964]	12,8	310	OM 471.9...	04.13→	TW	<b>0 445 020 235</b>	<b>0 986 437 507</b>
						<b>0 445 020 260</b>	
<b>2043</b> [964]	10,7	315	470.9... <OM470LA Euro 6>	04.13→	TW	<b>0 445 020 235</b>	<b>0 986 437 507</b>
						<b>0 445 020 260</b>	
<b>2045</b> [964]	12,8	330	OM 471.9...	04.13→	TW	<b>0 445 020 235</b>	<b>0 986 437 507</b>
						<b>0 445 020 260</b>	
<b>2048</b> [964]	12,8	350	OM 471.9...	04.13→	TW	<b>0 445 020 235</b>	<b>0 986 437 507</b>
						<b>0 445 020 260</b>	
<b>2051</b> [964]	12,8	375	OM 471.9...	04.13→	TW	<b>0 445 020 235</b>	<b>0 986 437 507</b>
						<b>0 445 020 260</b>	
<b>2052</b> [964]	15,6	380	473.900 <OM473LA Euro 6>	04.13→		<b>0 445 020 235</b>	<b>0 986 437 507</b>
<b>2058</b> [964]	15,6	425	473.900 <OM473LA Euro 6>	04.13→		<b>0 445 020 235</b>	<b>0 986 437 507</b>
<b>2063</b> [964]	15,6	460	473.900 <OM473LA Euro 6>	04.13→		<b>0 445 020 235</b>	<b>0 986 437 507</b>
<b>2533</b> [964]	10,7	240	470.9... <OM470LA Euro 6>	04.13→	TW	<b>0 445 020 235</b>	<b>0 986 437 507</b>
						<b>0 445 020 260</b>	
<b>2536</b> [964]	10,7	265	470.9... <OM470LA Euro 6>	04.13→	TW	<b>0 445 020 235</b>	<b>0 986 437 507</b>
						<b>0 445 020 260</b>	
<b>2540</b> [964]	10,7	290	470.9... <OM470LA Euro 6>	04.13→	TW	<b>0 445 020 235</b>	<b>0 986 437 507</b>
						<b>0 445 020 260</b>	
<b>2542</b> [964]	12,8	310	OM 471.9...	04.13→	TW	<b>0 445 020 235</b>	<b>0 986 437 507</b>
						<b>0 445 020 260</b>	
<b>2543</b> [964]	10,7	315	470.9... <OM470LA Euro 6>	04.13→	TW	<b>0 445 020 235</b>	<b>0 986 437 507</b>
						<b>0 445 020 260</b>	
<b>2545</b> [964]	12,8	330	OM 471.9...	04.13→	TW	<b>0 445 020 235</b>	<b>0 986 437 507</b>
						<b>0 445 020 260</b>	
<b>2548</b> [964]	12,8	350	OM 471.9...	04.13→	TW	<b>0 445 020 235</b>	<b>0 986 437 507</b>
						<b>0 445 020 260</b>	
<b>2551</b> [964]	12,8	375	OM 471.9...	04.13→	TW	<b>0 445 020 235</b>	<b>0 986 437 507</b>
						<b>0 445 020 260</b>	
<b>2552</b> [964]	15,6	380	473.900 <OM473LA Euro 6>	04.13→		<b>0 445 020 235</b>	<b>0 986 437 507</b>
<b>2558</b> [964]	15,6	425	473.900 <OM473LA Euro 6>	04.13→		<b>0 445 020 235</b>	<b>0 986 437 507</b>
<b>2563</b> [964]	15,6	460	473.900 <OM473LA Euro 6>	04.13→		<b>0 445 020 235</b>	<b>0 986 437 507</b>
<b>2633</b> [964]	10,7	240	470.9... <OM470LA Euro 6>	04.13→	TW	<b>0 445 020 235</b>	<b>0 986 437 507</b>
						<b>0 445 020 260</b>	
<b>2636</b> [964]	10,7	265-315	470.9... <OM470LA Euro 6>	04.13→	TW	<b>0 445 020 235</b>	<b>0 986 437 507</b>
						<b>0 445 020 260</b>	





◀ MERCEDES-BENZ

2640 [964]	10,7	265-290	470.9... <OM470LA Euro 6>	04.13→	TW	0 445 020 235 0 445 020 260	0 986 437 507
2642 [964]	12,8	310	OM 471.9...	04.13→	TW	0 445 020 235 0 445 020 260	0 986 437 507
2643 [964]	10,7	315	470.9... <OM470LA Euro 6>	04.13→	TW	0 445 020 235 0 445 020 260	0 986 437 507
2645 [964]	12,8	330	OM 471.9...	04.13→	TW	0 445 020 235 0 445 020 260	0 986 437 507
2648 [964]	12,8	350	OM 471.9...	04.13→	TW	0 445 020 235 0 445 020 260	0 986 437 507
2651 [964]	12,8	375	OM 471.9...	04.13→	TW	0 445 020 235 0 445 020 260	0 986 437 507
2652 [964]	15,6	380	473.900 <OM473LA Euro 6>	04.13→		0 445 020 235	0 986 437 507
2658 [964]	15,6	425	473.900 <OM473LA Euro 6>	04.13→		0 445 020 235	0 986 437 507
2663 [964]	15,6	460	473.900 <OM473LA Euro 6>	04.13→		0 445 020 235	0 986 437 507
3233 [964]	10,7	240	470.9... <OM470LA Euro 6>	04.13→	TW	0 445 020 235 0 445 020 260	0 986 437 507
3236 [964]	10,7	265	470.9... <OM470LA Euro 6>	04.13→	TW	0 445 020 235 0 445 020 260	0 986 437 507
3240 [964]	10,7	290	470.9... <OM470LA Euro 6>	04.13→	TW	0 445 020 235 0 445 020 260	0 986 437 507
3242 [964]	12,8	310	OM 471.9...	04.13→	TW	0 445 020 235 0 445 020 260	0 986 437 507
3243 [964]	10,7	315	470.9... <OM470LA Euro 6>	04.13→	TW	0 445 020 235 0 445 020 260	0 986 437 507
3245 [964]	12,8	330	OM 471.9...	04.13→	TW	0 445 020 235 0 445 020 260	0 986 437 507
3248 [964]	12,8	350	OM 471.9...	04.13→	TW	0 445 020 235 0 445 020 260	0 986 437 507
3251 [964]	12,8	375	OM 471.9... <Euro 6>	04.13→	TW	0 445 020 235 0 445 020 260	0 986 437 507
3252 [964]	15,6	380	473.900 <OM473LA Euro 6>	04.13→		0 445 020 235	0 986 437 507
3258 [964]	15,6	425	473.900 <OM473LA Euro 6>	04.13→		0 445 020 235	0 986 437 507
3263 [964]	15,6	460	473.900 <OM473LA Euro 6>	04.13→		0 445 020 235	0 986 437 507
3333 [964]	10,7	240	470.9... <OM470LA Euro 6>	04.13→	TW	0 445 020 235 0 445 020 260	0 986 437 507
3336 [964]	10,7	265	470.9... <OM470LA Euro 6>	04.13→	TW	0 445 020 235 0 445 020 260	0 986 437 507
3340 [964]	10,7	290	470.9... <OM470LA Euro 6>	04.13→	TW	0 445 020 235 0 445 020 260	0 986 437 507
3342 [964]	12,8	310	OM 471.9...	04.13→	TW	0 445 020 235 0 445 020 260	0 986 437 507
3343 [964]	10,7	315	470.9... <OM470LA Euro 6>	04.13→	TW	0 445 020 235 0 445 020 260	0 986 437 507
3345 [964]	12,8	330	OM 471.9...	04.13→	TW	0 445 020 235 0 445 020 260	0 986 437 507
3348 [964]	12,8	350	OM 471.9...	04.13→	TW	0 445 020 235 0 445 020 260	0 986 437 507
3351 [964]	12,8	375	OM 471.9...	04.13→	TW	0 445 020 235 0 445 020 260	0 986 437 507
3352 [964]	15,6	380	473.900 <OM473LA Euro 6>	04.13→		0 445 020 235	0 986 437 507
3358 [964]	15,6	425	473.900 <OM473LA Euro 6>	04.13→		0 445 020 235	0 986 437 507
3363 [964]	15,6	460	473.900 <OM473LA Euro 6>	04.13→		0 445 020 235	0 986 437 507
4133 [964]	10,7	240	470.9... <OM470LA Euro 6>	04.13→	TW	0 445 020 235 0 445 020 260	0 986 437 507
4136 [964]	10,7	265	470.9... <OM470LA Euro 6>	04.13→	TW	0 445 020 235 0 445 020 260	0 986 437 507
4140 [964]	10,7	290	470.9... <OM470LA Euro 6>	04.13→	TW	0 445 020 235 0 445 020 260	0 986 437 507
4142 [964]	12,8	310	OM 471.9...	04.13→	TW	0 445 020 235 0 445 020 260	0 986 437 507
4143 [964]	10,7	315	470.9... <OM470LA Euro 6>	04.13→	TW	0 445 020 235 0 445 020 260	0 986 437 507





4145 [964]	12,8	330	OM 471.9...	04.13→	TW	0 445 020 235	0 986 437 507
						0 445 020 260	
4148 [964]	12,8	350	OM 471.9...	04.13→	TW	0 445 020 235	0 986 437 507
						0 445 020 260	
4151 [964]	12,8	375	OM 471.9...	04.13→	TW	0 445 020 235	0 986 437 507
						0 445 020 260	
4152 [964]	15,6	380	473.900 <OM473LA Euro 6>	04.13→		0 445 020 235	0 986 437 507
4158 [964]	15,6	425	473.900 <OM473LA Euro 6>	04.13→		0 445 020 235	0 986 437 507
4163 [964]	15,6	460	473.900 <OM473LA Euro 6>	04.13→		0 445 020 235	0 986 437 507
<b>CapaCity</b>							
10.7	10,7	290	470.904 <OM470LA Euro 6>	01.15→		0 445 020 235	0 986 437 507
<b>Citaro</b>							
0 530 G/GÜ	10,7	265	470.904 <OM470LA Euro 6>	05.12→		0 445 020 235	0 986 437 507
<b>Conecto G</b>							
10.7 [628]	10,7	265	470.904 <OM470LA Euro 6>	09.13→	TW	0 445 020 235	0 986 437 507
<b>Integro II</b>							
L	10,7	265-290	470.908 <OM470LA Euro6>	04.13→	TW	0 445 020 235	0 986 437 507
<b>Serie V</b>							
200 CDI [638]	2,2	75	OM 611.980	06.99-09.03		0 445 010 269	0 986 437 101
220 CDI [638]	2,2	90	OM 611.980	06.99-09.03		0 445 010 269	0 986 437 101
<b>Sprinter</b>							
208 CDI [T1N]	2,2	60	OM 611.987 D LA				
			Mot.-Nr. →..50 900359	04.00-05.06		0 445 010 272	0 986 437 103
			Mot.-Nr. ..50 900360→	04.00-05.06		0 445 010 268	0 986 437 100
211 CDI [T1N]	2,1	80	OM 611.981 D LA				
			Mot.-Nr. →..50 900069	04.00-05.06		0 445 010 272	0 986 437 103
			Mot.-Nr. ..50 900070→ ..51 000001→	04.00-05.06		0 445 010 268	0 986 437 100
213 CDI [T1N]	2,1	95	OM 611.981 D LA				
			Mot.-Nr. →..50 900069	04.00-05.06		0 445 010 272	0 986 437 103
			Mot.-Nr. ..50 900070→ ..51 000001→	04.00-05.06		0 445 010 268	0 986 437 100
216 CDI [T1N]	2,7	115	OM 612.981 D LA				
			Mot.-Nr. →50 899863	04.00-05.06		0 445 010 275	0 986 437 106
			Mot.-Nr. 50 899864→	04.00-05.06		0 445 010 271	0 986 437 104
219 CDI [NCV3]	3,0	140	OM 642... <Euro 5>				
			Mot.-Typ 642.896	03.09→	TW	0 445 010 322	0 986 437 374
308 CDI [T1N]	2,2	60	OM 611.987 D LA				
			Mot.-Nr. →..50 900359	04.00-05.06		0 445 010 272	0 986 437 103
			Mot.-Nr. ..50 900360→	04.00-05.06		0 445 010 268	0 986 437 100
311 CDI	2,2	80	OM 611 LA				
			Komp.Nr. 522612/01	06.01-12.04		0 445 010 272	0 986 437 103
			Komp.Nr. 522612/06	06.01-12.04		0 445 010 268	0 986 437 100
CDI [T1N]	2,1	80	OM 611.981 D LA				
			Mot.-Nr. →..50 900069	04.00-05.06		0 445 010 272	0 986 437 103
			Mot.-Nr. ..50 900070→ ..51 000001→	04.00-05.06		0 445 010 268	0 986 437 100
313 CDI	2,2	95	OM 611 LA				
			Komp.Nr. 522612/01	06.01-05.12		0 445 010 272	0 986 437 103
			Komp.Nr. 522612/06	06.01-05.12		0 445 010 268	0 986 437 100
CDI [T1N]	2,1	95	OM 611.981 D LA				
			Mot.-Nr. →..50 900069	04.00-05.06		0 445 010 272	0 986 437 103
			Mot.-Nr. ..50 900070→ ..51 000001→	04.00-05.06		0 445 010 268	0 986 437 100
CDI 4x4 [T1N]	2,1	95	OM 611.981 D LA				
			Mot.-Nr. →..50 900359	08.02-05.06		0 445 010 272	0 986 437 103
			Mot.-Nr. ..50 900360→	08.02-05.06		0 445 010 268	0 986 437 100
316 CDI [T1N]	2,7	115	OM 612.981 D LA				
			Mot.-Nr. →50 899863	04.00-05.06		0 445 010 275	0 986 437 106
			Mot.-Nr. 50 899864→	04.00-05.06		0 445 010 271	0 986 437 104
319 CDI [NCV3]	3,0	140	OM 642... <Euro 5>				
			Mot.-Typ 642.896/898	03.09→	TW	0 445 010 322	0 986 437 374
408 CDI [T1N]	2,2	60	OM 611.987 D LA				
			Mot.-Nr. →..50 900359	04.00-05.06		0 445 010 272	0 986 437 103
			Mot.-Nr. ..50 900360→	04.00-05.06		0 445 010 268	0 986 437 100







◀ MERCEDES-BENZ

<b>411 CDI [T1N]</b>	2,1	80	OM 611.981 DLA					
			Mot.-Nr. →..50 900069	04.00-05.06			<b>0 445 010 272</b>	<b>0 986 437 103</b>
			Mot.-Nr. ..50 900070→ ..51 000001→	04.00-05.06			<b>0 445 010 268</b>	<b>0 986 437 100</b>
<b>413 CDI</b>	2,2	95	OM 611 LA					
			Komp.Nr. 522612/01	06.01-05.12			<b>0 445 010 272</b>	<b>0 986 437 103</b>
			Komp.Nr. 522612/06	06.01-05.12			<b>0 445 010 268</b>	<b>0 986 437 100</b>
CDI [T1N]	2,1	95	OM 611.981 DLA					
			Mot.-Nr. →..50 900069	04.00-05.06			<b>0 445 010 272</b>	<b>0 986 437 103</b>
			Mot.-Nr. ..50 900070→ ..51 000001→	04.00-05.06			<b>0 445 010 268</b>	<b>0 986 437 100</b>
<b>416 CDI [T1N]</b>	2,7	115	OM 612.981 DLA					
			Mot.-Nr. →50 899863	04.00-05.06			<b>0 445 010 275</b>	<b>0 986 437 106</b>
			Mot.-Nr. 50 899864→	04.00-05.06			<b>0 445 010 271</b>	<b>0 986 437 104</b>
<b>419 CDI [NCV3]</b>	3,0	140	OM 642... <Euro 5>					
			Mot.-Typ 642.896	03.09→	TW		<b>0 445 010 322</b>	<b>0 986 437 374</b>
<b>519 CDI [NCV3]</b>	3,0	140	OM 642... <Euro 5>					
			Mot.-Typ 642.896/898	03.09→	TW		<b>0 445 010 322</b>	<b>0 986 437 374</b>
<b>616 CDI [T1N]</b>	2,7	115	OM 612.981 DLA					
			Mot.-Nr. →50 899863	02.01-05.06			<b>0 445 010 275</b>	<b>0 986 437 106</b>
			Mot.-Nr. 50 899864→	02.01-05.06			<b>0 445 010 271</b>	<b>0 986 437 104</b>

**Sprinter (James Cook)**

<b>316 CDI [T1N]</b>	2,7	115	OM 612.981 DLA					
			Mot.-Nr. →50 899863	04.01-05.06			<b>0 445 010 275</b>	<b>0 986 437 106</b>
			Mot.-Nr. 50 899864→	04.01-05.06			<b>0 445 010 271</b>	<b>0 986 437 104</b>

**Sprinter Street**

<b>311 CDI</b>	2,2	95	OM 611 LA					
			Komp.Nr. 522612/01	01.09-05.12			<b>0 445 010 272</b>	<b>0 986 437 103</b>
			Komp.Nr. 522612/06	01.09-05.12			<b>0 445 010 268</b>	<b>0 986 437 100</b>

**Travego**

<b>0 580 M,L [Edition1]</b>	12,8	350	OM 471.902 LA <Euro 6>	02.12→	TW		<b>0 445 020 235</b>	<b>0 986 437 507</b>
-----------------------------	------	-----	------------------------	--------	----	--	----------------------	----------------------

**Vito**

<b>108 CDI [638]</b>	2,2	60	OM 611.980	04.99-09.03			<b>0 445 010 269</b>	<b>0 986 437 101</b>
<b>110 CDI [638]</b>	2,2	75	OM 611.980	04.99-09.03			<b>0 445 010 269</b>	<b>0 986 437 101</b>
<b>112 CDI [638]</b>	2,2	90	OM 611.980	04.99-09.03			<b>0 445 010 269</b>	<b>0 986 437 101</b>



**mitsubishi**

**Canter 35**

<b>3C11 [FB]</b>	3,0	81	4M42-T1 <Euro 4>	04.06→			<b>0 445 020 049</b>	
<b>3C13 [FB]</b>	3,0	92	4M42-T2 <Euro 4>	04.06→			<b>0 445 020 049</b>	
<b>3C15 [FB]</b>	3,0	107	4M42-T4 <Euro 4>	04.06→			<b>0 445 020 049</b>	
<b>3S11 [FE]</b>	3,0	81	4M42-T1 <Euro 4>	04.06→			<b>0 445 020 049</b>	
<b>3S13 [FE]</b>	3,0	92	4M42-T2 <Euro 4>	04.06→			<b>0 445 020 049</b>	

**Canter 55**

<b>5S13 [FE]</b>	3,0	92	4M42-3A T2 <Euro 4>	04.06→			<b>0 445 020 049</b>	
------------------	-----	----	---------------------	--------	--	--	----------------------	--

**Canter 65**

<b>6C15 [FE]</b>	3,0	107	4M42-3A T4 <Euro 4>	04.06→			<b>0 445 020 049</b>	
<b>6C18 [FE]</b>	4,9	132	4M50-T5 <Euro 4>	08.06→			<b>0 445 020 050</b>	

**Canter 75**

<b>7C15 [FE]</b>	3,0	107	4M42-3A T4 <Euro 4>	04.06→			<b>0 445 020 049</b>	
<b>7C18 [FE]</b>	4,9	132	4M50-T5 <Euro 4>	08.06→			<b>0 445 020 050</b>	

**mitsubishi fuso truck & bus co**

**Canter**

<b>3C11 D</b>	3,0	81	4M42-3AT1 <Euro 4>	04.06-11.10			<b>0 445 020 049</b>	
<b>3C13 D</b>	3,0	92	4M42-3AT2 <Euro 4>	04.06-11.10			<b>0 445 020 049</b>	
<b>3C15</b>	3,0	107	4M42-3AT4 <Euro 4>	04.06-11.10			<b>0 445 020 049</b>	
<b>3S11 D</b>	3,0	81	4M42-3AT1 <Euro 4>	04.06-11.10			<b>0 445 020 049</b>	
<b>3S13 D</b>	3,0	92	4M42-3AT2 <Euro 4>	04.06-11.10			<b>0 445 020 049</b>	
<b>4.9 D Turbo</b>	4,9	110	4M50-7AT7 <Euro 3>	11.09→			<b>0 445 020 028</b>	
<b>5S13 D</b>	3,0	92	4M42-3AT2 <Euro 4>	04.06-11.10			<b>0 445 020 049</b>	



6C15 D	3,0	107	4M42-3AT4 <Euro 4>	04.06-11.10	0 445 020 049
6C18 D	4,9	132	4M50-T5 <Euro 4>	04.06-11.10	0 445 020 050
7C15 D	3,0	107	4M42-3AT4 <Euro 4>	04.06-11.10	0 445 020 049
7C18 D	4,9	132	4M50-T5 <Euro 4>	04.06-11.10	0 445 020 050

## MZKT

<b>42t</b>					
700600	11,1	303	650.10 <Euro 3>	01.10→	0 445 020 086

## NEFAZ NEFTEKAMSK

<b>Serie 5000</b>					
5297	5,9	184	6ISBe 250.30 <Euro 3>	01.00→ TW	0 445 020 007 0 986 437 341 0 445 020 045 0 986 437 342
5299	6,7	184	6ISBe 250.30 <Euro 3>	01.08→ TW	0 445 020 007 0 986 437 341 0 445 020 045 0 986 437 342
		198	6ISBe 270B <Euro 3>	01.08→ TW	0 445 020 007 0 986 437 341 0 445 020 045 0 986 437 342

## NEOPLAN

<b>Trendliner</b>					
N 3516 ..	10,5	228	D 2066 LUH01 <Euro 4>	01.06-03.10	0 445 020 075 0 986 437 350

## NISSAN

<b>Atleon</b>					
3.0 [TK3]	3,0	110	ZD30Kai	09.09→	0 445 010 418
<b>Cabstar</b>					
3.0 D Turbo [F24]	3,0	110	ZD30DDTI	09.06-08.16 MG6	0 445 010 418
				3T5, MG5	0 445 010 136 0 986 437 031
				4T5, MG5	0 445 010 195
TD [F24]	3,0	110	ZD30DDTI	03.11→	0 445 010 195
<b>Cabstar NT400</b>					
3.0 DDTI [F24]	3,0	96/110	ZD30DDTI	11.16→	0 445 010 418
<b>Interstar</b>					
1.9 dCi 80 [X70]	1,9	59-60	F9Q 77...	07.02-06.10	0 445 010 075 0 986 437 301
2.2 dCi 90 [X70]	2,2	66	G9T 7...	07.02-06.10	0 445 010 033 0 986 437 302
2.5 dCi 100 [X70]	2,5	73-74	G9U...		
			Mot.-Nr. G9U 650	11.03-09.07	0 445 010 140 0 986 437 033
				10.07-06.10	0 445 010 295 0 986 437 039
			Mot.-Nr. G9U 754	11.03-06.10	0 445 010 033 0 986 437 302
dCi 120 [X70]	2,5	84-88	G9U...		
			Mot.-Nr. G9U 632	07.02-09.07	0 445 010 140 0 986 437 033
			Mot.-Nr. G9U 650	10.07-06.10	0 445 010 295 0 986 437 039
			Mot.-Nr. G9U 720	07.02-06.10	0 445 010 033 0 986 437 302
			Mot.-Nr. G9U 724		
			Mot.-Nr. G9U 750		
			Mot.-Nr. G9U 754		
3.0 dCi 140 [X70]	3,0	99-100	ZD3	11.03-06.10	0 445 020 024
<b>NT500</b>					
35.15 [G40M]	3,0	110	ZD30VNT	12.13→	0 445 010 418
56.15 [G40M]	3,0	110	ZD30VNT	12.13→	0 445 010 418
65.15 [G40M]	3,0	110	ZD30VNT	12.13→	0 445 010 418
<b>Primastar</b>					
1.9 dCi 80, dCi 100 [X83]	1,9	59-60/74	F9Q 760; F9Q 762	07.02-12.07	0 445 010 075 0 986 437 301





◀ NISSAN

2.0 dCi 90, dCi 115 [X83]	2,0	66/84-85	M9R...						
			Mot.-Nr. M9R 780	10.06→	0 445 010 099	0 986 437 355			
			Mot.-Nr. M9R 782	10.06-11.08	0 445 010 170	0 986 437 044			
				12.08→	0 445 010 223	0 986 437 044			
2.5 dCi 135 [X83]	2,5	99	G9U 730				09.03-11.11	0 445 010 033	0 986 437 302
dCi 150 [X83]	2,5	107-110	G9U 630				10.06-12.07	0 445 010 140	0 986 437 033
							01.08→	0 445 010 196	0 986 437 039

**OPEL**

**Movano**

1.9 DTI [A]	1,9	60	F9Q-77... <EEC99/102A>				10.01-10.05	0 445 010 075	0 986 437 301	
2.2 DTI [A]	2,2	66	G9T-7... <ECC99/102A>; G9T-720 <EEC96/69>				09.00-10.05	0 445 010 033	0 986 437 302	
2.3 CDTI FWD [B]	2,3	74	M9T 87...				10.12→	EU4,TW	0 445 010 205	0 986 437 041
							EU5,TW	0 445 010 234	0 986 437 086	
							TW	0 445 010 250	0 986 437 045	
			74/92	M9T 67...		04.10→	EU4	0 445 010 205	0 986 437 041	
							EU5	0 445 010 234	0 986 437 086	
			81	M9T 870		06.14→		0 445 010 250	0 986 437 045	
			92/107	M9T 6...		04.10→	EU4	0 445 010 205	0 986 437 041	
							EU5	0 445 010 234	0 986 437 086	
				M9T 8...		10.12→	EU4,TW	0 445 010 205	0 986 437 041	
							EU5,TW	0 445 010 234	0 986 437 086	
CDTI RWD [B]	2,3	74/92/107	M9T 69...				04.10→	EU4	0 445 010 205	0 986 437 041
							EU5	0 445 010 234	0 986 437 086	
				M9T 89...		10.12→	EU4,TW	0 445 010 205	0 986 437 041	
							EU5,TW	0 445 010 234	0 986 437 086	
				TW	0 445 010 250	0 986 437 045				



2.5 DTI [A]	2,5	73-74/84	G9U-7... <ECC99/102A>; G9U-754 <ECC99/102A>				10.01-03.10	0 445 010 033	0 986 437 302	
			74	G9U-650				09.06-09.07	0 445 010 140	0 986 437 033
								10.07-06.10	0 445 010 196	0 986 437 039
			88	G9U-650			08.06-03.10	TW	0 445 010 140	0 986 437 033
									0 445 010 196	0 986 437 039
88/107	G9U-632			08.06-03.10	TW	0 445 010 140	0 986 437 033			
							0 445 010 196	0 986 437 039		

**Vivaro**

1.6 CDTI, CDTI BiTurbo [B]	1,6	66/70/85/88/92/103/107	Mot.-Typ R9M-MA				10.14→	TW	0 445 010 406	0 986 437 071
			Mot.-Typ R9M-MB							
			Mot.-Typ R9M-MC							
			Mot.-Typ R9M-MG							
			Mot.-Typ R9M-MH							
			Mot.-Typ R9M-MD				10.14→	TW	0 445 010 404	0 986 437 070
			Mot.-Typ R9M-ME							
			Mot.-Typ R9M-MJ							
			Mot.-Typ R9M-MK							
1.9 CDTI, DTI [A]	1,9	60/74	F9Q-760; F9Q-762				03.01-08.06	0 445 010 075	0 986 437 301	
2.0 CDTI [A]	2,0	66/84	M9R 6...				12.10-08.14	0 445 010 234	0 986 437 086	
			M9R 78...							
			Mot.-Typ M9R 780				08.06-08.14		0 445 010 099	0 986 437 355
			Mot.-Typ M9R 782				08.06-08.14	TW	0 445 010 170	0 986 437 044
			Mot.-Typ M9R 784							
			Fg.-Nr. →9V611355 →9Y7							
			Mot.-Typ M9R 782				08.06-08.14	TW	0 445 010 223	0 986 437 044
			Mot.-Typ M9R 784							
			Fg.-Nr. 9V611356 → 9Y7 →							
			Mot.-Typ M9R 786				08.06-08.14		0 445 010 205	0 986 437 041
			Mot.-Typ M9R 788							
2.5 CDTI [A]	2,5	84	G9U 630				08.06-06.08	0 445 010 140	0 986 437 033	
		99	G9U-730 <Turbo>				09.02-08.06	0 445 010 033	0 986 437 302	



2.5 CDTi [A]	2,5	107	G9U-630,G9MB6 <Turbo>	08.06-12.07	0 445 010 140	0 986 437 033
				01.08-08.14	0 445 010 196	0 986 437 039

## PAZ PAVLOVO

Serie 3000						
3237	3,9	110	ISBe 150.30 <Euro 3>	01.00→	0 445 020 007	0 986 437 341
-03, -09	4,5	117,7/ 136	4ISBe 160B <Euro 3>; 4ISBe 185B <Euro 3>	06.09→	0 445 020 045	0 986 437 342
Serie 4000						
4230	4,5	136	4ISBe 185B <Euro 3>	06.09→	0 445 020 045	0 986 437 342
4234	4,8	100/110	D 245.9 E3 <Euro 3>; D 245.9 E4 <Euro 4>	01.08→	0 445 020 088	
Serie 32000						
32053	4,8	100/110	D 245.9 E3 <Euro 3>; D 245.9 E4 <Euro 2>	01.08→	0 445 020 088	
Serie 320000						
320301 -03	4,5	136	4ISBe 185B <Euro 3>	06.09→	0 445 020 045	0 986 437 342

## PEUGEOT

Boxer						
2.0 HDi [U3]	2,0	62	RHV <DW10TD>	09.01-02.02	0 445 010 046	0 986 437 017
HDi [U5]	2,0	62	RHV <DW10TD>	02.02-05.06	0 445 010 046	0 986 437 017
2.2 HDi [U5]	2,2	74	4HY <DW12TED>	02.02-12.06	0 445 010 046	0 986 437 017
2.8 HDi [U3]	2,8	94	8140.43S	09.00-02.02	0 445 020 002	0 986 437 501
HDi [U5]	2,8	94	8140.43S	02.02-05.06	0 445 020 002	0 986 437 501
		107	8140 43N <SOFIM 2800 HDi>	08.04-05.06	0 445 020 006	0 986 437 502
HDi	2,8	93	8140.43S	09.05-09.09	0 445 020 002	0 986 437 501
3.0 HDi [U9]	3,0	107/115/ 130	F1CE3481... <30 DT PEF EURO5 155>; F1CE3481E <30 DT PEF EURO5 175>; F1CE3481N <30 DT PEF EURO5 145>	01.10→	0 445 010 559	0 986 437 437
		116	F1CE0481D <SOFIM F 30DT/PEF>			
			Mot.-Nr. →980091	06.06-12.11	0 445 020 046	0 986 437 321
			Mot.-Nr. 980092→	06.06-12.11	0 445 010 559	0 986 437 437



## RENAULT

Kerax						
270	11,1	195	dCI 11 I <Euro 3>			
			Mot.-Nr. →83MO610300	01.01-03.04	0 445 020 012	
			Mot.-Nr. 83MO610301→	04.04-04.06	0 445 020 035	
320	11,1	230	dCI 11 G <Euro 3>			
			Mot.-Nr. →83MO610300	01.01-03.04	0 445 020 012	
			Mot.-Nr. 83MO610301→	04.04-04.06	0 445 020 035	
370	11,1	266	dCI 11 E <Euro 3>			
			Mot.-Nr. →83MO610300	01.01-03.04	0 445 020 012	
			Mot.-Nr. 83MO610301→	04.04-04.06	0 445 020 035	
420	11,1	303	dCI 11 C <Euro 3>			
			Mot.-Nr. →83MO610300	01.01-03.04	0 445 020 012	
			Mot.-Nr. 83MO610301→	04.04-04.06	0 445 020 035	
Mascott						
110	2,8	78	8140.43B.3586/3588	01.01-06.04	0 445 020 002	0 986 437 501
120	3,0	85	DXi 3-120 ZD3 600	05.04-05.07	0 445 010 094	
130	2,8	92	8140.43S.2585; 8140.43S.3585	01.99-06.04	0 445 020 002	0 986 437 501
	3,0	96	DXi 3-130 <ZD30DDTI>	06.07-12.10	0 445 010 136	0 986 437 031
140	2,8	103	8140.43K.2585	01.01-06.04	0 445 020 006	0 986 437 502
150	2,8	107	8140.43N.3585	10.01-06.04	0 445 020 006	0 986 437 502
	3,0	110	DXi 3-150 <ZD30DDTI>	06.07-12.10	0 445 010 136	0 986 437 031
160	3,0	115	DXi 3-160 ZD3 604	05.04-05.07	0 445 010 094	



◀ RENAULT

<b>Master</b>								
2.3 dCi 16V [ADCU]	2,3	96	M9T...		03.12→	TW	0 445 010 205	0 986 437 041
							0 445 010 234	0 986 437 086
2.5 dCi 16V [ADCU]	2,5	85	G9U-724		10.04-02.12		0 445 010 033	0 986 437 302
<b>Master II</b>								
1.9 dCi 80	1,9	60	F9Q 772; F9Q 774		05.00-10.06		0 445 010 075	0 986 437 301
2.2 dCi 90	2,2	66	G9T 720; G9T 722; G9T 750		01.00-10.06		0 445 010 033	0 986 437 302
2.5 dCi 100	2,5	74	G9U 650 (M2) <120BN, Euro 4>		11.06-09.07		0 445 010 140	0 986 437 033
					10.07-04.10		0 445 010 196	0 986 437 039
dCi 100, dCi 110, dCi 120	2,5	73/81/84	G9U 720; G9U 724; G9U 750; G9U 754		05.00-01.10		0 445 010 033	0 986 437 302
dCi 120	2,5	88	G9U 650 (M1) <120BO, Euro 4>		11.06-09.07		0 445 010 140	0 986 437 033
					10.07-04.10		0 445 010 196	0 986 437 039
dCi 120 FAP	2,5	88	G9U 632 (M1) <120BQ, Euro 4>		11.06-09.07		0 445 010 140	0 986 437 033
					10.07-04.10		0 445 010 196	0 986 437 039
dCi 150 FAP	2,5	107	G9U 632 (MY) <Euro 4>		11.06-09.07		0 445 010 140	0 986 437 033
					10.07-04.10		0 445 010 196	0 986 437 039
3.0 dCi 140	3,0	100	ZD3 200 <Euro 3>; ZD3 202 <Euro 3>		10.03-10.06		0 445 010 094	
<b>Master III</b>								
2.3 dCi	2,3	74-92/96-107	M9T 6... <120CG/CH/CK>; M9T 672 <120CA/CB>; M9T 676 <120BX/BY>; M9T 678 <120BZ>; M9T 694 <120CJ>		02.10-12.15		0 445 010 205	0 986 437 041
		74-92/107	M9T...; M9T 69... <120CD/CE/CL>; M9T 670 <120BU/BV>		02.10→		0 445 010 234	0 986 437 086
		92	M9T 876		10.12→		0 445 010 205	0 986 437 041
dCi 100 FWD, dCi 100 RWD, dCi 110, dCi 125 FWD, dCi 125 RWD	2,3	74/81/92	M9T 870; M9T 890		10.12→		0 445 010 250	0 986 437 045
dCi 150 FWD, dCi 150 RWD	2,3	110	M9T 880; M9T 898		10.12→		0 445 010 234	0 986 437 086
<b>Maxity</b>								
150	3,0	110	DXi 3 150 <ZD30DDTI, Euro 4>		03.07-12.11		0 445 010 136	0 986 437 031
<b>Midlum</b>								
150	4,0	112	dCI 4B <Euro 3>		07.01-04.06		0 445 020 024	
180	4,0	128	dCI 4C <Euro 3>		07.01-04.06		0 445 020 024	
210	6,2	157	dCI 6AE <Euro 3>		07.01-12.05		0 445 020 012	
220 4x2, 4x4	6,2	158/162	dCI 6W <Euro 3>					
			Mot.-Nr. →83MO6605194		07.01-04.06		0 445 020 012	
			Mot.-Nr. 83MO6605195→		07.01-04.06		0 445 020 035	
260	6,2	195	dCI 6AF <Euro 3>		07.01-12.05		0 445 020 012	
270	6,2	195	dCI 6A <Euro 3>					
			Mot.-Nr. →83MO6605194		07.01-04.06		0 445 020 012	
			Mot.-Nr. 83MO6605195→		07.01-04.06		0 445 020 035	
<b>Premium</b>								
220 Distribution	6,2	158	dCI 6W <Euro 3>					
			Mot.-Nr. →83MO6605194		11.00-02.04		0 445 020 012	
			Mot.-Nr. 83MO6605195→		03.04-04.06		0 445 020 035	
270 Distribution, Lander	6,2	195	dCI 6A <Euro 3>					
			Mot.-Nr. →83MO6605194		11.00-02.04		0 445 020 012	
			Mot.-Nr. 83MO6605195→		03.04-04.06		0 445 020 035	
320 Distribution, Lander, Route	11,1	229	dCI 11 G <Euro 3>					
			Mot.-Nr. →83MO610300		01.00-03.04		0 445 020 012	
			Mot.-Nr. 83MO610301→		04.04-04.06		0 445 020 035	
370 Distribution, Lander, Route	11,1	266	dCI 11 E <Euro 3>					
			Mot.-Nr. →83MO610300		01.00-03.04		0 445 020 012	
			Mot.-Nr. 83MO610301→		04.04-04.06		0 445 020 035	
420 Distribution, Lander, Route	11,1	303	dCI 11 C <Euro 3>					
			Mot.-Nr. →83MO610300		11.00-03.04		0 445 020 012	
			Mot.-Nr. 83MO610301→		04.04-04.06		0 445 020 035	
Route	11,1	303	dCI 06.23.56 B43 <Euro 3>		01.00-09.01		0 445 020 012	
<b>Traffic II</b>								
1.9 dCi [EL/FL/JL]	1,9	60/74	F9Q 760; F9Q 762		05.01-12.06		0 445 010 075	0 986 437 301
2.0 dCi [EL/FL/JL]	2,0	66/84	M9R 6...; M9R 630		05.10-12.14		0 445 010 234	0 986 437 086
		66/85	M9R 780		01.06-12.14		0 445 010 099	0 986 437 355
		85	M9R 782		01.06-10.08		0 445 010 170	0 986 437 044
					11.08-12.14		0 445 010 223	0 986 437 044





2.0 dCi [EL/FL/JL]	2,0	85	M9R 786	01.06-12.14	0 445 010 205	0 986 437 041
2.5 dCi [EL/FL/JL]	2,5	84-107	G9U 630	01.06-12.07	0 445 010 140	0 986 437 033
				01.08-12.14	0 445 010 196	0 986 437 039
		98	G9U 730	06.02-12.06	0 445 010 033	0 986 437 302
<b>Trafic III</b>						
1.6 dCi [EG/FG/JG]	1,6	66/85	R9M 408	05.14→	0 445 010 404	0 986 437 070
		70/89	R9M 413	08.15→	0 445 010 404	0 986 437 070
		88/103/107	R9M 450	05.14→	0 445 010 406	0 986 437 071
		92	R9M 452	08.15→	0 445 010 406	0 986 437 071

**TATA (TELCO)**

<b>Marcopolo</b>						
1628 Divo	6,7	210	ISBe 285 <Euro 3>	04.11→	0 445 020 150	0 986 437 342
<b>Prima K</b>						
3138 8x4	8,9	272	CUMISLe_EU3	04.11→	0 445 020 150	0 986 437 342

**TEMSA**

<b>Avenue</b>						
Diesel	6,7	184	ISBe4 250 <Euro 4>	11.08→	0 445 020 150	0 986 437 342
<b>Diamant</b>						
13,14	10,5	324	D 2066 LOH04 <Euro 4>	08.06-08.07	0 445 020 075	0 986 437 350
				09.07→	0 445 020 075	0 986 437 350
		12,4	D 2676 LOH	10.06→	0 445 020 075	0 986 437 350
<b>Diamond</b>						
14	12,4	353	D 2676 LOH	10.10→	0 445 020 090	0 986 437 383
<b>MD</b>						
9	6,9	184/213	D 0836 LOH64 <Euro 5>; D 0836 LOH65 <Euro 5/EEV>	10.10→	0 445 020 206	0 986 437 359
<b>MD 9</b>						
6.9	6,9	213	D 0836 LOH72 <Euro 6>	06.14→ TW	0 445 020 206	0 986 437 359
<b>Metropol</b>						
	6,9	177	D 0836 LOH52 <Euro 4/OBD1>	01.07-10.09 EXW	0 445 020 060	0 986 437 352
<b>Opalin</b>						
8	4,6	152	D0834 LFL51/52 <Euro 4>	01.07→ EXW	0 445 020 060	0 986 437 352
9	6,9	176/177	D 0836 LOH52 <Euro 4>; D 0836 LOH56 <Euro 4/OBD1>	09.05→ EXW	0 445 020 060	0 986 437 352
		184	D 0836 LOH65 <Euro 5/EEV>	11.09→	0 445 020 206	0 986 437 359
<b>Powerbus</b>						
	4,6	152	D 0834 LFL51 <Euro 4/OBD1>	02.07→ EXW	0 445 020 060	0 986 437 352
<b>Prestij</b>						
	3,0	107	4M42 <Euro 4>	01.10→	0 445 020 049	
<b>Safari</b>						
12,13 [RD]	10,5	265	D 2066 LOH06 <Euro 4/OBD1>	02.07→	0 445 020 075	0 986 437 350

**TONAR**

<b>24t</b>						
5422	11,1	303	650.10 <Euro 3>	01.10→	0 445 020 086	
6428	11,1	303	650.10 <Euro 3>	01.10→	0 445 020 086	
6528	11,1	303	650.10 <Euro 3>	01.10→	0 445 020 086	







**URAL AUTOMOBIL PLANT**

<b>18t</b>						
6367-31	11,1	266	6501.10 <Euro 3>		12.09→	0 445 020 086
<b>29t</b>						
6470	11,1	303	650 DCi 11 <Euro 3>		01.08→	0 445 020 086
<b>33t</b>						
63621	11,1	303	650.10 <Euro 3>		01.08→	0 445 020 086
65685	11,1	303	650 DCi 11 <Euro 3>		01.08→	0 445 020 086
<b>41t</b>						
6563	11,1	303	650 DCi 11 <Euro 3>		01.08→	0 445 020 086

**VAUXHALL**

<b>Movano</b>						
1.9 DTI [A]	1,9	60	F9Q-772		10.01-10.05	0 445 010 075 0 986 437 301
			F9Q-774		10.01-10.05 TW	0 445 010 075 0 986 437 301
2.2 DTI [A]	2,2	66	G9T-720; G9T-722; G9T-750		01.01-10.05	0 445 010 033 0 986 437 302
2.3 CDTI FFW [B]	2,3	81	M9T 870		06.14→	0 445 010 250 0 986 437 045
			CDTI FWD [B]	2,3	74	M9T 87...
						EU5,TW 0 445 010 234 0 986 437 086
						TW 0 445 010 250 0 986 437 045
		74/92	M9T 67...		04.10→	EU4 0 445 010 205 0 986 437 041
						EU5 0 445 010 234 0 986 437 086
		92/107	M9T 6...		04.10→	EU4 0 445 010 205 0 986 437 041
						EU5 0 445 010 234 0 986 437 086
			M9T 8...		10.12→	EU4,TW 0 445 010 205 0 986 437 041
						EU5,TW 0 445 010 234 0 986 437 086
						TW 0 445 010 250 0 986 437 045
CDTI RWD [B]	2,3	74/92/107	M9T 69...		04.10→	EU4 0 445 010 205 0 986 437 041
						EU5 0 445 010 234 0 986 437 086
					10.12→	EU4,TW 0 445 010 205 0 986 437 041
			M9T 89...			EU5,TW 0 445 010 234 0 986 437 086
						TW 0 445 010 250 0 986 437 045
2.5 DTI [A]	2,5	74-84	G9U 7...; G9U-75... <Turbo>; G9U-724 <Turbo>		10.01-03.10	0 445 010 033 0 986 437 302
		74-88/107	G9U-6... <Turbo>; G9U-632 <Turbo>		08.06-03.10	0 445 010 140 0 986 437 033
<b>Vivara</b>						
1.6 CDTI [B]	1,6	70/92	R9M	Mot.-Typ R9M-MA	11.15→	TW 0 445 010 406 0 986 437 071
				Mot.-Typ R9M-MB		
				Mot.-Typ R9M-MC		
				Mot.-Typ R9M-MG		
				Mot.-Typ R9M-MH		
				Mot.-Typ R9M-MD	11.15→	TW 0 445 010 404 0 986 437 070
				Mot.-Typ R9M-ME		
Mot.-Typ R9M-MJ						
Mot.-Typ R9M-MK						
<b>Vivaro</b>						
1.6 CDTI [B]	1,6	66/85/88/103/107	R9M	Mot.-Typ R9M-MA	10.14→	TW 0 445 010 406 0 986 437 071
				Mot.-Typ R9M-MB		
				Mot.-Typ R9M-MC		
				Mot.-Typ R9M-MG		
				Mot.-Typ R9M-MH		
				Mot.-Typ R9M-MD	10.14→	TW 0 445 010 404 0 986 437 070
				Mot.-Typ R9M-ME		
Mot.-Typ R9M-MJ						
Mot.-Typ R9M-MK						
1.9 DI, DTI [A]	1,9	59-60/74	F9Q-760; F9Q-762		03.01-08.06	0 445 010 075 0 986 437 301





2.0 CDTI [A]	2,0	66/84	M9R 6...	12.10-08.14	0 445 010 234	0 986 437 086	
			M9R 78...				
			Mot.-Typ M9R 780	08.06-08.14	0 445 010 099	0 986 437 355	
			Mot.-Typ M9R 782	08.06-08.14 TW	0 445 010 170	0 986 437 044	
			Mot.-Typ M9R 784				
			Fg.-Nr. →9V611355 →9Y7				
			Mot.-Typ M9R 782	08.06-08.14 TW	0 445 010 223	0 986 437 044	
			Mot.-Typ M9R 784				
2.5 CDTI [A]	2,5	84	G9U 630				
			Fg.-Nr. →8V623098	08.06-06.08	0 445 010 140	0 986 437 033	
			Mot.-Typ 630				
			Fg.-Nr. →8Y724919				
			Fg.-Nr. 8V623099→	08.06-06.08	0 445 010 196	0 986 437 039	
			Mot.-Typ 630				
			Fg.-Nr. 8Y724920→				
			Mot.-Typ 730	08.06-06.08	0 445 010 033	0 986 437 302	
DTI [A]	2,5	99	G9U 630	08.06-12.07	0 445 010 140	0 986 437 033	
			G9U 630	01.08-08.14	0 445 010 196	0 986 437 039	
			G9U-730 <Turbo>	04.04-08.06	0 445 010 033	0 986 437 302	

## VW (VOLKSWAGEN)

## California T5

2.0 TDI, TDI 4Motion [7E]	2,0	62/75/84/100/103/132	CAAA <D54>; CAAB <D55>; CAAC <D94>; CAAD <DK3>; CAEE <D94>; CCHA <D91>; CCHB <D94>; CFCA <D49>	09.09-08.15	0 445 010 541	0 986 437 433
---------------------------	-----	----------------------	--	-------------	---------------	---------------

## California T6

2.0 TDI, TDI 4Motion [SG]	2,0	75/103/132	CAAB <D55>; CAAC <D94>; CFCA <D49>	04.15→	0 445 010 541	0 986 437 433
---------------------------	-----	------------	------------------------------------	--------	---------------	---------------

## Caravelle T5

2.0 TDI, TDI 4Motion [7E]	2,0	62/75/84/100/103/132	CAAA <D54>; CAAB <D55>; CAAC <D94>; CAAD <DK3>; CAEE <D94>; CCHA <D91>; CCHB <D94>; CFCA <D49>	09.09-08.15	0 445 010 541	0 986 437 433
---------------------------	-----	----------------------	--	-------------	---------------	---------------

## Caravelle T6

2.0 TDI, TDI 4Motion [SG]	2,0	62/75/103/132	CAAA <D54>; CAAB <D55>; CAAC <D94>; CFCA <D49>	04.15→	0 445 010 541	0 986 437 433
---------------------------	-----	---------------	--	--------	---------------	---------------

## Crafter 30

2.0 BitDI, TDI [2E, 2F]	2,0	80/84/103/120	CSLA <DK2>; CSLB <DK3>; CSLC <D91>; CSNA	10.13-12.16	0 445 010 583	0 986 437 440
		80/100/105/120	CKTB <DK2>; CKTC <D94>; CKUB <D92>; CKUC <D46>	05.11-12.16	0 445 010 565	0 986 437 405
2.5 TDI [2E, 2F]	2,5	65/80/100/120	BJJ <D5K>; BJK <D5L>; BJL <D5M>; BJM <D5N>; CEBA <D5K>; CEBB <D5L>; CECA <D5M>; CECB <D5N>	04.06-05.13	0 445 010 343	0 986 437 348

## Crafter 35

2.0 BitDI, TDI [2E, 2F]	2,0	80/84/103/120	CSLA <DK2>; CSLB <DK3>; CSLC <D91>; CSNA	05.13-12.16	0 445 010 583	0 986 437 440
		80/100/105/120	CKTB <DK2>; CKTC <D94>; CKUB <D92>; CKUC <D46>	05.11-12.16	0 445 010 565	0 986 437 405
2.5 TDI [2E, 2F]	2,5	65/80/100/120	BJJ <D5K>; BJK <D5L>; BJL <D5M>; BJM <D5N>; CEBA <D5K>; CEBB <D5L>; CECA <D5M>; CECB <D5N>	04.06-05.13	0 445 010 343	0 986 437 348

## Crafter 50

2.0 BitDI, TDI [2E, 2F]	2,0	80/84/103/120	CSLA <DK2>; CSLB <DK3>; CSLC <D91>; CSNA	10.13-12.16	0 445 010 583	0 986 437 440
		80/100/105/120	CKTB <DK2>; CKTC <D94>; CKUB <D92>; CKUC <D46>	05.11-12.16	0 445 010 565	0 986 437 405
2.5 TDI [2E, 2F]	2,5	80/100/120	BJJ <D5L>; BJL <D5M>; BJM <D5N>; CEBA <D5K>; CEBB <D5L>; CECA <D5M>; CECB <D5N>	04.06-05.13	0 445 010 343	0 986 437 348





◀ VW

LT						
28	2.8 TDI [2D, 2H]	2,8	116	AUH; BCQ	02.02-04.06	<b>0 445 010 044</b>
35	2.8 TDI [2D, 2H]	2,8	116	AUH; BCQ	02.02-04.06	<b>0 445 010 044</b>
46	2.8 TDI [2D, 2H]	2,8	116	AUH	02.02-04.06	<b>0 445 010 044</b>
Multivan T5						
2.0	TDI, TDI 4Motion [7E]	2,0	62/75/84/100/103/132	CAAA <D54>; CAAB <D55>; CAAC <D94>; CAAD <DK3>; CAAE <D94>; CCHA <D91>; CCHB <D94>; CFCA <D49>	09.09-08.15	<b>0 445 010 541 0 986 437 433</b>
Multivan T6						
2.0	TDI, TDI 4Motion [SG]	2,0	75/103/132	CAAB <D55>; CAAC <D94>; CFCA <D49>	04.15→	<b>0 445 010 541 0 986 437 433</b>
	TDI 4Motion [SSG]	2,0	103	CAAC <D94>	04.15→	<b>0 445 010 541 0 986 437 433</b>
Transporter T5						
2.0	TDI, TDI 4Motion [7E]	2,0	62/75/84/100/103/132	CAAA <D54>; CAAB <D55>; CAAC <D94>; CAAD <DK3>; CAAE <D94>; CCHA <D91>; CCHB <D94>; CFCA <D49>	09.09-08.15	<b>0 445 010 541 0 986 437 433</b>
	TDI, TDI 4Motion [7F]	2,0	62/75/84/100/103/132	CAAA <D54>; CAAB <D55>; CAAC <D94>; CAAD <DK3>; CAAE <D94>; CCHA <D91>; CCHB <D94>; CFCA <D49>	09.09-08.15	<b>0 445 010 541 0 986 437 433</b>
Transporter T6						
2.0	TDI, TDI 4Motion [SF]	2,0	62/75/103/132	CAAA <D54>; CAAB <D55>; CAAC <D94>; CFCA <D49>	04.15→	<b>0 445 010 541 0 986 437 433</b>
	TDI, TDI 4Motion [SG]	2,0	62/75/103/132	CAAA <D54>; CAAB <D55>; CAAC <D94>; CFCA <D49>	04.15→	<b>0 445 010 541 0 986 437 433</b>

**ZIL**

4331						
433185		7,1	169	D 260.5 E3 <Euro 3>	05.08→	<b>0 445 020 087</b>
4334						
4334B1		4,8	115	D 245.30 E3 <Euro 3>	05.08→	<b>0 445 020 088</b>
5301						
5301EE		4,8	96	D 245.9 E3 <Euro 3>	01.10→	<b>0 445 020 088</b>





## CASE

Serie 21F						
521F	4,5	106	F4HFE413A <Tier 2>; F4HFE413J <Tier 4b>	01.08→	0 445 020 175	0 986 437 341
621F	6,7	128	F4HFE613Y <Tier 2>; F4HFE613Y <Tier 3>; F4HFE613Y <Tier 4a>	01.12-12.14	0 445 020 175	0 986 437 341
721F	6,7	145	F4HFE613T <Tier 4b>; F4HFE613Y <Tier 2>; F4HFE613Y <Tier 3>; F4HFE613Y <Tier 4a>	03.11→	0 445 020 175	0 986 437 341
821F	6,7	172	F4HFE613S <Tier 4b>; F4HFE613X <Tier 2>; F4HFE613X <Tier 3>; F4HFE613X <Tier 4a>	01.11→	0 445 020 175	0 986 437 341
921F	6,7	190	F4HFE613R <Tier 4b>; F4HFE613X <Tier 2>; F4HFE613X <Tier 4a>	09.10→	0 445 020 175	0 986 437 341
1021F	8,7	239	F2CFE614B <Tier 2>; F2CFE614B <Tier 4a>	04.10-11.16	0 445 020 093	0 986 437 389
1121F	8,7	259	F2CFE614B <Tier 2>; F2CFE614B <Tier 4a>	03.10-12.14	0 445 020 093	0 986 437 389
Serie 800						
885 B	6,7	164-175	F4HFE613X <Tier 3>	12.10→	0 445 020 223	
SN						
580	4,5	71	445TA <Tier 3>	03.12→	0 445 020 175	0 986 437 341
590	4,5	81	445TA <Tier 3>	03.12→	0 445 020 175	0 986 437 341
SR						
220	3,4	61	F5HFL413A <Tier 4>	01.13-12.14	0 445 020 516	
250	3,4	67	F5HFL413A <Tier 4>	07.12-03.16	0 445 020 516	
580	4,5	71	445TA <Tier 3>	03.08-12.10	0 460 424 424	
ST						
580	4,5	71	445TA <Tier 3>	10.10→	0 445 020 175	0 986 437 341
590	4,5	81	445TA <Tier 3>	10.10→	0 445 020 175	0 986 437 341
695	4,5	81	445TA <Tier 3>	10.10→	0 445 020 175	0 986 437 341
SV						
250	3,4	61	F5HFL413A <Tier 4>	01.13→	0 445 020 516	
300	3,4	67	F5H <Stage 3b/Tier 4f>	09.15→	0 445 020 516	
T						
580	4,5	71	445TA <Tier 3>	10.10→	0 460 424 424	
TR						
320	3,4	67	F5HFL413A <Tier 4>	07.12-09.16	0 445 020 516	
TV						
380	3,4	66	F5H <Stage 3b/Tier 4f>	09.15→	0 445 020 516	

## FENDT

Serie C						
5270	7,4	199	74 CTA	09.06-12.11	0 445 020 054	0 986 437 384
5275	7,4	202	74 AWF <Stage 4/Tier 4>	09.14→	0 445 020 611	
			74 AWI <Stage 3b/Tier 4>	09.10-12.14	0 445 020 610	
6300	8,4	224	84 CTA	09.06-12.11	0 445 020 054	0 986 437 384
6335	8,4	247	84 AWI <Stage 3b/Tier 4>	09.10-12.14	0 445 020 610	
		247-265	84 AWF <Stage 4/Tier 4>	09.12→	0 445 020 611	
Serie E						
5185	4,9	125	49 AWF <Stage 4/Tier 4>	09.15→	0 445 020 611	
5220	6,6	162	66 AWI <Stage 3b/Tier 4>	09.11-12.15	0 445 020 610	
5225	7,4	166	74 AWF <Stage 4/Tier 4>	09.15→	0 445 020 611	
Serie L						
5255	6,6	188	66 AWI <Stage 3b/Tier 4>	09.10-12.14	0 445 020 610	
	7,4	179-188	74 AWF <Stage 4/Tier 4>	09.14→	0 445 020 611	
6270	7,4	199	74 CTA	09.14→	0 445 020 054	0 986 437 384
6275	7,4	202	74 AWF <Stage 4/Tier 4>	09.14→	0 445 020 611	
			74 AWI <Stage 3b/Tier 4>	09.10-12.14	0 445 020 610	
Serie P						
8370	8,4	272	84 CTA	09.07-12.11	0 445 020 054	0 986 437 384
		275	84 AWI <Stage 3b/Tier 4>	09.10-12.13	0 445 020 610	
8380	8,4	279	84 AWF <Stage 4/Tier 4>	09.12→	0 445 020 611	





◀ FENDT

8400	8,4	297	84 AWI <Stage 3b/Tier 4> 84 CTA	09.10-12.13 09.07-12.11	0 445 020 610 0 445 020 054	0 986 437 384
8410	8,4	297	84 AWF <Stage 4/Tier 4>	09.12→	0 445 020 611	
<b>Serie R</b>						
9300	8,4	221	84 CTA	09.08-12.12	0 445 020 054	0 986 437 384
9350	8,4	258	84 CTA	09.08-12.12	0 445 020 054	0 986 437 384
9390	8,4	287	84 AWI <Stage 3b/Tier 4>	09.08-12.12	0 445 020 610	
9480	9,8	353	98 ATI	09.08-12.12	0 445 020 610	
<b>Serie X</b>						
9470	9,8	346	98 ATI 98 CTA	09.09-12.13 09.09-12.13	0 445 020 610 0 445 020 054	0 986 437 384
9490	9,8	365	98 AWF <Stage 4/Tier 4>	09.12→	0 445 020 611	
<b>Serie 200 Vario</b>						
207	3,3	52,2	33CTA Fg.-Nr. →2999 Fg.-Nr. 3000→	09.10→ 09.10→	0 445 020 056 0 445 020 512	
208	3,3	60	33CTA Fg.-Nr. →2999 Fg.-Nr. 3000→	09.10→ 09.10→	0 445 020 056 0 445 020 512	
209	3,3	67	33CTA Fg.-Nr. →2999 Fg.-Nr. 3000→	09.10→ 09.10→	0 445 020 056 0 445 020 512	
210	3,3	73	33CTA Fg.-Nr. →2999 Fg.-Nr. 3000→	09.10→ 09.10→	0 445 020 056 0 445 020 512	
211	3,3	74-81	33CTA Fg.-Nr. →2999 Fg.-Nr. 3000→	09.10→ 09.10→	0 445 020 056 0 445 020 512	
<b>Serie 8000</b>						
8300	8,4	224 258	84 CTA 84 AWF <Stage 4/Tier 4>	09.07-12.12 09.12→	0 445 020 054 0 445 020 611	0 986 437 384
8350	8,4	258	84 AWF <Stage 4/Tier 4> 84 CTA	09.12→ 09.07-12.12	0 445 020 611 0 445 020 054	0 986 437 384



**KOMATSU**

<b>BR-Serie</b>							
380JG-1E0	6,7	140-149	SAA6D107 Fg.-Nr. 2616→2001→ Mot.-Nr. 26546230→26500006→	06.13→	TW	0 445 020 109 0 445 020 122	0 986 437 375 0 986 437 310
<b>D-Serie</b>							
31	3,3	58-60	SAA4D95LE-5 Fg.-Nr. 60001→Mot.-Nr. 503228→	05.14→		0 445 020 070	0 986 437 082
37	3,3	66-68	SAA4D95LE-5 Fg.-Nr. 60001→Mot.-Nr. 503228→	05.14→		0 445 020 070	0 986 437 082
39EX-22	4,5	79	SAA4D107 Fg.-Nr. 3001→Mot.-Nr. 26513014→	01.13→	TW	0 445 020 109 0 445 020 122	0 986 437 375 0 986 437 310
39PX-22	4,5	79	SAA4D107 Fg.-Nr. 3001→Mot.-Nr. 26513014→	01.13→	TW	0 445 020 109 0 445 020 122	0 986 437 375 0 986 437 310
<b>GD-Serie</b>							
555-5	6,7	144-146	SAA6D107 Fg.-Nr. 55001→Mot.-Nr. 26540713→	08.11→	TW	0 445 020 109 0 445 020 122	0 986 437 375 0 986 437 310
655-5	6,7	163-165	SAA6D107 Fg.-Nr. 55001→B40001→ Mot.-Nr. 26540705→ Fg.-Nr. 55001→Mot.-Nr. 26540705→	04.14→ 04.14→	TW TW	0 445 020 109 0 445 020 122	0 986 437 375 0 986 437 310



HB-Serie									
<b>205-1</b>	4,5	104-110	SAA4D107						
			Fg.-Nr. 1001→10001→	03.11→	TW	<b>0 445 020 122</b>	<b>0 986 437 310</b>		
			Mot.-Nr. 102262→26554518→						
			Fg.-Nr. 1001→10001→	03.11→	TW	<b>0 445 020 109</b>	<b>0 986 437 375</b>		
			Mot.-Nr. 26554518→102262→						
<b>215LC-1</b>	4,5	104-110	SAA4D107						
			Fg.-Nr. 1001→10001→	03.11→	TW	<b>0 445 020 122</b>	<b>0 986 437 310</b>		
			Mot.-Nr. 102262→26554518→						
			Fg.-Nr. 1001→10001→	03.11→	TW	<b>0 445 020 109</b>	<b>0 986 437 375</b>		
			Mot.-Nr. 26554518→102262→						
PC-Serie									
<b>70-8</b>	3,3	48-50	SAA4D95LE-5						
			Fg.-Nr. 10011→Mot.-Nr. 500001→	06.11→		<b>0 445 020 070</b>	<b>0 986 437 082</b>		
<b>78-8</b>	3,3	41-42	SAA4D95LE-5						
			Fg.-Nr. 15001→Mot.-Nr. 504574→	10.08→		<b>0 445 020 070</b>	<b>0 986 437 082</b>		
<b>88MR-8</b>	3,3	49-50	SAA4D95LE-5						
			Fg.-Nr. 5001→Mot.-Nr. 502711→	04.13→		<b>0 445 020 070</b>	<b>0 986 437 082</b>		
<b>130-8</b>	3,3	68-72	SAA4D95LE-5						
			Fg.-Nr. 80001→	05.13→		<b>0 445 020 070</b>	<b>0 986 437 082</b>		
			Mot.-Nr. 501795→						
			Fg.-Nr. C30001→						
			Mot.-Nr. 502660→						
			Fg.-Nr. B10001→						
			Mot.-Nr. 26501795→						
<b>138UD-8</b>	3,3	68-72	SAA4D95LE-5						
			Fg.-Nr. 24510→	03.12→		<b>0 445 020 070</b>	<b>0 986 437 082</b>		
			Mot.-Nr. 500001→						
			Fg.-Nr. 20001→24509 20001→						
<b>138USLC-8</b>	3,3	68-72	SAA4D95LE-5						
			Fg.-Nr. 24510→	03.12→		<b>0 445 020 070</b>	<b>0 986 437 082</b>		
			Mot.-Nr. 500001→						
			Fg.-Nr. 20001→24509 20001→						
<b>160LC-8</b>	4,5	86-90	SAA4D107						
			Fg.-Nr. 25001→	08.12→	TW	<b>0 445 020 109</b>	<b>0 986 437 375</b>		
			Mot.-Nr. 26527701→						
			Fg.-Nr. B30001→						
			Mot.-Nr. 36399067→						
			Fg.-Nr. 25001→	08.12→	TW	<b>0 445 020 122</b>	<b>0 986 437 310</b>		
			Mot.-Nr. 26527701→						
			Fg.-Nr. K50001→						
			Mot.-Nr. 21872538→						
			Fg.-Nr. C20001→						
<b>190LC/NLC-8</b>	4,5	92-97	SAA4D107						
			Mot.-Nr. 21872538→	08.12→		<b>0 445 020 122</b>	<b>0 986 437 310</b>		
<b>200F-8</b>	6,7	110-116	SAA6D107						
				02.13→		<b>0 445 020 109</b>	<b>0 986 437 375</b>		
<b>200-JK-8N1</b>	6,7	110-116	SAA6D107						
				02.13→		<b>0 445 020 109</b>	<b>0 986 437 375</b>		
<b>200LC-8</b>	6,7	110-116	SAA6D107						
			Fg.-Nr. 350001→	11.14→	TW	<b>0 445 020 109</b>	<b>0 986 437 375</b>		
			Mot.-Nr. 541137→						
			Fg.-Nr. 315646→						
			Mot.-Nr. 26594007→						
			Fg.-Nr. 400001→310001→315645						
			Mot.-Nr. 26500006→						
			Fg.-Nr. 300001→						
			Fg.-Nr. 350001→	11.14→	TW	<b>0 445 020 122</b>	<b>0 986 437 310</b>		
			Mot.-Nr. 541137→						
			Fg.-Nr. 400001→						
			Mot.-Nr. 26594007→						
			Fg.-Nr. 310001→315645						
			Mot.-Nr. 26500006→						
			Fg.-Nr. 300001→						







◀ KOMATSU

<b>200LC-8E0</b>	4,5	86-90	SAA4D107 Fg.-Nr. 1001→1118→ Mot.-Nr. 541103→26503098→	01.08→		<b>0 445 020 109</b>	<b>0 986 437 375</b>
						<b>0 445 020 122</b>	<b>0 986 437 310</b>
<b>200LC-8M0</b>	6,7	103-110	SAA6D107	12.15→	TW	<b>0 445 020 109</b>	<b>0 986 437 375</b>
						<b>0 445 020 122</b>	<b>0 986 437 310</b>
<b>200-8</b>	6,7	110-116	SAA6D107 Fg.-Nr. 350001→ Mot.-Nr. 541137→ Fg.-Nr. 315646→ Mot.-Nr. 26594007→ Fg.-Nr. 400001→310001→315645 Mot.-Nr. 26500006→ Fg.-Nr. 300001→	11.14→	TW	<b>0 445 020 109</b>	<b>0 986 437 375</b>
			Fg.-Nr. 350001→ Mot.-Nr. 541137→ Fg.-Nr. 400001→ Mot.-Nr. 26594007→ Fg.-Nr. 310001→315645 Mot.-Nr. 26500006→ Fg.-Nr. 300001→	11.14→	TW	<b>0 445 020 122</b>	<b>0 986 437 310</b>
<b>200-8E0</b>	4,5	86-90	SAA4D107 Fg.-Nr. 1001→1118→ Mot.-Nr. 541103→26503098→	01.08→		<b>0 445 020 109</b>	<b>0 986 437 375</b>
						<b>0 445 020 122</b>	<b>0 986 437 310</b>
<b>200-8M0</b>	6,7	103-110	SAA6D107	12.15→	TW	<b>0 445 020 109</b>	<b>0 986 437 375</b>
						<b>0 445 020 122</b>	<b>0 986 437 310</b>
<b>220LC-8</b>	6,7	125-134	SAA6D107 Fg.-Nr. 85001→ Mot.-Nr. 26542663→ Fg.-Nr. 80377→ Mot.-Nr. 26598590→ Fg.-Nr. 100001→ Mot.-Nr. 26500006→ Fg.-Nr. 80001→70001→A88001→	06.13→	TW	<b>0 445 020 109</b>	<b>0 986 437 375</b>
			Fg.-Nr. 85001→ Mot.-Nr. 26542663→ Fg.-Nr. 80377→ Mot.-Nr. 26598590→ Fg.-Nr. 100001→ Mot.-Nr. 26500006→ Fg.-Nr. 80001→70001→	06.13→	TW	<b>0 445 020 122</b>	<b>0 986 437 310</b>
<b>220LC-8M0</b>	6,7	123-129	SAA6D107 Fg.-Nr. 85001→ Mot.-Nr. 26542663→ Fg.-Nr. 80377→ Mot.-Nr. 26598590→ Fg.-Nr. 100001→ Mot.-Nr. 26500006→ Fg.-Nr. 80001→70001→A88001→	09.14→	TW	<b>0 445 020 109</b>	<b>0 986 437 375</b>
			Fg.-Nr. 85001→ Mot.-Nr. 26542663→ Fg.-Nr. 80377→ Mot.-Nr. 26598590→ Fg.-Nr. 100001→ Mot.-Nr. 26500006→ Fg.-Nr. 80001→70001→	09.14→	TW	<b>0 445 020 122</b>	<b>0 986 437 310</b>





<b>220-8</b>	6,7	125-134	SAA6D107	Fg.-Nr. 85001→	06.13→	TW	<b>0 445 020 109</b>	<b>0 986 437 375</b>
				Mot.-Nr. 26542663→				
				Fg.-Nr. 80377→				
				Mot.-Nr. 26598590→				
				Fg.-Nr. 100001→				
				Mot.-Nr. 26500006→				
				Fg.-Nr. 80001→70001→A88001→				
				Fg.-Nr. 85001→	06.13→	TW	<b>0 445 020 122</b>	<b>0 986 437 310</b>
				Mot.-Nr. 26542663→				
				Fg.-Nr. 80377→				
				Mot.-Nr. 26598590→				
				Fg.-Nr. 100001→				
				Mot.-Nr. 26500006→				
				Fg.-Nr. 800001→70001→				
<b>220-8M0</b>	6,7	123-129	SAA6D107	Fg.-Nr. 85001→	09.14→	TW	<b>0 445 020 109</b>	<b>0 986 437 375</b>
				Mot.-Nr. 26542663→				
				Fg.-Nr. 80377→				
				Mot.-Nr. 26598590→				
				Fg.-Nr. 100001→				
				Mot.-Nr. 26500006→				
				Fg.-Nr. 80001→70001→A88001→				
				Fg.-Nr. 85001→	09.14→	TW	<b>0 445 020 122</b>	<b>0 986 437 310</b>
				Mot.-Nr. 26542663→				
				Fg.-Nr. 80377→				
				Mot.-Nr. 26598590→				
				Fg.-Nr. 100001→				
				Mot.-Nr. 26500006→				
				Fg.-Nr. 800001→70001→				
<b>228USCL-8</b>	6,7	110-116	SAA6D107	Fg.-Nr. 50001→ Mot.-Nr. 26547615→	09.13→	TW	<b>0 445 020 109</b>	<b>0 986 437 375</b>
							<b>0 445 020 122</b>	<b>0 986 437 310</b>
<b>228USLC-3E0</b>	6,7	110-116	SAA6D107	Fg.-Nr. 40001→ Mot.-Nr. 26500006→	04.08→	TW	<b>0 445 020 109</b>	<b>0 986 437 375</b>
							<b>0 445 020 122</b>	<b>0 986 437 310</b>
<b>228US-3E0</b>	6,7	110-116	SAA6D107	Fg.-Nr. 40001→ Mot.-Nr. 26500006→	04.08→	TW	<b>0 445 020 109</b>	<b>0 986 437 375</b>
							<b>0 445 020 122</b>	<b>0 986 437 310</b>
<b>228US-8</b>	6,7	110-116	SAA6D107	Fg.-Nr. 50001→ Mot.-Nr. 26547615→	09.13→	TW	<b>0 445 020 109</b>	<b>0 986 437 375</b>
							<b>0 445 020 122</b>	<b>0 986 437 310</b>
<b>240LC-8</b>	6,7	125-134	SAA6D107	Fg.-Nr. B10001→ Mot.-Nr. 26542663→	09.10→	TW	<b>0 445 020 109</b>	<b>0 986 437 375</b>
							<b>0 445 020 122</b>	<b>0 986 437 310</b>
<b>270LC-8</b>	6,7	140-149	SAA6D107	Fg.-Nr. 30117→	07.08→	TW	<b>0 445 020 122</b>	<b>0 986 437 310</b>
				Mot.-Nr. 26537659→				
				Fg.-Nr. 30001→30116				
				Mot.-Nr. 26500006→				
				Fg.-Nr. 20001→				
				Fg.-Nr. 30117→	07.08→	TW	<b>0 445 020 109</b>	<b>0 986 437 375</b>
				Mot.-Nr. 26537659→				
				Fg.-Nr. 30001→30116				
				Mot.-Nr. 26500006→				
				Fg.-Nr. 20001→A87001→				





◀ KOMATSU

<b>270LC-8N1-W1</b>	6,7	140-149	SAA6D107					
			Fg.-Nr. 30117→	09.13→	TW	<b>0 445 020 122</b>	<b>0 986 437 310</b>	
			Mot.-Nr. 26537659→					
			Fg.-Nr. 30001→30116					
			Mot.-Nr. 26500006→					
			Fg.-Nr. 20001→					
			Fg.-Nr. 30117→	09.13→	TW	<b>0 445 020 109</b>	<b>0 986 437 375</b>	
			Mot.-Nr. 26537659→					
			Fg.-Nr. 30001→30116					
			Mot.-Nr. 26500006→					
			Fg.-Nr. 20001→A87001→					
<b>270LC-8-W1</b>	6,7	140-149	SAA6D107					
			Fg.-Nr. 20001→	09.13→		<b>0 445 020 109</b>	<b>0 986 437 375</b>	
			Mot.-Nr. 26500006→					
<b>270-8</b>	6,7	140-149	SAA6D107					
			Fg.-Nr. 30117→	07.08→	TW	<b>0 445 020 122</b>	<b>0 986 437 310</b>	
			Mot.-Nr. 26537659→					
			Fg.-Nr. 30001→30116					
			Mot.-Nr. 26500006→					
			Fg.-Nr. 20001→					
			Fg.-Nr. 30117→	07.08→	TW	<b>0 445 020 109</b>	<b>0 986 437 375</b>	
			Mot.-Nr. 26537659→					
			Fg.-Nr. 30001→30116					
			Mot.-Nr. 26500006→					
			Fg.-Nr. 20001→A87001→					
<b>380USLC-3E0</b>	6,7	140-149	SAA6D107					
			Fg.-Nr. 30242→ Mot.-Nr. 537218→	03.13→	TW	<b>0 445 020 109</b>	<b>0 986 437 375</b>	
						<b>0 445 020 122</b>	<b>0 986 437 310</b>	
<b>WA-Serie</b>								
<b>150-6</b>	3,3	73-74	SAA4D95LE-5					
			Fg.-Nr. 80001→ Mot.-Nr. 506848→	02.09→		<b>0 445 020 070</b>	<b>0 986 437 082</b>	
<b>200PZ-6</b>	4,5	94-95	SAA4D107					
				11.07→	TW	<b>0 445 020 109</b>	<b>0 986 437 375</b>	
						<b>0 445 020 122</b>	<b>0 986 437 310</b>	
<b>200-6</b>	4,5	94-95	SAA4D107					
			Fg.-Nr. 70001→	06.15→	TW	<b>0 445 020 122</b>	<b>0 986 437 310</b>	
			Mot.-Nr. 26508146→					
			Fg.-Nr. 70883→					
			Mot.-Nr. 26537379→					
			Fg.-Nr. C10001→					
			Mot.-Nr. 26503098→					
			Fg.-Nr. 70001→70882					
			H00051→ 70136→70342					
			Fg.-Nr. 70001→70882 70136→70342	06.15→	TW	<b>0 445 020 109</b>	<b>0 986 437 375</b>	
			Mot.-Nr. 26503098→					
<b>250PZ-6</b>	6,7	104	SAA6D107					
			Fg.-Nr. 75053→	02.13→	TW	<b>0 445 020 109</b>	<b>0 986 437 375</b>	
			Mot.-Nr. 26506237→					
			Fg.-Nr. 75750→					
			Mot.-Nr. 26500006→					
			Fg.-Nr. 75001→ 75001→75749					
			Fg.-Nr. 75750→	02.13→	TW	<b>0 445 020 122</b>	<b>0 986 437 310</b>	
			Mot.-Nr. 26506237→					
			Fg.-Nr. 75053→					
			Mot.-Nr. 26500006→					
			Fg.-Nr. 75001→75749 75001→					
			H00051→ 75160→75467					





250-6	6,7	103-104	SAA6D107					
			Fg.-Nr. 75053→ Mot.-Nr. 26506237→ Fg.-Nr. 75750→ Mot.-Nr. 26500006→ Fg.-Nr. 75001→75001→75749	03.13→	TW	0 445 020 109	0 986 437 375	
			Fg.-Nr. 75750→ Mot.-Nr. 26506237→ Fg.-Nr. 75053→ Mot.-Nr. 26500006→ Fg.-Nr. 75001→75749 75001→ H00051→75160→75467	03.13→	TW	0 445 020 122	0 986 437 310	
320PZ-6	6,7	125-127	SAA6D107					
			Fg.-Nr. 70291→ Mot.-Nr. 26534228→ Fg.-Nr. 70452→ Mot.-Nr. 26500006→ Fg.-Nr. 70001→70290 70001→70451 H00059→H00256 H62051→	02.13→	TW	0 445 020 122	0 986 437 310	
			Fg.-Nr. 70291→ Mot.-Nr. 26534228→ Fg.-Nr. 70452→ Mot.-Nr. 26500006→ Fg.-Nr. 70001→70451 70001→70290 H00059→H00256 H62051→	02.13→		0 445 020 109	0 986 437 375	
320-6	6,7	125-127	SAA6D107					
			Fg.-Nr. 70291→ Mot.-Nr. 26534228→ Fg.-Nr. 70452→ Mot.-Nr. 26500006→ Fg.-Nr. 70001→70290 70001→70451 H00059→H00256 H62051→	02.13→	TW	0 445 020 122	0 986 437 310	
			Fg.-Nr. 70291→ Mot.-Nr. 26534228→ Fg.-Nr. 70452→ Mot.-Nr. 26500006→ Fg.-Nr. 70001→70451 70001→70290 H00059→H00256 H62051→	02.13→		0 445 020 109	0 986 437 375	
3802-6	6,7	141-143	SAA6D107					
				08.12→	TW	0 445 020 109	0 986 437 375	
						0 445 020 122	0 986 437 310	
380-6	6,7	142-143	SAA6D107					
			Fg.-Nr. 65949→66847→ Mot.-Nr. 537463→26580638→ Fg.-Nr. 65001→65948 a Mot.-Nr. 26500006→	02.13→	TW	0 445 020 109	0 986 437 375	
						0 445 020 122	0 986 437 310	



**MASSEY FERGUSON (MF)**

Activa							
7244	6,6	166	66 AWI <Stage 3b/Tier 4>		01.11-12.15	0 445 020 610	
7340	4,9	125	49 AWF <Stage 4/Tier 4>		01.15→	0 445 020 611	
7344	7,4	198	74 AWF <Stage 4/Tier 4>		01.15→	0 445 020 611	
Activa S							
7247	7,4	202	74 CTA		01.08-12.11	0 445 020 054	0 986 437 384
7345/MCS	6,6	175-179	66 AWI <Stage 3b/Tier 4>		01.11-12.14	0 445 020 610	
	7,4	198	74 AWF <Stage 4/Tier 4>		01.15→	0 445 020 611	
7347/MCS	7,4	203	74 AWF <Stage 4/Tier 4>		01.15→	0 445 020 611	
			74 AWI <Stage 3b/Tier 4>		01.11-12.14	0 445 020 610	



◀ MASSEY FERGUSON

Beta							
7260/AL	7,4	202	74 CTA		01.07-12.11	0 445 020 054	0 986 437 384
7270/AL	8,4	247	84 CTA		01.07-12.11	0 445 020 054	0 986 437 384
7360/PL	7,4	203	74 AWF <Stage 4/Tier 4>; 74 AWI <Stage 3b/Tier 4>		01.11→ TW	0 445 020 610	0 445 020 611
7370/PL	8,4	221-236	84 AWF <Stage 4/Tier 4>		01.14→	0 445 020 611	
		221-247	84 AWI <Stage 3b/Tier 4>		01.11-12.14	0 445 020 610	
Centora							
7280/AL	8,4	278	84 AWI <Stage 3b/Tier 4>		01.11-12.13	0 445 020 610	
			84 CTA		01.08-12.11	0 445 020 054	0 986 437 384
7282/AL	8,4	304	84 AWI <Stage 3b/Tier 4>		01.11-12.13	0 445 020 610	
			84 CTA		01.08-12.11	0 445 020 054	0 986 437 384
7380/AL	8,4	256-279	84 AWF <Stage 4/Tier 4>		01.14→	0 445 020 611	
7382/AL	8,4	276-297	84 AWF <Stage 4/Tier 4>		01.14→	0 445 020 611	
Cerea							
7274	8,4	221	84 CTA		01.05-12.11	0 445 020 054	0 986 437 384
7278	8,4	258	84 CTA		01.05-12.11	0 445 020 054	0 986 437 384
Delta							
9280/AL	9,8	353	98 ATI		01.10-12.13	0 445 020 610	
			98 CTA				
			Mot.-Nr. →63011		01.10-12.13	0 445 020 054	0 986 437 384
9380/AL	9,8	343	98 AWF <Stage 4/Tier 4>		01.13→	0 445 020 611	
Fortina							
9695	8,4	221	84 CTA		08.08-12.11	0 445 020 054	0 986 437 384
		243	84 WI <Tier 3>		08.08-12.11	0 445 020 610	
9795	8,4	258	84 CTA		08.08-12.14	0 445 020 054	0 986 437 384
	9,8	280	98 ATI		08.08-12.14	0 445 020 610	
9895	9,8	313	98 ATI		08.08-12.14	0 445 020 610	
T7							
	8,4	276	84 AWI <Stage 3b/Tier 4>		01.13→	0 445 020 610	
	9,8		98 AWF <Stage 4/Tier 4>		01.13→	0 445 020 611	
WR							
9740	4,9	101	49 AWI <Stage 3b/Tier 4>		09.13→	0 445 020 512	
9760	4,9	138	49 AWI <Stage 3b/Tier 4>		09.13→	0 445 020 512	
9770	6,6	162	66 AWI <Stage 3b/Tier 4>		09.13→	0 445 020 610	
9840	4,4	103-110	44 AWF <Stage 4/Tier 4>		09.13→	0 445 020 512	
9860	4,9	147-155	49 AWF <Stage 4/Tier 4>		09.13→	0 445 020 611	
9870	6,6	168-179	66 AWF		09.13→	0 445 020 611	
3600-Serie							
3630	3,3	56	33 DTA		05.11→	0 445 020 056	
3640 4x4	3,3	63	33CTA		05.11→	0 445 020 056	
3650 4x4	3,3	68-70	33CTA		05.11→	0 445 020 056	
3660 4x4	3,3	76	33CTA		05.11→	0 445 020 056	
4600-Serie							
4607 , M	3,3	52,3/52,5	33 AWF <Stage 4/Tier 4>; 33 AWI <Stage 3b/Tier 4>		09.12→	0 445 025 035	
4608	3,3	60	33 AWI <Stage 3b/Tier 4>		09.12-08.15	0 445 025 035	
4609	3,3	67	33 AWF <Stage 4/Tier 4>; 33 AWI <Stage 3b/Tier 4>		09.12→	0 445 025 035	
4610 , M	3,3	74/74,6	33 AWF <Stage 4/Tier 4>; 33 AWI <Stage 3b/Tier 4>		09.12→	0 445 025 035	
4700-Serie							
4707	3,3	55	33 AWI <Stage 3b/Tier 4>; 33 CWC		01.14→	0 445 025 035	
4708	3,3	63	33 AWF <Stage 4/Tier 4>; 33 AWI <Stage 3b/Tier 4>; 33 CWC		01.14→	0 445 025 035	
4709	3,3	70	33 AWF <Stage 4/Tier 4>; 33 AWI <Stage 3b/Tier 4>; 33 CWC		01.14→	0 445 025 035	
5400-Serie							
5460	4,4	85	44 CWA		01.07-12.12	0 445 020 056	
5465	6,6	88	66CTA		01.07-12.12	0 445 020 056	
5470	4,4	99	44 CWA		01.07-12.12	0 445 020 056	
5475	6,6	97	66CTA		01.07-12.12	0 445 020 056	
5480	4,9	99	49 CWA		01.07-12.12	0 445 020 056	
5600-Serie							
5608	3,3	63	AGCO POWER 33 AWI		01.12→	0 445 020 512	
5609	3,3	71	AGCO POWER 33 AWI		01.12→	0 445 020 512	





5610	3,3	78	AGCO POWER 33 AWI	01.12→		0 445 020 512
5611	4,4	81	AGCO POWER 44 AWI	01.13→		0 445 020 512
5612	4,4	88	AGCO POWER 44 AWI	01.13→		0 445 020 512
5613	4,4	92	AGCO POWER 44 AWI	01.13→		0 445 020 512
<b>5700-Serie</b>						
5412 SL	4,4	85-88	44 AWF <Stage 4/Tier 4>	01.15→		0 445 025 035
5710	4,4	74	44 AWF <Stage 4/Tier 4>	01.15→	TW	0 445 025 035
5711	4,4	77-81	44 AWF <Stage 4/Tier 4>	01.15→		0 445 025 035
5713 SL	4,4	92-96	44 AWF <Stage 4/Tier 4>	01.15→		0 445 025 035
<b>6400-Serie</b>						
6465	6,6	88	66CTA	01.10-12.12		0 445 020 056
6475	6,6	97	66CTA	01.10-12.12		0 445 020 056
6480	6,6	108	66CTA	01.10-12.12		0 445 020 056
6485 Dyna-6	6,6	118	66CTA	01.06-12.11		0 445 020 056
6490 Dyna-6	6,6	125	66CTA	01.06-12.11		0 445 020 056
6495 Dyna-6	6,6	136	66CTA	01.06-12.11		0 445 020 056
6497 Dyna-6	7,4	147	74 CTA	01.06-12.11		0 445 020 054 0 986 437 384
6499 Dyna-6	7,4	158	74 CTA	01.06-12.11		0 445 020 054 0 986 437 384
<b>6600-Serie</b>						
6612	4,9	88	49 AWI <Stage 3b/Tier 4>	01.12-12.16		0 445 020 512
6613	4,9	92	49 AWI <Stage 3b/Tier 4>	01.12-12.16		0 445 020 512
6614	4,9	103	49 AWI <Stage 3b/Tier 4>	01.12-12.16		0 445 020 512
6615	4,9	107-110	49 AWI <Stage 3b/Tier 4>	01.12-12.16		0 445 020 512
6616	4,9	118	49 AWI <Stage 3b/Tier 4>	01.12-12.16		0 445 020 512
<b>6700-Serie</b>						
6711	4,4	77-81	44 CWC	01.15→		0 445 025 035
6712	4,4	85-88	44 AWF <Stage 4/Tier 4>; 44 CWC	01.15→		0 445 025 035
	4,9	85-88	49 AWF <Stage 4/Tier 4>	01.15→		0 445 020 611
6713	4,4	92-96	44 AWF <Stage 4/Tier 4>; 44 CWC	01.15→		0 445 025 035
	4,9	92-96	49 AWF <Stage 4/Tier 4>	01.15→		0 445 020 611
6714	4,9	103	49 AWF <Stage 4/Tier 4>	01.15→		0 445 020 611
6715	4,9	110	49 AWF <Stage 4/Tier 4>	01.15→		0 445 020 611
6716	4,9	118	49 AWF <Stage 4/Tier 4>	01.15→		0 445 020 611
6718	4,9	133	49 AWF <Stage 4/Tier 4>	01.15→		0 445 020 611
<b>7400-Serie</b>						
7465	6,6	75	66CTA	01.07-12.12		0 445 020 056
7475	6,6	82	66CTA	01.07-12.12		0 445 020 056
7480	6,6	90	66CTA	01.07-12.12		0 445 020 056
7485	6,6	97	66CTA	01.04-12.12		0 445 020 056
7490	6,6	104	66CTA	01.04-12.12		0 445 020 056
7495	6,6	116	66CTA	01.04-12.12		0 445 020 056
7497	6,6	151	66CTA	01.07-12.12		0 445 020 054 0 986 437 384
7499	7,4	162	74 CTA	01.07-12.12		0 445 020 054 0 986 437 384
<b>7600-Serie</b>						
7614	6,6	103	AGCO POWER e3 SCR	01.12→		0 445 020 610
7615	6,6	110	AGCO POWER e3 SCR	01.12→		0 445 020 610
7616	6,6	118	AGCO POWER e3 SCR	01.12→		0 445 020 610
7618	6,6	129	AGCO POWER e3 SCR	01.12→		0 445 020 610
7619	6,6	136	AGCO POWER e3 SCR	01.12→		0 445 020 610
7620	6,6	147	AGCO POWER e3 SCR	01.12→		0 445 020 610
7622 Dyna-VT	6,6	158	AGCO POWER e3 SCR	01.12→		0 445 020 610
7624	7,4	173	AGCO POWER e3 SCR	01.12→		0 445 020 610
7626	7,4	188	AGCO POWER e3 SCR	01.12→		0 445 020 610
<b>7700-Serie</b>						
7714	6,6	96,9	66 AWF	01.15→		0 445 020 611
7715	6,6	104,4	66 AWF	01.15→		0 445 020 611
7716	6,6	111,9	66 AWF	01.15→		0 445 020 611
7718	6,6	123	66 AWF	01.15→		0 445 020 611
7719	6,6	113	66 AWF	01.15→		0 445 020 611
		127	66 CW3 <Tier 3>	01.15→		0 445 020 610
7720	6,6	138	66 CW3 <Tier 3>	01.15→		0 445 020 610
		149,1	66 AWF	01.15→		0 445 020 611
7722	7,4	130	74 AWF <Stage 4/Tier 4>	01.15→		0 445 020 611







◀ MASSEY FERGUSON

7722	7,4	149	74 CW3 <Tier 3>	01.15→	0 445 020 610	
7724	7,4	141	74 AWF <Stage 4/Tier 4>	01.15→	0 445 020 611	
		164,1	74 CW3 <Tier 3>	01.15→	0 445 020 610	
7726	7,4	151	74 AWF <Stage 4/Tier 4>	01.15→	0 445 020 611	
		179	74 CW3 <Tier 3>	01.15→	0 445 020 610	
<b>8400-Serie</b>						
8450	7,4	158	74 CTA	01.06-12.08	0 445 020 054	0 986 437 384
8460	7,4	173	74 CTA	01.06-12.08	0 445 020 054	0 986 437 384
8470	8,4	191	84 CTA	01.06-12.08	0 445 020 054	0 986 437 384
8480	8,4	213	84 CTA	01.04-12.07	0 445 020 054	0 986 437 384
<b>8600-Serie</b>						
8650	8,4	199	84 AWI <Stage 3b/Tier 4>	01.11-12.14	0 445 020 610	
			84 CTA	01.08-12.11	0 445 020 054	0 986 437 384
8660	8,4	217	84 AWI <Stage 3b/Tier 4>	01.11-12.14	0 445 020 610	
			84 CTA	01.08-12.11	0 445 020 054	0 986 437 384
8670	8,4	236	84 AWI <Stage 3b/Tier 4>	01.11-12.14	0 445 020 610	
			84 CTA	01.08-12.11	0 445 020 054	0 986 437 384
8680	8,4	258	84 AWI <Stage 3b/Tier 4>	01.11-12.14	0 445 020 610	
			84 CTA	01.08-12.11	0 445 020 054	0 986 437 384
8690	8,4	272	84 AWI <Stage 3b/Tier 4>	01.11-12.14	0 445 020 610	
		280	84 CTA	01.08-12.11	0 445 020 054	0 986 437 384
<b>8700-Serie</b>						
8727	8,4	199	84 AWI <Stage 3b/Tier 4>	01.14→	0 445 020 611	
8730	8,4	217	84 AWI <Stage 3b/Tier 4>	01.14→	0 445 020 611	
8732	8,4	236	84 AWI <Stage 3b/Tier 4>	01.14→	0 445 020 611	
8735	8,4	258/272	84 AWI <Stage 3b/Tier 4>	01.14→	0 445 020 611	
<b>9000-Serie</b>						
9520	8,4	234	84 AWI <Stage 3b/Tier 4>	01.12-12.14	0 445 020 610	
9530	8,4	255	84 AWI <Stage 3b/Tier 4>	01.12-12.14	0 445 020 610	
9540	9,8	276	98 ATI	01.12-12.14	0 445 020 610	
			98 AWF <Stage 4/Tier 4>	01.15→	0 445 020 611	
9550	9,8	300	98 ATI	01.12-12.14	0 445 020 610	
9560	9,8	343	98 ATI	01.12-12.14	0 445 020 610	
			98 AWF <Stage 4/Tier 4>	01.15→	0 445 020 611	
9690	8,4	224	84 CTA	09.05-12.08	0 445 020 054	0 986 437 384
9790	8,4	258	84 CTA	09.05-12.08	0 445 020 054	0 986 437 384
<b>9505-Serie</b>						
9545	9,8	280	98 AWF <Stage 4/Tier 4>	09.14→	0 445 020 611	
9565	9,8	343	98 AWF <Stage 4/Tier 4>	09.14→	0 445 020 611	



**MTZ (MINSK TRAKTOR WERK)**

**Belarus**

1025	4,8	105	D 245 E3 <Euro 3>	01.08→	0 445 020 088	
------	-----	-----	-------------------	--------	---------------	--

**NEW HOLLAND**

**Serie B**

100 B, BLR, BTC	4,5	74	445TA <Tier 3>	02.08-12.12	0 445 020 175	0 986 437 341
110 , B, BTC	4,5	79/81	445T <Tier 3>; 445TA <Tier 3>	02.07-12.12	0 445 020 175	0 986 437 341
115 , B	4,5	85	445T <Tier 3>; 445TA <Tier 3>	02.07-12.12	0 445 020 175	0 986 437 341

**Serie 200**

C232	3,2	56	F5CE5454B <Tier 3>	04.11→	0 445 020 516	
L225	3,2	56	F5CE5454B <Tier 3>	04.11→	0 445 020 516	
L230	3,4	62	F5HFL413A <Tier 4>	07.12-12.15	0 445 020 516	

**TD5**

.105	3,4	79	F5DFL413H	10.14→	0 445 020 516	
.115	3,4	84	F5DFL413H	10.14→	0 445 020 516	
.85	3,4	63	F5DFL413H	10.14→	0 445 020 516	
.95	3,4	73	F5DFL413H	10.14→	0 445 020 516	



<b>TD4000F</b>						
<b>4.100</b>	3,4	54	F5DFL413K <Tier 4>		05.17→	<b>0 445 020 516</b>
<b>4.80</b>	3,4	40	F5DFL413B <Tier 4>		05.17→	<b>0 445 020 516</b>
<b>4.90</b>	3,4	46	F5DFL413L <Tier 4>		05.17→	<b>0 445 020 516</b>
<b>TS</b>						
<b>110A 4.5 16x16</b>	4,5	81	F4DFE413E <Tier 4a>		12.03-12.07	<b>0 445 020 175 0 986 437 341</b>
<b>125A 12x12</b>	6,7	93	NEF		07.03-12.07	<b>0 445 020 175 0 986 437 341</b>
<b>135A 16x16</b>	6,7	100	NEF		07.03-12.07	<b>0 445 020 175 0 986 437 341</b>
<b>T4</b>						
<b>.100 F</b>	3,4	73	F5DFL413K <Tier 4>		03.16→	<b>0 445 020 516</b>
<b>.100 LP</b>	3,4	73	F5DFL413K <Tier 4>		05.17→	<b>0 445 020 516</b>
<b>.100 N</b>	3,4	73	F5DFL413K <Tier 4>		04.17→	<b>0 445 020 516</b>
<b>.100 V</b>	3,4	73	F5DFL413K <Tier 4>		04.17→	<b>0 445 020 516</b>
<b>.105</b>	3,4	79	F5DFL413... <Tier 4a>		12.12→	<b>0 445 020 516</b>
<b>.110 F</b>	3,4	79	F5DFL413J <Tier 4a>		03.16→	<b>0 445 020 516</b>
<b>.110 LP</b>	3,4	79	F5DFL413J <Tier 4a>		05.17→	<b>0 445 020 516</b>
<b>.110 N</b>	3,4	79	F5DFL413J <Tier 4a>		04.17→	<b>0 445 020 516</b>
<b>.110 V</b>	3,4	79	F5DFL413J <Tier 4a>		04.17→	<b>0 445 020 516</b>
<b>.115</b>	3,4	85	F5DFL413... <Tier 4a>		06.13→	<b>0 445 020 516</b>
<b>.75</b>	3,4	55	F5DFL413... <Tier 4a>		06.13→	<b>0 445 020 516</b>
<b>.80 F</b>	3,4	55	F5DFL413... <Tier 4a>		03.16→	<b>0 445 020 516</b>
<b>.80 LP</b>	3,4	55	F5DFL413... <Tier 4a>		05.17→	<b>0 445 020 516</b>
<b>.80 N</b>	3,4	55	F5DFL413... <Tier 4a>		04.17→	<b>0 445 020 516</b>
<b>.80 V</b>	3,4	55	F5DFL413... <Tier 4a>		04.17→	<b>0 445 020 516</b>
<b>.85</b>	3,4	63	F5DFL413... <Tier 4a>		12.12→	<b>0 445 020 516</b>
<b>.90 F</b>	3,4	63	F5DFL413L <Tier 4>		03.16→	<b>0 445 020 516</b>
<b>.90 LP</b>	3,4	63	F5DFL413L <Tier 4>		05.17→	<b>0 445 020 516</b>
<b>.90 N</b>	3,4	63	F5DFL413L <Tier 4>		04.17→	<b>0 445 020 516</b>
<b>.90 V</b>	3,4	63	F5DFL413L <Tier 4>		04.17→	<b>0 445 020 516</b>
<b>.95</b>	3,4	73	F5DFL413... <Tier 4a>		12.12→	<b>0 445 020 516</b>
<b>T4 Powerstar</b>						
<b>.55</b>	3,4	43	F5DFL463... <Tier 4a>		05.14→	<b>0 445 020 516</b>
<b>.65</b>	3,4	48	F5DFL463... <Tier 4a>		05.14→	<b>0 445 020 516</b>
<b>.75</b>	3,4	55	F5DFL463A <Tier 4a>		05.14→	<b>0 445 020 516</b>
<b>T5</b>						
<b>.100</b>	3,4	74	F5GFL413A		11.15→	<b>0 445 020 516</b>
<b>.105</b>	3,4	79	F5DFL413... <Tier 4a>		07.12→	<b>0 445 020 516</b>
<b>.110</b>	3,4	81	F5GFL413A		11.15→	<b>0 445 020 516</b>
<b>.115</b>	3,4	84	F5DFL413... <Tier 4a>		07.12→	<b>0 445 020 516</b>
<b>.120</b>	3,4	88	F5GFL413A		11.15→	<b>0 445 020 516</b>
<b>.75</b>	3,4	55	F5DFL413A <Tier 4a>		04.17→	<b>0 445 020 516</b>
<b>.85</b>	3,4	63	F5DFL413L <Tier 4>		04.17→	<b>0 445 020 516</b>
<b>.95</b>	3,4	73	F5DFL413... <Tier 4a>		01.12→	<b>0 445 020 516</b>
<b>T6</b>						
<b>.120 16x16</b>	4,5	89	F4DFE413E <Tier 4a>		02.12→	<b>0 445 020 175 0 986 437 341</b>
<b>.125 16x16</b>	4,5	92	F4DFE41... <Tier 4b>		03.15→	<b>0 445 020 223</b>
<b>.140 16x16</b>	4,5	105	F4DFE413C <Tier 4a>		02.12-12.15	<b>0 445 020 175 0 986 437 341</b>
<b>.145 16x16</b>	4,5	107	F4DFE4134 <Tier 4b>		03.15→	<b>0 445 020 223</b>
<b>.150 16x16</b>	4,5	113	F4DFE413B <Tier 4a>		02.12-12.15	<b>0 445 020 175 0 986 437 341</b>
<b>.155 16x16</b>	4,5	114	F4DFE4133 <Tier 4b>		03.15→	<b>0 445 020 223</b>
	6,7	113	F4DFE613F <Tier 4a>		02.12-12.15	<b>0 445 020 175 0 986 437 341</b>
<b>.160 16x16</b>	4,5	120	F4DFE413A <Tier 4a>		02.12-12.15	<b>0 445 020 175 0 986 437 341</b>
<b>.165 16x16</b>	4,5	121	F4DFE4132 <Tier 4b>		03.15→	<b>0 445 020 223</b>
	6,7	121	F4DFE6132 <Tier 4a>		02.12-12.15	<b>0 445 020 175 0 986 437 341</b>
<b>.175 16x16</b>	4,5	129	F4DFE4131 <Tier 4b>		03.15→	<b>0 445 020 223</b>
	6,7	129	F4DFE613E <Tier 4a>		02.12-12.15	<b>0 445 020 175 0 986 437 341</b>
<b>.180 16x16</b>	6,7	132	F4DFE6132 <Tier 4a>		03.15→	<b>0 445 020 223</b>
<b>T7</b>						
<b>.170 CVT</b>	6,7	126	F4DFE613B		12.10-12.14	<b>0 445 020 175 0 986 437 341</b>
<b>.175 CVT</b>	6,7	129	F4DFE613... <Tier 4b>		04.14→	<b>0 445 020 223</b>
<b>.185 CVT</b>	6,7	138	F4DFE613B		12.10-12.14	<b>0 445 020 175 0 986 437 341</b>
<b>.190 CVT</b>	6,7	140	F4DFE613N		04.14→	<b>0 445 020 223</b>
<b>.200 CVT</b>	6,7	149	F4DFE613B		12.10-12.14	<b>0 445 020 175 0 986 437 341</b>





◀ NEW HOLLAND

<b>.210 CVT</b>	6,7	154	F4DFE613M	04.14→	<b>0 445 020 223</b>	
		156	F4DFE613B	12.10-12.14	<b>0 445 020 175</b>	<b>0 986 437 341</b>
<b>.220 CVT</b>	6,7	160	F4DFE613J	12.10-12.14	<b>0 445 020 175</b>	<b>0 986 437 341</b>
<b>.225 CVT</b>	6,7	165	F4DFE613K	04.14→	<b>0 445 020 223</b>	
<b>.230 CVT</b>	6,7	165	F4DFE613K	04.14→	<b>0 445 020 223</b>	
<b>.235 CVT</b>	6,7	172	F4DFE613J	12.10-12.14	<b>0 445 020 175</b>	<b>0 986 437 341</b>
<b>.245 CVT</b>	6,7	180	F4DFE613J	04.14→	<b>0 445 020 223</b>	
<b>.250 CVT</b>	6,7	184	F4DFE613J	12.10-12.14	<b>0 445 020 175</b>	<b>0 986 437 341</b>
<b>.260 CVT</b>	6,7	191	F4DFE613H	04.14→	<b>0 445 020 223</b>	
			F4DFE613J	12.10-12.14	<b>0 445 020 175</b>	<b>0 986 437 341</b>
<b>.270 CVT</b>	6,7	198	F4DFE613B	04.14→	<b>0 445 020 223</b>	
			F4DFE613J	12.10-12.14	<b>0 445 020 175</b>	<b>0 986 437 341</b>
<b>.275</b>	6,7	202	F4DFE617L <Tier 4b>	08.17→	<b>0 445 020 223</b>	
<b>.290 CVT</b>	6,7	213	F4DFE617M <Tier 4b>	10.15→	<b>0 445 020 223</b>	
<b>.315 CVT</b>	6,7	230	F4DFE617L <Tier 4b>	10.15→	<b>0 445 020 223</b>	
<b>T8</b>						
<b>.275 CVT</b>	8,7	201	F2CFE613F	02.13-12.14	<b>0 445 020 093</b>	<b>0 986 437 389</b>
<b>.300 CVT</b>	8,7	219	F2CFE613F	02.13-12.14	<b>0 445 020 093</b>	<b>0 986 437 389</b>
<b>.320 CVT</b>	8,7	235	F2CFE613G	04.14→	<b>0 445 020 093</b>	<b>0 986 437 389</b>
<b>.330 CVT</b>	8,7	241	F2CFE613F	02.13-12.14	<b>0 445 020 093</b>	<b>0 986 437 389</b>
<b>.350 CVT</b>	8,7	258	F2CFE614G	04.14→	<b>0 445 020 093</b>	<b>0 986 437 389</b>
<b>.360 CVT</b>	8,7	263	F2CFE613F	02.13-12.14	<b>0 445 020 093</b>	<b>0 986 437 389</b>
<b>.380 CVT</b>	8,7	281	F2CFE614D	04.14→	<b>0 445 020 093</b>	<b>0 986 437 389</b>
<b>.390 CVT</b>	8,7	286	F2CFE613F	02.13-12.14	<b>0 445 020 093</b>	<b>0 986 437 389</b>
<b>.410 CVT</b>	8,7	301	F2CFE614C	04.14→	<b>0 445 020 093</b>	<b>0 986 437 389</b>
<b>.420 CVT</b>	8,7	308	F2CFE613F	02.13-12.14	<b>0 445 020 093</b>	<b>0 986 437 389</b>
<b>.435 CVT</b>	8,7	320	F2CFE614A	04.14→	<b>0 445 020 093</b>	<b>0 986 437 389</b>
<b>T9</b>						
<b>.390</b>	8,7	287	F2CFE614A	02.11-12.14	<b>0 445 020 093</b>	<b>0 986 437 389</b>
<b>.435</b>	8,7	320	F2CFE614A	10.14→	<b>0 445 020 093</b>	<b>0 986 437 389</b>
<b>.454</b>	12,9	345	F3HFE613B	10.14→	<b>0 445 020 195</b>	<b>0 986 437 512</b>
<b>.455</b>	12,9	386	F3HFE613B	10.14→	<b>0 445 020 195</b>	<b>0 986 437 512</b>
<b>.565</b>	12,9	410	F3HFE613B	10.14→	<b>0 445 020 195</b>	<b>0 986 437 512</b>
<b>.600</b>	12,9	451	F3DFE613F	10.14→	<b>0 445 020 195</b>	<b>0 986 437 512</b>
<b>.615</b>	12,7	451	F3DFE613B	04.11-11.17	<b>0 445 020 195</b>	<b>0 986 437 512</b>
	12,9	451	F3DFA613A	03.14-11.17	<b>0 445 020 195</b>	<b>0 986 437 512</b>
<b>.645</b>	12,9	476	F3DFE613F	10.14→	<b>0 445 020 195</b>	<b>0 986 437 512</b>
<b>.670</b>	12,7	492	F3DFA613A	04.11-11.17	<b>0 445 020 195</b>	<b>0 986 437 512</b>
	12,9	492	F3DFA613A	03.14-11.17	<b>0 445 020 195</b>	<b>0 986 437 512</b>
<b>.700</b>	12,9	509	F3DFE613F	10.14→	<b>0 445 020 195</b>	<b>0 986 437 512</b>
<b>T6000</b>						
<b>6020</b>	4,5	82	N45MNT <FPT>	01.07-11.16	<b>0 445 020 175</b>	<b>0 986 437 341</b>
<b>6030 12x12</b>	6,7	86	N67ENT <6.7LI6DTA>	01.07-09.13	<b>0 445 020 175</b>	<b>0 986 437 341</b>
<b>6040</b>	4,5	90	N45MNT <FPT>	01.07-11.13	<b>0 445 020 175</b>	<b>0 986 437 341</b>
<b>6050 16x16</b>	6,7	93	N67ENT <6.7LI6DTA>	01.07→	<b>0 445 020 175</b>	<b>0 986 437 341</b>
<b>6060</b>	4,5	97	N45MNT <FPT>	01.07-08.16	<b>0 445 020 175</b>	<b>0 986 437 341</b>
<b>6070 16x16</b>	6,7	104	N67ENT <6.7LI6DTA>	01.07→	<b>0 445 020 175</b>	<b>0 986 437 341</b>
<b>6080 Power Command</b>	6,7	114	N67ENT <6.7LI6DTA>	12.07→	<b>0 445 020 175</b>	<b>0 986 437 341</b>
<b>6090 Power Command</b>	6,7	121	N67ENT <6.7LI6DTA>	11.09→	<b>0 445 020 175</b>	<b>0 986 437 341</b>
<b>T7000</b>						
<b>T7030 CVT</b>	6,7	158	N67ENT <6.7LI6DTA>	01.07-12.11	<b>0 445 020 175</b>	<b>0 986 437 341</b>
<b>T7040 CVT, Power Command</b>	6,7	134/172	N67ENT <6.7LI6DTA>	01.06-12.11	<b>0 445 020 175</b>	<b>0 986 437 341</b>
<b>T7050 CVT, Power Command</b>	6,7	145/177	N67ENT <6.7LI6DTA>	01.06-12.11	<b>0 445 020 175</b>	<b>0 986 437 341</b>
<b>T7060 CVT</b>	6,7	179	N67ENT <6.7LI6DTA>	01.07-12.11	<b>0 445 020 175</b>	<b>0 986 437 341</b>
<b>T7070 CVT</b>	6,7	187	N67ENT <6.7LI6DTA>	06.09-12.11	<b>0 445 020 175</b>	<b>0 986 437 341</b>





l/ccm



kW/(PS)



Typ



eXchange

**KAMAZ****Serie 740**

<b>740.60</b> -360	11,8	265	740.72-360 <Euro 4>	08.08→	<b>0 445 020 089</b>
<b>740.61</b> -320	11,8	236	740.71-320 <Euro 4>	08.08→	<b>0 445 020 089</b>
<b>740.62</b> -280	11,8	206	740.70-280 <Euro 4>	08.08→	<b>0 445 020 089</b>
<b>740.63</b> -400	11,8	294	740.73-400 <Euro 4>	08.08→	<b>0 445 020 089</b>
<b>740.64</b> -420	11,8	309	740.74-420 <Euro 4>	08.08→	<b>0 445 020 089</b>
<b>740.65</b> -240	11,8	324	740.75-440 <Euro 4>	08.08→	<b>0 445 020 089</b>

**MMZ (MINSK MOTOREN WERK)****D Serie**

4,8	90/100/ 130	D 245.35 E4 <Euro 4>; D 245.7 E4 <Euro 4>; D 245.9 E4 <Euro 4>	12.11→	<b>0 445 020 088</b>
-----	----------------	---	--------	----------------------

**Serie D**

<b>245</b> .30 E3, .35 E3, .7 E3, .9 E3	4,8	90/100/ 115/125	D 245.30 E3 <Euro 3>; D 245.35 E3 <Euro 3>; D 245.7 E3 <Euro 3>; D 245.9 E3 <Euro 3>	01.08→	<b>0 445 020 088</b>
<b>249</b>	4,8	140	D 249 <Euro 3>	10.07→	<b>0 445 020 088</b>
<b>262</b> S2	7,9	220,5	D 262 S2 <Euro 3>	10.07→	<b>0 445 020 087</b>
<b>263</b> .1 E3	8,7	257,4	D 263.1 E3 <Euro 3>	10.07→	<b>0 445 020 087</b>

**YAMZ (YAROSLAWL MOTORENWERKE)****Serie 650**

<b>650</b> .10	11,1	303	650.10 <Euro 3>	11.08→	<b>0 445 020 086</b>
<b>6501</b> .10	11,1	266	6501.10 <Euro 3>	11.08→	<b>0 445 020 086</b>
<b>6502</b> .10	11,1	230	6502.10 <Euro 3>	11.08→	<b>0 445 020 086</b>





**ALFA ROMEO**

<b>145</b>						
1.9 TD [930 MY97]	1,9	66	AR 33601 <M5>	11.96-05.98	<b>0 460 494 390</b>	
			AR 67501 <M6>	11.96-05.98	<b>0 460 494 389</b>	
<b>146</b>						
1.9 TD [930 MY97]	1,9	66	AR 33601 <M5>; AR 67501 <M6>	11.96-05.98	<b>0 460 494 389</b>	
				AGF	<b>0 460 494 390</b>	
<b>164</b>						
2.5 D Turbo [164]	2,5	92	VM08B / VM32B <M8/M9>	01.94-10.98	EDC	<b>0 460 404 991</b>

**AUDI**

<b>A3</b>						
1.9 TDI [8L1]	1,9	66	AGR	09.96-08.00	<b>0 460 404 959 0 986 440 557</b>	
			ALH	08.97-06.01	GS	<b>0 460 404 959 0 986 440 557</b>
		81	AHF	01.97-08.00	<b>0 460 404 959 0 986 440 557</b>	
				01.00-09.06	<b>0 460 404 977 0 986 440 557</b>	
			ASV	09.99-06.01	<b>0 460 404 959 0 986 440 557</b>	
<b>A4</b>						
1.9 TDI [8D2; B5]	1,9	55	AFF	08.97-06.00	<b>0 460 404 971 0 986 440 555</b>	
		66	AHU	08.97-06.00	<b>0 460 404 971 0 986 440 555</b>	
TDI, TDI quattro [8D2; B5]	1,9	81	AFN	02.96-07.99	<b>0 460 404 969 0 986 440 554</b>	
			AVG	08.99-06.00	<b>0 460 404 969 0 986 440 554</b>	
2.5 TDI [8EC; B7]	2,5	120	BDG	11.04-05.06	GS,THI	<b>0 470 506 038 0 986 444 083</b>
TDI [8E2; B6]	2,5	120	BCZ	06.03-12.04	GS,THI	<b>0 470 506 033 0 986 444 073</b>
			BDG	06.03-12.04	GS,THI	<b>0 470 506 038 0 986 444 083</b>
TDI quattro [8E2; B6]	2,5	132	AKE; BAU	12.00-12.04	THI	<b>0 470 506 033 0 986 444 073</b>
			BDH	11.02-12.04	THI	<b>0 470 506 038 0 986 444 083</b>
TDI, TDI quattro [8D2; B5]	2,5	110	AKN	07.98-10.00	GS	<b>0 470 506 049 0 986 444 068</b>
<b>A4 Avant</b>						
1.9 TDI [8D5; B5]	1,9	66	AHU	08.97-06.00	<b>0 460 404 971 0 986 440 555</b>	
TDI, TDI quattro [8D5; B5]	1,9	81	AFN	02.96-07.99	<b>0 460 404 969 0 986 440 554</b>	
			AVG	08.99-06.00	<b>0 460 404 969 0 986 440 554</b>	
2.5 TDI [8ED; B7]	2,5	120	BDG	11.04-05.06	GS,THI	<b>0 470 506 038 0 986 444 083</b>
TDI [8E5; B6]	2,5	120	BCZ	06.03-12.04	GS,THI	<b>0 470 506 033 0 986 444 073</b>
			BDG	06.03-12.04	GS,THI	<b>0 470 506 038 0 986 444 083</b>
TDI quattro [8E5; B6]	2,5	132	AKE; BAU	09.01-12.04	THI	<b>0 470 506 033 0 986 444 073</b>
			BDH	11.02-12.04	THI	<b>0 470 506 038 0 986 444 083</b>
TDI, TDI quattro [8D5; B5]	2,5	110	AKN	07.98-09.01	GS	<b>0 470 506 049 0 986 444 068</b>
<b>A4 Cabriolet</b>						
2.5 TDI [8H7; B6]	2,5	120	BCZ	06.03-12.05	GS,THI	<b>0 470 506 033 0 986 444 073</b>
			BDG	06.03-12.05	GS,THI	<b>0 470 506 038 0 986 444 083</b>
<b>A6</b>						
1.9 TDI [4B2; C5]	1,9	81	AFN; AVG	04.97-10.00	<b>0 460 404 969 0 986 440 554</b>	
2.5 TDI, TDI quattro [4B2; C5]	2,5	110	AKN	11.98-04.01	GS	<b>0 470 506 049 0 986 444 068</b>
		132	AKE	06.01-08.03	THI	<b>0 470 506 033 0 986 444 073</b>
			BAU	11.02-05.04	THI	<b>0 470 506 033 0 986 444 073</b>
			BDH	11.02-05.04	THI	<b>0 470 506 038 0 986 444 083</b>
<b>A6 Allroad</b>						
2.5 TDI [4BH; C5]	2,5	132	BAU	06.03-08.05	THI	<b>0 470 506 033 0 986 444 073</b>
<b>A6 Avant</b>						
1.9 TDI [4B5; C5]	1,9	81	AFN	02.98-04.01	<b>0 460 404 969 0 986 440 554</b>	
2.5 TDI, TDI quattro [4B5; C5]	2,5	110	AKN	11.98-04.01	GS	<b>0 470 506 049 0 986 444 068</b>
		132	AKE	06.01-08.03	THI	<b>0 470 506 033 0 986 444 073</b>
			BAU	11.02-01.05	THI	<b>0 470 506 033 0 986 444 073</b>
			BDH	11.02-01.05	THI	<b>0 470 506 038 0 986 444 083</b>
<b>A8</b>						
2.5 TDI, TDI quattro [4D2; D2]	2,5	110	AKN	11.97-09.02	GS	<b>0 470 506 049 0 986 444 068</b>
<b>Cabriolet</b>						
1.9 TDI [8G7; B4]	1,9	66	AHU	07.96-08.00	<b>0 460 404 983 0 986 440 558</b>	





## BMW

Serie 3							
318 d [E 46]	2,0	85	20 4D 1 <M 47 D 20>		09.01-03.03	0 470 504 025	0 986 444 035
tds [E 36]	1,7	66	17 4T 1 <M 41 D 18>		10.94-03.98	0 460 494 995	0 986 440 538
320 d [E 46]	2,0	100	20 4D 1 <M 47 D 20>		04.98-09.01	AG	0 470 504 020 0 986 444 019
						GS	0 470 504 005 0 986 444 004
325 td [E 36]	2,5	85	25 6T 1 <M 51 D 25>		01.95-12.98		0 460 406 994 0 986 440 516
tds [E 36]	2,5	105	25 6T 1 <M 51 D 25>		05.93-12.98	EDC	0 460 406 994 0 986 440 516
Serie 3 Compact							
318 tds [E 36]	1,7	66	17 4T 1 <M 41 D 18>		01.95-09.00		0 460 494 995 0 986 440 538
Serie 3 Touring							
318 d [E 46]	2,0	85	20 4D 1 <M 47 D 20>		03.02-03.03		0 470 504 025 0 986 444 035
tds [E 36]	1,7	66	17 4T 1 <M 41 D 18>		03.95-12.99		0 460 494 995 0 986 440 538
320 d [E 46]	2,0	100	20 4D 1 <M 47 D 20>		10.99-09.01	AG	0 470 504 020 0 986 444 019
						GS	0 470 504 005 0 986 444 004
325 tds [E 36]	2,5	105	25 6T 1 <M 51 D 25>		09.95-12.99	EDC	0 460 406 994 0 986 440 516
Serie 5							
520 d [E 39]	2,0	100	20 4D 1 <M 47 D 20>		04.00-07.03		0 470 504 020 0 986 444 019
525 td, tds [E 39]	2,5	85/105	25 6T 1 <M 51 D 25>		01.96-09.00	EDC	0 460 406 994 0 986 440 516
Serie 5 Touring							
520 d [E 39]	2,0	100	20 4D 1 <M 47 D 20>		04.00-07.03		0 470 504 020 0 986 444 019
525 tds [E 39]	2,5	105	25 6T 1 <M 51 D 25>		03.97-09.00	EDC	0 460 406 994 0 986 440 516
Serie 7							
725 tds [E 38]	2,5	105	25 6T 1 <M 51 D 25>		01.96-12.00		0 460 406 994 0 986 440 516

## CHEVROLET

Blazer							
2.5 D	2,5	74	4A		10.97-01.00		0 460 414 127
Tavera							
2.5 D [I163]	2,5	59	4JA1		05.04→		F 002 D10 006

## CHRYSLER

Cherokee							
2.5 D	2,5	83	VM		01.99-01.04		0 460 404 980
3.1 D	3,1	110	EXA <VM 3,1 TDI>		01.00-12.01		0 460 405 999 0 986 440 550
Voyager							
2.5 TD [GS]	2,5	85	VM HR 425 CLIEE <ENC>		01.98-12.00		0 460 404 963

## CITROEN

Berlingo							
1.9 D [M49]	1,9	50-51	DJY <XUD9>		07.96-11.02	BO,WEG	0 460 484 070
			Org.-Nr. 7665→		12.97-11.02	BO,EFV, WZT	0 460 484 137
		52	WJC/WJZ <DW8/W3>		07.98-11.02	BO,WEG	0 460 494 463
						BO,WEG	0 460 494 462
C 15							
1.8 D	1,8	44	161A <XUD7>		04.92-05.00	BO	0 460 484 056
			Org.-Nr. 5654→				
Evasion							
1.9 D Turbo [U60]	1,9	66	DHX <XUD9TE>		10.94-07.02	N05,WEG	0 460 494 367
						N05,WEG	0 460 494 427
			Org.-Nr. 7665→		12.97-07.02	EFV,N05, WZT	0 460 494 455 0 986 440 161





◀ CITROEN

<b>1.9 D Turbo [U60]</b>	1,9	67-68	D8B <XUD9TE>	10.94-07.02	N09,OWO	<b>0 460 494 370</b>						
					N09,WEK	<b>0 460 494 412</b>						
					N39,OWK	<b>0 460 494 411</b>						
					N39,WOK	<b>0 460 494 384</b>						
			Org.-Nr. 6969→	01.96-07.02	EFV,N03, WEG	<b>0 460 494 423</b>	<b>0 986 440 156</b>					
<b>Jumpy</b>												
<b>1.9 D [U64]</b>	1,9	50-52	D9B <XUD9A>	10.95-01.07	OWK	<b>0 460 484 097</b>						
					OWO	<b>0 460 484 064</b>	<b>0 986 440 094</b>					
					WEK	<b>0 460 484 098</b>						
					WOK	<b>0 460 484 091</b>						
<b>D Turbo [U64]</b>	1,9	66	DHX <XUD9TE>	10.95-01.07	WEG	<b>0 460 494 423</b>	<b>0 986 440 156</b>					
					WEG	<b>0 460 494 427</b>						
					WZT	<b>0 460 494 455</b>	<b>0 986 440 161</b>					
					N03,WEG	<b>0 460 494 423</b>	<b>0 986 440 156</b>					
					N03,OWK	<b>0 460 494 384</b>						
					N09,OWK	<b>0 460 494 411</b>						
					N09,OWO	<b>0 460 494 370</b>						
					N09,WEK	<b>0 460 494 412</b>						
					N09,WOK	<b>0 460 494 388</b>						
					<b>Saxo</b>							
<b>1.5 D [S8]</b>	1,5	40	VJX <TUD5B>	09.00-09.03		<b>0 460 484 148</b>						
			40/42	VJY <TUD5Y>; VJZ <TUD5L>	07.96-09.03	BO,OWK	<b>0 460 484 099</b>					
						BO,OWO	<b>0 460 484 078</b>					
				Org.-Nr. 7707→	01.98-09.03	BO,WZT	<b>0 460 484 142</b>					
<b>Xantia</b>												
<b>1.9 D [X1]</b>	1,9	50-52	DJY/DJZ <XUD9A/Y>	05.94-01.98	AG,BOW	<b>0 460 484 092</b>						
					WEG	<b>0 460 484 070</b>						
						Org.-Nr. 6100→	05.94-01.98	AG,BOW	<b>0 460 484 057</b>			
						Org.-Nr. 7145→	06.96-01.98	WEG	<b>0 460 484 109</b>			
						D9B <XUD9A/L>	07.93-01.98	AG,BOW	<b>0 460 484 092</b>			
								BOW,GS	<b>0 460 484 091</b>			
								BOW,GS	<b>0 460 484 064</b>	<b>0 986 440 094</b>		
							Org.-Nr. 6100→	07.93-01.98	AG,BOW	<b>0 460 484 057</b>		
					<b>D Turbo [X1]</b>	1,9	66	DHX, DHY <XUD9BTF/Y, L3>	02.94-01.98	WEG	<b>0 460 494 367</b>	
											Org.-Nr. 7145→	07.96-01.98
<b>D Turbo [X2]</b>	1,9	66	DHX <XUD9BTF/L3>	12.97-12.01	AG	<b>0 460 494 446</b>						
						GS	<b>0 460 494 455</b>	<b>0 986 440 161</b>				
<b>Xantia Break</b>												
<b>1.9 D Turbo [X1]</b>	1,9	55/66	DHW <XUD9SD>; DHX, DHY <XUD9BTF/L3>	09.95-01.98	WEG	<b>0 460 494 367</b>						
						Org.-Nr. 7145→	07.96-01.98	WEG	<b>0 460 494 427</b>			
<b>D Turbo [X2]</b>	1,9	66	DHX <XUD9BTF/L3>	12.97-12.01	AG	<b>0 460 494 446</b>						
						GS	<b>0 460 494 455</b>	<b>0 986 440 161</b>				
<b>XM</b>												
<b>2.1 D Turbo [Y4]</b>	2,1	80-81	PHZ <XUD11ATE>	07.94-10.00	AG,WEG	<b>0 460 494 313</b>						
						AG,WEG	<b>0 460 494 386</b>					
						GS,WEG	<b>0 460 494 310</b>					
					P8B <XUD11ATE>	07.94-10.00	AG,KOC,	<b>0 460 494 276</b>				
					WEG							
					AG,KOC, WEG		<b>0 460 494 385</b>					
			GS,WEG	<b>0 460 494 255</b>								
<b>2.5 D Turbo [Y4]</b>	2,5	94-96	THY <DK5ATE>	07.94-10.00		<b>0 460 404 993</b>	<b>0 986 440 512</b>					
<b>Xsara</b>												
<b>1.9 D [N6]</b>	1,9	50	DJY <XUD9A>	11.97-08.00	BO,EFV	<b>0 460 484 137</b>						
						Org.-Nr. 7665→	04.98-08.00	BO	<b>0 460 494 467</b>			
						51	WJZ <DW8>	01.98-08.00		<b>0 460 484 131</b>		
<b>D Turbo [N6]</b>	1,9	55	DHV <XUD9BSD>	01.98-08.00		<b>0 460 484 131</b>						
<b>Xsara Break</b>												
<b>1.9 D [N6]</b>	1,9	50	DJY <XUD9A>	04.98-08.00	BO	<b>0 460 484 137</b>						
						51	WJZ <DW8>	04.98-08.00	BO	<b>0 460 494 467</b>		
						D Turbo [N6]	1,9	55	DHV <XUD9BSD>	04.98-08.00	<b>0 460 484 131</b>	





<b>Xsara Coupé</b>						
1.9 D [N6]	1,9	50	DJY <XUD9A>			
			Org.-Nr. 7665→	11.97-08.00	BO,EFV	<b>0 460 484 137</b>
		51	WJZ <DW8>	04.98-08.00	BO	<b>0 460 494 467</b>
D Turbo [N6]	1,9	55	DHV <XUD9BSD>	01.98-08.00		<b>0 460 484 131</b>

**DODGE**

<b>Caravan</b>						
2.5 TD [NS]	2,5	85	VM HR 425 CLIEE <ENC>	09.97-08.03		<b>0 460 404 963</b>

**FIAT**

<b>Brava</b>						
1.9 TD [182]	1,9	55	182 A8.000 <M9>; 182 A8.000 <M20>	03.96-09.01		<b>0 460 484 112</b>

<b>Bravo</b>						
1.9 TD [182]	1,9	55	182 A8.000 <M9>; 182 A8.000 <M20>	03.96-10.01		<b>0 460 484 112</b>

<b>Fiorino</b>						
1.7 D [146]	1,7	43	146 B2.000 <M6>	09.93-12.01	BOW	<b>0 460 484 095</b>
					BOW	<b>0 460 484 051</b>

<b>Fiorino Furgao</b>						
1.7 D	1,7	52	146 B2.000	01.04-12.08		<b>0 460 484 051</b>

<b>Marea</b>						
1.9 TD [185]	1,9	55,1	182 A8.000 <M2>	10.96-09.02		<b>0 460 484 112</b>
2.4 TD [185]	2,4	91	185 A2.000 <M3>	09.96-02.99		<b>0 460 495 998</b>

<b>Marengo</b>						
1.9 TD [285]	1,9	55/55,1	182 A8.000 <M2>	01.97-09.02		<b>0 460 484 112</b>

<b>Palio</b>						
1.7 D, TD	1,7	52	M 708 N7 17 L; 176A3000	02.97-08.01	BOW	<b>0 460 484 084</b>
					WEG	<b>0 460 484 126</b>

<b>Palio Weekend</b>						
1.7 TD [178]	1,7	46/51	176 B7.000 <M41>; 178 C9.066 <M40>	08.00-02.02	BOW	<b>0 460 484 113</b>
						BOW
		51	176 A3.000 <M3>	09.97-10.00	BOW	<b>0 460 484 083</b>
		53	176 A5.000 <M42>	02.02-09.02	WEG	<b>0 460 484 126</b>
					WEG	<b>0 460 484 113</b>

<b>Punto</b>						
1.7 TD [176]	1,7	46	176 B7.000 <M3>	05.97-08.99	BOW	<b>0 460 484 113</b>
		51	176 A3.000 <M2>	05.97-08.99	BOW	<b>0 460 484 083</b>

<b>Punto Soft Van</b>						
1.7 TD [276]	1,7	46	176 B7.000 <M3>	05.97-08.99	BOW	<b>0 460 484 113</b>

<b>Punto Van</b>						
1.7 TD [276]	1,7	51	176 A3.000 <M2>	05.97-08.99	BOW	<b>0 460 484 083</b>
		53	176 A5.000 <M1>	05.97-08.99	BOW	<b>0 460 484 084</b>

<b>Scudo</b>						
1.9 D [220]	1,9	51	D9B <M2>	10.95-05.00	OWK	<b>0 460 484 097</b>
					OWO	<b>0 460 484 064 0 986 440 094</b>
					WEK	<b>0 460 484 098</b>
					WOK	<b>0 460 484 091</b>

TD [220]	1,9	66	DHX <M4>		Ricam.Nr 7666→	12.97-05.00	WZT	<b>0 460 494 455 0 986 440 161</b>	
					Ricam.Nr 7848→	06.98-05.00	WEG	<b>0 460 494 423 0 986 440 156</b>	
					68	D8B <M3>	10.95-05.00	KOB,WEG	<b>0 460 494 423 0 986 440 156</b>
								KOB,WEG	<b>0 460 494 384</b>
								LWG,OWK	<b>0 460 494 411</b>
			LWG,OWO	<b>0 460 494 370</b>					
			LWG,WEK	<b>0 460 494 412</b>					
			LWG,WOK	<b>0 460 494 388</b>					

<b>Siena</b>						
1.7 TD [178]	1,7	46/47	176 B7.000 <M41>; 178 C9.066 <M40>	05.99-12.01	BOW	<b>0 460 484 113</b>
					BOW	<b>0 460 484 154</b>





◀ FIAT

Strada						
1.7 D Turbo	1,7	52			07.99-12.08	0 460 484 083
TDS [278]	1,7	51	176 A3.000 <M10>		03.99-03.03 BOW	0 460 484 083
Ulysse						
1.9 TD [220]	1,9	66	DHX <M4>			
			Ricam.Nr VET.6970→		01.96-05.98	0 460 494 423 0 986 440 156
			DHX <M7>		10.96-12.99 WEG	0 460 494 367
			Ricam.Nr 7666→		12.97-12.99 WZT	0 460 494 455 0 986 440 161
			D8B <M3>		01.95-05.98 OWK	0 460 494 411
					WEK	0 460 494 412
					WOK	0 460 494 384
			Ricam.Nr 6970→		01.96-05.98 OWO	0 460 494 423 0 986 440 156

**FISSORE**

Rayton						
2.4 D Turbo 4x4	2,4	82	HR 492 HIM		03.88-12.01 KOC	0 460 404 042

**FORD**

Escort						
1.8 D	1,8	44	RTF; RTH <Endura-DE>		01.95-11.01 BO,E93, KOC	0 460 484 079

Escort VII						
1.8 D [95]	1,8	44	RT... <D18NA>; RTH <D18NA>		01.95-09.01 BO,E93, KOC	0 460 484 079
					BO,N07	0 460 494 374

Escort VII Express 55						
1.8 D [95]	1,8	44	RTF <D18NA>; RTH <D18NA>		01.95-09.01 BO,E93, KOC	0 460 484 079
					BO,N07	0 460 494 374

Escort VII Express 75						
1.8 D [95]	1,8	44	RTF <D18NA>; RTH <D18NA>		01.95-09.01 BO,E93, KOC	0 460 484 079
					BO,N07	0 460 494 374

Escort VII Turnier						
1.8 D [95]	1,8	44	RTF <D18NA>; RTH <D18NA>		01.95-09.01 BO,E93, KOC	0 460 484 079
					BO,N07	0 460 494 374

Fiesta						
1.8 D	1,8	44	RTC; RTD <Endura-DE>		01.98-04.99	0 460 484 143 0 986 440 107
					05.99-08.03	0 460 484 150 0 986 440 225

Fiesta IV						
1.8 D [96]	1,8	44	RT... <D18, Endura-DE>		10.95-04.99 BO,E96, WEG	0 460 484 144
					BO,E96, WEG	0 460 484 143 0 986 440 107
					10.95-06.01 BO,E93, KOC	0 460 484 079
					BO,N07	0 460 494 374
					05.99-06.01 BO,E96, WEG	0 460 484 152 0 986 440 226
					BO,E96, WEG	0 460 484 150 0 986 440 225
TD [96]	1,8	55	RT... <LD18, Endura-DI>		02.00-12.02 EE2	0 470 004 008 0 986 444 521
					E96,FD3	0 470 004 007 0 986 444 519





<b>Fiesta IV Courier</b>							
1.8 D [96]	1,8	44	RT... <D18, Endura-DE>	10.95-04.99	BO,E96, WEG	0 460 484 144	
					BO,E96, WEG	0 460 484 143	0 986 440 107
				10.95-06.01	BO,E93, KOC	0 460 484 079	
					BO,N07	0 460 494 374	
				05.99-06.01	BO,E96, WEG	0 460 484 152	0 986 440 226
					BO,E96, WEG	0 460 484 150	0 986 440 225
TD [96]	1,8	55	RT... <LD18, Endura-DI>	02.00-12.02	EE2	0 470 004 008	0 986 444 521
					E96,FD3	0 470 004 007	0 986 444 519
<b>Focus I</b>							
1.8 TDDi [99]	1,8	55/66	BHD... <LD18,Endura-DI>; BHDA <LD18,Endura-DI>; BHDB <LD18,Endura-DI>; C9D... <LD18,Endura-DI>; C9DA <LD18,Endura-DI>; C9DB <LD18,Endura-DI>; C9DC <LD18,Endura-DI>	01.99-07.00		0 470 004 007	0 986 444 519
				08.00-05.05		0 470 004 008	0 986 444 521
<b>Focus I Turnier</b>							
1.8 TDDi [99]	1,8	55/66	BHDA <LD18,Endura-DI>; BHDB <LD18,Endura-DI>; C9DA <LD18,Endura-DI>; C9DB <LD18,Endura-DI>; C9DC <LD18,Endura-DI>	01.99-07.00		0 470 004 007	0 986 444 519
				08.00-05.05		0 470 004 008	0 986 444 521
<b>Galaxy</b>							
1.9 TDI [95]	1,9	66/81	AHU <D19N (VW 19N)>; AVG <D19P (VW 19P)>	09.96-03.00		0 460 404 971	0 986 440 555
		81	AFN <D19P (VW 19P)>	11.97-03.00		0 460 404 968	0 986 440 567
<b>Mondeo III</b>							
2.0 TDDi [01]	2,0	66	D5BA <Duratorq-DI>	10.00-03.07		0 470 004 013	0 986 444 520
		85	D6BA <Duratorq-DI>	08.02-08.02		0 470 504 036	0 986 444 075
<b>Mondeo III Turnier</b>							
2.0 TDDi [01]	2,0	66	D5BA <Duratorq-DI>	10.00-03.07		0 470 004 013	0 986 444 520
		85	D6BA <Duratorq-DI>	08.02-08.02		0 470 504 036	0 986 444 075
<b>Ranger</b>							
2.5 D, D 4x4 [99]	2,5	57	WL <MD25NA>	01.99-10.07	TW	9 460 613 382	
						9 460 613 519	
						9 460 613 526	
						9 460 613 527	
TD, TD 4x4 [99]	2,5	62/80-91	WL-T <MD25TI(HP)>; WL-T <MD25TI(NP)>	01.99-10.07	TW	9 460 613 525	
<b>Scorpio II</b>							
2.5 TD [95]	2,5	85/92	SCC <VM25-TCI>; SCD <VM25-TCI>	04.96-12.98		0 460 404 981	
<b>Scorpio II Turnier</b>							
2.5 TD [95]	2,5	85/92	SCC <VM25-TCI>; SCD <VM25-TCI>	04.96-12.98		0 460 404 981	
<b>Tourneo Connect</b>							
1.8 TDDi [02]	1,8	55	BHPA <Euro3>; BHPB <93EEC>	05.02-06.10		0 470 004 008	0 986 444 521

**HONDA**

<b>Accord Hatchback</b>							
2.0 TDi [CH8]	2,0	77	20T2N	01.99-10.00		0 460 414 992	0 986 440 522
<b>Accord Sedan</b>							
2.0 D Turbo [CF1]	2,0	77	20T2N	09.95-10.98	EDC	0 460 414 992	0 986 440 522
TDi [CH2]	2,0	77	20T2N	01.99-02.03		0 460 414 992	0 986 440 522
<b>Civic Aerodeck</b>							
2.0 D Turbo [MB/MC]	2,0	77	20T2N	04.98-02.01		0 460 414 992	0 986 440 522

**JEEP**

<b>Cherokee</b>							
2.5 D Turbo [XJ]	2,5	85-89	ENC,ENO <VM HR 425 CLIRX>	10.95-12.01	KOC	0 460 404 078	





**KIA**

Carnival						
2.9 D Turbo	2,9	92	JRTC1		03.00-03.03	<b>0 460 414 178</b>
D Turbo [UP]	2,9	93	J3		06.98-09.01 AG	<b>0 460 414 193</b>
					GS	<b>0 460 414 191</b>
Sedona						
2.9 D Turbo [UP]	2,9	93	J3		06.98-09.01 AG	<b>0 460 414 193</b>
					GS	<b>0 460 414 191</b>

**LADA**

Niva						
1.5 TD	1,5	48	3411		09.94-12.99	<b>0 460 484 147</b>
1.8 TD	1,8	55	3431		07.99-12.00	<b>0 460 484 147</b>
Serie 2100						
2104 1.5 TD	1,5	48	341		01.97-12.00	<b>0 460 484 147</b>

**LANCIA**

Dedra Berlina						
1.9 TD [835]	1,9	66	835A4.000/160D1.000 <M1/M2>		10.94-10.99 EU2,KOC,	<b>0 460 494 339</b>
					WEG	
					EU2,WEG	<b>0 460 494 390</b>
					EU2,KOC,	<b>0 460 494 304</b>
					WEG	
					EU2,WEG	<b>0 460 494 389</b>
Dedra Station Wagon						
1.9 TD [835]	1,9	66	835A4.000/160D1.000 <M1/M2>		10.94-10.99 EU2,KOC,	<b>0 460 494 339</b>
					WEG	
					EU2,WEG	<b>0 460 494 390</b>
					EU2,KOC,	<b>0 460 494 304</b>
					WEG	
					EU2,WEG	<b>0 460 494 389</b>
Delta						
1.9 TD [836]	1,9	66	160D1.000 <SQ M2>	A,D	10.95-08.98 WEG	<b>0 460 494 390</b>
				A,D	10.95-12.99 KOC	<b>0 460 494 339</b>
Kappa Berlina						
2.4 TD [838]	2,4	91	838A7.000 <M2>		06.96-03.98	<b>0 460 495 998</b>
Kappa Station Wagon						
2.4 D Turbo [838]	2,4	91	838A7.000 <M2>		06.96-03.98	<b>0 460 495 998</b>

**LAND ROVER GROUP**

Defender 90						
2.5 D Turbo	2,5	80-83	Gemini TCI D.I. 23L <200/300 Tdi>			
			Mot.-Nr. →23L 03832 A		09.94-12.01 AGR,WEG	<b>0 460 414 099</b>
			Mot.-Nr. 11 L ...→		08.90-12.01 KOC	<b>0 460 414 080</b>
			Mot.-Nr. 16L ...→		09.94-12.01 AGR	<b>0 460 414 098 0 986 440 038</b>
			Mot.-Nr. 23 L 03833 A→		09.94-12.01 AGR,WEG	<b>0 460 414 136</b>
Defender 110						
2.5 D Turbo	2,5	65-83	Gemini TCI D.I. 23L <200/300 Tdi>			
			Mot.-Nr. →23L 03832 A		09.94-12.01 AGR,WEG	<b>0 460 414 099</b>
			Mot.-Nr. 11 L ...→		08.90-12.01 KOC	<b>0 460 414 080</b>
			Mot.-Nr. 16L ...→		09.94-12.01 AGR	<b>0 460 414 098 0 986 440 038</b>
			Mot.-Nr. 23 L 03833 A→		09.94-12.01 AGR,WEG	<b>0 460 414 136</b>
		85	Maxion HS4TCC <Euro I>		08.98-12.05 TW	<b>0 460 414 194</b>
						<b>0 460 414 205</b>





Defender 130						
2.5 D Turbo	2,5	80-83	Gemini TCI D.I. 23L <200/300 Tdi>			
			Mot.-Nr. →23L 03832 A	09.94-12.01	AGR,WEG	0 460 414 099
			Mot.-Nr. 11 L ...→	08.90-12.01	KOC	0 460 414 080
			Mot.-Nr. 16L ...→	09.94-12.01	AGR	0 460 414 098 0 986 440 038
			Mot.-Nr. 23 L 03833 A→	09.94-12.01	AGR,WEG	0 460 414 136
Discovery I						
2.5 TDi	2,5	82-90	19L 21L 22L 23L 300	10.93-12.98	AGF	0 460 414 098 0 986 440 038
			Fg.-Nr. VA 703237→VA 534104→	10.93-12.98	AGR	0 460 414 136
					AGR	0 460 414 991
			Fg.-Nr. →TA 703236 →TA 534103	10.93-12.98	AGR	0 460 414 099
					AGR,KOC	0 460 414 997
Freelander I						
2.0 D [LN]	2,0	70-72	20T2N <L-Serie>	09.97-09.03		0 460 404 973 0 986 440 507
Range Rover II						
2.5 D [LP]	2,5	100-102	25 6T	09.94-08.02		0 460 406 994 0 986 440 516

MAHINDRA

Bolero						
2.5 D	2,5	53	XD 3P IDI	08.00-04.05	BS1	0 460 494 479
D, D XL, D XLS, D 4WD	2,5	46	MDI 3200 TC; MDI 3200TC	05.05-02.07	TW	0 460 414 251
						0 460 414 254
D XL	2,5	43	MDI 3200 D	02.04-03.05	BS1	0 460 414 197
					BS2	0 460 414 231
D XLS	2,5	44,5	XD 3PH	02.04-12.05	BS1	0 460 494 479
D 4WD	2,5	53	XD 3P IDI	08.00-04.05		0 460 494 479
Bolero Invader						
2.5 D	2,5	40	MDI 3200	03.03-10.04		0 460 414 197
D, D 4WD	2,5	46	MDI 3200 TC	12.04-06.07	TW	0 460 414 251
						0 460 414 254
D GLX	2,5	53	XD 3P IDI	03.03-10.04		0 460 494 479
Classic						
2.1 D 4WD	2,1	46	XDP 4.90	04.96-05.98		0 460 494 434
MM 540/550						
DP 2.1 D 4WD	2,1	46	XDP 4.90 C	04.96→		0 460 494 434
Voyager						
2.5 D	2,5	53	XD 3PBM	11.97-01.03		0 460 494 479



MAZDA

MPV						
2.5 12V D Turbo [LV]	2,5	85	WLT	03.96-05.99	ZDA	9 460 614 272
Serie B						
2500 D [UN]	2,5	57	MD25NA	02.99-03.06		9 460 613 527
				TR 02.99-03.06		9 460 613 519
D Turbo, D Turbo 4x4 [UN]	2,5	62	WLE7	09.01-03.06	EU3,ZDA	9 460 614 809
			Fg.-Nr. →322592	09.01-03.06	EU3,ZDA	9 460 614 206
D Turbo 4x4 [UN]	2,5	64-80	WLT			
			Fg.-Nr. →322592	02.99-03.06	EU3	9 460 613 941
					<del>EU3</del>	9 460 613 522
			Fg.-Nr. 322593→	02.99-03.06	EU3,ZDA	9 460 614 206
					<del>EU3,ZDA</del>	9 460 614 208
D 4x4 [UN]	2,5	57	MD25NA	02.99-03.06		9 460 613 527
				TR 02.99-03.06		9 460 613 519
12V D [UF]	2,5	63	WL	03.96-05.99	ZDA	9 460 613 266
12V D 4x4 [UF]	2,5	57-63	WL	03.96-05.99	ZDA	9 460 613 266
323						
2.0 D [BJ]	2,0	52	RF	05.98-10.00	ZDA	9 460 613 193
323 Hatchback						
2.0 D [BJ]	2,0	52	RF	06.98-09.99	ZDA	9 460 613 193





**MERCEDES-BENZ**

Serie E							
290 D Turbo [210]	2,9	95	OM 602.982 <DE LA>	01.96-07.99	EDC	<b>0 460 415 991</b>	<b>0 986 440 530</b> <b>0 986 440 578</b>
Serie E (T-Modell)							
290 D Turbo [210]	2,9	95	OM 602.982 <DE LA>	05.96-07.99	EDC	<b>0 460 415 991</b>	<b>0 986 440 530</b> <b>0 986 440 578</b>
Serie G							
290 DT [461]	2,9	90	OM 602.983	04.97-09.01	TW	<b>0 460 415 992</b>	<b>0 986 440 531</b>
			Komp.Nr. 180 Komp.Nr. ML9				<b>0 986 440 579</b>
			Komp.Nr. 180 Komp.Nr. ML9				<b>0 460 415 982</b>

**MG**

ZR							
2.0 D Turbo	2,0	74/82	20 T2N <L-Serie>	10.01-05.05		<b>0 470 004 005</b>	<b>0 986 444 503</b>
ZS							
2.0 TD	2,0	74	20 T2N <L-Serie>	10.01-05.05		<b>0 470 004 005</b>	<b>0 986 444 503</b>

**MITSUBISHI**

L 200							
2.5 D, D 4WD [K6/K7]	2,5	64	4D56	01.96-06.01	LLE	<b>9 460 614 549</b>	
				01.96-12.07	RLE,ZDA	<b>9 460 614 157</b>	
D Turbo Interc. 2WD [K6/K7]	2,5	74-85	4D56	01.96-12.07	AG,ZDA	<b>9 460 613 999</b>	
					GS,ZDA	<b>9 460 613 955</b>	
D Turbo Interc. 4WD [K6/K7]	2,5	73-85	4D56	01.96-03.98	ABS,GS,	<b>9 460 610 915</b>	
					WEG		
					ABS,GS,	<b>9 460 610 961</b>	
					WEG		
					AG,WEG,	<b>9 460 613 177</b>	
					ZDA		
					AG,WEG	<b>9 460 610 962</b>	
					ABS,GS,	<b>9 460 610 913</b>	
					WEG		
					ABS,GS,	<b>9 460 610 960</b>	
					WEG		
					01.96-12.07	RLE,ZDA	<b>9 460 614 157</b>
04.98-06.01	AG,WEG	<b>9 460 613 232</b>					
	AG,WEG,	<b>9 460 614 544</b>					
	ZDA						
	GS,WEG,	<b>9 460 614 187</b>					
07.01-12.07	ZDA						
	GS,WEG	<b>9 460 613 234</b>					
	AG,ZDA	<b>9 460 613 999</b>					
	GS,ZDA	<b>9 460 613 955</b>					
D Turbo 4WD [K0-K3]	2,5	73	4D56	06.94-03.01	TW,ZDA	<b>9 460 610 671</b>	
				04.95-03.01	TW,ZDA	<b>9 460 613 396</b>	





<b>2.5 D 2WD [K6/K7]</b>	2,5	55-64	4D56	06.95-03.98	ABS,FKR, WEG,ZDA	<b>9 460 611 605</b>
					ABS,FKR, WEG,ZDA	<b>9 460 612 412</b>
				06.95-06.01	ABS	<b>9 460 610 959</b>
					FLR,LLE	<b>9 460 614 549</b>
					FLR,RLE, ZDA	<b>9 460 614 157</b>
				04.98-06.01	FKR,WEG, ZDA TW	<b>9 460 614 104</b> <b>9 460 613 230</b>

**L 200 Forte**

<b>2.5 D Turbo Interc. 4WD [K7]</b>	2,5	73-85	4D56	01.97-03.98	ABS,GS, WEG	<b>9 460 610 915</b>
					ABS,GS, WEG	<b>9 460 610 961</b>
					AG,WEG, ZDA	<b>9 460 613 177</b>
					AG,WEG	<b>9 460 610 962</b>
					ABS,GS, WEG	<b>9 460 610 913</b>
					ABS,GS, WEG	<b>9 460 610 960</b>
				01.97→	RLE,ZDA	<b>9 460 614 158</b>
				04.98-06.01	AG,WEG, GS,WEG, ZDA	<b>9 460 613 232</b> <b>9 460 614 187</b>
				04.98→	AG,WEG, ZDA	<b>9 460 614 544</b>
					GS,WEG	<b>9 460 613 234</b>
				07.01→	AG,WEG, ZDA	<b>9 460 613 999</b>
					GS,WEG, ZDA	<b>9 460 613 955</b>

**L 300 Wagon**

<b>2.5 D 2WD long [P]</b>	2,5	51	4D56	07.95-12.00		<b>9 460 610 683</b>
---------------------------	-----	----	------	-------------	--	----------------------

**L 400**

<b>2.5 D Turbo 2WD, D Turbo 4WD</b>	2,5	64	4D56	12.94-03.01	AGF	<b>9 460 610 687</b>
					AGF	<b>9 460 610 685</b>

**Pajero**

<b>2.5 TD Interc. [V]</b>	2,5	73-77	4D56	CH 12.90-06.00		<b>9 460 610 546</b>
				CH 06.97-02.98	WEG,ZDA WEG	<b>9 460 612 419</b> <b>9 460 612 420</b>
				03.98-06.00	EU2,WEG, ZDA	<b>9 460 614 187</b>
					EU2,WEG	<b>9 460 613 234</b>
					EU3,ZDA	<b>9 460 613 955</b>
				TD Interc. 4WD [V60; V70]	2,5	73-85
				07.01-08.06	ZDA	<b>9 460 613 981</b>
<b>2.8 D [V]</b>	2,8	92	4M40	06.94-05.99	ZDA	<b>9 460 614 156</b>
TD Interc. 4WD [V]	2,8	103	4M40	11.93-04.00	ABS,FMA	<b>9 460 610 647</b>
					ABS,KL	<b>9 460 614 513</b>
					ABS,KL, ZDA	<b>9 460 614 111</b>
					ZDA	
<b>3.2 DI-D [V]</b>	3,2	121		05.00→	ZDA	<b>F 019 Z1D 003</b>
DI-D 4WD [V60; V70]	3,2	118-121	4M41	02.00-11.00	ZDA	<b>F 019 Z1D 003</b>
				12.00-08.06	ZDA	<b>F 019 Z1D 007</b>

**Pajero Cabrio**

<b>2.5 TD Interc. 4WD [V]</b>	2,5	73-77	4D56	CH 12.90-05.01		<b>9 460 610 546</b>
				CH 06.96-02.98	WEG	<b>9 460 611 612</b>
					WEG,ZDA	<b>9 460 611 565</b>
				03.98-05.01	WEG,ZDA	<b>9 460 614 187</b>
					WEG	<b>9 460 613 234</b>





◀ MITSUBISHI

<b>Pajero Sport</b>						
2.5 TD [K]	2,5	73-85	4D56	08.98-06.01		<b>9 460 613 234</b>
				07.01-02.09	ZDA	<b>9 460 613 955</b>
TD+ [K]	2,5	98	4D56	07.01-02.09	ZDA	<b>9 460 613 955</b>
<b>Space Gear</b>						
2.5 D Turbo Interc. 2WD, D Turbo Interc. 4WD, D Turbo 2WD short	2,5	64/73	4D56	06.96-02.98	ABS,WEG, ZDA	<b>9 460 614 530</b>
					ABS,WEG, ZDA	<b>9 460 614 531</b>
					ABS,WEG, ZDA	<b>9 460 612 415</b>
					ABS,WEG, ZDA	<b>9 460 613 499</b>
				03.98-03.01	WEG,ZDA	<b>9 460 614 546</b>
					WEG,ZDA	<b>9 460 614 161</b>

**NISSAN**

<b>Almera</b>						
2.0 D [N15]	2,0	55	CD20	04.96-04.00	EDC	<b>9 460 611 579</b>
<b>Almera Hatchback</b>						
2.0 D [N15]	2,0	55	CD20	04.96-04.00	EDC	<b>9 460 611 579</b>
<b>Patrol</b>						
2.8 D [260]	2,8	80	RD28	04.89-05.98	ZDA	<b>9 460 610 573</b>
D Turbo [260]	2,8	85	RD28T	06.89-05.98		<b>9 460 610 574</b>
					AGF,ZDA	<b>9 460 610 600</b>
<b>Patrol GR</b>						
2.8 D Turbo, D Turbo 4x4 [Y61]	2,8	95-96	RD28TI	10.97-02.00		<b>9 460 611 586</b>
3.0 Di Hardtop 4x4, Di 4x4 [Y61]	3,0	116	ZD30DDTI	02.00-07.04		<b>9 443 615 728</b>
<b>Pickup</b>						
2.5 D, D 4WD [D21]	2,5	59-63	TD25	08.87-02.98		<b>9 460 610 314</b>
D, D 4WD [D22]	2,5	61	TD25	02.98-11.01	WEG,ZDA	<b>9 460 613 482</b>
					WEG	<b>9 460 611 649</b>
D Turbo 4WD [D22]	2,5	76	TD25TI	05.98-11.01	WEG,ZDA	<b>9 460 614 027</b>
2.7 D 2WD [D22]	2,7	64	TD27	02.97-11.11	TW,ZDA	<b>9 460 611 352</b>
						<b>9 460 611 960</b>
3.2 D 4WD [D22]	3,2	76	QD32	02.97-06.01	TW,ZDA	<b>9 460 611 356</b>
				02.97-→	TW,ZDA	<b>9 460 611 426</b>
						<b>9 460 611 427</b>
						<b>9 460 611 428</b>
						<b>9 460 614 012</b>
						<b>9 460 614 013</b>
						<b>9 460 614 076</b>
						<b>9 460 614 437</b>
						<b>9 460 614 438</b>
<b>Primera Hatchback</b>						
2.0 D Turbo [P11E]	2,0	66	CD20T	11.97-12.01		<b>0 460 404 965</b>
<b>Primera Sedan</b>						
2.0 D Turbo [P11E]	2,0	66	CD20T	11.97-12.01		<b>0 460 404 965</b>
<b>Primera Wagon</b>						
2.0 D Turbo [WP11E]	2,0	66	CD20T	01.98-12.01		<b>0 460 404 965</b>
<b>Serena</b>						
2.3 D [C23]	2,3	55	LD23	11.95-03.98	AGF,WEG	<b>0 460 494 404</b>
				07.96-03.98	TW,WEG	<b>0 460 494 355</b>
				04.98-07.99	AGF,WEG	<b>0 460 494 461</b>
					AGF,TW	<b>0 460 494 465</b>
					AGF,WEG	<b>0 460 494 469</b>
					AGF,TW	<b>0 460 494 468</b>
				08.99-11.01		<b>0 460 494 461</b>
<b>Sunny</b>						
2.0 D	2,0	56	CD20	01.94-→		<b>9 460 610 557</b>
D [B14]	2,0	56	CD20	01.94-09.99		<b>9 460 611 338</b>





<b>Sunny Wagon</b>							
1.7 D [Y10]	1,7	40	CD17 <VA>	BG,PL,RO	05.92-04.98	<b>9 460 610 593</b>	
				BG,PL,RO	05.92-04.98	<b>9 460 610 597</b>	
2.0 D [Y10]	2,0	55	CD20 <VC>		11.90-03.00	<b>9 460 610 553</b>	
					SLX	<b>9 460 610 550</b>	
<b>Terrano II</b>							
2.7 D Turbo 4x4 [R20]	2,7	74	TD27T		04.99-10.99	KL,TW,ZDA	<b>9 460 610 702</b>
					12.99-02.02	ZDA	<b>9 460 610 702</b>
		91-92	TD27Ti		01.96-12.06	DKF,EDC	<b>9 460 613 261</b>
					10.97-12.06	BO,EDC	<b>0 460 404 974 0 986 440 508</b>
					04.99-02.02	EDC,TW,ZDA	<b>9 460 610 702</b>
		92	TD27Ti		11.98-12.99	EDC,TW	<b>0 460 404 974 0 986 440 508</b>
					11.98→	TW,ZDA	<b>9 461 610 088</b>
					01.00→	TW	<b>9 460 613 261</b>
<b>Xterra</b>							
2.8 D [N50]	2,8	97	4.07 TCA <Euro II (WM28TI)>		02.03-07.05	<b>0 460 424 245</b>	

**OPEL**

<b>Astra</b>							
1.7 DT [G]	1,7	50	X 17 DTL		03.98-08.00	<b>0 470 004 003 0 986 444 500</b>	
TD [F]	1,7	50	X 17 DTL		09.94-02.98	WEG	<b>0 460 494 353 0 986 440 150</b>
						WEG	<b>0 460 494 372 0 986 440 152</b>
		60	17 TD/TC4 <OHC EE1>		12.91-02.98	DKF,KL, WEG,ZDA	<b>9 460 620 011</b>
						DKF,KL, WEG	<b>9 460 620 013</b>
						DKF,KL, WEG	<b>9 460 620 020</b>
				Mot.-Nr. →076350	12.91-02.98	DKF,KL, WEG	<b>9 460 620 017 9 460 620 017</b>
				Mot.-Nr. 076351→	12.91-02.98	DKF,KL, WEG	<b>9 460 620 021</b>
2.0 DT [G]	2,0	60	X 20 DTL <Ecotec 16V Turbo>		02.98-08.00	EU2,NC8	<b>0 470 504 003 0 986 444 002</b>
						EU3,NT5	<b>0 470 504 011 0 986 444 012</b>
DTI [G]	2,0	74	Y 20 DTH <Ecotec>				
			Fg.-Nr. →Y2999999 →Y5999999 →Y6999999 →Y8999999 →YH999999	09.99-01.05			<b>0 470 504 011 0 986 444 012</b>
			Fg.-Nr. 12000001→22999999	09.99-01.05			<b>0 470 504 015 0 986 444 014</b>
			15000001→25999999 16000001→26999999				
			18000001→28999999 1H000001→2H999999				
			Fg.-Nr. 32000001→ 35000001→ 36000001→ 38000001→ 3H000001→	09.99-01.05	THS		<b>0 470 504 218 0 986 444 036</b>
DTL [G]	2,0	60	Y 20 DTL <Turbo>		09.00-01.04	EU2,NC8	<b>0 470 504 003 0 986 444 002</b>
						EU3,NT5	<b>0 470 504 011 0 986 444 012</b>
2.2 DTI [G]	2,2	92	Y 22 DTR <Ecotec>				
			Fg.-Nr. →22999999 →25999999 →26999999 →28999999 →2H999999	09.01-01.04	THS		<b>0 470 504 209 0 986 444 028</b>
			Fg.-Nr. 32000001→ 35000001→ 36000001→ 38000001→ 3H000001→	09.01-01.04	THS		<b>0 470 504 219 0 986 444 037</b>
<b>Astra Cabrio</b>							
2.2 DTI [G]	2,2	92	Y 22 DTR <Ecotec>				
			Fg.-Nr. →22999999 →25999999 →26999999 →28999999 →2H999999	03.02-08.05	THS		<b>0 470 504 209 0 986 444 028</b>
			Fg.-Nr. 32000001→ 35000001→ 36000001→ 38000001→ 3H000001→	03.02-08.05	THS		<b>0 470 504 219 0 986 444 037</b>
<b>Astra Caravan</b>							
1.7 DT [G]	1,7	50	X 17 DTL		03.98-08.00	<b>0 470 004 003 0 986 444 500</b>	





◀ OPEL

1.7 TD [F]	1,7	50	X 17 DTL	08.94-02.98	WEG	0 460 494 353	0 986 440 150
					WEG	0 460 494 372	0 986 440 152
1.7 TD [F]	1,7	60	17 TD/TC4 <OHC EE1>	12.91-02.98	DKF, KL, WEG, ZDA	9 460 620 011	
					DKF, KL, WEG	9 460 620 013	
					DKF, KL, WEG	9 460 620 020	
			Mot.-Nr. →076350	12.91-02.98	DKF, KL, WEG	9 460 620 017	9 460 620 017
			Mot.-Nr. 076351→	12.91-02.98	DKF, KL, WEG	9 460 620 021	
2.0 DT [G]	2,0	60	X 20 DTL <Ecotec 16V Turbo>	02.98-08.00	EU2, NC8	0 470 504 003	0 986 444 002
					EU3, NT5	0 470 504 011	0 986 444 012
DTI [G]	2,0	74	Y 20 DTH <Ecotec>				
			Fg.-Nr. →Y2999999 →Y5999999 →Y6999999 →Y8999999 →YH999999	09.00-06.04		0 470 504 011	0 986 444 012
			Fg.-Nr. 12000001→22999999	09.00-06.04		0 470 504 015	0 986 444 014
			15000001→25999999 16000001→26999999				
			18000001→28999999 1H000001→2H999999				
			Fg.-Nr. 32000001→ 35000001→ 36000001→ 38000001→ 3H000001→	09.00-06.04	THS	0 470 504 218	0 986 444 036
DTL [G]	2,0	60	Y 20 DTL <Turbo>	09.00-06.04	EU2, NC8	0 470 504 003	0 986 444 002
					EU3, NT5	0 470 504 011	0 986 444 012
2.2 DTI [G]	2,2	92	Y 22 DTR <Ecotec>				
			Fg.-Nr. →22999999 →25999999 →26999999 →28999999 →2H999999	09.01-06.04	THS	0 470 504 209	0 986 444 028
			Fg.-Nr. 32000001→ 35000001→ 36000001 → 38000001→ 3H000001→	09.01-06.04	THS	0 470 504 219	0 986 444 037
<b>Astra Coupé</b>							
2.2 DTI [G]	2,2	92	Y 22 DTR <Ecotec>				
			Fg.-Nr. →22999999 →25999999 →26999999 →28999999 →2H999999	03.02-02.05	THS	0 470 504 209	0 986 444 028
			Fg.-Nr. 32000001→ 35000001→ 36000001→ 38000001→ 3H000001→	03.02-02.05	THS	0 470 504 219	0 986 444 037
<b>Combo</b>							
1.7 D	1,7	44	X 17 D 4EE1; 17 D <4EE1>				
			Mot.-Nr. →076351	09.94-10.01	DKF, WEG	9 460 620 010	9 460 620 010
			Mot.-Nr. 076352→092141	09.94-10.01	DKF, WEG	9 460 620 019	
			Mot.-Nr. 092142→	09.94-10.01	DKF, WEG	9 460 620 023	
			Mot.-Nr. 877698→076351	09.94-10.01	DKF, WEG	9 460 620 016	
<b>Corsa</b>							
1.5 D [B]	1,5	37	15 D <4EC1>				
			Mot.-Nr. →877695	03.93-08.00	DKF, WEG	9 460 620 008	9 460 620 008
			Mot.-Nr. 877696→	03.93-08.00	DKF, WEG	9 460 620 014	
TD [B]	1,5	49	15 TD <T4EC1 Turbo>	03.93-08.00	DKF, WEG	9 460 620 009	9 460 620 009
			Mot.-Nr. 877708→	03.93-08.00	DKF, WEG	9 460 620 015	9 460 620 015
XD [B]	1,5	37	X 15 D <4EC1>				
			Mot.-Nr. →877695	04.96-08.00	DKF, WEG	9 460 620 008	9 460 620 008
			Mot.-Nr. 877696→	04.96-08.00	DKF, WEG	9 460 620 014	
XTD [B]	1,5	49	X 15 TD <4EE1 Turbo>	04.96-08.00	DKF, WEG	9 460 620 009	9 460 620 009
			Mot.-Nr. 877708→	04.96-08.00	DKF, WEG	9 460 620 015	9 460 620 015
1.7 D [B]	1,7	44	X 17 D <4EE1>				
			Mot.-Nr. →076351	04.96-08.00	DKF, WEG	9 460 620 010	9 460 620 010
			Mot.-Nr. 076352→092141	04.96-08.00	DKF, WEG	9 460 620 019	
			Mot.-Nr. 092142→	04.96-08.00	DKF, WEG	9 460 620 023	
			Mot.-Nr. 877698→076351	04.96-08.00	DKF, WEG	9 460 620 016	
			17 D <4EE1>				
			Mot.-Nr. →076351	03.93-08.00	DKF, WEG	9 460 620 010	9 460 620 010
			Mot.-Nr. 076352→092141	03.93-08.00	DKF, WEG	9 460 620 019	
			Mot.-Nr. 092142→	03.93-08.00	DKF, WEG	9 460 620 023	
			Mot.-Nr. 877698→076351	03.93-08.00	DKF, WEG	9 460 620 016	
D Utility [B]	1,7	42	X 17 D4EE1	09.98-10.05		9 460 620 023	



<b>Frontera</b>													
2.2 DTI [B]	2,2	85	X 22 DTH <Turbo>		09.98-10.02		<b>0 470 504 009</b>	<b>0 986 444 005</b>					
		88	Y 22 DTH <Turbo>		09.02-09.04	THS	<b>0 470 504 217</b>	<b>0 986 444 030</b>					
2.5 TDS Turbo [A]	2,5	85	VM 41 B <Venturi-25TD>		06.96-08.98		<b>0 460 404 991</b>						
2.8 TDI [A]	2,8	83	4JB1T <(28TD)>		02.95-08.98	DKF,WEG	<b>9 460 611 452</b>						
			Fg.-Nr. →SV799999		02.95-08.98	DKF,WEG	<b>9 460 610 708</b>						
<b>Omega</b>													
2.0 DTI Turbo [B]	2,0	74	X 20 DTH		09.97-08.00	EU2,NC8	<b>0 470 504 009</b>	<b>0 986 444 005</b>					
						FD3,NT5	<b>0 470 504 011</b>	<b>0 986 444 012</b>					
2.2 DTI [B]	2,2	88	Y 22 DTH <Turbo>		06.00-07.03	NC9	<b>0 470 504 016</b>	<b>0 986 444 021</b>					
2.5 TD [B]	2,5	96	U 25 TD; X 25 TD		04.94-02.01		<b>0 460 406 994</b>	<b>0 986 440 516</b>					
<b>Signum</b>													
2.0 DTI	2,0	74	Y 20 DTH <Ecotec>		05.03-09.05	THS	<b>0 470 504 217</b>	<b>0 986 444 030</b>					
2.2 DTI	2,2	86-92	Y 22 DTR <Ecotec>		05.03-09.05	THS	<b>0 470 504 217</b>	<b>0 986 444 030</b>					
<b>Sintra</b>													
2.2 TD	2,2	85	X 22 DTH <Turbo>		09.97-09.99		<b>0 470 504 009</b>	<b>0 986 444 005</b>					
<b>Vectra</b>													
1.7 TD [B]	1,7	60	X 17 TD <TC4 EE1>		09.95-09.98	DKF,KL, WEG,ZDA	<b>9 460 620 011</b>						
						DKF,KL, WEG	<b>9 460 620 013</b>						
						DKF,KL, WEG	<b>9 460 620 020</b>						
						Mot.-Nr. →076356	DKF,KL, WEG	<b>9 460 620 017</b>	<b>9 460 620 017</b>				
						Mot.-Nr. 076357→	DKF,KL, WEG	<b>9 460 620 021</b>					
2.0 DI [B]	2,0	60	X 20 DTL <Ecotec 16V Turbo>		09.96-08.02	EU2,NC8	<b>0 470 504 003</b>	<b>0 986 444 002</b>					
						FD3,NT5	<b>0 470 504 011</b>	<b>0 986 444 012</b>					
						TW	<b>0 470 504 002</b>	<b>0 986 444 001</b>					
				DTI [B]		2,0	74	X 20 DTH	09.97-08.03	EU2,NC8	<b>0 470 504 004</b>	<b>0 986 444 003</b>	
								Y 20 DTH <Ecotec>	09.00-09.03	EU3,NT5	<b>0 470 504 011</b>	<b>0 986 444 012</b>	
			DTI, DTI GTS [C]	2,0	74	Y 20 DTH <Ecotec>	04.02-09.05	THS	<b>0 470 504 210</b>	<b>0 986 444 029</b>			
2.2 DTI [B]	2,2	92	Y 22 DTR <Ecotec>		09.00-09.03		<b>0 470 504 016</b>	<b>0 986 444 021</b>					
			DTI, DTI GTS [C]	2,2	86-92	Y 22 DTR <Ecotec>	04.02-09.05	THS	<b>0 470 504 209</b>	<b>0 986 444 028</b>			
<b>Vectra Caravan</b>													
1.7 TD [B]	1,7	60	X 17 TD <TC4 EE1>		09.95-09.98	DKF,KL, WEG,ZDA	<b>9 460 620 011</b>						
						DKF,KL, WEG	<b>9 460 620 013</b>						
						DKF,KL, WEG	<b>9 460 620 020</b>						
						Mot.-Nr. →076356	DKF,KL, WEG	<b>9 460 620 017</b>	<b>9 460 620 017</b>				
						Mot.-Nr. 076357→	DKF,KL, WEG	<b>9 460 620 021</b>					
2.0 DI [B]	2,0	60	X 20 DTL <Ecotec 16V Turbo>		09.96-08.00	EU2,NC8	<b>0 470 504 003</b>	<b>0 986 444 002</b>					
						FD3,NT5	<b>0 470 504 011</b>	<b>0 986 444 012</b>					
						TW	<b>0 470 504 002</b>	<b>0 986 444 001</b>					
				DTI [B]		2,0	74	X 20 DTH	09.97-08.03	EU2,NC8	<b>0 470 504 004</b>	<b>0 986 444 003</b>	
								Y 20 DTH <Ecotec>	09.00-09.03	EU3,NT5	<b>0 470 504 011</b>	<b>0 986 444 012</b>	
			DTI [C]	2,0	74	Y 20 DTH <Ecotec>	09.03-09.05	THS	<b>0 470 504 210</b>	<b>0 986 444 029</b>			
2.2 DTI [B]	2,2	92	Y 22 DTR <Ecotec>		09.00-09.03		<b>0 470 504 016</b>	<b>0 986 444 021</b>					
			DTI [C]	2,2	86-92	Y 22 DTR <Ecotec>	09.03-09.05	THS	<b>0 470 504 209</b>	<b>0 986 444 028</b>			
<b>Zafira</b>													
2.0 DI [A]	2,0	60	X 20 DTL <Ecotec 16V Turbo>		03.99-08.00	EU2,NC8	<b>0 470 504 003</b>	<b>0 986 444 002</b>					
						EU3,NT5	<b>0 470 504 011</b>	<b>0 986 444 012</b>					
				DTI [A]		2,0	74	Y 20 DTH <Ecotec>					
			Fg.-Nr. →22999999		04.99-07.05		<b>0 470 504 015</b>	<b>0 986 444 014</b>					
			Fg.-Nr. 32000001→ 35000001→ 36000001→		04.99-07.05	AG,THS	<b>0 470 504 217</b>	<b>0 986 444 030</b>					
			38000001→ 3H000001→ 4G000001→			GS,THS	<b>0 470 504 218</b>	<b>0 986 444 036</b>					







◀ OPEL

2.2 DTI [A]	2,2	92	Y 22 DTR <Ecotec> Fg.-Nr. →22999999 →25999999 →26999999 →28999999 →2H999999	03.02-07.05	THS	<b>0 470 504 209</b>	<b>0 986 444 028</b>
			Fg.-Nr. 32000001→35000001→ 36000001→38000001→3H000001→	03.02-07.05	THS	<b>0 470 504 219</b>	<b>0 986 444 037</b>

**PEUGEOT**

Expert							
1.9 D [U64]	1,9	51-52	D9B <XUD9>	09.95-05.00	OWK	<b>0 460 484 097</b>	
					OWO	<b>0 460 484 064</b>	<b>0 986 440 094</b>
					WEK	<b>0 460 484 098</b>	
					WOK	<b>0 460 484 091</b>	
D Turbo [U64]	1,9	66-68	DHX <XUD9TE>	09.95-05.00	WEG	<b>0 460 494 423</b>	<b>0 986 440 156</b>
					WEG	<b>0 460 494 427</b>	
			Org.-Nr. 7665→	12.97-05.00	EFV,WZT	<b>0 460 494 455</b>	<b>0 986 440 161</b>
		68	D8B <XUD9TE>	09.95-07.98	WEG	<b>0 460 494 423</b>	<b>0 986 440 156</b>
					N03,WEG	<b>0 460 494 384</b>	
					N09,OWK	<b>0 460 494 411</b>	
					N09,OWO	<b>0 460 494 370</b>	
					N09,WEK	<b>0 460 494 412</b>	
					N09,WOK	<b>0 460 494 388</b>	

Partner							
1.9 D	1,9	51	DW8	10.99-12.14		<b>0 460 494 463</b>	
D [M4]	1,9	50	DJY <XUD9Y>	07.96-08.02	BOW	<b>0 460 484 070</b>	
			Org.-Nr. 7665→	12.97-08.02	BO,EFV, WZT	<b>0 460 484 137</b>	
		51	WJZ <DW8>	11.98-08.02	BOW	<b>0 460 494 462</b>	
					BOW	<b>0 460 494 463</b>	

Ranch							
1.9 D [M4]	1,9	51	WJZ <DW8>	11.98-08.02	BOW	<b>0 460 494 462</b>	
					BOW	<b>0 460 494 463</b>	

106							
1.5 D [S2]	1,5	40	VJY <TUD5>	05.96-05.05	BOW	<b>0 460 484 099</b>	
			Org.-Nr. 7511→7706	07.97-01.98	BO,WZT	<b>0 460 484 138</b>	
			Org.-Nr. 7707→	02.98-05.05	BO,WZT	<b>0 460 484 142</b>	
		40-42	VJZ <TUD5>	05.96-05.05	AGF,BOW	<b>0 460 484 100</b>	
					BOW,KL	<b>0 460 484 078</b>	
					BOW,KL	<b>0 460 484 099</b>	
					BOW,VAE	<b>0 460 484 099</b>	
			Org.-Nr. 7511→7706	07.97-01.98	BO,WZT	<b>0 460 484 138</b>	
			Org.-Nr. 7707→	02.98-05.05	BO,WZT	<b>0 460 484 142</b>	
		42	VJX <TUD5B>	07.00-05.05		<b>0 460 484 148</b>	

205							
1.9 D	1,9	47	DJZ,162 <XUD9>	08.92-09.98	AGF,BO	<b>0 460 494 279</b>	

205 Pickup							
1.8 D	1,8	44	<XUD7>	08.92-09.98	BO	<b>0 460 484 056</b>	

306							
1.9 D	1,9	50	<XUD9>	10.97→		<b>0 460 484 091</b>	
				01.98→	KL	<b>0 460 484 098</b>	
D [N5]	1,9	50	DJY <XUD9>	05.97-10.03	BO,WZT	<b>0 460 484 137</b>	
					BOW	<b>0 460 484 070</b>	
		51	D9B <XUD9>	05.97-10.03	WEK	<b>0 460 484 098</b>	
			WJZ <DW8>	09.98-10.03	BO	<b>0 460 494 467</b>	
D Turbo [N5]	1,9	55	DHV <XUD9BSD>	06.98-10.03	BO,WZT	<b>0 460 484 131</b>	

306 Break							
1.9 D [N5]	1,9	50	DJY <XUD9>	05.97-03.02	BO,WZT	<b>0 460 484 137</b>	
					BOW	<b>0 460 484 070</b>	
		51	D9B <XUD9>	05.97-03.02	WEK	<b>0 460 484 098</b>	
			WJZ <DW8>	09.98-03.02	BO	<b>0 460 494 467</b>	
D Turbo [N5]	1,9	55	DHV <XUD9BSD>	06.98-03.02	BO,WZT	<b>0 460 484 131</b>	



406							
1.9 D Turbo [D8]	1,9	66-68	DHX <XUD9TE>	12.95-03.99	WEG	0 460 494 367	
			Org.-Nr. 7145→	07.96-03.99	WEG	0 460 494 427	
			Org.-Nr. 7665→	12.97-03.99	WZT	0 460 494 455	0 986 440 161
			D8B <XUD9TE>	12.95-03.99	KOC,OWO	0 460 494 409	
					NO9,WEK	0 460 494 412	
					OWK	0 460 494 411	
					WOK	0 460 494 410	

406 Break							
1.9 D Turbo [D8]	1,9	66-68	DHX <XUD9TE>	10.96-03.99	WEG	0 460 494 367	
					WEG	0 460 494 427	
			Org.-Nr. 7665→	12.97-03.99	WZT	0 460 494 455	0 986 440 161
			D8B <XUD9TE>	10.96-03.99	KOC,OWO	0 460 494 409	
					NO9,WEK	0 460 494 412	
					OWK	0 460 494 411	
					WOK	0 460 494 410	

605							
2.5 D Turbo [Y30]	2,5	94-96	THY <DK5ATE>	07.94-05.99		0 460 404 993	0 986 440 512

806							
1.9 D Turbo [U60]	1,9	66	DHX <XUD9TE>	12.94-08.02	N05,WEG	0 460 494 367	
					N05,WEG	0 460 494 427	
			Org.-Nr. 7665→	12.97-08.02	EFV,WZT	0 460 494 455	0 986 440 161
		66-68	D8B <XUD9TE>	12.94-08.02	AGF,OWK	0 460 494 411	
					AGF,WOK	0 460 494 384	
					NO9,OWO	0 460 494 370	
				09.95-08.02	NO9,WEK	0 460 494 412	
			Org.-Nr. 6969→	01.96-08.02	N03,WEG	0 460 494 423	0 986 440 156

## RENAULT

Clio I							
1.9 D	1,9	47	F8Q 732	06.97→	KOC	0 460 484 049	
D [X57]	1,9	47	F8Q 678	09.96-02.98	BO	0 460 484 120	
			F8Q 732	06.90-02.98	KOC	0 460 484 049	
		47-48	F8Q 730	09.96-02.98	BO	0 460 484 122	
Clio II							
1.9 DTI [BB/CB/SB]	1,9	59	F9Q 780	03.99-10.07		0 460 414 988	0 986 440 520
			F9Q 782	08.00-10.07		0 460 414 983	
Espace III							
1.9 dTi [JEO]	1,9	72	F9Q 720	02.99-10.02		0 460 414 993	0 986 440 523
			F9Q 722	10.99-10.02		0 460 414 988	0 986 440 520
2.2 D Turbo [JEO]	2,2	83	G8T 714	11.97-10.02		0 460 494 454	
			G8T 716	11.97-10.02		0 460 494 451	
Express							
1.9 D	1,9	40	F8Q-682	09.96-09.02	BO	0 460 484 120	
Kangoo I							
1.9 DTI [FC./KC.]	1,9	59	F9Q 780	09.98-12.07		0 460 414 988	0 986 440 520
DTI, DTI 4x4 [FC./KC.]	1,9	59	F9Q 782	02.00-12.07		0 460 414 983	
Laguna I							
1.9 DTI [B56]	1,9	72	F9Q 710	09.99-02.01		0 460 414 988	0 986 440 520
			F9Q 716	10.97-09.99		0 460 414 993	0 986 440 523
			F9Q 717	04.99-02.01		0 460 414 988	0 986 440 520
2.2 D [B56]	2,2	61-63	G8T 752	11.95-02.01	KL,WEG	0 460 494 357	
					KL,WEG	0 460 494 396	
					KL,KOC,	0 460 494 358	
					WEG		
					KL,WEG	0 460 494 397	
			G8T 792	11.97-02.01		0 460 494 452	





◀ RENAULT

2.2 D [B56]	2,2	61-63	G8T 794	10.95-02.01	KL,WEG	0 460 494 357	
					KL,WEG	0 460 494 396	
					KL,KOC, WEG	0 460 494 358	
					KL,WEG	0 460 494 397	
D Turbo [B56]	2,2	83-85	G8T 760	11.97-02.01		0 460 494 449	
<b>Laguna I Grandtour</b>							
1.9 DTI [K56]	1,9	72	F9Q 710	09.99-02.01		0 460 414 988	0 986 440 520
			F9Q 716	10.97-09.99		0 460 414 993	0 986 440 523
			F9Q 717	04.99-02.01		0 460 414 988	0 986 440 520
DTI [S56]	1,9	72	F9Q 716	03.98-02.01		0 460 414 993	0 986 440 523
2.2 D [K56]	2,2	61-63	G8T 752	11.95-02.01	KL,WEG	0 460 494 357	
					KL,WEG	0 460 494 396	
					KL,KOC, WEG	0 460 494 358	
					KL,WEG	0 460 494 397	
			G8T 792	11.97-02.01		0 460 494 452	
			G8T 794	11.95-02.01	KL,WEG	0 460 494 357	
					KL,WEG	0 460 494 396	
					KL,KOC, WEG	0 460 494 358	
					KL,WEG	0 460 494 397	
D [S56]	2,2	61-63	G8T 752	11.95-02.01	KL,WEG	0 460 494 357	
					KL,WEG	0 460 494 396	
					KL,KOC, WEG	0 460 494 358	
					KL,WEG	0 460 494 397	
			G8T 792	11.97-02.01		0 460 494 452	
D Turbo [K56]	2,2	83-85	G8T 760	11.97-02.01		0 460 494 449	
D Turbo [S56]	2,2	83-85	G8T 760	11.97-02.01		0 460 494 449	
<b>Megane</b>							
1.9 D	1,9	68	F9QT	06.99-11.09		0 460 414 988	0 986 440 520
<b>Megane I</b>							
1.9 D [X64]	1,9	47-48	F8Q 620; F8Q 624	09.96-02.99	KL	0 460 484 114	
					KL	0 460 484 115	
DTI [X64]	1,9	59	F9Q 744	01.01-10.02		0 460 414 983	
		69	F9Q 730	06.97-02.99		0 460 414 993	0 986 440 523
		72	F9Q 731	03.99-10.02		0 460 414 988	0 986 440 520
			F9Q 734	06.97-02.99		0 460 414 993	0 986 440 523
			F9Q 736	03.99-10.02		0 460 414 988	0 986 440 520
<b>Megane I Classic</b>							
1.9 D [X64]	1,9	47-48	F8Q 624	09.96-09.03	KL	0 460 484 114	
			Mot.-Nr. C011708→	06.97-09.03	KL,WEG	0 460 484 133	
			Mot.-Nr. C024541→	11.97-09.03	WEG	0 460 484 136	
DTI [X64]	1,9	59	F9Q 744	11.00-09.03		0 460 414 983	
		72	F9Q 730	08.97-09.03		0 460 414 993	0 986 440 523
			F9Q 731	04.99-09.03		0 460 414 988	0 986 440 520
			F9Q 734	08.97-02.99		0 460 414 993	0 986 440 523
			F9Q 736	04.99-09.03		0 460 414 988	0 986 440 520
<b>Megane I Coupé</b>							
1.9 DTI [X64]	1,9	72	F9Q 731	03.99-10.02		0 460 414 988	0 986 440 520
			F9Q 734	06.97-02.99		0 460 414 993	0 986 440 523
			F9Q 736	03.99-10.02		0 460 414 988	0 986 440 520
<b>Megane I Grandtour</b>							
1.9 D [X64]	1,9	59	F9Q 744	01.01-09.03		0 460 414 983	
DTI [X64]	1,9	72	F9Q 731; F9Q 736	07.98-09.03		0 460 414 988	0 986 440 520
<b>R 21</b>							
1.9 D	1,9	47	F8Q 706	01.93-12.00	KOC	0 460 484 061	





Safrane						
2.2 12V D Turbo [B54]	2,2	83	G8T 740			
			Mot.-Nr. C003599→C020366	10.96-12.00	KL	0 460 494 440
			Mot.-Nr. C004121→C020366	10.96-12.00	<del>KL</del>	0 460 494 439
			Mot.-Nr. C020367→	10.96-12.00	GES,HEF	0 460 494 451
					GES,HEF	0 460 494 450
			Mot.-Nr. →C003598	10.96-12.00	KL,KOC	0 460 494 426
			Mot.-Nr. →C004120	10.96-12.00	<del>KL</del> ,KOC	0 460 494 425

Scenic I						
1.9 DTI [JA]	1,9	59	F9Q 744	11.00-04.03		0 460 414 983
		72	F9Q 731	03.99-04.03		0 460 414 988 0 986 440 520
			F9Q 736	03.99-04.03		0 460 414 988 0 986 440 520
		72-74	F9Q 734	06.97-02.99		0 460 414 993 0 986 440 523

19						
1.9 D [X53]	1,9	47	F8Q 706	09.88-12.01	BO,KL, KOC	0 460 484 043
					<del>KL</del> ,KOC	0 460 484 030
				05.92-12.01	BO, <del>KL</del>	0 460 484 059
					BO,KL, KOC	0 460 484 061
			F8Q 742	06.90-12.01	BO	0 460 484 041

## ROVER

Serie 200						
220 SD	2,0	63	20T2R	09.95-03.00	BO	0 460 414 118
SDI	2,0	77	20 T2N <L-Serie>			
			Fg.-Nr. YD 471565→	09.95-03.00	BO,EDC	0 470 004 005 0 986 444 503
			Fg.-Nr. →YD 471564	09.95-03.00	BO,EDC	0 460 414 992 0 986 440 522

Serie 400						
420 SD	2,0	63	20T2R	10.95-03.00	BO	0 460 414 118
SDI	2,0	77	20 T2N <L-Serie>			
			Fg.-Nr. YD 471064→	10.95-03.00	BO,EDC	0 470 004 005 0 986 444 503
			Fg.-Nr. →YD 471063	10.95-03.00	BO,EDC	0 460 414 992 0 986 440 522

Serie 400 Tourer						
418 TD	1,8	65	XUD7TE <PSA>	02.96-03.00	BO	0 460 484 019

Serie 600						
620 SDi	2,0	77	20 T2N <L-Serie>			
			Fg.-Nr. BM 246797→	03.95-12.98		0 460 414 992 0 986 440 522
			Fg.-Nr. →AM 246796	03.95-12.98		0 460 414 995

Serie 800						
825 TD	2,5	87	VM-425-SLIRR	10.91-12.98	KOC	0 460 404 068
		88/92	VM-425-CLIER; VM-425-SLIER	01.96-12.98		0 460 404 991

25						
2.0 iDT	2,0	74/83	20 T2N <L-Serie>			
			Fg.-Nr. YD 471565→	02.00-05.05	BO,EDC	0 470 004 005 0 986 444 503
			Fg.-Nr. →YD 471564	02.00-05.05	BO,EDC	0 460 414 992 0 986 440 522

45						
2.0 iDT	2,0	74/83	20 T2N <L-Serie>			
			Fg.-Nr. YD 471064→	02.00-05.05	BO,EDC	0 470 004 005 0 986 444 503
			Fg.-Nr. →YD 471063	02.00-05.05	BO,EDC	0 460 414 992 0 986 440 522

## SAAB (SAAB AUTOMOBILE AB)

9-3						
2.2 TiD [9440]	2,2	95	D223L	09.02-08.04	THS	0 470 504 211 0 986 444 037
			Fg.-Nr. →12020000	09.02-08.04		0 470 504 004 0 986 444 003
			Fg.-Nr. 12020001→	09.02-08.04	THS	0 470 504 206 0 986 444 045
16V D Turbo [9400]	2,2	85/92	D223L <X 22 DTH>; D223L <Y 22 DTH>			
			Fg.-Nr. →12020000	02.98-09.02		0 470 504 004 0 986 444 003
			Fg.-Nr. 12020001→	02.98-09.02	THS	0 470 504 206 0 986 444 045





◀ SAAB

9-3 Coupé							
2.2 16V D Turbo [9400]	2,2	92	D223L <Y 22 DTH>				
			Fg.-Nr. →12020000	11.00-09.02		0 470 504 004	0 986 444 003
			Fg.-Nr. 12020001→	11.00-09.02 THS		0 470 504 206	0 986 444 045
9-5							
2.2 TiD [9600]	2,2	88	D223L	03.02-08.02	AG,THS	0 470 504 212	0 986 444 046
					GS,THS	0 470 504 208	0 986 444 046
9-5 Kombi							
2.2 TiD [9600]	2,2	88	D223L	03.02-08.02	AG,THS	0 470 504 212	0 986 444 046
					GS,THS	0 470 504 208	0 986 444 046
				09.02-08.05	THS	0 470 504 226	0 986 444 030

**SEAT**

Alhambra							
1.9 TDI [7V8]	1,9	66	AHU	07.96-02.00		0 460 404 971	0 986 440 555
		81	AFN	05.97-02.00		0 460 404 968	0 986 440 567
			AVG	09.97-02.00		0 460 404 968	0 986 440 567
Arosa							
1.7 SDI [6H1]	1,7	44	AKU	08.97-10.03		0 460 404 967	0 986 440 553
Cordoba							
1.9 D [6K2]	1,9	47-50	1Y	09.93-12.02	KL	0 460 484 022	0 986 440 084
					KL,KOC	0 460 484 035	
		48	AGP	01.00→	KL	0 460 484 127	0 986 440 240
					KL,KOC	0 460 484 108	
SDI [6K2]	1,9	47	AEY				
			Fg.-Nr. 6K..V..247 165→	10.97-12.98		0 460 404 966	0 986 440 552
			Mot.-Nr. 134 671				
			Fg.-Nr. 6K..W..021 848→				
			Mot.-Nr. 134 672→	01.99-12.02		0 460 404 961	0 986 440 570
		50	AGP	05.99-08.02		0 460 404 972	0 986 440 556
			AQM	06.99-08.02		0 460 404 972	0 986 440 556
SDI [6L2]	1,9	47	ASY	09.02-12.05		0 460 404 972	0 986 440 556
TDI [6K2]	1,9	66	AGR	05.99-12.02		0 460 404 959	0 986 440 557
				01.00→		0 460 404 971	0 986 440 555
				10.00→		0 460 404 977	0 986 440 557
			AHU	07.96-06.99		0 460 404 971	0 986 440 555
			ALH	05.99-05.01		0 460 404 959	0 986 440 557
			IZ	07.96-06.99		0 460 404 971	0 986 440 555
		81	AFN	03.97-06.99		0 460 404 969	0 986 440 554
			ASV	05.99-12.02		0 460 404 959	0 986 440 557
Cordoba Vario							
1.9 SDI [6K5]	1,9	47	AEY				
			Fg.-Nr. 6K..V..247 165→	10.97-12.98		0 460 404 966	0 986 440 552
			Mot.-Nr. 134 671				
			Fg.-Nr. 6K..W..021 848→				
			Mot.-Nr. 134 672→	01.99-06.99		0 460 404 961	0 986 440 570
		50	AGP	05.99-08.02		0 460 404 972	0 986 440 556
			AQM	06.99-08.02		0 460 404 972	0 986 440 556
TDI [6K5]	1,9	66	AGR	05.99-08.02		0 460 404 959	0 986 440 557
			AHU	06.97-06.99		0 460 404 971	0 986 440 555
			ALH	05.99-05.01		0 460 404 959	0 986 440 557
		81	AFN	02.98-06.99		0 460 404 969	0 986 440 554
			ASV	05.99-08.02		0 460 404 959	0 986 440 557
Ibiza							
1.9 D [6K1]	1,9	47-50	1Y	03.93-10.99	KL	0 460 484 022	0 986 440 084
					KL,KOC	0 460 484 035	
SDI [6K1]	1,9	47	AEY				
			Fg.-Nr. 6K..V..247 165→	10.97-12.98		0 460 404 966	0 986 440 552
			Mot.-Nr. 134 671				
			Fg.-Nr. 6K..W..021 848→				
			Mot.-Nr. 134 672→	01.99-10.99		0 460 404 961	0 986 440 570





<b>1.9 SDI [6K1]</b>	1,9	50	AGP	05.99-05.02		<b>0 460 404 972</b>	<b>0 986 440 556</b>					
			AQM	05.99-05.02		<b>0 460 404 972</b>	<b>0 986 440 556</b>					
	SDI [6L1]	1,9	47	ASY	01.02-12.05		<b>0 460 404 972</b>	<b>0 986 440 556</b>				
	TDI [6K1]	1,9	66	AGR	05.99-05.02		<b>0 460 404 959</b>	<b>0 986 440 557</b>				
				AHU	12.96-06.99		<b>0 460 404 971</b>	<b>0 986 440 555</b>				
				ALH	05.99-05.02		<b>0 460 404 959</b>	<b>0 986 440 557</b>				
				81	AFN	03.97-06.99		<b>0 460 404 969</b>	<b>0 986 440 554</b>			
			ASV	05.99-05.02		<b>0 460 404 959</b>	<b>0 986 440 557</b>					
<b>Inca</b>												
<b>1.7 D [6K9]</b>	1,7	42	AHB	Mot.-Nr. →005 980	09.96-09.00	<b>0 460 404 967</b>	<b>0 986 440 553</b>					
<b>1.9 D</b>	1,9	47	AEY		05.99→	<del>KL</del>	<b>0 460 484 127</b>	<b>0 986 440 240</b>				
						KL	<b>0 460 484 128</b>	<b>0 986 440 241</b>				
				D [6K9]	1,9	47	1Y	11.95-06.03	KL	<b>0 460 484 128</b>	<b>0 986 440 241</b>	
				SDI [6K9]	1,9	47	AEY	Fg.-Nr. 9K..W..003 001→9K..X..015 600	10.97-12.98		<b>0 460 404 966</b>	<b>0 986 440 552</b>
								AYQ	09.00-06.03		<b>0 460 404 959</b>	<b>0 986 440 557</b>
<b>Leon</b>												
<b>1.9 SDI [1M1]</b>	1,9	50	AQM		12.99-10.03		<b>0 460 404 972</b>	<b>0 986 440 556</b>				
				TDI [1M1]	1,9	66/81	AGR; AHF; ALH	10.98-07.04		<b>0 460 404 959</b>	<b>0 986 440 557</b>	
							81	ASV	10.99-10.05		<b>0 460 404 959</b>	<b>0 986 440 557</b>
<b>Toledo</b>												
<b>1.9 D [1L2]</b>	1,9	47	1Y		05.91-03.99	KOC,MKO	<b>0 460 484 035</b>					
						MLK	<b>0 460 484 128</b>	<b>0 986 440 241</b>				
						Fg.-Nr. 1L..TR 020 001→	01.96-03.99	<del>KL</del>	<b>0 460 484 127</b>	<b>0 986 440 240</b>		
				SDI [1M2]	1,9	50	AQM	06.00-10.03		<b>0 460 404 972</b>	<b>0 986 440 556</b>	
				TDI [1L2]	1,9	66	AHU	06.96-03.99		<b>0 460 404 971</b>	<b>0 986 440 555</b>	
							81	AFN	11.96-03.99		<b>0 460 404 969</b>	<b>0 986 440 554</b>
TDI [1M2]	1,9	66/81	AGR; AHF; ALH	10.98-07.04		<b>0 460 404 959</b>	<b>0 986 440 557</b>					
			81	ASV	10.99-07.04		<b>0 460 404 959</b>	<b>0 986 440 557</b>				

**SKODA**

<b>Fabia</b>											
<b>1.9 SDI [6Y3]</b>	1,9	47	ASY		09.99-12.07		<b>0 460 404 972</b>	<b>0 986 440 556</b>			
<b>Fabia Combi</b>											
<b>1.9 SDI [6Y5]</b>	1,9	47	ASY		08.00-12.07		<b>0 460 404 972</b>	<b>0 986 440 556</b>			
<b>Fabia Schrägheck</b>											
<b>1.9 SDI [6Y2]</b>	1,9	47	ASY		09.99-03.08		<b>0 460 404 972</b>	<b>0 986 440 556</b>			
<b>Octavia</b>											
<b>1.9 SDI [1U2]</b>	1,9	50	AGP	05.97-07.00		<b>0 460 404 972</b>	<b>0 986 440 556</b>				
			AQM	08.00-12.03		<b>0 460 404 972</b>	<b>0 986 440 556</b>				
			TDI [1U2]	1,9	66	ALH	08.00-03.10	GS	<b>0 460 404 959</b>	<b>0 986 440 557</b>	
						66/81	AGR; AHF	09.96-12.09		<b>0 460 404 959</b>	<b>0 986 440 557</b>
						81	ASV	08.00-01.06		<b>0 460 404 959</b>	<b>0 986 440 557</b>
<b>Octavia Combi</b>											
<b>1.9 SDI [1U5]</b>	1,9	50	AGP	05.97-07.00		<b>0 460 404 972</b>	<b>0 986 440 556</b>				
			AQM	08.00-12.03		<b>0 460 404 972</b>	<b>0 986 440 556</b>				
			TDI [1U5]	1,9	66	ALH	08.00-03.10	GS	<b>0 460 404 959</b>	<b>0 986 440 557</b>	
						81	ASV	08.00-01.06		<b>0 460 404 959</b>	<b>0 986 440 557</b>
						66/81	AGR; AHF	08.97-12.09		<b>0 460 404 959</b>	<b>0 986 440 557</b>
TDI, TDI 4x4 [1U5]	1,9	66/81	AGR; AHF	08.97-12.09		<b>0 460 404 959</b>	<b>0 986 440 557</b>				
<b>Superb</b>											
<b>2.5 TDI [3U4]</b>	2,5	120	BDG		06.03-03.08	THI	<b>0 470 506 038</b>	<b>0 986 444 083</b>			

**TAGAZ**

<b>Tager</b>								
<b>2.9 D</b>	2,9	110	662 LA <Euro 3>		04.08→		<b>0 460 495 003</b>	





**TATA (TELCO)**









<b>Safari</b>						
2.0 D Turbo, D Turbo 4x4	2,0	66	483 DL		02.98-12.08	BKN <b>0 460 494 422</b> KSE <b>0 460 494 418</b>
<b>Sierra</b>						
1.9 D	1,9	44-50	483 DL		07.95-06.98	<b>9 460 034 413</b>
D Turbo	1,9	66	483 DL TCIC		06.97-05.02	BKN <b>0 460 494 422</b> KSE <b>0 460 494 418</b>
<b>Sumo</b>						
1.9 D	1,9	50	483 DL		07.95-07.00	<b>9 460 034 413</b>
					08.00→	EU3 <b>0 460 494 481</b>
					05.05→	EU3 <b>0 460 494 489</b>
D Turbo 4x4	1,9	66	483 DL TCIC		01.98→	BKN <b>0 460 494 422</b> KSE <b>0 460 494 418</b>
<b>Tatamobile</b>						
1.9 D	1,9	44-50	483 DL		07.95-07.00	<b>9 460 034 413</b>
<b>Telcoline</b>						
2.0 TDi	2,0	64			10.03→	BOK <b>0 460 494 418</b>

**UAZ**

<b>Hunter 3151</b>						
2.2 D 4x4	2,2	72	5143.1 <Euro 2>		01.06→	<b>0 460 414 217</b>

**VAUXHALL**

<b>Astra</b>						
1.7 D/DR [F]	1,7	42-44	17 D/DR <OHC>			
			Mot.-Nr. →14363651		12.91-02.98	<b>0 460 494 293</b>
			Mot.-Nr. 14363652→		12.91-02.98	<b>0 460 494 330 0 986 440 143</b>
DT [G]	1,7	50	X 17 DTL		03.98-08.00	<b>0 470 004 003 0 986 444 500</b>
DTL [F]	1,7	50	X 17 DTL		07.95-02.98	WEG <b>0 460 494 353 0 986 440 150</b>
						WEG <b>0 460 494 372 0 986 440 152</b>
TD [F]	1,7	60	17 DT/TC4 <EE1 OHC>		12.91-02.98	DKF,KL, <b>9 460 620 011</b>
						WEG,ZDA
						DKF,KL, <b>9 460 620 013</b>
						WEG
						DKF,KL, <b>9 460 620 020</b>
						WEG
			Mot.-Nr. →076350		12.91-02.98	DKF,KL, <b>9 460 620 017 9 460 620 017</b>
			Mot.-Nr. 076351→		12.91-02.98	DKF,KL, <b>9 460 620 021</b>
						WEG
<b>2.0 DTI [G]</b>						
2.0 DTI [G]	2,0	74	Y 20 DTH <Ecotec>			
			Mot.-Nr. 32000001→ 35000001→ 36000001→		09.00-08.05	THS <b>0 470 504 210 0 986 444 029</b>
			38000001→ 3B000001→ H0000001→			
DTL [G]	2,0	60	X 20 DTL <Turbo>		02.98-08.00	NC8 <b>0 470 504 003 0 986 444 002</b>
			Y 20 DTL <Turbo>		09.00-08.05	NC8 <b>0 470 504 003 0 986 444 002</b>
<b>2.2 DTI [G]</b>						
2.2 DTI [G]	2,2	92	Y 22 DTR <Turbo>		09.01-08.05	THS <b>0 470 504 209 0 986 444 028</b>
<b>Astra Estate</b>						
1.7 D/DR [F]	1,7	42-44	17 D/DR <OHC>			
			Mot.-Nr. →14363651		12.91-02.98	<b>0 460 494 293</b>
			Mot.-Nr. 14363652→		12.91-02.98	<b>0 460 494 330 0 986 440 143</b>
DT [G]	1,7	50	X 17 DTL		03.98-08.00	<b>0 470 004 003 0 986 444 500</b>
DTL [F]	1,7	50	X 17 DTL		07.95-02.98	WEG <b>0 460 494 353 0 986 440 150</b>
						WEG <b>0 460 494 372 0 986 440 152</b>

								
l/ccm	kW/(PS)	Typ						eXchange
<b>1.7 TD [F]</b>	1,7	60	17 DT <TC4EE1>	12.91-02.98	DKF, KL, WEG, ZDA			<b>9 460 620 011</b>
					DKF, KL, WEG			<b>9 460 620 013</b>
					DKF, KL, WEG			<b>9 460 620 020</b>
			Mot.-Nr. →076350	12.91-02.98	DKF, KL, WEG			<b>9 460 620 017 9 460 620 017</b>
			Mot.-Nr. 076351→	12.91-02.98	DKF, KL, WEG			<b>9 460 620 021</b>
<b>2.0 DTI [G]</b>	2,0	74	Y 20 DTH <Ecotec>	09.00-08.05	THS			<b>0 470 504 210 0 986 444 029</b>
			Mot.-Nr. 32000001→35000001→36000001→38000001→3B000001→H0000001→					
DTL [G]	2,0	60	X 20 DTL <Turbo>	03.98-08.00	NC8			<b>0 470 504 003 0 986 444 002</b>
			Y 20 DTL <Turbo>	09.00-08.05	NC8			<b>0 470 504 003 0 986 444 002</b>
<b>Astra Van</b>								
<b>1.7 D/DR [F]</b>	1,7	42-44	17 D/DR <OHC>	12.91-02.98				<b>0 460 494 293</b>
			Mot.-Nr. →14363651	12.91-02.98				<b>0 460 494 330 0 986 440 143</b>
			Mot.-Nr. 14363652→					
DT [G]	1,7	50	X 17 DTL	03.98-08.00				<b>0 470 004 003 0 986 444 500</b>
DTL [F]	1,7	50	X 17 DTL	07.95-02.98	WEG			<b>0 460 494 353 0 986 440 150</b>
					WEG			<b>0 460 494 372 0 986 440 152</b>
<b>2.0 DTI [G]</b>	2,0	74	Y 20 DTH <Ecotec>	09.00-08.05	THS			<b>0 470 504 210 0 986 444 029</b>
			Mot.-Nr. 32000001→35000001→36000001→38000001→3B000001→H0000001→					
DTL [G]	2,0	60	X 20 DTL <Turbo>	03.98-08.00	NC8			<b>0 470 504 003 0 986 444 002</b>
<b>Combo</b>								
<b>1.7 D</b>	1,7	44	X 17 D 4EE1; 17 D <4EE1>	09.94-10.01	DKF, WEG			<b>9 460 620 010 9 460 620 010</b>
			Mot.-Nr. →076351	09.94-10.01	DKF, WEG			<b>9 460 620 019</b>
			Mot.-Nr. 076352→092141	09.94-10.01	DKF, WEG			<b>9 460 620 023</b>
			Mot.-Nr. 092142→	09.94-10.01	DKF, WEG			<b>9 460 620 016</b>
			Mot.-Nr. 877698→076351	09.94-10.01	DKF, WEG			<b>9 460 620 016</b>
<b>Corsa</b>								
<b>1.5 D [B]</b>	1,5	37	X 15 D <4EC1 OHC>	04.96-08.00	DKF, WEG			<b>9 460 620 008 9 460 620 008</b>
			Mot.-Nr. →877695	04.96-08.00	DKF, WEG			<b>9 460 620 014</b>
			Mot.-Nr. 877696→					
			15 D <4EC1>	09.94-08.00	DKF, WEG			<b>9 460 620 008 9 460 620 008</b>
			Mot.-Nr. →877695	09.94-08.00	DKF, WEG			<b>9 460 620 014</b>
			Mot.-Nr. 877696→					
TD [B]	1,5	49	15 TD <T4EC1 Turbo>	09.94-08.00	DKF, WEG			<b>9 460 620 009 9 460 620 009</b>
			Mot.-Nr. 00877708→	09.94-08.00	DKF, WEG			<b>9 460 620 015 9 460 620 015</b>
XTD [B]	1,5	49	X 15 TD <4EE1 Turbo>	04.96-08.00	DKF, WEG			<b>9 460 620 009 9 460 620 009</b>
			Mot.-Nr. 00877708→	04.96-08.00	DKF, WEG			<b>9 460 620 015 9 460 620 015</b>
<b>1.7 D [B]</b>	1,7	44	X 17 D 4EE1; 17 D <4EE1>	09.94-08.00	DKF, WEG			<b>9 460 620 010 9 460 620 010</b>
			Mot.-Nr. →076351	09.94-08.00	DKF, WEG			<b>9 460 620 019</b>
			Mot.-Nr. 076352→092141	09.94-08.00	DKF, WEG			<b>9 460 620 023</b>
			Mot.-Nr. 092142→	09.94-08.00	DKF, WEG			<b>9 460 620 016</b>
			Mot.-Nr. 877698→076351	09.94-08.00	DKF, WEG			<b>9 460 620 016</b>
<b>Frontera</b>								
<b>2.2 DTI [B]</b>	2,2	85/88	X 22 DTH <Turbo>; Y 22 DTH <Turbo>	09.98-09.04				<b>0 470 504 009 0 986 444 005</b>
<b>2.5 TDS Turbo [A]</b>	2,5	85	VM41B <Venturi-25TD>	06.96-08.98				<b>0 460 404 991</b>
<b>2.8 TDI Turbo [A]</b>	2,8	83	4JB1T	02.95-08.98	DKF, WEG			<b>9 460 611 452</b>
			Fg.-Nr. →SV799999	02.95-08.98	DKF, WEG			<b>9 460 610 708</b>
<b>Monterey</b>								
<b>3.1 TD [A]</b>	3,1	84	4JG2 TC	08.96-08.98	WEG, ZDA			<b>9 460 611 262</b>
					KL, WEG			<b>9 460 611 263</b>
					OWK, WEG			<b>9 460 611 100</b>
					OWO, ZDA			<b>9 460 611 099</b>
<b>Omega</b>								
<b>2.0 DTI [B]</b>	2,0	74	X 20 DTH Turbo	09.97-08.00	NC8			<b>0 470 504 009 0 986 444 005</b>
					NT5			<b>0 470 504 011 0 986 444 012</b>
<b>2.2 DTI [B]</b>	2,2	88	Y 22 DTH <Turbo>	06.00-09.03	NC9			<b>0 470 504 016 0 986 444 021</b>
<b>2.5 TD, TDI [B]</b>	2,5	96	U 25 TD <R6 Turbo>; X 25 TD <Turbo>	04.94-09.04				<b>0 460 406 994 0 986 440 516</b>





◀ VAUXHALL

Signum									
2.0 DTI	2,0	74	Y 20 DTH <Ecotec>		05.03-09.05	THS	0 470 504 217	0 986 444 030	
2.2 DTI	2,2	86-92	Y 22 DTR <Ecotec>		05.03-09.08	THS	0 470 504 217	0 986 444 030	
Sintra									
2.2 TD	2,2	85	X 22 DTH <Turbo>		09.97-07.99		0 470 504 009	0 986 444 005	
Vectra									
1.7 TD [B]	1,7	60	X 17 TD <TC4 EE1 Turbo>		09.95-08.01	DKF,KL,	9 460 620 011		
						WEG,ZDA			
						DKF,KL,	9 460 620 013		
						WEG			
						DKF,KL,	9 460 620 020		
						WEG			
			Mot.-Nr. →076356		09.95-08.01	DKF,KL,	9 460 620 017	9 460 620 017	
			Mot.-Nr. 076357→		09.95-08.01	DKF,KL,	9 460 620 021		
						WEG			
2.0 DI [B]	2,0	60	X 20 DTL <Ecotec 16V Turbo>		09.96-08.00	NT5	0 470 504 011	0 986 444 012	
						TW	0 470 504 002	0 986 444 001	
							0 470 504 003	0 986 444 002	
DTI [B]	2,0	74	X 20 DTH <16V Turbo>		09.97-02.98	NC8	0 470 504 004	0 986 444 003	
						09.97-08.00	NT5	0 470 504 011	0 986 444 012
			Y 20 DTH <Ecotec>		09.00-08.01		0 470 504 015	0 986 444 014	
DTI [C]	2,0	74	Y 20 DTH <Ecotec>		04.02-09.05	THS	0 470 504 210	0 986 444 029	
2.2 DTI [B]	2,2	92	Y 22 DTR <Turbo>		09.00-08.01		0 470 504 016	0 986 444 021	
DTI [C]	2,2	86-92	Y 22 DTR <Turbo Ecotec>		04.02-09.05	THS	0 470 504 209	0 986 444 028	
Vectra Estate									
1.7 TD [B]	1,7	60	X 17 TD <TC4 EE1 Turbo>		09.95-08.01	DKF,KL,	9 460 620 011		
						WEG,ZDA			
						DKF,KL,	9 460 620 013		
						WEG			
						DKF,KL,	9 460 620 020		
						WEG			
			Mot.-Nr. →076356		09.95-08.01	DKF,KL,	9 460 620 017	9 460 620 017	
			Mot.-Nr. 076357→		09.95-08.01	DKF,KL,	9 460 620 021		
						WEG			
2.0 DI [B]	2,0	60	X 20 DTL <Ecotec 16V Turbo>		09.96-08.00	NT5	0 470 504 011	0 986 444 012	
						TW	0 470 504 002	0 986 444 001	
							0 470 504 003	0 986 444 002	
DTI [B]	2,0	74	X 20 DTH <16V Turbo>		09.97-02.98	NC8	0 470 504 004	0 986 444 003	
						09.97-08.00	NT5	0 470 504 011	0 986 444 012
			Y 20 DTH <Ecotec>		09.00-08.01		0 470 504 015	0 986 444 014	
DTI [C]	2,0	74	Y 20 DTH <Ecotec>		09.03-09.05	THS	0 470 504 210	0 986 444 029	
2.2 DTI [B]	2,2	92	Y 22 DTR <Turbo>		09.00-08.01		0 470 504 016	0 986 444 021	
DTI [C]	2,2	86-92	Y 22 DTR <Ecotec>		09.03-09.05	THS	0 470 504 209	0 986 444 028	
Zafira									
2.0 DI [A]	2,0	60	X 20 DTL <Turbo Ecotec>		03.99-08.00	NC8	0 470 504 003	0 986 444 002	
DTI [A]	2,0	74	Y 20 DTH <Ecotec>		04.99-06.05		0 470 504 015	0 986 444 014	
						THS	0 470 504 218	0 986 444 036	
						04.99-06.05	AG,THS	0 470 504 217	0 986 444 030
			36000001→ 38000001→ 3H000001→		04.99-06.05	GS,THS	0 470 504 218	0 986 444 036	
2.2 DTI [A]	2,2	92	Y 22 DTR <Turbo Ecotec>		03.02-06.05	THS	0 470 504 209	0 986 444 028	
						03.02-06.05	THS	0 470 504 219	0 986 444 037





## VOLVO

<b>S40 I</b>						
1.9 D	1,9	70	D4192T2		03.98-07.00	0 460 414 984
<b>S70</b>						
2.5 TDI	2,5	103	D5252T		01.97-07.00	0 460 415 990 0 986 440 564
<b>S80 I</b>						
2.5 TDI	2,5	103	D5252T		08.98-07.01	0 460 415 990 0 986 440 564
<b>V40 I</b>						
1.9 D	1,9	70	D4192T2		08.98-07.00	0 460 414 984
<b>V70 I</b>						
2.5 TDI	2,5	103	D5252T		01.97-03.00	0 460 415 990 0 986 440 564
<b>V70 II</b>						
2.5 D	2,5	103	D5252T		03.00-07.01	0 460 415 990 0 986 440 564

## VW (VOLKSWAGEN)

<b>Bora</b>						
1.9 SDI [1J2]	1,9	50	AGP		09.98-04.01	0 460 404 972 0 986 440 556
			AQM		09.98-05.05	0 460 404 972 0 986 440 556
TDI [1J2]	1,9	66	ALH		09.98-05.05 GS	0 460 404 959 0 986 440 557
		81	ASV		05.00-05.05	0 460 404 959 0 986 440 557
TDI, TDI 4Motion [1J2]	1,9	66/81	AGR; AHF		09.98-05.05	0 460 404 959 0 986 440 557
<b>Bora Variant</b>						
1.9 TDI [1J6]	1,9	66/81	AGR; AHF; ASV		09.98-05.05	0 460 404 959 0 986 440 557
<b>Caddy</b>						
1.7 SDI [9K9]	1,7	42	AHB			
			Mot.-Nr. →005 980		07.96-04.98	0 460 404 967 0 986 440 553
			Mot.-Nr. 005 981→		05.98-09.00	0 460 404 962
1.9 D [9K9]	1,9	47	1Y		11.95-06.03	MLK 0 460 484 128 0 986 440 241
						OLK 0 460 484 127 0 986 440 240
SDI [9K9]	1,9	47-66	AEY			
			Fg.-Nr. 9K..W..516 001→9K..W..529 222		10.97-01.98	0 460 404 966 0 986 440 552
			Fg.-Nr. 9K..W..529 223→		02.98-09.00	0 460 404 961 0 986 440 570
SDI, TDI [9K9]	1,9	47/66	ALH; AYQ		09.00-06.03	0 460 404 959 0 986 440 557
TDI [9K9]	1,9	66	AHU		09.96-09.00	0 460 404 971 0 986 440 555
			ALE		10.97-09.00	0 460 404 970 0 986 440 568
<b>Golf III</b>						
1.9 TD [1H1/1W1]	1,9	55	AAZ			
			Fg.-Nr. 1H-S-048 651→		10.94-08.98	KL 0 460 494 362
<b>Golf III Cabriolet</b>						
1.9 TDI [1E7]	1,9	66	AHU		08.96-04.98	0 460 404 971 0 986 440 555
			ALE		04.97-04.98	0 460 404 970 0 986 440 568
		81	AFN		07.96-05.98	0 460 404 969 0 986 440 554
<b>Golf III Variant</b>						
1.9 D [1H5]	1,9	47	1Y			
			Fg.-Nr. 1H..SW180 001→		11.94-02.99	0 460 484 127 0 986 440 240
SDI [1H5]	1,9	47	AEY		01.95-02.99	0 460 404 964 0 986 440 551
TD [1H5]	1,9	55	AAZ		CH 07.93-02.99	KL 0 460 494 314 0 986 440 142
						KL 0 460 494 414
			Fg.-Nr. 1H..SW180 001→	A,FIN, N,S	11.94-02.99	KL 0 460 494 362
				A,CH, FIN,N,S	11.94-02.99	KL 0 460 494 444 0 986 440 250
						KL 0 460 494 445 0 986 440 251
TDI [1H5]	1,9	66	AHU		08.96-02.99	0 460 404 971 0 986 440 555
			ALE		05.97-02.99	0 460 404 970 0 986 440 568
		81	AFN		02.96-02.99	0 460 404 969 0 986 440 554
<b>Golf IV</b>						
1.9 SDI [1J1]	1,9	50	AGP		08.97-04.01	0 460 404 972 0 986 440 556
			AQM		11.98-05.04	0 460 404 972 0 986 440 556
TDI [1J1]	1,9	66	ALH		10.97-05.04	GS 0 460 404 959 0 986 440 557



◀ VW

1.9 TDI [1J1]	1,9	81	ASV		05.00-05.04		0 460 404 959	0 986 440 557
TDI, TDI 4Motion [1J1]	1,9	66/81	AGR; AHF		10.97-12.05		0 460 404 959	0 986 440 557
<b>Golf IV Cabriolet</b>								
1.9 TDI [1E7]	1,9	66	AHU		04.98-06.00		0 460 404 971	0 986 440 555
			ALE		04.98-12.01		0 460 404 970	0 986 440 568
		81	AFN		04.98-08.99		0 460 404 969	0 986 440 554
			AVG		08.99-10.00		0 460 404 969	0 986 440 554
<b>Golf IV Station Wagon</b>								
1.9 TDI [1J5]	1,9	81	AHF		04.02-12.05		0 460 404 959	0 986 440 557
<b>Golf IV Variant</b>								
1.9 SDI [1J5]	1,9	50	AGP		05.00-04.01		0 460 404 972	0 986 440 556
			AQM		05.99-06.06		0 460 404 972	0 986 440 556
TDI [1J5]	1,9	66	ALH		05.99-06.06	GS	0 460 404 959	0 986 440 557
		81	ASV		05.00-06.06		0 460 404 959	0 986 440 557
TDI, TDI 4Motion [1J5]	1,9	66/81	AGR; AHF		05.99-06.06		0 460 404 959	0 986 440 557
<b>Jetta</b>								
1.9 TD [1H2/1W2]	1,9	55	AAZ					
			Fg.-Nr. 1H-S-048 651→		10.94-07.98	KL	0 460 494 362	
TDI [1H2/1W2]	1,9	66	1Z		08.95→		0 460 404 970	0 986 440 568
<b>Jetta IV</b>								
1.9 TDI [1J2]	1,9	81	AHF		09.99-12.05	GS	0 460 404 959	0 986 440 557
<b>Lupo</b>								
1.7 SDI [6X1]	1,7	44	AKU		10.98-07.05		0 460 404 967	0 986 440 553
<b>New Beetle</b>								
1.9 TDI [1C1/9C1]	1,9	66	ALH		01.98-06.04	GS	0 460 404 959	0 986 440 557
<b>Passat</b>								
1.9 TDI [3B2]	1,9	66	AHU		05.99-11.00		0 460 404 971	0 986 440 555
TDI, TDI Syncro [3B2]	1,9	81	AFN		10.96-11.00		0 460 404 969	0 986 440 554
			AVG		08.99-11.00		0 460 404 969	0 986 440 554
2.5 TDI, TDI Syncro [3B2]	2,5	110	AKN		08.98-11.00	GS	0 470 506 049	0 986 444 068
TDI, TDI 4Motion [3B3]	2,5	110	AKN		10.00-05.03	GS	0 470 506 049	0 986 444 068
		120/132	BDG; BDH		01.03-05.05	THI	0 470 506 038	0 986 444 083
TDI 4Motion [3B3]	2,5	132	BAU		01.03-05.05	THI	0 470 506 033	0 986 444 073
<b>Passat Variant</b>								
1.9 TDI [3B5]	1,9	66	AHU		05.97-11.00		0 460 404 971	0 986 440 555
TDI, TDI Syncro [3B5]	1,9	81	AFN		05.97-11.00		0 460 404 969	0 986 440 554
			AVG		08.99-11.00		0 460 404 969	0 986 440 554
2.5 TDI, TDI Syncro [3B5]	2,5	110	AKN		05.99-11.00	GS	0 470 506 049	0 986 444 068
TDI, TDI 4Motion [3B6]	2,5	110	AKN		10.00-05.03	GS	0 470 506 049	0 986 444 068
		120/132	BDG; BDH		01.03-05.05	THI	0 470 506 038	0 986 444 083
TDI 4Motion [3B6]	2,5	132	BAU		01.03-05.05	THI	0 470 506 033	0 986 444 073
<b>Polo</b>								
1.7 SDI [6N1]	1,7	42/44	AHG; AKU		04.97-12.99		0 460 404 967	0 986 440 553
SDI [6N2]	1,7	42/44	AHG; AKU		10.99-09.01		0 460 404 967	0 986 440 553
1.9 D [6N1]	1,9	47	AEF		10.94-12.99	WEG	0 460 484 071	0 986 440 240
			Fg.-Nr. 6N-T-000 001→		07.95-12.99	KOC, WEG	0 460 484 077	
			AGD					
			Fg.-Nr. →6N-V 160 000		07.96-12.99		0 460 404 964	0 986 440 551
			Fg.-Nr. 6N-V-160 001→		07.96-12.99		0 460 404 966	0 986 440 552
SDI [6N2]	1,9	47	AGD		10.99-09.01		0 460 404 966	0 986 440 552
			ASX		10.99-09.01		0 460 404 967	0 986 440 553
SDI [9N1]	1,9	47	ASY		09.01-05.05		0 460 404 972	0 986 440 556
SDI [9N2]	1,9	47	ASY		11.03-05.07		0 460 404 972	0 986 440 556
SDI [9N3]	1,9	47	ASY		04.05-12.09		0 460 404 972	0 986 440 556
<b>Polo Classic</b>								
1.7 SDI [6V2]	1,7	44	AKW					
			Mot.-Nr. AKW 001 850→		05.98-08.99		0 460 404 962	
			Mot.-Nr. →AKW 001 849		11.97-04.98		0 460 404 967	0 986 440 553
1.9 SD	1,9	47	1Y <M9N>		05.96-08.08	KL, TW	0 460 484 127	0 986 440 240
							0 460 484 161	
						KL	0 460 484 128	0 986 440 241
					09.00-08.08		0 460 484 160	0 986 440 240





<b>1.9 SDI [6V2]</b>	1,9	47	AEY						
				Fg.-Nr. 6K..V..247 165→Mot.-Nr. AEY 134 671	05.97-12.98	<b>0 460 404 966</b>	<b>0 986 440 552</b>		
				Fg.-Nr. 6K..W..021 848→					
				Mot.-Nr. AEY 134 672→	01.99-08.99	<b>0 460 404 961</b>	<b>0 986 440 570</b>		
		50	AGP		08.99-09.01	<b>0 460 404 972</b>	<b>0 986 440 556</b>		
			AQM		08.99-09.01	<b>0 460 404 972</b>	<b>0 986 440 556</b>		
<b>TDI</b>	1,9	66	AGR		09.00-08.08	<b>0 460 404 959</b>	<b>0 986 440 557</b>		
			AHU <M2K>		03.99-08.00	<b>0 460 404 971</b>	<b>0 986 440 555</b>		
<b>TDI [6V2]</b>	1,9	66	AGR		10.99-09.01	<b>0 460 404 959</b>	<b>0 986 440 557</b>		
			AHU		07.96-08.99	<b>0 460 404 971</b>	<b>0 986 440 555</b>		
			ALE		11.97-08.99	<b>0 460 404 970</b>	<b>0 986 440 568</b>		
			ALH		10.99-09.01	<b>0 460 404 959</b>	<b>0 986 440 557</b>		
				81	AFN		06.98-08.99	<b>0 460 404 969</b>	<b>0 986 440 554</b>
					ASV		10.99-09.01	<b>0 460 404 959</b>	<b>0 986 440 557</b>
<b>Polo Variant</b>									
<b>1.7 SDI [6V5]</b>	1,7	44	AKW						
				Mot.-Nr. AKW 001 850→	05.98-08.99	<b>0 460 404 962</b>			
				Mot.-Nr. →AKW 001 849	08.97-04.98	<b>0 460 404 967</b>	<b>0 986 440 553</b>		
<b>1.9 SDI [6V5]</b>	1,9	47	AEY						
				Mot.-Nr. AEY 134 672→	01.99-08.99	<b>0 460 404 961</b>	<b>0 986 440 570</b>		
				Mot.-Nr. →AEY 134 671	06.97-12.98	<b>0 460 404 966</b>	<b>0 986 440 552</b>		
				AGP	10.99-09.01	<b>0 460 404 972</b>	<b>0 986 440 556</b>		
				AQM	10.99-09.01	<b>0 460 404 972</b>	<b>0 986 440 556</b>		
				50					
<b>TDI [6V5]</b>	1,9	66	AGR		10.99-09.01	<b>0 460 404 959</b>	<b>0 986 440 557</b>		
			AHU		06.97-08.99	<b>0 460 404 971</b>	<b>0 986 440 555</b>		
			ALE		11.97-08.99	<b>0 460 404 970</b>	<b>0 986 440 568</b>		
			ALH		10.99-09.01	<b>0 460 404 959</b>	<b>0 986 440 557</b>		
				81	AFN		06.98-08.99	<b>0 460 404 969</b>	<b>0 986 440 554</b>
					ASV		10.99-09.01	<b>0 460 404 959</b>	<b>0 986 440 557</b>
<b>Sharan</b>									
<b>1.9 TDI [7M8]</b>	1,9	66	AHU		07.96-04.98	<b>0 460 404 971</b>	<b>0 986 440 555</b>		
				81	AFN		09.96-02.00	<b>0 460 404 979</b>	<b>0 986 440 567</b>
					AVG		08.99-02.00	<b>0 460 404 968</b>	<b>0 986 440 557</b>







**AVIA**

A						
21 T	3,6	76	D421.76 II	01.99-07.00		<b>0 460 424 171</b>
			D421.76.01 <Euro 2>	10.96-12.98		<b>0 460 424 151</b>
31 T	3,6	76	D421.76 II	01.99-07.00		<b>0 460 424 171</b>
			D421.76.01 <Euro 2>	10.96-12.98		<b>0 460 424 151</b>
60	3,6	76	D421.76 II	01.99-07.00		<b>0 460 424 171</b>
			D421.76.00 <Euro 2>	10.96-12.98		<b>0 460 424 151</b>
		85	D421.85.00 <Euro 2>	01.97-07.00		<b>0 460 424 162</b>
75	3,6	76	D421.76 II	01.99-07.00		<b>0 460 424 171</b>
			D421.76.00 <Euro 2>	10.96-12.98		<b>0 460 424 151</b>
		85	D421.85.00 <Euro 2>	01.97-07.00		<b>0 460 424 162</b>

**CHEVROLET**

Luv						
3.0 D-MAX	3,0	96	4JH1-TC	09.04→		<b>0 470 504 037</b>
Silverado						
4.1 D	4,1	66	S4	11.96-12.01	KOC	<b>0 460 424 175</b>

**CITROEN**

Jumper						
1.9 D [23]	1,9	51	DJY <XUD9>	01.99-02.02	WEG	<b>0 460 484 070</b>
					WZT	<b>0 460 484 146</b>
			D9B <XUD9AU>	02.94-08.98	WZT	<b>0 460 484 091</b>
				11.94-02.02	WEG	<b>0 460 484 064 0 986 440 094</b>
				09.98-02.02	WZT	<b>0 460 484 111</b>
D Turbo [23]	1,9	66-68	DHX <XUD9UTF>	02.94-02.02	EFV,WEG	<b>0 460 494 423 0 986 440 156</b>
					KOC,N11,	<b>0 460 494 383</b>
					WZT	
					N05,WZT	<b>0 460 494 430</b>
			D8C <XUD9UTF>	02.94-02.02	KOC,N03,	<b>0 460 494 428</b>
					WZT	
					KOC,WEG	<b>0 460 494 383</b>
					WZT	<b>0 460 494 388</b>
				12.94-02.02	N09,WEG	<b>0 460 494 370</b>
				01.96-02.02	N05,WEG	<b>0 460 494 423 0 986 440 156</b>
2.5 D [23]	2,5	63	T9A <DJ5>	06.98-02.02	WEG	<b>0 460 494 459</b>
					WZT	<b>0 460 494 460</b>
			Fg.-Nr. 15382157→	03.97-05.98		<b>0 460 494 429</b>
TDi [23]	2,5	79	THX <DJ5TED>	10.96-02.02	WEG	<b>0 460 414 140 0 986 440 051</b>
					WEG	<b>0 460 414 156</b>
2.8 D [23]	2,8	64	8140 63 <SOFIM 2800>	01.99-02.02	KOC	<b>0 460 494 483</b>
T	2,8	77	8140 43 <SOFIM 2800 TD>	12.01-08.05		<b>0 460 494 484</b>

**FIAT**

Ducato						
2.5 D	2,5	62	8140.67.2200	11.97-12.99		<b>0 460 404 084</b>
2.8 D	2,8	63	8140.63.22.60 <PC/NA>	04.99-05.05	TW	<b>0 460 494 466 0 986 440 163</b>
						<b>0 460 494 477</b>
D Turbo	2,8	90	8140.43.22.00 <ID/TCA>	04.99-08.00		<b>0 460 424 152</b>
				09.00-12.01		<b>0 460 424 227</b>
				01.02-05.05		<b>0 460 424 252</b>
D Turbo Interc.	2,8	103,3	8140.43.22.00 <ID/TCA>	09.00-12.01		<b>0 460 424 227</b>
				01.02-05.05		<b>0 460 424 252</b>



Ducato Cargo						
2.5 D	2,5	62	8140.67.2200		11.97-05.05	0 460 404 084
2.8 D	2,8	63	8140.63.22.60 <PC/NA>		04.99-05.05 TW	0 460 494 466 0 986 440 163 0 460 494 477
D Turbo	2,8	90	8140.43.22.00 <ID/TCA>		04.99-08.00	0 460 424 152
					09.00-12.01	0 460 424 227
					01.02-05.05	0 460 424 252
					01.04-05.05 FWT	0 460 424 248
Ducato Combinato						
2.8 D, iDTD	2,8	66/76	8140.63		06.98→ KOC	0 460 494 483
Ducato Furgon						
2.8 D	2,8	66	8140.63		06.98-11.04 KOC	0 460 494 483
Ducato 10						
1.9 D [230]	1,9	50	DJY <M11>		04.98-10.01 BOW	0 460 484 146
					BOW	0 460 484 070
		51	230 A2.000 <M1>		03.94-03.98 BOW	0 460 494 401
					BOW,KOC	0 460 494 349
TD [230]	1,9	60	230 A3.000 <M2>		03.94-03.98 BOW	0 460 494 400
					BOW	0 460 494 348
		66	DHX <M12>		04.98-10.01 BOW	0 460 494 430
					BOW	0 460 494 423 0 986 440 156
TD CAT [230]	1,9	59	230 A4.000 <M3>		03.94-03.98 BOW	0 460 494 402
					BOW,KOC	0 460 494 349
2.5 D [230]	2,5	62	8140.67 <M4>		11.95-03.98 BOW	0 460 404 084
TD ECO [230]	2,5	80	8140.47R <M7>		03.94-03.98	0 460 414 996 0 986 440 524
TD EGR, TD EGR 4x4 [230]	2,5	85	8140.47 <M6>		11.97-03.98 BOW,KOC	0 460 414 164
			Fg.-Nr. →5202307		03.94-03.98 BOW,KOC	0 460 414 104
TD 4x4 [230]	2,5	85	8140.47 <M5>		03.94-04.98 BOW	0 460 414 128
			Mot.-Nr. →1997700		03.94-04.98 BOW	0 460 414 091
			Mot.-Nr. 1997701→FG-Nr.5202307		03.94-04.98 BOW,KOC	0 460 414 120
2.8 D [230]	2,8	64	8140.63 <M10>		04.98-03.02	0 460 494 466 0 986 440 163
TD EGR, TD EGR 4x4 [230]	2,8	90	8140.43 <M9>			
			Mot.-Nr. →3050379		10.97-03.00	0 460 424 164
TD, TD 4x4 [230]	2,8	90	8140.43 <M8>			
			Mot.-Nr. →3050379		10.97-03.00	0 460 424 152
			Mot.-Nr. 30503780→		04.00-03.02	0 460 424 220
Ducato 11						
2.8 TD [244]	2,8	90	8140.43 <M25>		10.02-08.06	0 460 424 220
Ducato 14						
1.9 TD [230]	1,9	60	230 A3.000 <M2>		03.94-03.98 BOW	0 460 494 400
					BOW	0 460 494 348
		66	DHX <M12>		04.98-10.01 BOW	0 460 494 430
					BOW	0 460 494 423 0 986 440 156
TD CAT [230]	1,9	59	230 A4.000 <M3>		03.94-03.98 BOW	0 460 494 402
					BOW,KOC	0 460 494 349
2.5 D [230]	2,5	62	8140.67 <M4>		11.95-03.98 BOW	0 460 404 084
TD [230]	2,5	85	8140.47 <M5>		03.94-03.02 BOW	0 460 414 128
			Mot.-Nr. →1997700		03.94-03.02 BOW	0 460 414 091
			Mot.-Nr. 1997701→FG-Nr.5202307		03.94-03.02 BOW,KOC	0 460 414 120
TD ECO, TD ECO 4x4 [230]	2,5	80	8140.47R <M7>		03.94-03.98	0 460 414 996 0 986 440 524
TD EGR, TD EGR 4x4 [230]	2,5	85	8140.47 <M6>		11.97-03.98 BOW,KOC	0 460 414 164
			Fg.-Nr. →5202307		03.94-03.98 BOW,KOC	0 460 414 104
2.8 D [230]	2,8	64	8140.63 <M10>		04.98-03.02	0 460 494 466 0 986 440 163
TD EGR, TD EGR 4x4 [230]	2,8	90	8140.43 <M9>			
			Mot.-Nr. →3050379		10.97-03.00	0 460 424 164
TD, TD 4x4 [230]	2,8	90	8140.43 <M8>			
			Mot.-Nr. →3050379		10.97-03.00	0 460 424 152
			Mot.-Nr. 30503780→		04.00-03.02	0 460 424 220
Ducato 15						
2.8 TD, TD 4x4 [244]	2,8	90	8140.43 <M25>		10.02-08.06	0 460 424 220
Ducato 18						
2.5 D, D 4x4 [230]	2,5	62	8140.67 <M4>		11.95-03.98 BOW	0 460 404 084
TD ECO [230]	2,5	80	8140.47R <M7>		03.94-03.98	0 460 414 996 0 986 440 524





◀ FIAT

2.5 TD, TD 4x4 [230]	2,5	85	8140.47 <M5>	03.94-03.02	BOW	0 460 414 128	
			Mot.-Nr. →1997700	03.94-03.02	BOW	0 460 414 091	
			Mot.-Nr. 1997701→FG-Nr.5202307	03.94-03.02	BOW,KOC	0 460 414 120	
2.8 D, D 4x4 [230]	2,8	64	8140.63 <M10>	04.98-03.02		0 460 494 466	0 986 440 163
TD EGR, TD EGR 4x4 [230]	2,8	90	8140.43 <M9>				
			Mot.-Nr. →3050379	10.97-03.00		0 460 424 164	
TD, TD 4x4 [230]	2,8	90	8140.43 <M8>				
			Mot.-Nr. →3050379	10.97-03.00		0 460 424 152	
			Mot.-Nr. 30503780→	04.00-03.02		0 460 424 220	
TD, TD 4x4 [244]	2,8	90	8140.43 <M25>	10.02-08.06		0 460 424 220	

**FORD**

**Econovan**

2.0 D	2,0	41	RF <Mazda>	FIN,N	02.86-12.99	9 460 610 188	
					10.87-12.99	9 460 610 304	
						9 460 610 305	
				FIN,N	02.86-12.99	9 460 610 189	

**Serie F**

100 3.9 D 4x4	3,9	49		01.83-08.99	KOC,TW	0 460 424 183	
					TW	0 460 424 186	
						0 460 424 208	

**Transit**

<b>Euroline</b> 2.0 TDE [00]	2,0	74	ABFA <PD20>	08.00-07.06		0 470 004 012	0 986 444 522
							0 986 444 523
2.5 D [95]	2,5	51	4FA <D25N>; 4FB <D25N>; 4FC <D25N>; 4FD <D25N>	09.97-08.00	WEG	0 460 414 142	0 986 440 217
					WEG	0 460 414 141	0 986 440 052
2.5 DI [95]	2,5	56	4HB <D25P>; 4HC <D25P>	09.97-08.00	WEG	0 460 414 146	0 986 440 054
					WEG	0 460 414 145	0 986 440 053
<b>FT 080</b> 2.5 D [95]	2,5	51	4FA <D25N>; 4FB <D25N>; 4FC <D25N>; 4FD <D25N>	09.97-08.00	WEG	0 460 414 142	0 986 440 217
					WEG	0 460 414 141	0 986 440 052
2.5 DI [95]	2,5	56	4HB <D25P>; 4HC <D25P>	09.97-08.00	WEG	0 460 414 146	0 986 440 054
					WEG	0 460 414 145	0 986 440 053
<b>FT 100</b> 2.5 D [95]	2,5	51	4FA <D25N>; 4FB <D25N>; 4FC <D25N>; 4FD <D25N>	09.97-08.00	WEG	0 460 414 142	0 986 440 217
					WEG	0 460 414 141	0 986 440 052
2.5 DI [95]	2,5	56	4HB <D25P>; 4HC <D25P>	09.97-08.00	WEG	0 460 414 146	0 986 440 054
					WEG	0 460 414 145	0 986 440 053
<b>FT 120</b> 2.5 D [95]	2,5	51	4FA <D25N>; 4FB <D25N>; 4FC <D25N>; 4FD <D25N>	09.97-08.00	WEG	0 460 414 142	0 986 440 217
					WEG	0 460 414 141	0 986 440 052
2.5 DI [95]	2,5	56	4HB <D25P>; 4HC <D25P>	09.97-08.00	WEG	0 460 414 146	0 986 440 054
					WEG	0 460 414 145	0 986 440 053
<b>FT 150</b> 2.5 DI [95]	2,5	56	4HB <D25P>; 4HC <D25P>	09.97-08.00	WEG	0 460 414 146	0 986 440 054
					WEG	0 460 414 145	0 986 440 053
<b>FT 190</b> 2.5 DI [95]	2,5	56	4HB <D25P>; 4HC <D25P>	09.97-08.00	WEG	0 460 414 146	0 986 440 054
					WEG	0 460 414 145	0 986 440 053
<b>FT 240 K/S</b> 2.0 TD, 2.0 TDE [00]	2,0	55/63	D3FA <PD20>; F3FA <PD20>	08.00-07.06		0 470 004 012	0 986 444 522
							0 986 444 523
<b>FT 260 K/S</b> 2.0 TD, 2.0 TDE [00]	2,0	55/63/74	ABFA <PD20>; D3FA <PD20>; F3FA <PD20>	08.00-07.06		0 470 004 012	0 986 444 522
							0 986 444 523
2.4 TDE [00]	2,4	66	D2F... <PD24P>	04.01-07.06		0 470 004 012	0 986 444 522
							0 986 444 523
<b>FT 280 K/S</b> 2.0 TD, 2.0 TDE [00]	2,0	55/63/74	ABFA <PD20>; D3FA <PD20>; F3FA <PD20>	08.00-07.06		0 470 004 012	0 986 444 522
							0 986 444 523
2.4 TDE [00]	2,4	66	D2F... <PD24P>	04.01-07.06		0 470 004 012	0 986 444 522
							0 986 444 523
<b>FT 280 L</b> 2.4 TDE [00]	2,4	55	F4FA <PD24N>	01.00-09.03		0 470 004 012	0 986 444 522
							0 986 444 523
		66	D2F... <PD24P>	01.00-07.06		0 470 004 012	0 986 444 522
							0 986 444 523
		85	FXFA <DuraTorq DI>	03.04-07.06		0 470 504 041	0 986 444 076
		92	DOFA <PD24PP>	01.00-04.03		0 470 504 018	0 986 444 078
				05.03-07.06		0 470 504 041	0 986 444 076





<b>FT 280 M</b> 2.0 TD, 2.0 TDE [00]	2,0	55/63/74	ABFA <PD20>; D3FA <PD20>; F3FA <PD20>	08.00-07.06		<b>0 470 004 012</b>	<b>0 986 444 522</b>
							<b>0 986 444 523</b>
2.4 TDE [00]	2,4	66	D2F... <PD24P>	04.01-07.06		<b>0 470 004 012</b>	<b>0 986 444 522</b>
							<b>0 986 444 523</b>
<b>FT 280 S</b> 2.4 TDI [00]	2,4	66	<IDI24>	01.01-05.06	WEG	<b>0 460 414 219</b>	
<b>FT 300 K/S</b> 2.0 TD, 2.0 TDE [00]	2,0	55/63/74	ABFA <PD20>; D3FA <PD20>; F3FA <PD20>	08.00-07.06		<b>0 470 004 012</b>	<b>0 986 444 522</b>
							<b>0 986 444 523</b>
<b>FT 300 L</b> 2.0 TD, 2.0 TDE [00]	2,0	55/63/74	ABFA <PD20>; D3FA <PD20>; F3FA <PD20>	08.00-07.06		<b>0 470 004 012</b>	<b>0 986 444 522</b>
							<b>0 986 444 523</b>
<b>FT 300 M</b> 2.0 TD, 2.0 TDE [00]	2,0	55/63/74	ABFA <PD20>; D3FA <PD20>; F3FA <PD20>	08.00-07.06		<b>0 470 004 012</b>	<b>0 986 444 522</b>
							<b>0 986 444 523</b>
<b>FT 300 S</b> 2.4 TDI [00]	2,4	66	<IDI24>	01.01-05.06	WEG	<b>0 460 414 219</b>	
<b>FT 310 S</b> 2.4 TDI [00]	2,4	88	<IDI24>	01.01-05.06	WEG	<b>0 460 414 216</b>	
					WEG	<b>0 460 414 218</b>	
<b>FT 330 K/S</b> 2.0 TDE [00]	2,0	74	ABFA <PD20>	08.03-07.06		<b>0 470 004 012</b>	<b>0 986 444 522</b>
							<b>0 986 444 523</b>
2.4 TD [00]	2,4	55	F4FA <PD24N>	01.00-09.03		<b>0 470 004 012</b>	<b>0 986 444 522</b>
							<b>0 986 444 523</b>
2.4 TDE [00]	2,4	66	D2F... <PD24P>	01.00-07.06		<b>0 470 004 012</b>	<b>0 986 444 522</b>
							<b>0 986 444 523</b>
		85	FXFA <DuraTorq DI>	03.04-07.06		<b>0 470 504 041</b>	<b>0 986 444 076</b>
		88	D4FA <PD24>	01.00-04.03		<b>0 470 504 018</b>	<b>0 986 444 078</b>
				05.03-07.06		<b>0 470 504 041</b>	<b>0 986 444 076</b>
		92	DOFA <PD24PP>	01.00-04.03		<b>0 470 504 018</b>	<b>0 986 444 078</b>
				05.03-07.06		<b>0 470 504 041</b>	<b>0 986 444 076</b>
<b>FT 330 L</b> 2.0 TDE [00]	2,0	74	ABFA <PD20>	08.03-07.06		<b>0 470 004 012</b>	<b>0 986 444 522</b>
							<b>0 986 444 523</b>
2.4 TD [00]	2,4	55	F4FA <PD24N>	01.00-09.03		<b>0 470 004 012</b>	<b>0 986 444 522</b>
							<b>0 986 444 523</b>
2.4 TDE [00]	2,4	66	D2F... <PD24P>	01.00-07.06		<b>0 470 004 012</b>	<b>0 986 444 522</b>
							<b>0 986 444 523</b>
		85	FXFA <DuraTorq DI>	03.04-07.06		<b>0 470 504 041</b>	<b>0 986 444 076</b>
		88	D4FA <PD24>	01.00-04.03		<b>0 470 504 018</b>	<b>0 986 444 078</b>
				05.03-07.06		<b>0 470 504 041</b>	<b>0 986 444 076</b>
		92	DOFA <PD24PP>	01.00-04.03		<b>0 470 504 018</b>	<b>0 986 444 078</b>
				05.03-07.06		<b>0 470 504 041</b>	<b>0 986 444 076</b>
2.4 TDI [00]	2,4	66	<IDI24>	01.01-05.06	WEG	<b>0 460 414 219</b>	
		88	<IDI24>	01.01-05.06	WEG	<b>0 460 414 216</b>	
					WEG	<b>0 460 414 218</b>	
<b>FT 330 M</b> 2.0 TDE [00]	2,0	74	ABFA <PD20>	08.03-07.06		<b>0 470 004 012</b>	<b>0 986 444 522</b>
							<b>0 986 444 523</b>
2.4 TD [00]	2,4	55	F4FA <PD24N>	01.00-09.03		<b>0 470 004 012</b>	<b>0 986 444 522</b>
							<b>0 986 444 523</b>
2.4 TDE [00]	2,4	66	D2F... <PD24P>	01.00-07.06		<b>0 470 004 012</b>	<b>0 986 444 522</b>
							<b>0 986 444 523</b>
		85	FXFA <DuraTorq DI>	03.04-07.06		<b>0 470 504 041</b>	<b>0 986 444 076</b>
		88	D4FA <PD24>	01.00-04.03		<b>0 470 504 018</b>	<b>0 986 444 078</b>
				05.03-07.06		<b>0 470 504 041</b>	<b>0 986 444 076</b>
		92	DOFA <PD24PP>	01.00-04.03		<b>0 470 504 018</b>	<b>0 986 444 078</b>
				05.03-07.06		<b>0 470 504 041</b>	<b>0 986 444 076</b>
2.4 TDI [00]	2,4	66	<IDI24>	01.01-05.06	WEG	<b>0 460 414 219</b>	
		88	<IDI24>	01.01-05.06	WEG	<b>0 460 414 216</b>	
					WEG	<b>0 460 414 218</b>	
<b>FT 330 S</b> 2.4 TDI [00]	2,4	66	<IDI24>	01.01-05.06	WEG	<b>0 460 414 219</b>	
		88	<IDI24>	01.01-05.06	WEG	<b>0 460 414 216</b>	
					WEG	<b>0 460 414 218</b>	
<b>FT 350 E</b> 2.4 TDI [00]	2,4	66	<IDI24>	01.01-05.06	WEG	<b>0 460 414 219</b>	
		88/96	<IDI24>	01.01-05.06	WEG	<b>0 460 414 216</b>	
					WEG	<b>0 460 414 218</b>	
<b>FT 350 EL</b> 2.0 TDE [00]	2,0	74	ABFA <PD20>	08.03-07.06		<b>0 470 004 012</b>	<b>0 986 444 522</b>
							<b>0 986 444 523</b>
2.4 TD [00]	2,4	55	F4FA <PD24N>	01.00-09.03		<b>0 470 004 012</b>	<b>0 986 444 522</b>
							<b>0 986 444 523</b>





◀ FORD

<b>FT 350 EL 2.4 TDE [00]</b>	2,4	66	D2F... <PD24P>		01.00-07.06		<b>0 470 004 012</b>	<b>0 986 444 522</b>	
								<b>0 986 444 523</b>	
		85	FXFA <DuraTorq DI>		03.04-07.06		<b>0 470 504 041</b>	<b>0 986 444 076</b>	
		92	DOFA <PD24PP>		01.00-04.03		<b>0 470 504 018</b>	<b>0 986 444 078</b>	
					05.03-07.06		<b>0 470 504 041</b>	<b>0 986 444 076</b>	
<b>FT 350 L 2.0 TDE [00]</b>	2,0	74	ABFA <PD20>		08.03-07.06		<b>0 470 004 012</b>	<b>0 986 444 522</b>	
								<b>0 986 444 523</b>	
2.4 TD [00]	2,4	55	F4FA <PD24N>		01.00-09.03		<b>0 470 004 012</b>	<b>0 986 444 522</b>	
								<b>0 986 444 523</b>	
2.4 TDE [00]	2,4	66	D2F... <PD24P>		01.00-07.06		<b>0 470 004 012</b>	<b>0 986 444 522</b>	
								<b>0 986 444 523</b>	
		85	FXFA <DuraTorq DI>		03.04-07.06		<b>0 470 504 041</b>	<b>0 986 444 076</b>	
		88	D4FA <PD24>		01.00-04.03		<b>0 470 504 018</b>	<b>0 986 444 078</b>	
					05.03-07.06		<b>0 470 504 041</b>	<b>0 986 444 076</b>	
		92	DOFA <PD24PP>		01.00-04.03		<b>0 470 504 018</b>	<b>0 986 444 078</b>	
					05.03-07.06		<b>0 470 504 041</b>	<b>0 986 444 076</b>	
2.4 TDI [00]	2,4	66	<IDI24>		01.01-05.06	WEG	<b>0 460 414 219</b>		
		88/96	<IDI24>		01.01-05.06	WEG	<b>0 460 414 216</b>		
						WEG	<b>0 460 414 218</b>		
<b>FT 350 M 2.0 TDE [00]</b>	2,0	74	ABFA <PD20>		08.03-07.06		<b>0 470 004 012</b>	<b>0 986 444 522</b>	
								<b>0 986 444 523</b>	
2.4 TD [00]	2,4	55	F4FA <PD24N>		01.00-09.03		<b>0 470 004 012</b>	<b>0 986 444 522</b>	
								<b>0 986 444 523</b>	
2.4 TDE [00]	2,4	66	D2F... <PD24P>		01.00-07.06		<b>0 470 004 012</b>	<b>0 986 444 522</b>	
								<b>0 986 444 523</b>	
		85	FXFA <DuraTorq DI>		03.04-07.06		<b>0 470 504 041</b>	<b>0 986 444 076</b>	
		88	D4FA <PD24>		01.00-04.03		<b>0 470 504 018</b>	<b>0 986 444 078</b>	
					05.03-07.06		<b>0 470 504 041</b>	<b>0 986 444 076</b>	
		92	DOFA <PD24PP>		01.00-04.03		<b>0 470 504 018</b>	<b>0 986 444 078</b>	
					05.03-07.06		<b>0 470 504 041</b>	<b>0 986 444 076</b>	
2.4 TDI [00]	2,4	66	<IDI24>		01.01-05.06	WEG	<b>0 460 414 219</b>		
		88/96	<IDI24>		01.01-05.06	WEG	<b>0 460 414 216</b>		
						WEG	<b>0 460 414 218</b>		
<b>FT 430 E 2.4 TDI [00]</b>	2,4	96	<IDI24>		06.04-05.06	WEG	<b>0 460 414 216</b>		
						WEG	<b>0 460 414 218</b>		
<b>FT 430 EL 2.4 TD [00]</b>	2,4	55	F4FA <PD24N>		08.02-09.03		<b>0 470 004 012</b>	<b>0 986 444 522</b>	
								<b>0 986 444 523</b>	
2.4 TDE [00]	2,4	66	D2F... <PD24P>		08.02-07.06		<b>0 470 004 012</b>	<b>0 986 444 522</b>	
								<b>0 986 444 523</b>	
		85	FXFA <DuraTorq DI>		03.04-07.06		<b>0 470 504 041</b>	<b>0 986 444 076</b>	
		92	DOFA <PD24PP>		08.02-04.03		<b>0 470 504 018</b>	<b>0 986 444 078</b>	
					05.03-07.06		<b>0 470 504 041</b>	<b>0 986 444 076</b>	
<b>FT 430 M 2.4 TD [00]</b>	2,4	55	F4FA <PD24N>		08.02-09.03		<b>0 470 004 012</b>	<b>0 986 444 522</b>	
								<b>0 986 444 523</b>	
2.4 TDE [00]	2,4	85	FXFA <DuraTorq DI>		03.04-07.06		<b>0 470 504 041</b>	<b>0 986 444 076</b>	
		92	DOFA <PD24PP>		08.02-04.03		<b>0 470 504 018</b>	<b>0 986 444 078</b>	
					05.03-07.06		<b>0 470 504 041</b>	<b>0 986 444 076</b>	
<b>Nugget 2.0 TDE [00]</b>	2,0	74	ABFA <PD20>		08.00-07.06		<b>0 470 004 012</b>	<b>0 986 444 522</b>	
								<b>0 986 444 523</b>	
2.5 D [95]	2,5	51	4FA <D25N>; 4FB <D25N>; 4FC <D25N>; 4FD <D25N>		09.97-08.00	WEG	<b>0 460 414 142</b>	<b>0 986 440 217</b>	
						WEG	<b>0 460 414 141</b>	<b>0 986 440 052</b>	
2.5 DI [95]	2,5	56	4HB <D25P>; 4HC <D25P>		09.97-08.00	WEG	<b>0 460 414 146</b>	<b>0 986 440 054</b>	
						WEG	<b>0 460 414 145</b>	<b>0 986 440 053</b>	
<b>Transit Connect</b>									
<b>1.8 TDDi [02]</b>	1,8	55	BHPA <Euro3>; BHPB <93EEC>		05.02-06.10		<b>0 470 004 008</b>	<b>0 986 444 521</b>	
<b>Transit Tourneo</b>									
<b>2.0 TDE [00]</b>	2,0	74	ABFA <PD20>		08.00-07.06		<b>0 470 004 012</b>	<b>0 986 444 522</b>	
								<b>0 986 444 523</b>	
2.5 D [95]	2,5	51	4FA <D25N>; 4FB <D25N>; 4FC <D25N>; 4FD <D25N>		09.97-08.00	WEG	<b>0 460 414 142</b>	<b>0 986 440 217</b>	
						WEG	<b>0 460 414 141</b>	<b>0 986 440 052</b>	
DI [95]	2,5	56	4HB <D25P>; 4HC <D25P>		09.97-08.00	WEG	<b>0 460 414 146</b>	<b>0 986 440 054</b>	
						WEG	<b>0 460 414 145</b>	<b>0 986 440 053</b>	

**GMC (GENERAL MOTORS CORP.)****GMC**

<b>3500 HD</b>	4,2	110	6.07T <Sprint 6.07T>	08.96-12.99	<b>0 460 426 259</b>
				01.00-12.01	<b>0 460 426 331</b>

**HYUNDAI****H 100**

<b>2.5 D Turbo</b>	2,5	59	D4BF	07.93-03.00 TW	<b>9 460 614 023</b>
				05.05→ TW	<b>9 460 614 023</b>
					<b>9 460 614 199</b>
Intercooler	2,5	57	D4BA	07.94-03.00 E96,TW	<b>9 460 614 023</b>
TCI	2,5	63	D4BF <4D56>	09.96-09.04 TW	<b>9 460 614 023</b>

**H-1**

<b>2.5 Tci</b>	2,5	73-74	D4BH <4D56>	07.01-01.04 GS,N14, WEG	<b>9 460 614 002</b>
				02.04-12.07 TW	<b>9 460 614 829</b>

**H100**

<b>2.5 TDI</b>	2,5	59-70	D4BF	10.04-12.08	<b>9 460 614 826</b>
----------------	-----	-------	------	-------------	----------------------

**Starex**

<b>2.5 TCI</b>	2,5	74	D4BH <4D56TC>	10.02-01.04 GS,N14, WEG	<b>9 460 614 002</b>
----------------	-----	----	---------------	----------------------------	----------------------

**ISUZU****FVZ 1400T**

<b>9.8 D Turbo</b>	9,8	199	6SD1TC-N	05.99→ ZDA	<b>9 400 612 913</b>
--------------------	-----	-----	----------	------------	----------------------

**N-Serie**

<b>NHR 55E 2.8 D Turbo, 2.8 TD</b>	2,8	67/70	4JB1T; 4JB1-TC	09.05-12.08 ZDA	<b>9 460 614 881</b>
<b>NKR 55L 2.8 D Turbo</b>	2,8	67	4JB1T	09.99-12.08 TW,ZDA	<b>9 460 613 317</b>
					<b>9 460 614 881</b>
<b>N250 T Carrier 2.8 D Turbo</b>	2,8	67	4JB1T	09.99-12.07 ZDA	<b>9 460 614 881</b>

**IVECO****Daily**

<b>A40 -10 Turbo</b>	2,8	76	8140.23.37... <Euro 2>	05.96-05.99	<b>0 460 424 124</b>	<b>0 986 440 062</b>
-12 Turbo	2,8	90	8140.43.37... <Euro 2>	05.96-05.99	<b>0 460 424 125</b>	<b>0 986 440 063</b>
			8140.43.3723 <Euro 2>	05.96-05.99 WEG	<b>0 460 424 169</b>	
<b>A45 -10 Turbo</b>	2,8	76	8140.23.3721 <Euro 2>	05.96-05.99	<b>0 460 424 124</b>	<b>0 986 440 062</b>
-12 Turbo	2,8	90	8140.43.37... <Euro 2>	05.96-05.99	<b>0 460 424 125</b>	<b>0 986 440 063</b>
			8140.43.3723 <Euro 2>	05.96-05.99 WEG	<b>0 460 424 169</b>	
<b>A49 -10 Turbo</b>	2,8	76	8140.23.37... <Euro 2>	05.96-05.99	<b>0 460 424 124</b>	<b>0 986 440 062</b>
<b>29 L 9 [00]</b>	2,8	62	8140.63.4000	05.99-12.01	<b>0 460 494 471</b>	
11 [00]	2,8	78	8140.43C	05.99-09.02	<b>0 460 424 177</b>	
<b>35 10</b>	2,8	76	8140.23 <ID/TCA>	11.97-05.02	<b>0 460 424 124</b>	<b>0 986 440 062</b>
				06.02-07.07	<b>0 460 424 243</b>	
12	2,8	90	8140.43 <ID/TCA>	11.97-05.02	<b>0 460 424 125</b>	<b>0 986 440 063</b>
				06.02-07.07	<b>0 460 424 244</b>	
<b>35 C 9 [00]</b>	2,8	62	8140.63.40...	05.99-12.01	<b>0 460 494 471</b>	
11 [00]	2,8	78	8140.43C...	05.99-09.02	<b>0 460 424 177</b>	
<b>35 S 9 [00]</b>	2,8	62	8140.63.40...	05.99-12.01	<b>0 460 494 471</b>	
11 [00]	2,8	78	8140.43C...	05.99-03.02	<b>0 460 424 177</b>	
<b>40 10</b>	2,5	76	8140.27S	11.97-12.01	<b>0 460 424 124</b>	<b>0 986 440 062</b>
12	2,8	76	8140.43	11.97-05.02	<b>0 460 424 125</b>	<b>0 986 440 063</b>
				06.02-07.07	<b>0 460 424 244</b>	
<b>49 12</b>	2,8	90	8140.43	11.97-05.02	<b>0 460 424 125</b>	<b>0 986 440 063</b>
				06.02-07.07	<b>0 460 424 244</b>	







◀ IVECO

50 C 11 [00]	2,8	78	8140.43C...		05.99-09.02		0 460 424 177		
59 12	2,8	76	8140.43		11.97-05.02		0 460 424 125	0 986 440 063	
					06.02-07.07		0 460 424 244		
60 12	2,8	90	8140.43		10.02-07.07		0 460 424 125	0 986 440 063	
<b>Daily, Grinta</b>									
30 -8	2,5	60	8140.67F.37... <Euro 2>		05.96-03.98		0 460 404 085		
	2,8	62	8140.63.37... <Euro 2>		04.98-05.99		0 460 494 464		
-10 Turbo	2,8	76	8140.23.37... <Euro 2>		05.96-05.99		0 460 424 124	0 986 440 062	
			8140.23.3713 <Euro 2>		07.97-05.99	WEG	0 460 424 170		
35 -8	2,5	60	8140.67F.37... <Euro 2>		05.96-03.98		0 460 404 085		
	2,8	62	8140.63.37... <Euro 2>		04.98-05.99		0 460 494 464		
-10 Turbo	2,8	76	8140.23.37... <Euro 2>		05.96-05.99		0 460 424 124	0 986 440 062	
			8140.23.3713 <Euro 2>		07.97-05.99	WEG	0 460 424 170		
-12 Turbo	2,8	90	8140.43.37... <Euro 2>		05.96-05.99		0 460 424 125	0 986 440 063	
						WEG	0 460 424 169		
			8140.43.39... <Euro 2>						
			Mot.-Nr. →2527005		05.96-05.99		0 460 424 157		
			Mot.-Nr. 2527006→		05.96-05.99		0 460 424 168		
40 -10 Turbo 4x4	2,8	76	8140.23.3801 <Euro 2>		05.96-05.99		0 460 424 124	0 986 440 062	
49 -10 Turbo	2,8	76	8140.23.37... <Euro 2>		05.96-05.99		0 460 424 124	0 986 440 062	
			8140.23.3713 <Euro 2>		07.97-05.99	WEG	0 460 424 170		
-12 Turbo	2,8	90	8140.43.37... <Euro 2>		05.96-05.99		0 460 424 125	0 986 440 063	
						WEG	0 460 424 169		
59 -12 Turbo	2,8	90	8140.43.37... <Euro 2>		05.96-05.99		0 460 424 125	0 986 440 063	
<b>EuroCargo</b>									
65 E 12	4,0	85	8040.45D...		06.96-07.00		0 460 424 132		
75 E 12	4,0	85	8040.45D.51...		01.94-08.00		0 460 424 132		
14	4,0	100	8040.45.5...		01.93-08.00		0 460 424 110		
15	6,0	105	8060.45R.50...		01.93-08.00		0 460 426 255		
80 E 15	6,0	105	8060.25R.42...		01.91-08.00		0 460 426 169		
			8060.45R.50...		01.93-08.00		0 460 426 255		
18	5,9	130	8060.45B.51...		09.91-07.00		0 460 426 242		
	6,0	130	8060.25V.40...		01.91-08.00		0 460 426 171	0 986 440 076	
21	6,0	152	8060.45X.4180		01.92-06.00		0 460 426 198		
			8060.45.41...		01.91-08.00	KOC	0 460 426 170		
			8060.45.4403		01.91-08.00	KOC	0 460 426 215		
			8060.45.52...		01.91-08.00		0 460 426 252		
85 E 18	6,0	130	8060.25V.4900		01.91-08.00		0 460 426 171	0 986 440 076	
			8060.45B.43...		09.91-07.00		0 460 426 230		
			8060.45B.51...		09.91-07.00		0 460 426 242		
90 E 15	6,0	105	8060.45R.50...		01.93-08.00		0 460 426 255		
18	6,0	130	8060.45B.43...		09.91-07.00		0 460 426 230		
			8060.45B.51...		09.91-07.00		0 460 426 242		
21	6,0	152	8060.45.47...		01.91-12.00	KOC	0 460 426 170		
			8060.45.52...		01.91-08.00		0 460 426 252		
100 E 15	6,0	105	8060.25R.42...		01.91-08.00		0 460 426 169		
			8060.45R.50...		01.91-08.00		0 460 426 255		
18	5,9	130	8060.45B.51...		09.91-07.00		0 460 426 242		
	6,0	130	8060.25V.40...		01.91-11.00		0 460 426 171	0 986 440 076	
21	6,0	152	8060.45X.4180 TCA		01.92-11.00		0 460 426 198		
			8060.45.41...		01.91-11.00	KOC	0 460 426 170		
			8060.45.4403		01.91-08.00	KOC	0 460 426 215		
			8060.45.52...		01.91-08.00		0 460 426 252		
120 E 15	6,0	105	8060.25R.4...		12.91-07.00		0 460 426 169		
			8060.45R.50...		12.91-07.00		0 460 426 255		
18	6,0	130	8060.25V.4...		09.91-07.00		0 460 426 171	0 986 440 076	
			8060.45B.51...		09.91-07.00		0 460 426 242		
21	6,0	152	8060.45.52...		01.91-08.00		0 460 426 252		
130 E 15	6,0	105	8060.25R.4...		02.92-07.00		0 460 426 169		
			8060.45R.50...		12.91-07.00		0 460 426 255		
18	6,0	130	8060.25V.4...		11.91-07.00		0 460 426 171	0 986 440 076	
			8060.45B.51...		09.91-07.00		0 460 426 242		
135 E 18	5,8	130	8060.25V.472...		01.94-07.00		0 460 426 171	0 986 440 076	





<b>135 E 18</b>	5,8	130	8060.45B.51...	01.94-07.00	<b>0 460 426 242</b>
<b>150 E 15</b>	6,0	105	8060.25R.4...	12.91-07.00	<b>0 460 426 169</b>
			8060.45R.50...	12.91-07.00	<b>0 460 426 255</b>
18	6,0	130	8060.25V.4...	09.91-07.00	<b>0 460 426 171 0 986 440 076</b>
			8060.45B.51...	09.91-07.00	<b>0 460 426 242</b>
21	6,0	152	8060.45.52...	01.91-08.00	<b>0 460 426 252</b>
<b>170 E 18</b>	5,8	130	8060.25V.41...	01.94-07.00	<b>0 460 426 171 0 986 440 076</b>
	6,0	130	8060.45B.51...	09.91-07.00	<b>0 460 426 242</b>
<b>170 R 15</b>	6,0	105	8060.25R.436...	12.91-07.00	<b>0 460 426 169</b>
<b>180 E 21</b>	6,0	152	8060.45.41...	04.92-07.00 KOC	<b>0 460 426 170</b>
			8060.45.4403	04.92-07.00 KOC	<b>0 460 426 215</b>
			8060.45.52...	04.92-07.00	<b>0 460 426 252</b>

**Scudato**

<b>35 .10</b>	2,8	76	8140.23 <ID/TCA>	01.99-12.03	<b>0 460 424 124 0 986 440 062</b>
<b>49 .12</b>	2,8	76	8140.43	11.99-05.02	<b>0 460 424 125 0 986 440 063</b>
<b>59 .12</b>	2,8	76	8140.43	06.02-09.05	<b>0 460 424 125 0 986 440 063</b>
<b>300</b>					
<b>315 .8.18</b>	5,5	130	8060.25V.4600	06.91-11.00	<b>0 460 426 171 0 986 440 076</b>
			8060.45B.5160	06.91-11.00	<b>0 460 426 242</b>
<b>316 .8.18</b>	5,5	130	8060.25V.4600	06.91-11.00	<b>0 460 426 171 0 986 440 076</b>
			8060.45B.5160	06.91-11.00	<b>0 460 426 242</b>

**KIA****K 2500**

<b>2.5 Tci</b>	2,5	69-96	D4BH	09.01-06.04 ZDA	<b>F 01G 09W 00Y</b>
<b>Pregio</b>					
<b>2.5 Tci [TB]</b>	2,5	69	D4BH	08.01-04.04 ZDA	<b>F 01G 09W 00Y</b>
				05.04-12.06 ZDA	<b>F 01G 09W 0C3</b>

**MAHINDRA****Bolero Camper**

<b>2.5 D</b>	2,5	43	MDI 3200 D	06.03-11.03	<b>0 460 414 209</b>
				12.03→	<b>0 460 414 231</b>
		74	NEF TCI	10.04→	<b>0 460 414 240</b>

**FJ Bus**

<b>2.1 D [FJ 460 DP]</b>	2,1	44	XDP-4.90 IDI	04.96-02.00	<b>0 460 494 434</b>
--------------------------	-----	----	--------------	-------------	----------------------

**FJ Truck**

<b>2.1 D [FJ 470 DP]</b>	2,1	44	XDP-4.90 IDI	04.96-02.00	<b>0 460 494 434</b>
D 4WD [FJ 460 DP]	2,1	44	XDP-4.90 IDI	04.96-06.98	<b>0 460 494 434</b>

**LoadKing Pride**

<b>2.6 TCI</b>	2,6	54	NEF 3200 TCI	03.05-12.09	<b>0 460 414 236</b>
----------------	-----	----	--------------	-------------	----------------------

**NC 640 DP Pick up**

<b>2.1 D, D 4WD</b>	2,1	46	XDP 4.90	04.96-10.03	<b>0 460 494 434</b>
---------------------	-----	----	----------	-------------	----------------------

**Tourister**

<b>2.5 D</b>	2,5	45	MDI 3200 TCI E	01.10→	<b>0 460 414 197</b>
--------------	-----	----	----------------	--------	----------------------

**MAN****Bus 8t**

<b>8.150 FOC [L50]</b>	4,6	114-118	D 0824 LFO01 <V1700, Euro 2>	02.95-07.98	<b>0 460 424 104</b>
FOCL [L51]	4,6	114-118	D 0824 LFO01 <V1700, Euro 2>	11.95-07.98	<b>0 460 424 104</b>
<b>8.160 FOC [L50]</b>	4,6	114-118	D 0824 LFL09 <V1700, Euro 2>	06.97-02.01	<b>0 460 424 150</b>
FOCL [L51]	4,6	118	D 0824 LFL09 <V1700, Euro 2>	06.97-02.01	<b>0 460 424 150</b>
<b>8.220 FOC [L52]</b>	6,9	162	D 0826 LFL10 <V2300, Euro 2>	07.98-02.01 MVR	<b>0 460 426 273</b>
FOCL [L53]	6,9	162	D 0826 LFL10 <V2300, Euro 2>	07.98-09.01 MVR	<b>0 460 426 273</b>

**Bus 11t**

<b>11.220 HOCL [469]</b>	6,9	162	D 0826 LOH19 <V2900, Euro 2>	07.98-09.01 MRQ	<b>0 460 426 281</b>
				MVR	<b>0 460 426 273</b>





◀ MAN

Bus 12t							
12.220	HOCL-NL [A76]	6,9	162	D 0826 LOH19 <V2900, Euro 2>	07.98-09.02	MRQ	0 460 426 281
						MVR	0 460 426 273
Bus 14t							
14.220	HOCL-NL [A66]	6,9	162	D 0826 LOH19 <V2900, Euro 2>	07.98-09.01	MRQ	0 460 426 281
						MVR	0 460 426 273
Bus 18t							
18.220	HOCL-NL [A69]	6,9	162	D 0826 LOH19 <V2900, Euro 2>	07.98-09.01	MRQ	0 460 426 281
						MVR	0 460 426 273
L2000							
8.113	L, LL	4,6	83	D 0824 LFL08 <V1700, Euro 2>	03.97-09.01		0 460 424 153
8.163	L, LA, LL	4,6	114	D 0824 LFL09 <V1700, Euro 2>	03.97-02.02		0 460 424 150
8.224	L, LC, LK, L-KI, LK-LV, LLC, LLS	6,9	162	D 0826 LFL10 <V2300, Euro 2>	07.94-09.01	MVR	0 460 426 273
9.163	L, LL	4,6	114	D 0824 LFL09 <V1700, Euro 2>	03.97-09.01		0 460 424 150
9.224	LC, LK, L-KI, LK-LV, LLC, LLS	6,9	162	D 0826 LFL10 <V2300, Euro 2>	07.94-09.01	MVR	0 460 426 273
10.160	LA	4,6	114	D 0824 LFL09 <V1700, Euro 2>	03.97-09.06		0 460 424 150
10.163	L, LA, LL	4,6	114	D 0824 LFL09 <V1700, Euro 2>	03.97→		0 460 424 150
10.220	FOC, FOCL	6,9	162	D 0826 LFL10 <V2300, Euro 2>	07.98-09.01	MVR	0 460 426 273
10.224	F, FL, LA, LC, LK, LK-L	6,9	162	D 0826 LFL10 <V2300, Euro 2>	07.98-12.06	MVR	0 460 426 273
12.163	L, LL	4,6	114	D 0824 LFL09 <V1700, Euro 2>	03.97-08.01		0 460 424 150
12.224	L, LL	6,9	162	D 0826 LFL10 <V2300, Euro 2>	03.97-09.01	MVR	0 460 426 273
14.163	L, LL	4,6	114	D 0824 LFL09 <V1700, Euro 2>	03.97-08.01		0 460 424 150
14.224	L, LA, LL	6,9	162	D 0826 LFL10 <V2300, Euro 2>	03.97-09.01	MVR	0 460 426 273
15.163	L, LL	4,6	114	D 0824 LFL09 <V1700, Euro 2>	03.97-09.01		0 460 424 150
15.224	L, LL	6,9	162	D 0826 LFL10 <V2300, Euro 2>; D 0826 LF10 <V2300, Euro 2>	03.97→	MVR	0 460 426 273
18.224	L, LA, LL	6,9	162	D 0826 LFL10 <V2300, Euro 2>	03.97-09.01	MVR	0 460 426 273
20.224	L, LL	6,9	162	D 0826 LFL10 <V2300, Euro 2>	10.97-09.01	MVR	0 460 426 273
L2000 Evol. (LE)							
220C	F, FA, F, FL	6,9	162	D 0826 LFL10 <V2300, Euro 2>	09.00-01.02	MVR	0 460 426 273
M2000							
12.163	L	4,6	114	D 0824 LFL09 <V1700, Euro 2>	03.00-12.01		0 460 424 150
12.224	M, ML	6,9	162	D 0826 LF18 <V3000, Euro 2>	03.97-09.01	MVR	0 460 426 273
14.224	M, MA, ML	6,9	162	D 0826 LF18 <V3000, Euro 2>	03.97-09.01	MVR	0 460 426 273
18.224	LS, AK, LA, M, MA, ML, MLLC	6,9	162	D 0826 LFL10 <V2300, Euro 2>; D 0826 LF18 <V3000, Euro 2>	03.97→	MVR	0 460 426 273
18.232	FOC/HOC	6,9	162	D 0826 LFL10 <V2300, Euro 2>	03.97→	MVR	0 460 426 273
25.224	M, ML, MVL	6,9	162	D 0826 LF18 <V3000, Euro 2>	03.97-09.01	MVR	0 460 426 273
25.264	ML	6,9	191	D 0826 LF17 <V3000, Euro 2>	08.95-01.01	MVR	0 460 426 273
M2000 Evol. (LE)							
220B	DF, F, FL	6,9	162	D 0826 LFL10 <V2300, Euro 2>	08.00-09.01	MVR	0 460 426 273
M2000 Evol. (ME)							
220B	DF, F, FL	6,9	162	D 0826 LF18 <V3000, Euro 2>	09.00-09.01	MVR	0 460 426 273
M2000 LE							
LE 232	FOC	6,9	162	D 0826 LFL10 <V2300, Euro 2>	08.00→	MVR	0 460 426 273
SÜ							
223	[A72]	6,9	162	D 0826 LOH19 <V2900, Euro 2>	11.99-09.01	MRQ	0 460 426 281
						MVR	0 460 426 273



**MERCEDES-BENZ**

Sprinter							
210D	[T1N]	2,9	75	OM 602.980 DLA	01.97-03.00	FE2	0 460 415 982
							0 986 440 525
							0 986 440 576
				Mot.-Nr. →..000136	01.97-03.00	AG,FE2	0 460 415 995
							0 986 440 533
							0 986 440 580
				Mot.-Nr. →..009849	01.97-03.00	FE2,GS	0 460 415 995
							0 986 440 533
							0 986 440 580
				Mot.-Nr. ...000137→	01.97-03.00	AG,FE2	0 460 415 992
							0 986 440 531
							0 986 440 579
				Mot.-Nr. ...009850→	01.97-03.00	FE2,GS	0 460 415 992
							0 986 440 531
							0 986 440 579



<b>212 D</b> [T1N]	2,9	90	OM 602.980 D LA	02.95-03.00	FE2	<b>0 460 415 982</b>	<b>0 986 440 525</b>
							<b>0 986 440 576</b>
			Mot.-Nr. →..000136	02.95-03.00	AG,FE2	<b>0 460 415 995</b>	<b>0 986 440 533</b>
							<b>0 986 440 580</b>
			Mot.-Nr. →..009849	02.95-03.00	FE2,GS	<b>0 460 415 995</b>	<b>0 986 440 533</b>
							<b>0 986 440 580</b>
			Mot.-Nr. ..000137→	02.95-03.00	AG,FE2	<b>0 460 415 992</b>	<b>0 986 440 531</b>
							<b>0 986 440 579</b>
			Mot.-Nr. ...009850→	02.95-03.00	FE2,GS	<b>0 460 415 992</b>	<b>0 986 440 531</b>
							<b>0 986 440 579</b>
<b>310 D</b>	2,5	70	OM 014 A <(632.999)>	09.96-05.01		<b>0 460 414 160</b>	
D [T1N]	2,9	75	OM 602.980 D LA	01.97-03.00	FE2	<b>0 460 415 982</b>	<b>0 986 440 525</b>
							<b>0 986 440 576</b>
			Mot.-Nr. →..000136	01.97-03.00	AG,FE2	<b>0 460 415 995</b>	<b>0 986 440 533</b>
							<b>0 986 440 580</b>
			Mot.-Nr. →..009849	01.97-03.00	FE2,GS	<b>0 460 415 995</b>	<b>0 986 440 533</b>
							<b>0 986 440 580</b>
			Mot.-Nr. ..000137→	01.97-03.00	AG,FE2	<b>0 460 415 992</b>	<b>0 986 440 531</b>
							<b>0 986 440 579</b>
			Mot.-Nr. ...009850→	01.97-03.00	FE2,GS	<b>0 460 415 992</b>	<b>0 986 440 531</b>
							<b>0 986 440 579</b>
<b>312 D</b>	2,5	77	OM 014 LA <Euro 2 (632.997)>	10.99-05.01		<b>0 460 414 202</b>	
		85	OM 014 LA <Euro 2 (632.998)>	08.99-05.01		<b>0 460 414 198</b>	
D [T1N]	2,9	90	OM 602.980 D LA	02.95-03.00	FE2	<b>0 460 415 982</b>	<b>0 986 440 525</b>
							<b>0 986 440 576</b>
			Mot.-Nr. →..000136	02.95-03.00	AG,FE2	<b>0 460 415 995</b>	<b>0 986 440 533</b>
							<b>0 986 440 580</b>
			Mot.-Nr. →..009849	02.95-03.00	FE2,GS	<b>0 460 415 995</b>	<b>0 986 440 533</b>
							<b>0 986 440 580</b>
			Mot.-Nr. ..000137→	02.95-03.00	AG,FE2	<b>0 460 415 992</b>	<b>0 986 440 531</b>
							<b>0 986 440 579</b>
			Mot.-Nr. ...009850→	02.95-03.00	FE2,GS	<b>0 460 415 992</b>	<b>0 986 440 531</b>
							<b>0 986 440 579</b>
<b>410 D</b> [T1N]	2,9	75	OM 602.980 D LA	01.97-03.00	FE2	<b>0 460 415 982</b>	<b>0 986 440 525</b>
							<b>0 986 440 576</b>
			Mot.-Nr. →..000136	01.97-03.00	AG,FE2	<b>0 460 415 995</b>	<b>0 986 440 533</b>
							<b>0 986 440 580</b>
			Mot.-Nr. →..009849	01.97-03.00	FE2,GS	<b>0 460 415 995</b>	<b>0 986 440 533</b>
							<b>0 986 440 580</b>
			Mot.-Nr. ..000137→	01.97-03.00	AG,FE2	<b>0 460 415 992</b>	<b>0 986 440 531</b>
							<b>0 986 440 579</b>
			Mot.-Nr. ...009850→	01.97-03.00	FE2,GS	<b>0 460 415 992</b>	<b>0 986 440 531</b>
							<b>0 986 440 579</b>
<b>412 D</b>	2,5	85	OM 014 LA <Euro 2>	10.99-05.01		<b>0 460 414 198</b>	
D [T1N]	2,9	90	OM 602.980 D LA	02.95-03.00	FE2	<b>0 460 415 982</b>	<b>0 986 440 525</b>
							<b>0 986 440 576</b>
			Mot.-Nr. →..000136	02.95-03.00	AG,FE2	<b>0 460 415 995</b>	<b>0 986 440 533</b>
							<b>0 986 440 580</b>
			Mot.-Nr. →..009849	02.95-03.00	FE2,GS	<b>0 460 415 995</b>	<b>0 986 440 533</b>
							<b>0 986 440 580</b>
			Mot.-Nr. ..000137→	02.95-03.00	AG,FE2	<b>0 460 415 992</b>	<b>0 986 440 531</b>
							<b>0 986 440 579</b>
			Mot.-Nr. ...009850→	02.95-03.00	FE2,GS	<b>0 460 415 992</b>	<b>0 986 440 531</b>
							<b>0 986 440 579</b>





◀ MERCEDES-BENZ

Sprinter (James Cook)							
310 D [T1N]	2,9	75	OM 602.980 DLA	01.97-03.00	FE2	0 460 415 982	0 986 440 525 0 986 440 576
			Mot.-Nr. →..000136	01.97-03.00	AG,FE2	0 460 415 995	0 986 440 533 0 986 440 580
			Mot.-Nr. →..009849	01.97-03.00	FE2,GS	0 460 415 995	0 986 440 533 0 986 440 580
			Mot.-Nr...000137→	01.97-03.00	AG,FE2	0 460 415 992	0 986 440 531 0 986 440 579
			Mot.-Nr...009850→	01.97-03.00	FE2,GS	0 460 415 992	0 986 440 531 0 986 440 579
312 D [T1N]	2,9	90	OM 602.980 DLA	02.95-03.00	FE2	0 460 415 982	0 986 440 525 0 986 440 576
			Mot.-Nr. →..000136	02.95-03.00	AG,FE2	0 460 415 995	0 986 440 533 0 986 440 580
			Mot.-Nr. →..009849	02.95-03.00	FE2,GS	0 460 415 995	0 986 440 533 0 986 440 580
			Mot.-Nr...000137→	02.95-03.00	AG,FE2	0 460 415 992	0 986 440 531 0 986 440 579
			Mot.-Nr...009850→	02.95-03.00	FE2,GS	0 460 415 992	0 986 440 531 0 986 440 579
Unimog							
U90 [408]	2,9	90	OM 602.98... <DE 29 LA>				
			Mot.-Nr. →..045121	07.96-09.01	TW	0 460 415 988	0 986 440 527 0 986 440 577
			Mot.-Nr...044336→..044336 ..045122→..045360 ..045371→	07.96-09.01	FE2,TW	0 460 415 982	0 986 440 525 0 986 440 576
U100 L [408]	2,9	90	OM 602.98... <DE 29 LA>				
			Mot.-Nr. →..045121	07.96-09.01	TW	0 460 415 988	0 986 440 527 0 986 440 577
			Mot.-Nr...044336→..044336 ..045122→..045360 ..045371→	07.96-09.01	FE2,TW	0 460 415 982	0 986 440 525 0 986 440 576
UX							
100	2,9	85-90	OM 602.989 <DE 29 LA>	08.96-09.01		0 460 415 988	0 986 440 527 0 986 440 577
Vario							
512 D [T2W]	2,9	90	OM 602.984 LA <Euro 2>	09.96-01.01	EU2	0 460 415 988	0 986 440 527 0 986 440 577
					FE2	0 460 415 982	0 986 440 525 0 986 440 576
612 D [T2W]	2,9	90	OM 602.984,985 LA <Euro 2>	09.96-01.01	EU2	0 460 415 988	0 986 440 527 0 986 440 577
					FE2	0 460 415 982	0 986 440 525 0 986 440 576
812 , D [T2W]	2,9	90	OM 602... <Euro 2>; OM 602.984,985 LA <Euro 2>	09.96-09.06	EU2	0 460 415 988	0 986 440 527 0 986 440 577
					FE2	0 460 415 982	0 986 440 525 0 986 440 576



**MITSUBISHI**

Canter 35							
2.8 D Turbo [FB]	2,8	85	4M40	05.98-10.00	ZDA	9 460 614 113	
D Turbo Interc. [FE]	2,8	85	4M40	05.98-10.00	ZDA	9 460 614 113	
L 200							
2.5 D Turbo	2,5	64	4D56	08.97-12.03	TW	9 460 613 400	9 460 614 159
L 300							
2.5 D Turbo	2,5	73-74	4D56	08.98-12.03		9 460 610 776	



<b>L 300 Truck</b>							
2.5 D Turbo [P]	2,5	64	4D56		06.94-12.01	ABS	<b>9 460 610 696</b>
						AGF	<b>9 460 613 168</b>
						ABS	<b>9 460 610 695</b>
<b>L 300 Van</b>							
2.5 D Turbo 4WD [P]	2,5	62-64	4D56		01.92-12.01		<b>9 460 610 583</b>
D 2WD [P]	2,5	51-53	4D56		07.95-12.00		<b>9 460 610 683</b>

**NISSAN**

<b>Atleon</b>							
110 3.0	3,0	81	BD-30Ti		09.99-10.99	ZDA	<b>9 460 611 364</b>
					02.04-10.06		<b>0 470 504 047</b> <b>0 986 444 058</b>
120 3.0	3,0	88	BD-30Ti		02.04-10.06		<b>0 470 504 047</b> <b>0 986 444 058</b>
<b>Cabstar</b>							
3.5	3,5	87	FD35T		11.96-12.99		<b>9 400 619 545</b>
<b>Cabstar ZZ</b>							
4.6	4,6	90	FD46		11.99→	TW,ZDA	<b>9 400 610 551</b>
							<b>9 410 610 415</b>
<b>Cabstar 20</b>							
3.2	3,2	70	QD32		10.99-04.01	ZDA	<b>9 460 613 421</b>
					05.01→	ZDA	<b>9 460 614 025</b>
<b>Frontier</b>							
2.7 D [D22]	2,7	65-66	TD27		05.00-10.00	ZDA	<b>9 460 611 507</b>
					11.00-08.01	ZDA	<b>9 460 613 548</b>
					09.01→		<b>9 460 614 018</b>
<b>L50</b>							
4.0 D	4,0	66	B4II		06.94-12.04		<b>0 460 424 108</b>
			B440II		02.93-12.03		<b>0 460 424 099</b>
<b>L60</b>							
4.0 D	4,0	66	B4II		06.94-12.04		<b>0 460 424 108</b>
			B440II		02.93-12.03		<b>0 460 424 099</b>
<b>M</b>							
5.9 D	5,9	110	B660TII		03.93-12.08	KOC	<b>0 460 426 221</b>
<b>Trade</b>							
3.0 D	3,0	63	BD30		04.93-12.98	ZDA	<b>9 460 610 633</b>
<b>Urvan Bus</b>							
2.5 D [E25]	3,0	77-78	ZD30DD		07.01-11.12		<b>0 470 504 029</b>
<b>Vanette Cargo</b>							
2.3 D [C23M]	2,3	55	LD23		11.95-03.98	AGF,WEG	<b>0 460 494 404</b>
					07.96-03.98	TW,WEG	<b>0 460 494 355</b>
					04.98-07.99	AGF,WEG	<b>0 460 494 461</b>
						AGF,TW	<b>0 460 494 465</b>
						AGF,WEG	<b>0 460 494 469</b>
						AGF,TW	<b>0 460 494 468</b>
					08.99-11.01		<b>0 460 494 461</b>

**PAZ PAVLOVO**

<b>Serie 3000</b>							
3204	3,9	104	4BTAA 3.9-140 <Euro 2>		01.00→		<b>0 460 424 226</b>
3205	3,9	103	EQB-140-20 <Euro 2>		01.00→		<b>0 460 414 217</b>





**PEUGEOT**

Boxer							
1.9 D [U3]	1,9	50	DJY <XUD9>	07.98-02.02	BOW	0 460 484 070	
					WZT	0 460 484 146	
		51	D9B <XUD9A>	02.94-05.98	BOW	0 460 484 091	
				11.94-02.02	BOW,EFV	0 460 484 064 0 986 440 094	
				06.98-02.02	EFV,WZT	0 460 484 111	
D Turbo [U3]	1,9	66	DHX <XUD9TE>	02.94-02.02	KOC,N11,	0 460 494 383	
					WZT		
				01.96-02.02	BOW,EFV	0 460 494 423 0 986 440 156	
		68	D8C <XUD9TE>	02.94-02.02	WZT	0 460 494 388	
2.5 D [U3]	2,5	63	T9A <DJ5>	05.98-02.02	N05,WZT	0 460 494 460	
				Fg.-Nr. 15382157→	03.97-05.98	BOW,N03	0 460 494 429
			TDi [U3]	10.96-02.02	BOW	0 460 414 140 0 986 440 051	
				WZT	0 460 414 156		
2.8 D	2,8	66		03.02-08.05	KOC	0 460 494 483	
			D [U3]	2,8	64	8140 63 <SOFIM 2800>	01.99-02.02

**RENAULT**

B-Serie/Messenger						
B80	2,5	55	8140.67.2585 <Euro 2>	06.96-06.99		0 460 404 088
B110 , 4x4	2,8	78	8140.23.2565; 8140.23.2585 <Euro 2>	06.96-06.99		0 460 424 136 0 986 440 064
B120	2,8	90	8140.43.2585 <Euro 2>	06.96-06.01		0 460 424 137
Mascott						
90	2,8	63	8140.63.2585	01.99-06.04		0 460 494 464
			8140.63.2586	01.99-06.04		0 460 494 470
Master II						
1.9 dTi 80	1,9	58	F9Q 770	01.00-09.03		0 460 414 988 0 986 440 520
2.5 D	2,5	60	S8U 770 <8140,67.2620/29>	10.97-09.03	KL	0 460 404 090
					KL	0 460 404 093
			S8U 772	10.97-09.03	KL	0 460 404 097
2.8 D	2,8	86	S8W 700	05.01-10.04		0 460 494 484
dTi 110	2,8	81	S9W 700 <Sofim8140.43,2609/39>	10.97-06.00		0 460 424 148
dTi 120	2,8	84	S9W 702 <Sofim8140.43,2620/29>	10.97-06.00	KL	0 460 424 147 0 986 440 066
					KL	0 460 424 146 0 986 440 065
Trafic I						
2.1 D	2,1	44	J8S	07.86-10.99	WEG	0 460 494 381
2.5 D, D 4x4	2,5	55	S8U 782	11.97-05.01	BO,WEG	0 460 404 081
					BO,WEG	0 460 404 087
D 4x4	2,5	55	S8U 758	11.97-05.01	WEG	0 460 404 087

**STEYR (STEYR-DAIMLER-PUCH AG)**

8 S						
14	6,6	100	WD 612.61	05.89-12.98	KOC	0 460 426 099
9 S						
14	6,6	100	WD 612.61	06.86-12.98	KOC	0 460 426 099
10 S						
14	6,6	100	WD 612.61	06.86-12.98	KOC	0 460 426 099
11 S						
14	6,6	100	WD 612.61	07.89-12.98	KOC	0 460 426 099
12 S						
14	6,6	100	WD 612.61	06.86-12.98	KOC	0 460 426 099
13 S						
14	6,6	100	WD 612.61	09.88-12.98	KOC	0 460 426 099



<b>14 S</b>						
<b>14</b>	6,6	100	WD 612.61; WD 612.92		06.86-12.98 KOC	<b>0 460 426 099</b>
<b>15 S</b>						
<b>14</b>	6,6	100	WD 612.92		04.86-12.98 KOC	<b>0 460 426 099</b>

**TATA (TELCO)**

<b>407</b>						
<b>3.0 D</b>	3,0	48	497 SP		01.86-01.03	<b>0 460 424 235</b>
<b>613</b>						
<b>LPT 5.7 TCI</b>	5,7	96	697 TCIC <Euro 3>		01.08→	<b>0 460 426 990</b>

**VOLVO**

<b>FLC</b>						
	4,0	99	D4A135 <Euro 2>		09.96-09.00	<b>0 460 424 140</b>

**VOLZHANIN**

<b>Serie 32000</b>						
<b>32901</b>	5,7	96	697 TC65 <Euro 3>		01.10→	<b>0 460 426 990</b>

**VW (VOLKSWAGEN)**

<b>California T4</b>						
<b>1.9 D Turbo [70, 7D]</b>	1,9	50	ABL Fg.-Nr. 70..SH113 566→		05.95-06.03	<b>0 460 494 417 0 986 440 155</b> <b>0 986 440 257</b>
<b>2.4 D [70, 7D]</b>	2,4	55	AJA		05.97-06.03 AG	<b>0 460 485 036</b>
					GS, KL	<b>0 460 485 035 0 986 440 244</b>
					GS, KL	<b>0 460 485 037 0 986 440 253</b>
<b>D, D Syncro [70, 7D]</b>	2,4	57	AAB Fg.-Nr. 70..R..080 001→70..T..199 000 Fg.-Nr. 70..SH113 566→		09.90-09.98 AG, KL	<b>0 460 485 022</b>
					05.95-09.98 KL	<b>0 460 485 032</b>
<b>2.5 TDI [70, 7D]</b>	2,5	65/75	AJT; AUF		05.98-06.03	<b>0 460 415 983 0 986 440 562</b>
		75	ACV Fg.-Nr. 70..W..081 102→		11.97-06.03	<b>0 460 415 983 0 986 440 562</b>
		111	AHY		05.98-09.00	<b>0 460 415 985 0 986 440 571</b>
			AXG		09.00-06.03	<b>0 460 415 985 0 986 440 571</b>
<b>TDI Syncro [70, 7D]</b>	2,5	75	ACV		03.98-06.03	<b>0 460 415 983 0 986 440 562</b>
<b>TDI, TDI Syncro [70, 7D]</b>	2,5	65/75	AXL; AYC; AYY		04.01-06.03	<b>0 460 415 983 0 986 440 562</b>

<b>Caravelle T4</b>						
<b>1.9 D Turbo [70, 7D]</b>	1,9	50	ABL Fg.-Nr. 70..SH113 566→		05.95-06.03	<b>0 460 494 417 0 986 440 155</b> <b>0 986 440 257</b>
<b>2.4 D [70, 7D]</b>	2,4	55	AJA		05.97-06.03 AG	<b>0 460 485 036</b>
					GS, KL	<b>0 460 485 035 0 986 440 244</b>
					GS, KL	<b>0 460 485 037 0 986 440 253</b>
<b>D, D Syncro [70, 7D]</b>	2,4	57	AAB Fg.-Nr. 70..R..080 001→70..T..199 000 Fg.-Nr. 70..SH113 566→		09.90-09.98 AG, KL	<b>0 460 485 022</b>
					05.95-09.98 KL	<b>0 460 485 032</b>
<b>2.5 TDI [70, 7D]</b>	2,5	65/75	AJT; AUF		05.98-06.03	<b>0 460 415 983 0 986 440 562</b>
		75	ACV Fg.-Nr. 70..W..081 102→		11.97-06.03	<b>0 460 415 983 0 986 440 562</b>
		111	AHY		05.98-09.00	<b>0 460 415 985 0 986 440 571</b>
			AXG		09.00-06.03	<b>0 460 415 985 0 986 440 571</b>
<b>TDI Syncro [70, 7D]</b>	2,5	75	ACV		03.98-06.03	<b>0 460 415 983 0 986 440 562</b>
<b>TDI, TDI Syncro [70, 7D]</b>	2,5	65/75	AXL; AYC; AYY		04.01-06.03	<b>0 460 415 983 0 986 440 562</b>





◀ VW

LT											
28	2.5 SDI [2D, 2H]	2,5	55	AGX	Fg.-Nr. →2D..X..027 000	05.96-02.99		<b>0 460 415 987</b>	<b>0 986 440 569</b>		
					Fg.-Nr. 2D..X..027 001→	03.99-04.01		<b>0 460 415 983</b>	<b>0 986 440 562</b>		
	2.5 TDI [2D, 2H]	2,5	61/66/ 70/80	ANJ; APA; AVR; BBE; BBF		05.99-04.06		<b>0 460 415 983</b>	<b>0 986 440 562</b>		
					75	AHD	Fg.-Nr. 2D..W..021 001→	01.98-05.99		<b>0 460 415 983</b>	<b>0 986 440 562</b>
	2.8 D Turbo [2D, 2H]	2,8	92	AGK		07.97-12.98		<b>0 460 424 138</b>	<b>0 986 440 228</b>		
					96	ATA	01.99-01.02	WEG	<b>0 460 424 138</b>	<b>0 986 440 228</b>	
							WEG	<b>0 460 424 222</b>			
35											
	2.5 SDI [2D, 2H]	2,5	55	AGX	Fg.-Nr. →2D..X..027 000	05.96-02.99		<b>0 460 415 987</b>	<b>0 986 440 569</b>		
					Fg.-Nr. 2D..X..027 001→	03.99-04.01		<b>0 460 415 983</b>	<b>0 986 440 562</b>		
	2.5 TDI [2D, 2H]	2,5	61/66/ 70/80	ANJ; APA; AVR; BBE; BBF		05.99-04.06		<b>0 460 415 983</b>	<b>0 986 440 562</b>		
					75	AHD	Fg.-Nr. 2D..W..021 001→	01.98-05.99		<b>0 460 415 983</b>	<b>0 986 440 562</b>
	2.8 D Turbo [2D, 2H]	2,8	92	AGK		07.97-12.98		<b>0 460 424 138</b>	<b>0 986 440 228</b>		
					96	ATA	01.99-01.02	WEG	<b>0 460 424 138</b>	<b>0 986 440 228</b>	
							WEG	<b>0 460 424 222</b>			
46											
	2.5 SDI [2D, 2H]	2,5	55	AGX	Fg.-Nr. →2D..X..027 000	05.96-02.99		<b>0 460 415 987</b>	<b>0 986 440 569</b>		
					Fg.-Nr. 2D..X..027 001→	03.99-04.01		<b>0 460 415 983</b>	<b>0 986 440 562</b>		
	2.5 TDI [2D, 2H]	2,5	61/66/ 70/80	ANJ; APA; AVR; BBE; BBF		05.99-04.06		<b>0 460 415 983</b>	<b>0 986 440 562</b>		
					75	AHD	Fg.-Nr. 2D..W..021 001→	01.98-05.99		<b>0 460 415 983</b>	<b>0 986 440 562</b>
	2.8 D Turbo [2D, 2H]	2,8	92	AGK		07.97-12.98		<b>0 460 424 138</b>	<b>0 986 440 228</b>		
					96	ATA	01.99-01.02	WEG	<b>0 460 424 138</b>	<b>0 986 440 228</b>	
							WEG	<b>0 460 424 222</b>			
L80											
	[2V]	4,3	103	AGF		01.97-12.99		<b>0 460 424 115</b>			
Multivan T4											
1.9	D Turbo [70, 7D]	1,9	50	ABL	Fg.-Nr. 70..SH113 566→	05.95-06.03		<b>0 460 494 417</b>	<b>0 986 440 155</b>		
									<b>0 986 440 257</b>		
2.4	D [70, 7D]	2,4	55	AJA		05.97-06.03	AG	<b>0 460 485 036</b>			
							GS, KL	<b>0 460 485 035</b>	<b>0 986 440 244</b>		
							GS, KL	<b>0 460 485 037</b>	<b>0 986 440 253</b>		
	D, D Syncro [70, 7D]	2,4	57	AAB	Fg.-Nr. 70..R..080 001→70..T..199 000	09.90-09.98	AG, KL	<b>0 460 485 022</b>			
					Fg.-Nr. 70..SH113 566→	05.95-09.98	KL	<b>0 460 485 032</b>			
2.5	TDI [70, 7D]	2,5	65/75	AJT; AUF		05.98-06.03		<b>0 460 415 983</b>	<b>0 986 440 562</b>		
					75	ACV	Fg.-Nr. 70..W..081 102→	11.97-06.03		<b>0 460 415 983</b>	<b>0 986 440 562</b>
					111	AHY		05.98-09.00		<b>0 460 415 985</b>	<b>0 986 440 571</b>
				AXG		09.00-06.03		<b>0 460 415 985</b>	<b>0 986 440 571</b>		
	TDI Syncro [70, 7D]	2,5	75	ACV		03.98-06.03		<b>0 460 415 983</b>	<b>0 986 440 562</b>		
	TDI, TDI Syncro [70, 7D]	2,5	65/75	AXL; AYC; AYY		04.01-06.03		<b>0 460 415 983</b>	<b>0 986 440 562</b>		
Transporter T4											
1.9	D Turbo [70, 7D]	1,9	50	ABL	Fg.-Nr. 70..SH113 566→	05.95-06.03		<b>0 460 494 417</b>	<b>0 986 440 155</b>		
									<b>0 986 440 257</b>		
2.4	D [70, 7D]	2,4	55	AJA		05.97-06.03	AG	<b>0 460 485 036</b>			
							GS, KL	<b>0 460 485 035</b>	<b>0 986 440 244</b>		
							GS, KL	<b>0 460 485 037</b>	<b>0 986 440 253</b>		
	D, D Syncro [70, 7D]	2,4	57	AAB	Fg.-Nr. 70..R..080 001→70..T..199 000	09.90-09.98	AG, KL	<b>0 460 485 022</b>			
					Fg.-Nr. 70..SH113 566→	05.95-09.98	KL	<b>0 460 485 032</b>			
2.5	TDI [70, 7D]	2,5	65/75	AJT; AUF		05.98-06.03		<b>0 460 415 983</b>	<b>0 986 440 562</b>		
					75	ACV	Fg.-Nr. 70..W..081 102→	11.97-06.03		<b>0 460 415 983</b>	<b>0 986 440 562</b>





2.5 TDI [70, 7D]	2,5	111	AHY	05.98-09.00	0 460 415 985	0 986 440 571
			AXG	09.00-06.03	0 460 415 985	0 986 440 571
TDI Syncro [70, 7D]	2,5	75	ACV	03.98-06.03	0 460 415 983	0 986 440 562
TDI, TDI Syncro [70, 7D]	2,5	65/75	AXL; AYC; AYY	04.01-06.03	0 460 415 983	0 986 440 562
<b>14t</b>						
14 .150	6,5	105	6.10	11.95-02.00	0 460 426 250	
.170 BT	5,8	116	6 BTAA	04.97-02.00	0 460 426 251	





**CASE**

Serie 400						
420/420CT 3 3	3,2	55	F5CE9484 <Tier 3>		01.08-12.11	0 460 424 470
430/430CT 3	3,2	61	F5CE5454 <Tier 3>		01.08-03.11	0 460 424 471
435/435CT 3	3,2	61	F5CE5454 <Tier 3>		01.08-03.11	0 460 424 471
440/440CT 3	4,5	65	445T/M3		01.08→	0 460 414 265
445/445CT 3	3,2	67	F5CE5454 <Tier 3>		01.08-03.11	0 460 424 471
450/450CT Serie3	4,5	65	445T/M3		01.08→	0 460 414 265
SR						
220	3,2	61	F5CE5454 <Tier 3>		04.11-12.12	0 460 424 471
363	3,2	67	F5CE5454 <Tier 3>		04.11-12.13	0 460 424 491
SV						
250	3,2	61	F5CE5454 <Tier 3>		04.11-12.12	0 460 424 471
300	3,2	67	F5CE5454 <Tier 3>		04.11-12.13	0 460 424 491
TR						
320	3,2	67	F5CE5454 <Tier 3>		04.11-12.13	0 460 424 491
TV						
380	3,2	67	F5CE5454 <Tier 3>		04.11-12.13	0 460 424 491
WX						
95	4,5	74	F4GE9484 <Tier 3>		01.08-12.12	0 460 424 432

**CASE IH (CASE INTERNATIONAL)**

Farmall						
65 C	3,2	48	F5AE9454L <Tier 3>		09.11→	0 460 424 488
Maxxum						
110 12X12	4,5	66			01.07-12.13	0 460 424 398
Maxxum MXM						
175	7,5	130			09.02→	0 470 006 007 0 986 444 511
190	7,5	144			09.02→	0 470 006 007 0 986 444 511
Quantum						
65 V	3,2	48			01.12→	0 460 424 478
75 V/N/F	3,2	57			01.12→	0 460 424 479
95 C	4,5	71			01.07-12.14	0 460 424 418
V/N/F	4,4	71	NEF <Tier 3>		01.12→	0 460 424 418
Serie JX						
55	2,9	40	8035.06.260		09.01-12.04	0 460 423 011
55 JXM	2,9	40	8035.06.260		08.14→	0 460 423 072
60	3,2	44	NEF 3200 TCI		09.08-12.13 X96	0 460 423 011
65	2,9	46	8035.05 <Tier 2>			
			Fg.-Nr. 13287→		09.01-12.04	0 460 423 012
70	2,9	52	Fiat 8035.25.231		09.03-12.07	0 460 423 012
75	3,6	53-55	8045.06 <Tier 2>			
			Fg.-Nr. 13287→		09.01-06.06	0 460 424 300
75 T	3,9	55	8045.25 <Tier 2>		01.09-12.11	0 460 414 235
80	3,2	60	NEF 3200 TCI		09.08-12.13	0 460 424 300
	3,9	59	8045.05.205		09.03-12.07	0 460 424 300
85	3,9	59	8045.05.205			
			Fg.-Nr. →13286		09.01-12.04 TW	0 460 414 169
						0 460 414 176
			Fg.-Nr. 13287→		09.01-12.04 TW	0 460 424 299
90	3,9	66	8045.25.210		09.03-12.07	0 460 424 299
	4,5	65			01.07-12.13	0 460 424 299
		66	F4CE9484 <Tier 3>			
			Fg.-Nr. D6681→		01.07-12.13	0 460 424 430
			Fg.-Nr. →C6681		01.07-12.13	0 460 424 421
95	3,9	71	8045.25.210			
			Fg.-Nr. →13286		09.01-12.07	0 460 414 171
			Fg.-Nr. 13287→		09.01-12.07	0 460 424 280
	4,5	70			01.07-12.14	0 460 424 280





95	4,5	70	F4CE9484 <Tier 3>	01.07-12.14	0 460 424 421
1060 V	2,9	40	8035.05 <Tier 2>	05.04-12.08	0 460 423 007
<b>Serie JXC</b>					
1060	2,9	40	8035.05 <Tier 2>	12.03-06.08	0 460 423 007
1085	4,5	60	445M2	01.05-12.08	0 460 424 349
1095	4,5	66		10.05-12.05	0 460 424 306
<b>Serie JXU</b>					
80	3,9	55	8045.05.205	05.02-12.05	0 460 414 169
85	4,5	63		01.08-12.14	0 460 424 422
95	4,5	71		01.08-12.14	0 460 424 418
100	3,9	70	8045.25.210	05.02-12.05	0 460 414 171
105	4,5	78		01.08-12.14	0 460 424 428
115	4,5	83		01.08-12.14	0 460 424 428

**FENDT**

<b>Serie C</b>					
5270	7,4	199	74 ETA	09.03-12.07	0 470 506 042
6300	8,4	221	84 ETA	09.03-12.07	0 470 506 042

**GAZ**

<b>Tiger</b>					
5.9 TD [2330]	5,9	132	B 180-20	05.06→	0 460 426 249

**MASSEY FERGUSON (MF)**

<b>Beta</b>					
7260/AL	7,4	202	74 ETA	01.04-12.07	0 470 506 042
7270/AL	8,4	247	84 ETA	01.04-12.07	0 470 506 042
<b>6400-Serie</b>					
6499	7,4	158	74 ETA	01.03-12.06	0 470 506 042
<b>8400-Serie</b>					
8450	7,4	158	74 ETA	01.04-12.05	0 470 506 042
8460	7,4	173	74 ETA	01.04-12.06	0 470 506 042
8470	8,4	191	84 ETA	01.04-12.06	0 470 506 042
8480	8,4	213	84 ETA	01.04-12.06	0 470 506 042

**NEW HOLLAND**

<b>LM</b>					
415 A	4,5	71	F4CE0454 <NEF 45>	11.03-12.07	0 460 424 282
		82	F4CE0454 <NEF 45>	11.03-12.07	0 460 424 274
435 A	4,5	71	F4CE0454 <NEF 45>	11.03-12.07	0 460 424 282
		82	F4CE0454 <NEF 45>	11.03-12.07	0 460 424 274
445 A	4,5	71	F4CE0454 <NEF 45>	11.03-12.07	0 460 424 282
		82	F4CE0454 <NEF 45>	11.03-12.07	0 460 424 274
5040	4,5	88	F4BE0484F <Tier 2>	06.07-12.13	0 460 424 425
5060	4,5	88	F4BE0484F <Tier 2>	06.07-12.13	0 460 424 425
5080	4,5	88	F4BE0484F <Tier 2>	06.07-12.13	0 460 424 425
<b>Serie LB</b>					
90 .B	4,5	71-74	F4GE0454C <Tier 2>	04.03-12.06	0 460 424 282
95 .B	4,5	71-74	F4GE0454C <Tier 2>	04.03-12.06	0 460 424 282
<b>Serie TM</b>					
115	7,5	88		11.99-06.02	0 460 426 314
120	7,5	82/91	Genesis	01.02-12.07	0 460 426 345
125	7,5	93	Genesis	09.00-12.07	0 460 426 312
130	7,5	86	Genesis	01.02-12.07	0 460 426 344
135	7,5	101	Genesis	09.00-12.07	0 460 426 312







◀ NEW HOLLAND

140	7,5	106	Genesis	12.02-12.07		0 460 426 343
150	7,5	110	GSD675T	11.99-01.08		0 460 426 303
		115	Genesis	01.02-12.07		0 460 426 340
165	7,5	119	GSD675T	11.99-01.08		0 460 426 313
175	7,5	130	Genesis	06.02-12.07		0 470 006 007 0 986 444 511
180	7,5	130	Genesis	07.04-01.08		0 460 426 405
190	7,5	142	Genesis	06.02-12.07		0 470 006 007 0 986 444 511
<b>Serie 60</b>						
M 115	7,5	85	TD456			
			Fg.-Nr. D3672→	09.95-12.99		0 460 426 262
M 135	7,5	99	WL456			
			Fg.-Nr. D3672→	09.95-12.99		0 460 426 266
M 160	7,5	118	WM456			
			Fg.-Nr. D3672→	09.95-12.99		0 460 426 265
8260	7,5	85	TD456			
			Fg.-Nr. D3672→	02.96-01.00		0 460 426 262
8360	7,5	100	WL456			
			Fg.-Nr. D3672→	02.96-01.00		0 460 426 266
8560	7,5	118	WM456			
			Fg.-Nr. D3672→	02.96-01.00		0 460 426 265
<b>Serie 90</b>						
110-90	5,9	82	8065.05.210			
			Fg.-Nr. →776978	01.84-12.04	BO	0 460 416 036
			Fg.-Nr. 776979→	01.84-12.04		0 460 416 083
<b>T</b>						
4020 Deluxe	3,2	48		04.08-12.14	TW	0 460 424 478
						0 460 424 479
V	3,2	48		10.08→		0 460 424 478
4030 Deluxe, F, N, V	3,2	57		04.08→		0 460 424 479
4040 Deluxe	4,5	63	F4CE0454 <NEF 45>	12.07-12.14		0 460 424 422
	F, N, V	3,2	65		06.08→	0 460 424 480
4050 Deluxe, F, N, V	4,5	71	F4CE0454 <NEF 45>	12.07→		0 460 424 418
4060 F, N, V	4,5	78	F4CE9484L	02.12→		0 460 424 428
5040	4,5	63	F4CE0454 <NEF 45>	01.07-12.14		0 460 424 422
5050	4,5	71	F4CE0454 <NEF 45>	01.07-12.14		0 460 424 418
5060	4,5	78	F4CE0454 <NEF 45>	01.07-12.14	TW	0 460 424 428
						0 460 424 441
5070	4,5	83	F4CE0454 <NEF 45>	01.08-12.14	TW	0 460 424 428
						0 460 424 441
<b>TD</b>						
60	2,9	44		01.06→	TIE	0 460 413 025
			Mot.-Nr. 5096705	01.06→	X96	0 460 423 029
			Mot.-Nr. 47125223 Mot.-Nr. 47125224	01.06→	X96	0 460 423 011
80	3,9	59	8045.06.260			
			Mot.-Nr. 5096707	01.06→		0 460 424 372
			Mot.-Nr. 47484048			
			Mot.-Nr. 47682823			
			Mot.-Nr. 47125297	01.06→		0 460 424 300
			Mot.-Nr. 87521995			
90	2,9	66		01.06→	X96	0 460 424 373
	3,9	66	84527375	01.06→		0 460 424 299
95	2,9	72		01.06→		0 460 424 370
	3,9	72	84527375	01.06→		0 460 424 280
<b>TDD</b>						
TD75D	3,6	54	8045.06 <Tier 2>	01.06-12.09		0 460 424 300
<b>TD3</b>						
.50	2,9	36	47636590	02.15→		0 460 423 056
<b>TD5</b>						
5040	4,5	65,6	F4CE0454 <NEF 45>			
			Fg.-Nr. D6681→	12.07-12.14		0 460 424 430
			Fg.-Nr. →C6681	12.07-12.14		0 460 424 421
.100	3,9	73	845273...	11.12→		0 460 424 500





.105	4,5	78	F4CE9484L	12.12-12.15	TW	0 460 424 428
						0 460 424 441
.110	3,9	81	8453464...	11.12→		0 460 424 519
.115	4,5	83	F4CE9484C	12.12-12.15	TW	0 460 424 428
						0 460 424 441
.65	2,9	48	8452738...	11.12→		0 460 423 057
.75	2,9	53	84560055	12.12-12.15		0 460 423 058
	3,9	56	8452737...	11.12→		0 460 424 502
.80	2,9	60	84527383	11.12→		0 460 423 054
.85	3,2	60	F5AE9484L	12.12-12.15		0 460 424 483
.90	3,9	66	8452737...	11.12→		0 460 424 501
.95	4,5	70	F4CE9487N	12.12-12.15	TW	0 460 424 421
						0 460 424 430
<b>TD4000F</b>						
4.70	3,2	48	F5AE9484A	07.15→		0 460 424 478
4.80	3,2	57	F5AE9484B	07.15→		0 460 424 479
4.90	3,2	65	F5AE9484G	07.15→		0 460 424 480
4020	3,2	48	F5AE9484A	09.09-12.15		0 460 424 478
4030	3,2	57	F5AE9484B	09.09-12.15		0 460 424 479
4040	3,2	65	F5AE9484G	09.09-08.13		0 460 424 492
				09.13-12.15		0 460 424 480
<b>TK</b>						
80 A, MA	3,9	57	8045.25 <Tier 2>	02.04-12.09		0 460 424 300
4020	3,2	48		03.09→		0 460 424 478
4030	3,2	57		03.09→		0 460 424 479
4040	3,2	65		03.09→		0 460 424 480
4050	4,5	70		03.09→		0 460 424 421
4060	4,5	74		03.09→		0 460 424 432
<b>TL</b>						
70 A	4,5	53	4B	01.04-12.07		0 460 424 333
80	4,5	60	4B			
			Mot.-Nr. →776978	10.98-01.04		0 460 414 115
			Mot.-Nr. 776979→	10.98-01.04		0 460 414 170
A	4,5	60	4B	01.04-12.08		0 460 424 329
90	4,5	67	4B			
			Mot.-Nr. →776978	10.98-01.04	KOC	0 460 414 114
			Mot.-Nr. 776979→	10.98-01.04		0 460 414 179
A	4,5	67		01.04-12.07		0 460 424 334
100	4,5	74	4B			
			Mot.-Nr. →776978	10.98-01.04		0 460 414 137
			Mot.-Nr. 776979→	10.98-01.04		0 460 414 171
A	4,5	73		01.04-12.08		0 460 424 321
<b>TN</b>						
60 A, DA, SA, VA	2,9	44	8035.05 <Tier 2>	12.03-12.08		0 460 423 007
65	2,9	44	8035.05	09.99-12.03	KOC	0 460 414 147
70 A, SA	2,9	53	8035.05 <Tier 2>	12.03-12.08		0 460 423 008
75 A, SA	2,9	55	8035.05 <Tier 2>	12.03-12.08		0 460 423 006
FA	3,9	55	8045.25 <Tier 2>	12.03-12.08		0 460 424 296
85 A, DA, SA	4,5	62,6	4B	01.04-12.08		0 460 424 349
FA	3,9	62,6	8045.25 <Tier 2>	12.03-12.08		0 460 424 298
90 F	3,9	66	8045.25 <Tier 2>	09.97-10.01		0 460 414 148
95 DA	4,5	66		10.05-12.07		0 460 424 306
F	3,9	68	8045.25 <Tier 2>	10.01-01.04		0 460 414 148
VA	4,5	66		12.04-12.08		0 460 424 297
<b>TS</b>						
100A 12x12	4,5	75	F4CE9484C	10.03-12.07		0 460 424 268
115A 12x12	6,7	86		07.03-12.07		0 460 426 357
<b>TT</b>						
55 ,4WD	2,9	39/41	8035.05	01.03-12.08		0 460 414 235
<b>T3</b>						
.50F	2,9	37	47375489	01.14-12.15		0 460 423 056
.55F	2,9	40,4	47375488	01.14-12.15		0 460 423 055
.65F	2,9	48	47375487	01.14-12.15		0 460 423 057





◀ NEW HOLLAND

<b>.75F</b>	2,9	55	47375485		01.14-12.15	<b>0 460 423 058</b>
<b>T4</b>						
<b>.105 F</b>	4,5	78	F4CE9484L		07.13→	<b>0 460 424 428</b>
<b>.105 LP</b>	4,5	78	F4CE9484L		01.15→	<b>0 460 424 428</b>
<b>.105 N</b>	4,5	78	F4CE9484L		07.13→	<b>0 460 424 428</b>
<b>.105 V</b>	4,5	78	F4CE9484L		07.13→	<b>0 460 424 428</b>
<b>.65 V</b>	3,2	48			07.13→	<b>0 460 424 478</b>
<b>.75 F</b>	3,2	57	F5AE9484G		07.13→	<b>0 460 424 479</b>
<b>.75 LP</b>	3,2	57	F5AE9484G		01.15→	<b>0 460 424 479</b>
<b>.75 N</b>	3,2	57	F5AE9484G		07.13→	<b>0 460 424 479</b>
<b>.75 V</b>	3,2	57	F5AE9484G		07.13→	<b>0 460 424 479</b>
<b>.85</b>	3,2	65	F5AE9484G		01.15→	<b>0 460 424 480</b>
<b>.85 F</b>	3,2	65			07.13→	<b>0 460 424 480</b>
<b>.85 N</b>	3,2	65			07.13→	<b>0 460 424 480</b>
<b>.85 V</b>	3,2	65			07.13→	<b>0 460 424 480</b>
<b>.95</b>	4,5	71	F4CE0454 <NEF 45>		07.13→	<b>0 460 424 418</b>
<b>.95 F</b>	4,5	71	F4CE0454 <NEF 45>		07.13→	<b>0 460 424 418</b>
<b>.95 LP</b>	4,5	71	F4CE9484L		01.15→	<b>0 460 424 418</b>
<b>.95 V</b>	4,5	71	F4CE0454 <NEF 45>		07.13→	<b>0 460 424 418</b>
<b>T6000</b>						
<b>6020 12x12</b>	4,5	82	N45MNT		01.07→	<b>0 460 424 398</b>
<b>6030 16x16</b>	6,7	86	N67MNT		01.07-09.13	<b>0 460 426 455</b>
<b>6050 12x12</b>	6,7	93	N67MNT		01.07→	<b>0 460 426 453</b>
<b>6070 24x24</b>	6,7	104	N67MNT		01.07→	<b>0 460 426 459</b>
<b>Workmaster</b>						
<b>65</b>	3,2	49			11.10-12.15	<b>0 460 424 491</b>
<b>75</b>	3,2	56			06.10-03.18	<b>0 460 424 479</b>

**STEYR (STEYR-DAIMLER-PUCH AG)**

**Serie 8000**

<b>8055 , a</b>	2,6	35	WD 311.46; WD 311.47	D,F	09.86-09.01 KOC	<b>0 460 413 006</b>
<b>8065 , a</b>	2,6	41	WD 311.85		09.86-09.01 KOC	<b>0 460 413 007</b>
<b>8070 , a</b>	3,5	47	WD 411.43, 44	D,F	10.84-10.99	<b>0 460 414 014</b>
<b>8075 , a</b>	3,5	47	WD 411.45, 46	D,F	01.84-01.99	<b>0 460 414 014</b>
<b>8080 , a</b>	3,5	53	WD 411.89, 90	D,F	06.84-06.99 KOC	<b>0 460 414 011</b>
<b>8130 , a</b>	5,2	81	WD 611.87, 88		10.84-07.99 KOC	<b>0 460 416 032</b>





**IVECO**

**8100**

<b>8140</b> .21.290 [Sofim]	2,4	68	8140.21.290	06.88-12.00	KOC	<b>0 460 414 060</b>
-----------------------------	-----	----	-------------	-------------	-----	----------------------

**MAN**

**Serie D 0200**

<b>0226</b> MCE 51	5,7		D 0226 MCE 51 <Schlüter>	06.86-12.00	KOC	<b>0 460 426 098</b>
ME 74	5,7	74	D 0226 ME 74 <Schlüter>	02.85-12.00	KOC	<b>0 460 416 037</b>





**ALFA ROMEO**

<b>Brera</b>						
2.0 JTDM [939]	2,0	120/125	844 A2.000; 939 B3.000 <M120>	02.09-12.10		<b>0 281 002 917</b>
2.4 JTDM 20V [939]	2,4	147/154	939 A3.000 <M95>; 939 A9.000	04.06-12.10		<b>0 281 006 048</b>
<b>Giulietta</b>						
1.6 JTDM [940]	1,6	77	940 A3.000	05.10→	SSJ	<b>0 281 002 917</b>
					SSJ	<b>0 281 006 054</b>
		85/88	940 C1.000; 940 C5.000	04.15→		<b>0 281 006 054</b>
2.0 JTDM [940]	2,0	100/103/120/125	940...; 940 A4.000; 940 A5.000; 940 A7.000	04.10→	SSJ	<b>0 281 002 917</b>
					SSJ	<b>0 281 006 054</b>
		110/120/129	940 B4.000; 940 B5.000; 940 B9.000; 940 C3.000; 940 C4.000	08.13→		<b>0 281 006 054</b>
<b>GT</b>						
1.9 JTD 16V [937]	1,9	110	937 A5.000 <M15>	10.03-12.10		<b>0 280 218 120</b>
			937 A5.000 <M92>	01.04-06.07		<b>0 281 002 792</b>
				07.07-12.10		<b>0 281 002 980</b>
		125	937 A.6000 <M94>	10.07-12.10		<b>0 281 002 980</b>
<b>MiTo</b>						
1.3 JTD [955]	1,2	62	199 B4.000	03.11→	SSJ	<b>0 281 002 917</b>
					SSJ	<b>0 281 006 054</b>
		1,3	199 A3.000 <M72 (ECOCF4)>; 199 B1.000 <M95>	10.08→	EU4	<b>0 281 002 792</b>
					EU5	<b>0 281 006 054</b>
JTDM, SDE [955]	1,3	59/70	199 B8.000; 330 A1.000	12.13→		<b>0 281 006 054</b>
1.6 JTD [955]	1,6	85/88	955 A3.000 <M88>; 955 A4.000 <M87>	08.08→	SSJ	<b>0 281 002 917</b>
					SSJ	<b>0 281 006 054</b>
<b>Spider</b>						
2.0 JTDM [939]	2,0	120/125	844 A2.000; 939 B3.000 <M120>	04.09-12.10		<b>0 281 002 917</b>
2.4 JTDM 20V [939]	2,4	147/154	939 A3.000 <M95>; 939 A9.000	03.07-12.10		<b>0 281 006 048</b>
<b>145</b>						
1.9 JTD [930 MY97]	1,9	76	AR 32302 <M20>	05.98-02.99		<b>0 280 218 019</b>
JTD [930 MY99]	1,9	76	AR 32302 <M20>	02.99-12.00		<b>0 280 218 019</b>
<b>146</b>						
1.9 JTD [930 MY97]	1,9	77	AR 32302 <M13>	05.98-02.99		<b>0 280 218 019</b>
JTD [930 MY99]	1,9	77	AR 32302 <W4 M20>	02.99-12.00		<b>0 280 218 019</b>
<b>147</b>						
1.9 JTD [937]	1,9	74	182B9000 <M14>	06.03-10.06	TW	<b>0 281 002 308</b>
				09.03-10.06	TW	<b>0 280 218 120</b>
		81-85	937 A.2000 <M15>	11.00-03.05	TW	<b>0 281 002 308</b>
				09.03-03.05	TW	<b>0 280 218 120</b>
JTDM [937]	1,9	85	939 A7.000 <M87>	01.06-06.07		<b>0 281 002 792</b>
				07.07-12.10		<b>0 281 002 980</b>
		88	937 A.3000 <M88>	04.05-06.07		<b>0 281 002 792</b>
				07.07-12.10		<b>0 281 002 980</b>
JTDM 16V [937]	1,9	93	937 A.4000 <M16>	06.03-09.06		<b>0 280 218 120</b>
		100	192B1000 <M18>	02.04-12.05		<b>0 280 218 120</b>
			192B1000 <M91>	01.06-06.07		<b>0 281 002 792</b>
				07.07-12.10		<b>0 281 002 980</b>
		103	192A5000 <M17>	10.02-09.03		<b>0 280 218 120</b>
		110	937 A5.000 <M19>	10.04-02.06		<b>0 280 218 120</b>
			937 A5.000 <M92>	03.06-06.07		<b>0 281 002 792</b>
				07.07-12.10		<b>0 281 002 980</b>
		125	937 A.6000 <M94>	10.07-12.10		<b>0 281 002 980</b>
<b>156 Berlina</b>						
1.9 JTD [932]	1,9	74	182 B9.000 <M24>	06.03-12.04		<b>0 281 002 309</b>
		76	AR32302 <M1>	10.97-09.00		<b>0 280 218 019</b>
		81-85	AR37101 / 937A2.000 <M3/M5>	09.00-12.01		<b>0 281 002 309</b>
		85	937 A2.000 <M25>	01.02-10.05		<b>0 281 002 309</b>
JTD 16V [932]	1,9	93	937 A4.000 <M26>	06.03-10.05		<b>0 280 218 113</b>
		100/103	192 A5.000 <M27>; 192 B1.000 <M29>	10.02-10.05		<b>0 280 218 113</b>
		110	937 A5.000 <M82>	07.04-12.05		<b>0 281 002 683</b>
2.4 JTD [932]	2,4	100	AR32501 <M2>	10.97-09.00		<b>0 280 218 019</b>





2.4 JTD [932]	2,4	100/110	839 A6.000 <M4>; 841 C.000 <M30>	09.00-10.05	<b>0 281 002 309</b>
JTD, JTD 20V [932]	2,4	120/129	841 G.000 <M31>; 841 M.000 <M33>	06.03-10.05	<b>0 281 002 598</b>
<b>156 Sportwagon</b>					
1.9 JTD [932]	1,9	74	182 B9.000 <M24>	06.03-12.04	<b>0 281 002 309</b>
		76	AR32302 CF2 <M1>	06.00-09.00	<b>0 280 218 019</b>
		80-85	AR37101 / 937A2.000 <M3/M5 CF3>	09.00-12.01	<b>0 281 002 309</b>
		85	937 A2.000 <M25>	01.02-12.05	<b>0 281 002 309</b>
JTD 16V [932]	1,9	93	937 A4.000 <M26/M90>	06.03-10.05	<b>0 280 218 113</b>
		93/110	937 A4.000 <M90>; 937 A5.000 <M82>	10.03-12.05	<b>0 281 002 683</b>
		100/103	192 A5.000 <M27>; 192 B1.000 <M29>	10.02-12.05	<b>0 280 218 113</b>
2.4 JTD [932]	2,4	100	AR32501 CF2 <M2>	06.00-09.00	<b>0 280 218 019</b>
		100/110	839 A6.000 <M4, CF3>; 841 C.000 <M30>	09.00-10.05	<b>0 281 002 309</b>
JTD, JTD 20V [932]	2,4	120/129	841 G.000 <M31>; 841 M.000 <M33>	06.03-12.05	<b>0 281 002 598</b>
<b>156 Sportwagon Q4</b>					
1.9 JTD 16V 4x4 [932]	1,9	110	937 A5.000 <M28/M92>	10.04-05.05 EU3	<b>0 280 218 113</b>
				10.04-12.05 EU4	<b>0 281 002 683</b>
<b>159 Berlina</b>					
1.9 JTDM 8V, JTDM 16V [939]	1,9	85/88/ 100/110	937 A8.000 <M91>; 939 A1.000 <M88>; 939 A2.000 <M92>; 939 A7.000 <M87>	06.05-12.08	<b>0 281 002 861</b>
2.0 JTDM, JTDM 16V [939]	2,0	100/120/ 125	844 A2.000; 939 B3.000 <M120>; 939 B4.000	05.09-12.11	<b>0 281 002 917</b>
2.4 JTD 20V, JTDM 20V [939]	2,4	147/154	939 A3.000 <M95>; 939 A9.000	06.05-12.08	<b>0 281 006 048</b>
<b>159 Berlina Q4</b>					
2.4 JTD 20V [939]	2,4	154	939 A9.000	09.06-12.08	<b>0 281 006 048</b>
<b>159 Sportwagon</b>					
1.9 JTDM 8V, JTDM 16V [939]	1,9	85/88/ 100/110	937 A8.000 <M91>; 939 A1.000 <M88>; 939 A2.000 <M92>; 939 A7.000 <M87>	03.06-12.08	<b>0 281 002 861</b>
2.0 JTDM, JTDM 16V [939]	2,0	100/120/ 125	844 A2.000; 939 B3.000 <M120>; 939 B4.000	05.09-12.11	<b>0 281 002 917</b>
2.4 JTD 20V, JTDM 20V [939]	2,4	147/154	939 A3.000 <M95>; 939 A9.000	03.06-12.08	<b>0 281 006 048</b>
<b>159 Sportwagon Q4</b>					
2.4 JTD 20V [939]	2,4	154	939 A9.000	09.06-12.08	<b>0 281 006 048</b>
<b>164</b>					
2.5 D Turbo [164]	2,5	92	VM08B / VM32B <M8/M9>	09.92-10.98	<b>0 281 002 085</b>
<b>166</b>					
2.4 JTD [936]	2,4	100	AR 34202 <M20>	10.98-09.00	<b>0 280 218 019</b>
		100-110	839 A6.000/841 C.000 <M21/M22>	09.00-10.07	<b>0 281 002 309</b>
JTD 20V [936]	2,4	120/128/ 129	841 G.000/841 H.000 <M25/M26>; 841 M.000 <M27>; 841 N.000 <M28>	06.03-10.07	<b>0 281 002 598</b>
JTDM 20V [936]	2,4	132-136	936 B.000 <M99>	10.05-10.07	<b>0 281 006 048</b>

## AUDI

<b>A1</b>					
2.0 TDI [8X]	2,0	100/105	CFHB <D94>; CFHD <D92>	09.11-04.15	<b>0 281 002 956</b>
<b>A1 Sportback</b>					
2.0 TDI [8X]	2,0	100/105	CFHB <D94>; CFHD <D92>	09.11-04.15	<b>0 281 002 956</b>
<b>A2</b>					
1.4 TDI [820]	1,4	55/66	ATL; BHC	05.03-08.05	<b>0 281 002 610</b>
<b>A3</b>					
1.9 TDI [8L1]	1,9	66/81	AGR; AHF	08.98-08.00	<b>0 281 002 757</b>
			Fg.-Nr. 8L..X..000 001→	WW,XXX	<b>0 986 280 202</b>
			ALH; ASV	08.97-06.01	<b>0 281 002 757</b>
				WW,XXX	<b>0 986 280 202</b>
		74	ATD	09.00-10.01	<b>0 281 002 757</b>
			Fg.-Nr. →8L..2..040 000	WW,XXX	<b>0 986 280 202</b>
			Fg.-Nr. 8L..2..040 001→	10.01-06.03	<b>0 281 002 531 0 986 284 009</b>
			AXR	11.01-06.03	<b>0 281 002 531 0 986 284 009</b>
TDI [8P1]	1,9	77	BKC; BLS <D3W>; BXE <D3W>	06.03-05.10	<b>0 281 002 531 0 986 284 009</b>















◀ AUDI

1.9 TDI, TDI quattro [8L1]	1,9	96	ASZ	Fg.-Nr. →8L..2..105 000	05.00-04.02	0 280 217 529	0 986 280 204
				Fg.-Nr. 8L..2..105 001→	04.02-06.03	0 281 002 461	0 986 284 007
2.0 quattro, TDI, TDI quattro [8V1]	2,0	81/100/105/110/135	CRBC <DN4>; CRBD <DE9>; CRFA <DN1>; CRFC <DN6>; CRLB <DN4>; CRLC <DE9>; CRUA <DN4>; CUNA <DK7>; DBGA <T37>; DEJA <DN4>		04.12→	0 281 002 956	
TDI, TDI quattro [8P1]	2,0	100/103/120/125	AZV; BKD; BMM; BMN; BUY		05.03-06.08	0 281 002 461	0 986 284 007
		100/103/125	CBAA <D94>; CBAB <D91>; CBBB <D93>		07.08-05.10	0 281 002 735	
			CFFA <D94>; CFFB <D91>; CFGB <D93>; CLJA <D91>		11.09-03.13	0 281 002 956	
TDI, TDI quattro [8VS]	2,0	81/100/105/110/135	CRBC <DN4>; CRBD <DE9>; CRFA <DN1>; CRFC <DN6>; CRLB <DN4>; CRLC <DE9>; CRUA <DN4>; CUNA <DK7>; DBGA <T37>; DEJA <DN4>		05.13→	0 281 002 956	
<b>A3 Cabriolet</b>							
1.9 TDI [8P7]	1,9	77	BLS <D3W>		04.08-05.09	0 281 002 531	0 986 284 009
2.0 TDI [8P7]	2,0	100/103	CBAA <D94>; CBAB <D91>		04.08-05.10	0 281 002 735	
			CFFA <D94>; CFFB <D91>		11.09-05.13	0 281 002 956	
TDI, TDI quattro [8V7]	2,0	100/110/135	CRLB <DN4>; CRLC <DE9>; CUNA <DK7>		10.13→	0 281 002 956	
<b>A3 Sportback</b>							
1.9 TDI [8PA]	1,9	77	BKC; BLS <D3W>; BXE <D3W>		09.04-05.10	0 281 002 531	0 986 284 009
2.0 TDI, TDI quattro [8PA]	2,0	100/103/120/125	AZV; BKD; BMM; BMN; BUY		09.04-06.08	0 281 002 461	0 986 284 007
		100/103/125	CBAA <D94>; CBAB <D91>; CBBB <D93>		07.08-05.10	0 281 002 735	
			CFFA <D94>; CFFB <D91>; CFGB <D93>; CLJA <D91>		11.09-03.13	0 281 002 956	
TDI, TDI quattro [8VA]	2,0	81/100/105/110/135	CRBC <DN4>; CRBD <DE9>; CRFA <DN1>; CRFC <DN6>; CRLB <DN4>; CRLC <DE9>; CRUA <DN4>; CUNA <DK7>; DBGA <T37>; DEJA <DN4>		09.12→	0 281 002 956	
<b>A4</b>							
1.9 TDI [8EC; B7]	1,9	84	BKE		11.04-11.05	0 281 002 461	0 986 284 007
		85	BRB		01.06-06.08	0 281 002 461	0 986 284 007
TDI [8E2; B6]	1,9	74	AVB	Fg.-Nr. →8E..2..120 000	04.01-09.01	0 281 002 757	
					WW,XXX		0 986 280 202
				Fg.-Nr. 8E..2..120 001→	09.01-05.04	0 281 002 531	0 986 284 009
		85	BKE		06.04-12.04	0 281 002 461	0 986 284 007
		96	AWX	Fg.-Nr. →8E..1..080 000	12.00-04.01	0 280 217 529	0 986 280 204
				Fg.-Nr. 8E..2..000 001→	04.01-06.03	0 281 002 461	0 986 284 007
TDI, TDI quattro [8D2; B5]	1,9	55/66/81/85	AFF; AFN; AHU; AJM; ATJ; AVG		08.97-11.00	0 281 002 216	0 986 284 001
TDI, TDI quattro [8E2; B6]	1,9	96	AVF		04.01-12.04	0 281 002 461	0 986 284 007
2.0 TDI [8K2; B8]	2,0	105	CMEA <D92>		05.10-03.12	0 281 002 735	
TDI, TDI quattro [8EC; B7]	2,0	89/93/100/103/120/125	BLB; BNA; BPW; BRD; BRE; BRF; BVA; BVF; BVG		11.04-06.08	0 281 002 461	0 986 284 007
TDI, TDI quattro [8K2; B8]	2,0	88/100/105/110/120/130	CGLC <DE2>; CGLD <D95>; CJCA <D92>; CJCB <D94>; CJCC <D90>; CJCD <DN4>		11.10-12.15	0 281 002 956	
		88/100/105/120/125	CAGA <D92>; CAGB <D94>; CAGC <D90>; CAHA <D93>; CAHB <D95>		11.07-03.12	0 281 002 735	
		100/105/110/120/140	CMFA <D92>; CMFB <DN4>; CNHA <DE5>; CNHC <D95>; CSUA <DN4>; CSUB <D94>		11.11-12.15	0 281 002 956	
TDI, TDI quattro [8W2; B9]	2,0	100/110/140	CZHA <DN4>; DESA <DE5>; DETA <DE5>; DEUA <DN4>; DEUB <D94>		05.15→	0 281 002 956	
2.5 TDI, TDI quattro [8D2; B5]	2,5	110	AFB		08.97-06.00	0 281 002 429	0 986 284 005



								
2.5 TDI, TDI quattro [8D2; B5]	2,5	110	AKN					
					Fg.-Nr. →8D..X..400 000	07.98-06.99	<b>0 281 002 429</b>	<b>0 986 284 005</b>
					Fg.-Nr. 8D..Y..000 001→	07.99-10.00	<b>0 281 002 403</b>	<b>0 986 284 004</b>
<b>A4 Allroad</b>								
2.0 TDI [8KH]	2,0	100/105/110/120/130/140	CGLC <D92>; CGLD <D95>; CJCA <D92>; CJCB <D94>; CJCD <DN4>; CNHA <DE5>; CNHC <D95>; CSUA <DN4>; CSUB <D94>			11.11-04.16	<b>0 281 002 956</b>	
		100/105/120/125	CAGA <D92>; CAGB <D94>; CAHA <D93>; CAHB <D95>			04.09-01.12	<b>0 281 002 735</b>	
TDI [8WH]	2,0	140	DESA <DE5>; DETA <DE5>			01.16→	<b>0 281 002 956</b>	
<b>A4 Avant</b>								
1.9 TDI [8D5; B5]	1,9	66	AHH			04.97-09.01	<b>0 281 002 216</b>	<b>0 986 284 001</b>
TDI [8ED; B7]	1,9	85	BKE; BRB			11.04-06.08	<b>0 281 002 461</b>	<b>0 986 284 007</b>
TDI [8E5; B6]	1,9	74	AVB			09.01-05.04	<b>0 281 002 531</b>	<b>0 986 284 009</b>
TDI, TDI quattro [8D5; B5]	1,9	66/81/85/81	AHU; AJM; ATJ; AVG; AFN			08.97-09.01 08.97-07.99	<b>0 281 002 216</b> <b>0 281 002 216</b>	<b>0 986 284 001</b> <b>0 986 284 001</b>
TDI, TDI quattro [8E5; B6]	1,9	85/96	AVF; AWX; BKE			09.01-12.04	<b>0 281 002 461</b>	<b>0 986 284 007</b>
2.0 TDI [8K5; B8]	2,0	105	CMEA <D92>			05.10-03.12	<b>0 281 002 735</b>	
TDI, TDI quattro [8ED; B7]	2,0	89/93/100/103/120/125	BLB; BNA; BPW; BRD; BRE; BRF; BVA; BVF; BVG			11.04-06.08	<b>0 281 002 461</b>	<b>0 986 284 007</b>
TDI, TDI quattro [8K5; B8]	2,0	88/100/105/110/120/130	CGLC <DE2>; CGLD <D95>; CJCA <D92>; CJCB <D94>; CJCC <D90>; CJCD <DN4>			11.10-12.15	<b>0 281 002 956</b>	
		88/100/105/120/125	CAGA <D92>; CAGB <D94>; CAGC <D90>; CAHA <D93>; CAHB <D95>			04.08-03.12	<b>0 281 002 735</b>	
		100/105/110/120/140	CMFA <D92>; CMFB <DN4>; CNHA <DE5>; CNHC <D95>; CSUA <DN4>; CSUB <D94>			11.11-12.15	<b>0 281 002 956</b>	
TDI, TDI quattro [8W5; B9]	2,0	100/110/140	CZHA <DN4>; DESA <DE5>; DETA <DE5>; DEUA <DN4>; DEUB <D94>			05.15→	<b>0 281 002 956</b>	
2.5 TDI, TDI quattro [8D5; B5]	2,5	110	AFB AKN			11.97-06.00	<b>0 281 002 429</b>	<b>0 986 284 005</b>
					Fg.-Nr. →8D..X..400 000	07.98-06.99	<b>0 281 002 429</b>	<b>0 986 284 005</b>
					Fg.-Nr. 8D..Y..000 001→	07.99-09.01	<b>0 281 002 403</b>	<b>0 986 284 004</b>
<b>A4 Cabriolet</b>								
2.0 TDI [8HE; B7]	2,0	100/103	BPW; BRC			01.06-03.09	<b>0 281 002 461</b>	<b>0 986 284 007</b>
<b>A4 Sportback</b>								
2.0 TDI quattro [8TA]	2,0	130	CGLC <DE2>			01.12→	<b>0 281 002 956</b>	
<b>A5 Cabriolet</b>								
2.0 TDI [8F7]	2,0	120/125	CAHA <D93>; CAHB <D95>			05.09-03.12	<b>0 281 002 735</b>	
TDI, TDI quattro [8F7]	2,0	105/110/120/130/140	CGLC <DE2>; CGLD <D95>; CJCA <D92>; CJCD <DN4>; CNHA <DE5>; CSUA <DN4>			10.11→	<b>0 281 002 956</b>	
<b>A5 Coupé</b>								
2.0 TDI, TDI quattro [8T3]	2,0	120/125/120/130/140	CAHA <D93>; CAHB <D95>; CGLC <DE2>; CGLD <D95>; CNHA <DE5>; CNHC <D95>			01.08-03.12 08.11→	<b>0 281 002 735</b> <b>0 281 002 956</b>	
<b>A5 Sportback</b>								
2.0 TDI [8TA]	2,0	100/105/110/120/130	CGLC <DE2>; CGLD <D95>; CJCA <D92>; CJCB <D94>; CJCD <DN4>			08.11→	<b>0 281 002 956</b>	
		105	CMEA <D92>; CMFA <D92>			05.10-03.12 11.11-05.13	<b>0 281 002 735</b> <b>0 281 002 956</b>	
TDI, TDI quattro [8TA]	2,0	100/110/120/140	CMFB <DN4>; CNHA <DE5>; CNHC <D95>; CSUA <DN4>; CSUB <D94>			09.13→	<b>0 281 002 956</b>	
		100/120/125	CAGB <D94>; CAHA <D93>; CAHB <D95>			09.09-03.12	<b>0 281 002 735</b>	
<b>A6</b>								
1.9 TDI [4B2; C5]	1,9	81/81/85/96	AVG; AFN; AJM; AVF			08.99-10.00 04.97-04.01 06.01-05.04	<b>0 281 002 216</b> <b>0 281 002 216</b> <b>0 281 002 461</b>	<b>0 986 284 001</b> <b>0 986 284 001</b> <b>0 986 284 007</b>





◀ AUDI

1.9 TDI [4B2; C5]	1,9	96	AWX	06.01-05.04	0 281 002 461	0 986 284 007
2.0 TDI [4F2; C6]	2,0	89/100/103	BLB; BNA; BRE; BRF; BVG	07.04-06.08	0 281 002 461	0 986 284 007
TDI [4G; C7]	2,0	110	DDCB <DN4>	05.16→	0 281 002 956	
TDI, TDI e [4F2; C6]	2,0	100/120/125	CAGB <D94>; CAHA <D93>; CAHB <D95>	10.08-08.11	0 281 002 735	
TDI, TDI quattro [4G; C7]	2,0	100/110/120/130/140	CGLC <DE2>; CGLD <D95>; CGLG <D94>; CMGB <DE2>; CNHA <DE5>; CSUD <DN4>; CSUE <D94>; CZJA <DE5>; DDCA <D94>; DDDA <DE5>	02.11→	0 281 002 956	
2.5 TDI, TDI quattro [4A2; C4]	2,5	85/103	AAT; AEL	06.94-10.97	0 281 002 074	
TDI, TDI quattro [4B2; C5]	2,5	110	AFB	04.97-05.00	0 281 002 429	0 986 284 005
			AKN			
			Fg.-Nr. →4B..X..200 000	11.98-06.99	0 281 002 429	0 986 284 005
			Fg.-Nr. 4B..Y..000 001→	07.99-04.01	0 281 002 403	0 986 284 004

**A6 Avant**

1.9 TDI [4B5; C5]	1,9	81/85/96	AFN; AJM AVF; AWX	02.98-04.01 06.01-01.05	0 281 002 216 0 281 002 461	0 986 284 001 0 986 284 007
2.0 TDI [4F5; C6]	2,0	89/100/103	BLB; BNA; BRE; BRF; BVG	06.05-10.08	0 281 002 461	0 986 284 007
TDI, TDI e [4F5; C6]	2,0	100/120/125	CAGB <D94>; CAHA <D93>; CAHB <D95>	10.08-08.11	0 281 002 735	
TDI, TDI quattro [4G; C7]	2,0	100/110/120/130/140	CGLC <DE2>; CGLD <D95>; CGLG <D94>; CMGB <DE2>; CNHA <DE5>; CSUD <DN4>; CSUE <D94>; CZJA <DE5>; DDCA <D94>; DDCB <DN4>; DDDA <DE5>	05.11→	0 281 002 956	
2.5 TDI, TDI quattro [4A5; C4]	2,5	85/103	AAT; AEL	06.94-10.97	0 281 002 074	
TDI, TDI quattro [4B5; C5]	2,5	110	AFB	02.98-05.00	0 281 002 429	0 986 284 005
			AKN			
			Fg.-Nr. →4B..X..200 000	11.98-06.99	0 281 002 429	0 986 284 005
			Fg.-Nr. 4B..Y..000 001→	07.99-04.01	0 281 002 403	0 986 284 004

**A8**

2.5 TDI, TDI quattro [4D2; D2]	2,5	110	AFB; AKN	06.97-09.02	0 281 002 429	0 986 284 005
3.3 TDI quattro [4D2; D2]	3,3	165	AKF	12.99-08.02	0 281 002 435	0 986 284 006
4.2 TDI quattro [4H; D4]	4,2	258/283	CDSB <DD2>; CTEC <TE5>	11.09→ SFU	0 281 006 069	

**Q3**

2.0 TDI, TDI quattro [8U]	2,0	88/100/103/110/120/130/135	CFFA <D94>; CFFB <D91>; CFGC <DE2>; CFGD <D95>; CLJA <D91>; CLLB <DE2>; CUVB <TL4>; CUVC <DN4>; CUVD <D90>; CUWA <DK7>; CYLA <DK7>; DFTC <D90>	06.11→	0 281 002 956	
---------------------------	-----	----------------------------	--	--------	---------------	--

**Q5**

2.0 TDI quattro [8RB]	2,0	100/105/120/125	CAGA <D92>; CAGB <D94>; CAHA <D93>; CAHB <D95>	11.08-09.10	0 281 002 735	
TDI, TDI quattro [8RB]	2,0	100/105/110/120/125/130/140	CGLA <D95>; CGLB <D93>; CGLC <DE2>; CGLD <D95>; CJCA <D92>; CJCB <D94>; CJCD <DN4>; CMGA <D93>; CMGB <DE2>; CNHA <DE5>; CNHC <D95>; CSUA <DN4>; CSUB <D94>	05.10→	0 281 002 956	

**TT Coupé**

2.0 TDI [FV3]	2,0	135	CUNA <DK7>	07.14→	0 281 002 956	
TDI quattro [8J3]	2,0	125	CBBB <D93> CFGB <D93>	06.08-06.10 05.10-06.14	0 281 002 735 0 281 002 956	









**TT Roadster**

2.0 TDI [FV9]	2,0	135	CUNA <DK7>	11.14→	0 281 002 956	
TDI quattro [8J9]	2,0	125	CBBB <D93> CFGB <D93>	06.08-06.10 05.10-06.14	0 281 002 735 0 281 002 956	

**BMW**

**Serie X1**

16 d sDrive [E 84]	2,0	85	N47 D20C	07.12-06.15	0 281 006 093	
18 d sDrive [E 84]	2,0	100-105	N47 D20C	11.09-06.12	0 281 006 146	

									
<b>18</b> d sDrive [E 84]	2,0	105	N47 D20C <N47N>		07.12-06.15			<b>0 281 006 093</b>	
d xDrive [E 84]	2,0	100-105	N47 D20C		11.09-02.10			<b>0 281 006 146</b>	
					03.10-06.12			<b>0 281 006 093</b>	
<b>20</b> d sDrive [E 84]	2,0	120-130	N47 D20C		10.09-06.12			<b>0 281 006 146</b>	
d sDrive, ed sDrive, s xDrive [E 84]	2,0	120/135	N47 D20C <N47N>		09.11-06.15			<b>0 281 006 093</b>	
d xDrive [E 84]	2,0	120-130	N47 D20C		10.09-02.10			<b>0 281 006 146</b>	
					03.10-06.12			<b>0 281 006 093</b>	
<b>23</b> d xDrive [E 84]	2,0	150	N47 D20D		10.09-06.12			<b>0 281 006 146</b>	
<b>25</b> d xDrive [E 84]	2,0	160	N47 D20D		07.12-06.15			<b>0 281 006 093</b>	
<b>Serie X3</b>									
<b>2.0</b> d [E 83]	2,0	110	20 4D 4 <M 47N>		10.04-09.07			<b>0 928 400 529</b>	
		130	N47 D20A		09.07-08.08			<b>0 281 006 147</b>	
<b>3.0</b> d [E 83]	3,0	150	30 6D 2 <M 57N>		01.04-09.05			<b>0 928 400 529</b>	
		160	30 6D 3 <M 57N2>		09.05-08.06			<b>0 928 400 529</b>	
					09.06-02.07			<b>0 281 006 147</b>	
					03.07-08.08			<b>0 281 006 147</b>	
sd [E 83]	3,0	210	30 6D 5		09.06-02.07			<b>0 281 006 147</b>	
					03.07-08.08			<b>0 281 006 147</b>	
<b>18</b> d sDrive [F 25]	2,0	105/110	N47 D20C		10.12-11.14			<b>0 281 006 092</b>	
d xDrive [E 83]	2,0	105	N47 D20C		05.09-02.10			<b>0 281 006 147</b>	
					03.10-08.10			<b>0 281 006 147</b>	
<b>20</b> d xDrive [E 83]	2,0	120-130	N47 D20...		09.08-02.10			<b>0 281 006 147</b>	
					03.10-08.10			<b>0 281 006 147</b>	
d xDrive [F 25]	2,0	135	N47 D20C		10.10→			<b>0 281 006 092</b>	
<b>30</b> d xDrive [E 83]	3,0	155-160	30 6D 3 <M 57N2>		09.08-02.10			<b>0 281 006 147</b>	
					03.10-08.10			<b>0 281 006 147</b>	
<b>35</b> d xDrive [E 83]	3,0	210	30 6D 5		09.08-02.10			<b>0 281 006 147</b>	
					03.10-08.10			<b>0 281 006 147</b>	
<b>Serie X5</b>									
<b>3.0</b> d [E 53]	3,0	135	30 6D 1 <M 57 D 30>		03.01-09.03	UPE		<b>0 928 400 527</b>	
		155-160	30 6D 2 <M 57N>		10.03-10.06			<b>0 928 400 529</b>	
d [E 70]	3,0	155-173	30 6D 3 <M 57N2>		03.07-09.08			<b>0 928 400 529</b>	
sd [E 70]	3,0	210	30 6D 5		10.07-09.08			<b>0 281 006 147</b>	
<b>25</b> d sDrive, d xDrive [F 15]	2,0	160	N47 D20D		12.13-07.15			<b>0 281 006 092</b>	
<b>30</b> d xDrive [E 70]	3,0	173	30 6D 3 <M 57N2>		10.08-03.10			<b>0 928 400 529</b>	
<b>35</b> d xDrive [E 70]	3,0	210	30 6D 5		10.08-02.10			<b>0 281 006 147</b>	
					03.10-03.10			<b>0 281 006 147</b>	
<b>Serie X6</b>									
<b>30</b> d xDrive [E 71]	3,0	173	30 6D 3 <M 57N2>		05.08-03.10			<b>0 928 400 529</b>	
<b>35</b> d xDrive [E 71]	3,0	210	30 6D 5		05.08-02.10			<b>0 281 006 147</b>	
					03.10-03.10			<b>0 281 006 147</b>	
<b>Serie 1</b>									
<b>114</b> d [F 20]	1,6	70	N47 D16A		11.12-05.15			<b>0 281 006 092</b>	
d [F 21]	1,6	70	N47 D16A		11.12-05.15			<b>0 281 006 092</b>	
<b>116</b> d [E 81]	2,0	66-85	N47 D20...		03.09-12.11			<b>0 281 006 146</b>	
d [E 87]	2,0	66-85	N47 D20...		03.09-06.11			<b>0 281 006 146</b>	
d [F 20]	2,0	85	N47 D20C		09.11-02.15			<b>0 281 006 092</b>	
d [F 21]	2,0	85	N47 D20C		09.12-02.15			<b>0 281 006 092</b>	
d ed [F 20]	1,6	85	N47 D16A		03.12-02.15			<b>0 281 006 092</b>	
d ed [F 21]	1,6	85	N47 D16A		09.12-02.15			<b>0 281 006 092</b>	
<b>118</b> d [E 81]	2,0	100-105	N47 D20...		05.07-12.11			<b>0 281 006 146</b>	
d [E 87]	2,0	90	20 4D 4 <M 47N>		09.04-03.07			<b>0 928 400 529</b>	
		100-105	N47 D20...		03.07-06.11			<b>0 281 006 146</b>	
d, d xDrive [F 20]	2,0	105	N47 D20C		09.11-02.15			<b>0 281 006 092</b>	
d, d xDrive [F 21]	2,0	105	N47 D20C		09.12-02.15			<b>0 281 006 092</b>	
<b>120</b> d [E 81]	2,0	120-130	N47 D20...		05.07-12.11			<b>0 281 006 146</b>	
d [E 87]	2,0	120	20 4D 4 <M 47N>		09.04-03.07			<b>0 928 400 529</b>	
		120-130	N47 D20...		03.07-06.11			<b>0 281 006 146</b>	
d, d xDrive [F 20]	2,0	135-147	N47 D20C		09.11-02.15			<b>0 281 006 092</b>	
d, d xDrive [F 21]	2,0	135-147	N47 D20C		11.12-02.15			<b>0 281 006 092</b>	
<b>123</b> d [E 81]	2,0	150	N47 D20...		09.07-12.11			<b>0 281 006 146</b>	
d [E 87]	2,0	150	N47 D20...		09.07-06.11			<b>0 281 006 146</b>	
<b>125</b> d [F 20]	2,0	160	N47 D20D		03.12-02.15			<b>0 281 006 092</b>	





◀ BMW

125 d [F 21]	2,0	160	N47 D20D	09.12-02.15	0 281 006 092
<b>Serie 1 Cabrio</b>					
118 d [E 88]	2,0	100-105	N47 D20...	09.08-10.13	0 281 006 146
120 d [E 88]	2,0	120-130	N47 D20...	03.08-10.13	0 281 006 146
123 d [E 88]	2,0	150	N47 D20...	09.08-09.13	0 281 006 146
<b>Serie 1 Coupé</b>					
118 d [E 82]	2,0	100-105	N47 D20C	09.09-10.13	0 281 006 146
120 d [E 82]	2,0	120-130	N47 D20...	10.07-10.13	0 281 006 146
123 d [E 82]	2,0	150	N47 D20...	10.07-09.13	0 281 006 146
<b>Serie 2 Coupé</b>					
218 d [F 22]	2,0	105	N47 D20C	03.14-06.15	0 281 006 092
220 d [F 22]	2,0	135	N47 D20C	03.14-10.14	0 281 006 092
225 d [F 22]	2,0	160	N47 D20D	03.14-06.15	0 281 006 092
<b>Serie 3</b>					
316 d [E 90]	2,0	85	N47 D20C	09.09-02.10	0 281 006 146
				03.10-10.11	0 281 006 093
d [F 30]	2,0	85	N47 D20C	03.12-02.15	0 281 006 092
318 d [E 46]	2,0	85	20 4D 1 <M 47 D 20>	09.01-03.03	UPE 0 928 400 527
			20 4D 4 <M 47N>	03.03-03.05	EU3,UPE 0 928 400 527
				EU4	0 928 400 529
d [E 90]	2,0	90	20 4D 4 <M 47N>	09.05-09.07	0 928 400 529
		100-105	N47 D20...	09.07-02.10	0 281 006 146
				03.10-10.11	0 281 006 093
d, d xDrive [F 30]	2,0	105	N47 D20C	03.12-06.15	0 281 006 092
320 d [E 46]	2,0	100	20 4D 1 <M 47 D 20>	04.98-09.01	UPE 0 928 400 527
		110	20 4D 4 <M 47N>	09.01-03.05	EU3,UPE 0 928 400 527
				EU4	0 928 400 529
d [E 90]	2,0	110/120	20 4D 4 <M 47N>	03.05-09.07	0 928 400 529
d, d ed, d xDrive [E 90]	2,0	120-135	N47 D20C <N47N>	03.10-12.11	0 281 006 093
d, d ed, d xDrive [F 30]	2,0	120/135-147	N47 D20C	02.12-→	0 281 006 092
d, d xDrive [E 90]	2,0	120-130	N47 D20...; N47 D20C	09.07-03.10	0 281 006 146
323 d [F 30]	2,0	160	N47 D20D	03.13-→	0 281 006 092
325 d [E 90]	3,0	145	30 6D 3 <M 57N2>	09.06-02.10	0 928 400 529
330 d, xd [E 46]	3,0	135	30 6D 1 <M 57 D 30>	10.99-04.03	UPE 0 928 400 527
		150	30 6D 2 <M 57N>	03.03-03.05	0 928 400 529
d, xd [E 90]	3,0	170	30 6D 3 <M 57N2>	09.05-08.08	0 928 400 529
335 d [E 90]	3,0	210	30 6D 5	09.06-02.07	0 281 006 147
				03.07-02.10	0 281 006 147
				03.10-10.11	0 281 006 147
<b>Serie 3 Cabrio</b>					
320 d [E 46]	2,0	110	20 4D 4 <M 47N>	01.05-08.06	0 928 400 529
d [E 93]	2,0	120-135	N47 D20C <N47N>	03.10-10.13	0 281 006 093
		130	N47 D20...	03.08-02.10	0 281 006 146
325 d [E 93]	3,0	145	30 6D 3 <M 57N2>	09.07-02.10	0 928 400 529
330 d [E 46]	3,0	150	30 6D 2 <M 57N>	04.05-08.06	0 928 400 529
d [E 93]	3,0	170	30 6D 3 <M 57N2>	03.07-02.09	0 928 400 529
<b>Serie 3 Compact</b>					
318 td [E 46]	2,0	85	20 4D 4 <M 47N>	03.03-12.04	EU3,UPE 0 928 400 527
				EU4	0 928 400 529
320 td [E 46]	2,0	110	20 4D 4 <M 47N>	09.01-12.04	EU3,UPE 0 928 400 527
				EU4	0 928 400 529
<b>Serie 3 Coupé</b>					
320 d [E 46]	2,0	110	20 4D 4 <M 47N>	09.03-05.06	EU3,UPE 0 928 400 527
				EU4	0 928 400 529
d, d xDrive [E 92]	2,0	120-135	N47 D20C <N47N>	03.10-06.13	0 281 006 093
		130	N47 D20...; N47 D20C	03.07-02.10	0 281 006 146
325 d [E 92]	3,0	145	30 6D 3 <M 57N2>	03.07-02.10	0 928 400 529
330 d [E 46]	3,0	150	30 6D 2 <M 57N>	03.03-05.06	0 928 400 529
d, xd [E 92]	3,0	170	30 6D 3 <M 57N2>	09.06-08.08	0 928 400 529
335 d [E 92]	3,0	210	30 6D 5	09.06-02.07	0 281 006 147
				03.07-02.10	0 281 006 147
				03.10-03.13	0 281 006 147





Serie 3 GT						
318 d [F 34]	2,0	105	N47 D20C		06.13-06.15	0 281 006 092
320 d, d xDrive [F 34]	2,0	135	N47 D20C		06.13-06.15	0 281 006 092
325 d [F 34]	2,0	160	N47 D20D		07.13→	0 281 006 092
Serie 3 Touring						
316 d [E 91]	2,0	85	N47 D20C <N47N>		03.10-05.12	0 281 006 093
d [F 31]	2,0	85	N47 D20C		11.12-02.15	0 281 006 092
318 d [E 46]	2,0	85	20 4D 1 <M 47 D 20>		03.02-03.03 UPE	0 928 400 527
			20 4D 4 <M 47N>		03.03-09.05 EU3,UPE EU4	0 928 400 527 0 928 400 529
d [E 91]	2,0	90 100-105	20 4D 4 <M 47N>		03.06-09.07	0 928 400 529
			N47 D20...		09.07-02.10	0 281 006 146
					03.10-05.12	0 281 006 093
d, d xDrive [F 31]	2,0	105	N47 D20C		11.12-06.15	0 281 006 092
320 d [E 46]	2,0	100	20 4D 1 <M 47 D 20>		10.99-09.01 UPE	0 928 400 527
		110	20 4D 4 <M 47N>		09.01-09.05 EU3,UPE EU4	0 928 400 527 0 928 400 529
d [E 91]	2,0	110/120	20 4D 4 <M 47N>		09.05-08.07	0 928 400 529
d, d ed, d xDrive [E 91]	2,0	120-135	N47 D20C <N47N>		03.10-05.12	0 281 006 093
d, d ed, d xDrive [F 31]	2,0	120/135-	N47 D20C		09.12→	0 281 006 092
		147				
d, d xDrive [E 91]	2,0	120-130	N47 D20...; N47 D20C		09.07-02.10	0 281 006 146
325 d [E 91]	3,0	145	30 6D 3 <M 57N2>		09.06-02.10	0 928 400 529
d [F 31]	2,0	160	N47 D20D		03.13→	0 281 006 092
330 d, xd [E 46]	3,0	135	30 6D 1 <M 57 D 30>		10.99-03.03 UPE	0 928 400 527
		150	30 6D 2 <M 57N>		03.03-09.05	0 928 400 529
d, xd [E 91]	3,0	170	30 6D 3 <M 57N2>		09.05-08.08	0 928 400 529
335 d [E 91]	3,0	210	30 6D 5		09.06-02.07	0 281 006 147
					03.07-02.10	0 281 006 147
					03.10-05.12	0 281 006 147
Serie 4 Cabrio						
420 d [F 33]	2,0	135	N47 D20C		03.14-06.15	0 281 006 092
425 d [F 33]	2,0	160	N47 D20D		06.14→	0 281 006 092
Serie 4 Coupé						
420 d [F 32]	2,0	135	N47 D20C		09.13-02.15	0 281 006 092
425 d [F 32]	2,0	160	N47 D20D		03.14→	0 281 006 092
Serie 4 GC						
418 d [F 36]	2,0	105	N47 D20C		05.14-06.15	0 281 006 092
420 d, d xDrive [F 36]	2,0	135	N47 D20C		05.14-03.15	0 281 006 092
Serie 5						
518 d [F 10]	2,0	105	N47 D20C <N47N>		07.13-06.14	0 281 006 092
520 d [E 39]	2,0	100	20 4D 1 <M 47 D 20>		04.00-07.03 UPE	0 928 400 527
			d [E 60]		09.05-02.08	0 928 400 529
d [E 60]	2,0	110/120	20 4D 4 <M 47N>		09.07-02.10	0 281 006 147
		120-130	N47 D20...		09.07-02.10	0 281 006 147
d, d ed, d xDrive [F 10]	2,0	135	N47 D20C <N47N>		05.10→	0 281 006 092
525 d [E 39]	2,5	120	25 6D 1		04.00-07.03 UPE	0 928 400 527
d [E 60]	2,5	120/130	25 6D 2		05.04-03.07	0 928 400 529
d, d xDrive [F 10]	2,0	160	N47 D20D <N47S1>		09.11→	0 281 006 092
d, d xDrive, xd [E 60]	3,0	145	30 6D 3 <M 57N2>		03.07-02.10	0 928 400 529
530 d [E 39]	3,0	135-142	30 6D 1 <M 57 D 30>		08.98-07.03 UPE	0 928 400 527
		d, d xDrive, xd [E 60]		07.03-02.10	0 928 400 529	
535 d [E 60]	3,0	200/210	30 6D 4; 30 6D 5		09.04-02.10	0 281 006 147
Serie 5 GT						
520 d [F 07]	2,0	135	N47 D20C		07.12→	0 281 006 092
Serie 5 Touring						
518 d [F 11]	2,0	105	N47 D20C <N47N>		07.13-06.14	0 281 006 092
520 d [E 39]	2,0	100	20 4D 1 <M 47 D 20>		04.00-07.03 UPE	0 928 400 527
			d [E 61]		09.05-02.08	0 928 400 529
					09.07-02.10	0 281 006 147
d [E 61]	2,0	110/120	20 4D 4 <M 47N>		03.10-08.10	0 281 006 147
		120-130	N47 D20...		09.10→	0 281 006 092
d [F 11]	2,0	135	N47 D20C <N47N>		09.10→	0 281 006 092
525 d [E 39]	2,5	120	25 6D 1		04.00-05.04 UPE	0 928 400 527







◀ BMW

<b>525 d [E 61]</b>	2,5	120/130	25 6D 2	05.04-03.07	<b>0 928 400 529</b>
d, d xDrive [F 11]	2,0	160	N47 D20D <N47S1>	09.11→	<b>0 281 006 092</b>
d, d xDrive, xd [E 61]	3,0	145	30 6D 3 <M 57N2>	03.07-08.10	<b>0 928 400 529</b>
<b>530 d [E 39]</b>	3,0	135-142	30 6D 1 <M 57 D 30>	08.98-05.04 UPE	<b>0 928 400 527</b>
d, d xDrive, xd [E 61]	3,0	160/170/173	30 6D 2 <M 57N>; 30 6D 3 <M 57N2>	05.04-08.10	<b>0 928 400 529</b>
<b>535 d [E 61]</b>	3,0	200	30 6D 4	09.04-03.07	<b>0 281 006 147</b>
		210	30 6D 5	03.07-02.10	<b>0 281 006 147</b>
				03.10-08.10	<b>0 281 006 147</b>
<b>Serie 6</b>					
<b>635 d [E 63]</b>	3,0	210	30 6D 5	09.07-02.10	<b>0 281 006 147</b>
				03.10-07.10	<b>0 281 006 147</b>
<b>Serie 6 Cabrio</b>					
<b>635 d [E 64]</b>	3,0	210	30 6D 5	09.07-02.10	<b>0 281 006 147</b>
				03.10-07.10	<b>0 281 006 147</b>
<b>Serie 7</b>					
<b>730 d [E 38]</b>	3,0	135-142	30 6D 1 <M 57 D 30>	08.98-12.01 UPE	<b>0 928 400 527</b>
d [E 65]	3,0	160/170	30 6D 2 <M 57N>; 30 6D 3 <M 57N2>	10.02-10.08	<b>0 928 400 529</b>
d, d xDrive [G 11]	3,0	195	B57 D30A	09.15→	<b>0 281 006 597</b>
Ld [E 66]	3,0	170	30 6D 3 <M 57N2>	09.05-10.08	<b>0 928 400 529</b>
Ld, Ld xDrive [G 12]	3,0	195	B57 D30A	09.15→	<b>0 281 006 597</b>
<b>740 d [E 38]</b>	3,9	180	39 8D 1 <M 67>	10.98-12.01	<b>0 280 217 124</b>
d [E 65]	3,9	190	39 8D 1 <M 67>	10.02-03.05	<b>0 281 006 146</b>
d xDrive [G 11]	3,0	235	B57 D30B	11.15→	<b>0 281 006 597</b>
Ld xDrive [G 12]	3,0	235	B57 D30B	11.15→	<b>0 281 006 597</b>
<b>745 d [E 65]</b>	4,4	220/242	44 8D 1	03.05-10.08	<b>0 281 006 146</b>
<b>750 d xDrive [G 11]</b>	3,0	294	B57 D30C	07.16→	<b>0 281 006 597</b>
Ld xDrive [G 12]	3,0	294	B57 D30C	07.16→	<b>0 281 006 597</b>



**CHEVROLET**

<b>Captiva</b>					
<b>2.0</b> CDRI, CDRI 4x4 [C100]	2,0	93/110	Z20S	10.06-02.11	<b>0 281 002 683</b>
<b>Cruze</b>					
<b>1.7</b> CDI [J300]	1,7	81/96	A 17 DTS; <LKR>	01.12-08.15	<b>0 281 002 940</b>
<b>2.0</b> CDI [J300]	2,0	110/120	Z20D1 <Euro 5>; Z20S1	05.09→	<b>0 281 002 912</b>
<b>Cruze Hatchback</b>					
<b>1.7</b> CDI [J305]	1,7	81/96	A 17 DTS; <LKR>	01.12-08.15	<b>0 281 002 940</b>
<b>2.0</b> CDI [J305]	2,0	120	Z20D1 <Euro 5>	07.11→	<b>0 281 002 912</b>
<b>Cruze Station Wagon</b>					
<b>1.7</b> CDI [J308]	1,7	81/96	A 17 DTS; <LKR>	07.12-08.15	<b>0 281 002 940</b>
<b>2.0</b> CDI [J308]	2,0	120	Z20D1 <Euro 5>	07.12→	<b>0 281 002 912</b>
<b>Lacetti</b>					
<b>2.0</b> D [J200]	2,0	89	Z20S	09.06-04.13	<b>0 281 002 683</b>
<b>Malibu</b>					
<b>2.0</b> CDRI [V300]	2,0	118	LBS <Euro 5>	06.12→	<b>0 281 002 912</b>
<b>Nubira</b>					
<b>2.0</b> D [J200]	2,0	89	Z20S	09.06-04.13	<b>0 281 002 683</b>
<b>Nubira Wagon</b>					
<b>2.0</b> D [J200]	2,0	89	Z20S	09.06-04.13	<b>0 281 002 683</b>
<b>Orlando</b>					
<b>2.0</b> CRDi [J309]	2,0	120	Z20D1 <Euro 5>	10.10→	<b>0 281 002 912</b>
<b>Trax</b>					
<b>1.7</b> CDI, CDI AWD	1,7	96	A 17 DTS	11.12→	<b>0 281 006 311</b>

**CHRYSLER**

<b>PT Cruiser</b>					
<b>2.2</b> CRD [PT]	2,2	89/110	EDJ	09.02-12.09	<b>0 281 002 571</b>
<b>Sebring</b>					
<b>2.0</b> CRD [JS]	2,0	103	ECD	09.06→	<b>0 281 002 779</b>



<b>Sebring Convertible</b>						
2.0 CRD [JS]	2,0	103	ECD		09.06→	<b>0 281 002 779</b>
<b>Voyager</b>						
2.5 CRD, CRD 4x4 [RG]	2,5	105	ENC; ENJ		09.00-08.07	<b>0 281 002 451</b>
TD [GS]	2,5	85	VM HR 425 CLIEE <ENC>		01.95-12.00	<b>0 281 002 132</b>
<b>300C</b>						
3.0 CRD [LE]	3,0	160	EXL		10.05-08.10	<b>0 281 002 896</b>
<b>300C Touring</b>						
3.0 CRD [LE]	3,0	160	EXL		10.05-08.10	<b>0 281 002 896</b>

**CITROEN**

<b>Nemo</b>						
1.3 HDi [A9]	1,3	55/59	FHY <F 13DTE6>; FHZ <F13DTE5>		08.10→	<b>0 281 002 917</b>
<b>XM</b>						
2.5 D Turbo [Y4]	2,5	94-96	THY <DK5ATE>		07.94-10.00 N05	<b>0 281 002 128</b>

**DODGE**

<b>Avenger</b>						
2.0 CRD [JS]	2,0	103	ECD		09.07-08.10	<b>0 281 002 779</b>
<b>Caliber</b>						
2.0 CRD [PM]	2,0	88/103	ECD; ECE		09.06-08.09	<b>0 281 002 779</b>
<b>Caravan</b>						
2.5 TD [NS]	2,5	85	VM HR 425 CLIEE <ENC>		01.95-08.03	<b>0 281 002 132</b>
<b>Journey</b>						
2.0 CRD [JC]	2,0	103	ECE		09.08-08.10	<b>0 281 002 779</b>
<b>Stratus</b>						
2.0 CRD [JS]	2,0	103	ECD <A>		09.06-08.07	<b>0 281 002 779</b>

**FIAT**

<b>Albea</b>						
1.3 JTD 16V [172]	1,3	52	188 A9.000 <M40>		07.03-12.12	<b>0 281 002 613</b>
<b>Brava</b>						
1.9 JTD [182]	1,9	74	182 B9.000 <M26>		08.00-09.01	<b>0 281 002 309</b>
		77	182 B4.000 <M25>		11.98-09.01	<b>0 280 218 019</b>
TD [182]	1,9	73,6/74	182 A7.000 <M8>; 182 A7.000 <M21>		03.96-09.01	<b>0 281 002 144</b>
<b>Bravo</b>						
1.6 Multijet [198]	1,6	66	198 A6.000		02.09-12.09	<b>0 281 002 917</b>
					03.10-12.14	<b>0 281 006 054</b>
		77	198 A3.000		01.10-09.13	<b>0 281 006 054</b>
			198 A3.000 <M76>		10.07-12.09	<b>0 281 002 917</b>
			844 A3.000		10.13-12.14	<b>0 281 006 054</b>
		85	955 A4.000		11.08-12.09	<b>0 281 002 917</b>
		88	198 A2.000		03.10-12.14	<b>0 281 006 054</b>
			198 A2.000 <M78>		03.08-12.09	<b>0 281 002 917</b>
1.9 JTD [182]	1,9	74	182 B9.000 <M26>		08.00-09.01	<b>0 281 002 309</b>
		77	182 B4.000 <M25>		11.98-09.01	<b>0 280 218 019</b>
Multijet [198]	1,9	66/85/88	192 A8.000 <M88>; 192 B4.000 <M87>; 192 B5.000 <M83>		03.07-06.07	<b>0 281 002 792</b>
					07.07-12.09	<b>0 281 002 980</b>
		110	937 A5.000 <M92>		07.07-12.09	<b>0 281 002 980</b>
TD [182]	1,9	73,6/74	182 A7.000 <M8>; 182 A7.000 <M21>		03.96-09.01	<b>0 281 002 144</b>
2.0 Multijet [198]	2,0	120	844 A2.000		10.08-12.09	<b>0 281 002 917</b>
					03.10-12.14	<b>0 281 006 054</b>
		120-121	198 A...		03.10-12.14	<b>0 281 006 054</b>
		121	198 A5.000 <M120>		10.08-12.09	<b>0 281 002 917</b>
<b>Croma</b>						
1.9 JTD 8V, JTD 16V [194]	1,9	85/88/ 100/110	939 A1.000 <M88>; 939 A2.000 <M92>; 939 A7.000 <M87>; 939 A8.000 <M91>		06.05-12.10	<b>0 281 002 683</b>













◀ FIAT

2.4 JTD [194]	2,4	147	939 A3.000 <M95>	06.05-12.10	0 281 006 048	
2.5 TDI [154]	2,5	85	8144.97Y (US87) <M5>	09.93-11.96	0 281 002 088	
<b>Doblo</b>						
1.3 JTD 16V [223]	1,3	51	188 A9.000 <M20>	02.04-09.05	0 281 002 613	
Multijet [223]	1,3	55	199 A2.000 <M73>	10.05-06.14	0 281 002 792	
			62	223 A9.000 <M71>	07.14-08.16	0 281 002 980
					10.05-06.07	0 281 002 792
			07.07-12.10	0 281 002 980		
Multijet [263]	1,3	66	199 A3.000 <M72 (ECOFC4)>; 263 A2.000 <M72>	02.10→	SSJ 0 281 002 980 SSJ 0 281 006 054	
MultiJet [263]	1,3	70	330 A1.000	04.16→	0 281 006 054	
1.6 Multijet [263]	1,6	66/74/77	198 A3.000 <M76>; 263 A...; 263 A3.000 <M76>	02.10→	SSJ 0 281 002 917 SSJ 0 281 006 054	
				70/77/88	263 A7.000; 263 A8.000; 940 C1.000	04.15→
1.9 JTD [223]	1,9	74	182 B9.000 <M15>	10.01-01.04	0 280 218 113	
			77	223 A7.000 <M16/M30>	11.02-09.05	0 280 218 113
			Multijet [223]	1,9	74/77	223 B1.000 <M84>; 223 B2.000 <M86>
88	186 A9.000 <M88>	10.05-12.10			0 281 002 861	
2.0 Multijet [263]	2,0	99	263 A1.000 <M120>	02.10→	0 281 006 054	
<b>Doblo Cargo</b>						
1.3 JTD 16V [223]	1,3	51	188 A9.000 <M20>	02.04-09.05	0 281 002 613	
Multijet [223]	1,3	55	199 A2.000 <M73>	10.05-06.14	0 281 002 792	
			62	223 A9.000 <M71>	07.14-08.16	0 281 002 980
					10.05-06.07	0 281 002 792
					07.07-12.10	0 281 002 980
			MultiJet [263]	1,3	55/66	263 A2.000 <M72>; 263 A6.000
			59	225 A2.000	04.16→	0 281 006 054
			66	199 A3.000 <M72 (ECOFC4)>	02.10→	SSJ 0 281 002 980 SSJ 0 281 006 054
					70	330 A1.000
1.6 MultiJet [263]	1,6	66/74/77	198 A3.000 <M76>; 263 A...; 263 A3.000 <M76>	02.10→	SSJ 0 281 002 917 SSJ 0 281 006 054	
				77/88	263 A8.000; 940 C1.000	04.15→
1.9 JTD [223]	1,9	74	182 B9.000 <M15>	10.01-01.04	0 280 218 113	
			77	223 A7.000 <M16/M30>	11.02-09.05	0 280 218 113
			Multijet [223]	1,9	74/77	223 B1.000 <M84>; 223 B2.000 <M86>
88	186 A9.000 <M88>	10.05-12.10			0 281 002 861	
2.0 MultiJet [263]	2,0	99	263 A1.000 <M120>	02.10→	0 281 006 054	
<b>Fiorino</b>						
1.3 Multijet [225]	1,3	55	199 A2.000 <M73>	12.07→	0 281 002 963	
			55/70	199 A9.000 <ECOFC5>; 199 B1.000	06.10→	0 281 006 054
			59/70	225 A2.000; 330 A1.000	03.15→	0 281 002 963
<b>Grande Punto</b>						
1.3 MultiJet [199]	1,3	51	199 B2.000 <ECOFC4>	07.08-12.11	0 281 002 980	
			55	199 A9.000 <ECOFC5>	09.08-12.11	0 281 006 054
			55/66	199 A2.000 <M73>; 199 A3.000 <M72 (ECOFC4)>	10.05-10.07	0 281 002 792
					11.07-12.11	0 281 002 980
1.6 MultiJet [199]	1,6	88	199 B4.000 <ECOFC5>	04.10-12.11	0 281 006 054	
			955 A3.000 <M78>	08.08-12.09	0 281 002 917	
1.9 MultiJet [199]	1,9	85/88/96	199 A5.000 <M89>; 939 A1.000 <M88>;	10.05-11.07	0 281 002 683	
			939 A7.000 <M87>	12.07-12.09	0 281 002 861	
<b>Idea</b>						
1.3 MultiJet [350]	1,3	51	188 A9.000 <M30>	01.04-11.10	0 281 002 613	
			66	199 A3.000 <M72 (ECOFC4)>	11.04-11.10	0 281 002 792
			70	199 B1.000	05.08-12.12	SSJ 0 281 002 917 SSJ 0 281 006 054
1.6 MultiJet [350]	1,6	85-88	350 A...	04.08-12.12	SSJ 0 281 002 917 SSJ 0 281 006 054	
				1.9 MultiJet [350]	1,9	74
				12.07-12.12	0 281 002 861	
<b>Linea</b>						
1.3 JTD [110]	1,3	63	199 A3.000	12.08→	0 281 002 980	



									
<b>1.3</b> MultiJet [323]	1,3	66	199 A3.000 <M72 (ECOCF4)>		03.07→				<b>0 281 002 980</b>
		70	199 B1.000		09.09→				<b>0 281 006 054</b>
<b>1.6</b> MultiJet [323]	1,6	77	198 A3.000 <M76>		10.08→				<b>0 281 006 054</b>
<b>Marea</b>									
<b>1.9</b> JTD [185]	1,9	77	182 B4.000 <M1>		03.99-09.02				<b>0 280 218 019</b>
		81	186 A6.000 <M4>		08.00-09.02				<b>0 281 002 308</b>
JTD S.W. [185]	1,9	74	182 B9.000 <M5>		10.01-09.02				<b>0 281 002 309</b>
TD [185]	1,9	73,6	182 A7.000 <M1>		10.96-02.99				<b>0 281 002 144</b>
<b>2.4</b> JTD [185]	2,4	100	185 A6.000 <M3>		03.99-09.02				<b>0 280 218 004</b>
TD [185]	2,4	91	185 A2.000 <M3>						
			Mot.-Nr. →0918279		10.96-02.99				<b>0 281 002 185</b>
			Mot.-Nr. 0918280→		10.96-02.99				<b>0 281 002 144</b>
<b>Marengo</b>									
<b>1.9</b> JTD [285]	1,9	77	182 B4.000 <M1>		03.99-09.02				<b>0 280 218 019</b>
		81	186 A6.000 <M4>		08.00-09.02				<b>0 281 002 308</b>
TD [285]	1,9	73,6	182 A7.000 <M1>		01.97-02.99				<b>0 281 002 144</b>
<b>Multipla</b>									
<b>1.9</b> JTD [186]	1,9	77	182 B4.000 <M5>		01.99-12.00				<b>0 280 218 004</b>
		81	186 A6.000 <M6>		08.00-03.02				<b>0 281 002 308</b>
		85	186 A8.000 <M7/EU3>		04.02-10.03				<b>0 281 002 308</b>
					11.03-06.10				<b>0 280 218 120</b>
		85/88	186 A8.000 <M87/EU4>; 186 A9.000 <M88>		10.03-06.07				<b>0 281 002 792</b>
					07.07-12.10				<b>0 281 002 980</b>
<b>Palio</b>									
<b>1.3</b> JTD 16V [178]	1,3	52	188 A9.000 <M40>		07.03-12.11				<b>0 281 002 613</b>
<b>Palio Weekend</b>									
<b>1.9</b> JTD [178]	1,9	57/80	188 A2.000 <M30>		10.01-12.08				<b>0 281 002 308</b>
<b>Panda</b>									
<b>1.3</b> JTD [169]	1,3	55	169 A1.000 <M73>		05.06-12.09				<b>0 281 002 792</b>
JTD, JTD 4x4 [169]	1,3	52	188 A8.000 <ECOCF4>; 188 A8.000 <M10>		01.04-09.10				<b>0 281 002 613</b>
Multijet, Multijet 4x4 [169]	1,3	55	169 A5.000 <ECOCF5>		03.10-12.12				<b>0 281 002 917</b>
MultiJet, MultiJet 4x4 [312]	1,3	55/59/70	199 A9.000 <ECOCF5>; 225 A2.000; 312 A8.000; 312 B1.000; 312 B2.000; 330 A1.000		02.12→				<b>0 281 006 054</b>
<b>Punto</b>									
<b>1.3</b> MJTD 16V [188]	1,3	52	188 A9.000 <M20>		07.03-12.10				<b>0 281 002 613</b>
MultiJet [199]	1,3	55	199 A2.000 <ECOCF4>		01.12-08.13				<b>0 281 002 792</b>
		55/59/62/70	199 A9.000 <ECOCF5>; 199 B1.000; 199 B4.000 <ECOCF5>; 199 B8.000		01.12→		SSJ		<b>0 281 002 917</b>
							SSJ		<b>0 281 006 054</b>
<b>1.9</b> JTD [188]	1,9	59/63	188 A2.000 <M5>; 188 A7.000 <M6>		07.99-06.03				<b>0 281 002 309</b>
JTD 8V [188]	1,9	63/74	188 A7.000 <M25>; 188 B2.000 <M30>		07.03-12.10				<b>0 280 218 113</b>
<b>Punto Evo</b>									
<b>1.3</b> MultiJet [199]	1,3	51	199 B2.000 <ECOCF4>		10.09-12.11				<b>0 281 002 980</b>
		55-56/66	199 A2.000 <ECOCF4>; 199 A3.000 <M72 (ECOCF4)>		10.09-12.11				<b>0 281 002 980</b>
		55-56/68-70	199 A9.000 <ECOCF5>; 199 B1.000		10.09-12.11		SSJ		<b>0 281 002 917</b>
							SSJ		<b>0 281 006 054</b>
		62	199 B4.000 <ECOCF5>		10.09-12.11		SSJ		<b>0 281 002 917</b>
							SSJ		<b>0 281 006 054</b>
<b>1.6</b> MultiJet [199]	1,6	88	955 A3.000 <M78>		10.09-12.11				<b>0 281 006 054</b>
<b>Punto Van</b>									
<b>1.3</b> MJTD 16V [288]	1,3	51	188 A9.000 <M20>		07.03-12.10				<b>0 281 002 613</b>
<b>1.9</b> JTD [288]	1,9	63	188 A7.000 <M6>		05.99-06.03				<b>0 281 002 309</b>
JTD 8V [288]	1,9	63	188 A7.000 <M25>		07.03-12.10				<b>0 280 218 113</b>
<b>Qubo</b>									
<b>1.3</b> Multijet [300]	1,3	55	199 A2.000 <M73>		09.08→				<b>0 281 002 963</b>
		55/70	199 A9.000 <ECOCF5>; 199 B1.000		06.10→				<b>0 281 006 054</b>
		59/70	225 A2.000; 330 A1.000		03.15→				<b>0 281 002 963</b>
<b>Stilo</b>									
<b>1.9</b> JTD	1,9	85			06.02-12.07				<b>0 281 002 308</b>
JTD 8V [192]	1,9	59/85	192 A1.000 <M50>; 192 A3.000 <M40>		10.01-12.07				<b>0 281 002 308</b>
		66	192 B5.000 <M83>		10.05-06.07				<b>0 281 002 792</b>
					07.07-12.07				<b>0 281 002 980</b>
		74	192 A9.000 <M45>		01.04-12.07				<b>0 281 002 308</b>





◀ FIAT

<b>1.9 JTD 8V [192]</b>	1,9	88	192 A8.000 <M88>	07.05-06.07	<b>0 281 002 792</b>
				07.07-12.07	<b>0 281 002 980</b>
JTD 8V, JTD 16V [192]	1,9	85/110	937 A5.000 <M92>; 937 A7.000 <M87>	07.05-06.07	<b>0 281 002 792</b>
				07.07-12.07	<b>0 281 002 980</b>
JTD 16V [192]	1,9	93	937 A4.000 <M61>	01.04-12.07	<b>0 280 218 120</b>
		100	192 B1.000 <M62>	01.04-12.07	<b>0 280 218 120</b>
		103	192 A5.000 <M60>	01.04-12.07	<b>0 280 218 120</b>
<b>Stilo Multi Wagon</b>					
<b>1.9 JTD 8V [192]</b>	1,9	59/85	192 A1.000 <M50>; 192 A3.000 <M40>	10.02-12.07	<b>0 281 002 308</b>
		66	192 B5.000 <M83>	10.05-06.07	<b>0 281 002 792</b>
				07.07-12.07	<b>0 281 002 980</b>
		74	192 A9.000 <M45>	09.04-12.07	<b>0 281 002 308</b>
		88	192 A8.000 <M88>	07.05-06.07	<b>0 281 002 792</b>
				07.07-12.07	<b>0 281 002 980</b>
JTD 8V, JTD 16V [192]	1,9	85/110	937 A5.000 <M92>; 937 A7.000 <M87>	07.05-06.07	<b>0 281 002 792</b>
				07.07-12.07	<b>0 281 002 980</b>
JTD 16V [192]	1,9	93	937 A4.000 <M61>	09.04-12.07	<b>0 280 218 120</b>
		100	192 B1.000 <M62>	09.04-12.07	<b>0 280 218 120</b>
		103	192 A5.000 <M60>	01.04-12.07	<b>0 280 218 120</b>
<b>Strada</b>					
<b>1.3 JTD [278]</b>	1,3	63	223 A9.000 <M71>	07.05-06.07	<b>0 281 002 792</b>
				07.07-12.11	<b>0 281 002 980</b>
MultiJet [278]	1,3	70	199 B1.000	12.11→	<b>0 281 002 917</b>
<b>1.9 JTD [278]</b>	1,9	59	188 A2.000 <M50>	04.03-06.05	<b>0 281 002 308</b>
<b>Tipo</b>					
<b>1.3 MultiJet [356]</b>	1,3	70	199 B1.000	11.15→	<b>0 281 006 054</b>
<b>500</b>					
<b>1.3 MultiJet [312]</b>	1,3	55	169 A1.000 <M73>	07.07-12.12	<b>0 281 002 980</b>
		70	199 B1.000 <M95>; 312 B1.000	01.10→	<b>0 281 006 054</b>
<b>500C</b>					
<b>1.3 Multijet [312]</b>	1,3	55	169 A1.000	07.09-12.12	<b>0 281 002 980</b>
MultiJet, MultiJet [312]	1,3	70	199 B1.000; 312 B1.000	01.10→	<b>0 281 006 054</b>
<b>500L</b>					
<b>1.3 Multijet [199]</b>	1,3	62/70	199 B4.000 <ECOCF5>; 330 A1.000	09.12→	<b>0 281 006 054</b>
<b>1.6 Multijet [199]</b>	1,6	77/88	199 B5.000; 940 C1.000; 955 A3.000	03.13→	<b>0 281 006 054</b>
<b>500X</b>					
<b>1.6 Multijet [334]</b>	1,6	84-88	55260384	11.14→	<b>0 281 006 054</b>
<b>2.0 Multijet 4x4 [334]</b>	2,0	100-103	5526308...	11.14→	<b>0 281 006 054</b>



**FORD**

<b>Galaxy</b>					
<b>1.9 TDI [00]</b>	1,9	66	ANU <19NPD>	04.00-08.06	<b>0 281 002 757</b>
				WW,XXX	<b>0 986 280 202</b>
		85	AUY <19PPD>	04.00-08.06	<b>0 281 002 757</b>
				WW,XXX	<b>0 986 280 202</b>
		96	ASZ <19PPD>	01.03-08.06	<b>0 281 002 461</b>
		110	BTB <19PPD>	01.05-08.06	<b>0 281 002 461</b>
					<b>0 986 284 007</b>
TDI [95]	1,9	66/81	AFN <D19P (VW 19P)>; AHU <D19N (VW 19N)>; ANU <19NPD>; AVG <D19P (VW 19P)>	09.97-03.00	<b>0 281 002 757</b>
				WW,XXX	<b>0 986 280 202</b>
<b>Ka</b>					
<b>1.3 TDCi [08]</b>	1,3	55	169 A... <Euro4/Euro5>	09.08-10.10	<b>0 281 002 980</b>

**GREAT WALL**

<b>Hover CUV</b>					
<b>2.8 T</b>	2,8	85	GW2.8TCI_EU3	01.04-02.11	<b>0 281 002 900</b>



**HONDA**

<b>Accord Hatchback</b>						
2.0 TDi [CH8]	2,0	77	20T2N		01.99-12.99 GS,TW	0 281 002 120
					01.99-10.00	0 280 218 012
<b>Accord Sedan</b>						
2.0 D Turbo [CF1]	2,0	77	20T2N		09.95-10.98	0 281 002 120
TDi [CH2]	2,0	77	20T2N		01.99-12.99 GS,TW	0 281 002 120
					01.99-02.03	0 280 218 012
<b>Civic Aerodeck</b>						
2.0 D Turbo [MC3]	2,0	77	20T2N		04.98-12.99	0 281 002 120
<b>Civic Fastback</b>						
2.0 D [MB7]	2,0	74-77	20T2N		03.97-02.01	0 281 002 120
<b>Civic Hatchback</b>						
1.7 CTDi [EU7/EP1]	1,7	74	4EE2		01.02-12.05	0 281 002 482

**HYUNDAI**

<b>Accent</b>						
1.5 CRDi [LC]	1,5	57-60	D3-EA		01.02-06.06	0 281 002 528
CRDi [MC, MCT]	1,5	81	D4FA <(1B) U15>		04.06-02.12	0 281 002 723
<b>Accent Hatchback</b>						
1.5 CRDi [LC]	1,5	57-60	D3-EA		01.02-06.06	0 281 002 528
CRDi [MC]	1,5	81	D4FA <(1B) U15>		04.06-02.12	0 281 002 723
<b>Elantra</b>						
1.6 CRDi [HD]	1,6	85	D4FB <(1C) U16>		08.06-06.11	0 281 002 723
2.0 CRDi [XD]	2,0	83	D4EA <(2B) D20>		06.01-08.06	0 281 002 447
<b>Elantra Hatchback</b>						
2.0 CRDi [XD]	2,0	83	D4EA <(2B) D20>		06.01-08.06	0 281 002 447
<b>Getz</b>						
1.5 CRDi [TB]	1,5	60	D3-EA <TCI>		05.03-08.05	0 281 002 528
		65/81	D4FA <TDI>; D4FA-L <TDI>		09.05-06.09	0 281 002 723
<b>Grandeur</b>						
2.2 CRDi [TG]	2,2	110-114	D4EB <(2D) D22>		07.06-11.10	0 281 002 721
<b>ix55</b>						
3.0 V6 CRDi 4x4 [EN]	3,0	176/184	D6EA <(9B) S30>; D6EB <(9C) S32>		04.09-12.12	0 281 002 798
<b>i10</b>						
1.1 CRDi [PA]	1,1	55	D3FA <(1A) U11>		03.08-12.10	0 281 002 723
<b>i20</b>						
1.4 CRDi [PB/PBT]	1,4	55/66	D4FC <(1D) U14/(1G) U142>		10.08-03.12 SSJ	0 281 002 723
1.6 CRDi [PB/PBT]	1,6	85/94	D4FB <(1E) U162>		01.09-03.12	0 281 002 723
<b>i30</b>						
1.6 CRDi [FD/FDH]	1,6	66/81-85/94	D4FB <(1C) U16/ (1E) U162>; D4FB <(1E) U162>		09.07-08.12 TW	0 281 002 723
2.0 CRDi [FD/FDH]	2,0	100-103	D4EA <(2B) D20>		09.07-03.11	0 281 002 721
<b>i30 CW</b>						
1.6 CRDi [FD/FDH]	1,6	66/85/94	D4FB <(1C) U16/ (1E) U162>; D4FB <(1E) U162>		02.08-09.12 TW	0 281 002 723
2.0 CRDi [FD/FDH]	2,0	100-103	D4EA <(2B) D20>		03.08-03.11	0 281 002 721
<b>Matrix</b>						
1.5 CRDi [FC]	1,5	60	D3-EA <TCI>		07.01-01.06	0 281 002 528
		75	D4FA <TDI>		02.05-08.06	0 281 002 669
		81	D4FA-G <TDI>		09.06-04.10	0 281 002 723
<b>Santa Fe</b>						
2.0 CRDi [DM]	2,0	83	D4EA		04.01-12.05	0 281 002 447
CRDi, CRDi 4x4 [SM]	2,0	83	<DOHC>; D4EA <(2B) D20>		06.00-12.05	0 281 002 447
CRDi-VGT 4x4 [SM]	2,0	92-107	D4EA-V		08.03-12.05	0 281 002 721
2.2 CRDi, CRDi 4x4 [CM]	2,2	110-114	D4EB <(2D) D22>		03.06-11.09	0 281 002 721
<b>Sonata</b>						
2.0 CRDi [NF]	2,0	100-105/110	D4EA <(2B) D20>		01.06-12.10	0 281 002 721







◀ HYUNDAI

Terracan						
2.9 CRDi	2,9	128	J3		02.01→	0 281 002 554
CRDi [HP]	2,9	110/120	J3		11.01-10.06	0 281 002 554
Trajet						
2.0 CRDi [FO]	2,0	83-92	D4EA <(2B) D20>		01.01-06.07	0 281 002 447
Trajet XG						
2.0 CRDi	2,0	83	D		10.99→	0 281 002 447
Tucson						
2.0 CRDi, CRDi 4x4 [JM]	2,0	83/100-103/110	D4EA...; D4EA <(2B) D20>		08.04-03.10 TW	0 281 002 600 0 281 002 721

**IVECO**

Massif						
3.0	3,0	107/130	F1CE0481F*..; F1CE0481H*..		06.08-12.12	0 281 006 048

**JAGUAR**

F-Pace						
2.0 D, D AWD [X761]	2,0	132	204PT		04.16→	0 280 218 307
3.0 TDV6 AWD [X761]	3,0	221			04.16→	LAB 0 280 218 307 RAB 0 280 218 286
XE						
2.0 E-performance, 20d	2,0	120/132	204PT		06.15→	0 280 218 307
XJ						
3.0 D V6, D V6 S [X351]	3,0	202/221			08.10→	LAB 0 280 218 307 RAB 0 280 218 286

**JEEP**

Commander						
3.0 CRD 4x4 [XH]	3,0	160-165	EXL		01.06→	0 281 002 896
Compass						
2.0 CRD, CRD 4x4 [MK]	2,0	103	EC...		10.06→	0 281 002 779
Grand Cherokee						
2.7 CRD [WG]	2,7	120	ENF		10.01-12.04	0 281 002 501
3.0 CRD [WH]	3,0	160-165	EXL		03.05-10.11	0 281 002 896
Patriot						
2.0 CRD, CRD 4x4 [MK]	2,0	103	EC...		10.06→	0 281 002 779
Renegade						
1.6 MultiJet	1,6	77/88	55260384		07.14→	0 281 006 054
2.0 MultiJet 4x4	2,0	88/103/125	5526308...; 55263087; 55263088		07.14→	0 281 006 054

**KIA**

Carens						
2.0 CRDi [II]	2,0	85	D4EA		02.02-04.06	0 281 002 447
CRDi, CRDi VGT [FC]	2,0	83/103	D4EA		04.02-08.06	0 281 002 447
CRDi, CRDi VGT [FG]	2,0	85/100/103	D4EA; D4EA-L; D4EA-W		09.06→	0 281 002 721
Carnival						
2.2 CRDi [MB]	2,2	110/143	D4HB <2.2L-R>		10.09-12.12 TW	0 281 002 798
2.9 CRDi [MB]	2,9	136	J3		04.06-12.12	0 281 002 721
CRDi, D Turbo [UP]	2,9	93/106	J3		06.98-06.06	0 281 002 554
Cee'd						
1.6 CRDi [ED/FF2]	1,6	66/85/94	D4FB <1600 U2>; D4FB-L		11.06-12.12 SSJ	0 281 002 723
2.0 CRDi [ED/FF2]	2,0	103	D4EA-F		09.07-12.12	0 281 002 721



Cee'd Sporty Wagon						
1.6 CRDi [ED/FF2]	1,6	66/85/94	D4FB <1600 U2>; D4FB-L	09.07-12.12	SSJ	0 281 002 723
2.0 CRDi [ED/FF2]	2,0	103	D4EA-F	09.07-12.12		0 281 002 721
Cerato						
1.5 CRDi [FE]	1,5	75	D4FA	06.05-11.09	TW	0 281 002 669
						0 281 002 723
1.6 CRDi [FE]	1,6	85	D4FB <1600 U2>	06.05-11.09		0 281 002 723
2.0 CRDi [FE]	2,0	83	D4EA	04.04-11.09		0 281 002 669
Cerato Hatchback						
1.5 CRDi [FE]	1,5	75	D4FA	06.05-11.09	TW	0 281 002 669
						0 281 002 723
1.6 CRDi [FE]	1,6	85	D4FB <1600 U2>	06.05-11.09		0 281 002 723
2.0 CRDi [FE]	2,0	83	D4EA	04.04-11.09		0 281 002 669
Magentis						
2.0 CRDi [GE]	2,0	103/110	D4EA	02.06-04.10		0 281 002 721
Mohave						
3.0 CRDi	3,0	184	<3.0S/3.0S2>	01.09→	EU3	0 281 002 798
Picanto						
1.1 CRDi [BA]	1,1	55	D3FA <1H U2>	11.05-01.11		0 281 002 765
Pro Cee'd						
1.6 CRDi [ED]	1,6	66/85/94	D4FB <1600 U2>; D4FB-FL	03.08-12.12	SSJ	0 281 002 723
2.0 CRDi [ED]	2,0	103	D4EA	03.08-12.12		0 281 002 721
Rio						
1.5 CRDi [JB, DE]	1,5	65/81	D4FA	03.05-09.11		0 281 002 723
Rio Hatchback						
1.5 CRDi [JB, DE]	1,5	65/81	D4FA	03.05-09.11		0 281 002 723
Sedona						
2.9 D Turbo [UP]	2,9	93	J3	06.98-09.01		0 281 002 554
Sorento						
2.5 CRDi	2,5	107	<A2,51Gen>	05.00→		0 281 002 554
CRDi [JC, BL]	2,5	103	D4CB	07.02-08.09		0 281 002 554
		125	D4CB	03.06-08.09	TW	0 281 002 554
						0 281 002 721
Soul						
1.6 CRDi [AM]	1,6	85/94	D4FB <1600 U2>	02.09-07.11		0 281 002 723
Sportage						
2.0 CRDi, CRDi 4x4 [JE]	2,0	83	D4EA	09.04-04.07		0 281 002 600
		100-103	D4EA...; D4EA-V	01.06-04.07		0 281 002 721
		110	D4EA	05.07-05.10	EU3	0 281 002 600
					EU4	0 281 002 721

## LANCIA

Delta						
1.6 MultiJet [844]	1,6	77	844 A3.000; 944 A3.000	04.11→		0 281 006 054
		85	955 A4.000	07.08-12.10		0 281 002 917
				01.11→		0 281 006 054
		88	198 A2.000 <M78>	07.08-12.10		0 281 002 917
				01.11→		0 281 006 054
1.9 MultiJet [844]	1,9	140	844 A1.000 <M94>	08.08→		0 280 218 237
2.0 MultiJet [844]	2,0	120/121	198 A5.000 <M120>; 844 A2.000	08.08-12.10		0 281 002 917
				01.11→		0 281 006 054
Kappa Berlina						
2.4 JTD [838]	2,4	100	838A8.000 <M3>	03.98-12.00		0 280 218 019
TD [838]	2,4	91	838A3.000 <M1>; 838A7.000 <M2>	11.94-03.98		0 281 002 085
Kappa Station Wagon						
2.4 D Turbo [838]	2,4	91	838A7.000 <M2>	06.96-03.98		0 281 002 085
JTD [838]	2,4	100	838A8.000 <M3>	03.98-12.00		0 280 218 019
Lybra Berlina						
1.9 JTD [839]	1,9	77	AR32302 <M1 CF2>	10.99-09.00		0 280 218 019
		80/85	AR37101 <M2 CF3>; 937 A2.000 <M3 CF3>	09.00-11.06		0 281 002 309
2.4 JTD [839]	2,4	98	839A5.000/AR32501 <M6/M5 CF2>	10.99-09.00		0 280 218 019



◀ LANCIA

2.4 JTD [839]	2,4	103	839A6.000 <M7 CF3>	09.00-05.02	<b>0 281 002 309</b>
		110	841C000 <M8 CF3>	06.02-09.03	<b>0 281 002 309</b>
				10.03-09.05	<b>0 280 218 113</b>
<b>Lybra Station Wagon</b>					
1.9 JTD [839]	1,9	77	AR32302 <M1 CF2>	10.99-09.00	<b>0 280 218 019</b>
		80/85	AR37101 <M2 CF3>; 937 A2.000 <M3 CF3>	09.00-11.06	<b>0 281 002 309</b>
2.4 JTD [839]	2,4	98	839A5.000/AR32501 <M6/M5 CF2>	10.99-09.00	<b>0 280 218 019</b>
		103	839A6.000 <M7 CF3>	09.00-05.02	<b>0 281 002 309</b>
		110	841C000 <M8 CF3>	06.02-09.03	<b>0 281 002 309</b>
				10.03-09.05	<b>0 280 218 113</b>
<b>Musa</b>					
1.3 MultiJet [350]	1,3	51-55	188 A9.000 <M30>	10.04-11.10	<b>0 281 002 613</b>
		66	199 A3.000 <M72 (ECOCF4)>	09.05-06.07	<b>0 281 002 792</b>
				07.07-11.10	<b>0 281 002 980</b>
		70	199 B1.000	03.09-12.12	<b>0 281 006 054</b>
1.6 MultiJet [350]	1,6	85/88	350 A2.000; 350 A3.000	10.07-12.12	SSJ <b>0 281 002 917</b>
					SSJ <b>0 281 006 054</b>
1.9 MultiJet [350]	1,9	74	188 B2.000 <M40>	10.04-12.12	<b>0 281 002 683</b>
<b>Thesis</b>					
2.4 JTD 10V [841]	2,4	110	841C.000 <M20>		
			Ricam.Nr →9518	04.02-09.03	<b>0 281 002 309</b>
			Ricam.Nr 9519→	10.03-02.05	<b>0 280 218 113</b>
JTD 20V [841]	2,4	120/129	841G.000 <M24>; 841H.000 <M25>; 841M.000 <M22>; 841N.000 <M23>	06.03-02.06	<b>0 281 002 598</b>
		136	841 P.000 <M99 CF4>	03.06-12.09	<b>0 281 006 048</b>
<b>Ypsilon</b>					
1.3 JTD [843]	1,3	51	188 A9.000 <M15>	06.03-09.06	<b>0 281 002 613</b>
MultiJet [312]	1,3	70	199 B1.000; 312 B1.000	06.11→	<b>0 281 006 054</b>
MultiJet [843]	1,3	55	199 A2.000 <ECOCF4>	09.09-11.10 EU5	<b>0 281 002 917</b>
		55/66/77	199 A2.000 <M73>; 199 A3.000 <M72 (ECOCF4)>;	10.06-10.07 EU4	<b>0 281 002 792</b>
			199 A3.000 <M105>	10.06-11.11 EU5	<b>0 281 002 917</b>
				11.07-11.11 EU4	<b>0 281 002 980</b>



**LAND ROVER GROUP**

<b>Discovery I</b>					
2.5 TDi	2,5	82-90	19L 21L 22L 23L 300	10.93-12.98	<b>0 281 002 092</b>
<b>Discovery Sport</b>					
2.0 TD4 [B5]	2,0	110/132	AJ200 <204DTD>	09.15→	<b>0 280 218 307</b>
<b>Freelander I</b>					
2.0 D [LN]	2,0	70-72	20T2N <L-Serie>	09.97-09.03 EDC	<b>0 281 002 182</b>
TD4 [LN]	2,0	80-82	TD4 204D3	09.01-10.06	<b>0 928 400 520</b>
<b>Range Rover Evoque</b>					
2.0 eD4, TD4 AWD [LV]	2,0	110/132	AJ200 <204DTD>	09.15→	<b>0 280 218 307</b>
<b>Range Rover Evoque Cabrio</b>					
2.0 TD4 AWD	2,0	110/132	AJ200 <204DTD>	03.16→	<b>0 280 218 307</b>
<b>Range Rover IV</b>					
3.0 TD [LG]	3,0	155-190	306DT	02.13→	RAB <b>0 280 218 286</b>
			Fg.-Nr. FA000001→	02.13→	LAB <b>0 280 218 307</b>
			Fg.-Nr. →EA999999	02.13→	LAB <b>0 280 218 286</b>
TD AWD [LG]	3,0	155	306DT	10.13→	<b>0 280 218 307</b>
<b>Range Rover Sport</b>					
3.0 SDV6, TDV6 [LW L494]	3,0	183-190/ 215-225	306DT; 306DTX	09.13→	<b>0 280 218 286</b>

**LUFENG**

<b>Landwind</b>					
2.5 D	2,5	156	VM_EU3	10.06-02.07	<b>0 281 002 951</b>



MERCEDES-BENZ

<b>Serie A</b>					
<b>160</b> CDI	1,7	44	OM 668.941 <DE 17 A>		
			Mot.-Nr. →30210110	09.98-02.01	SFU <b>0 281 002 281</b>
			Mot.-Nr. 30210111→	09.98-02.01	SFU <b>0 281 002 489</b>
CDI [168]	1,7	55	OM 668.940 <DE 17 LA>		
			Mot.-Nr. →30210110	03.01-08.04	SFU <b>0 281 002 281</b>
			Mot.-Nr. 30210111→	03.01-08.04	SFU <b>0 281 002 489</b>
<b>170</b> CDI [168]	1,7	66/70	OM 668.940 <DE 17 LA>; OM 668.942 <DE 17 LA>		
			Mot.-Nr. →30210110	07.98-08.04	SFU <b>0 281 002 281</b>
			Mot.-Nr. 30210111→	07.98-08.04	SFU <b>0 281 002 489</b>
<b>Serie C</b>					
<b>30 AMG</b> CDI [203]	3,0	170	OM 612.990 <DE 30 LA AMG>	01.03-08.04	<b>0 281 002 535</b>
<b>200</b> CDI [202]	2,2	75	OM 611.960 <DE LA>		
			Mot.-Nr. →30 055905	03.98-04.00	<b>0 280 217 114</b>
			Mot.-Nr. 30 055906→	03.98-04.00	<b>0 281 002 384</b>
CDI [203]	2,2	75/90	OM 646.962 <DE 22 LA>; OM 646.963 <DE 22 LA>	03.03-07.07	<b>0 281 002 535</b>
CDI [204]	2,1	100	OM 651.913 <D 22 LHD RED>		
			Komp.Nr. 064	04.08-12.14	TW <b>0 281 002 535</b>
	2,2	100	OM 646.811... <DE 22 LA LL>	01.07-12.10	<b>0 281 002 535</b>
<b>220</b> CDI [202]	2,2	92	OM 611.960 <DE LA>		
			Mot.-Nr. →30 055905	12.97-04.00	<b>0 280 217 114</b>
			Mot.-Nr. 30 055906→	12.97-04.00	<b>0 281 002 384</b>
CDI [203]	2,2	105-110	OM 646.963 <DE 22 LA>	03.03-02.07	<b>0 281 002 535</b>
CDI [204]	2,2	120-125	OM 646.811 <DE 22 LA LL>	03.07-04.09	<b>0 281 002 535</b>
<b>250 D</b> Turbo [202]	2,5	110	OM 605.960 <AD 25 LA>	09.95-04.00	<b>0 280 217 114</b>
<b>300</b> CDI 4MATIC [204]	3,0	170	OM 642.832 <D 30>	03.11-12.14	<b>0 281 002 954</b>
<b>350</b> CDI, CDI 4MATIC [204]	3,0	170/195	OM 642.830 <D 30>; OM 642.832 <D 30>; OM 642.834	10.09-12.14	<b>0 281 002 954</b>
<b>Serie C (Sportcoupe)</b>					
<b>30 AMG</b> CDI [203]	3,0	170	OM 612.990 <DE 30 LA AMG>	09.02-08.04	<b>0 281 002 535</b>
<b>200</b> CDI [203]	2,2	90	OM 646.963 <DE 22 LA>	03.03-02.08	<b>0 281 002 535</b>
<b>220</b> CDI [203]	2,2	110	OM 646.963 <DE 22 LA>	03.03-02.08	<b>0 281 002 535</b>
<b>Serie C (T-Modell)</b>					
<b>30 AMG</b> CDI [203]	3,0	170	OM 612.990 <DE 30 LA AMG>	01.03-08.04	<b>0 281 002 535</b>
<b>200</b> CDI [202]	2,2	75	OM 611.960 <DE LA>		
			Mot.-Nr. →30 055905	03.98-02.01	<b>0 280 217 114</b>
			Mot.-Nr. 30 055906→	03.98-02.01	<b>0 281 002 384</b>
CDI [203]	2,2	75/90	OM 646.962 <DE 22 LA>; OM 646.963 <DE 22 LA>	03.03-08.07	<b>0 281 002 535</b>
CDI [204]	2,1	100	OM 651.913 <D 22 LHD RED>	01.11-12.14	TW <b>0 281 002 535</b>
			Komp.Nr. 064		
	2,2	100	OM 646.811 <DE 22 LA LL>	09.07-10.09	<b>0 281 002 535</b>
<b>220</b> CDI [202]	2,2	92	OM 611.960 <DE LA>		
			Mot.-Nr. →30 055905	12.97-02.01	<b>0 280 217 114</b>
			Mot.-Nr. 30 055906→	12.97-02.01	<b>0 281 002 384</b>
CDI [203]	2,2	110	OM 646.963 <DE 22 LA>	03.03-08.07	<b>0 281 002 535</b>
CDI [204]	2,2	125	OM 646.811 <DE 22 LA LL>	09.07-03.09	<b>0 281 002 535</b>
<b>250 D</b> Turbo [202]	2,5	110	OM 605.960 <AD 25 LA>	05.96-02.01	<b>0 280 217 114</b>
<b>300</b> CDI 4MATIC [204]	3,0	170	OM 642.832 <D 30>	09.11-12.14	<b>0 281 002 954</b>
<b>350</b> CDI, CDI 4MATIC [204]	3,0	170/195	OM 642.832 <D 30>; OM 642.834	10.09-12.14	<b>0 281 002 954</b>
<b>Serie CLC</b>					
<b>200</b> CDI [203]	2,2	90	OM 646.963 <DE 22 LA>	03.08-05.10	<b>0 281 002 535</b>
<b>220</b> CDI [203]	2,2	110	OM 646.963 <DE 22 LA>	03.08-05.10	<b>0 281 002 535</b>
<b>Serie CLK (Coupé)</b>					
<b>220</b> CDI [209]	2,1	100-110	OM 646.966 <DE 22 LA>	04.05-04.09	<b>0 281 002 535</b>
<b>Serie CLS (Coupé)</b>					
<b>350</b> BlueTec, CDI, CDI 4MATIC [218]	3,0	185-190/195	OM 642.85... <D 30>; OM 642.853 <D 30>; OM 642.854 <D 30>	10.10→	<b>0 281 002 954</b>
<b>Serie CLS (Shooting Brake)</b>					
<b>350</b> CDI, CDI 4MATIC [218]	3,0	195	OM 642.853 <D 30>; OM 642.854 <D 30>	06.12→	<b>0 281 002 954</b>





◀ MERCEDES-BENZ

Serie E						
200 CDI [210]	2,1	85	OM 611.961 <DE LA>		08.99-08.99	0 281 002 152
200 CDI [210]	2,2	75	OM 611.961 <DE LA>		07.98-08.99	0 281 002 152
CDI [211]	2,1	75/90/100	OM 646.82... <DE 22 LA LL>; OM 646.951 <DE 22 LA>		07.02-03.09	0 281 002 535
220 CDI [210]	2,1	100-105	OM 611.961 <DE LA>		08.99-08.99	0 281 002 152
	2,2	92	OM 611.961 <DE LA>		07.98-07.99	0 281 002 152
CDI [211]	2,1	100/110/120-125	OM 646.821 <DE 22 LA LL>; OM 646.961 <DE 22 LA>		03.02-03.09	0 281 002 535
270 CDI [211]	2,7	120-130	OM 647.961 <DE 27 LA>		03.02-03.05	0 281 002 535
280 CDI [211]	3,2	130	OM 648.961 <DE 32 LA>		04.04-03.05	0 281 002 535
290 D Turbo [210]	2,9	95	OM 602.982 <DE LA>		01.96-07.99	0 280 217 509
300 BlueTec, CDI [212]	3,0	170	OM 642.850 <D 30>; OM 642.852 <D 30>		07.10→	0 281 002 954
D Turbo [210]	3,0	130	OM 606.962 <D 30>		03.97-07.99	0 281 002 152
320 CDI [211]	3,2	150	OM 648.961 <DE 32 LA>		11.02-08.06	0 281 002 535
350 BlueTec, CDI 4MATIC [212]	3,0	170/185-190/195	OM 642.852 <D 30>; OM 642.856 <D 30>; OM 642.858 <D 30>		04.09→	0 281 002 954
BlueTec 4MATIC [212]	3,0	185-190	OM 642.85... <D 30>		08.12→	0 281 002 954
CDI [212]	3,0	170	OM 642.850 <D 30>		08.08-11.10	0 281 002 954
Serie E (Cabrio)						
350 BlueTec, CDI [207]	3,0	185-190/195	OM 642.838 <D 30>		04.11→	0 281 002 954
Serie E (Coupé)						
350 BlueTec, CDI [207]	3,0	170/185-190/195	OM 642.836 <D 30>; OM 642.838 <D 30>		02.09→	0 281 002 954
Serie E (T-Modell)						
200 CDI [211]	2,1	100	OM 646.821 <DE 22 LA LL>		04.07-08.09	0 281 002 535
220 CDI [210]	2,1	100-105	OM 611.961 <DE LA>		08.99-08.99	0 281 002 152
	2,2	92	OM 611.961 <DE LA>		07.98-07.99	0 281 002 152
CDI [211]	2,1	100/110/125	OM 646.821 <DE 22 LA LL>; OM 646.961 <DE 22 LA>		02.03-08.09	0 281 002 535
270 CDI [211]	2,7	120-130	OM 647.961 <DE 27 LA>		02.03-03.05	0 281 002 535
280 CDI [211]	3,2	130	OM 648.961 <DE 32 LA>		04.04-03.05	0 281 002 535
290 D Turbo [210]	2,9	95	OM 602.982 <DE LA>		05.96-07.99	0 280 217 509
300 BlueTec, CDI [212]	3,0	170	OM 642.852 <D 30>		08.11→	0 281 002 954
D Turbo [210]	3,0	130	OM 606.962 <D 30>		03.97-07.99	0 281 002 152
D Turbo 4MATIC [124]	3,0	105-108	OM 603.963		07.93-05.96	0 281 002 024
						0 281 002 028
320 CDI [211]	3,2	150	OM 648.961 <DE 32 LA>		02.03-03.05	0 281 002 535
350 BlueTec, BlueTec 4MATIC, CDI [212]	3,0	170/185-190/195	OM 642.85... <D 30>; OM 642.850 <D 30>; OM 642.852 <D 30>		08.09→	0 281 002 954
CDI 4MATIC [212]	3,0	170/195	OM 642.856 <D 30>; OM 642.858 <D 30>		08.09-11.10	0 281 002 954
					12.10→	0 281 002 954
Serie G						
280 CDI [461]	3,0	135	OM 642.884 <OM642>		04.09→	0 281 002 896
Serie GL						
350 BlueTec 4MATIC [166]	3,0	190	OM 642.826 <D 30>		08.12→	0 281 002 954
CDI 4MATIC [164]	3,0	195	OM 642.822 <D 30>		09.10-12.12	0 281 002 954
Serie GLE						
350 d 4MATIC [166]	3,0	190	OM 642.826 <D 30>		04.15→	0 281 002 954
Serie GLE (Coupé)						
350 d 4MATIC [292]	3,0	190	OM 642.826 <D 30>		04.15→	0 281 002 954
Serie GLK						
350 CDI 4MATIC [204]	3,0	195	OM 642.835 <D 30>		03.12→	0 281 002 954
Serie ML						
300 CDI 4MATIC [164]	3,0	150	OM 642.820 <D 30>		05.09-07.11	0 281 002 954
350 BlueTec 4MATIC [166]	3,0	190	OM 642.826 <D 30>		06.11→	0 281 002 954
BlueTec 4MATIC, CDI 4MATIC [164]	3,0	155/170	OM 642.820 <D 30>		05.09-08.11	0 281 002 954
Serie R						
300 CDI [251]	3,0	140	OM 642... <D 30>		05.10-10.12	0 281 002 954
350 CDI 4MATIC [251]	3,0	195	OM 642.872 <D 30>		05.10-10.12	0 281 002 954
Serie S						
320 CDI [220]	3,2	150	OM 648.960 <DE 32 LA>		09.02-08.05	0 281 002 535





<b>350</b> BlueTec, BlueTec 4MATIC [221]	3,0	190	OM 642.862 <D 30>; OM 642.868 <D 30>	07.10-12.13	<b>0 281 002 954</b>
BlueTec, BlueTec 4MATIC [222]	3,0	185-190	OM 642.861 <D 30>; OM 642.867 <D 30>	05.13→	<b>0 281 002 954</b>
<b>350</b> D Turbo [140]	3,5	100-110	OM 603.971	09.93-06.96	<b>0 281 002 077</b>
<b>Vaneo</b>					
<b>1.7</b> CDI [414]	1,7	55/67	OM 668.914 <DE 17 LA> Mot.-Nr. →30210110	02.02-08.05 SFU 02.02-08.05 SFU	<b>0 281 002 489</b> <b>0 281 002 281</b>

## MG

<b>MG 6</b>					
<b>1.9</b> DTI	1,8	110		09.12→	<b>0 281 006 314</b>
<b>ZR</b>					
<b>2.0</b> D Turbo	2,0	74/82	20 T2N <L-Serie>	10.01-05.05	<b>0 280 218 012</b>
<b>ZS</b>					
<b>2.0</b> TD	2,0	74	20 T2N <L-Serie>	10.01-05.05	<b>0 280 218 012</b>
<b>ZT</b>					
<b>135</b> 2.0 CDTi	2,0	96	20 4D 2 <M47R>	10.02-05.05	<b>0 928 400 520</b>
<b>190</b> 2.0 CDT	2,0	85	20 4D 2 <M47R>	10.01-05.05	<b>0 928 400 520</b>
<b>ZT-Tourer</b>					
<b>135</b> 2.0 CDTi	2,0	96	20 4D 2 <M47R>	10.02-05.05	<b>0 928 400 520</b>
<b>190</b> 2.0 CDT	2,0	85	20 4D 2 <M47R>	10.01-05.05	<b>0 928 400 520</b>

## MINI (BMW)

<b>Cooper</b>					
<b>1.6</b> D [R 56]	1,6	82	N47 C16A	08.10-11.13	<b>0 281 006 092</b>
<b>2.0</b> D, SD [R 56]	2,0	82/100-105	N47 C20A	03.11-11.13	<b>0 281 006 092</b>
<b>Cooper Cabrio</b>					
<b>1.6</b> D [R 57]	1,6	82	N47 C16A	09.10-05.15	<b>0 281 006 092</b>
<b>2.0</b> D, SD [R 57]	2,0	82/105	N47 C20A	03.11-05.15	<b>0 281 006 092</b>
<b>Cooper Clubman</b>					
<b>1.6</b> D [R 55]	1,6	82	N47 C16A	09.10-06.14	<b>0 281 006 092</b>
<b>2.0</b> D, SD [R 55]	2,0	82/100-105	N47 C20A	03.11-06.14	<b>0 281 006 092</b>
<b>Cooper Clubvan</b>					
<b>1.6</b> D [R 55]	1,6	82	N47 C16A	02.13-06.14	<b>0 281 006 092</b>
<b>2.0</b> D [R 55]	2,0	82	N47 C20A	02.13-06.14	<b>0 281 006 092</b>
<b>Cooper Countryman</b>					
<b>1.6</b> D, D ALL4 [R 60]	1,6	82	N47 C16A	09.10→	<b>0 281 006 092</b>
<b>2.0</b> D, D ALL4, SD, SD ALL4 [R 60]	2,0	82/100-105	N47 C20A	03.11→	<b>0 281 006 092</b>
<b>Cooper Coupé</b>					
<b>2.0</b> SD [R 58]	2,0	100-105	N47 C20A	09.11-05.15	<b>0 281 006 092</b>
<b>Cooper One</b>					
<b>1.4</b> D [R 50]	1,4	55	1 ND <W17 D14A>	03.03-09.05	<b>0 281 002 621</b>
<b>1.6</b> D [R 56]	1,6	66	N47 C16A	08.10-11.13	<b>0 281 006 092</b>
<b>Cooper One Clubman</b>					
<b>1.6</b> D [R 55]	1,6	66	N47 C16A	09.10-06.14	<b>0 281 006 092</b>
<b>Cooper One Countryman</b>					
<b>1.6</b> D [R 60]	1,6	66	N47 C16A	09.10→	<b>0 281 006 092</b>
<b>Cooper Paceman</b>					
<b>1.6</b> D, D ALL4 [R 61]	1,6	82	N47 C16A	03.13→	<b>0 281 006 092</b>
<b>2.0</b> D, D ALL4, SD, SD ALL4 [R 61]	2,0	82/100-105	N47 C20A	03.13→	<b>0 281 006 092</b>
<b>Cooper Roadster</b>					
<b>2.0</b> SD [R 59]	2,0	100-105	N47 C20A	02.12→	<b>0 281 006 092</b>







**NISSAN**

<b>Almera</b>						
2.2 D Turbo [N16]	2,2	81	YD22DDT		04.00-03.01	0 280 218 005 0 986 280 232
D Turbo [N16E]	2,2	81	YD22DDT		03.01-02.03	0 280 218 005 0 986 280 232
<b>Almera Hatchback</b>						
2.2 D Turbo [N16E]	2,2	81	YD22DDT		01.00-02.03	0 280 218 005 0 986 280 232
<b>Almera Tino</b>						
2.2 D Turbo [V10M]	2,2	81-84	YD22DDTI		05.00-01.03	0 280 218 005 0 986 280 232
<b>Primera</b>						
2.2 D Turbo [P12E]	2,2	93	YD22DDT		12.01-06.04	0 280 218 005 0 986 280 232
<b>Primera Hatchback</b>						
2.0 D Turbo [P11E]	2,0	66	CD20T		10.97-12.01	0 281 002 207 0 986 284 012
2.2 D Turbo [P12E]	2,2	93	YD22DDT		05.02-06.04	0 280 218 005 0 986 280 232
<b>Primera Sedan</b>						
2.0 D Turbo [P11E]	2,0	66	CD20T		10.97-12.01	0 281 002 207 0 986 284 012
<b>Primera Wagon</b>						
2.0 D Turbo [WP11E]	2,0	66	CD20T		01.98-12.01	0 281 002 207 0 986 284 012
2.2 D Turbo [P12E]	2,2	93	YD22DDT		12.01-06.04	0 280 218 005 0 986 280 232
<b>Terrano II</b>						
2.7 D Turbo 4x4 [R20]	2,7	91-92	TD27Ti		10.00-02.02 GS	0 281 002 207 0 986 284 012
					GS,WW	0 281 002 440
					03.02-05.03	0 281 002 594
					06.03-12.06	0 281 002 597
					10.97-12.06 GS	0 281 002 207 0 986 284 012
11.98→	0 281 002 207 0 986 284 012					
3.0 D Turbo 4x4 [R20]	3,0	113	ZD30		02.02-12.04	0 281 002 594

**OPEL**

<b>Agila</b>						
1.3 CDTI [A]	1,3	51	Z 13 DT <Ecotec>		08.03-02.08	0 281 002 619
CDTI [B]	1,2	55	D 13 A; Z 13 DTJ		03.08→	0 281 002 862
<b>Antara</b>						
2.0 CDTI, CDTI 4x4	2,0	93/110	Z 20 DM; Z 20 DMH		05.06-12.11	0 281 002 683
<b>Astra</b>						
1.3 CDTI [H]	1,2	66	Z 13 DTH <Ecotec>		08.05-03.10	0 281 002 683
CDTI [J]	1,2	66-70	A 13 DTE <ecoFLEX>		09.09→	0 281 002 940
1.6 CDTI [J]	1,6	81/100	B 16 DTH; B 16 DTL		12.13→	0 280 218 254
CDTI, i [K]	1,6	70/81/100/118	B 16 DTE; B 16 DTH; B 16 DTR; B 16 DTU		09.15→	0 280 218 254
1.7 CDTI [G]	1,7	59	Z 17 DTL <Turbo Ecotec>		03.03-01.04	0 281 002 549
CDTI [H]	1,7	59	Z 17 DTL <Turbo Ecotec>		03.04-09.05	0 281 002 683
			74 Z 17 DTH		03.04-08.07	0 281 002 683
			81 Z 17 DTJ <Ecotec>		02.07-03.10	0 281 002 832
			81/92 A 17 DTJ <Ecotec>; A 17 DTR <Ecotec>		02.07→	0 281 002 832
			92 Z 17 DTR <Turbo Ecotec>		02.07-03.10	0 281 002 832
CDTI [J]	1,7	74/81/92/96	A 17 DTE <ecoFlex>; A 17 DTF <ecoFlex>; A 17 DTJ <Ecotec>; A 17 DTL; A 17 DTR <Ecotec>		09.09→	0 281 002 940
			81 A 17 DTC <Ecotec>		07.11→	0 281 002 940
					09.12→	0 280 218 254
			96 A 17 DTS <Ecotec>		07.11→	0 281 002 940
					09.12→	0 280 218 254
DT, DTI [G]	1,7	50/55	X 17 DTL; Y 17 DT <Turbo>		03.98-01.04	0 281 002 180
1.9 CDTI [H]	1,9	74/88/110	Z 19 DT <Ecotec>; Z 19 DTH <Ecotec>; Z 19 DTL <Ecotec>		04.04-03.10	0 281 002 683
2.0 CDTI [J]	2,0	118/121/143	A 20 DTH <ecoFlex>; A 20 DTR <Ecotec>		09.09→	0 281 002 912
DT [G]	2,0	60	X 20 DTL <Ecotec 16V Turbo>		03.98-08.00	0 281 002 180





2.0 DTI [G]	2,0	74	Y 20 DTH <Ecotec> Fg.-Nr. →Y2999999 →Y5999999 →Y6999999 →Y8999999 →YH999999	09.99-01.05	<b>0 281 002 180</b>
			Fg.-Nr. 12000001→22999999 15000001→25999999 16000001→26999999 18000001→28999999 1H000001→2B999999 →2H999999	09.99-01.05	<b>0 281 002 428</b>
			Fg.-Nr. 32000001→ 35000001→ 36000001→ 38000001→ 3B000001→ 3H000001→	09.99-01.05	<b>0 281 002 478</b>
DTL [G]	2,0	60	Y 20 DTL <Turbo> Fg.-Nr. →Y2999999 →Y5999999 →Y6999999 →Y8999999 →YH999999	09.00-01.04	<b>0 281 002 180</b>
			Fg.-Nr. 12000001→ 15000001→ 16000001→ 18000001→ 1H000001→	09.00-01.04	<b>0 281 002 428</b>
2.2 DTI [G]	2,2	92	Y 22 DTR <Ecotec>	09.01-01.04	<b>0 281 002 478</b>
<b>Astra Cabrio</b>					
1.7 CDTI [G]	1,7	59	Z 17 DTL <Turbo Ecotec>	03.03-08.05	<b>0 281 002 549</b>
2.2 DTI [G]	2,2	92	Y 22 DTR <Ecotec>	03.02-08.05	<b>0 281 002 478</b>
<b>Astra Caravan</b>					
1.3 CDTI [H]	1,2	66	Z 13 DTH <Ecotec>	08.05-03.10	<b>0 281 002 683</b>
1.7 CDTI [G]	1,7	59	Z 17 DTL <Turbo Ecotec>	03.03-07.09	<b>0 281 002 549</b>
CDTI [H]	1,7	59	Z 17 DTL <Turbo Ecotec>	08.04-09.05	<b>0 281 002 683</b>
		74	Z 17 DTH	08.04-03.07	<b>0 281 002 683</b>
		81	Z 17 DTJ <Ecotec>	02.07-03.10	<b>0 281 002 832</b>
		81/92	A 17 DTJ <Ecotec>; A 17 DTR <Ecotec>	02.07→	<b>0 281 002 832</b>
		92	Z 17 DTR <Turbo Ecotec>	02.07-03.10	<b>0 281 002 832</b>
DT, DTI [G]	1,7	50/55	X 17 DTL; Y 17 DT <Ecotec Turbo>	03.98-06.04	<b>0 281 002 180</b>
1.9 CDTI [H]	1,9	74/88/ 110	Z 19 DTL <Ecotec>; Z 19 DTH <Ecotec>; Z 19 DTL <Ecotec>	09.04-07.10	<b>0 281 002 683</b>
2.0 DT [G]	2,0	60	X 20 DTL <Ecotec 16V Turbo>	03.98-08.00	<b>0 281 002 180</b>
DTI [G]	2,0	74	Y 20 DTH <Ecotec> Fg.-Nr. →Y2999999 →Y5999999 →Y6999999 →Y8999999 →YH999999	09.00-06.04	<b>0 281 002 180</b>
			Fg.-Nr. 12000001→22999999 15000001→25999999 16000001→26999999 18000001→28999999 1H000001→2B999999 →2H999999	09.00-06.04	<b>0 281 002 428</b>
			Fg.-Nr. 32000001→ 35000001→ 36000001→ 38000001→ 3B000001→ 3H000001→	09.00-06.04	<b>0 281 002 478</b>
DTL [G]	2,0	60	Y 20 DTL <Turbo> Fg.-Nr. →Y2999999 →Y5999999 →Y6999999 →Y8999999 →YH999999	09.00-06.04	<b>0 281 002 180</b>
			Fg.-Nr. 12000001→ 15000001→ 16000001→ 18000001→ 1H000001→	09.00-06.04	<b>0 281 002 428</b>
2.2 DTI [G]	2,2	92	Y 22 DTR <Ecotec>	09.01-06.04	<b>0 281 002 478</b>
<b>Astra Coupé</b>					
1.7 CDTI [G]	1,7	59	Z 17 DTL <Turbo Ecotec>	03.03-02.05	<b>0 281 002 549</b>
2.2 DTI [G]	2,2	92	Y 22 DTR <Ecotec>	03.02-02.05	<b>0 281 002 478</b>
<b>Astra GTC</b>					
1.3 CDTI [H]	1,2	66	Z 13 DTH <Ecotec>	06.05-02.09	<b>0 281 002 683</b>
1.6 CDTI [J]	1,6	81/100	B 16 DTH; B 16 DTL	06.14→	<b>0 280 218 254</b>
1.7 CDTI [H]	1,7	59	Z 17 DTL <Turbo Ecotec>	03.05-03.07	<b>0 281 002 683</b>
		74	Z 17 DTH	09.05-03.07	<b>0 281 002 683</b>
		81	A 17 DTJ <Ecotec>	10.09-12.12	<b>0 281 002 832</b>
			Z 17 DTJ <Ecotec>	02.07-09.09	<b>0 281 002 832</b>
		92	A 17 DTR <Ecotec>	02.07-03.09	<b>0 281 002 832</b>
			Z 17 DTR <Turbo Ecotec>	02.07-03.09	<b>0 281 002 832</b>
CDTI [J]	1,7	81	A 17 DTC <Ecotec>	11.11→	<b>0 280 218 254</b>
		81/96	A 17 DTE <ecoFlex>; A 17 DTF <ecoFlex>	11.11→	<b>0 281 002 940</b>
		96	A 17 DTS <Ecotec>	11.11→	<b>0 280 218 254</b>





◀ OPEL

1.9 CDTI [H]	1,9	74/88/110	Z 19 DT <Ecotec>; Z 19 DTH <Ecotec>; Z 19 DTJ <Turbo Ecotec>; Z 19 DTL <Ecotec>	03.05-07.10		<b>0 281 002 683</b>
2.0 CDTI [J]	2,0	96/121/143	A 20 DTH <ecoFlex>; A 20 DTR <Ecotec>; Z 20 DTJ	09.11→		<b>0 281 002 912</b>
<b>Astra Sports Tourer</b>						
1.3 CDTI [J]	1,2	67-70	A 13 DTE <ecoFLEX>	09.10→		<b>0 281 002 940</b>
1.6 [K]	1,6	70/81/100/118	B 16 DTE; B 16 DTH; B 16 DTR; B 16 DTU	02.16→		<b>0 280 218 254</b>
CDTI [J]	1,6	81/100	B 16 DTH; B 16 DTL	10.13→		<b>0 280 218 254</b>
1.7 CDTI [J]	1,7	74	A 17 DTN	04.13→		<b>0 280 218 254</b>
		74/81/96	A 17 DTC <Ecotec>; A 17 DTE <ecoFlex>; A 17 DTF <ecoFlex>; A 17 DTJ <Ecotec>; A 17 DTL	09.10→		<b>0 281 002 940</b>
		92/96	A 17 DTR <Ecotec>; A 17 DTS <Ecotec>	09.10→		<b>0 281 002 940</b>
2.0 CDTI [J]	2,0	118/121/143	A 20 DTH <ecoFlex>; A 20 DTR <Ecotec>	09.10→		<b>0 281 002 912</b>
<b>Astra TwinTop</b>						
1.9 CDTi [H]	1,9	110	Z 19 DTH <Ecotec>	09.05-10.10		<b>0 281 002 683</b>
<b>Cascada</b>						
2.0 CDTI	2,0	121/143/125	A 20 DTH <ecoFlex>; A 20 DTR <Ecotec> B 20 DTH	03.13→ 09.15→		<b>0 281 002 912</b> <b>0 280 218 254</b>
<b>Combo</b>						
1.3 CDTI [D]	1,2	66	A 13 FD <ecoFLEX>	02.12→	SSJ	<b>0 281 002 792</b>
					SSJ	<b>0 281 002 980</b>
CDTI [Tour]	1,3	51/55	Y 13 DT <Ecotec>; Z 13 DT <Ecotec> Z 13 DTJ <Ecotec>	09.04-09.07 10.05-01.12		<b>0 281 002 549</b> <b>0 281 002 683</b>
1.6 CDTI [D]	1,6	66/74/77	A 16 FDH <ecoFLEX>; A 16 FDL <ecoFLEX>	02.12→	SSJ	<b>0 281 002 917</b>
					SSJ	<b>0 281 002 980</b>
1.7 CDTI [Tour]	1,7	74	Z 17 DTH	09.04-01.11		<b>0 281 002 549</b>
DI, DTI [Tour]	1,7	48/55	Y 17 DT <Turbo>; Y 17 DTL	10.01-08.04		<b>0 281 002 180</b>
2.0 CDTI [D]	2,0	99	A 20 FD <ecoFLEX>	02.12→		<b>0 281 002 980</b>
<b>Corsa</b>						
1.3 [E]	1,2	55/70	B 13 DTC; B 13 DTE; B 13 DTR	10.14→		<b>0 280 218 254</b>
CDTI [C]	1,3	51/55	Y 13 DT <Ecotec>; Z 13 DT <Ecotec> Z 13 DTJ <Ecotec>	09.03-09.06 09.05-09.06		<b>0 281 002 549</b> <b>0 281 002 683</b>
CDTI [D]	1,2	55/66/55/70	Z 13 DTH <Ecotec>; Z 13 DTJ <Ecotec> A 13 DT...; A 13 DTC <Ecotec>	07.06-07.10 10.10→		<b>0 281 002 683</b> <b>0 281 002 940</b>
		66/70	A 13 DTH <Ecotec> Z 13 DTE	10.06-02.09 12.09-09.10		<b>0 281 002 683</b> <b>0 281 002 940</b>
1.7 CDTI [C]	1,7	74	Z 17 DTH	09.03-09.06		<b>0 281 002 549</b>
CDTI [D]	1,7	92/96	A 17 DTR <Ecotec> Z 17 DTR <Turbo Ecotec> A 17 DTS <Ecotec>	07.06-02.09 07.06-06.10 12.09→		<b>0 281 002 832</b> <b>0 281 002 832</b> <b>0 281 002 940</b>
DI, DTi, DTI [C]	1,7	48/55	Y 17 DT; Y 17 DTL	09.00-12.05		<b>0 281 002 180</b>
<b>Frontera</b>						
2.2 DTI [B]	2,2	85/88	X 22 DTH <Turbo> Y 22 DTH <Turbo>	09.98-10.02 09.02-09.04		<b>0 281 002 184</b> <b>0 281 002 479</b>
2.5 TDS Turbo [A]	2,5	85	VM 41 B <Venturi-25TD>	06.96-08.98		<b>0 281 002 144</b>
<b>Insignia</b>						
1.6 [68]	1,6	88/100	B 16 DTH; B 16 DTJ	09.15→		<b>0 281 002 912</b>
[69]	1,6	88/100	B 16 DTH; B 16 DTJ	07.15→		<b>0 281 002 912</b>
2.0 CDTI, CDTI 4x4 [68]	2,0	81/88/96/103/118/125/140-143	A 20 DT... <ecoFlex>; A 20 DT... <Ecotec>; A 20 DTE; A 20 DTH <ecoFlex>; A 20 DTR <Ecotec>; B 20 DTH	09.08→		<b>0 281 002 912</b>
CDTI, CDTI 4x4 [69]	2,0	81/88/96/103/118/125/140-143	A 20 DT... <ecoFlex>; A 20 DT... <Ecotec>; A 20 DTE; A 20 DTH <ecoFlex>; A 20 DTR <Ecotec>; B 20 DTH	09.08→		<b>0 281 002 912</b>
<b>Insignia Sports Tourer</b>						
1.6 [35]	1,6	88/100	B 16 DTH; B 16 DTJ	07.15→		<b>0 281 002 912</b>





2.0 CDTI, CDTI 4x4 [35]	2,0	81/88/96/103/118/125/140-143	A 20 DT... <ecoFlex>; A 20 DT... <Ecotec>; A 20 DTE; A 20 DTH <ecoFlex>; A 20 DTR <Ecotec>; B 20 DTH	02.09→	0 281 002 912
<b>Meriva</b>					
1.3 CDTI [A]	1,3	51/55	Y 13 DT <Ecotec>; Z 13 DT <Ecotec>; Z 13 DTJ <Ecotec>	04.05-03.10 09.03-03.10	0 281 002 620 0 281 002 802
CDTI [B]	1,2	55/70	A 13 DTC <Ecotec>; A 13 DTE <ecoFLEX>	04.10→	0 281 002 940
1.6 CDTI [B]	1,6	70/81/100	B 16 DTC; B 16 DTH; B 16 DTL	10.13→	0 280 218 254
1.7 CDTI [A]	1,7	74/92	Z 17 DTH Z 17 D... <Turbo Ecotec>	09.03-09.09 09.06-03.10	0 281 002 620 0 281 002 830
CDTI [B]	1,7	74/81/96	A 17 DT <Ecotec>; A 17 DTC <Ecotec>; A 17 DTI; A 17 DTS <Ecotec>	06.10→	0 281 002 940
DTI [A]	1,7	55	Y 17 DT <Turbo (EE4)>	03.03-09.05	0 281 002 579
<b>Mokka</b>					
1.6 , 4x4	1,6	100	B 16 DTH	02.15→	0 281 006 311
1.7 CDTI ecoFLEX, CDTI ecoFLEX 4x4	1,7	96	A 17 DTS <Ecotec>	09.12→	0 281 006 311
<b>Omega</b>					
2.0 DTI Turbo [B]	2,0	74	X 20 DTH	09.97-08.00	0 281 002 180
2.2 DTI [B]	2,2	88	Y 22 DTH <Turbo>	06.00-07.03	0 281 002 428
2.5 DTI Turbo [B]	2,5	110	Y 25 TD	06.01-09.03	0 281 002 564
<b>Signum</b>					
1.9 CDTI	1,9	74/88/110	Z 19 DT <Ecotec>; Z 19 DTH <Ecotec>; Z 19 DTL <Ecotec>	04.04-09.08	0 281 002 683
2.0 DTI	2,0	74	Y 20 DTH <Ecotec>	05.03-09.05	0 281 002 479
2.2 DTI	2,2	86-92	Y 22 DTR <Ecotec>	05.03-09.05	0 281 002 479
3.0 CDTI	3,0	130-135	Y 30 DT <Ecotec>; Z 30 DT <Ecotec>	05.03-09.05 09.05-09.08	0 281 002 605 0 281 002 773
<b>Sintra</b>					
2.2 TD	2,2	85	X 22 DTH <Turbo>	09.97-09.99	0 281 002 184
<b>Tigra TwinTop</b>					
1.3 CDTI [B]	1,3	51	Z 13 DT <Ecotec>	06.04-03.09	0 281 002 549
<b>Vectra</b>					
1.9 CDTI, CDTI GTS [C]	1,9	74/88/110	Z 19 DT <Ecotec>; Z 19 DTH <Ecotec>; Z 19 DTL <Ecotec>	04.04-10.08	0 281 002 683
2.0 DI [B]	2,0	60	X 20 DTL <Ecotec 16V Turbo>		
			Fg.-Nr. W1000001→	09.96-08.02	0 281 002 180
			Fg.-Nr. →V7999999	09.96-08.02	0 281 002 139
DTI [B]	2,0	74	X 20 DTH Y 20 DTH <Ecotec>	09.97-08.03 09.00-09.03	0 281 002 180 0 281 002 428
DTI, DTI GTS [C]	2,0	74	Y 20 DTH <Ecotec>	04.02-09.05	0 281 002 479
2.2 DTI [B]	2,2	92	Y 22 DTR <Ecotec>	09.00-09.03	0 281 002 428
DTI, DTI GTS [C]	2,2	86-92	Y 22 DTR <Ecotec>	04.02-09.05	0 281 002 479
3.0 CDTI, CDTI GTS [C]	3,0	130/135	Y 30 DT <Ecotec>; Z 30 DT <Ecotec>	03.03-08.05 08.05-10.08	0 281 002 605 0 281 002 773
<b>Vectra Caravan</b>					
1.9 CDTI [C]	1,9	74/88/110	Z 19 DT <Ecotec>; Z 19 DTH <Ecotec>; Z 19 DTL <Ecotec>	04.04-10.08	0 281 002 683
2.0 DI [B]	2,0	60	X 20 DTL <Ecotec 16V Turbo>		
			Fg.-Nr. W1000001→	09.96-08.00	0 281 002 180
			Fg.-Nr. →V7999999	09.96-08.00	0 281 002 139
DTI [B]	2,0	74	X 20 DTH Y 20 DTH <Ecotec>	09.97-08.03 09.00-09.03	0 281 002 180 0 281 002 428
DTI [C]	2,0	74	Y 20 DTH <Ecotec>	09.03-09.05	0 281 002 479
2.2 DTI [B]	2,2	92	Y 22 DTR <Ecotec>	09.00-09.03	0 281 002 428
DTI [C]	2,2	86-92	Y 22 DTR <Ecotec>	09.03-09.05	0 281 002 479
3.0 CDTI [C]	3,0	130/135	Y 30 DT <Ecotec>; Z 30 DT <Ecotec>	09.03-08.05 08.05-10.08	0 281 002 605 0 281 002 773
<b>Zafira</b>					
1.6 CDTI [C]	1,6	88/100	B 16 DTH; B 16 DTL	05.13→	0 280 218 254
1.7 CDTI [B]	1,7	81/92	A 17 DTJ <Ecotec>; A 17 DTR <Ecotec>; Z 17 DTJ <Ecotec>; Z 17 DTR <Turbo Ecotec>	03.08→	0 281 002 832





◀ OPEL

<b>2.0 CDTI [C]</b>	2,0	81/96/121/143	A 20 DT <ecoFlex>; A 20 DTH <ecoFlex>; A 20 DTL <Ecotec>; A 20 DTR <Ecotec>	01.12→	<b>0 281 002 912</b>
		96	Z 20 DTJ	03.12→	<b>0 281 002 912</b>
		96/125	B 20 DTH; B 20 DTJ	02.15→	<b>0 280 218 254</b>
<b>DI [A]</b>	2,0	60	X 20 DTL <Ecotec 16V Turbo>		
			Fg.-Nr. →Y8999999 →YT999999	03.99-08.00	<b>0 281 002 180</b>
			Fg.-Nr. 12000001→1T000001→	03.99-08.00	<b>0 281 002 428</b>
<b>DTI [A]</b>	2,0	74	Y 20 DTH <Ecotec>		
			Fg.-Nr. →Y2999999 →Y5999999	04.99-07.05	<b>0 281 002 180</b>
			→Y6999999 →Y8999999 →YH999999		
			Fg.-Nr. 12000001→22999999	04.99-07.05	<b>0 281 002 428</b>
			15000001→25999999 16000001→26999999		
			18000001→28999999 1H000001→2H999999		
			Fg.-Nr. 32000001→35000001→36000001	04.99-07.05	<b>0 281 002 478</b>
			→38000001→3H000001→3H000001→		
<b>2.2 DTI [A]</b>	2,2	92	Y 22 DTR <Ecotec>	03.02-07.05	<b>0 281 002 478</b>

**PEUGEOT**

<b>Bipper</b>					
<b>1.3 HDi [A9]</b>	1,3	55/59	FHY <F 13DTE6>; FHZ <F13DTE5>	08.10→	<b>0 281 002 917</b>
<b>605</b>					
<b>2.5 D Turbo [Y30]</b>	2,5	94-96	THY <DK5ATE>	07.94-05.99	<b>0 281 002 128</b>

**PIAGGIO**

<b>Porter</b>					
<b>1.2 D</b>	1,2	47	P120	01.11→	<b>0 281 006 178</b>
<b>Porter Maxxi</b>					
<b>1.2 D</b>	1,2	47	P120	01.11→	<b>0 281 006 178</b>

**RENAULT**

<b>Espace IV</b>					
<b>3.0 dCi [JK]</b>	3,0	130/133	P9X 701; P9X 715	11.02→	<b>0 280 218 079</b>
<b>Megane I</b>					
<b>1.9 DTI [X64]</b>	1,9	69	F9Q 730	06.97-02.99	<b>0 281 002 195</b>
<b>Megane I Classic</b>					
<b>1.9 DTI [X64]</b>	1,9	72	F9Q 730	08.97-09.03	<b>0 281 002 195</b>
<b>Vel Satis</b>					
<b>3.0 DCi V6 [BJ]</b>	3,0	130/133	P9X 701; P9X 715	04.02-12.09	<b>0 280 218 079</b>

**ROVER**

<b>Serie 200</b>					
<b>220 SD, SDI</b>	2,0	63/77	20 T2N <L-Serie>; 20T2R		
			Fg.-Nr. YD 471565→	09.95-03.00	<b>0 280 218 012</b>
			Fg.-Nr. →YD 471564	09.95-03.00	<b>0 281 002 120</b>
<b>Serie 400</b>					
<b>420 SD, SDI</b>	2,0	63/77	20 T2N <L-Serie>; 20T2R		
			Fg.-Nr. YD 471064→	10.95-03.00	<b>0 280 218 012</b>
			Fg.-Nr. →YD 471063	10.95-03.00	<b>0 281 002 120</b>
<b>Serie 600</b>					
<b>620 SDi</b>	2,0	77	20 T2N <L-Serie>	03.95-12.98	BO <b>0 281 002 120</b>
<b>Serie 800</b>					
<b>825 TD</b>	2,5	92	VM-425-CLIER	01.96-12.98	<b>0 281 002 120</b>



<b>25</b>					
2.0 IDT	2,0	74/83	20 T2N <L-Serie>		
			Fg.-Nr. YD 471565→	02.00-05.05	<b>0 280 218 012</b>
			Fg.-Nr. →YD 471564	02.00-05.05	<b>0 281 002 120</b>
<b>45</b>					
2.0 iDT	2,0	74/83	20 T2N <L-Serie>		
			Fg.-Nr. YD 471064→	02.00-05.05	<b>0 280 218 012</b>
			Fg.-Nr. →YD 471063	02.00-05.05	<b>0 281 002 120</b>
<b>75</b>					
2.0 CDT, CDTi	2,0	85/96	20 4D 2 <M 47 D 20>	01.99-05.05	<b>0 928 400 520</b>
<b>75 Tourer</b>					
2.0 CDT, CDTi	2,0	85/96	20 4D 2 <M 47 D 20>	01.01-05.05	<b>0 928 400 520</b>

## SAAB (SAAB AUTOMOBILE AB)

<b>9-3</b>					
1.9 TiD [9440]	1,9	88/110	Z 19 DT; Z 19 DTH	09.04-12.10	<b>0 281 002 683</b>
TTiD [9440]	1,9	96/118	A19DTR (130); A19DTR (160)	09.10-06.12	<b>0 281 002 764</b>
		132	Z 19 DTR	02.08-02.11	<b>0 281 002 764</b>
2.2 TiD [9440]	2,2	95	D223L	10.02-08.04	<b>0 281 002 479</b>
16V D Turbo [9400]	2,2	85/92	D223L <X 22 DTH>; D223L <Y 22 DTH>		
			Fg.-Nr. →12020000	03.98-09.02	<b>0 281 002 212</b>
			Fg.-Nr. 12020001→	03.98-09.02	<b>0 281 002 443</b>
<b>9-3 Cabriolet</b>					
1.9 TiD [9440]	1,9	110	Z 19 DTH	01.06-09.10	<b>0 281 002 683</b>
TTiD [9440]	1,9	118	A19DTR (160)	09.10-06.12	<b>0 281 002 764</b>
		132	Z 19 DTR	02.08-02.11	<b>0 281 002 764</b>
<b>9-3 Coupé</b>					
2.2 16V D Turbo [9400]	2,2	92	D223L <Y 22 DTH>		
			Fg.-Nr. →12020000	11.00-09.02	<b>0 281 002 212</b>
			Fg.-Nr. 12020001→	11.00-09.02	<b>0 281 002 443</b>
<b>9-3 Kombi</b>					
1.9 TiD [9440]	1,9	88/110	Z 19 DT; Z 19 DTH	03.05-09.10	<b>0 281 002 683</b>
TTiD [9440]	1,9	96/118	A19DTR (130); A19DTR (160)	09.10-06.12	<b>0 281 002 764</b>
		132	Z 19 DTR	02.08-02.11	<b>0 281 002 764</b>
<b>9-3X</b>					
1.9 TTiD [9440]	1,9	132	Z 19 DTR	03.10-06.12	<b>0 281 002 764</b>
<b>9-5</b>					
1.9 TiD [9600]	1,9	110	Z 19 DTH	09.05-02.10	<b>0 281 002 683</b>
2.0 TiD4, TTiD4, TTiD4 XWD [650]	2,0	118/140	A 20 DTH; A 20 DTR	03.10-06.12	<b>0 281 002 912</b>
2.2 TiD [9600]	2,2	88	D223L	03.02-08.05	<b>0 281 002 538</b>
3.0 TiD [9600]	3,0	130	D308L		
			Fg.-Nr. →330027123 →33029139	09.01-08.05	<b>0 281 002 538</b>
			Fg.-Nr. 330027124 → 33029140→	09.01-08.05	<b>0 281 002 605</b>
<b>9-5 Kombi</b>					
1.9 TiD [9600]	1,9	110/129	Z 19 DTH	01.06-02.10	<b>0 281 002 683</b>
2.2 TiD [9600]	2,2	88	D223L	03.02-08.05	<b>0 281 002 538</b>
3.0 TiD [9600]	3,0	130	D308L		
			Fg.-Nr. →330027123 →33029139	09.01-08.05	<b>0 281 002 538</b>
			Fg.-Nr. 330027124 → 33029140→	09.01-08.05	<b>0 281 002 605</b>

## SEAT

<b>Alhambra</b>					
1.9 TDI [7V8]	1,9	66/81	AFN; AHU		
			Fg.-Nr. 7M..W..507 042→	09.97-02.00	<b>0 281 002 757</b>
				WW,XXX	<b>0 986 280 202</b>
		81	AVG	09.97-02.00	<b>0 281 002 757</b>
TDI [7V9]	1,9	66	ANU	06.00-04.02	<b>0 280 218 023 0 986 280 209</b>
				05.02-03.10	<b>0 281 002 757</b>
		110	BTB	06.05-05.07	<b>0 281 002 461 0 986 284 007</b>













◀ SEAT

1.9 TDI, TDI 4Motion [7V9]	1,9	85	AUY	06.00-04.02	0 280 218 023	0 986 280 209
				05.02-03.10	0 281 002 757	
			BVK	06.05-03.10	0 281 002 531	0 986 284 009
		96	ASZ	11.02-11.08	0 281 002 461	0 986 284 007
2.0 TDI [7V9]	2,0	103	BRT	11.05-03.10	0 281 002 461	0 986 284 007
TDI, TDI 4Drive [710]	2,0	85/100/103/125/130	CFFA; CFFB <D91>; CFFE <DE4>; CFGB <D93>; CFGC <DE2>	05.10→	0 281 002 956	
TDI, TDI 4Drive [711]	2,0	110/135	CUVC <DN4>; CUWA <DK7>	05.15→	0 281 002 956	
<b>Altea</b>						
1.9 TDI [5P1]	1,9	66/77	BJB; BKC; BLS <D3W>; BXE <D3W>; BXF <MF7>	04.04-12.10	0 281 002 531	0 986 284 009
2.0 TDI [5P1]	2,0	100/103/125	AZV; BKD <D3X>; BMM <D7N>; BMN	03.04-07.11	0 281 002 461	0 986 284 007
		103	CFHC <D91>	09.10→	0 281 002 956	
		125	CEGA <D93>	03.09-05.10	0 281 002 735	
<b>Altea Freetrack</b>						
2.0 TDI, TDI 4WD [5P5/5P8]	2,0	103/125	BMM <D7N>; BMN	06.07-10.10	0 281 002 461	0 986 284 007
TDI 4WD [5P5/5P8]	2,0	103/125	CFHC <D91>; CFJA <D93>	09.10→	0 281 002 956	
		125	CEGA <D93>	03.09-10.10	0 281 002 735	
<b>Altea XL</b>						
1.9 TDI [5P5]	1,9	66/77	BLS <D3W>; BXE <D3W>; BXF <MF7>	10.06-12.10	0 281 002 531	0 986 284 009
2.0 TDI [5P5]	2,0	100/103/125	AZV; BKD <D3X>; BMM <D7N>; BMN	05.06-09.11	0 281 002 461	0 986 284 007
		125	CEGA <D93>	03.09-05.10	0 281 002 735	
TDI, TDI 4WD [5P5]	2,0	103	CFHC <D91>	10.10→	0 281 002 956	
<b>Arosa</b>						
1.4 TDI [6H1]	1,4	55	AMF	01.98-06.04	0 281 002 318	0 986 284 002
<b>Cordoba</b>						
1.4 TDI [6L2]	1,4	51/55/58/59	AMF; BMS; BNM; BNV	10.02-11.09	0 281 002 531	0 986 284 009
1.9 TDI [6K2]	1,9	66/81	AGR; ALH; ASV	05.99→	0 281 002 216	0 986 284 001
TDI [6L2]	1,9	74	ATD; AXR	09.02-11.09	0 281 002 531	0 986 284 009
			BMT	09.06-11.09	0 281 002 531	0 986 284 009
		96	ASZ	10.02-09.05	0 281 002 461	0 986 284 007
			BLT	05.05-11.09	0 281 002 461	0 986 284 007
<b>Cordoba Vario</b>						
1.9 TDI [6K5]	1,9	66/81	AGR; ALH; ASV	05.99-08.02	0 281 002 216	0 986 284 001
<b>Exeo</b>						
2.0 TDI [3R2]	2,0	88/105/125	CAGA <D92>; CAGC <D90>; CAHA <D93>; CGLB <D93>; CJCA <D92>; CJCC <D90>	12.08-12.11	0 281 002 735	
				01.12-08.13	0 281 002 956	
<b>Exeo ST</b>						
2.0 TDI [3R5]	2,0	88/105/125	CAGA <D92>; CAGC <D90>; CAHA <D93>; CGLB <D93>; CJCA <D92>; CJCC <D90>	06.09-12.11	0 281 002 735	
				01.12-08.13	0 281 002 956	
<b>Ibiza</b>						
1.2 TDI [6J5]	1,2	55	CFWA <D28>	06.10-05.15	0 281 006 132	
1.4 TDI [6J5]	1,4	59	BMS <D4T>	08.08-06.10	0 281 002 531	0 986 284 009
TDI [6L1]	1,4	51/55/59	AMF; BMS; BNM; BNV	05.02-11.09	0 281 002 531	0 986 284 009
1.9 TDI [6J5]	1,9	66/77	BLS <D3W>; BXJ	02.08-06.10	0 281 002 531	0 986 284 009
TDI [6K1]	1,9	66/81	AGR; ALH; ASV	05.99-05.02	0 281 002 216	0 986 284 001
TDI [6L1]	1,9	74	ATD			
			Fg.-Nr. →6L..2..050 000	09.01-03.02	0 281 002 757	
				WW,XXX		0 986 280 202
			Fg.-Nr. 6L..2..050 001→	04.02-05.05	0 281 002 531	0 986 284 009
			AXR	05.05-11.09	0 281 002 531	0 986 284 009
			BMT	09.06-11.09	0 281 002 531	0 986 284 009
		96	ASZ	11.01-09.05	0 281 002 461	0 986 284 007
			BLT	05.05-11.09	0 281 002 461	0 986 284 007
2.0 TDI [6J5]	2,0	105	CFHD <D92>	01.10-05.15	0 281 002 956	
<b>Ibiza Cupra R</b>						
1.9 TDI [6L1]	1,9	118	BPX; BUK	03.04-02.08	0 281 002 461	0 986 284 007
<b>Ibiza SC</b>						
1.2 TDI [6J1]	1,2	55	CFWA <D28>	05.10-05.15	0 281 006 132	
1.4 TDI [6J1]	1,4	59	BMS <D4T>	07.08-06.10	0 281 002 531	0 986 284 009



									
1.9 TDI [6J1]	1,9	66/77	BLS <D3W>; BXJ		02.08-06.10			<b>0 281 002 531</b>	<b>0 986 284 009</b>
2.0 TDI [6J1]	2,0	105	CFHD <D92>		01.10-05.15			<b>0 281 002 956</b>	
<b>Ibiza ST</b>									
1.2 TDI [6J8]	1,2	55	CFWA <D28>		04.10-05.15			<b>0 281 006 132</b>	
<b>Leon</b>									
1.9 TDI [1M1]	1,9	66	AGR		12.99-09.02			<b>0 281 002 757</b>	
			ALH		03.99-07.04	WW,XXX		<b>0 986 280 202</b>	
			PR-Code OGD PR-Code OGE		03.99-07.04	ØBD,WW,XXX		<b>0 281 002 757</b>	
			PR-Code OGZ		03.99-07.04	ØBD		<b>0 281 002 531</b>	<b>0 986 284 009</b>
	74		AXR		10.05-06.06			<b>0 281 002 531</b>	<b>0 986 284 009</b>
	81		AHF		10.98-09.02	WW,XXX		<b>0 986 280 202</b>	
			ASV		04.99-09.02			<b>0 281 002 757</b>	
			PR-Code OGD PR-Code OGE		10.99-10.05	ØBD,WW,XXX		<b>0 986 280 202</b>	
			PR-Code OGZ		10.99-10.05	ØBD		<b>0 281 002 531</b>	<b>0 986 284 009</b>
	96		ASZ		05.03-06.06			<b>0 281 002 461</b>	<b>0 986 284 007</b>
TDI [1P1]	1,9	66/77	BKC; BLS <D3W>; BXE <D3W>; BXF <MF7>		07.05-12.10			<b>0 281 002 531</b>	<b>0 986 284 009</b>
TDI Syncro [1M1]	1,9	110	ARL						
			Fg.-Nr. →1M..3..011 800		09.00-05.02			<b>0 280 217 529</b>	<b>0 986 280 204</b>
			Fg.-Nr. 1M..3..011 801→		06.02-07.04			<b>0 281 002 461</b>	<b>0 986 284 007</b>
2.0 TDI [1P1]	2,0	100/103/125	AZV; BKD <D3X>; BMM <D7N>; BMN		07.05-12.12			<b>0 281 002 461</b>	<b>0 986 284 007</b>
		103/125	CFHC <D91>; CFJA <D93>; CLCB <D91>		05.10-12.12			<b>0 281 002 956</b>	
		125	CEGA <D93>		03.09-12.12			<b>0 281 002 735</b>	
TDI [5F1]	2,0	81/105/110/135	CKFC <DN4>; CRMB <DN4>; CRVA <DN1>; CRVC <DN6>; CUNA <DK7>; CUPA <DK7>		10.12→			<b>0 281 002 956</b>	
<b>Leon SC</b>									
2.0 TDI [5F5]	2,0	81/105/110/135	CKFC <DN4>; CRMB <DN4>; CRVA <DN1>; CRVC <DN6>; CUNA <DK7>; CUPA <DK7>		02.13→			<b>0 281 002 956</b>	
<b>Leon ST</b>									
2.0 TDI, TDI 4Drive, TSI [5F8]	2,0	81/105/110/135	CKFC <DN4>; CRBC <DN4>; CRLB <DN4>; CRMB <DN4>; CRVA <DN1>; CRVC <DN6>; CUNA <DK7>; CUPA <DK7>		08.13→			<b>0 281 002 956</b>	
<b>Toledo</b>									
1.9 TDI [1M2]	1,9	66	AGR		04.99-09.02			<b>0 281 002 757</b>	
			ALH			WW,XXX		<b>0 986 280 202</b>	
			PR-Code OGD PR-Code OGE		04.99-07.04	ØBD		<b>0 281 002 757</b>	
			PR-Code OGZ		04.99-07.04	ØBD,WW,XXX		<b>0 986 280 202</b>	
	81		AHF		10.98-09.02	WW,XXX		<b>0 986 280 202</b>	
			ASV		04.99-09.02			<b>0 281 002 757</b>	
			PR-Code OGD PR-Code OGE		10.99-07.04	ØBD		<b>0 281 002 757</b>	
			PR-Code OGZ		10.99-07.04	ØBD,WW,XXX		<b>0 986 280 202</b>	
	96		ASZ		05.03-07.04			<b>0 281 002 461</b>	<b>0 986 284 007</b>
	110		ARL		09.00-05.02			<b>0 280 217 529</b>	<b>0 986 280 204</b>
TDI [5P2]	1,9	77	BJB; BKC; BLS <D3W>; BXE <D3W>		09.04-05.09			<b>0 281 002 531</b>	<b>0 986 284 009</b>
2.0 TDI [5P2]	2,0	100/103/125	AZV; BKD <D3X>; BMM <D7N>; BMN		09.04-05.09			<b>0 281 002 461</b>	<b>0 986 284 007</b>
		125	CEGA <D93>		03.09-05.09			<b>0 281 002 735</b>	





**SKODA**

**Fabia**

1.2 TDI [5J2]	1,2	55	CFWA <D28>	03.10-12.14	<b>0 281 006 132</b>	
1.4 TDI [5J2]	1,4	51/59	BMS <D4T>; BNM <D4S>; BNV <D4T>	01.07-03.10	<b>0 281 002 531</b>	<b>0 986 284 009</b>
TDI [6Y3]	1,4	51/55/59	AMF; BNM <D4S>; BNV <D4T>	05.03-12.07	<b>0 281 002 531</b>	<b>0 986 284 009</b>
1.9 TDI [5J2]	1,9	77	BLS <D3W>; BSW <D3W>	04.07-03.10	<b>0 281 002 531</b>	<b>0 986 284 009</b>
TDI [6Y3]	1,9	74	ATD			
			Fg.-Nr. →6Y..2..532 833 →6Y..2X040 209	09.99-04.02	<b>0 281 002 757</b>	
					WW,XXX	<b>0 986 280 202</b>
			Fg.-Nr. 6Y..2..532 834 →6Y..2X040 210→	05.02-10.05	<b>0 281 002 531</b>	<b>0 986 284 009</b>
			AXR <MS7>	10.05-12.07	<b>0 281 002 531</b>	<b>0 986 284 009</b>

**Fabia Combi**

1.2 TDI [5J5]	1,2	55	CFWA <D28>	03.10-12.14	<b>0 281 006 132</b>	
1.4 TDI [5J5]	1,4	51/59	BMS <D4T>; BNM <D4S>; BNV <D4T>	10.07-03.10	<b>0 281 002 531</b>	<b>0 986 284 009</b>
TDI [6Y5]	1,4	51/55/59	AMF; BNM <D4S>; BNV <D4T>	05.03-12.07	<b>0 281 002 531</b>	<b>0 986 284 009</b>
1.9 TDI [5J5]	1,9	77	BLS <D3W>; BSW <D3W>	10.07-03.10	<b>0 281 002 531</b>	<b>0 986 284 009</b>
TDI [6Y5]	1,9	74	ATD			
			Fg.-Nr. →6Y..2..532 833 →6Y..2X040 209	08.00-04.02	<b>0 281 002 757</b>	
					WW,XXX	<b>0 986 280 202</b>
			Fg.-Nr. 6Y..2..532 834 →6Y..2X040 210→	05.02-10.05	<b>0 281 002 531</b>	<b>0 986 284 009</b>
			AXR <MS7>	10.05-12.07	<b>0 281 002 531</b>	<b>0 986 284 009</b>

**Fabia Schrägheck**

1.4 TDI [6Y2]	1,4	51/55/59	AMF; BNM <D4S>; BNV <D4T>	05.03-04.07	<b>0 281 002 531</b>	<b>0 986 284 009</b>
1.9 TDI [6Y2]	1,9	74	ATD			
			Fg.-Nr. →6Y..2..532 833 →6Y..2X040 209	09.99-04.02	<b>0 281 002 757</b>	
					WW,XXX	<b>0 986 280 202</b>
			Fg.-Nr. 6Y..2..532 834 →6Y..2X040 210→	05.02-10.05	<b>0 281 002 531</b>	<b>0 986 284 009</b>
			AXR <MS7>	10.05-04.07	<b>0 281 002 531</b>	<b>0 986 284 009</b>

**Fabia Schrägheck RS**

1.9 TDI [6Y2]	1,9	96	ASZ; BLT	06.03-04.07	<b>0 281 002 461</b>	<b>0 986 284 007</b>
---------------	-----	----	----------	-------------	----------------------	----------------------

**Octavia**

1.9 TDI [1U2]	1,9	66/81	AGR; AHF			
			Fg.-Nr. 1U..W..134 001→	08.98-12.09	<b>0 281 002 757</b>	
					WW,XXX	<b>0 986 280 202</b>
			ALH; ASV			
			Fg.-Nr. →1U..3..836 957 →1U..3A016 708	08.00-07.03	<b>0 281 002 757</b>	
			→1U..38712 468		WW,XXX	<b>0 986 280 202</b>
			Fg.-Nr. 1U..3..836 958 →1U..3A016 709→	08.03-03.10	<b>0 281 002 531</b>	<b>0 986 284 009</b>
			1U..38712 469→			
		74	AXR <MS7>	10.05-12.10	<b>0 281 002 531</b>	<b>0 986 284 009</b>
		96	ASZ	01.03-09.04	<b>0 281 002 461</b>	<b>0 986 284 007</b>
TDI, TDI 4x4 [1Z3]	1,9	77	BJB <D3W>; BKC <D3W>; BLS <D3W>; BXE <D3W>	05.04-04.13	<b>0 281 002 531</b>	<b>0 986 284 009</b>
2.0 RS TDI 4x4, TDI, TDI 4x4 [5E3]	2,0	105/110/135	CKFB <DN6>; CKFC <DN4>; CRMB <DN4>; CRVC <DN6>; CUNA <DK7>; CUPA <DK7>	11.12→	<b>0 281 002 956</b>	
TDI [1Z3]	2,0	100/103	AZV <MS9>; BKD <D7N>; BMM <D7N>	05.04-05.10	<b>0 281 002 461</b>	<b>0 986 284 007</b>
TDI, TDI 4x4 [1Z3]	2,0	81/103	CFHC <D91>; CFHF <D96>; CLCA <D96>; CLCB <D91>	02.10-06.13	<b>0 281 002 956</b>	

**Octavia Combi**

1.9 TDI [1U5]	1,9	66/81	ALH; ASV			
			Fg.-Nr. →1U..3..836 957 →1U..3A016 708	08.00-07.03	<b>0 281 002 757</b>	
			→1U..38712 468		WW,XXX	<b>0 986 280 202</b>
			Fg.-Nr. 1U..3..836 958 →1U..3A016 709→	08.03-03.10	<b>0 281 002 531</b>	<b>0 986 284 009</b>
			1U..38712 469→			
		74	AXR <MS7>	10.05-12.10	<b>0 281 002 531</b>	<b>0 986 284 009</b>
		81	AHF			
			Fg.-Nr. 1U..W..134 001→	08.98-01.06	<b>0 281 002 757</b>	
					WW,XXX	<b>0 986 280 202</b>
		96	ASZ	01.03-09.04	<b>0 281 002 461</b>	<b>0 986 284 007</b>
TDI, TDI 4x4 [1U5]	1,9	66	AGR	05.98-12.09	<b>0 281 002 757</b>	
					WW,XXX	<b>0 986 280 202</b>





1.9 TDI, TDI 4x4 [1U5]	1,9	74	ATD					
				Fg.-Nr. →1U..3..666 021 →1U..38665 263	08.00-04.02		<b>0 281 002 757</b>	
						WW,XXX		<b>0 986 280 202</b>
				Fg.-Nr. 1U..3..666 022 → 1U..38665 264 →	05.02-01.06		<b>0 281 002 531</b>	<b>0 986 284 009</b>
TDI, TDI 4x4 [1Z5]	1,9	77	BJB <D3W>; BKC <D3W>; BLS <D3W>; BXE <D3W>		05.04-04.13		<b>0 281 002 531</b>	<b>0 986 284 009</b>
2.0 TDI, TDI RS 4x4, TDI 4x4 [5E5]	2,0	105/110/135	CKFB <DN6>; CKFC <DN4>; CRMB <DN4>; CRVC <DN6>; CUNA <DK7>; CUPA <DK7>		11.12 →		<b>0 281 002 956</b>	
TDI, TDI 4x4 [1Z5]	2,0	81/103	CFHC <D91>; CFHF <D96>; CLCA <D96>; CLCB <D91>		02.10-06.13		<b>0 281 002 956</b>	
		100/103	AZV <MS9>; BKD <D7N>; BMM <D7N>		05.04-05.10		<b>0 281 002 461</b>	<b>0 986 284 007</b>
<b>Octavia Combi RS</b>								
2.0 FSI, TDI [5E5]	2,0	135	CUNA <DK7>; CUPA <DK7>		05.13 →		<b>0 281 002 956</b>	
TDI [1Z5]	2,0	125	BMN <DOM>		04.06-05.08		<b>0 281 002 461</b>	<b>0 986 284 007</b>
			CEGA <D93>		05.08-02.13		<b>0 281 002 735</b>	
<b>Octavia RS</b>								
2.0 TDI [1Z3]	2,0	125	BMN <DOM>		04.06-05.08		<b>0 281 002 461</b>	<b>0 986 284 007</b>
			CEGA <D93>		05.08-02.13		<b>0 281 002 735</b>	
TDI [5E3]	2,0	135	CUNA <DK7>; CUPA <DK7>		05.13 →		<b>0 281 002 956</b>	
<b>Praktik</b>								
1.2 TDI [5J7]	1,2	55	CFWA <D28>		03.10-05.15		<b>0 281 006 132</b>	
1.4 TDI [5J7]	1,4	51/59	BMS <D4T>; BNM <D4S>; BNV <D4T>		03.07-03.10		<b>0 281 002 531</b>	<b>0 986 284 009</b>
<b>Roomster</b>								
1.2 TDI [5J7]	1,2	55	CFWA <D28>		03.10-05.15		<b>0 281 006 132</b>	
1.4 TDI [5J7]	1,4	51/59	BMS <D4T>; BNM <D4S>; BNV <D4T>		05.06-03.10		<b>0 281 002 531</b>	<b>0 986 284 009</b>
1.9 TDI [5J7]	1,9	74/77	AXR <MS7>; BLS <D3W>; BSW <D3W>		03.06-03.10		<b>0 281 002 531</b>	<b>0 986 284 009</b>
<b>Superb</b>								
1.9 TDI [3T4]	1,9	77	BLS <D3W>; BXE <D3W>		03.08-11.10		<b>0 281 002 531</b>	<b>0 986 284 009</b>
TDI [3U4]	1,9	74	AVB		02.02-10.05		<b>0 281 002 463</b>	<b>0 986 284 008</b>
		77/85/96	AVF; AWX; BPZ; BSV		12.01-03.08		<b>0 281 002 461</b>	<b>0 986 284 007</b>
2.0 TDI [3T4]	2,0	103	BKD <D7N>; BMP <D7N>		03.08-03.10		<b>0 281 002 461</b>	<b>0 986 284 007</b>
TDI [3U4]	2,0	91/103	BSS; BWW		10.05-03.08		<b>0 281 002 461</b>	<b>0 986 284 007</b>
TDI, TDI 4x4 [3T4]	2,0	103/125	CFFB <D91>; CFGB <D93>; CLJA <D91>		02.10-05.15		<b>0 281 002 956</b>	
		125	CBBB <D93>		06.08-05.10		<b>0 281 002 735</b>	
TDI, TDI 4x4 [3V3]	2,0	110/140	CRLB <DN4>; DDAA <DE5>; DFCA <DE5>; DFEA <DN4>		05.15 →		<b>0 281 002 956</b>	
<b>Superb Combi</b>								
1.9 TDI [3T5]	1,9	77	BLS <D3W>; BXE <D3W>		09.09-11.10		<b>0 281 002 531</b>	<b>0 986 284 009</b>
2.0 TDI [3T5]	2,0	103	BKD <D7N>; BMP <D7N>		09.09-03.10		<b>0 281 002 461</b>	<b>0 986 284 007</b>
TDI, TDI 4x4 [3T5]	2,0	103/125	CFFB <D91>; CFGB <D93>; CLJA <D91>		02.10-05.15		<b>0 281 002 956</b>	
		125	CBBB <D93>		09.09-05.10		<b>0 281 002 735</b>	
TDI, TDI 4x4 [3V5]	2,0	110/140	CRLB <DN4>; DDAA <DE5>; DFCA <DE5>; DFEA <DN4>		05.15 →		<b>0 281 002 956</b>	
<b>Yeti</b>								
2.0 TDI, TDI 4x4 [5L7]	2,0	81/103/110/125	CFHA <D96>; CFHC <D91>; CFHF <D96>; CFJA <D93>; CLCA <D96>; CLCB <D91>; CUUA <DN1>; CUUB <DN4>; DFSA <DN1>; DFSB <DN4>		11.09 →		<b>0 281 002 956</b>	
TDI 4x4 [5L7]	2,0	103/125	CBDB <D91>; CEGA <D93>		05.09-05.10		<b>0 281 002 735</b>	

## SSANGYONG

**Actyon**

2.0 e-XDi, e-XDi 4x4	2,0	109,6	D20DTF (671.950) <Euro 4>		05.11 →		<b>0 281 006 043</b>	
Xdi, Xdi 4WD	2,0	100-104	D 20 DT (OM 664.951)		09.06-12.10	EU3	<b>0 280 218 130</b>	

**Actyon Sports**

2.0 E-Xdi, E-Xdi 4WD	2,0	114	D 20 DTR <OM 671.959>		12.11 →		<b>0 281 006 043</b>	
Xdi, Xdi 4WD	2,0	104	D 20 DT (OM 664.951)		03.07-12.12	EU3	<b>0 280 218 130</b>	

**Korando**

2.0 DT, DT AWD [CK]	2,0	110/129	D 20 DT <OM 671.950>		07.10 →		<b>0 281 006 043</b>	
2.2 XDi, XDi AWD [CK]	2,2	131	E-XDi220 <OM 672.950>		08.15 →		<b>0 281 006 043</b>	

**Kyron**

2.0 Xdi, Xdi 4WD	2,0	100/104	D 20 DT <OM 664.950>		05.05 →	EU4	<b>0 280 218 130</b>	
------------------	-----	---------	----------------------	--	---------	-----	----------------------	--



◀ SSANGYONG

2.7 Xdi 4WD	2,7	121	D 27 DT <OM 665.950>	05.05→	€4	<b>0 280 218 130</b>
<b>Rexton</b>						
2.7 Xdi 4WD	2,7	120-121	D 27 DT <OM 665.925>	08.04-12.09		<b>0 280 218 130</b>
<b>Rexton RX270</b>						
2.7 XDI 4WD, XVT 4WD	2,7	118/132	D 27 DT <OM 665.925>; D27 DTP <OM 665.935>	10.08-12.12	EU3	<b>0 280 218 130</b>
<b>Rodius</b>						
2.7 Xdi, Xdi 4WD	2,7	120-121	D 27 DT <OM 665.926>	05.05-12.12	€4	<b>0 280 218 130</b>
<b>Rodius SV200</b>						
2.0 e-XDI, e-XDI 4WD	2,0	114	D 20 DTR <OM 671.960>	05.13→		<b>0 281 006 043</b>

**SUZUKI**







<b>Ignis Hatchback</b>						
1.3 DDiS Turbo	1,3	51	Z13DT	10.03-12.07		<b>0 281 002 619</b>
<b>Splash</b>						
1.3 DDiS [A5B]	1,2	55	D13A <DPF>; Z13DTJ	01.08→		<b>0 281 002 862</b>
<b>Swift Hatchback</b>						
1.3 DDiS D Turbo [MZ/EZ]	1,3	51-55	Z13DT			
			Fg.-Nr. →00500000	08.05→		<b>0 281 002 619</b>
			Fg.-Nr. 00500001→	08.05→		<b>0 281 002 862</b>
DDiS, DDiS D Turbo [FZ/NZ]	1,2	55	D13A <DPF>; D13AA	09.10→	SSJ	<b>0 281 002 860</b>
					SSJ	<b>0 281 006 054</b>
DDiS, DDiS D Turbo [MZ/EZ]	1,2	55	D13A <DPF>; Z13DTJ	02.08→		<b>0 281 002 862</b>
<b>SX4 Hatchback</b>						
1.9 DDiS, DDiS 4WD	1,9	88	D19AA	05.06→		<b>0 281 002 683</b>
2.0 DDiS, DDiS 4WD	2,0	99	D20AA <DPF>	09.09→		<b>0 281 002 860</b>
<b>SX4 S-Cross</b>						
1.6 DDiS, DDiS 4WD	1,6	88	D16AA	10.13→		<b>0 281 006 374</b>
<b>Vitara</b>						
1.6 DDiS, DDiS 4x4 [LY]	1,6	88	D16AA	02.15→		<b>0 281 006 374</b>
<b>Wagon R+</b>						
1.3 DDiS D Turbo [MM]	1,3	51	Z13DT	09.03-03.06		<b>0 281 002 619</b>

**UAZ**

<b>Patriot</b>						
2.2 TD 4x4	2,3	85	F1AE0481B	01.07→		<b>0 281 002 763</b>

**VAUXHALL**

<b>Agila</b>						
1.3 CDTI [B]	1,2	55	D 13 A <Turbo>; Z 13 DTJ	03.08→		<b>0 281 002 862</b>
<b>Antara</b>						
2.0 CDTI 4x4	2,0	93/110	Z 20 DM <Ecotec>; Z 20 DMH <Ecotec>	11.06-12.11		<b>0 281 002 683</b>
<b>Astra</b>						
1.3 CDTI [H]	1,3	66	Z 13 DTH <Ecotec>	01.06-03.10		<b>0 281 002 683</b>
CDTI [J]	1,2	70	A 13 DTE <ecoFlex>	09.09→		<b>0 281 002 940</b>
1.6 [K]	1,6	70/81/100/118	B 16 DTH; B 16 DTR; B 16 DTU	09.15→		<b>0 280 218 254</b>
CDTI, GTC [J]	1,6	81/100	B 16 DTH; B 16 DTL	10.13→		<b>0 280 218 254</b>
1.7 CDTI	1,7	81	A 17 DTC <ecoFlex>	01.12→		<b>0 280 218 254</b>
		81/96	A 17 DTE; A 17 DTF	01.12→		<b>0 281 002 940</b>
CDTI [H]	1,7	59	Z 17 DTL <Turbo Ecotec>	03.04-03.07		<b>0 281 002 683</b>
		74	Z 17 DTH <Turbo Ecotec>	03.04-03.07		<b>0 281 002 683</b>
		81	A 17 DTJ <Ecotec>	04.09-09.09		<b>0 281 002 832</b>
			Z 17 DTJ <Turbo Ecotec>	03.07-09.09		<b>0 281 002 832</b>
		92	A 17 DTR <Turbo Ecotec>	03.10-12.12		<b>0 281 002 832</b>
			Z 17 DTR <Turbo Ecotec>	05.07-03.10		<b>0 281 002 832</b>
CDTI [J]	1,7	81/92	A 17 DTJ <Ecotec>; A 17 DTR <Ecotec>	09.09→		<b>0 281 002 940</b>
		96	A 17 DTS <ecoFlex>	01.12→		<b>0 280 218 254</b>

									
<b>1.7</b> CDTI 16V [G]	1,7	59	Z 17 DTL <Turbo Ecotec>		03.03-08.05				<b>0 281 002 549</b>
DT, DTI [G]	1,7	50/55	X 17 DTL; Y 17 DT <Turbo (EE 4)>		03.98-08.05				<b>0 281 002 180</b>
<b>1.9</b> CDTI [H]	1,9	74/88/110	Z 19 DT <Turbo Ecotec>; Z 19 DTH <Ecotec>; Z 19 DTL <Turbo Ecotec>		03.04-03.10				<b>0 281 002 683</b>
<b>2.0</b> CDTI, GTC [J]	2,0	118/121/143	A 20 DTH <Ecotec>; A 20 DTR <Ecotec>		09.09→				<b>0 281 002 912</b>
DTI, DTL [G]	2,0	60/74	X 20 DTL <Turbo>; Y 20 DTH <Ecotec> Fg.-Nr. →Y8999999 →YT999999 Mot.-Nr. 12000001→1T000001→		03.98-08.05 03.98-08.05				<b>0 281 002 180</b> <b>0 281 002 428</b>
DTL [G]	2,0	60	Y 20 DTL <Turbo> Mot.-Nr. 12000001→1T000001→		09.00-08.05				<b>0 281 002 428</b>
<b>Astra Estate</b>									
<b>1.3</b> CDTI [H]	1,3	66	Z 13 DTH <Ecotec>		06.05-03.10				<b>0 281 002 683</b>
<b>1.7</b> CDTI [G]	1,7	59	Z 17 DTL <Turbo Ecotec>		03.03-08.05				<b>0 281 002 549</b>
CDTI [H]	1,7	59	Z 17 DTL <Turbo Ecotec>		09.04-03.07				<b>0 281 002 683</b>
		74	Z 17 DTH <Turbo Ecotec>		08.04-03.07				<b>0 281 002 683</b>
		81	Z 17 DTJ <Turbo Ecotec>		03.07-03.10				<b>0 281 002 832</b>
		81/92	A 17 DTJ <Ecotec>; A 17 DTR <Turbo Ecotec>		03.10-12.12				<b>0 281 002 832</b>
		92	Z 17 DTR <Turbo Ecotec>		05.07-03.10				<b>0 281 002 832</b>
DT, DTI [G]	1,7	50/55	X 17 DTL; Y 17 DT <Turbo (EE 4)>		03.98-08.05				<b>0 281 002 180</b>
<b>1.9</b> CDTI [H]	1,9	74/88/110	Z 19 DT <Turbo Ecotec>; Z 19 DTH <Ecotec>; Z 19 DTL <Turbo Ecotec>		08.04-03.10				<b>0 281 002 683</b>
<b>2.0</b> DTI, DTL [G]	2,0	60/74	X 20 DTL <Turbo>; Y 20 DTH <Ecotec> Fg.-Nr. →Y8999999 →YT999999 Mot.-Nr. 12000001→1T000001→		03.98-08.05 03.98-08.05				<b>0 281 002 180</b> <b>0 281 002 428</b>
DTL [G]	2,0	60	Y 20 DTL <Turbo> Mot.-Nr. 12000001→1T000001→		09.00-08.05				<b>0 281 002 428</b>
<b>Astra GTC</b>									
<b>1.7</b> [J]	1,7	81	A 17 DTC <ecoFLEX>		11.11→				<b>0 280 218 254</b>
		81/96	A 17 DTE; A 17 DTF		11.11→				<b>0 281 002 940</b>
		96	A 17 DTS <ecoFLEX>		11.11→				<b>0 280 218 254</b>
CDTI [H]	1,7	59	Z 17 DTL <Turbo Ecotec>		09.05-03.07				<b>0 281 002 683</b>
		74	Z 17 DTH <Turbo Ecotec>		06.05-03.07				<b>0 281 002 683</b>
		81	Z 17 DTJ <Turbo Ecotec>		03.07-12.09				<b>0 281 002 832</b>
		92	Z 17 DTR <Turbo Ecotec>		05.07-12.09				<b>0 281 002 832</b>
<b>1.9</b> CDTI [H]	1,9	88/110	Z 19 DTH <Ecotec>; Z 19 DTJ <Turbo Ecotec>		06.05-12.09				<b>0 281 002 683</b>
<b>2.0</b> [J]	2,0	121	A 20 DTH <Ecotec>		09.11→				<b>0 281 002 912</b>
<b>Astra Sport Tourer</b>									
<b>1.7</b> CDTI	1,7	96	A 17 DTF		01.12→				<b>0 281 002 940</b>
<b>Astra Sports Tourer</b>									
<b>1.3</b> CDTI [J]	1,2	70	A 13 DTE <ecoFlex>		09.10→				<b>0 281 002 940</b>
<b>1.6</b> [K]	1,6	70/81/100/118	B 16 DTE; B 16 DTH; B 16 DTR; B 16 DTU		02.16→				<b>0 280 218 254</b>
CDTI [J]	1,6	81/100	B 16 DTH; B 16 DTL		10.13→				<b>0 280 218 254</b>
<b>1.7</b> CDTI	1,7	81	A 17 DTC		01.12→				<b>0 280 218 254</b>
			A 17 DTE		01.12→				<b>0 281 002 940</b>
		96	A 17 DTS		01.12→				<b>0 280 218 254</b>
CDTI [J]	1,7	81/92	A 17 DTJ <Ecotec>; A 17 DTR		09.10→				<b>0 281 002 940</b>
<b>2.0</b> CDTI [J]	2,0	118/121/143	A 20 DTH <Ecotec>; A 20 DTR <Ecotec>		09.10→				<b>0 281 002 912</b>
<b>Astra TwinTop</b>									
<b>1.9</b> CDTi [H]	1,9	110	Z 19 DTH <Ecotec>		09.05-12.09				<b>0 281 002 683</b>
<b>Astra Van</b>									
<b>1.7</b> CDTI [G]	1,7	59	Z 17 DTL <Turbo Ecotec>		03.03-08.05				<b>0 281 002 549</b>
DT [G]	1,7	50	X 17 DTL		03.98-08.00				<b>0 281 002 180</b>
<b>2.0</b> DTI, DTL [G]	2,0	60/74	X 20 DTL <Turbo>; Y 20 DTH <Ecotec> Fg.-Nr. →Y8999999 →YT999999 Mot.-Nr. 12000001→1T000001→		03.98-08.05 03.98-08.05				<b>0 281 002 180</b> <b>0 281 002 428</b>
<b>Cascada</b>									
<b>2.0</b> CDTI	2,0	121/143	A 20 DTH <Ecotec>; A 20 DTR <Ecotec>		04.13→				<b>0 281 002 912</b>
		125	B 20 DTH		07.15→				<b>0 280 218 254</b>





◀ VAUXHALL

Combo						
1.3 [D]	1,2	66	A 13 FD <ecoFLEX>	02.12→	SSJ	0 281 002 792
					SSJ	0 281 002 980
CDTi [Tour]	1,3	51	Y 13 DT <Turbo>; Z 13 DT <Ecotec>	09.04-01.12		0 281 002 549
		55	Z 13 DTJ <Turbo>	03.06-01.12		0 281 002 683
1.6 [D]	1,6	66/74/77	A 16 FDH <ecoFLEX>; A 16 FDL <ecoFLEX>	02.12→	SSJ	0 281 002 917
					SSJ	0 281 002 980
1.7 CDTi [Tour]	1,7	74	Z 17 DTH <Turbo Ecotec>	09.04-01.12		0 281 002 549
DI, DTI [Tour]	1,7	48/55	Y 17 DT Turbo; Y 17 DTL Turbo	09.01-08.04		0 281 002 180
2.0 [D]	2,0	99	A 20 FD <ecoFLEX>	02.12→		0 281 002 980
Corsa						
1.3 [E]	1,2	55/70	B 13 DTC; B 13 DTE; B 13 DTR	10.14→		0 280 218 254
CDTi [C]	1,3	51	Y 13 DT <Turbo Ecotec>; Z 13 DT <Ecotec>	09.03-09.06		0 281 002 549
		55	Z 13 DTJ <Turbo Ecotec>	09.05-09.06		0 281 002 683
CDTi [D]	1,2	55/66	Z 13 DTH <Turbo Ecotec>; Z 13 DTJ <Turbo Ecotec>	07.06-07.10		0 281 002 683
		55/70	A 13 DT... <ecoFlex>; A 13 DTC <Ecotec>	01.11→		0 281 002 940
		70	Z 13 DTE <eco Flex>	12.09-09.10		0 281 002 940
	1,3	55/66	A 13 DTH <Turbo Ecotec>; A 13 DTJ <Turbo Ecotec>	10.06-02.09		0 281 002 683
1.7 CDTi [C]	1,7	74	Z 17 DTH <Turbo Ecotec>	09.03-08.05		0 281 002 549
CDTi [D]	1,7	92	A 17 DTR	07.06-02.09		0 281 002 832
			Z 17 DTR <Turbo Ecotec>	07.06-06.10		0 281 002 832
		96	A 17 DTS	12.09→		0 281 002 940
DI, DTI [C]	1,7	48/55	Y 17 DT <Turbo (EE 4)>; Y 17 DTL	09.00-08.03		0 281 002 180
Frontera						
2.2 DTI [B]	2,2	85/88	X 22 DTH <Turbo>; Y 22 DTH <Turbo>			
			Fg.-Nr. →2V599999	09.98-09.04		0 281 002 184
			Fg.-Nr. 3V500001→	09.98-09.04		0 281 002 479
2.5 TDS Turbo [A]	2,5	85	VM41B <Venturi-25TD>	06.96-08.98		0 281 002 144
Insignia						
1.6 [68]	1,6	100	B 16 DTH	07.15→		0 281 002 912
Sports Tourer [35]	1,6	100	B 16 DTH	07.15→		0 281 002 912
2.0 CDTi, CDTi 4x4 [68]	2,0	81/96/103/118/125/140-143	A 20 DT... <Ecotec>; A 20 DTE; A 20 DTH <Ecotec>; A 20 DTR <Ecotec>; B 20 DTH	11.08→		0 281 002 912
CDTi, CDTi 4x4 [69]	2,0	81/88/96/118/140-143	A 20 DT... <Ecotec>; A 20 DTE; A 20 DTH <Ecotec>; A 20 DTR <Ecotec>	11.08→		0 281 002 912
Insignia Sports Tourer						
2.0 CDTi, CDTi 4x4 [35]	2,0	81/88/96/103/118/125/140-143	A 20 DT... <Ecotec>; A 20 DTE; A 20 DTH <Ecotec>; A 20 DTR <Ecotec>; B 20 DTH	02.09→		0 281 002 912
Meriva						
1.3 CDTi [A]	1,3	51	Y 13 DT <Ecotec>; Z 13 DT <Ecotec>	09.05-03.10		0 281 002 620
		55	Z 13 DTJ <Ecotec>	09.03-03.10		0 281 002 802
CDTi [B]	1,2	55/70	A 13 DTC <Ecotec>; A 13 DTE <ecoFlex>	06.10→		0 281 002 940
1.6 CDTi [B]	1,6	70/81/100	B 16 DTC; B 16 DTH; B 16 DTL	10.13→		0 280 218 254
1.7 CDTi [A]	1,7	74	Z 17 DTH <Turbo Ecotec>	09.03-09.09		0 281 002 620
CDTi [B]	1,7	74/81/96	A 17 DT...; A 17 DT <Ecotec>; A 17 DTS <Ecotec>	04.10→		0 281 002 940
DTI [A]	1,7	55	Y 17 DT <Turbo (EE 4)>	03.03-09.05		0 281 002 579
Mokka						
1.6 , 4x4	1,6	100	B 16 DTH	02.15→		0 281 006 311
1.7 CDTi ecoFLEX, CDTi ecoFLEX 4x4	1,7	96	A 17 DTS	09.12→		0 281 006 311
Omega						
2.0 DTI [B]	2,0	74	X 20 DTH Turbo	09.97-08.00		0 281 002 180
2.2 DTI [B]	2,2	88	Y 22 DTH <Turbo>	06.00-09.03		0 281 002 428
2.5 TDI [B]	2,5	110	Y 25 TD <Turbo>	09.01-09.04		0 281 002 564
Signum						
1.9 CDTi	1,9	74/88/110	Z 19 DT <Ecotec>; Z 19 DTH <Ecotec>; Z 19 DTL <Ecotec>	04.04-09.08		0 281 002 683
2.0 DTI	2,0	74	Y 20 DTH <Ecotec>	05.03-09.05		0 281 002 479





2.2 DTI	2,2	86-92	Y 22 DTR <Ecotec>	05.03-09.08	0 281 002 479
3.0 CDTI	3,0	130-135	Y 30 DT <Ecotec>	05.03-09.05	0 281 002 605
			Z 30 DT <Ecotec>	09.05-09.08	0 281 002 773
<b>Sintra</b>					
2.2 TD	2,2	85	X 22 DTH <Turbo>	09.97-09.99	0 281 002 184
<b>Tigra TwinTop</b>					
1.3 CDTI [B]	1,3	51	Z 13 DT <Ecotec>	06.04-03.09	0 281 002 549
<b>Vectra</b>					
1.9 CDTI [C]	1,9	74/88/ 110	Z 19 DT <Ecotec>; Z 19 DTH <Ecotec>; Z 19 DTL <Ecotec>	04.04-10.08	0 281 002 683
2.0 DI [B]	2,0	60	X 20 DTL <Ecotec 16V Turbo>		
			Fg.-Nr. W1000001→ Fg.-Nr. →V7999999	09.96-08.00 09.96-08.00	0 281 002 180 0 281 002 139
DTI [B]	2,0	74	X 20 DTH <16V Turbo> Y 20 DTH <Ecotec>	09.97-08.00 09.00-08.01	0 281 002 180 0 281 002 428
DTI [C]	2,0	74	Y 20 DTH <Ecotec>	04.02-09.05	0 281 002 479
2.2 DTI [B]	2,2	92	Y 22 DTR <Turbo>	09.00-08.01	0 281 002 428
DTI [C]	2,2	86-92	Y 22 DTR <Turbo Ecotec>	04.02-09.05	0 281 002 479
3.0 CDTI [C]	3,0	130-135	Y 30 DT <Ecotec>	03.03-10.08	0 281 002 605
			Z 30 DT <Ecotec>	09.05-10.08	0 281 002 773
<b>Vectra Estate</b>					
1.9 CDTI [C]	1,9	74/88/ 110	Z 19 DT <Ecotec>; Z 19 DTH <Ecotec>; Z 19 DTL <Ecotec>	04.04-10.08	0 281 002 683
2.0 DI [B]	2,0	60	X 20 DTL <Ecotec 16V Turbo>		
			Fg.-Nr. W1000001→ Fg.-Nr. →V7999999	09.96-08.00 09.96-08.00	0 281 002 180 0 281 002 139
DTI [B]	2,0	74	X 20 DTH <16V Turbo> Y 20 DTH <Ecotec>	09.97-08.00 09.00-08.01	0 281 002 180 0 281 002 428
DTI [C]	2,0	74	Y 20 DTH <Ecotec>	09.03-09.05	0 281 002 479
2.2 DTI [B]	2,2	92	Y 22 DTR <Turbo>	09.00-08.01	0 281 002 428
DTI [C]	2,2	86-92	Y 22 DTR <Ecotec>	09.03-09.05	0 281 002 479
3.0 CDTI [C]	3,0	130-135	Y 30 DT <Ecotec>	09.03-10.08	0 281 002 605
			Z 30 DT <Ecotec>	09.05-10.08	0 281 002 773
<b>Zafira</b>					
1.6 CDTI [C]	1,6	100	B 16 DTH	05.13→	0 280 218 254
1.7 CDTI [B]	1,7	81/92	A 17 DTJ <Ecotec>; A 17 DTR <Ecotec>; Z 17 DTJ <Turbo Ecotec>; Z 17 DTR <Turbo Ecotec>	03.08-01.15	0 281 002 832
2.0 CDTI [C]	2,0	81/96/ 121/143	A 20 DT <ecoFLEX>; A 20 DTH <Ecotec>; A 20 DTL <Ecotec>; A 20 DTR <Ecotec>	01.12→	0 281 002 912
		125	B 20 DTH	02.15→	0 280 218 254
DI [A]	2,0	60	X 20 DTL <Turbo Ecotec>		
			Fg.-Nr. →Y8999999 →YT999999 Mot.-Nr. 12000001→1T000001→	03.99-08.00 03.99-08.00	0 281 002 180 0 281 002 428
DTI [A]	2,0	74	Y 20 DTH <Ecotec>		
			Fg.-Nr. →Y2999999 →Y5999999 →Y6999999 →Y8999999 →YH999999	04.99-06.05	0 281 002 180
			Fg.-Nr. 12000001→22999999 15000001→25999999 16000001→26999999 18000001→28999999 1H000001→2H999999	04.99-06.05	0 281 002 428
			Fg.-Nr. 32000001→35000001→36000001→ 38000001→3H000001→3H000001→	04.99-06.05	0 281 002 478
<b>VOLVO</b>					
<b>C30</b>					
2.0 D3, D4 [P14]	2,0	110/130	D5204T; D5204T5	08.10→	0 281 006 346
2.4 D5 [P14]	2,4	120/132	D5244T8...; D5244T9	10.06-07.10	0 281 002 730
<b>C70 II Cabrio</b>					
2.0 D3, D4	2,0	110/130	D5204T; D5204T5	10.10-07.13 TW	0 281 002 972
					0 281 006 346
2.4 D, D5	2,4	120/132	D5244T8...; D5244T9	08.06-07.10	0 281 002 730



◀ VOLVO

S40 II						
2.0 D3, D4 [P11]	2,0	110/130	D5204T; D5204T5		08.10-08.12	0 281 002 972
2.4 D5 [P11]	2,4	120/132	D5244T8...; D5244T9			
			Fg.-Nr. →533875		03.06-07.10	0 281 002 730
			Fg.-Nr. 533876→		03.06-07.10	0 281 006 184
S60 I						
2.4 D	2,4	85/96/120	D5244T; D5244T2; D5244T3		08.01-07.06	0 280 218 088
D, D5	2,4	90/93/120/136	D5244T4; D5244T5; D5244T6; D5244T7		08.05-07.09	0 281 002 730
S60 II						
2.0 D3, D4	2,0	100/120	D5204T2; D5204T3; D5204T7		08.10→	0 281 002 972
2.4 D5, D5 AWD	2,4	151/158	D5244T10; D5244T11; D5244T15		08.10→	0 281 002 972
S70						
2.5 TDI	2,5	103	D5252T			
			Fg.-Nr. →596595		01.97-07.00	0 281 002 155
			Fg.-Nr. 596596→		01.97-07.00	0 280 218 108
S80 I						
2.4 D, D5	2,4	96/120	D5244T; D5244T2		08.01-07.06	0 280 218 088
2.5 TDI	2,5	103	D5252T		08.98-07.01	0 280 218 108
S80 II						
2.0 D3, D4	2,0	100/120	D5204T2; D5204T3; D5204T7		08.10→	0 281 002 972
2.4 D, D5, D5 AWD	2,4	120/129/151/158	D5244T10; D5244T11; D5244T14; D5244T15; D5244T19		11.08→	0 281 002 972
		120/136	D5244T4; D5244T5		03.06-07.09	0 281 002 730
V40 Cross Country						
2.0 D3, D4	2,0	110/130	D5204T4; D5204T6		01.13→	0 281 006 346
V40 II						
2.0 D3, D4	2,0	110/130	D5204T4; D5204T6		09.12→	0 281 006 346
V50						
2.0 D3, D4 [P12]	2,0	110/130	D5204T; D5204T5		08.10-12.12	0 281 002 972
2.4 D5 [P12]	2,4	120/132	D5244T9; D5244T13			
			Fg.-Nr. →599018		04.06-07.10	0 281 002 730
			Fg.-Nr. 599019→		04.06-07.10	0 281 006 184
V60						
2.0 D3, D4	2,0	100/120	D5204T2; D5204T3; D5204T7		09.10→	0 281 002 972
2.4 D4 AWD, D5, D5 AWD	2,4	120/133/158	D5244T11; D5244T12; D5244T15; D5244T17		09.11-08.15	0 281 006 346
D5, D5 AWD	2,4	151	D5244T10		09.10-08.11	0 281 002 972
V70 I						
2.5 TDI	2,5	103	D5252T			
			Fg.-Nr. →587536		01.97-03.00	0 281 002 155
			Fg.-Nr. 587537→		01.97-03.00	0 280 218 108
V70 II						
2.4 D, D AWD, D5, D5 AWD	2,4	96/120/136	D5244T; D5244T2; D5244T3		08.01-07.06	0 280 218 088
D, D5, D5 AWD	2,4	90/93/120/136	D5244T4; D5244T5; D5244T6; D5244T7		08.06-07.07	0 281 002 730
2.5 D	2,5	103	D5252T		03.00-07.01	0 280 218 108
V70 III						
2.0 D3, D3/D4	2,0	100/120	D5204T2; D5204T3; D5204T7		08.10-07.15	0 281 002 972
2.4 D, D4 AWD, D5, D5 AWD	2,4	120/129/133/151/158	D5244T10; D5244T11; D5244T12; D5244T14; D5244T15; D5244T17		08.09→	0 281 002 972
D, D5, D5 AWD	2,4	120/132-136	D5244T4; D5244T5		08.07-07.09	0 281 002 730
XC60						
2.0 D3	2,0	100	D5204T7		08.12-07.15	0 281 006 346
D3 DRIVE	2,0	120	D5204T2			
			Fg.-Nr. →50098		08.10-07.11	0 281 002 730
			Fg.-Nr. 50099→		08.10-07.11	0 281 002 972
D3 DRIVE, D4	2,0	120	D5204T3		08.11-07.15	0 281 002 972





<b>2.4 D AWD, D DRIVE</b>	2,4	120/129	D5244T14; D5244T16 Fg.-Nr. →50098 Fg.-Nr. 50099→	08.09-07.11 08.09-07.11	<b>0 281 002 730</b> <b>0 281 002 972</b>
D AWD, D5 AWD	2,4	120/136/ 151	D5244T4; D5244T5; D5244T10 Fg.-Nr. →50098 Fg.-Nr. 50099→	03.09-07.11 03.09-07.11	<b>0 281 002 730</b> <b>0 281 002 972</b>
D3 AWD, D5 AWD	2,4	120/169	D5244T17; D5244T23	08.11→	<b>0 281 002 972</b>
D4 AWD	2,4	133	D5244T12	08.13-07.15	<b>0 281 002 972</b>
D5 AWD	2,4	158	D 5244 T1...	08.11-07.15	<b>0 281 002 972</b>
<b>XC70 I</b>					
<b>2.4 D AWD</b>	2,4	120	D5244T	08.02-07.06	<b>0 280 218 088</b>
D5 AWD	2,4	136	D5244T4	12.05-07.07	<b>0 281 002 730</b>
<b>XC70 II</b>					
<b>2.0 D3 DRIVE</b>	2,0	120	D5204T2; D5204T3	08.10-07.15	<b>0 281 002 972</b>
<b>2.4 D AWD, D DRIVE, D3 AWD, D4 AWD, D5 AWD</b>	2,4	120/129/ 133/151/ 158	D5244T10; D5244T11; D5244T12; D5244T14; D5244T15; D5244T16; D5244T17	08.09→	<b>0 281 002 972</b>
D AWD, D5 AWD	2,4	120/136	D5244T4; D5244T5	08.07-07.09	<b>0 281 002 730</b>
<b>XC90 I</b>					
<b>2.4 D3, D5 AWD</b>	2,4	120/136	D5244T4; D5244T5 Fg.-Nr. →574466 Fg.-Nr. 574467→	05.05-07.15 05.05-07.15	<b>0 281 002 730</b> <b>0 281 006 184</b>
D5 AWD	2,4	120 147	D5244T D5244T18	01.03-07.06 08.10-07.15	<b>0 280 218 088</b> <b>0 281 006 184</b>
<b>850</b>					
<b>2.5 TDI</b>	2,5	103	D5252T	05.96-07.97	<b>0 281 002 155</b>
<b>850 Kombi</b>					
<b>2.5 TDI</b>	2,5	103	D5252T	05.96-07.97	<b>0 281 002 155</b>



**VW (VOLKSWAGEN)**

<b>Amarok</b>					
<b>2.0 BiTDI, BiTDI 4Motion, TDI, TDI 4Motion [2H, S1]</b>	2,0	90-103/ 120-132	CDBA <D45>; CDCA <D46>; CNEA <D49>; CNFA <D45>; CNFB <D91>; CSHA <D49>	09.10→	<b>0 281 002 956</b>
<b>Beetle</b>					
<b>2.0 TDI [5C1]</b>	2,0	81/103/ 110	CFFB <D91>; CUUA <DN1>; CUUB <DN4>	04.12-06.16	<b>0 281 002 956</b>
TDI [5C2]	2,0	81/110	CUUA <DN1>; CUUB <DN4>	07.16→	<b>0 281 002 956</b>
<b>Beetle Cabriolet</b>					
<b>2.0 TDI [5C7]</b>	2,0	81/103/ 110	CFFB <D91>; CUUA <DN1>; CUUB <DN4>	01.13→	<b>0 281 002 956</b>
TDI [5C8]	2,0	81/110	CUUA <DN1>; CUUB <DN4>	07.16→	<b>0 281 002 956</b>
<b>Bora</b>					
<b>1.9 TDI [1J2]</b>	1,9	74	AXR Fg.-Nr. →1J..2..380 000 →1J..2D420 000	05.01-10.01	<b>0 281 002 757</b>
				WW,XXX	<b>0 986 280 202</b>
			Fg.-Nr. 1J..2..380 001 → 1J..2D420 000 →	11.01-05.05	<b>0 281 002 531 0 986 284 009</b>
		81	ASV	05.00-05.05	<b>0 281 002 757</b>
				WW,XXX	<b>0 986 280 202</b>
TDI, TDI 4Motion [1J2]	1,9	66/81/85	AGR; AHF; AJM; ALH	09.98-05.05	<b>0 281 002 757</b>
				WW,XXX	<b>0 986 280 202</b>
		74	ATD Fg.-Nr. →1J..2..380 000 →1J..2D420 000	01.00-10.01	<b>0 281 002 757</b>
				WW,XXX	<b>0 986 280 202</b>
			Fg.-Nr. 1J..2..380 001 → 1J..2D420 000 →	11.01-05.05	<b>0 281 002 531 0 986 284 009</b>
		85	AUY	01.00-04.01	<b>0 281 002 757</b>
				WW,XXX	<b>0 986 280 202</b>
		96	ASZ Fg.-Nr. →1J..2..600 000	01.01-04.02	<b>0 280 217 529 0 986 280 204</b>
			Fg.-Nr. 1J..2..600 001 →	05.02-05.05	<b>0 281 002 461 0 986 284 007</b>



◀ VW

<b>1.9 TDI, TDI 4Motion [1J2]</b>	1,9	110	ARL				
				Fg.-Nr. →1J..2..600 000	01.00-04.02	<b>0 280 217 529</b>	<b>0 986 280 204</b>
				Fg.-Nr. 1J..2..600 001→	05.02-05.05	<b>0 281 002 461</b>	<b>0 986 284 007</b>

**Bora Variant**

<b>1.9 TDI [1J6]</b>	1,9	74	AXR				
				Fg.-Nr. →1J..2..380 000 →1J..2D420 000	05.01-10.01	<b>0 281 002 757</b>	
					WW,XXX		<b>0 986 280 202</b>
				Fg.-Nr. 1J..2..380 001→ 1J..2D420 000→	11.01-05.05	<b>0 281 002 531</b>	<b>0 986 284 009</b>
		81	ASV		05.00-05.05	<b>0 281 002 757</b>	
					WW,XXX		<b>0 986 280 202</b>
<b>TDI, TDI 4Motion [1J6]</b>	1,9	66/81/85	AGR; AHF; AJM		09.98-05.05	<b>0 281 002 757</b>	
					WW,XXX		<b>0 986 280 202</b>
		74	ATD				
				Fg.-Nr. →1J..2..380 000 →1J..2D420 000	05.00-10.01	<b>0 281 002 757</b>	
					WW,XXX		<b>0 986 280 202</b>
				Fg.-Nr. 1J..2..380 001→ 1J..2D420 000→	11.01-05.05	<b>0 281 002 531</b>	<b>0 986 284 009</b>
		85	AUY		01.00-04.01	<b>0 281 002 757</b>	
					WW,XXX		<b>0 986 280 202</b>
		96	ASZ				
				Fg.-Nr. →1J..2..600 000	01.01-04.02	<b>0 280 217 529</b>	<b>0 986 280 204</b>
				Fg.-Nr. 1J..2..600 001→	05.02-05.05	<b>0 281 002 461</b>	<b>0 986 284 007</b>
		110	ARL		05.02-05.05	<b>0 281 002 461</b>	<b>0 986 284 007</b>

**Caddy**

<b>1.9 TDI [9K9]</b>	1,9	66	ALH		09.00-06.03	<b>0 281 002 216</b>	<b>0 986 284 001</b>
<b>TDI, TDI 4Motion [2K]</b>	1,9	55/77	BJB <D3W>; BLS <D3W>; BSU <D4U>		02.04-08.10	<b>0 281 002 531</b>	<b>0 986 284 009</b>
<b>2.0 SDI [2K]</b>	2,0	51	BST <D0K>		06.05-08.10	<b>0 281 002 531</b>	<b>0 986 284 009</b>
<b>TDI [2K]</b>	2,0	103	BMM <D7N>		09.07-08.10	<b>0 281 002 461</b>	<b>0 986 284 007</b>
<b>TDI, TDI 4Motion [SA]</b>	2,0	55/75/81/90/103/110	CFHC <D91>; CFHF <D96>; CUUB <DN4>; CUUC <DS2>; CUUD <M0H>; CUUE <DN9>; CUUF <DS2>; DFSB <DN4>; DFSC <DS2>; DFSD <M0H>; DFSE <DN9>; DFSF <DS2>		05.15→	<b>0 281 002 956</b>	
<b>TDI, TDI 4Motion [2C]</b>	2,0	81/103/125	CFHC <D91>; CFHE; CFHF <D96>; CFJA <D93>; CLCA <D96>; CLCB <D91>		08.10-05.15	<b>0 281 002 956</b>	

**Caddy Panel Van**

<b>1.9 TDI [2K]</b>	1,9	77	BJB <D3W>		06.04→	<b>0 281 002 531</b>	<b>0 986 284 009</b>
---------------------	-----	----	-----------	--	--------	----------------------	----------------------

**CC**

<b>2.0 TDI, TDI 4Motion [358]</b>	2,0	100/103/110/125/130/135	CFFA <D94>; CFFB <D91>; CFGB <D93>; CFGC <DE2>; CLLA <D93>; CUVC <DN4>; CUWA <DK7>		11.11→	<b>0 281 002 956</b>	
-----------------------------------	-----	-------------------------	--	--	--------	----------------------	--

**Eos**

<b>2.0 TDI [1F7]</b>	2,0	103	BMM <D7N>		05.06-05.08	<b>0 281 002 461</b>	<b>0 986 284 007</b>
			CBAB <D91>		05.08-11.10	<b>0 281 002 735</b>	
<b>TDI [1F8]</b>	2,0	100/103	CFFA <D94>; CFFB <D91>		11.10-08.15	<b>0 281 002 956</b>	

**Fox**

<b>1.4 TDI [5Z1]</b>	1,4	51	BNM <D4S>		04.05-12.12	<b>0 281 002 531</b>	<b>0 986 284 009</b>
----------------------	-----	----	-----------	--	-------------	----------------------	----------------------

**Golf Alltrack**

<b>2.0 GTD 4Motion, TDI 4Motion [BA5]</b>	2,0	110/135	CRBC <DN4>; CRLB <DN4>; CUNA <DK7>		12.14→	<b>0 281 002 956</b>	
---	-----	---------	------------------------------------	--	--------	----------------------	--

**Golf IV**

<b>1.9 TDI [1J1]</b>	1,9	74	AXR				
				Fg.-Nr. →1J..2B088 000 →1J..2D420 000 →1J..2P055 000 →1J..2U030 000 →1J..2W350 000	05.01-11.01	<b>0 281 002 757</b>	
					WW,XXX		<b>0 986 280 202</b>
				Fg.-Nr. 1J..2B088 001→ 1J..2D420 001→ 1J..2P055 001→ 1J..2U030 001→ 1J..2W350 001→	12.01-05.04	<b>0 281 002 531</b>	<b>0 986 284 009</b>
		81	AHF		05.00-12.05	<b>0 281 002 757</b>	
					WW,XXX		<b>0 986 280 202</b>
				Fg.-Nr. 1J..XB045 001→ 1J..XW181 001→ 1J..XD092 001→ 1J..XP073 001→	08.98-05.04	<b>0 281 002 757</b>	
					WW,XXX		<b>0 986 280 202</b>
			ASV		05.00-05.04	<b>0 281 002 757</b>	
					WW,XXX		<b>0 986 280 202</b>



1.9 TDI [1J1]	1,9	96	ASZ	Fg.-Nr. →1J..2..600 000	04.01-04.02	<b>0 280 217 529</b>	<b>0 986 280 204</b>	
				Fg.-Nr. 1J..2..600 001→	05.02-05.04	<b>0 281 002 461</b>	<b>0 986 284 007</b>	
TDI, TDI 4Motion [1J1]	1,9	66	AGR	Fg.-Nr. 1J..XB045 001→ 1J..XD092 001→	08.98-09.02	<b>0 281 002 757</b>		
				1J..XP073 001→ 1J..XW181 001→		WW,XXX	<b>0 986 280 202</b>	
			66/85	AJM; ALH	10.97-05.04	<b>0 281 002 757</b>		
						WW,XXX	<b>0 986 280 202</b>	
			74	ATD	Fg.-Nr. →1J..2B088 000 →1J..2D420 000	02.00-11.01	<b>0 281 002 757</b>	
					→1J..2P055 000 →1J..2U030 000		WW,XXX	<b>0 986 280 202</b>
→1J..2W350 000								
		Fg.-Nr. 1J..2B088 001→ 1J..2D420 001→	12.01-06.05	<b>0 281 002 531</b>	<b>0 986 284 009</b>			
		1J..2P055 001→ 1J..2U030 001→						
		1J..2W350 001→						
TDI 4Motion	1,9	96	ASZ	Fg.-Nr. →1J..2..600 000	04.01-04.02	<b>0 280 217 529</b>	<b>0 986 280 204</b>	
				Fg.-Nr. 1J..2..600 001→	05.02-06.05	<b>0 281 002 461</b>	<b>0 986 284 007</b>	

**Golf IV Variant**

1.9 TDI [1J5]	1,9	66	ALH	Fg.-Nr. →1J..4..300 000	05.99-04.04	<b>0 281 002 757</b>		
						WW,XXX	<b>0 986 280 202</b>	
					Fg.-Nr. 1J..5..000 001→	05.04-06.06	<b>0 281 002 531</b>	<b>0 986 284 009</b>
			74	AXR	Fg.-Nr. →1J..2B088 000 →1J..2D420 000	05.01-11.01	<b>0 281 002 757</b>	
					→1J..2P055 000 →1J..2U030 000		WW,XXX	<b>0 986 280 202</b>
					→1J..2W350 000			
					Fg.-Nr. 1J..2B088 001→ 1J..2D420 001→	12.01-06.06	<b>0 281 002 531</b>	<b>0 986 284 009</b>
					1J..2P055 001→ 1J..2U030 001→			
					1J..2W350 001→			
			81	AHF	Fg.-Nr. →1J..4..300 000	05.99-04.04	<b>0 281 002 757</b>	
							WW,XXX	<b>0 986 280 202</b>
					Fg.-Nr. 1J..5..000 001→	05.04-06.06	<b>0 281 002 531</b>	<b>0 986 284 009</b>
		ASV	05.00-06.06	<b>0 281 002 757</b>				
				WW,XXX	<b>0 986 280 202</b>			
TDI, TDI 4Motion [1J5]	1,9	66	AGR	05.99-09.02	<b>0 281 002 757</b>			
					WW,XXX	<b>0 986 280 202</b>		
			74	ATD	Fg.-Nr. →1J..2B088 000 →1J..2D420 000	01.00-11.01	<b>0 281 002 757</b>	
					→1J..2P055 000 →1J..2U030 000	02.00-11.01	WW,XXX	<b>0 986 280 202</b>
					→1J..2W350 000			
					Fg.-Nr. 1J..2B088 001→ 1J..2D420 001→	12.01-06.06	<b>0 281 002 531</b>	<b>0 986 284 009</b>
					1J..2P055 001→ 1J..2U030 001→			
					1J..2W350 001→			
			85	AJM	05.99-07.01	<b>0 281 002 757</b>		
						WW,XXX	<b>0 986 280 202</b>	
	AUY	11.99-07.01	<b>0 281 002 757</b>					
			WW,XXX	<b>0 986 280 202</b>				
96	ASZ	Fg.-Nr. →1J..2..600 000	04.01-04.02	<b>0 280 217 529</b>	<b>0 986 280 204</b>			
		Fg.-Nr. 1J..2..600 001→	05.02-06.06	<b>0 281 002 461</b>	<b>0 986 284 007</b>			

**Golf Plus**

1.9 TDI [5M1]	1,9	66/77	BKC; BLS <D3W>; BRU; BXE <D3W>; BXF; BXJ	01.05-01.09	<b>0 281 002 531</b>	<b>0 986 284 009</b>
2.0 TDI [5M1]	2,0	96/100/103	AZV; BEE; BKD; BMM <D7N>	01.05-05.09	<b>0 281 002 461</b>	<b>0 986 284 007</b>















◀ VW

2.0 TDI [521]	2,0	81/100/103	CBDA <D94>; CBDB <D91>; CBDC <D96> CFHB <D94>; CFHC <D91>; CLCA <D96>	01.09-05.10 11.09-02.14	<b>0 281 002 735</b> <b>0 281 002 956</b>	
<b>Golf Sportsvan</b>						
2.0 TDI [AM1]	2,0	81/110	CRLB <DN4>; CRVA <DN1>	02.14→	<b>0 281 002 956</b>	
<b>Golf V</b>						
1.9 TDI, TDI 4Motion [1K1]	1,9	66/77	BKC; BLS <D3W>; BRU; BXE <D3W>; BXF	10.03-11.08	<b>0 281 002 531</b>	<b>0 986 284 009</b>
2.0 SDI [1K1]	2,0	55	BDK	01.04-11.08	<b>0 281 002 531</b>	<b>0 986 284 009</b>
TDI [1K1]	2,0	100	AZV	10.03-11.08	<b>0 281 002 461</b>	<b>0 986 284 007</b>
TDI, TDI 4Motion [1K1]	2,0	103/125	BKD; BMM <D7N>; BMN	10.03-11.08	<b>0 281 002 461</b>	<b>0 986 284 007</b>
<b>Golf V Variant</b>						
1.9 TDI, TDI 4Motion [1K5]	1,9	77	BLS <D3W>; BXE <D3W>	05.07-06.09	<b>0 281 002 531</b>	<b>0 986 284 009</b>
2.0 TDI [1K5]	2,0	100/103	CBDA <D94>; CBDB <D91>	07.08-07.09	<b>0 281 002 735</b>	
TDI, TDI 4Motion [1K5]	2,0	100/103	AZV; BKD; BMM <D7N>	05.07-06.09	<b>0 281 002 461</b>	<b>0 986 284 007</b>
<b>Golf VI</b>						
2.0 TDI [5K1]	2,0	81	CLCA <D96>	05.10-11.12	<b>0 281 002 956</b>	
		103	CJAA <D91>	09.09-11.12	<b>0 281 002 735</b>	
TDI, TDI 4Motion [5K1]	2,0	81/100/103/125	CBAA <D94>; CBAB <D91>; CBBB <D93>; CBDC <D96>	10.08-05.11	<b>0 281 002 735</b>	
		100/103/125	CFFA <D94>; CFFB <D91>; CFGB <D93>	11.09-11.12	<b>0 281 002 956</b>	
<b>Golf VI Cabriolet</b>						
2.0 TDI [517]	2,0	81/110	CUUA <DN1>; CUUB <DN4>	05.15→	<b>0 281 002 956</b>	
		103	CFHC <D91>	11.11-11.13	<b>0 281 002 956</b>	
<b>Golf VI Variant</b>						
2.0 TDI [AJ5]	2,0	81/100/103	CFHB <D94>; CFHC <D91>; CLCA <D96>	07.09-04.13	<b>0 281 002 956</b>	
		100/103	CBDA <D94>; CBDB <D91>	07.09-04.13	<b>0 281 002 735</b>	
		103	BMM <D7N>	07.09-04.13	<b>0 281 002 461</b>	<b>0 986 284 007</b>
<b>Golf VII</b>						
2.0 GTD, TDI, TDI 4Motion [5G1]	2,0	81/105/110/135	CRBB <DN6>; CRBC <DN4>; CRLB <DN4>; CRVA <DN1>; CRVC <DN6>; CUNA <DK7>; CYKB <DN1>	08.12→	<b>0 281 002 956</b>	
<b>Golf VII Variant</b>						
2.0 TDI, TDI 4Motion [BA5]	2,0	81/110/135	CKFC <DN4>; CRBC <DN4>; CRLB <DN4>; CRLD <DN1>; CRVA <DN1>; CUNA <DK7>; CYKB <DN1>	04.13→	<b>0 281 002 956</b>	
<b>Jetta</b>						
1.9 TDI [1K2]	1,9	77	BKC; BLS <D3W>; BXE <D3W>	09.05-10.10	<b>0 281 002 531</b>	<b>0 986 284 009</b>
2.0 TDI [1K2]	2,0	81	CLCA <D96>	01.10-10.10	<b>0 281 002 956</b>	
		100/103/125	AZV; BKD; BMM <D7N>; BMN CBDA <D94>; CBDB <D91>; CEGA <D93>	08.05-06.08 07.08-10.10	<b>0 281 002 461</b> <b>0 281 002 735</b>	<b>0 986 284 007</b>
TDI [162]	2,0	103	CFFB <D91>; CFHC <D91>; CLCB <D91>	10.10-07.14	<b>0 281 002 956</b>	
TDI [163]	2,0	81/103/110	CFFB <D91>; CLCA <D96>; CLCB <D91>; CUUA <DN1>; CUUB <DN4>	07.14→	<b>0 281 002 956</b>	
<b>Jetta V</b>						
2.0 TDI [1K6]	2,0	103	BKD	03.06→	<b>0 281 002 461</b>	<b>0 986 284 007</b>
<b>Lupo</b>						
1.2 TDI 3L [6X1]	1,2	45	ANY; AYZ	10.98-07.05	<b>0 280 218 002</b>	<b>0 986 280 205</b>
1.4 TDI [6X1]	1,4	55	AMF	06.98-07.05	<b>0 281 002 318</b>	<b>0 986 284 002</b>
<b>New Beetle</b>						
1.9 TDI [1C1/9C1]	1,9	66	ALH	01.98-06.04	<b>0 281 002 757</b>	
		74/77	ATD; BEW; BSW <D3W>	10.00-12.10	<b>0 281 002 531</b>	<b>0 986 284 009</b>
<b>New Beetle Cabriolet</b>						
1.9 TDI [1Y7]	1,9	74/77	AXR; BSW <D3W>	06.03-09.10	<b>0 281 002 531</b>	<b>0 986 284 009</b>
<b>Passat</b>						
1.9 TDI [3B2]	1,9	66	AHH AHU	08.97-11.00	<b>0 281 002 216</b>	<b>0 986 284 001</b>
		81	Fg.-Nr. WE118001/WP100001→ AFN	09.97-11.00	<b>0 281 002 216</b>	<b>0 986 284 001</b>
			Fg.-Nr. WE118001/WP100001→	09.97-11.00	<b>0 281 002 216</b>	<b>0 986 284 001</b>



									
<b>1.9 TDI [3B3]</b>	1,9	74	AVB						
				Fg.-Nr. →3B..2P241 613 →3B..2P240 805 →3B..2E262 022	10.00-10.01		<b>0 281 002 216</b>	<b>0 986 284 001</b>	
				Fg.-Nr. 3B..2P241 614 → 3B..2P240 806 → 3B..2E262 023 →	11.01-05.05		<b>0 281 002 463</b>	<b>0 986 284 008</b>	
TDI [3C2]	1,9	77	BKC; BLS <D3W>; BXE <D3W>		03.05-11.08		<b>0 281 002 531</b>	<b>0 986 284 009</b>	
TDI syncro [3B2]	1,9	81	AFN						
				Fg.-Nr. WE 106 001 → WP 090 001 →	08.97-11.00		<b>0 281 002 216</b>	<b>0 986 284 001</b>	
TDI, TDI syncro [3B2]	1,9	74/81/85	AJM; ATJ; AVB; AVG		01.98-11.00		<b>0 281 002 216</b>	<b>0 986 284 001</b>	
TDI, TDI 4Motion [3B3]	1,9	96	AVF; AWX						
				Fg.-Nr. →3B..1..400 000	10.00-04.01		<b>0 280 217 529</b>	<b>0 986 280 204</b>	
				Fg.-Nr. 3B..2..000 001 →	05.01-05.05		<b>0 281 002 461</b>	<b>0 986 284 007</b>	
<b>2.0 TDI [A32]</b>	2,0		CKRA		09.11-08.14		<b>0 281 002 956</b>		
TDI [3B3]	2,0	100	BGW		11.03-05.05		<b>0 281 002 461</b>	<b>0 986 284 007</b>	
TDI, TDI 4Motion [3C2]	2,0	81/100/ 103/105/ 125	CBAA <D94>; CBAB <D91>; CBAC <D92>; CBBB <D93>; CBDC <D96>		05.08-11.10		<b>0 281 002 735</b>		
		88/90/ 100/103/ 120/125	BKP; BMA; BMP; BMR; BUZ; BVE; BWV		03.05-06.08		<b>0 281 002 461</b>	<b>0 986 284 007</b>	
TDI, TDI 4Motion [3G2]	2,0	81/110/ 140	CRLB <DN4>; CRLD <DN1>; DDAA <DE5>; DFCA <DE5>; DFEA <DN4>; DFGA <DN4>		08.14 →		<b>0 281 002 956</b>		
TDI, TDI 4Motion [362]	2,0	100/103/ 125/130	CFFA <D94>; CFFB <D91>; CFGB <D93>; CFGC <DE2>; CLLA <D93>		08.10-12.14		<b>0 281 002 956</b>		
<b>2.5 TDI [3B2]</b>	2,5	110	AKN		08.98-11.00		<b>0 281 002 224</b>		
TDI syncro [3B2]	2,5	110	AKN						
				Fg.-Nr. →3B..Y..200 000	08.98-11.99		<b>0 281 002 224</b>		
				Fg.-Nr. 3B..Y..200 001 →	12.99-11.00		<b>0 281 002 403</b>	<b>0 986 284 004</b>	
TDI, TDI syncro [3B2]	2,5	110	AFB		08.98-11.00		<b>0 281 002 224</b>		
<b>Passat Alltrack</b>									
<b>2.0 TDI, TDI 4Motion [365]</b>	2,0	103/125/ 130	CFFB <D91>; CFGB <D93>; CFGC <DE2>		01.12-12.14		<b>0 281 002 956</b>		
TDI 4Motion [3G5]	2,0	110/140	CRLB <DN4>; DDAA <DE5>; DFCA <DE5>; DFEA <DN4>		05.15 →		<b>0 281 002 956</b>		
<b>Passat CC</b>									
<b>2.0 TDI, TDI 4Motion [357]</b>	2,0	100/103/ 105/125	CBAA <D94>; CBAB <D91>; CBAC <D92>; CBBB <D93>		05.08-11.10		<b>0 281 002 735</b>		
		100/103/ 125	CFFA <D94>; CFFB <D91>; CFGB <D93>		11.10-05.12		<b>0 281 002 956</b>		
<b>Passat Variant</b>									
<b>1.9 TDI [3B5]</b>	1,9	66	AHH AHU		05.98-11.00		<b>0 281 002 216</b>	<b>0 986 284 001</b>	
				Fg.-Nr. WE118001/WP100001 →	09.97-11.00		<b>0 281 002 216</b>	<b>0 986 284 001</b>	
		81	AFN						
				Fg.-Nr. WE118001/WP100001 →	09.97-11.00		<b>0 281 002 216</b>	<b>0 986 284 001</b>	
TDI [3B6]	1,9	74	AVB						
				Fg.-Nr. →3B..2P241 613 →3B..2P240 805 →3B..2E262 022	10.00-10.01		<b>0 281 002 216</b>	<b>0 986 284 001</b>	
				Fg.-Nr. 3B..2P241 614 → 3B..2P240 806 → 3B..2E262 023 →	11.01-05.05		<b>0 281 002 463</b>	<b>0 986 284 008</b>	
TDI [3C5]	1,9	77	BKC; BLS <D3W>; BXE <D3W>		08.05-11.08		<b>0 281 002 531</b>	<b>0 986 284 009</b>	
TDI syncro [3B5]	1,9	81	AFN						
				Fg.-Nr. WE 106 001 → WP 090 001 →	08.97-08.00		<b>0 281 002 216</b>	<b>0 986 284 001</b>	
TDI, TDI syncro [3B5]	1,9	74/81/85	AJM; ATJ; AVB; AVG		01.99-11.00		<b>0 281 002 216</b>	<b>0 986 284 001</b>	
TDI, TDI 4Motion [3B6]	1,9	96	AVF; AWX						
				Fg.-Nr. →3B..1..400 000	10.00-04.01		<b>0 280 217 529</b>	<b>0 986 280 204</b>	
				Fg.-Nr. 3B..2..000 001 →	05.01-05.05		<b>0 281 002 461</b>	<b>0 986 284 007</b>	
<b>2.0 TDI [3B6]</b>	2,0	100	BGW		11.03-05.05		<b>0 281 002 461</b>	<b>0 986 284 007</b>	
TDI, TDI 4Motion [3C5]	2,0	81/100/ 103/105/ 125	CBAA <D94>; CBAB <D91>; CBAC <D92>; CBBB <D93>; CBDC <D96>		01.08-11.10		<b>0 281 002 735</b>		





◀ VW

<b>2.0</b>	TDI, TDI 4Motion [3C5]	2,0	88/90/100/103/120/125	BKP; BMA; BMP; BMR; BUZ; BVE; BWV	08.05-06.08	<b>0 281 002 461</b>	<b>0 986 284 007</b>
	TDI, TDI 4Motion [3G5]	2,0	81/110/140	CRLB <DN4>; CRLD <DN1>; DDAA <DE5>; DFCA <DE5>; DFEA <DN4>; DFGA <DN4>	11.14→	<b>0 281 002 956</b>	
	TDI, TDI 4Motion [365]	2,0	100/103/125/130	CFFA <D94>; CFFB <D91>; CFGB <D93>; CFGC <DE2>; CLLA <D93>	08.10-12.14	<b>0 281 002 956</b>	
<b>2.5</b>	TDI [3B5]	2,5	110	AKN	05.99-11.00	<b>0 281 002 224</b>	
	TDI syncro [3B5]	2,5	110	AKN	Fg.-Nr. →3B..Y..200 000 Fg.-Nr. 3B..Y..200 001→	05.99-11.99 12.99-08.00	<b>0 281 002 224</b> <b>0 281 002 403</b> <b>0 986 284 004</b>
	TDI, TDI syncro [3B5]	2,5	110	AFB	08.98-11.00	<b>0 281 002 224</b>	
<b>Phaeton</b>							
<b>5.0</b>	TDI 4Motion [3D]	5,0	230	AJS	11.02-10.06	<b>0 281 002 461</b>	<b>0 986 284 007</b>
<b>Polo</b>							
<b>1.2</b>	TDI [6R1]	1,2	55	CFWA <D28>	10.09-02.14	<b>0 281 006 132</b>	
<b>1.4</b>	TDI [6N2]	1,4	55	AMF	10.99-09.01	<b>0 281 002 318</b>	<b>0 986 284 002</b>
	TDI [9N1]	1,4	55	AMF; BAY	Fg.-Nr. →9N..2..120 000	09.01-04.02	<b>0 281 002 757</b>
					Fg.-Nr. 9N..3..000 001→	05.02-06.05	<b>0 281 002 531</b> <b>0 986 284 009</b>
	TDI [9N2]	1,4	55	BAY	07.03-05.07	<b>0 281 002 531</b>	<b>0 986 284 009</b>
	TDI [9N3]	1,4	51/58/59	BMS; BNM <D4S>; BNV; BWB	04.05-12.09	<b>0 281 002 531</b>	<b>0 986 284 009</b>
	TDI [9N4]	1,4	58	BNV	04.05→	<b>0 281 002 531</b>	<b>0 986 284 009</b>
	TDI [9V4]	1,4	55	AMF	10.02-12.03	<b>0 281 002 757</b>	
<b>1.9</b>	TDI [9N1]	1,9	74	ATD; AXR	Fg.-Nr. →9N..2..120 000	09.01-04.02	<b>0 281 002 757</b>
					Fg.-Nr. 9N..3..000 001→	05.02-05.05	<b>0 281 002 531</b> <b>0 986 284 009</b>
			96	ASZ	11.03-05.05	<b>0 281 002 461</b>	<b>0 986 284 007</b>
				BLT	05.04-05.05	<b>0 281 002 461</b>	<b>0 986 284 007</b>
	TDI [9N3]	1,9	74	ATD; AXR	04.05-12.09	<b>0 281 002 531</b>	<b>0 986 284 009</b>
				BMT	05.06-12.09	<b>0 281 002 531</b>	<b>0 986 284 009</b>
			96	ASZ	04.05-12.09	<b>0 281 002 461</b>	<b>0 986 284 007</b>
				BLT	04.05-12.09	<b>0 281 002 461</b>	<b>0 986 284 007</b>
<b>Polo Classic</b>							
<b>1.9</b>	TDI	1,9	66	AGR	09.00-08.08	<b>0 281 002 216</b>	<b>0 986 284 001</b>
	TDI [6V2]	1,9	66/81	AGR; ALH; ASV	10.99-09.01	<b>0 281 002 216</b>	<b>0 986 284 001</b>
<b>Polo Variant</b>							
<b>1.9</b>	TDI [6V5]	1,9	66/81	AGR; ALH; ASV	10.99-09.01	<b>0 281 002 216</b>	<b>0 986 284 001</b>
<b>Scirocco III</b>							
<b>2.0</b>	TDI [137]	2,0	100/103/125/130	CFGB <D93>; CFGC <DE2>; CFHB <D94>; CFHC <D91>	11.10-05.14	<b>0 281 002 956</b>	
			103/125	CBBB <D93>; CBDB <D91>	10.08-11.10	<b>0 281 002 735</b>	
	TDI [138]	2,0	110/132/135	CUUB <DN4>; CUWA <DK7>; CUXA <DN4>	05.14→	<b>0 281 002 956</b>	
<b>Sharan</b>							
<b>1.9</b>	TDI [7M8]	1,9	66/81	AFN; AHU	Fg.-Nr. 7M..W..020 001→	08.97-02.00	<b>0 281 002 757</b>
					ANU; AVG	03.99-02.00	<b>0 281 002 757</b>
						WW,XXX	<b>0 986 280 202</b>
						WW,XXX	<b>0 986 280 202</b>
	TDI [7M9, 7M6]	1,9	66	ANU	04.00-03.10	<b>0 281 002 757</b>	
			96	ASZ	11.02-03.10	<b>0 281 002 461</b>	<b>0 986 284 007</b>
			110	BTB	01.05-06.06	<b>0 281 002 461</b>	<b>0 986 284 007</b>
	TDI, TDI 4Motion [7M9, 7M6]	1,9	85	AUY	05.00-03.10	<b>0 281 002 757</b>	
				BVK	11.05-03.10	<b>0 281 002 531</b>	<b>0 986 284 009</b>
<b>2.0</b>	TDI [7M9, 7M6]	2,0	100/103	BRT; BVH	11.05-03.10	<b>0 281 002 461</b>	<b>0 986 284 007</b>
	TDI, TDI 4Motion [7N1]	2,0	85/100/103/125/130	CFFA <D94>; CFFB <D91>; CFFE <DE4>; CFGB <D93>; CFGC <DE2>	05.10-11.15	<b>0 281 002 956</b>	
	TDI, TDI 4Motion [7N2]	2,0	85/110/135	CUVA <DE4>; CUVC <DN4>; CUWA <DK7>; DFLA <DN4>; DFLD <DE4>; DFMA <DK7>	05.15→	<b>0 281 002 956</b>	





<b>Tiguan</b>						
2.0 TDI, TDI 4Motion [AD1]	2,0	85/110/140	DFGA <DN4>; DFGC <DE4>; DFHA <DE5>		01.16→	<b>0 281 002 956</b>
TDI, TDI 4Motion [5N1]	2,0	81/100/103/125	CFFA <D94>; CFFB <D91>; CFFD <D96>; CFGB <D93>; CLJA <D91>		11.09-05.11	<b>0 281 002 956</b>
		100/103/120/125	CBAA <D94>; CBAB <D91>; CBBA <D95>; CBBB <D93>		11.07-05.11	<b>0 281 002 735</b>
TDI, TDI 4Motion [5N2]	2,0	81/100/103/110/125/130/135	CFFA <D94>; CFFB <D91>; CFFD <D96>; CFGB <D93>; CFGC <DE2>; CLJA <D91>; CUVC <DN4>; CUVE <DN1>; CUWA <DK7>		05.11→	<b>0 281 002 956</b>
<b>Touareg</b>						
2.5 TDI [7LA]	2,5	120/128	BAC; BLK		01.03-11.06	<b>0 281 002 461 0 986 284 007</b>
			BPD; BPE		01.06-11.06	<b>0 281 002 735</b>
TDI [7L6]	2,5	120/128	BPD; BPE		12.06-05.10	<b>0 281 002 735</b>
5.0 TDI [7LA]	5,0	230	AYH; BLE		11.02-11.06	<b>0 281 002 461 0 986 284 007</b>
TDI [7L6]	5,0	230/258	BLE; CBWA		12.06-05.10	<b>0 281 002 461 0 986 284 007</b>
<b>Touran</b>						
1.9 TDI [1T1]	1,9	66/74/77	AVQ; BKC; BLS <D3W>; BRU; BXE <D3W>; BXF; BXJ		02.03-11.06	<b>0 281 002 531 0 986 284 009</b>
TDI [1T2]	1,9	66/77	BLS <D3W>; BXE <D3W>; BXF; BXJ		11.06-05.10	<b>0 281 002 531 0 986 284 009</b>
2.0 TDI [1T1]	2,0	100/103/125	AZV; BKD; BMM <D7N>; BMN		02.03-11.06	<b>0 281 002 461 0 986 284 007</b>
TDI [1T2]	2,0	100/103/125	AZV; BKD; BMM <D7N>; BMN		11.06-05.10	<b>0 281 002 461 0 986 284 007</b>
TDI [1T3]	2,0	81/103/125/130	CFHC <D91>; CFHF <D96>; CFJA <D93>; CFJB <DE2>; CLCA <D96>		05.10-05.15	<b>0 281 002 956</b>
TDI [5T1]	2,0	81/110/150	CRVA <DN1>; CYKB <DN1>; DFEA <DN4>; DFEB <DN1>; DFGA <DN4>; DFGB <DN1>; DFHA <DE5>		05.15→	<b>0 281 002 956</b>





**CITROEN**

<b>Jumper</b>						
2.8 HDi [U5]	2,8	94/107	8140 43N <SOFIM 2800 HDi>; 8140.43S	02.02-05.06		<b>0 281 002 184</b>
HDi [23]	2,8	94	8140.43S	09.00-02.02		<b>0 281 002 184</b>
HDI	2,8	93	8140.43S	09.05-09.09		<b>0 281 002 184</b>

**FIAT**

<b>Ducato</b>						
<b>110</b> Multijet [250]	2,3	83	F1AE3481G	10.11-12.14	GS	<b>0 281 006 056</b>
					HAG	<b>0 281 006 054</b>
Multijet [290]	2,3	83	F1AE3481G	05.14->		<b>0 281 006 054</b>
<b>115</b> Multijet [250]	2,0	85	250 A1.000	06.11-12.14		<b>0 281 006 056</b>
				Multijet [290]	2,0	85
<b>130</b> Multijet [250]	2,3	96	F1AE3481D	06.11-12.14	GS	<b>0 281 006 056</b>
					HAG	<b>0 281 006 054</b>
				Multijet [290]	2,3	96
<b>150</b> Multijet [250]	2,3	109	F1AE3481E	06.11-12.14	GS	<b>0 281 006 056</b>
					HAG	<b>0 281 006 054</b>
				Multijet [290]	2,3	109
					HAG	<b>0 281 006 054</b>
<b>180</b> Multijet [250]	3,0	130	F1CE3481E	06.11-12.14		<b>0 281 006 056</b>
				Multijet [290]	3,0	130
<b>Ducato Maxi 17</b>						
<b>120</b> Multijet [250]	2,3	88	F1AE0481D <M94>	06.06-12.14		<b>0 281 006 048</b>
<b>130</b> Multijet [250]	2,3	96	F1AE0481N <M95>	06.06-12.14		<b>0 281 006 048</b>
<b>160</b> Multijet [250]	3,0	116	F1CE0481D <M96>	06.06-12.14	TW	<b>0 281 006 048</b>
				07.13-12.14	TW	<b>0 281 006 056</b>
<b>Ducato Maxi 20</b>						
<b>120</b> Multijet [250]	2,3	88	F1AE0481D <M94>	06.06-12.14		<b>0 281 006 048</b>
<b>130</b> Multijet [250]	2,3	96	F1AE0481N <M95>	06.06-12.14		<b>0 281 006 048</b>
<b>160</b> Multijet [250]	3,0	116	F1CE0481D <M96>	06.06-12.14	TW	<b>0 281 006 048</b>
				07.13-12.14	TW	<b>0 281 006 056</b>
<b>Ducato 10</b>						
<b>2.5</b> TD ECO [230]	2,5	80	8140.47R <M7>	03.94-03.98		<b>0 281 002 087</b>
<b>2.8</b> JTD EGR, JTD EGR 4x4 [230]	2,8	94	8140.43S <M14>	08.00-03.02		<b>0 281 002 184</b>
<b>Ducato 11</b>						
<b>2.3</b> JTD, JTD EGR [244]	2,3	81	F1AE0481C <M10>; F1AE0481C <M11>	04.02-08.06		<b>0 281 002 565</b>
<b>2.8</b> JTD EGR, JTD EGR 4x4 [244]	2,8	94	8140.43S <M15>	04.02-08.06		<b>0 281 002 184</b>
<b>120</b> Multijet [250]	2,3	88	F1AE0481D <M94>	06.06-12.14		<b>0 281 006 048</b>
<b>130</b> Multijet [250]	2,3	96	F1AE0481N <M95>	06.06-12.14		<b>0 281 006 048</b>
<b>160</b> Multijet [250]	3,0	116	F1CE0481D <M96>	06.06-12.14	TW	<b>0 281 006 048</b>
				07.13-12.14	TW	<b>0 281 006 056</b>
<b>Ducato 14</b>						
<b>2.5</b> TD ECO, TD ECO 4x4 [230]	2,5	80	8140.47R <M7>	03.94-03.98		<b>0 281 002 087</b>
<b>2.8</b> JTD EGR, JTD EGR 4x4 [230]	2,8	94	8140.43S <M14>	08.00-03.02		<b>0 281 002 184</b>
<b>Ducato 15</b>						
<b>2.3</b> JTD [244]	2,3	81	F1AE0481C <M10>	04.02-08.06		<b>0 281 002 565</b>
				JTD EGR [244]	2,3	81
				01.08-12.11		<b>0 281 006 048</b>
<b>2.8</b> JTD EGR, JTD EGR 4x4 [244]	2,8	94	8140.43S <M15>	04.02-08.06		<b>0 281 002 184</b>
<b>120</b> Multijet [250]	2,3	88	F1AE0481D <M94>	06.06-12.14		<b>0 281 006 048</b>
<b>130</b> Multijet [250]	2,3	96	F1AE0481N <M95>	06.06-12.14		<b>0 281 006 048</b>
<b>160</b> Multijet [250]	3,0	116	F1CE0481D <M96>	06.06-12.14	TW	<b>0 281 006 048</b>
				07.13-12.14	TW	<b>0 281 006 056</b>
<b>Ducato 17</b>						
<b>120</b> Multijet [250]	2,3	88	F1AE0481D <M94>	06.06-12.14		<b>0 281 006 048</b>
<b>130</b> Multijet [250]	2,3	96	F1AE0481N <M95>	06.06-12.14		<b>0 281 006 048</b>
<b>150</b> Multijet [250]	3,0	107	F1CE3481N <M97>	07.13-12.14		<b>0 281 006 056</b>





<b>160 Multijet [250]</b>	3,0	116	F1CE0481D <M96>	06.06-12.14 TW	<b>0 281 006 048</b>
				07.13-12.14 TW	<b>0 281 006 056</b>
<b>Ducato 18</b>					
<b>2.3 JTD [244]</b>	2,3	81	F1AE0481C <M10>	04.02-08.06	<b>0 281 002 565</b>
JTD EGR [244]	2,3	81	F1AE0481C <M11>	01.08-12.11	<b>0 281 006 048</b>
<b>2.5 TD ECO [230]</b>	2,5	80	8140.47R <M7>	03.94-03.98	<b>0 281 002 087</b>
<b>2.8 JTD EGR, JTD EGR 4x4 [230]</b>	2,8	94	8140.43S <M14>	08.00-03.02	<b>0 281 002 184</b>
JTD EGR, JTD EGR 4x4 [244]	2,8	94	8140.43S <M15>	04.02-08.06	<b>0 281 002 184</b>
<b>Ducato 20</b>					
<b>150 Multijet [250]</b>	3,0	107	F1CE3481N <M97>	07.13-12.14	<b>0 281 006 056</b>
<b>160 Multijet [250]</b>	3,0	115	F1CE3481M <M99>	09.10-12.14 TW	<b>0 281 006 048</b>
				07.13-12.14 TW	<b>0 281 006 056</b>

**HYUNDAI**

<b>H 100</b>					
<b>2.5 CRDi</b>	2,5	95	D4CB <(6A) A25/(6B) A25B>	01.09→	<b>0 281 002 721</b>
<b>H-1</b>					
<b>2.5 CRDi</b>	2,5	81/103	D4CB	12.01-12.07	<b>0 281 002 554</b>
CRDi Cargo, CRDi Travel	2,5	81-85/ 100/120- 125	D4CB... <(6A) A25>; D4CB <(6A) A25>; D4CB... <(6A) A25/(6B) A25B>; D4CB <(6A) A25/(6B) A25B>	03.08→	<b>0 281 002 721</b>
<b>Starex</b>					
<b>2.5 CRDi</b>	2,5	103/107	<A2,51Gen>; D4CB	10.02→	<b>0 281 002 554</b>

**IVECO**

<b>CityClass</b>					
<b>45 S 17</b>	3,0	125	F1CDS <Euro 5 / P-7 (EGR)>	10.12→	<b>0 281 006 056</b>
<b>55 S 17</b>	3,0	125	F1CDS <Euro 5 / P-7 (EGR)>	10.12→	<b>0 281 006 056</b>
<b>Daily</b>					
<b>29 L 10, 12, 14 [06]</b>	2,3	71/85/ 100	F1AE0481F*...; F1AE0481G*...; F1AE0481H*...	04.06-12.11 TW	<b>0 281 006 048</b>
					<b>0 281 006 056</b>
11, 13, 15 [12]	2,3	78/93/ 146	F1AE3481A*A0...; F1AE3481B*A0...; F1AE3481C..	07.11-07.14	<b>0 281 006 056</b>
<b>33 S 11, 13, 15 [14]</b>	2,3	78/93/ 107	F1AFL411A*A; F1AFL411B*A; F1AFL411C*A	05.14→	<b>0 281 006 056</b>
<b>35 -10 Turbo I.D.</b>	2,5	80	8140.47R.2790	07.92-04.97	<b>0 281 002 087</b>
<b>35 C 10, 12, 14 [06]</b>	2,3	71/85/ 100	F1AE0481F*B...; F1AE0481G*...; F1AE0481H...; F1AE0481R..	04.06-12.11 TW	<b>0 281 006 048</b>
					<b>0 281 006 056</b>
11, 13 [09]	2,3	78/93	F1AE0481U*...; F1AE0481V*...	06.09-12.11 TW	<b>0 281 006 048</b>
					<b>0 281 006 056</b>
11, 13, 15 [12]	2,3	78/93/ 107	F1AE3481A*A0...; F1AE3481B*A0...; F1AE3481C*A034	07.11-07.14	<b>0 281 006 056</b>
11, 13, 15 [14]	2,3	78/93/ 107	F1AFL411A*A; F1AFL411B*A; F1AFL411C*A	05.14→	<b>0 281 006 056</b>
14, 17 [09]	3,0	103/125	F1CE3481C*...; F1CE3481L*C..	06.09-12.11 TW	<b>0 281 006 048</b>
					<b>0 281 006 056</b>
15, 17, 21 [12]	3,0	107/125/ 150	F1CE3481...; F1CE3481D*B13...	07.11-07.14	<b>0 281 006 056</b>
15, 18 [06]	3,0	107/130	F1CE0481F*...; F1CE0481H*...	04.06-12.11 TW	<b>0 281 006 048</b>
					<b>0 281 006 056</b>
17, 21 [14]	3,0	125/150	F1CFL411G*C; F1CFL411H*C	05.14→	<b>0 281 006 056</b>
<b>35 S 10, 12, 14 [06]</b>	2,3	71/85/ 100	F1AE0481F*...; F1AE0481G...; F1AE0481H*...; F1AE0481R..	04.06-12.11 TW	<b>0 281 006 048</b>
					<b>0 281 006 056</b>
11, 13 [09]	2,3	78/93	F1AE0481U*...; F1AE0481V*...	06.09-12.11 TW	<b>0 281 006 048</b>
					<b>0 281 006 056</b>
11, 13, 15 [12]	2,3	78/93/ 107	F1AE3481A...; F1AE3481B*A0...; F1AE3481C..	07.11-07.14	<b>0 281 006 056</b>
11, 13, 15 [14]	2,3	78/93/ 107	F1AFL411A*A; F1AFL411B*A; F1AFL411C*A	05.14→	<b>0 281 006 056</b>







◀ IVECO

<b>35 S</b> 14, 17, 18 [09]	3,0	103/125/130	F1CE3481C*...; F1CE3481H...; F1CE3481L*C..	06.09-12.11	TW	<b>0 281 006 048</b> <b>0 281 006 056</b>
15, 17, 21 [12]	3,0	107/125/150	F1CE3481...; F1CE3481D..	07.11-07.14		<b>0 281 006 056</b>
15, 18 [06]	3,0	107/130	F1CE0481...; F1CE0481H*..	04.06-12.11	TW	<b>0 281 006 048</b> <b>0 281 006 056</b>
17, 21 [14]	3,0	125/150	F1CFL411F*C; F1CFL411G*C; F1CFL411H*C	05.14→		<b>0 281 006 056</b>
<b>40 C</b> 10, 12 [06]	2,3	71/85	F1AE0481F...; F1AE0481G..	04.06-05.09	TW	<b>0 281 006 048</b> <b>0 281 006 056</b>
11, 13 [09]	2,3	78/93	F1AE0481U...; F1AE0481V..	06.09-12.11	TW	<b>0 281 006 048</b> <b>0 281 006 056</b>
11, 13 [12]	2,3	78/93	F1AE3481A*A00...; F1AE3481B*A00...	01.12-07.14		<b>0 281 006 056</b>
14, 17 [09]	3,0	103/125	F1CE3481C...; F1CE3481CC..	06.09-12.11	TW	<b>0 281 006 048</b> <b>0 281 006 056</b>
15, 17, 21 [12]	3,0	107/125/150	F1CE3481...; F1CE3481D*B13...	01.12-07.14		<b>0 281 006 056</b>
15, 17, 21 [14]	3,0	107/125/150	F1CFL411F*C; F1CFL411G*C; F1CFL411H*C; F1CFL411J*C	05.14→		<b>0 281 006 056</b>
15, 18 [06]	3,0	107/130	F1CE0481...; F1CE0481H..	04.06-12.11	TW	<b>0 281 006 048</b> <b>0 281 006 056</b>
<b>45 C</b> 14, 15, 17 [09]	3,0	103/107/125	F1CE0481F...; F1CE0481HA...; F1CE3481L..	07.09-12.11	TW	<b>0 281 006 048</b> <b>0 281 006 056</b>
15, 18 [06]	3,0	107/130	F1CE0481F...; F1CE0481H..	04.06-12.11	TW	<b>0 281 006 048</b> <b>0 281 006 056</b>
<b>45 S</b> 17	3,0	125	F1C DS <Euro 5 / P-7 (EGR)>	04.12→		<b>0 281 006 056</b>
<b>50 C</b> 12 [06]	2,3	85	F1AE0481G..	04.06-12.11	TW	<b>0 281 006 048</b> <b>0 281 006 056</b>
14, 17 [09]	3,0	103/125	F1CE3481C*...; F1CE3481L*C..	06.09-12.11	TW	<b>0 281 006 048</b> <b>0 281 006 056</b>
15, 17, 21 [12]	3,0	107/125/150	F1CE3481...; F1CE3481D*B13...	07.11-07.14		<b>0 281 006 056</b>
15, 17, 21 [14]	3,0	107/125/150	F1CFL411E*C; F1CFL411F*C; F1CFL411G*C; F1CFL411H*C; F1CFL411J*C	05.14→		<b>0 281 006 056</b>
15, 18 [06]	3,0	107/130	F1CE0481...; F1CE0481H..	04.06-12.11	TW	<b>0 281 006 048</b> <b>0 281 006 056</b>
<b>55 S</b> 17	3,0	125	F1CFL411F*C	09.15→		<b>0 281 006 056</b>
17 [09]	3,0	125	F1CE3481CC..	06.09-12.11	TW	<b>0 281 006 048</b> <b>0 281 006 056</b>
17 [12]	3,0	125	F1CE3481...	07.11-07.14		<b>0 281 006 056</b>
18 [06]	3,0	130	F1CE0481H..	04.06-12.11	TW	<b>0 281 006 048</b> <b>0 281 006 056</b>
<b>60 C</b> 14 [09]	3,0	103	F1CE3481L..	11.10-12.11	TW	<b>0 281 006 048</b> <b>0 281 006 056</b>
15, 18 [06]	3,0	107/130	F1CE0481F...; F1CE0481H..	04.06-12.11	TW	<b>0 281 006 048</b> <b>0 281 006 056</b>
17	3,0	107	F1CFL411E*C	09.15→		<b>0 281 006 056</b>
17 [14]	3,0	125	F1CFL411F*C	05.14→		<b>0 281 006 056</b>
<b>65 C</b> 14, 17 [09]	3,0	103/125	F1CE3481C*...; F1CE3481L*C..	06.09-12.11	TW	<b>0 281 006 048</b> <b>0 281 006 056</b>
15, 17, 21 [12]	3,0	107/125/150	F1CE3481...; F1CE3481D*B134	07.11-07.14		<b>0 281 006 056</b>
15, 17, 21 [14]	3,0	107/125/150	F1CFL411G*C; F1CFL411H*C; F1CFL411J*C	05.14→		<b>0 281 006 056</b>
15, 18 [06]	3,0	107/130	F1CE0481F...; F1CE0481H..	04.06-12.11	TW	<b>0 281 006 048</b> <b>0 281 006 056</b>
<b>70 C</b> 14, 15, 17, 18 [09]	3,0	103/107/125/130	F1CE...; F1CE3481C...; F1CE3481H...; F1CE3481L..	06.10-12.11	TW	<b>0 281 006 048</b> <b>0 281 006 056</b>
15, 17, 21 [12]	3,0	107/125/150	F1CE3481...; F1CE3481D*B13...	07.11-07.14		<b>0 281 006 056</b>
15, 17, 21 [14]	3,0	107/125/150	F1CFL411G*C; F1CFL411H*C; F1CFL411J*C	05.14→		<b>0 281 006 056</b>

<b>Daily Chassi</b>						
<b>55 C</b> 17	3,0	125	F1C DS <Euro 5 / P-7 (EGR)>	04.12→		<b>0 281 006 056</b>



<b>70 C 17</b>	3,0	125	F1C DS <Euro 5 / P-7 (EGR)>	04.12→	<b>0 281 006 056</b>
<b>Daily Furgao</b>					
<b>45 S 17</b>	3,0	125	F1C DS <Euro 5 / P-7 (EGR)>	04.12→	<b>0 281 006 056</b>
<b>55 C 17</b>	3,0	125	F1C DS <Euro 5 / P-7 (EGR)>	04.12→	<b>0 281 006 056</b>
<b>Daily Vetrato</b>					
<b>45 S 17</b>	3,0	125	F1C DS <Euro 5 / P-7 (EGR)>	04.12→	<b>0 281 006 056</b>
<b>55 C 17</b>	3,0	125	F1C DS <Euro 5 / P-7 (EGR)>	04.12→	<b>0 281 006 056</b>
<b>Scudato</b>					
<b>70 C 17</b>	3,0	125	F1C DS <Euro 5 / P-7 (EGR)>	04.12→	<b>0 281 006 056</b>

**KIA**

<b>Bongo Coach</b>					
<b>2.9 CRDi [III]</b>	2,9	91		02.04-05.05	<b>0 281 002 554</b>
<b>K 2900</b>					
<b>2.9 CRDi</b>	2,9	92	<2.9L-J3>	05.07→	<b>0 281 002 721</b>
				EU4	<b>0 281 002 554</b>

**MAN**

<b>TGL</b>					
<b>7.150</b>	4,6	110	D 0834 LFL66 <Euro 6>	06.13→	<b>0 281 006 275</b> <b>0 281 006 284</b>
<b>7.180</b>	4,6	132	D 0834 LFL67 <Euro 6>	06.13→	<b>0 281 006 275</b> <b>0 281 006 284</b>
<b>8.150</b>	4,6	110	D 0834 LFL66 <Euro 6>	06.13→	<b>0 281 006 275</b> <b>0 281 006 284</b>
<b>8.180</b>	4,6	132	D 0834 LFL67 <Euro 6>	06.13→	<b>0 281 006 275</b> <b>0 281 006 284</b>
<b>8.220</b>	4,6	162	D 0834 LFL68 <Euro 6>	06.13→	<b>0 281 006 275</b> <b>0 281 006 284</b>
<b>8.250</b>	6,9	184	D 0836 LFL66 <Euro 6>	06.13→	<b>0 281 006 275</b> <b>0 281 006 284</b>
<b>10.180</b>	4,6	132	D 0834 LFL67 <Euro 6>	06.13→	<b>0 281 006 275</b> <b>0 281 006 284</b>
<b>10.220</b>	4,6	162	D 0834 LFL68 <Euro 6>	06.13→	<b>0 281 006 275</b> <b>0 281 006 284</b>
<b>10.250</b>	6,9	184	D 0836 LFL66 <Euro 6>	06.13→	<b>0 281 006 275</b> <b>0 281 006 284</b>
<b>12.180</b>	4,6	132	D 0834 LFL67 <Euro 6>	06.13→	<b>0 281 006 275</b> <b>0 281 006 284</b>
<b>12.220</b>	4,6	162	D 0834 LFL68 <Euro 6>	06.13→	<b>0 281 006 275</b> <b>0 281 006 284</b>
<b>12.250</b>	6,9	184	D 0836 LFL66 <Euro 6>	06.13→	<b>0 281 006 275</b> <b>0 281 006 284</b>
<b>TGM</b>					
<b>12.250</b>	6,9	184	D 0836 LFL66 <Euro 6>	06.13→	<b>0 281 006 275</b> <b>0 281 006 284</b>
<b>12.290</b>	6,9	213	D 0836 LFL67 <Euro 6>	06.13→	<b>0 281 006 275</b> <b>0 281 006 284</b>
<b>13.290</b>	6,9	213	D 0836 LFL67 <Euro 6>	06.13→	<b>0 281 006 275</b> <b>0 281 006 284</b>
<b>13.250</b>	6,9	184	D 0836 LFL66 <Euro 6>	06.13→	<b>0 281 006 275</b> <b>0 281 006 284</b>
<b>15.250</b>	6,9	184	D 0836 LFL66 <Euro 6>	06.13→	<b>0 281 006 275</b> <b>0 281 006 284</b>
<b>15.290</b>	6,9	213	D 0836 LFL67 <Euro 6>	06.13→	<b>0 281 006 275</b> <b>0 281 006 284</b>
<b>15.340</b>	6,9	250	D 0836 LFL68 <Euro 6>	06.13→	<b>0 281 006 275</b> <b>0 281 006 284</b>





◀ MAN

<b>18.250</b>	6,9	184	D 0836 LFL66 <Euro 6>	06.13→	TW	<b>0 281 006 275</b> <b>0 281 006 284</b>
<b>18.290</b>	6,9	213	D 0836 LFL67 <Euro 6>	06.13→	TW	<b>0 281 006 275</b> <b>0 281 006 284</b>
<b>18.320</b>	10,5	235	D 2066 LF68 <Euro 6>; D 2066 LF81 <Euro 6>	10.12→	TW	<b>0 281 006 274</b> <b>0 281 006 284</b>
<b>18.340</b>	6,9	250	D 0836 LFL68 <Euro 6>	06.13→	TW	<b>0 281 006 275</b> <b>0 281 006 284</b>
<b>18.360</b>	10,5	265	D 2066 LF80 <Euro 6>	06.15→	TW	<b>0 281 006 274</b> <b>0 281 006 284</b>
<b>19.250</b>	6,9	184	D 0836 LFL66 <Euro 6>	06.13→	TW	<b>0 281 006 275</b> <b>0 281 006 284</b>
<b>19.290</b>	6,9	213	D 0836 LFL67 <Euro 6>	06.13→	TW	<b>0 281 006 275</b> <b>0 281 006 284</b>
<b>19.340</b>	6,9	250	D 0836 LFL68 <Euro 6>	06.13→	TW	<b>0 281 006 275</b> <b>0 281 006 284</b>
<b>22.250</b>	6,9	184	D 0836 LFL66 <Euro 6>	06.13-06.16	TW	<b>0 281 006 275</b> <b>0 281 006 284</b>
<b>22.290</b>	6,9	213	D 0836 LFL67 <Euro 6>	06.13-06.16	TW	<b>0 281 006 275</b> <b>0 281 006 284</b>
<b>26.290</b>	6,9	213	D 0836 LFL67 <Euro 6>	06.13→	TW	<b>0 281 006 275</b> <b>0 281 006 284</b>
<b>26.340</b>	6,9	250	D 0836 LFL68 <Euro 6>	06.13→	TW	<b>0 281 006 275</b> <b>0 281 006 284</b>

**TGS**

<b>18.360</b>	10,5	265	D 2066 LF67 <Euro 6>	10.12-06.16	TW	<b>0 281 006 274</b> <b>0 281 006 284</b>
<b>18.400</b>	10,5	294	D 2066 LF61 <Euro 6>	10.12-06.16	TW	<b>0 281 006 274</b> <b>0 281 006 284</b>
	12,4	294	D 2676 LF47 <Euro 6>	03.15→	TW	<b>0 281 006 274</b> <b>0 281 006 284</b>
<b>18.440</b>	12,4	324	D 2676 LF26 <Euro 6>; D 2676 LF46 <Euro 6>	10.12→	TW	<b>0 281 006 274</b> <b>0 281 006 284</b>
<b>18.480</b>	12,4	353	D 2676 LF25 <Euro 6>; D 2676 LF45 <Euro 6>	10.12→	TW	<b>0 281 006 274</b> <b>0 281 006 284</b>
<b>24.230</b>	10,5	235	D 2066 LF81 <Euro 6>	06.15→	TW	<b>0 281 006 274</b> <b>0 281 006 284</b>
<b>24.320</b>	10,5	235	D 2066 LF68 <Euro 6>	10.12-06.16	TW	<b>0 281 006 274</b> <b>0 281 006 284</b>
<b>24.360</b>	10,5	265	D 2066 LF67 <Euro 6>; D 2066 LF80 <Euro 6>	10.12→	TW	<b>0 281 006 274</b> <b>0 281 006 284</b>
<b>24.400</b>	10,5	294	D 2066 LF61 <Euro 6>	10.12-06.16	TW	<b>0 281 006 274</b> <b>0 281 006 284</b>
	12,4	294	D 2676 LF47 <Euro 6>	03.15→	TW	<b>0 281 006 274</b> <b>0 281 006 284</b>
<b>24.440</b>	12,4	324	D 2676 LF26 <Euro 6>; D 2676 LF46 <Euro 6>	10.12→	TW	<b>0 281 006 274</b> <b>0 281 006 284</b>
<b>24.480</b>	12,4	353	D 2676 LF25 <Euro 6>; D 2676 LF45 <Euro 6>	10.12→	TW	<b>0 281 006 274</b> <b>0 281 006 284</b>
<b>26.320</b>	10,5	235	D 2066 LF68 <Euro 6>; D 2066 LF81 <Euro 6>	10.12→	TW	<b>0 281 006 274</b> <b>0 281 006 284</b>
<b>26.360</b>	10,5	265	D 2066 LF67 <Euro 6>; D 2066 LF80 <Euro 6>	10.12→	TW	<b>0 281 006 274</b> <b>0 281 006 284</b>
<b>26.400</b>	10,5	294	D 2066 LF61 <Euro 6>	10.12-06.16	TW	<b>0 281 006 274</b> <b>0 281 006 284</b>
	12,4	294	D 2676 LF47 <Euro 6>	03.15→	TW	<b>0 281 006 274</b> <b>0 281 006 284</b>
<b>26.440</b>	12,4	324	D 2676 LF26 <Euro 6>; D 2676 LF46 <Euro 6>	10.12→	TW	<b>0 281 006 274</b> <b>0 281 006 284</b>
<b>26.480</b>	12,4	353	D 2676 LF25 <Euro 6>; D 2676 LF45 <Euro 6>	10.12→	TW	<b>0 281 006 274</b> <b>0 281 006 284</b>
<b>28.320</b>	10,5	235	D 2066 LF68 <Euro 6>; D 2066 LF81 <Euro 6>	10.12→	TW	<b>0 281 006 274</b> <b>0 281 006 284</b>



									
<b>28.360</b>		10,5	265	D 2066 LF67 <Euro 6>; D 2066 LF80 <Euro 6>	10.12→	TW		<b>0 281 006 274</b> <b>0 281 006 284</b>	
<b>28.400</b>		10,5	294	D 2066 LF61 <Euro 6>	10.12-06.16	TW		<b>0 281 006 274</b> <b>0 281 006 284</b>	
		12,4	294	D 2676 LF47 <Euro 6>	03.15→	TW		<b>0 281 006 274</b> <b>0 281 006 284</b>	
<b>28.440</b>		12,4	324	D 2676 LF26 <Euro 6>; D 2676 LF46 <Euro 6>	10.12→	TW		<b>0 281 006 274</b> <b>0 281 006 284</b>	
<b>28.480</b>		12,4	353	D 2676 LF25 <Euro 6>; D 2676 LF45 <Euro 6>	10.12→	TW		<b>0 281 006 274</b> <b>0 281 006 284</b>	
<b>32.320</b>		10,5	235	D 2066 LF68 <Euro 6>; D 2066 LF81 <Euro 6>	06.13→	TW		<b>0 281 006 274</b> <b>0 281 006 284</b>	
<b>32.360</b>		10,5	265	D 2066 LF67 <Euro 6>; D 2066 LF80 <Euro 6>	06.13→	TW		<b>0 281 006 274</b> <b>0 281 006 284</b>	
<b>32.400</b>		10,5	294	D 2066 LF61 <Euro 6>	06.13-06.16	TW		<b>0 281 006 274</b> <b>0 281 006 284</b>	
		12,4	294	D 2676 LF47 <Euro 6>	03.15→	TW		<b>0 281 006 274</b> <b>0 281 006 284</b>	
<b>32.440</b>		12,4	324	D 2676 LF26 <Euro 6>; D 2676 LF46 <Euro 6>	06.13→	TW		<b>0 281 006 274</b> <b>0 281 006 284</b>	
<b>32.480</b>		12,4	353	D 2676 LF25 <Euro 6>; D 2676 LF45 <Euro 6>	06.13→	TW		<b>0 281 006 274</b> <b>0 281 006 284</b>	
<b>33.320</b>		10,5	235	D 2066 LF68 <Euro 6>; D 2066 LF81 <Euro 6>	06.13→	TW		<b>0 281 006 274</b> <b>0 281 006 284</b>	
<b>33.360</b>		10,5	265	D 2066 LF67 <Euro 6>; D 2066 LF80 <Euro 6>	06.13→	TW		<b>0 281 006 274</b> <b>0 281 006 284</b>	
<b>33.400</b>		10,5	294	D 2066 LF61 <Euro 6>	06.13-06.16	TW		<b>0 281 006 274</b> <b>0 281 006 284</b>	
		12,4	294	D 2676 LF47 <Euro 6>	03.15→	TW		<b>0 281 006 274</b> <b>0 281 006 284</b>	
<b>33.440</b>		12,4	324	D 2676 LF26 <Euro 6>; D 2676 LF46 <Euro 6>	06.13→	TW		<b>0 281 006 274</b> <b>0 281 006 284</b>	
<b>33.480</b>		12,4	353	D 2676 LF25 <Euro 6>; D 2676 LF45 <Euro 6>	06.13→	TW		<b>0 281 006 274</b> <b>0 281 006 284</b>	
<b>35.320</b>		10,5	235	D 2066 LF68 <Euro 6>; D 2066 LF81 <Euro 6>	06.13→	TW		<b>0 281 006 274</b> <b>0 281 006 284</b>	
<b>35.360</b>		10,5	265	D 2066 LF67 <Euro 6>; D 2066 LF80 <Euro 6>	06.13→	TW		<b>0 281 006 274</b> <b>0 281 006 284</b>	
<b>35.400</b>		10,5	294	D 2066 LF61 <Euro 6>	06.13-06.16	TW		<b>0 281 006 274</b> <b>0 281 006 284</b>	
		12,4	294	D 2676 LF47 <Euro 6>	03.15→	TW		<b>0 281 006 274</b> <b>0 281 006 284</b>	
<b>35.440</b>		12,4	324	D 2676 LF26 <Euro 6>; D 2676 LF46 <Euro 6>	06.13→	TW		<b>0 281 006 274</b> <b>0 281 006 284</b>	
<b>35.480</b>		12,4	353	D 2676 LF25 <Euro 6>; D 2676 LF45 <Euro 6>	06.13→	TW		<b>0 281 006 274</b> <b>0 281 006 284</b>	
<b>37.320</b>		10,5	235	D 2066 LF68 <Euro 6>; D 2066 LF81 <Euro 6>	06.13→	TW		<b>0 281 006 274</b> <b>0 281 006 284</b>	
<b>37.360</b>		10,5	265	D 2066 LF67 <Euro 6>; D 2066 LF80 <Euro 6>	06.13→	TW		<b>0 281 006 274</b> <b>0 281 006 284</b>	
<b>37.400</b>		10,5	294	D 2066 LF61 <Euro 6>	06.13-06.16	TW		<b>0 281 006 274</b> <b>0 281 006 284</b>	
		12,4	294	D 2676 LF47 <Euro 6>	03.15→	TW		<b>0 281 006 274</b> <b>0 281 006 284</b>	
<b>37.440</b>		12,4	324	D 2676 LF26 <Euro 6>; D 2676 LF46 <Euro 6>	06.13→	TW		<b>0 281 006 274</b> <b>0 281 006 284</b>	
<b>37.480</b>		12,4	353	D 2676 LF25 <Euro 6>; D 2676 LF45 <Euro 6>	06.13→	TW		<b>0 281 006 274</b> <b>0 281 006 284</b>	
<b>41.320</b>		10,5	235	D 2066 LF68 <Euro 6>; D 2066 LF81 <Euro 6>	06.13→	TW		<b>0 281 006 274</b> <b>0 281 006 284</b>	
<b>41.360</b>		10,5	265	D 2066 LF67 <Euro 6>; D 2066 LF80 <Euro 6>	06.13→	TW		<b>0 281 006 274</b> <b>0 281 006 284</b>	





◀ MAN

41.400	10,5	294	D 2066 LF61 <Euro 6>	06.13-06.16	TW	0 281 006 274
						0 281 006 284
	12,4	294	D 2676 LF47 <Euro 6>	03.15→	TW	0 281 006 274
						0 281 006 284
41.440	12,4	324	D 2676 LF26 <Euro 6>; D 2676 LF46 <Euro 6>	06.13→	TW	0 281 006 274
						0 281 006 284
41.480	12,4	353	D 2676 LF25 <Euro 6>; D 2676 LF45 <Euro 6>	06.13→	TW	0 281 006 274
						0 281 006 284
<b>TGX</b>						
18.360	10,5	265	D 2066 LF67 <Euro 6>; D 2066 LF80 <Euro 6>	10.12→	TW	0 281 006 274
						0 281 006 284
18.400	10,5	294	D 2066 LF61 <Euro 6>	10.12-06.16	TW	0 281 006 274
						0 281 006 284
	12,4	294	D 2676 LF47 <Euro 6>	03.15→	TW	0 281 006 274
						0 281 006 284
18.440	12,4	324	D 2676 LF26 <Euro 6>; D 2676 LF46 <Euro 6>	10.12→	TW	0 281 006 274
						0 281 006 284
18.480	12,4	353	D 2676 LF25 <Euro 6>; D 2676 LF45 <Euro 6>	10.12→	TW	0 281 006 274
						0 281 006 284
18.520	15,2	383	D 3876 LF02 <Euro 6>	10.14→	TW	0 281 006 274
						0 281 006 284
18.560	15,2	412	D 3876 LF01 <Euro 6>	10.14→	TW	0 281 006 274
						0 281 006 284
24.360	10,5	265	D 2066 LF67 <Euro 6>; D 2066 LF80 <Euro 6>	10.12→	TW	0 281 006 274
						0 281 006 284
24.400	10,5	294	D 2066 LF61 <Euro 6>	10.12-06.16	TW	0 281 006 274
						0 281 006 284
	12,4	294	D 2676 LF47 <Euro 6>	03.15→	TW	0 281 006 274
						0 281 006 284
24.440	12,4	324	D 2676 LF26 <Euro 6>; D 2676 LF46 <Euro 6>	10.12→	TW	0 281 006 274
						0 281 006 284
24.480	12,4	353	D 2676 LF25 <Euro 6>; D 2676 LF45 <Euro 6>	10.12→	TW	0 281 006 274
						0 281 006 284
26.360	10,5	265	D 2066 LF67 <Euro 6>	10.12-06.16	TW	0 281 006 274
						0 281 006 284
26.400	10,5	294	D 2066 LF61 <Euro 6>	10.12-06.16	TW	0 281 006 274
						0 281 006 284
	12,4	294	D 2676 LF47 <Euro 6>	03.15→	TW	0 281 006 274
						0 281 006 284
26.440	12,4	324	D 2676 LF26 <Euro 6>; D 2676 LF46 <Euro 6>	10.12→	TW	0 281 006 274
						0 281 006 284
26.480	12,4	353	D 2676 LF45 <Euro 6>	03.15→	TW	0 281 006 274
						0 281 006 284
26.520	15,2	383	D 3876 LF02 <Euro 6>	10.14→	TW	0 281 006 274
						0 281 006 284
26.560	15,2	412	D 3876 LF01 <Euro 6>	10.14→	TW	0 281 006 274
						0 281 006 284
28.360	10,5	265	D 2066 LF67 <Euro 6>; D 2066 LF80 <Euro 6>	10.12→	TW	0 281 006 274
						0 281 006 284
28.400	10,5	294	D 2066 LF61 <Euro 6>	10.12-06.16	TW	0 281 006 274
						0 281 006 284
	12,4	294	D 2676 LF47 <Euro 6>	03.15→	TW	0 281 006 274
						0 281 006 284
28.440	12,4	324	D 2676 LF26 <Euro 6>; D 2676 LF46 <Euro 6>	10.12→	TW	0 281 006 274
						0 281 006 284
28.480	12,4	353	D 2676 LF25 <Euro 6>; D 2676 LF45 <Euro 6>	10.12→	TW	0 281 006 274
						0 281 006 284
28.520	15,2	383	D 3876 LF02 <Euro 6>	10.14→	TW	0 281 006 274
						0 281 006 284
28.560	15,2	412	D 3876 LF01 <Euro 6>	10.14→	TW	0 281 006 274
						0 281 006 284
33.360	10,5	265	D 2066 LF67 <Euro 6>; D 2066 LF80 <Euro 6>	06.13→	TW	0 281 006 274
						0 281 006 284





33.400	10,5	294	D 2066 LF61 <Euro 6>	06.13-06.16	TW	0 281 006 274
						0 281 006 284
	12,4	294	D 2676 LF47 <Euro 6>	03.15→	TW	0 281 006 274
						0 281 006 284
33.440	12,4	324	D 2676 LF26 <Euro 6>; D 2676 LF46 <Euro 6>	06.13→	TW	0 281 006 274
						0 281 006 284
33.480	12,4	353	D 2676 LF25 <Euro 6>; D 2676 LF45 <Euro 6>	06.13→	TW	0 281 006 274
						0 281 006 284
33.520	15,2	383	D 3876 LF02 <Euro 6>	10.14→	TW	0 281 006 274
						0 281 006 284
33.560	15,2	412	D 3876 LF01 <Euro 6>	10.14→	TW	0 281 006 274
						0 281 006 284
35.360	10,5	265	D 2066 LF67 <Euro 6>; D 2066 LF80 <Euro 6>	12.13→	TW	0 281 006 274
						0 281 006 284
35.400	10,5	294	D 2066 LF61 <Euro 6>	12.13-06.16	TW	0 281 006 274
						0 281 006 284
	12,4	294	D 2676 LF47 <Euro 6>	03.15→	TW	0 281 006 274
						0 281 006 284
35.440	12,4	324	D 2676 LF26 <Euro 6>; D 2676 LF46 <Euro 6>	12.13→	TW	0 281 006 274
						0 281 006 284
35.480	12,4	353	D 2676 LF25 <Euro 6>; D 2676 LF45 <Euro 6>	12.13→	TW	0 281 006 274
						0 281 006 284
35.520	15,2	383	D 3876 LF02 <Euro 6>	10.14→	TW	0 281 006 274
						0 281 006 284
35.560	15,2	412	D 3876 LF01 <Euro 6>	10.14→	TW	0 281 006 274
						0 281 006 284
41.560	15,2	412	D 3876 LF01 <Euro 6>	10.14→	TW	0 281 006 274
						0 281 006 284
41.640	15,2	471	D 3876 LF03 <Euro 6>	10.15→	TW	0 281 006 274
						0 281 006 284
<b>TRX</b>						
26.480	12,4	353	D 2676 LF25 <Euro 6>	10.12-06.16	TW	0 281 006 274
						0 281 006 284
<b>ZGX</b>						
26.360	10,5	265	D 2066 LF80 <Euro 6>	06.15→	TW	0 281 006 274
						0 281 006 284



**MERCEDES-BENZ**

**Serie V**

200 CDI [638]	2,2	75	OM 611.980	06.99-09.03		0 280 217 114
220 CDI [638]	2,2	90	OM 611.980	06.99-09.03		0 280 217 114
230 TD [638]	2,3	72	OM 601.970	04.96-09.03		0 280 217 523
<b>Sprinter</b>						
208 CDI [T1N]	2,2	60	OM 611.987 D LA	04.00-05.06		0 280 217 517
209 CDI [NCV3]	2,1	65	OM 646.984 D 22 LA <Euro 4>	04.06-12.09		0 281 002 896
211 CDI [NCV3]	2,1	80	OM 646.985 D 22 LA <Euro 4>	04.06-09.11		0 281 002 896
CDI [T1N]	2,1	80	OM 611.981 D LA	04.00-05.06		0 280 217 517
213 CDI [NCV3]	2,1	95	OM 646.986 D 22 LA <Euro 4>	04.06-09.11		0 281 002 896
CDI [T1N]	2,1	95	OM 611.981 D LA	04.00-05.06		0 280 217 517
215 CDI [NCV3]	2,1	110	OM 646.9... <Euro 4>	04.06-12.11		0 281 002 896
216 CDI [T1N]	2,7	115	OM 612.981 D LA	04.00-05.06		0 280 217 517
218 CDI [NCV3]	3,0	135	OM 642... <Euro 4>	04.06-03.09		0 281 002 896
219 CDI [NCV3]	3,0	140	OM 642... <Euro 5>	03.09→		0 281 002 978
308 CDI [T1N]	2,2	60	OM 611.987 D LA	04.00-05.06		0 280 217 517
309 CDI [NCV3]	2,1	65	OM 646.984 D 22 LA <Euro 4>	04.06-12.09		0 281 002 896
311 CDI	2,2	80	OM 611 LA	06.01-12.04		0 280 217 517
CDI [NCV3]	2,1	80	OM 646.985 D 22 LA <Euro 4>	04.06-09.11		0 281 002 896
CDI [T1N]	2,1	80	OM 611.981 D LA	04.00-05.06		0 280 217 517
CDI [909]	2,1	80	OM 646.701 <OM 646 DE22LA>	11.13→	EU4	0 281 002 978
313 CDI [NCV3]	2,1	95	OM 646.986 DE 22 LA <Euro 4>	04.06-09.11		0 281 002 896
CDI, CDI 4x4 [T1N]	2,1	95	OM 611.981 D LA	04.00-05.06		0 280 217 517





◀ MERCEDES-BENZ

315 CDI [NCV3]	2,1	110	OM 646.9... <Euro 4>	04.06-09.11	0281 002 896
316 CDI [T1N]	2,7	115	OM 647.981 D 27 LA	10.04-05.06	0281 002 656
CDI, CDI James Cook [T1N]	2,7	115	OM 612.981 D LA	04.00-05.06	0280 217 517
318 CDI [NCV3]	3,0	135	OM 642... <Euro 4>	04.06-03.09	0281 002 896
319 CDI [NCV3]	3,0	140	OM 642... <Euro 5>	03.09→	0281 002 978
408 CDI [T1N]	2,2	60	OM 611.987 D LA	04.00-05.06	0280 217 517
411 CDI [NCV3]	2,1	80	OM 646.985 D 22 LA <Euro 4>	04.06-09.11	0281 002 896
CDI [T1N]	2,1	80	OM 611.981 D LA	04.00-05.06	0280 217 517
CDI [909]	2,1	80	OM 646.701 <OM 646 DE22LA>	11.13→ EU4	0281 002 978
413 CDI [T1N]	2,1	95	OM 611.981 D LA	04.00-05.06	0280 217 517
415 CDI [NCV3]	2,1	110	OM 646.9... <Euro 4>	04.06-09.11	0281 002 896
416 CDI [T1N]	2,7	115	OM 612.981 D LA	04.00-05.06	0280 217 517
			OM 647.981 D 27 LA	10.04-05.06	0281 002 656
418 CDI [NCV3]	3,0	135	OM 642... <Euro 4>	04.06-03.09	0281 002 896
419 CDI [NCV3]	3,0	140	OM 642... <Euro 5>	03.09→	0281 002 978
509 CDI [NCV3]	2,1	65	OM 646.984 D 22 LA <Euro 4>	04.06-12.09	0281 002 896
511 CDI [NCV3]	2,1	80	OM 646.985 D 22 LA <Euro 4>	04.06-09.11	0281 002 896
515 CDI [NCV3]	2,1	110	OM 646.9... <Euro 4>	04.06-09.11	0281 002 896
518 CDI [NCV3]	3,0	135	OM 642... <Euro 4>	04.06-03.09	0281 002 896
519 CDI [NCV3]	3,0	140	OM 642... <Euro 5>	03.09→	0281 002 978
616 CDI [T1N]	2,7	115	OM 612.981 D LA	02.01-05.06	0280 217 517
<b>Viano</b>					
2.0 CDI [639]	2,1	80/85	OM 646.98... <OM 646 DE22LA>; OM 646.982 <OM 646 DE22LA>	09.03-08.10	0281 002 585
2.2 CDI [639]	2,1	110	OM 646.98... <OM 646 DE22LA>	09.03-12.10	0281 002 585
3.0 CDI [639]	3,0	150	OM 642.990 <OM 642 DE 30LA>	04.06-08.10 EU5	0281 002 978
			Fg.-Nr. →298499	04.06-08.10 EU5	0281 002 656
			Fg.-Nr. 298500→	04.06-08.10 EU5	0281 002 896
		165	OM 642.890 <OM 642 DE 30 LA>	07.10-12.14	0281 002 978
<b>Vito</b>					
108 CDI [638]	2,2	60	OM 611.980	04.99-09.03	0280 217 114
D [638]	2,3	60	OM 601.942	11.95-09.03	0280 217 523
109 CDI [639]	2,1	65/70	OM 646.980 <OM 646 DE22LA>; OM 646.983 <OM 646 DE22LA>	10.03-07.10	0281 002 585
110 CDI [638]	2,2	75	OM 611.980	04.99-09.03	0280 217 114
D [638]	2,3	72	OM 601.970	11.95-09.03	0280 217 523
111 CDI [639]	2,1	80/85	OM 646.98... <OM 646 DE22LA>; OM 646.982 <OM 646 DE22LA>	10.03-07.10	0281 002 585
112 CDI [638]	2,2	90	OM 611.980	04.99-09.03	0280 217 114
115 CDI [639]	2,1	110	OM 646.982 <OM 646 DE22LA>	10.03-07.10	0281 002 585
120 CDI [639]	3,0	150	642.990 <OM 642 DE30LA>	04.06-07.10 EU5	0281 002 978
			Fg.-Nr. →298499	04.06-07.10 EU5	0281 002 656
			Fg.-Nr. 298500→	04.06-07.10 EU5	0281 002 896
122 CDI [639]	3,0	165	OM 642.890 <OM 642 DE 30 LA>	07.10-12.14	0281 002 978



**MITSUBISHI FUSO TRUCK & BUS CO**

<b>Canter</b>					
3C13 , D	3,0	96	4P10-BAT2 <Euro 5b+>; 4P10-T2 <Euro 5/EEV>	12.11→	0281 006 154
D	3,0	96	4P10... <Euro 5>	07.09→	0281 006 073
3C15	3,0	107	4P10 OAT3 <Euro 5>	07.09→	0281 006 073
, D	3,0	110	4P10-BAT4 <Euro 5b+>; 4P10-T4 <Euro 5/EEV>	12.11→	0281 006 154
3C18	3,0	129	4P10-BAT6 <Euro 5b+>; 4P10-T6 <Euro 5/EEV>	12.11→	0281 006 154
3S13	3,0	96	4P10-BAT2 <Euro 5b+>; 4P10-T2 <Euro 5/EEV>	12.11→	0281 006 154
D	3,0	96	4P10 OAT2 <Euro 5>	07.09→	0281 006 073
3S15	3,0	110	4P10-BAT4 <Euro 5b+>; 4P10-T4 <Euro 5/EEV>	12.11→	0281 006 154
5S13	3,0	96	4P10 OAT2 <Euro 5>	07.09→	0281 006 073
6C15 D	3,0	107	4P10 OAT3 <Euro 5>	07.09→	0281 006 073
6C18 D	3,0	129	4P10 OAT6 <Euro 5>	07.09→	0281 006 073
D 4x4	3,0	129	4P10-AAT6 <Euro 6>; 4P10-T6 <Euro 5/EEV>	12.11→	0281 006 154
6S15	3,0	110	4P10-BAT4 <Euro 5b+>; 4P10-T4 <Euro 5/EEV>	12.11→	0281 006 154
7C15 D	3,0	107	4P10 OAT3 <Euro 5>	07.09→	0281 006 073



<b>7C15 D</b>	3,0	110	4P10-AAT4 <Euro 6>; 4P10-T4 <Euro 5/EEV>	12.11→	<b>0 281 006 154</b>
<b>7C18 D</b>	3,0	129	4P10 0AT6 <Euro 5>	07.09→	<b>0 281 006 073</b>
			4P10-AAT6 <Euro 6>; 4P10-T6 <Euro 5/EEV>	12.11→	<b>0 281 006 154</b>
<b>9C15</b>	3,0	110	4P10-AAT4 <Euro 6>	08.13→	<b>0 281 006 154</b>
<b>9C18</b>	3,0	129	4P10-AAT6 <Euro 6>; 4P10-HAT6 <Euro 6>	08.13→	<b>0 281 006 154</b>

**PEUGEOT****Boxer**

<b>2.8 HDi [U3]</b>	2,8	94	8140.43S	09.00-02.02	<b>0 281 002 184</b>
HDi [U5]	2,8	94/107	8140 43N <SOFIM 2800 HDi>; 8140.43S	02.02-05.06	<b>0 281 002 184</b>
HDi	2,8	93	8140.43S	09.05-09.09	<b>0 281 002 184</b>

**TEMSA****Prestij City**

	3,0	110	4P10-T4 <Euro 5/EEV>	06.14→	<b>0 281 006 154</b>
--	-----	-----	----------------------	--------	----------------------

**VW (VOLKSWAGEN)****California T4**

<b>2.5 TDI [70, 7D]</b>	2,5	65/75	AJT; AUF		
			Fg.-Nr. →70..1H048 284 →70..1X047 893	05.98-08.00	<b>0 281 002 216 0 986 284 001</b>
			Fg.-Nr. 70..1H048 285→70..1X047 894→	09.00-06.03	<b>0 281 002 463 0 986 284 008</b>
		111	AHY		
			Fg.-Nr. →70..1..001 319	05.98-05.00	<b>0 280 217 529 0 986 280 204</b>
			Fg.-Nr. 70..1..001 320→	06.00-09.00	<b>0 281 002 461 0 986 284 007</b>
			AXG	09.00-06.03	<b>0 281 002 461 0 986 284 007</b>
<b>TDI, TDI Syncro [70, 7D]</b>	2,5	65/75	AXL; AYC; AYY	04.01-06.03	<b>0 281 002 463 0 986 284 008</b>
		75	ACV		
			Fg.-Nr. →70..1H048 284 →70..1X047 893	05.98-08.00	<b>0 281 002 216 0 986 284 001</b>
			Fg.-Nr. 70..1H048 285→70..1X047 894→	09.00-06.03	<b>0 281 002 463 0 986 284 008</b>

**California T5**

<b>1.9 TDI [7H]</b>	1,9	62/63/75/77	AXB; AXC; BRR; BRS	04.03-11.09	<b>0 281 002 531 0 986 284 009</b>
<b>2.0 TDI, TDI 4Motion [7E]</b>	2,0	62/75/84/100/103/132	CAAA <D54>; CAAB <D55>; CAAC <D94>; CAAD <DK3>; CAAE <D94>; CCHA <D91>; CCHB <D94>; CFCA <D49>	09.09-08.15	<b>0 281 002 956</b>
<b>2.5 TDI, TDI 4Motion [7H]</b>	2,5	96/120/128	AXD; AXE; BLJ	02.03-11.09	<b>0 281 002 461 0 986 284 007</b>
		96/128	BNZ; BPC	01.06-11.09	<b>0 281 002 735</b>

**California T6**

<b>2.0 TDI, TDI 4Motion [SG]</b>	2,0	62/75/103/110/132	CAAB <D55>; CAAC <D94>; CFCA <D49>; CXFA <DN4>; CXGA <MOI>; CXGB <MOH>; CXHA <DN4>	04.15→	<b>0 281 002 956</b>
----------------------------------	-----	-------------------	--	--------	----------------------

**Caravelle T4**

<b>2.5 TDI [70, 7D]</b>	2,5	65/75	AJT; AUF		
			Fg.-Nr. →70..1H048 284 →70..1X047 893	05.98-08.00	<b>0 281 002 216 0 986 284 001</b>
			Fg.-Nr. 70..1H048 285→70..1X047 894→	09.00-06.03	<b>0 281 002 463 0 986 284 008</b>
		111	AHY		
			Fg.-Nr. →70..1..001 319	05.98-05.00	<b>0 280 217 529 0 986 280 204</b>
			Fg.-Nr. 70..1..001 320→	06.00-09.00	<b>0 281 002 461 0 986 284 007</b>
			AXG	09.00-06.03	<b>0 281 002 461 0 986 284 007</b>
<b>TDI, TDI Syncro [70, 7D]</b>	2,5	65/75	AXL; AYC; AYY	04.01-06.03	<b>0 281 002 463 0 986 284 008</b>
		75	ACV		
			Fg.-Nr. →70..1H048 284 →70..1X047 893	05.98-08.00	<b>0 281 002 216 0 986 284 001</b>
			Fg.-Nr. 70..1H048 285→70..1X047 894→	09.00-06.03	<b>0 281 002 463 0 986 284 008</b>

**Caravelle T5**

<b>1.9 TDI [7H]</b>	1,9	62/63/75/77	AXB; AXC; BRR; BRS	04.03-11.09	<b>0 281 002 531 0 986 284 009</b>
---------------------	-----	-------------	--------------------	-------------	------------------------------------





◀ VW

<b>2.0</b> TDI, TDI 4Motion [7E]	2,0	62/75/84/100/103/132	CAAA <D54>; CAAB <D55>; CAAC <D94>; CAAD <DK3>; CAAE <D94>; CCHA <D91>; CCHB <D94>; CFCA <D49>	09.09-08.15	<b>0 281 002 956</b>	
<b>2.5</b> TDI, TDI 4Motion [7H]	2,5	96/120/128	AXD; AXE; BLJ	02.03-11.09	<b>0 281 002 461</b>	<b>0 986 284 007</b>
		96/128	BNZ; BPC	01.06-11.09	<b>0 281 002 735</b>	
<b>Caravelle T6</b>						
<b>2.0</b> TDI, TDI 4Motion [SG]	2,0	62/75/103/110/132	CAAA <D54>; CAAB <D55>; CAAC <D94>; CFCA <D49>; CXFA <DN4>; CXGA <MOI>; CXGB <MOH>; CXHA <DN4>	04.15→	<b>0 281 002 956</b>	
<b>Crafter 30</b>						
<b>2.0</b> BitDI, TDI [2E, 2F]	2,0	80/84/100/103/105/120	CKTB <DK2>; CKTC <D94>; CKUB <D92>; CKUC <D46>; CSLA <DK2>; CSLB <DK3>; CSLC <D91>; CSNA	05.11→	<b>0 281 002 956</b>	
<b>2.5</b> TDI [2E, 2F]	2,5	65/80/100/120	BJJ <D5K>; BJK <D5L>; BJL <D5M>; BJM <D5N>; CEBA <D5K>; CEBB <D5L>; CECA <D5M>; CECB <D5N>	04.06-05.13	<b>0 281 002 896</b>	
<b>Crafter 35</b>						
<b>2.0</b> BitDI, TDI [2E, 2F]	2,0	80/84/100/103/105/120	CKTB <DK2>; CKTC <D94>; CKUB <D92>; CKUC <D46>; CSLA <DK2>; CSLB <DK3>; CSLC <D91>; CSNA	05.11→	<b>0 281 002 956</b>	
<b>2.5</b> TDI [2E, 2F]	2,5	65/80/100/120	BJJ <D5K>; BJK <D5L>; BJL <D5M>; BJM <D5N>; CEBA <D5K>; CEBB <D5L>; CECA <D5M>; CECB <D5N>	04.06-05.13	<b>0 281 002 896</b>	
<b>Crafter 50</b>						
<b>2.0</b> BitDI, TDI [2E, 2F]	2,0	80/84/100/103/105/120	CKTB <DK2>; CKTC <D94>; CKUB <D92>; CKUC <D46>; CSLA <DK2>; CSLB <DK3>; CSLC <D91>; CSNA	05.11→	<b>0 281 002 956</b>	
<b>2.5</b> TDI [2E, 2F]	2,5	80/100/120	BJK <D5L>; BJL <D5M>; BJM <D5N>; CEBB <D5L>; CECA <D5M>; CECB <D5N>	04.06-05.13	<b>0 281 002 896</b>	
<b>LT</b>						
<b>28</b> 2.5 SDI [2D, 2H]	2,5	55	AGX Fg.-Nr. 2D..X..027 194→	03.99-04.01	<b>0 281 002 216</b>	<b>0 986 284 001</b>
2.5 TDI [2D, 2H]	2,5	61/70/80	AVR; BBE; BBF	04.01-04.06	<b>0 281 002 463</b>	<b>0 986 284 008</b>
		66	APA	05.99-04.01	<b>0 281 002 216</b>	<b>0 986 284 001</b>
		80	ANJ Fg.-Nr. →2D..1..013 334	05.99-08.00	<b>0 281 002 216</b>	<b>0 986 284 001</b>
			Fg.-Nr. 2D..1..013 335→	09.00-04.06	<b>0 281 002 463</b>	<b>0 986 284 008</b>
2.8 D Turbo, 2.8 TDI [2D, 2H]	2,8	92/96/116	AGK; ATA; AUH; BCQ	07.97-04.06	<b>0 281 002 461</b>	<b>0 986 284 007</b>
<b>35</b> 2.5 SDI [2D, 2H]	2,5	55	AGX Fg.-Nr. 2D..X..027 194→	03.99-04.01	<b>0 281 002 216</b>	<b>0 986 284 001</b>
2.5 TDI [2D, 2H]	2,5	61/70/80	AVR; BBE; BBF	04.01-04.06	<b>0 281 002 463</b>	<b>0 986 284 008</b>
		66	APA	05.99-04.01	<b>0 281 002 216</b>	<b>0 986 284 001</b>
		80	ANJ Fg.-Nr. →2D..1..013 334	05.99-08.00	<b>0 281 002 216</b>	<b>0 986 284 001</b>
			Fg.-Nr. 2D..1..013 335→	09.00-04.06	<b>0 281 002 463</b>	<b>0 986 284 008</b>
2.8 D Turbo, 2.8 TDI [2D, 2H]	2,8	92/96/116	AGK; ATA; AUH; BCQ	07.97-04.06	<b>0 281 002 461</b>	<b>0 986 284 007</b>
<b>46</b> 2.5 SDI [2D, 2H]	2,5	55	AGX Fg.-Nr. 2D..X..027 194→	03.99-04.01	<b>0 281 002 216</b>	<b>0 986 284 001</b>
2.5 TDI [2D, 2H]	2,5	61/70/80	AVR; BBE; BBF	04.01-04.06	<b>0 281 002 463</b>	<b>0 986 284 008</b>
		66	APA	05.99-04.01	<b>0 281 002 216</b>	<b>0 986 284 001</b>
		80	ANJ Fg.-Nr. →2D..1..013 334	05.99-08.00	<b>0 281 002 216</b>	<b>0 986 284 001</b>
			Fg.-Nr. 2D..1..013 335→	09.00-04.06	<b>0 281 002 463</b>	<b>0 986 284 008</b>
2.8 D Turbo, 2.8 TDI [2D, 2H]	2,8	92/96/116	AGK; ATA; AUH	07.97-04.06	<b>0 281 002 461</b>	<b>0 986 284 007</b>
<b>Multivan T4</b>						
<b>2.5</b> TDI [70, 7D]	2,5	65/75	AJT; AUF Fg.-Nr. →70..1H048 284→70..1X047 893	05.98-08.00	<b>0 281 002 216</b>	<b>0 986 284 001</b>
			Fg.-Nr. 70..1H048 285→70..1X047 894→	09.00-06.03	<b>0 281 002 463</b>	<b>0 986 284 008</b>





2.5 TDI [70, 7D]	2,5	111	AHY					
				Fg.-Nr. →70..1..001 319	05.98-05.00	0 280 217 529	0 986 280 204	
				Fg.-Nr. 70..1..001 320→	06.00-09.00	0 281 002 461	0 986 284 007	
				AXG	09.00-06.03	0 281 002 461	0 986 284 007	
TDI, TDI Syncro [70, 7D]	2,5	65/75	AXL; AYC; AYY		04.01-06.03	0 281 002 463	0 986 284 008	
		75	ACV					
				Fg.-Nr. →70..1H048 284 →70..1X047 893	05.98-08.00	0 281 002 216	0 986 284 001	
				Fg.-Nr. 70..1H048 285→ 70..1X047 894→	09.00-06.03	0 281 002 463	0 986 284 008	
<b>Multivan T5</b>								
1.9 TDI [7H]	1,9	62/63/75/77	AXB; AXC; BRR; BRS		04.03-11.09	0 281 002 531	0 986 284 009	
2.0 TDI, TDI 4Motion [7E]	2,0	62/75/84/100/103/132	CAAA <D54>; CAAB <D55>; CAAC <D94>; CAAD <DK3>; CAAE <D94>; CCHA <D91>; CCHB <D94>; CFCA <D49>		09.09-08.15	0 281 002 956		
2.5 TDI, TDI 4Motion [7H]	2,5	96/120/128	AXD; AXE; BLJ		02.03-11.09	0 281 002 461	0 986 284 007	
		96/128	BNZ; BPC		01.06-11.09	0 281 002 735		
<b>Multivan T6</b>								
2.0 TDI, TDI 4Motion [SG]	2,0	62/75/103/110/132	CAAB <D55>; CAAC <D94>; CFCA <D49>; CXFA <DN4>; CXGA <M0I>; CXGB <M0H>; CXHA <DN4>		04.15→	0 281 002 956		
TDI 4Motion [SSG]	2,0	103	CAAC <D94>		04.15→	0 281 002 956		
<b>Transporter T4</b>								
2.5 TDI [70, 7D]	2,5	65/75	AJT; AUF					
				Fg.-Nr. →70..1H048 284 →70..1X047 893	05.98-08.00	0 281 002 216	0 986 284 001	
				Fg.-Nr. 70..1H048 285→ 70..1X047 894→	09.00-06.03	0 281 002 463	0 986 284 008	
		111	AHY					
				Fg.-Nr. →70..1..001 319	05.98-05.00	0 280 217 529	0 986 280 204	
				Fg.-Nr. 70..1..001 320→	06.00-09.00	0 281 002 461	0 986 284 007	
				AXG	09.00-06.03	0 281 002 461	0 986 284 007	
TDI, TDI Syncro [70, 7D]	2,5	65/75	AXL; AYC; AYY		04.01-06.03	0 281 002 463	0 986 284 008	
		75	ACV					
				Fg.-Nr. →70..1H048 284 →70..1X047 893	05.98-08.00	0 281 002 216	0 986 284 001	
				Fg.-Nr. 70..1H048 285→ 70..1X047 894→	09.00-06.03	0 281 002 463	0 986 284 008	
<b>Transporter T5</b>								
1.9 TDI [7H]	1,9	62/63/75/77	AXB; AXC; BRR; BRS		04.03-11.09	0 281 002 531	0 986 284 009	
TDI [7J]	1,9	62/63/75/77	AXB; AXC; BRR; BRS		04.03-11.09	0 281 002 531	0 986 284 009	
2.0 TDI, TDI 4Motion [7E]	2,0	62/75/84/100/103/132	CAAA <D54>; CAAB <D55>; CAAC <D94>; CAAD <DK3>; CAAE <D94>; CCHA <D91>; CCHB <D94>; CFCA <D49>		09.09-08.15	0 281 002 956		
TDI, TDI 4Motion [7F]	2,0	62/75/84/100/103/132	CAAA <D54>; CAAB <D55>; CAAC <D94>; CAAD <DK3>; CAAE <D94>; CCHA <D91>; CCHB <D94>; CFCA <D49>		09.09-08.15	0 281 002 956		
2.5 TDI, TDI 4Motion [7H]	2,5	96/120/128	AXD; AXE; BLJ		02.03-11.09	0 281 002 461	0 986 284 007	
		96/128	BNZ; BPC		01.06-11.09	0 281 002 735		
TDI, TDI 4Motion [7J]	2,5	96/128	AXD; AXE		04.03-11.09	0 281 002 461	0 986 284 007	
			BNZ; BPC		06.06-11.09	0 281 002 735		
<b>Transporter T6</b>								
2.0 TDI, TDI 4Motion [SF]	2,0	62/75/103/110/132	CAAA <D54>; CAAB <D55>; CAAC <D94>; CFCA <D49>; CXGB <M0H>; CXHA <DN4>		04.15→	0 281 002 956		
TDI, TDI 4Motion [SG]	2,0	62/75/103/110/132	CAAA <D54>; CAAB <D55>; CAAC <D94>; CFCA <D49>; CXFA <DN4>; CXGA <M0I>; CXGB <M0H>; CXHA <DN4>		04.15→	0 281 002 956		





**ASTRA**

HD9C-Serie							
HD9	12,9	302/382/412	F3BE3681A; F3BE3681D; F3BE3681E	01.12→		0 414 703 004	0 986 441 025
		353	F3BE3681F	01.12→	TW	0 414 701 083	0 986 441 013
						0 414 703 004	0 986 441 025

HD9-Series							
12.9	12,9	280	F3BE0681 <Euro 3>	01.12→		0 414 701 083	0 986 441 013
		309/324/353/397	F3BE0681 <Euro 3>	01.12→	TW	0 414 701 083	0 986 441 013
						0 414 703 004	0 986 441 025









**HEULIEZ**

Access` Bus GX							
427 BHNS	7,8	213	F2BE3682... <Euro 4/5>	09.09-12.13		0 414 700 010	0 986 441 120
GX Acces Bus							
327 , BHNS	7,8	180/213	F2BE3682C <Euro 4/5>; F2BE3682D <Euro 4/5>	09.07-12.13		0 414 700 010	0 986 441 120

**IVECO**

Crossway							
7.8	7,8	243	F2BE3682B <Euro 4/5>	06.13→		0 414 703 008	0 986 441 026
EuroCargo							
180 E 24	5,9	176	F4AE0681B*C...	09.00-08.03		0 414 701 084	0 986 441 003
EuroMover							
190 E 24	7,8	180	F2BE0681D*A.. <Euro 2>	Mot.-Nr. →13740	08.00-03.06	0 414 700 002	0 986 441 102
				Mot.-Nr. 13741→	08.00-03.06	0 414 700 003	0 986 441 112
260 E 24	7,8	180	F2BE0681D..	Mot.-Nr. →13740	08.00-03.06	0 414 700 002	0 986 441 102
				Mot.-Nr. 13741→	08.00-03.06	0 414 700 003	0 986 441 112
EuroStar							
190 E 39	10,5	287	F3AE0681E*A..	08.00-08.03		0 414 701 084	0 986 441 003
	43	10,3	316	F3AE0681D*A..; F3AE0681D*B..	08.00-08.03	0 414 701 084	0 986 441 003
260 E 39, 40, 43	10,3	287/294/316	F3AE0681B*B..; F3AE0681D*A..; F3AE0681D*B..; F3AE0681E*..	08.00-09.04		0 414 701 084	0 986 441 003
		48	13,0	353	F3BE0681E*..	08.97-08.03	0 414 701 083
440 E 39, 40, 43	10,3	287/294/316	F3AE0681B*B..; F3AE0681D*A..; F3AE0681E*..	08.99-09.04		0 414 701 084	0 986 441 003
		46, 48	13,0	339/353	F3BE0681E*..; F3BE0681F*..	08.00-08.03	0 414 701 083
EuroTech							
190 E 24, 27, 31, 35	7,8	180/200/228/259	F2BE0681A*A.. <Euro2>; F2BE0681A*B.. <Euro3>; F2BE0681B... <Euro2>; F2BE0681B... <Euro3>; F2BE0681C..; F2BE0681D*A... <Euro 2>; F2BE0681D*B... <Euro 3>; F2BE0681F..	Mot.-Nr. →13740	08.00-08.03	0 414 700 002	0 986 441 102
				Mot.-Nr. 13741→	08.00-08.03	0 414 700 003	0 986 441 112
39, 40, 43	10,3	287/294/316	F3AE0681B*A..; F3AE0681D*A..; F3AE0681D*B..; F3AE0681E*..	08.00-09.04		0 414 701 084	0 986 441 003
260 E 24, 27, 31, 35	7,8	180/200/228/259	F2BE0681A*A.. <Euro2>; F2BE0681A*B..; F2BE0681B*A.. <Euro2>; F2BE0681B*B..; F2BE0681C..; F2BE0681D..; F2BE0681F..	Mot.-Nr. →13740	08.00-08.03	0 414 700 002	0 986 441 102
				Mot.-Nr. 13741→	08.00-08.03	0 414 700 003	0 986 441 112
39	10,5	287	F3AE0681E*A..	08.00-08.03		0 414 701 084	0 986 441 003
40, 43	10,3	294/316	F3AE0681B*B..; F3AE0681D*A..; F3AE0681D*B..	08.00-09.04		0 414 701 084	0 986 441 003



									
<b>440 E</b> 31, 35	7,8	228/259	F2BE0681A*..-Euro2; F2BE0681A*B..-Euro3; F2BE0681B*..-Euro2; F2BE0681B*B..-Euro3	Mot.-Nr. →13740 Mot.-Nr. 13741→	08.00-08.03 08.00-08.03		<b>0 414 700 002</b>	<b>0 986 441 102</b>	
40, 43	10,3	294/316	F3AE0681B*B..; F3AE0681D*A..		08.00-09.04		<b>0 414 701 084</b>	<b>0 986 441 003</b>	
<b>EuroTrakker</b>									
<b>180 E</b> 24, 27	7,8	180/200	F2BE0681D*A*...; F2BE0681D*B*...; F2BE0681F*...	Mot.-Nr. →13740 Mot.-Nr. 13741→	08.00-08.04 08.00-08.04		<b>0 414 700 002</b>	<b>0 986 441 102</b>	
<b>190 E</b> 24, 27, 31, 35	7,8	180/200/ 228/259	F2BE0681A*..-Euro2; F2BE0681A*B..-Euro3; F2BE0681B... <Euro2>; F2BE0681B... <Euro3>; F2BE0681DA071; F2BE0681D*B521 <Euro 3>; F2BE0681F...	Mot.-Nr. →13740 Mot.-Nr. 13741→	08.00-08.04 08.00-08.04		<b>0 414 700 002</b>	<b>0 986 441 102</b>	
38, 44	13,0	280/324	F3BE0681C*...; F3BE0681G..		08.00-08.04		<b>0 414 701 083</b>	<b>0 986 441 013</b>	
<b>260 E</b> 31, 35	7,8	228/259	F2BE0681A*A.. <Euro2>; F2BE0681A*B..; F2BE0681B*A.. <Euro2>; F2BE0681B*B..	Mot.-Nr. →13740 Mot.-Nr. 13741→	08.00-08.04 08.00-08.04		<b>0 414 700 002</b>	<b>0 986 441 102</b>	
38, 44, 48	13,0	280/324/ 353	F3BE0681C*B..; F3BE0681E*B..; F3BE0681G*B..		08.00-08.04		<b>0 414 701 083</b>	<b>0 986 441 013</b>	
<b>340 E</b> 35	7,8	259	F2BE0681A*A.. <Euro2>; F2BE0681A*B..	Mot.-Nr. →13740 Mot.-Nr. 13741→	08.00-08.04 08.00-08.04		<b>0 414 700 002</b>	<b>0 986 441 102</b>	
38, 44	13,0	280/324	F3BE0681C*B..; F3BE0681G*B..		08.00-08.04		<b>0 414 701 083</b>	<b>0 986 441 013</b>	
<b>380 E</b> 35	7,8	259	F2BE0681A*A.. <Euro2>; F2BE0681A*B..	Mot.-Nr. →13740 Mot.-Nr. 13741→	08.00-08.04 08.00-08.04		<b>0 414 700 002</b>	<b>0 986 441 102</b>	
38, 44, 48	13,0	280/324/ 353	F3BE0681C*B..; F3BE0681E*B..; F3BE0681G*B..		08.00-08.04		<b>0 414 701 083</b>	<b>0 986 441 013</b>	
<b>400 E</b> 35	7,8	259	F2BE0681A*A.. <Euro2>; F2BE0681A*B..	Mot.-Nr. →13740 Mot.-Nr. 13741→	08.00-08.04 08.00-08.04		<b>0 414 700 002</b>	<b>0 986 441 102</b>	
38, 44	13,0	280/324	F3BE0681C*B..; F3BE0681G*B..		08.00-08.04		<b>0 414 701 083</b>	<b>0 986 441 013</b>	
<b>410 E</b> 35	7,8	259	F2BE0681A*A.. <Euro2>; F2BE0681A*B..	Mot.-Nr. →13740 Mot.-Nr. 13741→	08.00-08.04 08.00-08.04		<b>0 414 700 002</b>	<b>0 986 441 102</b>	
38, 44, 48	13,0	280/324/ 353	F3BE0681C*B..; F3BE0681E*B..; F3BE0681G*B..		08.00-08.04		<b>0 414 701 083</b>	<b>0 986 441 013</b>	
<b>440 E</b> 38, 44	13,0	280/324	F3BE0681C*B..; F3BE0681G*..		08.00-08.04		<b>0 414 701 083</b>	<b>0 986 441 013</b>	
39	10,5	287	F3AE0681E*A..		08.00-08.04		<b>0 414 701 084</b>	<b>0 986 441 003</b>	
<b>720 E</b> 44, 48	13,0	324/353	F3BE0681C*B..; F3BE0681E*B..		08.00-08.04		<b>0 414 701 083</b>	<b>0 986 441 013</b>	
<b>Stralis</b>									
<b>L 190 S</b> 42, 45 [07]	10,3	309/331	F3AE3681A*...; F3AE3681D*...		04.07-12.12		<b>0 414 703 008</b>	<b>0 986 441 026</b>	
50 [07]	12,9	368	F3AE3681B*...		04.07-12.12 TW		<b>0 414 703 004</b>	<b>0 986 441 025</b>	
<b>L 260 S</b> 50 [07]	12,9	368	F3BE3681B*...		04.07-12.12 TW		<b>0 414 703 004</b>	<b>0 986 441 025</b>	
56 [07]	12,9	412	F3BE3681A*...		04.07-12.12		<b>0 414 703 004</b>	<b>0 986 441 025</b>	
<b>L 320 S</b> 42, 45 [07]	10,3	309/331	F3AE3681A*...; F3AE3681D*...		06.11-12.12		<b>0 414 703 008</b>	<b>0 986 441 026</b>	
<b>L 440 S</b> 42, 45 [07]	10,3	309/331	F3AE3681A*...; F3AE3681D*...		04.07-12.12		<b>0 414 703 008</b>	<b>0 986 441 026</b>	
48 [07]	13,0	353	F3BE3681H*..		08.06-12.12		<b>0 414 701 083</b>	<b>0 986 441 013</b>	
50 [07]	12,9	368	F3BE3681B*...		04.07-12.12 TW		<b>0 414 703 004</b>	<b>0 986 441 025</b>	
56 [07]	12,9	412	F3BE3681A*...		04.07-12.12		<b>0 414 703 008</b>	<b>0 986 441 026</b>	
<b>N 190 S</b> 31, 33, 36 [07]	7,8	228/243/ 265	F2BE3681A*...; F2BE3681B*...; F2BE3681C*..		04.07-12.12		<b>0 414 700 006</b>	<b>0 986 441 020</b>	
<b>N 260 S</b> 31, 36 [07]	7,8	228/265	F2BE3681A*...; F2BE3681C*...		04.07-12.12		<b>0 414 700 006</b>	<b>0 986 441 020</b>	
33 [07]	12,9	243	F3AE3681B*...		04.07-12.12		<b>0 414 700 006</b>	<b>0 986 441 020</b>	
<b>N 440 S</b> 33, 36 [07]	7,8	243/265	F2BE3681A*...; F2BE3681B*..		04.07-12.12		<b>0 414 700 006</b>	<b>0 986 441 020</b>	





◀ IVECO

<b>190 S</b> 27, 30, 31, 35	7,8	200/218/228/259	F2BE0681A*...; F2BE0681B*B...Euro3; F2BE0681E...; F2BE0681F..	Mot.-Nr. →13740 Mot.-Nr. 13741→	08.03-03.06 08.03-03.06	<b>0 414 700 002</b> <b>0 414 700 003</b>	<b>0 986 441 102</b> <b>0 986 441 112</b>	
31, 33, 36	7,8	228/243/265	F2BE3681A*...; F2BE3681B*...; F2BE3681C*...		04.06-12.12	<b>0 414 700 006</b>	<b>0 986 441 020</b>	
40	10,3	294	F3AE0681*...		08.02-03.06	<b>0 414 701 084</b>	<b>0 986 441 003</b>	
42, 45	10,3	309/331	F3AE3681A*...; F3AE3681D*...		04.06-12.12	<b>0 414 703 008</b>	<b>0 986 441 026</b>	
43	10,5	316	F3AE0681D*..		08.02-12.12 TW	<b>0 414 701 084</b> <b>0 414 703 008</b>	<b>0 986 441 003</b> <b>0 986 441 026</b>	
48	13,0	353	F3BE0681E*D..		08.02-03.06	<b>0 414 701 083</b>	<b>0 986 441 013</b>	
50	12,9	368	F3AE3681B*...		04.06-12.12	<b>0 414 703 004</b>	<b>0 986 441 025</b>	
<b>260 S</b> 27, 30, 31	7,8	200/218/228	F2BE0681B*B...Euro3; F2BE0681E...; F2BE0681F..	Mot.-Nr. →13740 Mot.-Nr. 13741→	08.03-03.06 08.03-03.06	<b>0 414 700 002</b> <b>0 414 700 003</b>	<b>0 986 441 102</b> <b>0 986 441 112</b>	
31, 33, 36	7,8	228/243/265	F2BE3681A*...; F2BE3681B*...; F2BE3681C*...		04.06-12.12	<b>0 414 700 006</b>	<b>0 986 441 020</b>	
35	7,8	259	F2BE0681A*..		08.03-03.06 TW	<b>0 414 700 002</b> <b>0 414 700 003</b> <b>0 414 700 006</b>	<b>0 986 441 102</b> <b>0 986 441 112</b> <b>0 986 441 020</b>	
40	10,3	294	F3AE0681...		08.02-03.06	<b>0 414 701 084</b>	<b>0 986 441 003</b>	
42 Cube, 45 Cube [07]	10,3	309/331	F3AE3681A*...; F3AE3681D*...		04.07-12.12	<b>0 414 703 008</b>	<b>0 986 441 026</b>	
42, 45	10,3	309/331	F3AE3681A*...; F3AE3681D*...		04.06-12.12	<b>0 414 703 008</b>	<b>0 986 441 026</b>	
43	10,5	316	F3AE0681D*..		08.02-03.06 TW	<b>0 414 701 084</b> <b>0 414 703 009</b>	<b>0 986 441 003</b> <b>0 986 441 027</b>	
44, 48, 54	13,0	324/353/397	F3BE0681A*...; F3BE0681C*B...; F3BE0681E*..		08.02-03.06	<b>0 414 701 083</b>	<b>0 986 441 013</b>	
50	12,9	368	F3BE3681B*...		04.06-12.12	<b>0 414 703 004</b>	<b>0 986 441 025</b>	
56	12,9	412	F3BE3681A*M		04.06-05.09	<b>0 414 703 008</b>	<b>0 986 441 026</b>	
<b>320 S</b> 36	7,8	265	F2BE3681A*..		04.06-12.12	<b>0 414 700 006</b>	<b>0 986 441 020</b>	
<b>400 S</b> 56	12,9	412	F3BE3681A*..		04.06-12.12	<b>0 414 703 004</b>	<b>0 986 441 025</b>	
<b>440 S</b> 31, 35	7,8	228/259	F2BE0681A*...; F2BE0681B*..	Mot.-Nr. →13740 Mot.-Nr. 13741→	08.03-12.12 08.03-12.12	<b>0 414 700 002</b> <b>0 414 700 003</b>	<b>0 986 441 102</b> <b>0 986 441 112</b>	
33, 36	7,8	243/265	F2BE3681A*...; F2BE3681B*M		04.06-12.12	<b>0 414 700 006</b>	<b>0 986 441 020</b>	
40	10,3	294	F3AE0681...		08.02-03.06	<b>0 414 701 084</b>	<b>0 986 441 003</b>	
42, 45	10,3	309/331	F3AE3681A*...; F3AE3681D*...		04.06-12.12	<b>0 414 703 008</b>	<b>0 986 441 026</b>	
43	10,5	316	F3AE0681D*..		08.02-12.12 TW	<b>0 414 701 084</b> <b>0 414 703 009</b>	<b>0 986 441 003</b> <b>0 986 441 027</b>	
44, 54	13,0	324/397	F3BE0681A*...; F3BE0681C*..		08.03-03.06	<b>0 414 701 083</b>	<b>0 986 441 013</b>	
50	12,9	368	F3...		04.06-12.12	<b>0 414 703 004</b>	<b>0 986 441 025</b>	
56	12,9	412	F3...		04.06-12.12	<b>0 414 703 008</b>	<b>0 986 441 026</b>	
<b>Stralis Hi-Way</b>								
<b>310</b>	7,8	228	F2BE3681C*...		07.12→	<b>0 414 700 006</b>	<b>0 986 441 020</b>	
<b>330</b>	7,8	243	F2BE3681B*...		07.12→	<b>0 414 700 006</b>	<b>0 986 441 020</b>	
<b>360</b>	7,8	265	F2BE3681A*...		07.12→	<b>0 414 700 006</b>	<b>0 986 441 020</b>	
<b>420</b>	10,3	309	F3AE3681D*...		07.12→	<b>0 414 703 008</b> <b>0 414 703 004</b>	<b>0 986 441 026</b> <b>0 986 441 025</b>	
<b>460</b>	10,3	338	F3AE3681Y*...		07.12→	<b>0 414 703 008</b>	<b>0 986 441 026</b>	
<b>480</b>	13,0	353	F3BE3681H*..		07.12→	<b>0 414 703 004</b>	<b>0 986 441 025</b>	
<b>500</b>	12,9	368	F3BE3681B*...		07.12→	<b>0 414 703 004</b>	<b>0 986 441 025</b>	
<b>560</b>	12,9	412	F3BE3681A*...		07.12→	<b>0 414 703 004</b>	<b>0 986 441 025</b>	
<b>Trakker</b>								
<b>N 190 T</b> 31, 33, 36 [07]	7,8	228/243/265	F2BE3681A*...; F2BE3681B*...; F2BE3681C*...		07.07-06.13	<b>0 414 700 006</b>	<b>0 986 441 020</b>	
41, 45 [07]	13,0	302/331	F3BE3681C*...; F3BE3681D*...		07.07-06.13	<b>0 414 703 004</b>	<b>0 986 441 025</b>	
<b>N 260 T</b> 33, 36 [07]	7,8	243/265	F2BE3681A*...; F2BE3681B*...		07.07-06.13	<b>0 414 700 006</b>	<b>0 986 441 020</b>	
41, 45 [07]	13,0	302/331	F3BE3681C*...; F3BE3681D*...		07.07-06.13	<b>0 414 703 004</b>	<b>0 986 441 025</b>	
50 [07]	12,9	368	F3BE3681B*...		07.07-06.13	<b>0 414 703 004</b>	<b>0 986 441 025</b>	
<b>N 340 T</b> 36 [07]	7,8	265	F2BE3681A*...		07.07-06.13	<b>0 414 700 006</b>	<b>0 986 441 020</b>	
41, 45 [07]	13,0	302/331	F3BE3681C*...; F3BE3681D*...		07.07-06.13	<b>0 414 703 004</b>	<b>0 986 441 025</b>	
<b>N 380 T</b> 41, 45 [07]	13,0	302/331	F3BE3681C*...; F3BE3681D*...		07.07-06.13	<b>0 414 703 004</b>	<b>0 986 441 025</b>	



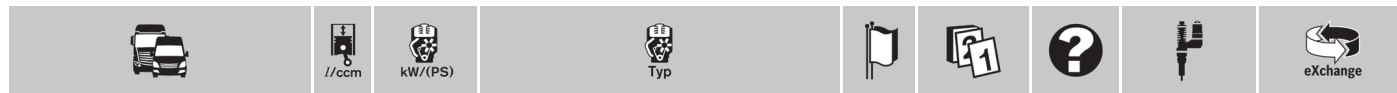

<b>N 380T</b> 50 [07]	12,9	368	F3BE3681B*...	07.07-06.13	<b>0 414 703 004</b>	<b>0 986 441 025</b>
<b>N 400T</b> 36 [07]	7,8	265	F2BE3681A*...	07.07-06.13	<b>0 414 700 006</b>	<b>0 986 441 020</b>
41, 45 [07]	13,0	302/331	F3BE3681C*...; F3BE3681D*...	07.07-06.13	<b>0 414 703 004</b>	<b>0 986 441 025</b>
50 [07]	12,9	368	F3BE3681B*...	07.07-06.13	<b>0 414 703 004</b>	<b>0 986 441 025</b>
<b>N 410T</b> 41, 45 [07]	13,0	302/331	F3BE3681C*...; F3BE3681D*...	07.07-06.13	<b>0 414 703 004</b>	<b>0 986 441 025</b>
50 [07]	12,9	368	F3BE3681B*...	07.07-06.13	<b>0 414 703 004</b>	<b>0 986 441 025</b>
<b>N 440T</b> 41, 45 [07]	13,0	302/331	F3BE3681C*...; F3BE3681D*...	07.07-06.13	<b>0 414 703 004</b>	<b>0 986 441 025</b>
50 [07]	12,9	368	F3BE3681B*...	07.07-06.13	<b>0 414 703 004</b>	<b>0 986 441 025</b>
<b>N 720T</b> 41, 45 [07]	13,0	302/331	F3BE3681C*...; F3BE3681D*...	07.07-06.13	<b>0 414 703 004</b>	<b>0 986 441 025</b>
50 [07]	12,9	368	F3BE3681B*...	07.07-06.13	<b>0 414 703 004</b>	<b>0 986 441 025</b>
<b>180T</b> 24, 27, 31	7,8	180/200/228	F2BE0681B*B...; F2BE0681D...; F2BE0681F*B... Mot.-Nr. →13740 Mot.-Nr. 13741→	09.04-03.06 09.04-03.06	<b>0 414 700 002</b> <b>0 414 700 003</b>	<b>0 986 441 102</b> <b>0 986 441 112</b>
<b>190T</b> 27, 31, 35	7,8	200/228/259	F2BE0681A*B...; F2BE0681B*B...; F2BE0681F*B... Mot.-Nr. →13740 Mot.-Nr. 13741→	09.04-09.06 09.04-09.06	<b>0 414 700 002</b> <b>0 414 700 003</b>	<b>0 986 441 102</b> <b>0 986 441 112</b>
31, 33, 36	7,8	228/243/265	F2BE3681A*...; F2BE3681B*...; F2BE3681C*...	04.06-12.12	<b>0 414 700 006</b>	<b>0 986 441 020</b>
38, 41, 45	13,0	280/302/331	F3BE3681C*...; F3BE3681D*...	04.05-12.12	<b>0 414 703 004</b>	<b>0 986 441 025</b>
38, 44	13,0	280/324	F3BE0681C*...; F3BE0681G*A...	09.04-12.12	<b>0 414 701 083</b>	<b>0 986 441 013</b>
<b>190T</b> 31, 33, 36 [13]	7,8	228/243/265	F2BE3681A*...; F2BE3681B*...; F2BE3681C*...	01.13→	<b>0 414 700 006</b>	<b>0 986 441 020</b>
41, 45 [13]	13,0	301/332	F3BE3681C*S; F3BE3681D*S	01.13→	<b>0 414 703 004</b>	<b>0 986 441 025</b>
<b>260T</b> 31, 35	7,8	228/259	F2BE0681A*B...; F2BE0681B*B... Mot.-Nr. →13740 Mot.-Nr. 13741→	09.04-03.06 09.04-03.06	<b>0 414 700 002</b> <b>0 414 700 003</b>	<b>0 986 441 102</b> <b>0 986 441 112</b>
33, 36	7,8	243/265	F2BE3681A*...; F2BE3681B*...	04.06-12.12	<b>0 414 700 006</b>	<b>0 986 441 020</b>
38, 44, 48	13,0	280/324/353	F3BE0681C*B...; F3BE0681E*B...; F3BE0681G*B...	09.04-12.12	<b>0 414 701 083</b>	<b>0 986 441 013</b>
41, 45	13,0	302/331	F3BE3681C*...; F3BE3681D*...	04.06-12.12	<b>0 414 703 004</b>	<b>0 986 441 025</b>
50	12,9	368	F3BE3681B*...	04.06-12.12	<b>0 414 703 004</b>	<b>0 986 441 025</b>
<b>260T</b> 33, 36 [13]	7,8	243/265	F2BE3681A*...; F2BE3681B*...	01.13→	<b>0 414 700 006</b>	<b>0 986 441 020</b>
41, 45 [13]	13,0	301/332	F3BE3681C*S; F3BE3681D*S	01.13→	<b>0 414 703 004</b>	<b>0 986 441 025</b>
50 [13]	12,9	368	F3BE3681B*...	01.13→	<b>0 414 703 004</b>	<b>0 986 441 025</b>
<b>340T</b> 35	7,8	259	F2BE0681A*B... Mot.-Nr. →13740 Mot.-Nr. 13741→	09.04-03.06 09.04-03.06	<b>0 414 700 002</b> <b>0 414 700 003</b>	<b>0 986 441 102</b> <b>0 986 441 112</b>
36	7,8	265	F2BE3681A*...	04.06-12.12	<b>0 414 700 006</b>	<b>0 986 441 020</b>
38, 44	13,0	280/324	F3BE0681C*B...; F3BE0681G*B...	09.04-03.06	<b>0 414 701 083</b>	<b>0 986 441 013</b>
41, 45	13,0	302/331	F3BE3681C*...; F3BE3681D*...	04.06-12.12	<b>0 414 703 004</b>	<b>0 986 441 025</b>
<b>340T</b> 36 [13]	7,8	265	F2BE3681A*...	01.13→	<b>0 414 700 006</b>	<b>0 986 441 020</b>
41, 45 [13]	13,0	301/332	F3BE3681C*S; F3BE3681D*S	01.13→	<b>0 414 703 004</b>	<b>0 986 441 025</b>
50 [13]	12,9	368	F3BE3681B*...	01.18→	<b>0 414 703 004</b>	<b>0 986 441 025</b>
<b>380T</b> 35	7,8	259	F2BE0681A*B... Mot.-Nr. →13740 Mot.-Nr. 13741→	09.04-03.06 09.04-03.06	<b>0 414 700 002</b> <b>0 414 700 003</b>	<b>0 986 441 102</b> <b>0 986 441 112</b>
36	7,8	265	F2BE3681A*...	04.06-12.12	<b>0 414 700 006</b>	<b>0 986 441 020</b>
38, 48	13,0	280/353	F3BE0681E*B...; F3BE0681G*...	09.04-12.12	<b>0 414 701 083</b>	<b>0 986 441 013</b>
41, 45	13,0	302/331	F3BE3681C*...; F3BE3681D*...	04.06-12.12	<b>0 414 703 004</b>	<b>0 986 441 025</b>
42	13,0	309	F3BE0681V*...	04.06-12.12 TW	<b>0 414 701 083</b>	<b>0 986 441 013</b>
					<b>0 414 703 004</b>	<b>0 986 441 025</b>
44	13,0	324	F3BE0681C*B...	09.04-12.12 TW	<b>0 414 701 083</b>	<b>0 986 441 013</b>
					<b>0 414 703 004</b>	<b>0 986 441 025</b>
50	12,9	368	F3BE3681B*...	04.06-12.12	<b>0 414 703 004</b>	<b>0 986 441 025</b>
<b>380T</b> 36 [13]	7,8	265	F2BE3681A*...	01.13→	<b>0 414 700 006</b>	<b>0 986 441 020</b>
41, 45 [13]	13,0	301/332	F3BE3681C*S; F3BE3681D*S	01.13→	<b>0 414 703 004</b>	<b>0 986 441 025</b>
42 [13]	10,3	309	F3AE3681D*...	07.13→	<b>0 414 703 004</b>	<b>0 986 441 025</b>
50 [13]	12,9	368	F3BE3681B*...	01.13→	<b>0 414 703 004</b>	<b>0 986 441 025</b>
35 7,8	259	F2BE0681A*B... Mot.-Nr. →13740 Mot.-Nr. 13741→	09.04-03.06 09.04-03.06	<b>0 414 700 002</b> <b>0 414 700 003</b>	<b>0 986 441 102</b> <b>0 986 441 112</b>	
36	7,8	265	F2BE3681A*...	04.06-12.12	<b>0 414 700 006</b>	<b>0 986 441 020</b>





◀ IVECO

<b>400 T 38</b>	13,0	280	F3BE0681G*...	09.04-12.12	TW	<b>0 414 701 083</b>	<b>0 986 441 013</b>
						<b>0 414 703 004</b>	<b>0 986 441 025</b>
41	13,0	302	F3BE3681D*...	04.06-12.12		<b>0 414 703 004</b>	<b>0 986 441 025</b>
42	13,0	309	F3BE0681V*...	04.06-12.12		<b>0 414 701 083</b>	<b>0 986 441 013</b>
44	13,0	324	F3BE0681C*B..	09.04-03.06		<b>0 414 701 083</b>	<b>0 986 441 013</b>
50	12,9	368	F3BE3681B*...	04.06-12.12		<b>0 414 703 004</b>	<b>0 986 441 025</b>
<b>400T 41 [13]</b>	13,0	301	F3BE3681D*...	01.13→	TW	<b>0 414 700 006</b>	<b>0 986 441 020</b>
						<b>0 414 703 004</b>	<b>0 986 441 025</b>
45 [13]	13,0	301	F3BE3681C*S	01.13→		<b>0 414 703 004</b>	<b>0 986 441 025</b>
50 [13]	12,9	368	F3BE3681B*...	01.13→		<b>0 414 703 004</b>	<b>0 986 441 025</b>
<b>410 T 35</b>	7,8	259	F2BE0681A*B..				
			Mot.-Nr. →13740	09.04-03.06		<b>0 414 700 002</b>	<b>0 986 441 102</b>
			Mot.-Nr. 13741→	09.04-03.06		<b>0 414 700 003</b>	<b>0 986 441 112</b>
36	7,8	265	F2BE3681A*...	04.06-12.12		<b>0 414 700 006</b>	<b>0 986 441 020</b>
38	13,0	280	F3BE0681G*B..	09.04-12.12	TW	<b>0 414 701 083</b>	<b>0 986 441 013</b>
						<b>0 414 703 004</b>	<b>0 986 441 025</b>
41, 45	13,0	302/331	F3BE3681C*...; F3BE3681D*...	04.06-12.12		<b>0 414 703 004</b>	<b>0 986 441 025</b>
42	13,0	309	F3BE0681V*...	04.06-12.12		<b>0 414 701 083</b>	<b>0 986 441 013</b>
44	13,0	324	F3BE0681C*B..	09.04-12.12	TW	<b>0 414 701 083</b>	<b>0 986 441 013</b>
						<b>0 414 703 004</b>	<b>0 986 441 025</b>
48	13,0	353	F3BE0681E*B..	09.04-03.06		<b>0 414 701 083</b>	<b>0 986 441 013</b>
50	12,9	368	F3BE3681B*...	04.06-12.12		<b>0 414 703 004</b>	<b>0 986 441 025</b>
<b>410T 41, 45 [13]</b>	13,0	301	F3BE3681C*S; F3BE3681D*S	01.13→		<b>0 414 703 004</b>	<b>0 986 441 025</b>
42 [13]	10,3	309	F3AE3681D*...	07.13→		<b>0 414 703 004</b>	<b>0 986 441 025</b>
50 [13]	12,9	368	F3BE3681B*...	01.13→		<b>0 414 703 004</b>	<b>0 986 441 025</b>
<b>440 T 38, 44</b>	13,0	280/324	F3BE0681C*B..; F3BE0681G*B..	09.04-12.12		<b>0 414 701 083</b>	<b>0 986 441 013</b>
41, 45	13,0	302/331	F3BE3681C*...; F3BE3681D*...	04.06-12.12		<b>0 414 703 004</b>	<b>0 986 441 025</b>
50	12,9	368	F3BE3681B*...	04.06-12.12		<b>0 414 703 004</b>	<b>0 986 441 025</b>
<b>440T 41, 45 [13]</b>	13,0	301/332	F3BE3681C*S; F3BE3681D*...	01.13→		<b>0 414 703 004</b>	<b>0 986 441 025</b>
50 [13]	12,9	368	F3BE3681B*...	01.13→		<b>0 414 703 004</b>	<b>0 986 441 025</b>
<b>720 T 38, 44, 48</b>	13,0	280/324/ 353	F3BE0681C*B..; F3BE0681E*B..; F3BE0681G*...	09.04-12.12		<b>0 414 701 083</b>	<b>0 986 441 013</b>
41, 45	13,0	302/331	F3BE3681C*...; F3BE3681D*...	04.06-12.12		<b>0 414 703 004</b>	<b>0 986 441 025</b>
42	13,0	309	F3BE0681V*...	04.06-12.12	TW	<b>0 414 701 083</b>	<b>0 986 441 013</b>
						<b>0 414 703 004</b>	<b>0 986 441 025</b>
50	12,9	368	F3BE3681B*...	04.06-12.12		<b>0 414 703 004</b>	<b>0 986 441 025</b>
<b>720T 41, 45 [13]</b>	13,0	301/332	F3BE3681C*S; F3BE3681D*...	01.13→		<b>0 414 703 004</b>	<b>0 986 441 025</b>
50 [13]	12,9	368	F3BE3681B*...	01.13→		<b>0 414 703 004</b>	<b>0 986 441 025</b>



**SCANIA**

<b>G</b>							
<b>230</b>	8,9	169	DC 9.13 <Euro 3>	09.07→		<b>0 414 701 061</b>	
			DC 9.16 <Euro 4>	09.07→		<b>0 414 701 065</b>	
<b>270</b>	8,9	198	DC 9.12 <Euro 3>	09.07→		<b>0 414 701 061</b>	
			DC 9.17 <Euro 4>	09.07→		<b>0 414 701 062</b>	
<b>310</b>	8,9	228	DC 9.11 <Euro 3>	09.07→		<b>0 414 701 061</b>	
			DC 9.18 <Euro 4>	09.07→		<b>0 414 701 062</b>	
<b>340</b>	10,6	250	DC 11.08 <Euro 3>				
			Mot.-Typ L01	09.07→		<b>0 414 701 027</b>	<b>0 986 441 015</b>
			Mot.-Typ L02	09.07→		<b>0 414 701 045</b>	
<b>380</b>	11,0	280	DC 11.09 <Euro 3>	09.07→		<b>0 414 701 027</b>	<b>0 986 441 015</b>
	12,0	280	DC 12.17 <Euro 3>	09.08→		<b>0 414 701 066</b>	
<b>410</b>	12,7	302	DC13 107 <Euro 3>	10.11→		<b>0 414 701 072</b>	
<b>420</b>	12,0	309	DC 12.06 <Euro 3>	09.07→		<b>0 414 701 066</b>	
<b>460</b>	12,7	339	DC13 106 <Euro 3>	10.11→		<b>0 414 701 072</b>	
<b>P</b>							
<b>230</b>	8,9	169	DC 9.13 <Euro 3>	09.04→		<b>0 414 701 061</b>	
			DC 9.16 <Euro 4>	09.05→		<b>0 414 701 065</b>	
<b>270</b>	8,9	198	DC 9.12 <Euro 3>	09.04→		<b>0 414 701 061</b>	
			DC 9.17 <Euro 4>	09.05→		<b>0 414 701 062</b>	
<b>310</b>	8,9	228	DC 9.11 <Euro 3>	09.04→		<b>0 414 701 061</b>	



310	8,9	228	DC 9.18 <Euro 4>	09.05→	0 414 701 062	
340	10,6	250	DC 11.08 <Euro 3>			
			Mot.-Typ L01	09.04→	0 414 701 027	0 986 441 015
			Mot.-Typ L02	09.04→	0 414 701 045	
380	11,0	280	DC 11.09 <Euro 3>			
			Mot.-Typ L01	09.04→	0 414 701 027	0 986 441 015
			Mot.-Typ L02	09.04→	0 414 701 045	
	12,0	280	DC 12.17 <Euro 3>	09.07→	0 414 701 066	
420	12,0	309	DC 12.06 <Euro 3>	09.07→	0 414 701 066	
<b>R</b>						
230	8,9	169	DC 9.13 <Euro 3>	09.04→	0 414 701 061	
			DC 9.16 <Euro 4>	09.05→	0 414 701 065	
270	8,9	198	DC 9.12 <Euro 3>	09.04→	0 414 701 061	
			DC 9.17 <Euro 4>	09.05→	0 414 701 062	
310	8,9	228	DC 9.11 <Euro 3>	09.04→	0 414 701 061	
			DC 9.18 <Euro 4>	09.05→	0 414 701 062	
340	10,6	250	DC 11.08 <Euro 3>			
			Mot.-Typ L01	03.04→	0 414 701 027	0 986 441 015
			Mot.-Typ L02	03.04→	0 414 701 045	
380	11,0	280	DC 11.09 <Euro 3>			
			Mot.-Typ L01	03.04→	0 414 701 027	0 986 441 015
			Mot.-Typ L02	03.04→	0 414 701 045	
	12,0	280	DC 12.17 <Euro 3>	09.07→	0 414 701 066	
410	12,7	302	DC13 107 <Euro 3>	10.11→	0 414 701 072	
420	12,0	309	DC 12.06 <Euro 3>	09.07→	0 414 701 066	
500	15,6	368	DC 16.04 <Euro 3>	03.04→	0 414 701 028	0 986 441 016
	16,0	368	DC 16.06 <Euro 4>; DC 16.09 <Euro 5>; DC 16.19 <Euro 5>	02.06→	0 414 701 063	
560	16,0	412	DC 16.05 <Euro 4>; DC 16.18 <Euro 5>	02.06→	0 414 701 064	
580	16,0	426	DC 16.03 <Euro 3>	04.04→	0 414 701 028	0 986 441 016
620	16,0	456	DC 16.08 <Euro 4>; DC 16.17 <Euro 5>	02.06→	0 414 701 064	
<b>Serie 114</b>						
K EB, IB [BUS]	10,6	250	DC 11.06 <Euro 3>			
			Mot.-Nr. →6173205 SSS	08.97→	0 414 701 016	
			Mot.-Nr. 6173206 SSS→	08.97→	0 414 701 018	
		250/280	DC 11.03 <Euro 3>; DC 11.04 <Euro 3>			
			Mot.-Nr. →6173205 SSS	08.97→	0 414 701 057	0 986 441 008
			Mot.-Nr. 6173206 SSS→	08.97→	0 414 701 027	0 986 441 015
P,R 340	10,6	250	DC 11.06 <Euro 3>			
			Mot.-Nr. →6173205 SSS	02.96-09.04	0 414 701 016	
			Mot.-Nr. 6173206 SSS→	02.96-09.04	0 414 701 018	
340, 380	10,6	250/280	DC 11.01 <Euro 2>; DC 11.02 <Euro 2>			
			Mot.-Nr. →6173205 SSS	03.96-02.02	0 414 701 105	0 986 441 001
			Mot.-Nr. 6173206 SSS→	03.96-02.02	0 414 701 017	0 986 441 014
			DC 11.03 <Euro 3>; DC 11.04 <Euro 3>			
			Mot.-Nr. →6173205 SSS	02.96-09.04	0 414 701 057	0 986 441 008
			Mot.-Nr. 6173206 SSS→	02.96-09.04	0 414 701 027	0 986 441 015
T 340	10,6	250	DC 11.06 <Euro 3>			
			Mot.-Nr. →6173205 SSS	02.96-09.04	0 414 701 016	
			Mot.-Nr. 6173206 SSS→	02.96-09.04	0 414 701 018	
340, 380	10,6	250/280	DC 11.01 <Euro 2>; DC 11.02 <Euro 2>			
			Mot.-Nr. →6173205 SSS	03.96-02.02	0 414 701 105	0 986 441 001
			Mot.-Nr. 6173206 SSS→	03.96-02.02	0 414 701 017	0 986 441 014
			DC 11.03 <Euro 3>; DC 11.04 <Euro 3>			
			Mot.-Nr. →6173205 SSS	02.96-09.04	0 414 701 057	0 986 441 008
			Mot.-Nr. 6173206 SSS→	02.96-09.04	0 414 701 027	0 986 441 015
<b>Serie 124</b>						
K EB [BUS]	11,7	309	DC 12.01 <Euro 3>			
			Mot.-Nr. →6173205 SSS	10.97-08.02	0 414 701 056	0 986 441 007
			Mot.-Nr. 6173206 SSS→	10.97-08.02	0 414 701 028	0 986 441 016
EB, IB [BUS]	12,0	309	DSC 12.05 <Euro 2>			
			Mot.-Nr. →6173205 SSS	08.97-02.02	0 414 701 105	0 986 441 001
			Mot.-Nr. 6173206 SSS→	08.97-02.02	0 414 701 017	0 986 441 014





◀ SCANIA

<b>K</b> IB [BUS]	12,0	294	DC 12.02 <Euro 3>				
			Mot.-Nr. →6173205 SSS	08.97→	0414 701 057	0986 441 008	
			Mot.-Nr. 6173206 SSS→	08.97→	0414 701 027	0986 441 015	
		309	DC 12.01 <Euro 3>				
			Mot.-Nr. →6173205 SSS	08.97-08.02	0414 701 056	0986 441 007	
			Mot.-Nr. 6173206 SSS→	08.97-08.02	0414 701 028	0986 441 016	
<b>P,R</b> 360	12,0	265	DC 12.02 <Euro 3>		09.95-09.04	0414 701 057	0986 441 008
420	12,0	309	DC 12.01 <Euro 3>				
			Mot.-Nr. →6173205 SSS	09.95-08.02		0414 701 056	0986 441 007
			Mot.-Nr. 6173206 SSS→	09.95-08.02		0414 701 028	0986 441 016
			DSC 12.05 <Euro 2>				
			Mot.-Nr. →6173205 SSS	09.95-02.02		0414 701 105	0986 441 001
			Mot.-Nr. 6173206 SSS→	09.95-02.02		0414 701 017	0986 441 014
<b>T</b> 400, 420	12,0	294/309	DC 12.02 <Euro 3>		09.95-09.04	0414 701 057	0986 441 008
420	12,0	309	DC 12.01 <Euro 3>				
			Mot.-Nr. →6173205 SSS	09.95-08.02		0414 701 056	0986 441 007
			Mot.-Nr. 6173206 SSS→	09.95-08.02		0414 701 028	0986 441 016
			DSC 12.03 <Euro 2>	06.96-02.02		0414 701 105	
			DSC 12.05 <Euro 2>				
			Mot.-Nr. →6173205 SSS	09.95-02.02		0414 701 105	0986 441 001
			Mot.-Nr. 6173206 SSS→	09.95-02.02		0414 701 017	0986 441 014
<b>Serie 164</b>							
<b>R</b> 480	16,0	353	DC 16.02 <Euro 3>				
			Mot.-Nr. →6173205 SSS	04.00-05.04		0414 701 057	0986 441 008
			Mot.-Nr. 6173206 SSS→	04.00-05.04		0414 701 027	0986 441 015
			580	16,0	427	DC 16.01 <Euro 3>	
			Mot.-Nr. →6173205 SSS	04.00-05.04		0414 701 056	0986 441 007
			Mot.-Nr. 6173206 SSS→	04.00-05.04		0414 701 028	0986 441 016
<b>T</b> 480	16,0	353	DC 16.02 <Euro 3>				
			Mot.-Nr. →6173205 SSS	04.00-09.04		0414 701 057	0986 441 008
			Mot.-Nr. 6173206 SSS→	04.00-09.04		0414 701 027	0986 441 015
			580	16,0	427	DC 16.01 <Euro 3>	
			Mot.-Nr. →6173205 SSS	04.00-09.04		0414 701 056	0986 441 007
			Mot.-Nr. 6173206 SSS→	04.00-09.04		0414 701 028	0986 441 016
<b>T</b>							
<b>340</b>	10,6	250	DC 11.08 <Euro 3>				
			Mot.-Typ L01	09.04-10.05		0414 701 027	0986 441 015
			Mot.-Typ L02	09.04-10.05		0414 701 045	
<b>380</b>	11,0	280	DC 11.09 <Euro 3>	09.04-10.05		0414 701 027	0986 441 015
<b>500</b>	15,6	368	DC 16.04 <Euro 3>	09.04-10.05		0414 701 028	0986 441 016
<b>580</b>	16,0	426	DC 16.03 <Euro 3>	09.04-10.05		0414 701 028	0986 441 016

**VOLVO**

**B**

<b>12</b> CH 5000-	12,0	250/272/	D12A340 <Euro 2>; D12A370 <Euro 2>; D12A380				
		279/305/	<Euro 2>; D12A415 <Euro 2>; D12A420 <Euro 2>				
		309	Mot.-Nr. →93097	10.95-12.00	TW	0414 701 055	0986 441 004
			Mot.-Nr. 93098→	10.95-12.00	TW	0414 702 017	0986 441 005

**FH**

<b>12</b> 340	12,0	250	D 12C340 <Euro 2>	08.98-08.02	BO,TW	0414 702 006	0986 441 110
340, 380	12,1	250/280	D 12D340; D 12D380	12.01-08.06	BO	0414 702 019	0986 441 011
340, 380, 420	12,0	250/279/	D12A340 <Euro 2>; D12A380 <Euro 2>;				
		309	D12A420 <Euro 2>				
			Mot.-Nr. →93097	08.93-08.98	BO	0414 701 055	0986 441 004
			Mot.-Nr. 93098→	08.93-08.98	BO	0414 702 017	
380	12,1	279	D 12C380	08.98-08.02	BO,TW	0414 702 006	0986 441 110
420	12,1	309	D 12C420	08.98-08.02	BO,TW	0414 702 006	0986 441 110
						0414 702 021	0986 441 006
			D 12D420	12.01-08.06	BO,E96	0414 702 021	0986 441 006
460	12,1	338	D 12C460	08.98-08.02	BO,TW	0414 702 021	0986 441 006



l/ccm



kW/(PS)



Typ



eXchange

FL							
12	380, 420	12,0	279/309	D12A380 <Euro 2>; D12A420 <Euro 2>			
				Mot.-Nr. →93097	09.95-12.01	BO	0 414 701 055 0 986 441 004
				Mot.-Nr. 93098→	09.95-12.01	BO	0 414 702 017
FM							
12	340, 380	12,1	250/279	D 12C340; D 12C380	09.98-01.02	BO,EC9	0 414 702 018 0 986 441 110
						BO,EU2	0 414 702 021 0 986 441 006
			250/280	D 12D340; D 12D380	01.02-09.05	EU2	0 414 702 021 0 986 441 006
						EU3	0 414 702 019 0 986 441 011
	420	12,1	309	D 12C420	09.98-01.02	BO,EU2	0 414 702 021 0 986 441 006
						BO,TW	0 414 702 019 0 986 441 011
	420, 460	12,1	309/339	D 12D420; D 12D460	01.02-09.05	EU2	0 414 702 021 0 986 441 006
	425	12,0	313	D12C425	11.02-09.05	BO,E96	0 414 702 021 0 986 441 006

## VW (VOLKSWAGEN)

California T5							
1.9	TDI [7H]	1,9	62/75	BRR; BRS	01.06-11.09		0 414 720 363 0 986 441 568
			63/77	AXB; AXC	04.03-11.09		0 414 720 265 0 986 441 559
2.5	TDI, TDI 4Motion [7H]	2,5	96	AXD	02.03-11.09		0 414 720 260 0 986 441 561
				BNZ	01.06-11.09		0 414 720 360 0 986 441 579
			120/128	AXE; BLJ			
				Fg.-Nr. →7H..5H042 663 →7H..5X010 640	02.03-10.04		0 414 720 260 0 986 441 561
				Fg.-Nr. 7H..5H042 664 →7H..5X010 641→	11.04-11.09		0 414 720 278 0 986 441 573
			128	BPC	01.06-11.09		0 414 720 359 0 986 441 578
Caravelle T5							
1.9	TDI [7H]	1,9	62/75	BRR; BRS	01.06-11.09		0 414 720 363 0 986 441 568
			63/77	AXB; AXC	04.03-11.09		0 414 720 265 0 986 441 559
2.5	TDI, TDI 4Motion [7H]	2,5	96	AXD	02.03-11.09		0 414 720 260 0 986 441 561
				BNZ	01.06-11.09		0 414 720 360 0 986 441 579
			120/128	AXE; BLJ			
				Fg.-Nr. →7H..5H042 663 →7H..5X010 640	02.03-10.04		0 414 720 260 0 986 441 561
				Fg.-Nr. 7H..5H042 664 →7H..5X010 641→	11.04-11.09		0 414 720 278 0 986 441 573
			128	BPC	01.06-11.09		0 414 720 359 0 986 441 578
Multivan T5							
1.9	TDI [7H]	1,9	62/75	BRR; BRS	01.06-11.09		0 414 720 363 0 986 441 568
			63/77	AXB; AXC	04.03-11.09		0 414 720 265 0 986 441 559
2.5	TDI, TDI 4Motion [7H]	2,5	96	AXD	02.03-11.09		0 414 720 260 0 986 441 561
				BNZ	01.06-11.09		0 414 720 360 0 986 441 579
			120/128	AXE; BLJ			
				Fg.-Nr. →7H..5H042 663 →7H..5X010 640	02.03-10.04		0 414 720 260 0 986 441 561
				Fg.-Nr. 7H..5H042 664 →7H..5X010 641→	11.04-11.09		0 414 720 278 0 986 441 573
			128	BPC	01.06-11.09		0 414 720 359 0 986 441 578
Transporter T5							
1.9	TDI [7H]	1,9	62/75	BRR; BRS	01.06-11.09		0 414 720 363 0 986 441 568
			63/77	AXB; AXC	04.03-11.09		0 414 720 265 0 986 441 559
	TDI [7J]	1,9	62/75	BRR; BRS	06.06-11.09		0 414 720 363 0 986 441 568
			63/77	AXB; AXC	04.03-11.09		0 414 720 265 0 986 441 559
2.5	TDI, TDI 4Motion [7H]	2,5	96	AXD	02.03-11.09		0 414 720 260 0 986 441 561
				BNZ	01.06-11.09		0 414 720 360 0 986 441 579
			120/128	AXE; BLJ			
				Fg.-Nr. →7H..5H042 663 →7H..5X010 640	02.03-10.04		0 414 720 260 0 986 441 561
				Fg.-Nr. 7H..5H042 664 →7H..5X010 641→	11.04-11.09		0 414 720 278 0 986 441 573
			128	BPC	01.06-11.09		0 414 720 359 0 986 441 578
	TDI, TDI 4Motion [7J]	2,5	96	AXD	04.03-11.09		0 414 720 260 0 986 441 561
				BNZ	06.06-11.09		0 414 720 360 0 986 441 579
			128	AXE			
				Fg.-Nr. →7H..5H042 663 →7H..5X010 640	01.04-10.04		0 414 720 260 0 986 441 561
				Fg.-Nr. 7H..5H042 664 →7H..5X010 641→	11.04-11.09		0 414 720 278 0 986 441 573
				BPC	06.06-11.09		0 414 720 359 0 986 441 578





**CASE****Serie 300**

327B	10,3	235	F3AE	04.07-12.12	0 414 703 009	0 986 441 027
330B	10,3	260	F3AE	04.07-12.12	0 414 703 009	0 986 441 027
335B	12,9	306	F3BE3681A	04.07-12.12	0 414 703 009	0 986 441 027

**CASE IH (CASE INTERNATIONAL)****Serie A**

AF 8120	10,3	314	CURSOR 10	09.08-03.12	0 414 703 009	0 986 441 027
AF 9120	12,9	361	<Cursor 13>	09.08-03.12	0 414 703 009	0 986 441 027
<b>Serie Axial-Flow 240</b>						
AF 7230	8,7	330	F2CFE613F	01.13-09.14	0 414 703 008	0 986 441 026
AF 8230	12,7	380	F3BFE613A	01.13-09.14	0 414 703 008	0 986 441 026
AF 9230	12,7	420	F3BFE613A	01.13-09.14	0 414 703 008	0 986 441 026
<b>Steiger</b>						
385	12,9	283	F3BE0681G <Cursor 13>	08.07-12.11	0 414 703 009	0 986 441 027
435	12,9	320	F3BE0681G <Cursor 13>	08.07-12.11	0 414 703 009	0 986 441 027

**NEW HOLLAND****Serie CR**

8.80	10,3	360	CURSOR 10	12.14-12.17	0 414 703 008	0 986 441 026
8.90	10,3	360	CURSOR 10	12.14-12.17	0 414 703 008	0 986 441 026
9.80	12,9	380	Cursor 13 <Euro 5 / P-7>	12.14-12.17	0 414 703 009	0 986 441 027
<b>TJ</b>						
380	12,9	283	CURSOR 13	01.06-12.07	0 414 703 009	0 986 441 027
430	12,9	321	CURSOR 13	01.06-12.07	0 414 703 009	0 986 441 027
<b>T9</b>						
.450	12,7	328	F3BFA613C	02.11-12.14	0 414 703 008	0 986 441 026
	12,9	328	F3BFA613A	03.14-11.17	0 414 703 008	0 986 441 026
.505	12,7	369	F3BFE613B	02.11-12.14	0 414 703 008	0 986 441 026
	12,9	369	F3BFA613A	03.14-11.17	0 414 703 008	0 986 441 026
.560	12,7	410	F3BFE613A	02.11-12.14	0 414 703 008	0 986 441 026
	12,9	410	F3BFA613A	03.14-11.17	0 414 703 008	0 986 441 026
<b>T9000</b>						
9030	12,9	283	CURSOR 13	08.07-12.10	0 414 703 009	0 986 441 027
9040	12,9	321	CURSOR 13	08.07-12.10	0 414 703 009	0 986 441 027





**DAF**

<b>CF</b>							
<b>75</b> .250	9,2	183	PE 183 <Euro3>	12.99-06.02		<b>0 414 755 005</b>	<b>0 986 445 005</b>
				02.01-02.07	MEB	<b>0 414 755 008</b>	<b>0 986 445 013</b>
.290	9,2	212	PE 212 <Euro3>	11.99-02.02		<b>0 414 755 005</b>	<b>0 986 445 005</b>
.310	9,2	228	PE 228 <Euro3>	02.01-07.07	MEB	<b>0 414 755 008</b>	<b>0 986 445 013</b>
.320	9,2	235	PE 235 <Euro3>	01.99-01.02		<b>0 414 755 005</b>	<b>0 986 445 005</b>
.360	9,2	265	PE 265 <Euro3>	02.01-05.07		<b>0 414 755 008</b>	<b>0 986 445 013</b>
<b>85</b> .340, .380, .430	12,6	250/280/	XE 250 <Euro 3>; XE 280 <Euro 3>; XE 315 <Euro 3>	07.99-02.02		<b>0 414 755 005</b>	<b>0 986 445 005</b>
		315		01.01-01.08		<b>0 414 755 008</b>	<b>0 986 445 013</b>
.480	12,6	355	XE 355 <Euro 3>	10.01-10.07		<b>0 414 755 008</b>	<b>0 986 445 013</b>
<b>XF</b>							
<b>95</b> .380	12,6	280	XE 280 C <Euro 3>	04.98-04.03	TW	<b>0 414 755 005</b>	<b>0 986 445 005</b>
			XE 280 <Euro 3>	02.02-01.07		<b>0 414 755 008</b>	<b>0 986 445 013</b>
.430	12,6	315	XE 315 C <Euro 3>	01.99-08.03		<b>0 414 755 005</b>	<b>0 986 445 005</b>
.430, .460	12,6	315/335	XE 315 <Euro 3>; XE 335 <Euro 3>	01.02-12.07		<b>0 414 755 008</b>	<b>0 986 445 013</b>
.480	12,6	355	XE 355 C <Euro 3>	05.98-09.03	TW	<b>0 414 755 005</b>	<b>0 986 445 005</b>
						<b>0 414 755 008</b>	<b>0 986 445 013</b>
			XE 355 <Euro 3>	02.02-12.07		<b>0 414 755 008</b>	<b>0 986 445 013</b>
.530	12,6	390	XE 390 C <Euro 3>	11.99-09.03		<b>0 414 755 005</b>	<b>0 986 445 005</b>
				11.01-01.07		<b>0 414 755 008</b>	<b>0 986 445 013</b>

**KAVZ KURGAN**

<b>Serie 4000</b>							
<b>4239</b>	7,1	162	BF6M 1013-22E3 <Euro 3>	09.08→		<b>0 414 750 004</b>	

**LAZ**

<b>CityLAZ</b>							
<b>4.8</b>	4,8	140	BF4M 1013 FC <Euro 3>	01.08→		<b>0 414 750 004</b>	

**MAZ MINSK**

<b>Serie 100</b>							
<b>105</b>	6,4	205	OM 906 LA <Euro 3>			<b>0 414 799 008</b>	<b>F 00E 200 403</b>
			Komp.Nr. 505012/05 Komp.Nr. 505012/06	01.02→	TNK		<b>0 986 445 003</b>
<b>107</b>	6,4	205	OM 906 LA <Euro 3>			<b>0 414 799 008</b>	<b>F 00E 200 403</b>
			Komp.Nr. 505012/05 Komp.Nr. 505012/06	01.02→	TNK		<b>0 986 445 003</b>
<b>Serie 200</b>							
<b>203</b>	6,4	170/205	OM 906 LA <Euro 3>			<b>0 414 799 008</b>	<b>F 00E 200 403</b>
			Komp.Nr. 505012/05 Komp.Nr. 505012/06	01.02→	TNK		<b>0 986 445 003</b>

**MERCEDES-BENZ**

<b>Actros</b>							
<b>1831</b> , AK, L [SKN]	12,0	230	OM 541.920 <(501)LA Euro2>; OM 541.926 <(501)LA Euro2>				
			Komp.Nr. 505108/01/02	09.96-09.03	TNK	<b>0 414 799 025</b>	<b>0 986 445 102</b>
			Komp.Nr. 505108/05/06	09.96-09.03	TNK	<b>0 414 799 015</b>	<b>0 986 445 020</b>
AK [SKN]	11,9	230	OM 541.941 <(501)LA Euro3>				
			Komp.Nr. 505108/01	04.97-09.03	TNK	<b>0 414 799 025</b>	<b>0 986 445 102</b>
			Komp.Nr. 505108/05	04.97-09.03	TNK	<b>0 414 799 015</b>	<b>0 986 445 020</b>





◀ MERCEDES-BENZ

<b>1831 L</b> [SKN]	12,0	230	OM 541.940 <501 LA Euro3> Komp.Nr. 505108/01	09.96-09.03	TNK	<b>0 414 799 025</b>	<b>0 986 445 102</b>
			Komp.Nr. 505108/05	09.96-09.03	TNK	<b>0 414 799 015</b>	<b>0 986 445 020</b>
<b>1835 , AK</b> [SKN]	12,0	260	OM 541.942 <501 LA Euro3>; OM 541.943 <501 LA Euro3>				
			Komp.Nr. 505108/01	09.96-09.03	TNK	<b>0 414 799 025</b>	<b>0 986 445 102</b>
			Komp.Nr. 505108/05	09.96-09.03	TNK	<b>0 414 799 015</b>	<b>0 986 445 020</b>
<b>, AK, L</b> [SKN]	12,0	260	OM 541.922 <(501)LA Euro2>; OM 541.927 <501 LA Euro3>				
			Komp.Nr. 505108/01/02	09.96-09.03	TNK	<b>0 414 799 025</b>	<b>0 986 445 102</b>
			Komp.Nr. 505108/05/06	09.96-09.03	TNK	<b>0 414 799 015</b>	<b>0 986 445 020</b>
<b>1840</b> [SKN]	12,0	290	OM 541.944 <501 LA Euro3>				
			Komp.Nr. 505108/01	09.96-09.03	TNK	<b>0 414 799 025</b>	<b>0 986 445 102</b>
			Komp.Nr. 505108/05	09.96-09.03	TNK	<b>0 414 799 015</b>	<b>0 986 445 020</b>
<b>, AK, L</b> [SKN]	12,0	290	OM 541.923 <(501)LA Euro2>; OM 541.924 <(501)LA Euro 2>				
			Komp.Nr. 505108/01/02	09.96-09.03	TNK	<b>0 414 799 025</b>	<b>0 986 445 102</b>
			Komp.Nr. 505108/05/06	09.96-09.03	TNK	<b>0 414 799 015</b>	<b>0 986 445 020</b>
<b>AK</b> [SKN]	11,9	290	OM 541.945 <(501)LA Euro3>				
			Komp.Nr. 505108/01	09.96-09.03	TNK	<b>0 414 799 025</b>	<b>0 986 445 102</b>
			Komp.Nr. 505108/05	09.96-09.03	TNK	<b>0 414 799 015</b>	<b>0 986 445 020</b>
<b>1843</b> [SKN]	12,0	315	OM 541.946 <501 LA Euro3>				
			Komp.Nr. 505108/01	09.96-09.03	TNK	<b>0 414 799 025</b>	<b>0 986 445 102</b>
			Komp.Nr. 505108/05	09.96-09.03	TNK	<b>0 414 799 015</b>	<b>0 986 445 020</b>
<b>, L</b> [SKN]	12,0	315	OM 541.925 <(501)LA Euro2>				
			Komp.Nr. 505108/01	09.96-09.03	TNK	<b>0 414 799 025</b>	<b>0 986 445 102</b>
			Komp.Nr. 505108/05/06	09.96-09.03	TNK	<b>0 414 799 015</b>	<b>0 986 445 020</b>
<b>AK</b> [SKN]	12,0	315	OM 541.921 <(501)LA Euro2>				
			Komp.Nr. 505108/01/02	04.97-09.03	TNK	<b>0 414 799 025</b>	<b>0 986 445 102</b>
			Komp.Nr. 505108/05/06	04.97-09.03	TNK	<b>0 414 799 015</b>	<b>0 986 445 020</b>
<b>1848 , AK</b> [SKN]	15,9	350	OM 542.940 <502 LA Euro3>; OM 542.941 <502 LA Euro3>				
			Komp.Nr. 505108 /04	09.96-09.03	TNK	<b>0 414 799 026</b>	<b>0 986 445 016</b>
			Komp.Nr. 505108/01/02	09.96-09.03	TNK	<b>0 414 799 025</b>	<b>0 986 445 102</b>
			Komp.Nr. 505108/06	09.96-09.03	TNK	<b>0 414 799 015</b>	<b>0 986 445 020</b>
<b>, L</b> [SKN]	16,0	350	OM 542.921 <(502)LA Euro2>				
			Komp.Nr. 505108/01/02	09.96-09.03	TNK	<b>0 414 799 025</b>	<b>0 986 445 102</b>
<b>AK</b> [SKN]	16,0	350	OM 542.925 <(502)LA Euro2>	04.97-09.03		<b>0 414 799 025</b>	<b>0 986 445 102</b>
<b>1853 , AK</b> [SKN]	15,9	390	OM 542.942 <502 LA Euro3>; OM 542.943 <(502)LA Euro2>				
			Komp.Nr. 505108 /04	09.96-09.03	TNK	<b>0 414 799 026</b>	<b>0 986 445 016</b>
			Komp.Nr. 505108/01/02	09.96-09.03	TNK	<b>0 414 799 025</b>	<b>0 986 445 102</b>
			Komp.Nr. 505108/06	09.96-09.03	TNK	<b>0 414 799 015</b>	<b>0 986 445 020</b>
<b>, L</b> [SKN]	16,0	390	OM 542.920 <(502)LA Euro2>				
			Komp.Nr. 505108/01/02	09.96-09.03	TNK	<b>0 414 799 025</b>	<b>0 986 445 102</b>
<b>1857 L</b> [SKN]	15,9	420	OM 542.944 <502 LA Euro3>				
			Komp.Nr. 505108 /04	09.96-09.03	TNK	<b>0 414 799 026</b>	<b>0 986 445 016</b>
			Komp.Nr. 505108/01/02	09.96-09.03	TNK	<b>0 414 799 025</b>	<b>0 986 445 102</b>
			Komp.Nr. 505108/06	09.96-09.03	TNK	<b>0 414 799 015</b>	<b>0 986 445 020</b>
	16,0	420	OM 542.922 <(502)LA Euro2>				
			Komp.Nr. 505108/01/02	04.97-09.03	TNK	<b>0 414 799 025</b>	<b>0 986 445 102</b>
<b>2031</b> [SKN]	12,0	230	OM 541.940 <501 LA Euro3>				
			Komp.Nr. 505108/01	09.96-09.03	TNK	<b>0 414 799 025</b>	<b>0 986 445 102</b>
			Komp.Nr. 505108/05	09.96-09.03	TNK	<b>0 414 799 015</b>	<b>0 986 445 020</b>
<b>, A</b> [SKN]	12,0	230	OM 541.920 <(501)LA Euro2>; OM 541.926 <(501)LA Euro2>				
			Komp.Nr. 505108/01/02	09.96-09.03	TNK	<b>0 414 799 025</b>	<b>0 986 445 102</b>
			Komp.Nr. 505108/05/06	09.96-09.03	TNK	<b>0 414 799 015</b>	<b>0 986 445 020</b>
<b>AK,AS</b> [SKN]	11,9	230	OM 541.941 <(501)LA Euro3>				
			Komp.Nr. 505108/01	09.96-09.03	TNK	<b>0 414 799 025</b>	<b>0 986 445 102</b>
			Komp.Nr. 505108/05	09.96-09.03	TNK	<b>0 414 799 015</b>	<b>0 986 445 020</b>





<b>2035</b> [SKN]	12,0	260	OM 541.927 <501 LA Euro3>					
			Komp.Nr. 505108/01/02	04.97-09.03	TNK	<b>0 414 799 025</b>	<b>0 986 445 102</b>	
			Komp.Nr. 505108/05/06	04.97-09.03	TNK	<b>0 414 799 015</b>	<b>0 986 445 020</b>	
			OM 541.942 <501 LA Euro3>					
<b>2040</b> [SKN]	12,0	290	OM 541.944 <501 LA Euro3>					
			Komp.Nr. 505108/01	11.97-09.03	TNK	<b>0 414 799 025</b>	<b>0 986 445 102</b>	
			Komp.Nr. 505108/05	11.97-09.03	TNK	<b>0 414 799 015</b>	<b>0 986 445 020</b>	
			, A [SKN]	12,0	290	OM 541.923 <(501)LA Euro2>; OM 541.924 <(501)LA Euro 2>		
AK,AS [SKN]	11,9	290	OM 541.945 <(501)LA Euro3>					
			Komp.Nr. 505108/01	11.97-09.03	TNK	<b>0 414 799 025</b>	<b>0 986 445 102</b>	
			Komp.Nr. 505108/05	11.97-09.03	TNK	<b>0 414 799 015</b>	<b>0 986 445 020</b>	
			<b>2043 AS</b> [SKN]	11,9	315	OM 541.947 <(501)LA Euro3>		
Komp.Nr. 505108/01	09.98-09.03	TNK	<b>0 414 799 025</b>			<b>0 986 445 102</b>		
Komp.Nr. 505108/05	09.98-09.03	TNK	<b>0 414 799 015</b>			<b>0 986 445 020</b>		
	12,0	315	OM 541.921 <(501)LA Euro2>					
<b>2048 AS</b> [SKN]	15,9	350	OM 542.941 <502 LA Euro3>					
			Komp.Nr. 505108 /04	09.96-09.03	TNK	<b>0 414 799 026</b>	<b>0 986 445 016</b>	
			Komp.Nr. 505108/01/02	09.96-09.03	TNK	<b>0 414 799 025</b>	<b>0 986 445 102</b>	
			Komp.Nr. 505108/06	09.96-09.03	TNK	<b>0 414 799 015</b>	<b>0 986 445 020</b>	
	16,0	350	OM 542.925 <(502)LA Euro2>	09.96-09.03		<b>0 414 799 025</b>	<b>0 986 445 102</b>	
<b>2053</b> [SKN]	12,0	390	OM 542.920 <(501)LA Euro2>					
<b>2531</b> [SKN]	12,0	230	OM 541.940 <501 LA Euro3>					
			Komp.Nr. 505108/01	09.96-09.03	TNK	<b>0 414 799 025</b>	<b>0 986 445 102</b>	
			Komp.Nr. 505108/05	09.96-09.03	TNK	<b>0 414 799 015</b>	<b>0 986 445 020</b>	
			, L [SKN]	12,0	230	OM 541.920 <(501)LA Euro2>		
<b>2535</b> [SKN]	12,0	260	OM 541.942 <501 LA Euro3>					
			Komp.Nr. 505108/01	09.96-09.03	TNK	<b>0 414 799 025</b>	<b>0 986 445 102</b>	
			Komp.Nr. 505108/05	09.96-09.03	TNK	<b>0 414 799 015</b>	<b>0 986 445 020</b>	
			L [SKN]	12,0	260	OM 541.922 <(501)LA Euro2>		
<b>2540</b> [SKN]	12,0	290	OM 541.944 <501 LA Euro3>					
			Komp.Nr. 505108/01	09.96-09.03	TNK	<b>0 414 799 025</b>	<b>0 986 445 102</b>	
			Komp.Nr. 505108/05	09.96-09.03	TNK	<b>0 414 799 015</b>	<b>0 986 445 020</b>	
			, L [SKN]	12,0	290	OM 541.923 <(501)LA Euro2>		
<b>2543</b> [SKN]	12,0	315	OM 541.946 <501 LA Euro3>					
			Komp.Nr. 505108/01	09.96-09.03	TNK	<b>0 414 799 025</b>	<b>0 986 445 102</b>	
			Komp.Nr. 505108/05	09.96-09.03	TNK	<b>0 414 799 015</b>	<b>0 986 445 020</b>	
			, L [SKN]	12,0	315	OM 541.925 <(501)LA Euro2>		
<b>2548</b> [SKN]	15,9	350	OM 542.940 <502 LA Euro3>					
			Komp.Nr. 505108 /04	09.96-09.03	TNK	<b>0 414 799 026</b>	<b>0 986 445 016</b>	
			Komp.Nr. 505108/01/02	09.96-09.03	TNK	<b>0 414 799 025</b>	<b>0 986 445 102</b>	
			Komp.Nr. 505108/06	09.96-09.03	TNK	<b>0 414 799 015</b>	<b>0 986 445 020</b>	
	16,0	350	OM 542.921 <(502)LA Euro2>	09.96-09.03		<b>0 414 799 025</b>	<b>0 986 445 102</b>	
<b>2553</b> [SKN]	15,9	390	OM 542.942 <502 LA Euro3>					
			Komp.Nr. 505108 /04	09.96-09.03	TNK	<b>0 414 799 026</b>	<b>0 986 445 016</b>	
			Komp.Nr. 505108/01/02	09.96-09.03	TNK	<b>0 414 799 025</b>	<b>0 986 445 102</b>	
			Komp.Nr. 505108/06	09.96-09.03	TNK	<b>0 414 799 015</b>	<b>0 986 445 020</b>	





◀ MERCEDES-BENZ

<b>2553</b> , L [SKN]	16,0	390	OM 542.920 <(502)LA Euro2> Komp.Nr. 505108/01/02	09.96-09.03	TNK	<b>0 414 799 025</b>	<b>0 986 445 102</b>
<b>2557</b> L [SKN]	15,9	420	OM 542.944 <502 LA Euro3> Komp.Nr. 505108 /04 Komp.Nr. 505108/01/02 Komp.Nr. 505108/06	09.96-09.03 09.96-09.03 09.96-09.03	TNK TNK TNK	<b>0 414 799 026</b> <b>0 414 799 025</b> <b>0 414 799 015</b>	<b>0 986 445 016</b> <b>0 986 445 102</b> <b>0 986 445 020</b>
	16,0	420	OM 542.922 <(502)LA Euro2> Komp.Nr. 505108/01/02	04.97-09.03	TNK	<b>0 414 799 025</b>	<b>0 986 445 102</b>
<b>2631</b> [SKN]	12,0	230	OM 541.940 <501 LA Euro3> Komp.Nr. 505108/01 Komp.Nr. 505108/05	04.97-09.03 04.97-09.03	TNK TNK	<b>0 414 799 025</b> <b>0 414 799 015</b>	<b>0 986 445 102</b> <b>0 986 445 020</b>
, L [SKN]	12,0	230	OM 541.920 <(501)LA Euro2> Komp.Nr. 505108/01/02 Komp.Nr. 505108/05/06	04.97-09.03 04.97-09.03	TNK TNK	<b>0 414 799 025</b> <b>0 414 799 015</b>	<b>0 986 445 102</b> <b>0 986 445 020</b>
<b>2635</b> [SKN]	12,0	260	OM 541.942 <501 LA Euro3> Komp.Nr. 505108/01 Komp.Nr. 505108/05	04.97-09.03 04.97-09.03	TNK TNK	<b>0 414 799 025</b> <b>0 414 799 015</b>	<b>0 986 445 102</b> <b>0 986 445 020</b>
, L [SKN]	12,0	260	OM 541.922 <(501)LA Euro2> Komp.Nr. 505108/01/02 Komp.Nr. 505108/05/06	04.97-09.03 04.97-09.03	TNK TNK	<b>0 414 799 025</b> <b>0 414 799 015</b>	<b>0 986 445 102</b> <b>0 986 445 020</b>
<b>2640</b> [SKN]	12,0	290	OM 541.944 <501 LA Euro3> Komp.Nr. 505108/01 Komp.Nr. 505108/05	09.96-09.03 09.96-09.03	TNK TNK	<b>0 414 799 025</b> <b>0 414 799 015</b>	<b>0 986 445 102</b> <b>0 986 445 020</b>
, L [SKN]	12,0	290	OM 541.923 <(501)LA Euro2> Komp.Nr. 505108/01/02 Komp.Nr. 505108/05/06	09.96-09.03 09.96-09.03	TNK TNK	<b>0 414 799 025</b> <b>0 414 799 015</b>	<b>0 986 445 102</b> <b>0 986 445 020</b>
<b>2643</b> [SKN]	12,0	315	OM 541.946 <501 LA Euro3> Komp.Nr. 505108/01 Komp.Nr. 505108/05	09.96-09.03 09.96-09.03	TNK TNK	<b>0 414 799 025</b> <b>0 414 799 015</b>	<b>0 986 445 102</b> <b>0 986 445 020</b>
, L [SKN]	12,0	315	OM 541.925 <(501)LA Euro2> Komp.Nr. 505108/01 Komp.Nr. 505108/05/06	09.96-09.03 09.96-09.03	TNK TNK	<b>0 414 799 025</b> <b>0 414 799 015</b>	<b>0 986 445 102</b> <b>0 986 445 020</b>
<b>2648</b> [SKN]	15,9	350	OM 542.940 <502 LA Euro3> Komp.Nr. 505108 /04 Komp.Nr. 505108/01/02 Komp.Nr. 505108/06	09.96-09.03 09.96-09.03 09.96-09.03	TNK TNK TNK	<b>0 414 799 026</b> <b>0 414 799 025</b> <b>0 414 799 015</b>	<b>0 986 445 016</b> <b>0 986 445 102</b> <b>0 986 445 020</b>
, L [SKN]	16,0	350	OM 542.921 <(502)LA Euro2> Komp.Nr. 505108/01/02	09.96-09.03	TNK	<b>0 414 799 025</b>	<b>0 986 445 102</b>
<b>2653</b> [SKN]	15,9	390	OM 542.942 <502 LA Euro3> Komp.Nr. 505108 /04 Komp.Nr. 505108/01/02 Komp.Nr. 505108/06	09.96-09.03 09.96-09.03 09.96-09.03	TNK TNK TNK	<b>0 414 799 026</b> <b>0 414 799 025</b> <b>0 414 799 015</b>	<b>0 986 445 016</b> <b>0 986 445 102</b> <b>0 986 445 020</b>
, L [SKN]	16,0	390	OM 542.920 <(502)LA Euro2> Komp.Nr. 505108/01/02	09.96-09.03	TNK	<b>0 414 799 025</b>	<b>0 986 445 102</b>
<b>2657</b> [SKN]	15,9	420	OM 542.944 <502 LA Euro3> Komp.Nr. 505108 /04 Komp.Nr. 505108/01/02 Komp.Nr. 505108/06	09.96-09.03 09.96-09.03 09.96-09.03	TNK TNK TNK	<b>0 414 799 026</b> <b>0 414 799 025</b> <b>0 414 799 015</b>	<b>0 986 445 016</b> <b>0 986 445 102</b> <b>0 986 445 020</b>
, L [SKN]	16,0	420	OM 542.922 <(502)LA Euro2> Komp.Nr. 505108/01/02	04.97-09.03	TNK	<b>0 414 799 025</b>	<b>0 986 445 102</b>
<b>3231</b> [SKN]	12,0	230	OM 541.920 <(501)LA Euro2> Komp.Nr. 505108/01/02 Komp.Nr. 505108/05/06	04.97-09.03 04.97-09.03	TNK TNK	<b>0 414 799 025</b> <b>0 414 799 015</b>	<b>0 986 445 102</b> <b>0 986 445 020</b>
<b>3235</b> [SKN]	12,0	260	OM 541.922 <(501)LA Euro2> Komp.Nr. 505108/01/02 Komp.Nr. 505108/05/06	04.97-09.03 04.97-09.03	TNK TNK	<b>0 414 799 025</b> <b>0 414 799 015</b>	<b>0 986 445 102</b> <b>0 986 445 020</b>
<b>3240</b> [SKN]	12,0	290	OM 541.923 <(501)LA Euro2> Komp.Nr. 505108/01/02 Komp.Nr. 505108/05/06	04.97-09.03 04.97-09.03	TNK TNK	<b>0 414 799 025</b> <b>0 414 799 015</b>	<b>0 986 445 102</b> <b>0 986 445 020</b>
<b>3243</b> [SKN]	12,0	315	OM 541.925 <(501)LA Euro2> Komp.Nr. 505108/01 Komp.Nr. 505108/05/06	04.97-09.03 04.97-09.03	TNK TNK	<b>0 414 799 025</b> <b>0 414 799 015</b>	<b>0 986 445 102</b> <b>0 986 445 020</b>





<b>3331</b> , A [SKN]	12,0	230	OM 541.920 <(501)LA Euro2>; OM 541.926 <(501)LA Euro2>					
			Komp.Nr. 505108/01/02	04.97-09.03	TNK	<b>0 414 799 025</b>	<b>0 986 445 102</b>	
			Komp.Nr. 505108/05/06	04.97-09.03	TNK	<b>0 414 799 015</b>	<b>0 986 445 020</b>	
<b>3335</b> [SKN]	12,0	260	OM 541.922 <(501)LA Euro2>					
			Komp.Nr. 505108/01/02	04.97-09.03	TNK	<b>0 414 799 025</b>	<b>0 986 445 102</b>	
			Komp.Nr. 505108/05/06	04.97-09.03	TNK	<b>0 414 799 015</b>	<b>0 986 445 020</b>	
<b>3340</b> , A [SKN]	12,0	290	OM 541.923 <(501)LA Euro2>; OM 541.924 <(501)LA Euro 2>					
			Komp.Nr. 505108/01/02	04.97-09.03	TNK	<b>0 414 799 025</b>	<b>0 986 445 102</b>	
			Komp.Nr. 505108/05/06	04.97-09.03	TNK	<b>0 414 799 015</b>	<b>0 986 445 020</b>	
<b>3343</b> [SKN]	12,0	315	OM 541.925 <(501)LA Euro2>					
			Komp.Nr. 505108/01	04.97-09.03	TNK	<b>0 414 799 025</b>	<b>0 986 445 102</b>	
			Komp.Nr. 505108/05/06	04.97-09.03	TNK	<b>0 414 799 015</b>	<b>0 986 445 020</b>	
A [SKN]	12,0	315	OM 541.921 <(501)LA Euro2>					
			Komp.Nr. 505108/01/02	04.97-09.03	TNK	<b>0 414 799 025</b>	<b>0 986 445 102</b>	
			Komp.Nr. 505108/05/06	04.97-09.03	TNK	<b>0 414 799 015</b>	<b>0 986 445 020</b>	
<b>3348</b> [SKN]	16,0	350	OM 542.921 <(502)LA Euro2>					
			Komp.Nr. 505108/01/02	04.97-09.03	TNK	<b>0 414 799 025</b>	<b>0 986 445 102</b>	
A [SKN]	16,0	350	OM 542.925 <(502)LA Euro2>	04.97-09.03		<b>0 414 799 025</b>	<b>0 986 445 102</b>	
<b>3353</b> [SKN]	16,0	390	OM 542... <(502)LA>					
			Mot.-Typ 542.920	09.96-09.03	TW	<b>0 414 799 025</b>	<b>0 986 445 102</b>	
			Mot.-Typ 542.926					
			Mot.-Typ 542.943					
			Mot.-Typ 542.926	09.96-09.03	TW	<b>0 414 799 015</b>	<b>0 986 445 020</b>	
			Mot.-Typ 542.943					
			Mot.-Typ 542.943	09.96-09.03	TW	<b>0 414 799 026</b>	<b>0 986 445 016</b>	
<b>3357</b> [SKN]	16,0	420	OM 542.922 <(502)LA Euro2>					
			Komp.Nr. 505108/01/02	04.97-09.03	TNK	<b>0 414 799 025</b>	<b>0 986 445 102</b>	
<b>4140</b> , A [SKN]	12,0	290	OM 541.923 <(501)LA Euro2>; OM 541.924 <(501)LA Euro 2>					
			Komp.Nr. 505108/01/02	04.97-09.03	TNK	<b>0 414 799 025</b>	<b>0 986 445 102</b>	
			Komp.Nr. 505108/05/06	04.97-09.03	TNK	<b>0 414 799 015</b>	<b>0 986 445 020</b>	
<b>4143</b> [SKN]	12,0	315	OM 541.925 <(501)LA Euro2>					
			Komp.Nr. 505108/01	04.97-09.03	TNK	<b>0 414 799 025</b>	<b>0 986 445 102</b>	
			Komp.Nr. 505108/05/06	04.97-09.03	TNK	<b>0 414 799 015</b>	<b>0 986 445 020</b>	
A [SKN]	12,0	315	OM 541.921 <(501)LA Euro2>					
			Komp.Nr. 505108/01/02	04.97-09.03	TNK	<b>0 414 799 025</b>	<b>0 986 445 102</b>	
			Komp.Nr. 505108/05/06	04.97-09.03	TNK	<b>0 414 799 015</b>	<b>0 986 445 020</b>	
<b>4148</b> [SKN]	16,0	350	OM 542.921 <(502)LA Euro2>					
			Komp.Nr. 505108/01/02	04.97-09.03	TNK	<b>0 414 799 025</b>	<b>0 986 445 102</b>	
			OM 542.925 <(502)LA Euro2>	04.97-09.03		<b>0 414 799 025</b>	<b>0 986 445 102</b>	
<b>Actros II</b>								
<b>1832</b> [MP2]	12,0	235	OM 541.940 <501 LA Euro3>					
			Komp.Nr. 505108/01	04.03-12.08	TNK	<b>0 414 799 025</b>	<b>0 986 445 102</b>	
			Komp.Nr. 505108/05	04.03-12.08	TNK	<b>0 414 799 015</b>	<b>0 986 445 020</b>	
BlueTec [MP2]	12,0	235	OM 541.970 <501 LA Euro4/5>					
			Komp.Nr. 505108 /01	02.05-12.08	TNK	<b>0 414 799 025</b>	<b>0 986 445 102</b>	
			Komp.Nr. 505108/05	02.05-12.08	TNK	<b>0 414 799 015</b>	<b>0 986 445 020</b>	
<b>1836</b> [MP2]	12,0	265	OM 541.942 <501 LA Euro3>					
			Komp.Nr. 505108/01	04.03-12.08	TNK	<b>0 414 799 025</b>	<b>0 986 445 102</b>	
			Komp.Nr. 505108/05	04.03-12.08	TNK	<b>0 414 799 015</b>	<b>0 986 445 020</b>	
BlueTec [MP2]	11,9	265	OM 541.972 <501 LA Euro4/5>					
			Komp.Nr. 505108 /01	02.05-12.08	TNK	<b>0 414 799 025</b>	<b>0 986 445 102</b>	
			Komp.Nr. 505108/05	02.05-12.08	TNK	<b>0 414 799 015</b>	<b>0 986 445 020</b>	
<b>1841</b> [MP2]	12,0	300	OM 541.944 <501 LA Euro3>					
			Komp.Nr. 505108/01	04.03-12.08	TNK	<b>0 414 799 025</b>	<b>0 986 445 102</b>	
			Komp.Nr. 505108/05	04.03-12.08	TNK	<b>0 414 799 015</b>	<b>0 986 445 020</b>	
BlueTec [MP2]	12,0	300	OM 541.974 <501 LA Euro4/5>					
			Komp.Nr. 505108 /01	02.05-12.08	TNK	<b>0 414 799 025</b>	<b>0 986 445 102</b>	
			Komp.Nr. 505108/05	02.05-12.08	TNK	<b>0 414 799 015</b>	<b>0 986 445 020</b>	







◀ MERCEDES-BENZ

<b>1844</b> [MP2]	12,0	320	OM 541.946 <501 LA Euro3> Komp.Nr. 505108/01	04.03-12.08	TNK	<b>0 414 799 025</b>	<b>0 986 445 102</b>
			Komp.Nr. 505108/05	04.03-12.08	TNK	<b>0 414 799 015</b>	<b>0 986 445 020</b>
BlueTec [MP2]	12,0	320	OM 541.976 <501 LA Euro4/5> Komp.Nr. 505108/01	02.05-12.08	TNK	<b>0 414 799 025</b>	<b>0 986 445 102</b>
			Komp.Nr. 505108/05	02.05-12.08	TNK	<b>0 414 799 015</b>	<b>0 986 445 020</b>
<b>1846</b> [MP2]	12,0	335	OM 541... <501 LA Euro3> Komp.Nr. 505108/01	04.03-12.08	TNK	<b>0 414 799 025</b>	<b>0 986 445 102</b>
			Komp.Nr. 505108/05	04.03-12.08	TNK	<b>0 414 799 015</b>	<b>0 986 445 020</b>
BlueTec [MP2]	12,0	335	OM 541.980 <501 LA Euro4/5> Komp.Nr. 505108/01	02.05-12.08	TNK	<b>0 414 799 025</b>	<b>0 986 445 102</b>
			Komp.Nr. 505108/05	02.05-12.08	TNK	<b>0 414 799 015</b>	<b>0 986 445 020</b>
<b>1848</b> BlueTec [MP2]	12,0	350	OM 541.978 <501 LA Euro4/5> Komp.Nr. 505108/01	02.05-12.08	TNK	<b>0 414 799 025</b>	<b>0 986 445 102</b>
			Komp.Nr. 505108/05	02.05-12.08	TNK	<b>0 414 799 015</b>	<b>0 986 445 020</b>
<b>1850</b> [MP2]	15,9	370	OM 542.940 <502 LA Euro3> Komp.Nr. 505108/04	04.03-12.08	TNK	<b>0 414 799 026</b>	<b>0 986 445 016</b>
			Komp.Nr. 505108/01/02	04.03-12.08	TNK	<b>0 414 799 025</b>	<b>0 986 445 102</b>
			Komp.Nr. 505108/06	04.03-12.08	TNK	<b>0 414 799 015</b>	<b>0 986 445 020</b>
<b>1851</b> BlueTec [MP2]	15,9	375	OM 542.960 <502 LA Euro4/5> Komp.Nr. 505108/02	02.05-12.08	TNK	<b>0 414 799 025</b>	<b>0 986 445 102</b>
			Komp.Nr. 505108/06	02.05-12.08	TNK	<b>0 414 799 015</b>	<b>0 986 445 020</b>
<b>1854</b> [MP2]	15,9	395	OM 542.942 <502 LA Euro3> Komp.Nr. 505108/04	04.03-12.08	TNK	<b>0 414 799 026</b>	<b>0 986 445 016</b>
			Komp.Nr. 505108/01/02	04.03-12.08	TNK	<b>0 414 799 025</b>	<b>0 986 445 102</b>
			Komp.Nr. 505108/06	04.03-12.08	TNK	<b>0 414 799 015</b>	<b>0 986 445 020</b>
<b>1855</b> BlueTec [MP2]	15,9	405	OM 542.962 <502 LA Euro4/5> Komp.Nr. 505108/02	07.05-12.08	TNK	<b>0 414 799 025</b>	<b>0 986 445 102</b>
			Komp.Nr. 505108/06	07.05-12.08	TNK	<b>0 414 799 015</b>	<b>0 986 445 020</b>
<b>1858</b> [MP2]	15,9	425	OM 542.944 <502 LA Euro3> Komp.Nr. 505108/04	04.03-12.08	TNK	<b>0 414 799 026</b>	<b>0 986 445 016</b>
			Komp.Nr. 505108/01/02	04.03-12.08	TNK	<b>0 414 799 025</b>	<b>0 986 445 102</b>
			Komp.Nr. 505108/06	04.03-12.08	TNK	<b>0 414 799 015</b>	<b>0 986 445 020</b>
<b>1860</b> BlueTec [MP2]	15,9	440	OM 542.964 <502 LA Euro4/5> Komp.Nr. 505108/02	07.05-12.08	TNK	<b>0 414 799 025</b>	<b>0 986 445 102</b>
			Komp.Nr. 505108/06	07.05-12.08	TNK	<b>0 414 799 015</b>	<b>0 986 445 020</b>
<b>1861</b> Black Edition [MP2]	15,9	450	OM 542.958 <502 LA Euro3> Komp.Nr. 505108/01/02	09.04-12.08	TNK	<b>0 414 799 025</b>	<b>0 986 445 102</b>
			Komp.Nr. 505108/06	09.04-12.08	TNK	<b>0 414 799 015</b>	<b>0 986 445 020</b>
<b>2032</b> [MP2]	12,0	235	OM 541.940,941 <501 LA Euro3> Komp.Nr. 505108/01	04.03-12.08	TNK	<b>0 414 799 025</b>	<b>0 986 445 102</b>
			Komp.Nr. 505108/05/06	04.03-12.08	TNK	<b>0 414 799 015</b>	<b>0 986 445 020</b>
BlueTec [MP2]	12,0	235	OM 541.970 <501 LA Euro4/5> Komp.Nr. 505108/01	02.05-12.08	TNK	<b>0 414 799 025</b>	<b>0 986 445 102</b>
			Komp.Nr. 505108/05	02.05-12.08	TNK	<b>0 414 799 015</b>	<b>0 986 445 020</b>
<b>2036</b> [MP2]	12,0	265	OM 541... <501 LA Euro3> Komp.Nr. 505108/01	04.03-12.08	TNK	<b>0 414 799 025</b>	<b>0 986 445 102</b>
			Komp.Nr. 505108/05	04.03-12.08	TNK	<b>0 414 799 015</b>	<b>0 986 445 020</b>
BlueTec [MP2]	11,9	265	OM 541.972 <501 LA Euro4/5> Komp.Nr. 505108/01	02.05-12.08	TNK	<b>0 414 799 025</b>	<b>0 986 445 102</b>
			Komp.Nr. 505108/05	02.05-12.08	TNK	<b>0 414 799 015</b>	<b>0 986 445 020</b>
<b>2041</b> [MP2]	12,0	300	OM 541.944 <501 LA Euro3> Komp.Nr. 505108/01	04.03-12.08	TNK	<b>0 414 799 025</b>	<b>0 986 445 102</b>
			Komp.Nr. 505108/05	04.03-12.08	TNK	<b>0 414 799 015</b>	<b>0 986 445 020</b>
BlueTec [MP2]	12,0	300	OM 541.974 <501 LA Euro4/5> Komp.Nr. 505108/01	02.05-12.08	TNK	<b>0 414 799 025</b>	<b>0 986 445 102</b>
			Komp.Nr. 505108/05	02.05-12.08	TNK	<b>0 414 799 015</b>	<b>0 986 445 020</b>
<b>2044</b> [MP2]	12,0	320	OM 541... <501 LA Euro3> Komp.Nr. 505108/01	04.03-12.08	TNK	<b>0 414 799 025</b>	<b>0 986 445 102</b>
			Komp.Nr. 505108/05	04.03-12.08	TNK	<b>0 414 799 015</b>	<b>0 986 445 020</b>
BlueTec [MP2]	12,0	320	OM 541.976 <501 LA Euro4/5> Komp.Nr. 505108/01	02.05-12.08	TNK	<b>0 414 799 025</b>	<b>0 986 445 102</b>
			Komp.Nr. 505108/05	02.05-12.08	TNK	<b>0 414 799 015</b>	<b>0 986 445 020</b>





<b>2046</b> [MP2]	12,0	335	OM 541... <501 LA Euro3>					
			Komp.Nr. 505108/01	04.03-12.08	TNK	<b>0 414 799 025</b>	<b>0 986 445 102</b>	
			Komp.Nr. 505108/05	04.03-12.08	TNK	<b>0 414 799 015</b>	<b>0 986 445 020</b>	
BlueTec [MP2]	12,0	335	OM 541.980 <501 LA Euro4/5>					
			Komp.Nr. 505108/01	02.05-12.08	TNK	<b>0 414 799 025</b>	<b>0 986 445 102</b>	
			Komp.Nr. 505108/05	02.05-12.08	TNK	<b>0 414 799 015</b>	<b>0 986 445 020</b>	
<b>2048</b> BlueTec [MP2]	12,0	350	OM 541.978 <501 LA Euro4/5>					
			Komp.Nr. 505108/01	02.05-12.08	TNK	<b>0 414 799 025</b>	<b>0 986 445 102</b>	
			Komp.Nr. 505108/05	02.05-12.08	TNK	<b>0 414 799 015</b>	<b>0 986 445 020</b>	
<b>2050</b> [MP2]	15,9	370	OM 542.940 <502 LA Euro3>					
			Komp.Nr. 505108/04	04.03-12.08	TNK	<b>0 414 799 026</b>	<b>0 986 445 016</b>	
			Komp.Nr. 505108/01/02	04.03-12.08	TNK	<b>0 414 799 025</b>	<b>0 986 445 102</b>	
			Komp.Nr. 505108/06	04.03-12.08	TNK	<b>0 414 799 015</b>	<b>0 986 445 020</b>	
<b>2051</b> BlueTec [MP2]	15,9	375	OM 542.960 <502 LA Euro4/5>					
			Komp.Nr. 505108/02	09.05-12.08	TNK	<b>0 414 799 025</b>	<b>0 986 445 102</b>	
			Komp.Nr. 505108/06	09.05-12.08	TNK	<b>0 414 799 015</b>	<b>0 986 445 020</b>	
<b>2054</b> [MP2]	15,9	395	OM 542.942 <502 LA Euro3>					
			Komp.Nr. 505108/04	04.03-12.08	TNK	<b>0 414 799 026</b>	<b>0 986 445 016</b>	
			Komp.Nr. 505108/01/02	04.03-12.08	TNK	<b>0 414 799 025</b>	<b>0 986 445 102</b>	
			Komp.Nr. 505108/06	04.03-12.08	TNK	<b>0 414 799 015</b>	<b>0 986 445 020</b>	
<b>2055</b> BlueTec [MP2]	15,9	405	OM 542.962 <502 LA Euro4/5>					
			Komp.Nr. 505108/02	07.05-12.08	TNK	<b>0 414 799 025</b>	<b>0 986 445 102</b>	
			Komp.Nr. 505108/06	07.05-12.08	TNK	<b>0 414 799 015</b>	<b>0 986 445 020</b>	
<b>2532</b> [MP2]	12,0	235	OM 541.940 <501 LA Euro3>					
			Komp.Nr. 505108/01	04.03-12.08	TNK	<b>0 414 799 025</b>	<b>0 986 445 102</b>	
			Komp.Nr. 505108/05/06	04.03-12.08	TNK	<b>0 414 799 015</b>	<b>0 986 445 020</b>	
BlueTec [MP2]	12,0	235	OM 541.970 <501 LA Euro4/5>					
			Komp.Nr. 505108/01	02.05-12.08	TNK	<b>0 414 799 025</b>	<b>0 986 445 102</b>	
			Komp.Nr. 505108/05	02.05-12.08	TNK	<b>0 414 799 015</b>	<b>0 986 445 020</b>	
<b>2536</b> [MP2]	12,0	265	OM 541.942 <501 LA Euro3>					
			Komp.Nr. 505108/01	04.03-12.08	TNK	<b>0 414 799 025</b>	<b>0 986 445 102</b>	
			Komp.Nr. 505108/05	04.03-12.08	TNK	<b>0 414 799 015</b>	<b>0 986 445 020</b>	
BlueTec [MP2]	11,9	265	OM 541.972 <501 LA Euro4/5>					
			Komp.Nr. 505108/01	02.05-12.08	TNK	<b>0 414 799 025</b>	<b>0 986 445 102</b>	
			Komp.Nr. 505108/05	02.05-12.08	TNK	<b>0 414 799 015</b>	<b>0 986 445 020</b>	
<b>2541</b> [MP2]	12,0	300	OM 541.944 <501 LA Euro3>					
			Komp.Nr. 505108/01	04.03-12.08	TNK	<b>0 414 799 025</b>	<b>0 986 445 102</b>	
			Komp.Nr. 505108/05	04.03-12.08	TNK	<b>0 414 799 015</b>	<b>0 986 445 020</b>	
BlueTec [MP2]	12,0	300	OM 541.974 <501 LA Euro4/5>					
			Komp.Nr. 505108/01	02.05-12.08	TNK	<b>0 414 799 025</b>	<b>0 986 445 102</b>	
			Komp.Nr. 505108/05	02.05-12.08	TNK	<b>0 414 799 015</b>	<b>0 986 445 020</b>	
<b>2544</b> [MP2]	12,0	320	OM 541.946 <501 LA Euro3>					
			Komp.Nr. 505108/01	04.03-12.08	TNK	<b>0 414 799 025</b>	<b>0 986 445 102</b>	
			Komp.Nr. 505108/05	04.03-12.08	TNK	<b>0 414 799 015</b>	<b>0 986 445 020</b>	
BlueTec [MP2]	12,0	320	OM 541.976 <501 LA Euro4/5>					
			Komp.Nr. 505108/01	02.05-12.08	TNK	<b>0 414 799 025</b>	<b>0 986 445 102</b>	
			Komp.Nr. 505108/05	02.05-12.08	TNK	<b>0 414 799 015</b>	<b>0 986 445 020</b>	
<b>2546</b> [MP2]	12,0	335	OM 541.948 <501 LA Euro3>					
			Komp.Nr. 505108/01	04.03-12.08	TNK	<b>0 414 799 025</b>	<b>0 986 445 102</b>	
			Komp.Nr. 505108/05	04.03-12.08	TNK	<b>0 414 799 015</b>	<b>0 986 445 020</b>	
BlueTec [MP2]	12,0	335	OM 541.980 <501 LA Euro4/5>					
			Komp.Nr. 505108/01	02.05-12.08	TNK	<b>0 414 799 025</b>	<b>0 986 445 102</b>	
			Komp.Nr. 505108/05	02.05-12.08	TNK	<b>0 414 799 015</b>	<b>0 986 445 020</b>	
<b>2548</b> BlueTec [MP2]	12,0	350	OM 541.978 <501 LA Euro4/5>					
			Komp.Nr. 505108/01	02.05-12.08	TNK	<b>0 414 799 025</b>	<b>0 986 445 102</b>	
			Komp.Nr. 505108/05	02.05-12.08	TNK	<b>0 414 799 015</b>	<b>0 986 445 020</b>	
<b>2550</b> [MP2]	15,9	370	OM 542.940 <502 LA Euro3>					
			Komp.Nr. 505108/04	04.03-12.08	TNK	<b>0 414 799 026</b>	<b>0 986 445 016</b>	
			Komp.Nr. 505108/01/02	04.03-12.08	TNK	<b>0 414 799 025</b>	<b>0 986 445 102</b>	
			Komp.Nr. 505108/06	04.03-12.08	TNK	<b>0 414 799 015</b>	<b>0 986 445 020</b>	
<b>2551</b> BlueTec [MP2]	15,9	375	OM 542.960 <502 LA Euro4/5>					
			Komp.Nr. 505108/02	02.05-12.08	TNK	<b>0 414 799 025</b>	<b>0 986 445 102</b>	
			Komp.Nr. 505108/06	02.05-12.08	TNK	<b>0 414 799 015</b>	<b>0 986 445 020</b>	





◀ MERCEDES-BENZ

<b>2554</b> [MP2]	15,9	395	OM 542.942 <502 LA Euro3>					
			Komp.Nr. 505108 /04	04.03-12.08	TNK	<b>0 414 799 026</b>	<b>0 986 445 016</b>	
			Komp.Nr. 505108/01/02	04.03-12.08	TNK	<b>0 414 799 025</b>	<b>0 986 445 102</b>	
			Komp.Nr. 505108/06	04.03-12.08	TNK	<b>0 414 799 015</b>	<b>0 986 445 020</b>	
<b>2555</b> BlueTec [MP2]	15,9	405	OM 542.962 <502 LA Euro4/5>					
			Komp.Nr. 505108/02	07.05-12.08	TNK	<b>0 414 799 025</b>	<b>0 986 445 102</b>	
			Komp.Nr. 505108/06	07.05-12.08	TNK	<b>0 414 799 015</b>	<b>0 986 445 020</b>	
<b>2558</b> [MP2]	15,9	425	OM 542.944 <502 LA Euro3>					
			Komp.Nr. 505108 /04	04.03-12.08	TNK	<b>0 414 799 026</b>	<b>0 986 445 016</b>	
			Komp.Nr. 505108/01/02	04.03-12.08	TNK	<b>0 414 799 025</b>	<b>0 986 445 102</b>	
			Komp.Nr. 505108/06	04.03-12.08	TNK	<b>0 414 799 015</b>	<b>0 986 445 020</b>	
<b>2560</b> BlueTec [MP2]	15,9	440	OM 542.964 <502 LA Euro4/5>					
			Komp.Nr. 505108 /02	07.05-12.08	TNK	<b>0 414 799 025</b>	<b>0 986 445 102</b>	
			Komp.Nr. 505108/06	07.05-12.08	TNK	<b>0 414 799 015</b>	<b>0 986 445 020</b>	
<b>2632</b> [MP2]	12,0	235	OM 541.940 <501 LA Euro3>					
			Komp.Nr. 505108/01	04.03-12.08	TNK	<b>0 414 799 025</b>	<b>0 986 445 102</b>	
			Komp.Nr. 505108/05/06	04.03-12.08	TNK	<b>0 414 799 015</b>	<b>0 986 445 020</b>	
BlueTec [MP2]	12,0	235	OM 541.970 <501 LA Euro4/5>					
			Komp.Nr. 505108 /01	09.05-12.08	TNK	<b>0 414 799 025</b>	<b>0 986 445 102</b>	
			Komp.Nr. 505108/05	09.05-12.08	TNK	<b>0 414 799 015</b>	<b>0 986 445 020</b>	
<b>2636</b> [MP2]	12,0	265	OM 541.942 <501 LA Euro3>					
			Komp.Nr. 505108/01	04.03-12.08	TNK	<b>0 414 799 025</b>	<b>0 986 445 102</b>	
			Komp.Nr. 505108/05	04.03-12.08	TNK	<b>0 414 799 015</b>	<b>0 986 445 020</b>	
BlueTec [MP2]	11,9	265	OM 541.972 <501 LA Euro4/5>					
			Komp.Nr. 505108 /01	09.05-12.08	TNK	<b>0 414 799 025</b>	<b>0 986 445 102</b>	
			Komp.Nr. 505108/05	09.05-12.08	TNK	<b>0 414 799 015</b>	<b>0 986 445 020</b>	
<b>2641</b> [MP2]	12,0	300	OM 541.944 <501 LA Euro3>					
			Komp.Nr. 505108/01	06.03-12.08	TNK	<b>0 414 799 025</b>	<b>0 986 445 102</b>	
			Komp.Nr. 505108/05	06.03-12.08	TNK	<b>0 414 799 015</b>	<b>0 986 445 020</b>	
BlueTec [MP2]	12,0	300	OM 541.974 <501 LA Euro4/5>					
			Komp.Nr. 505108 /01	09.05-12.08	TNK	<b>0 414 799 025</b>	<b>0 986 445 102</b>	
			Komp.Nr. 505108/05	09.05-12.08	TNK	<b>0 414 799 015</b>	<b>0 986 445 020</b>	
<b>2644</b> [MP2]	12,0	320	OM 541.946 <501 LA Euro3>					
			Komp.Nr. 505108/01	06.03-12.08	TNK	<b>0 414 799 025</b>	<b>0 986 445 102</b>	
			Komp.Nr. 505108/05	06.03-12.08	TNK	<b>0 414 799 015</b>	<b>0 986 445 020</b>	
BlueTec [MP2]	12,0	320	OM 541.976 <501 LA Euro4/5>					
			Komp.Nr. 505108 /01	09.05-12.08	TNK	<b>0 414 799 025</b>	<b>0 986 445 102</b>	
			Komp.Nr. 505108/05	09.05-12.08	TNK	<b>0 414 799 015</b>	<b>0 986 445 020</b>	
<b>2646</b> [MP2]	12,0	335	OM 541.948 <501 LA Euro3>					
			Komp.Nr. 505108/01	06.03-12.08	TNK	<b>0 414 799 025</b>	<b>0 986 445 102</b>	
			Komp.Nr. 505108/05	06.03-12.08	TNK	<b>0 414 799 015</b>	<b>0 986 445 020</b>	
BlueTec [MP2]	12,0	335	OM 541.980 <501 LA Euro4/5>					
			Komp.Nr. 505108 /01	09.05-12.08	TNK	<b>0 414 799 025</b>	<b>0 986 445 102</b>	
			Komp.Nr. 505108/05	09.05-12.08	TNK	<b>0 414 799 015</b>	<b>0 986 445 020</b>	
<b>2648</b> BlueTec [MP2]	12,0	350	OM 541.978 <501 LA Euro4/5>					
			Komp.Nr. 505108 /01	02.05-12.08	TNK	<b>0 414 799 025</b>	<b>0 986 445 102</b>	
			Komp.Nr. 505108/05	02.05-12.08	TNK	<b>0 414 799 015</b>	<b>0 986 445 020</b>	
<b>2650</b> [MP2]	15,9	370	OM 542.940 <502 LA Euro3>					
			Komp.Nr. 505108 /04	04.03-12.08	TNK	<b>0 414 799 026</b>	<b>0 986 445 016</b>	
			Komp.Nr. 505108/01/02	04.03-12.08	TNK	<b>0 414 799 025</b>	<b>0 986 445 102</b>	
			Komp.Nr. 505108/06	04.03-12.08	TNK	<b>0 414 799 015</b>	<b>0 986 445 020</b>	
<b>2651</b> BlueTec [MP2]	15,9	375	OM 542.960 <502 LA Euro4/5>					
			Komp.Nr. 505108 /02	09.05-12.08	TNK	<b>0 414 799 025</b>	<b>0 986 445 102</b>	
			Komp.Nr. 505108/06	09.05-12.08	TNK	<b>0 414 799 015</b>	<b>0 986 445 020</b>	
<b>2654</b> [MP2]	15,9	395	OM 542.942 <502 LA Euro3>					
			Komp.Nr. 505108 /04	04.03-12.08	TNK	<b>0 414 799 026</b>	<b>0 986 445 016</b>	
			Komp.Nr. 505108/01/02	04.03-12.08	TNK	<b>0 414 799 025</b>	<b>0 986 445 102</b>	
			Komp.Nr. 505108/06	04.03-12.08	TNK	<b>0 414 799 015</b>	<b>0 986 445 020</b>	
<b>2655</b> BlueTec [MP2]	15,9	405	OM 542.962 <502 LA Euro4/5>					
			Komp.Nr. 505108 /02	09.05-12.08	TNK	<b>0 414 799 025</b>	<b>0 986 445 102</b>	
			Komp.Nr. 505108/06	09.05-12.08	TNK	<b>0 414 799 015</b>	<b>0 986 445 020</b>	





2658 [MP2]	15,9	425	OM 542.944 <502 LA Euro3>					
			Komp.Nr. 505108 /04	04.03-12.08	TNK	0 414 799 026	0 986 445 016	
			Komp.Nr. 505108/01/02	04.03-12.08	TNK	0 414 799 025	0 986 445 102	
3232 [MP2]	12,0	235	OM 541.940 <501 LA Euro3>					
			Komp.Nr. 505108/01	04.03-12.08	TNK	0 414 799 025	0 986 445 102	
			Komp.Nr. 505108/05/06	04.03-12.08	TNK	0 414 799 015	0 986 445 020	
BlueTec [MP2]	12,0	235	OM 541.970 <501 LA Euro4/5>					
			Komp.Nr. 505108 /01	02.05-12.08	TNK	0 414 799 025	0 986 445 102	
			Komp.Nr. 505108/05	02.05-12.08	TNK	0 414 799 015	0 986 445 020	
3236 [MP2]	12,0	265	OM 541.942 <501 LA Euro3>					
			Komp.Nr. 505108/01	04.03-12.08	TNK	0 414 799 025	0 986 445 102	
			Komp.Nr. 505108/05	04.03-12.08	TNK	0 414 799 015	0 986 445 020	
BlueTec [MP2]	11,9	265	OM 541.972 <501 LA Euro4/5>					
			Komp.Nr. 505108 /01	02.05-12.08	TNK	0 414 799 025	0 986 445 102	
			Komp.Nr. 505108/05	02.05-12.08	TNK	0 414 799 015	0 986 445 020	
3241 [MP2]	12,0	300	OM 541.944 <501 LA Euro3>					
			Komp.Nr. 505108/01	04.03-12.08	TNK	0 414 799 025	0 986 445 102	
			Komp.Nr. 505108/05	04.03-12.08	TNK	0 414 799 015	0 986 445 020	
BlueTec [MP2]	12,0	300	OM 541.974 <501 LA Euro4/5>					
			Komp.Nr. 505108 /01	02.05-12.08	TNK	0 414 799 025	0 986 445 102	
			Komp.Nr. 505108/05	02.05-12.08	TNK	0 414 799 015	0 986 445 020	
3244 BlueTec [MP2]	12,0	320	OM 541.976 <501 LA Euro4/5>					
			Komp.Nr. 505108 /01	02.05-12.08	TNK	0 414 799 025	0 986 445 102	
			Komp.Nr. 505108/05	02.05-12.08	TNK	0 414 799 015	0 986 445 020	
3246 [MP2]	12,0	335	OM 541.948 <501 LA Euro3>					
			Komp.Nr. 505108/01	04.03-12.08	TNK	0 414 799 025	0 986 445 102	
			Komp.Nr. 505108/05	04.03-12.08	TNK	0 414 799 015	0 986 445 020	
BlueTec [MP2]	12,0	335	OM 541.980 <501 LA Euro4/5>					
			Komp.Nr. 505108 /01	02.05-12.08	TNK	0 414 799 025	0 986 445 102	
			Komp.Nr. 505108/05	02.05-12.08	TNK	0 414 799 015	0 986 445 020	
3248 BlueTec [MP2]	12,0	350	OM 541.978 <501 LA Euro4/5>					
			Komp.Nr. 505108 /01	02.05-12.08	TNK	0 414 799 025	0 986 445 102	
			Komp.Nr. 505108/05	02.05-12.08	TNK	0 414 799 015	0 986 445 020	
3332 [MP2]	12,0	235	OM 541.940 <501 LA Euro3>					
			Komp.Nr. 505108/01	04.03-12.08	TNK	0 414 799 025	0 986 445 102	
			Komp.Nr. 505108/05/06	04.03-12.08	TNK	0 414 799 015	0 986 445 020	
BlueTec [MP2]	12,0	235	OM 541.970 <501 LA Euro4/5>					
			Komp.Nr. 505108 /01	02.05-12.08	TNK	0 414 799 025	0 986 445 102	
			Komp.Nr. 505108/05	02.05-12.08	TNK	0 414 799 015	0 986 445 020	
3336 [MP2]	12,0	265	OM 541.942 <501 LA Euro3>					
			Komp.Nr. 505108/01	04.03-12.08	TNK	0 414 799 025	0 986 445 102	
			Komp.Nr. 505108/05	04.03-12.08	TNK	0 414 799 015	0 986 445 020	
BlueTec [MP2]	11,9	265	OM 541.972 <501 LA Euro4/5>					
			Komp.Nr. 505108 /01	02.05-12.08	TNK	0 414 799 025	0 986 445 102	
			Komp.Nr. 505108/05	02.05-12.08	TNK	0 414 799 015	0 986 445 020	
3341 [MP2]	12,0	300	OM 541.944 <501 LA Euro3>					
			Komp.Nr. 505108/01	04.03-12.08	TNK	0 414 799 025	0 986 445 102	
			Komp.Nr. 505108/05	04.03-12.08	TNK	0 414 799 015	0 986 445 020	
BlueTec [MP2]	12,0	300	OM 541.974 <501 LA Euro4/5>					
			Komp.Nr. 505108 /01	02.05-12.08	TNK	0 414 799 025	0 986 445 102	
			Komp.Nr. 505108/05	02.05-12.08	TNK	0 414 799 015	0 986 445 020	
3344 [MP2]	12,0	320	OM 541.946 <501 LA Euro3>					
			Komp.Nr. 505108/01	06.03-12.08	TNK	0 414 799 025	0 986 445 102	
			Komp.Nr. 505108/05	06.03-12.08	TNK	0 414 799 015	0 986 445 020	
BlueTec [MP2]	12,0	320	OM 541.976 <501 LA Euro4/5>					
			Komp.Nr. 505108 /01	02.05-12.08	TNK	0 414 799 025	0 986 445 102	
			Komp.Nr. 505108/05	02.05-12.08	TNK	0 414 799 015	0 986 445 020	
3346 [MP2]	12,0	335	OM 541... <501 LA Euro3>					
			Komp.Nr. 505108/01	06.03-12.08	TNK	0 414 799 025	0 986 445 102	
			Komp.Nr. 505108/05	06.03-12.08	TNK	0 414 799 015	0 986 445 020	





◀ MERCEDES-BENZ

3346 BlueTec [MP2]	12,0	335	OM 541.980 <501 LA Euro4/5>					
				Komp.Nr. 505108 /01	02.05-12.08	TNK	0 414 799 025	0 986 445 102
3348 BlueTec [MP2]	12,0	350	OM 541.978 <501 LA Euro4/5>					
				Komp.Nr. 505108 /05	02.05-12.08	TNK	0 414 799 015	0 986 445 020
3350 [MP2]	15,9	370	OM 542.940 <502 LA Euro3>; OM 542.941 <502 LA Euro3>					
				Komp.Nr. 505108 /04	04.03-12.08	TNK	0 414 799 026	0 986 445 016
				Komp.Nr. 505108/01/02	04.03-12.08	TNK	0 414 799 025	0 986 445 102
				Komp.Nr. 505108/06	04.03-12.08	TNK	0 414 799 015	0 986 445 020
3351 BlueTec [MP2]	15,9	375	OM 542.960 <502 LA Euro4/5>					
				Komp.Nr. 505108 /02	02.05-12.08	TNK	0 414 799 025	0 986 445 102
3354 [MP2]	15,9	395	OM 542.942 <502 LA Euro3>					
				Komp.Nr. 505108 /04	04.03-12.08	TNK	0 414 799 026	0 986 445 016
3355 BlueTec [MP2]	15,9	405	OM 542.96... <502 LA Euro4/5>					
				Komp.Nr. 505108 /02	07.05-12.08	TNK	0 414 799 025	0 986 445 102
				Komp.Nr. 505108/06	07.05-12.08	TNK	0 414 799 015	0 986 445 020
				Komp.Nr. 505108/11	07.05-12.08	TNK	0 414 799 024	F 00E 200 413 0 986 445 022
3358 [MP2]	15,9	425	OM 542.944 <502 LA Euro3>					
				Komp.Nr. 505108 /04	04.03-12.08	TNK	0 414 799 026	0 986 445 016
				Komp.Nr. 505108/01/02	04.03-12.08	TNK	0 414 799 025	0 986 445 102
3360 BlueTec [MP2]	15,9	440	OM 542.964 <502 LA Euro4/5>					
				Komp.Nr. 505108 /02	09.06-12.08	TNK	0 414 799 025	0 986 445 102
4141 [MP2]	12,0	300	OM 541.944 <501 LA Euro3>					
				Komp.Nr. 505108/01	04.03-12.08	TNK	0 414 799 025	0 986 445 102
BlueTec [MP2]	12,0	300	OM 541.974 <501 LA Euro4/5>					
				Komp.Nr. 505108 /05	04.03-12.08	TNK	0 414 799 015	0 986 445 020
4144 [MP2]	12,0	320	OM 541.946 <501 LA Euro3>					
				Komp.Nr. 505108/01	06.03-12.08	TNK	0 414 799 025	0 986 445 102
BlueTec [MP2]	12,0	320	OM 541.976 <501 LA Euro4/5>					
				Komp.Nr. 505108/05	06.03-12.08	TNK	0 414 799 015	0 986 445 020
4146 [MP2]	12,0	335	OM 541... <501 LA Euro3>					
				Komp.Nr. 505108 /01	04.03-12.08	TNK	0 414 799 025	0 986 445 102
BlueTec [MP2]	12,0	335	OM 541.980 <501 LA Euro4/5>					
				Komp.Nr. 505108/05	04.03-12.08	TNK	0 414 799 015	0 986 445 020
4148 BlueTec [MP2]	12,0	350	OM 541.978 <501 LA Euro4/5>					
				Komp.Nr. 505108 /01	09.06-12.08	TNK	0 414 799 025	0 986 445 102
4150 [MP2]	15,9	370	OM 542.94... <502 LA Euro3>					
				Komp.Nr. 505108/05	09.06-12.08	TNK	0 414 799 015	0 986 445 020
4151 BlueTec [MP2]	15,9	375	OM 542.960 <502 LA Euro4/5>					
				Komp.Nr. 505108 /04	04.03-12.08	TNK	0 414 799 026	0 986 445 016
				Komp.Nr. 505108/01/02	04.03-12.08	TNK	0 414 799 025	0 986 445 102
BlueTec [MP2]	15,9	375	OM 542.960 <502 LA Euro4/5>					
				Komp.Nr. 505108/06	04.03-12.08	TNK	0 414 799 015	0 986 445 020
BlueTec [MP2]	15,9	375	OM 542.960 <502 LA Euro4/5>					
				Komp.Nr. 505108 /02	09.06-12.08	TNK	0 414 799 025	0 986 445 102
BlueTec [MP2]	15,9	375	OM 542.960 <502 LA Euro4/5>					
				Komp.Nr. 505108/06	09.06-12.08	TNK	0 414 799 015	0 986 445 020







<b>Actros III</b>									
<b>1832</b> AK BlueTec, BlueTec [MP3]	11,9	235	OM 541.996 <501 LA EEV>; OM 541.997 <501 LA EEV>	07.10→	TW	<b>0 414 799 015</b>	<b>0 986 445 020</b>	<b>0 414 799 024</b>	<b>F 00E 200 413</b>
								<b>0 986 445 022</b>	
						<b>0 414 799 025</b>	<b>0 986 445 102</b>		
BlueTec [MP3]	12,0	235	OM 541.970 <501 LA Euro4/5>	06.08→	TW	<b>0 414 799 035</b>	<b>0 986 445 025</b>		
						<b>0 414 799 015</b>	<b>0 986 445 020</b>		
						<b>0 414 799 024</b>	<b>F 00E 200 413</b>		
							<b>0 986 445 022</b>		
						<b>0 414 799 025</b>	<b>0 986 445 102</b>		
						<b>0 414 799 035</b>	<b>0 986 445 025</b>		
<b>1836</b> AK BlueTec, BlueTec [MP3]	11,9	265	OM 541.972 <501 LA Euro4/5>; OM 541.998 <501 LA EEV>; OM 541.999 <501 LA EEV>	06.08→	TW	<b>0 414 799 015</b>	<b>0 986 445 020</b>		
						<b>0 414 799 024</b>	<b>F 00E 200 413</b>		
							<b>0 986 445 022</b>		
						<b>0 414 799 025</b>	<b>0 986 445 102</b>		
						<b>0 414 799 035</b>	<b>0 986 445 025</b>		
<b>1841</b> AK BlueTec, BlueTec [MP3]	11,9	300	OM 541.990 <501 LA EEV>; OM 541.991 <501 LA EEV>	12.09→	TW	<b>0 414 799 015</b>	<b>0 986 445 020</b>		
						<b>0 414 799 024</b>	<b>F 00E 200 413</b>		
							<b>0 986 445 022</b>		
						<b>0 414 799 025</b>	<b>0 986 445 102</b>		
BlueTec [MP3]	12,0	300	OM 541.974 <501 LA Euro4/5>	06.08→	TW	<b>0 414 799 035</b>	<b>0 986 445 025</b>		
						<b>0 414 799 015</b>	<b>0 986 445 020</b>		
						<b>0 414 799 024</b>	<b>F 00E 200 413</b>		
							<b>0 986 445 022</b>		
						<b>0 414 799 025</b>	<b>0 986 445 102</b>		
						<b>0 414 799 035</b>	<b>0 986 445 025</b>		
<b>1844</b> AK BlueTec, BlueTec [MP3]	11,9	320	OM 541.992 <501 LA EEV>; OM 541.993 <501 LA EEV>	12.09→	TW	<b>0 414 799 015</b>	<b>0 986 445 020</b>		
						<b>0 414 799 024</b>	<b>F 00E 200 413</b>		
							<b>0 986 445 022</b>		
						<b>0 414 799 025</b>	<b>0 986 445 102</b>		
BlueTec [MP3]	12,0	320	OM 541.976 <501 LA Euro4/5>	06.08→	TW	<b>0 414 799 035</b>	<b>0 986 445 025</b>		
						<b>0 414 799 015</b>	<b>0 986 445 020</b>		
						<b>0 414 799 024</b>	<b>F 00E 200 413</b>		
							<b>0 986 445 022</b>		
						<b>0 414 799 025</b>	<b>0 986 445 102</b>		
						<b>0 414 799 035</b>	<b>0 986 445 025</b>		
<b>1846</b> AK BlueTec, BlueTec [MP3]	11,9	335	OM 541.994 <501 LA EEV>; OM 541.995 <501 LA EEV>	12.09→	TW	<b>0 414 799 015</b>	<b>0 986 445 020</b>		
						<b>0 414 799 024</b>	<b>F 00E 200 413</b>		
							<b>0 986 445 022</b>		
						<b>0 414 799 025</b>	<b>0 986 445 102</b>		
BlueTec [MP3]	12,0	335	OM 541.980 <501 LA Euro4/5>	06.08→	TW	<b>0 414 799 035</b>	<b>0 986 445 025</b>		
						<b>0 414 799 015</b>	<b>0 986 445 020</b>		
						<b>0 414 799 024</b>	<b>F 00E 200 413</b>		
							<b>0 986 445 022</b>		
						<b>0 414 799 025</b>	<b>0 986 445 102</b>		
						<b>0 414 799 035</b>	<b>0 986 445 025</b>		
<b>1848</b> BlueTec [MP3]	12,0	350	OM 541.978 <501 LA Euro4/5>	06.08→	TW	<b>0 414 799 015</b>	<b>0 986 445 020</b>		
						<b>0 414 799 024</b>	<b>F 00E 200 413</b>		
							<b>0 986 445 022</b>		
						<b>0 414 799 025</b>	<b>0 986 445 102</b>		
						<b>0 414 799 035</b>	<b>0 986 445 025</b>		
<b>1851</b> BlueTec [MP3]	15,9	375	OM 542.960 <502 LA Euro4/5>	06.08→	TW	<b>0 414 799 015</b>	<b>0 986 445 020</b>		
						<b>0 414 799 024</b>	<b>F 00E 200 413</b>		
							<b>0 986 445 022</b>		
						<b>0 414 799 025</b>	<b>0 986 445 102</b>		
						<b>0 414 799 035</b>	<b>0 986 445 025</b>		
<b>1855</b> BlueTec [MP3]	15,9	405	OM 542.962 <502 LA Euro4/5>	06.08→	TW	<b>0 414 799 015</b>	<b>0 986 445 020</b>		
						<b>0 414 799 024</b>	<b>F 00E 200 413</b>		
							<b>0 986 445 022</b>		
						<b>0 414 799 025</b>	<b>0 986 445 102</b>		
						<b>0 414 799 035</b>	<b>0 986 445 025</b>		







◀ MERCEDES-BENZ

<b>1860</b> BlueTec [MP3]	15,9	440	OM 542.964 <502 LA Euro4/5>	06.08→	TW	<b>0 414 799 015</b> <b>0 414 799 024</b> <b>0 986 445 022</b> <b>0 414 799 025</b> <b>0 986 445 102</b> <b>0 414 799 035</b> <b>0 986 445 025</b>
<b>2031</b> [MP3]	12,0	230	OM 541.920 <(501)LA Euro2> Komp.Nr. 505108/01 Komp.Nr. 505108/06	09.08→ 09.08→	TNK TNK	<b>0 414 799 025</b> <b>0 986 445 102</b> <b>0 414 799 015</b> <b>0 986 445 020</b>
<b>2032</b> A/AK/AS BlueTec, BlueTec [MP3]	11,9	235	OM 541.996 <501 LA EEV>; OM 541.997 <501 LA EEV>	07.10→	TW	<b>0 414 799 015</b> <b>0 986 445 020</b> <b>0 414 799 024</b> <b>F 00E 200 413</b> <b>0 986 445 022</b> <b>0 414 799 025</b> <b>0 986 445 102</b> <b>0 414 799 035</b> <b>0 986 445 025</b>
BlueTec [MP3]	12,0	235	OM 541.970 <501 LA Euro4/5>	06.08→	TW	<b>0 414 799 015</b> <b>0 986 445 020</b> <b>0 414 799 024</b> <b>F 00E 200 413</b> <b>0 986 445 022</b> <b>0 414 799 025</b> <b>0 986 445 102</b> <b>0 414 799 035</b> <b>0 986 445 025</b>
<b>2036</b> A/AK/AS BlueTec, BlueTec [MP3]	11,9	265	OM 541.972 <501 LA Euro4/5>; OM 541.998 <501 LA EEV>; OM 541.999 <501 LA EEV>	06.08→	TW	<b>0 414 799 015</b> <b>0 986 445 020</b> <b>0 414 799 024</b> <b>F 00E 200 413</b> <b>0 986 445 022</b> <b>0 414 799 025</b> <b>0 986 445 102</b> <b>0 414 799 035</b> <b>0 986 445 025</b>
<b>2040</b> S [MP3]	12,0	290	OM 541.923 <(501)LA Euro2> Komp.Nr. 505108/01 Komp.Nr. 505108/05	09.08→ 09.08→	TNK TNK	<b>0 414 799 025</b> <b>0 986 445 102</b> <b>0 414 799 015</b> <b>0 986 445 020</b>
<b>2041</b> AK/AS BlueTec, BlueTec [MP3]	11,9	300	OM 541.990 <501 LA EEV>; OM 541.991 <501 LA EEV>	12.09→	TW	<b>0 414 799 015</b> <b>0 986 445 020</b> <b>0 414 799 024</b> <b>F 00E 200 413</b> <b>0 986 445 022</b> <b>0 414 799 025</b> <b>0 986 445 102</b> <b>0 414 799 035</b> <b>0 986 445 025</b>
BlueTec [MP3]	12,0	300	OM 541.974 <501 LA Euro4/5>	06.08→	TW	<b>0 414 799 015</b> <b>0 986 445 020</b> <b>0 414 799 024</b> <b>F 00E 200 413</b> <b>0 986 445 022</b> <b>0 414 799 025</b> <b>0 986 445 102</b> <b>0 414 799 035</b> <b>0 986 445 025</b>
<b>2044</b> BlueTec [MP3]	11,9	320	OM 541.992 <501 LA EEV>; OM 541.993 <501 LA EEV>	12.09→	TW	<b>0 414 799 015</b> <b>0 986 445 020</b> <b>0 414 799 024</b> <b>F 00E 200 413</b> <b>0 986 445 022</b> <b>0 414 799 025</b> <b>0 986 445 102</b> <b>0 414 799 035</b> <b>0 986 445 025</b>
	12,0	320	OM 541.976 <501 LA Euro4/5>	06.08→	TW	<b>0 414 799 015</b> <b>0 986 445 020</b> <b>0 414 799 024</b> <b>F 00E 200 413</b> <b>0 986 445 022</b> <b>0 414 799 025</b> <b>0 986 445 102</b> <b>0 414 799 035</b> <b>0 986 445 025</b>
<b>2046</b> AK/AS BlueTec, BlueTec [MP3]	11,9	335	OM 541.994 <501 LA EEV>; OM 541.995 <501 LA EEV>	12.09→	TW	<b>0 414 799 015</b> <b>0 986 445 020</b> <b>0 414 799 024</b> <b>F 00E 200 413</b> <b>0 986 445 022</b> <b>0 414 799 025</b> <b>0 986 445 102</b> <b>0 414 799 035</b> <b>0 986 445 025</b>
BlueTec [MP3]	12,0	335	OM 541.980 <501 LA Euro4/5>	06.08→	TW	<b>0 414 799 015</b> <b>0 986 445 020</b> <b>0 414 799 024</b> <b>F 00E 200 413</b> <b>0 986 445 022</b> <b>0 414 799 025</b> <b>0 986 445 102</b> <b>0 414 799 035</b> <b>0 986 445 025</b>
<b>2048</b> BlueTec [MP3]	12,0	350	OM 541.978 <501 LA Euro4/5>	06.08→	TW	<b>0 414 799 015</b> <b>0 986 445 020</b> <b>0 414 799 024</b> <b>F 00E 200 413</b> <b>0 986 445 022</b> <b>0 414 799 025</b> <b>0 986 445 102</b> <b>0 414 799 035</b> <b>0 986 445 025</b>





<b>2051</b> BlueTec [MP3]	15,9	375	OM 542.960 <502 LA Euro4/5>	06.08→	TW	0 414 799 015	0 986 445 020
						0 414 799 024	F 00E 200 413
							0 986 445 022
						0 414 799 025	0 986 445 102
						0 414 799 035	0 986 445 025
<b>2055</b> BlueTec [MP3]	15,9	405	OM 542.962 <502 LA Euro4/5>	06.08→	TW	0 414 799 015	0 986 445 020
						0 414 799 024	F 00E 200 413
							0 986 445 022
						0 414 799 025	0 986 445 102
						0 414 799 035	0 986 445 025
<b>2432</b> BlueTec [MP3]	12,0	235	OM 541.970 <501 LA Euro4/5>	06.08→	TW	0 414 799 015	0 986 445 020
						0 414 799 024	F 00E 200 413
							0 986 445 022
						0 414 799 025	0 986 445 102
						0 414 799 035	0 986 445 025
LS BlueTec [MP3]	11,9	235	OM 541.996 <501 LA EEV>	07.10→	TW	0 414 799 015	0 986 445 020
						0 414 799 024	F 00E 200 413
							0 986 445 022
						0 414 799 025	0 986 445 102
						0 414 799 035	0 986 445 025
<b>2436</b> BlueTec, LS BlueTec [MP3]	11,9	265	OM 541.972 <501 LA Euro4/5>; OM 541.998 <501 LA EEV>	06.08→	TW	0 414 799 015	0 986 445 020
						0 414 799 024	F 00E 200 413
							0 986 445 022
						0 414 799 025	0 986 445 102
						0 414 799 035	0 986 445 025
<b>2441</b> BlueTec [MP3]	12,0	300	OM 541.974 <501 LA Euro4/5>	06.08→	TW	0 414 799 015	0 986 445 020
						0 414 799 024	F 00E 200 413
							0 986 445 022
						0 414 799 025	0 986 445 102
						0 414 799 035	0 986 445 025
LS BlueTec [MP3]	11,9	300	OM 541.990 <501 LA EEV>	12.09→	TW	0 414 799 015	0 986 445 020
						0 414 799 024	F 00E 200 413
							0 986 445 022
						0 414 799 025	0 986 445 102
						0 414 799 035	0 986 445 025
<b>2444</b> BlueTec [MP3]	12,0	320	OM 541.976 <501 LA Euro4/5>	06.08→	TW	0 414 799 015	0 986 445 020
						0 414 799 024	F 00E 200 413
							0 986 445 022
						0 414 799 025	0 986 445 102
						0 414 799 035	0 986 445 025
LS BlueTec [MP3]	11,9	320	OM 541.992 <501 LA EEV>	12.09→	TW	0 414 799 015	0 986 445 020
						0 414 799 024	F 00E 200 413
							0 986 445 022
						0 414 799 025	0 986 445 102
						0 414 799 035	0 986 445 025
<b>2446</b> BlueTec [MP3]	12,0	335	OM 541.980 <501 LA Euro4/5>	06.08→	TW	0 414 799 015	0 986 445 020
						0 414 799 024	F 00E 200 413
							0 986 445 022
						0 414 799 025	0 986 445 102
						0 414 799 035	0 986 445 025
<b>2448</b> BlueTec [MP3]	12,0	350	OM 541.978 <501 LA Euro4/5>	06.08→	TW	0 414 799 015	0 986 445 020
						0 414 799 024	F 00E 200 413
							0 986 445 022
						0 414 799 025	0 986 445 102
						0 414 799 035	0 986 445 025
<b>2451</b> BlueTec [MP3]	15,9	375	OM 542.960 <502 LA Euro4/5>	06.08→	TW	0 414 799 015	0 986 445 020
						0 414 799 024	F 00E 200 413
							0 986 445 022
						0 414 799 025	0 986 445 102
						0 414 799 035	0 986 445 025





◀ MERCEDES-BENZ

2455 BlueTec [MP3]	15,9	405	OM 542.962 <502 LA Euro4/5>	06.08→	TW	0 414 799 015	0 986 445 020
						0 414 799 024	F 00E 200 413
							0 986 445 022
						0 414 799 025	0 986 445 102
						0 414 799 035	0 986 445 025
2460 BlueTec [MP3]	15,9	440	OM 542.964 <502 LA Euro4/5>	06.08→	TW	0 414 799 015	0 986 445 020
						0 414 799 024	F 00E 200 413
							0 986 445 022
						0 414 799 025	0 986 445 102
						0 414 799 035	0 986 445 025
2532 BlueTec [MP3]	11,9	235	OM 541.996 <501 LA EEV>	07.10→	TW	0 414 799 015	0 986 445 020
						0 414 799 024	F 00E 200 413
							0 986 445 022
						0 414 799 025	0 986 445 102
						0 414 799 035	0 986 445 025
2532 BlueTec [MP3]	12,0	235	OM 541.970 <501 LA Euro4/5>	06.08→	TW	0 414 799 015	0 986 445 020
						0 414 799 024	F 00E 200 413
							0 986 445 022
						0 414 799 025	0 986 445 102
						0 414 799 035	0 986 445 025
2536 BlueTec [MP3]	11,9	265	OM 541.972 <501 LA Euro4/5>; OM 541.998 <501 LA EEV>	06.08→	TW	0 414 799 015	0 986 445 020
						0 414 799 024	F 00E 200 413
							0 986 445 022
						0 414 799 025	0 986 445 102
						0 414 799 035	0 986 445 025
2541 BlueTec [MP3]	11,9	300	OM 541.990 <501 LA EEV>	12.09→	TW	0 414 799 015	0 986 445 020
						0 414 799 024	F 00E 200 413
							0 986 445 022
						0 414 799 025	0 986 445 102
						0 414 799 035	0 986 445 025
2541 BlueTec [MP3]	12,0	300	OM 541.974 <501 LA Euro4/5>	06.08→	TW	0 414 799 015	0 986 445 020
						0 414 799 024	F 00E 200 413
							0 986 445 022
						0 414 799 025	0 986 445 102
						0 414 799 035	0 986 445 025
2544 BlueTec [MP3]	11,9	320	OM 541.992 <501 LA EEV>	12.09→	TW	0 414 799 015	0 986 445 020
						0 414 799 024	F 00E 200 413
							0 986 445 022
						0 414 799 025	0 986 445 102
						0 414 799 035	0 986 445 025
2544 BlueTec [MP3]	12,0	320	OM 541.976 <501 LA Euro4/5>	06.08→	TW	0 414 799 015	0 986 445 020
						0 414 799 024	F 00E 200 413
							0 986 445 022
						0 414 799 025	0 986 445 102
						0 414 799 035	0 986 445 025
2546 BlueTec [MP3]	11,9	335	OM 541.994 <501 LA EEV>	12.09→	TW	0 414 799 015	0 986 445 020
						0 414 799 024	F 00E 200 413
							0 986 445 022
						0 414 799 025	0 986 445 102
						0 414 799 035	0 986 445 025
2546 BlueTec [MP3]	12,0	335	OM 541.980 <501 LA Euro4/5>	06.08→	TW	0 414 799 015	0 986 445 020
						0 414 799 024	F 00E 200 413
							0 986 445 022
						0 414 799 025	0 986 445 102
						0 414 799 035	0 986 445 025
2548 BlueTec [MP3]	12,0	350	OM 541.978 <501 LA Euro4/5>	06.08→	TW	0 414 799 015	0 986 445 020
						0 414 799 024	F 00E 200 413
							0 986 445 022
						0 414 799 025	0 986 445 102
						0 414 799 035	0 986 445 025





<b>2551</b> BlueTec [MP3]	15,9	375	OM 542.960 <502 LA Euro4/5>	06.08→	TW	0 414 799 015	0 986 445 020
						0 414 799 024	F 00E 200 413
							0 986 445 022
						0 414 799 025	0 986 445 102
<b>2555</b> BlueTec [MP3]	15,9	405	OM 542.962 <502 LA Euro4/5>	06.08→	TW	0 414 799 015	0 986 445 020
						0 414 799 024	F 00E 200 413
							0 986 445 022
						0 414 799 025	0 986 445 102
<b>2560</b> BlueTec [MP3]	15,9	440	OM 542.964 <502 LA Euro4/5>	06.08→	TW	0 414 799 015	0 986 445 020
						0 414 799 024	F 00E 200 413
							0 986 445 022
						0 414 799 025	0 986 445 102
<b>2632</b> BlueTec [MP3]	11,9	235	OM 541.996 <501 LA EEV>	07.10→	TW	0 414 799 015	0 986 445 020
						0 414 799 024	F 00E 200 413
							0 986 445 022
						0 414 799 025	0 986 445 102
<b>2636</b> BlueTec [MP3]	11,9	265	OM 541.972 <501 LA Euro4/5>; OM 541.998 <501 LA EEV>	06.08→	TW	0 414 799 015	0 986 445 020
						0 414 799 024	F 00E 200 413
							0 986 445 022
						0 414 799 025	0 986 445 102
<b>2641</b> BlueTec [MP3]	11,9	300	OM 541.990 <501 LA EEV>	12.09→	TW	0 414 799 015	0 986 445 020
						0 414 799 024	F 00E 200 413
							0 986 445 022
						0 414 799 025	0 986 445 102
<b>2644</b> BlueTec [MP3]	11,9	320	OM 541.992 <501 LA EEV>	12.09→	TW	0 414 799 015	0 986 445 020
						0 414 799 024	F 00E 200 413
							0 986 445 022
						0 414 799 025	0 986 445 102
<b>2646</b> BlueTec [MP3]	11,9	335	OM 541.994 <501 LA EEV>	12.09→	TW	0 414 799 015	0 986 445 020
						0 414 799 024	F 00E 200 413
							0 986 445 022
						0 414 799 025	0 986 445 102
<b>2646</b> BlueTec [MP3]	12,0	335	OM 541.980 <501 LA Euro4/5>	06.08→	TW	0 414 799 015	0 986 445 020
						0 414 799 024	F 00E 200 413
							0 986 445 022
						0 414 799 025	0 986 445 102
<b>2646</b> BlueTec [MP3]	12,0	335	OM 541.980 <501 LA Euro4/5>	06.08→	TW	0 414 799 015	0 986 445 020
						0 414 799 024	F 00E 200 413
							0 986 445 022
						0 414 799 025	0 986 445 102
<b>2646</b> BlueTec [MP3]	12,0	335	OM 541.980 <501 LA Euro4/5>	06.08→	TW	0 414 799 015	0 986 445 020
						0 414 799 024	F 00E 200 413
							0 986 445 022
						0 414 799 025	0 986 445 102





◀ MERCEDES-BENZ

<b>2648</b> BlueTec [MP3]	12,0	350	OM 541.978 <501 LA Euro4/5>	06.08→	TW	<b>0 414 799 015</b> <b>0 414 799 024</b> <b>0 986 445 020</b> <b>0 986 445 022</b>
<b>2651</b> BlueTec [MP3]	15,9	375	OM 542.960 <502 LA Euro4/5>	06.08→	TW	<b>0 414 799 025</b> <b>0 986 445 102</b> <b>0 414 799 035</b> <b>0 986 445 025</b>
<b>2655</b> BlueTec [MP3]	15,9	405	OM 542.962 <502 LA Euro4/5>	06.08→	TW	<b>0 414 799 015</b> <b>0 986 445 020</b> <b>0 414 799 024</b> <b>F 00E 200 413</b> <b>0 986 445 022</b>
<b>2660</b> BlueTec [MP3]	15,9	440	OM 542.964 <502 LA Euro4/5>	06.08→	TW	<b>0 414 799 025</b> <b>0 986 445 102</b> <b>0 414 799 035</b> <b>0 986 445 025</b>
<b>2665</b> LS Blue Tec [MP3]	15,9	480	OM 542.968 <OM 502 LA Euro 4/5>	08.08→	TW	<b>0 414 799 015</b> <b>0 986 445 020</b> <b>0 414 799 024</b> <b>F 00E 200 413</b> <b>0 986 445 022</b>
<b>2732</b> AE/AKE BlueTec [MP3]	11,9	235	OM 541.971 <501 LA Euro 4/5>	06.08→	TW	<b>0 414 799 025</b> <b>0 986 445 102</b> <b>0 414 799 035</b> <b>0 986 445 025</b>
<b>2736</b> AE/AKE BlueTec [MP3]	11,9	265	OM 541.973 <501 LA Euro 4/5>	06.08→	TW	<b>0 414 799 015</b> <b>0 986 445 020</b> <b>0 414 799 024</b> <b>F 00E 200 413</b> <b>0 986 445 022</b>
<b>2741</b> AE/AKE BlueTec [MP3]	11,9	300	OM 541.975 <501 LA Euro 4/5>; OM 541.991 <501 LA EEV>	06.08→	TW	<b>0 414 799 025</b> <b>0 986 445 102</b> <b>0 414 799 035</b> <b>0 986 445 025</b>
<b>2744</b> AE/AKE BlueTec, BlueTec [MP3]	11,9	320	OM 541.977 <501 LA Euro 4/5>; OM 541.993 <501 LA EEV>	06.08→	TW	<b>0 414 799 015</b> <b>0 986 445 020</b> <b>0 414 799 024</b> <b>F 00E 200 413</b> <b>0 986 445 022</b>
<b>2746</b> AE/AKE BlueTec, BlueTec [MP3]	11,9	335	OM 541.981 <501 LA Euro 4/5>; OM 541.995 <501 LA EEV>	06.08→	TW	<b>0 414 799 025</b> <b>0 986 445 102</b> <b>0 414 799 035</b> <b>0 986 445 025</b>
<b>2748</b> AE/AKE BlueTec [MP3]	11,9	350	OM 541.979 <501 LA Euro 4/5>	06.08→	TW	<b>0 414 799 015</b> <b>0 986 445 020</b> <b>0 414 799 024</b> <b>F 00E 200 413</b> <b>0 986 445 022</b>
<b>3232</b> BlueTec [MP3]	11,9	235	OM 541.996 <501 LA EEV>	07.10→	TW	<b>0 414 799 025</b> <b>0 986 445 102</b> <b>0 414 799 035</b> <b>0 986 445 025</b>
						<b>0 414 799 015</b> <b>0 986 445 020</b> <b>0 414 799 024</b> <b>F 00E 200 413</b> <b>0 986 445 022</b>
						<b>0 414 799 025</b> <b>0 986 445 102</b> <b>0 414 799 035</b> <b>0 986 445 025</b>





<b>3232</b> BlueTec [MP3]	12,0	235	OM 541.970 <501 LA Euro4/5>	06.08→	TW	0 414 799 015	0 986 445 020
						0 414 799 024	F 00E 200 413
							0 986 445 022
						0 414 799 025	0 986 445 102
<b>3236</b> BlueTec [MP3]	11,9	265	OM 541.972 <501 LA Euro4/5>; OM 541.998 <501 LA EEV>	06.08→	TW	0 414 799 015	0 986 445 020
						0 414 799 024	F 00E 200 413
							0 986 445 022
						0 414 799 025	0 986 445 102
<b>3241</b> BlueTec [MP3]	11,9	300	OM 541.990 <501 LA EEV>	12.09→	TW	0 414 799 015	0 986 445 020
						0 414 799 024	F 00E 200 413
							0 986 445 022
						0 414 799 025	0 986 445 102
	12,0	300	OM 541.974 <501 LA Euro4/5>	06.08→	TW	0 414 799 015	0 986 445 020
						0 414 799 024	F 00E 200 413
							0 986 445 022
						0 414 799 025	0 986 445 102
<b>3244</b> BlueTec [MP3]	11,9	320	OM 541.992 <501 LA EEV>	12.09→	TW	0 414 799 015	0 986 445 020
						0 414 799 024	F 00E 200 413
							0 986 445 022
						0 414 799 025	0 986 445 102
	12,0	320	OM 541.976 <501 LA Euro4/5>	06.08→	TW	0 414 799 015	0 986 445 020
						0 414 799 024	F 00E 200 413
							0 986 445 022
						0 414 799 025	0 986 445 102
<b>3246</b> BlueTec [MP3]	11,9	335	OM 541.994 <501 LA EEV>	12.09→	TW	0 414 799 015	0 986 445 020
						0 414 799 024	F 00E 200 413
							0 986 445 022
						0 414 799 025	0 986 445 102
	12,0	335	OM 541.980 <501 LA Euro4/5>	06.08→	TW	0 414 799 015	0 986 445 020
						0 414 799 024	F 00E 200 413
							0 986 445 022
						0 414 799 025	0 986 445 102
<b>3248</b> BlueTec [MP3]	12,0	350	OM 541.978 <501 LA Euro4/5>	06.08→	TW	0 414 799 015	0 986 445 020
						0 414 799 024	F 00E 200 413
							0 986 445 022
						0 414 799 025	0 986 445 102
<b>3332</b> AK/AS BlueTec, BlueTec [MP3]	11,9	235	OM 541.996 <501 LA EEV>; OM 541.997 <501 LA EEV>	07.10→	TW	0 414 799 015	0 986 445 020
						0 414 799 024	F 00E 200 413
							0 986 445 022
						0 414 799 025	0 986 445 102
BlueTec [MP3]	12,0	235	OM 541.970 <501 LA Euro4/5>	06.08→	TW	0 414 799 015	0 986 445 020
						0 414 799 024	F 00E 200 413
							0 986 445 022
						0 414 799 025	0 986 445 102
<b>3336</b> AK/AS BlueTec, BlueTec [MP3]	11,9	265	OM 541.972 <501 LA Euro4/5>; OM 541.998 <501 LA EEV>; OM 541.999 <501 LA EEV>	06.08→	TW	0 414 799 015	0 986 445 020
						0 414 799 024	F 00E 200 413
							0 986 445 022
						0 414 799 025	0 986 445 102
<b>3340</b> S [MP3]	12,0	290	OM 541.923 <(501)LA Euro2>	09.08→	TNK	0 414 799 025	0 986 445 102
						Komp.Nr. 505108/05	0 414 799 015







◀ MERCEDES-BENZ

<b>3341</b> BlueTec [MP3]	11,9	300	OM 541.990 <501 LA EEV>; OM 541.991 <501 LA EEV>	12.09→	TW	<b>0 414 799 015</b>	<b>0 986 445 020</b>
						<b>0 414 799 024</b>	<b>F 00E 200 413</b> <b>0 986 445 022</b>
						<b>0 414 799 025</b>	<b>0 986 445 102</b>
						<b>0 414 799 035</b>	<b>0 986 445 025</b>
	12,0	300	OM 541.974 <501 LA Euro4/5>	06.08→	TW	<b>0 414 799 015</b>	<b>0 986 445 020</b>
						<b>0 414 799 024</b>	<b>F 00E 200 413</b> <b>0 986 445 022</b>
						<b>0 414 799 025</b>	<b>0 986 445 102</b>
						<b>0 414 799 035</b>	<b>0 986 445 025</b>
<b>3344</b> A/AK/AS BlueTec, BlueTec [MP3]	11,9	320	OM 541.992 <501 LA EEV>; OM 541.993 <501 LA EEV>	12.09→	TW	<b>0 414 799 015</b>	<b>0 986 445 020</b>
						<b>0 414 799 024</b>	<b>F 00E 200 413</b> <b>0 986 445 022</b>
						<b>0 414 799 025</b>	<b>0 986 445 102</b>
						<b>0 414 799 035</b>	<b>0 986 445 025</b>
BlueTec [MP3]	12,0	320	OM 541.976 <501 LA Euro4/5>	06.08→	TW	<b>0 414 799 015</b>	<b>0 986 445 020</b>
						<b>0 414 799 024</b>	<b>F 00E 200 413</b> <b>0 986 445 022</b>
						<b>0 414 799 025</b>	<b>0 986 445 102</b>
						<b>0 414 799 035</b>	<b>0 986 445 025</b>
<b>3346</b> A/AK/AS BlueTec, BlueTec [MP3]	11,9	335	OM 541.994 <501 LA EEV>; OM 541.995 <501 LA EEV>	12.09→	TW	<b>0 414 799 015</b>	<b>0 986 445 020</b>
						<b>0 414 799 024</b>	<b>F 00E 200 413</b> <b>0 986 445 022</b>
						<b>0 414 799 025</b>	<b>0 986 445 102</b>
						<b>0 414 799 035</b>	<b>0 986 445 025</b>
BlueTec [MP3]	12,0	335	OM 541.980 <501 LA Euro4/5>	06.08→	TW	<b>0 414 799 015</b>	<b>0 986 445 020</b>
						<b>0 414 799 024</b>	<b>F 00E 200 413</b> <b>0 986 445 022</b>
						<b>0 414 799 025</b>	<b>0 986 445 102</b>
						<b>0 414 799 035</b>	<b>0 986 445 025</b>
<b>3348</b> BlueTec [MP3]	12,0	350	OM 541.978 <501 LA Euro4/5>	06.08→	TW	<b>0 414 799 015</b>	<b>0 986 445 020</b>
						<b>0 414 799 024</b>	<b>F 00E 200 413</b> <b>0 986 445 022</b>
						<b>0 414 799 025</b>	<b>0 986 445 102</b>
						<b>0 414 799 035</b>	<b>0 986 445 025</b>
<b>3351</b> BlueTec [MP3]	15,9	375	OM 542.960 <502 LA Euro4/5>	06.08→	TW	<b>0 414 799 015</b>	<b>0 986 445 020</b>
						<b>0 414 799 024</b>	<b>F 00E 200 413</b> <b>0 986 445 022</b>
						<b>0 414 799 025</b>	<b>0 986 445 102</b>
						<b>0 414 799 035</b>	<b>0 986 445 025</b>
<b>3355</b> BlueTec [MP3]	15,9	405	OM 542.962 <502 LA Euro4/5>	06.08→	TW	<b>0 414 799 015</b>	<b>0 986 445 020</b>
						<b>0 414 799 024</b>	<b>F 00E 200 413</b> <b>0 986 445 022</b>
						<b>0 414 799 025</b>	<b>0 986 445 102</b>
						<b>0 414 799 035</b>	<b>0 986 445 025</b>
<b>3360</b> BlueTec [MP3]	15,9	440	OM 542.964 <502 LA Euro4/5>	06.08→	TW	<b>0 414 799 015</b>	<b>0 986 445 020</b>
						<b>0 414 799 024</b>	<b>F 00E 200 413</b> <b>0 986 445 022</b>
						<b>0 414 799 025</b>	<b>0 986 445 102</b>
						<b>0 414 799 035</b>	<b>0 986 445 025</b>
<b>3365</b> Blue Tec [MP3]	15,9	480	OM 542.96... <OM 502 LA Euro 4/5>	08.08→	TW	<b>0 414 799 015</b>	<b>0 986 445 020</b>
						<b>0 414 799 024</b>	<b>F 00E 200 413</b> <b>0 986 445 022</b>
						<b>0 414 799 025</b>	<b>0 986 445 102</b>
						<b>0 414 799 035</b>	<b>0 986 445 025</b>
<b>3641</b> AKE BlueTec [MP3]	11,9	300	OM 541.991 <501 LA EEV>	12.09→	TW	<b>0 414 799 015</b>	<b>0 986 445 020</b>
						<b>0 414 799 024</b>	<b>F 00E 200 413</b> <b>0 986 445 022</b>
						<b>0 414 799 025</b>	<b>0 986 445 102</b>
						<b>0 414 799 035</b>	<b>0 986 445 025</b>





<b>3644</b> AKE BlueTec [MP3]	11,9	320	OM 541.993 <501 LA EEV>	12.09→	TW	<b>0 414 799 015</b>	<b>0 986 445 020</b>
						<b>0 414 799 024</b>	<b>F 00E 200 413</b>
							<b>0 986 445 022</b>
						<b>0 414 799 025</b>	<b>0 986 445 102</b>
						<b>0 414 799 035</b>	<b>0 986 445 025</b>
<b>4040</b> K [MP3]	12,0	290	OM 541.923 <(501)LA Euro2>				
			Komp.Nr. 505108/01	09.08→	TNK	<b>0 414 799 025</b>	<b>0 986 445 102</b>
			Komp.Nr. 505108/05	09.08→	TNK	<b>0 414 799 015</b>	<b>0 986 445 020</b>
<b>4140</b> B [MP3]	12,0	290	OM 541.923 <(501)LA Euro2>				
			Komp.Nr. 505108/01	09.08→	TNK	<b>0 414 799 025</b>	<b>0 986 445 102</b>
			Komp.Nr. 505108/05	09.08→	TNK	<b>0 414 799 015</b>	<b>0 986 445 020</b>
<b>4141</b> AK BlueTec, BlueTec [MP3]	11,9	300-302	OM 541.990 <501 LA EEV>; OM 541.991 <501 LA EEV>	12.09→	TW	<b>0 414 799 015</b>	<b>0 986 445 020</b>
						<b>0 414 799 024</b>	<b>F 00E 200 413</b>
							<b>0 986 445 022</b>
						<b>0 414 799 025</b>	<b>0 986 445 102</b>
						<b>0 414 799 035</b>	<b>0 986 445 025</b>
BlueTec [MP3]	12,0	300	OM 541.974 <501 LA Euro4/5>	06.08→	TW	<b>0 414 799 015</b>	<b>0 986 445 020</b>
						<b>0 414 799 024</b>	<b>F 00E 200 413</b>
							<b>0 986 445 022</b>
						<b>0 414 799 025</b>	<b>0 986 445 102</b>
						<b>0 414 799 035</b>	<b>0 986 445 025</b>
<b>4144</b> AK BlueTec, BlueTec [MP3]	11,9	320	OM 541.992 <501 LA EEV>; OM 541.993 <501 LA EEV>	12.09→	TW	<b>0 414 799 015</b>	<b>0 986 445 020</b>
						<b>0 414 799 024</b>	<b>F 00E 200 413</b>
							<b>0 986 445 022</b>
						<b>0 414 799 025</b>	<b>0 986 445 102</b>
						<b>0 414 799 035</b>	<b>0 986 445 025</b>
BlueTec [MP3]	12,0	320	OM 541.976 <501 LA Euro4/5>	06.08→	TW	<b>0 414 799 015</b>	<b>0 986 445 020</b>
						<b>0 414 799 024</b>	<b>F 00E 200 413</b>
							<b>0 986 445 022</b>
						<b>0 414 799 025</b>	<b>0 986 445 102</b>
						<b>0 414 799 035</b>	<b>0 986 445 025</b>
<b>4146</b> BlueTec [MP3]	11,9	335	OM 541.994 <501 LA EEV>	12.09→	TW	<b>0 414 799 015</b>	<b>0 986 445 020</b>
						<b>0 414 799 024</b>	<b>F 00E 200 413</b>
							<b>0 986 445 022</b>
						<b>0 414 799 025</b>	<b>0 986 445 102</b>
						<b>0 414 799 035</b>	<b>0 986 445 025</b>
	12,0	335	OM 541.980 <501 LA Euro4/5>	06.08→	TW	<b>0 414 799 015</b>	<b>0 986 445 020</b>
						<b>0 414 799 024</b>	<b>F 00E 200 413</b>
							<b>0 986 445 022</b>
						<b>0 414 799 025</b>	<b>0 986 445 102</b>
						<b>0 414 799 035</b>	<b>0 986 445 025</b>
<b>4148</b> BlueTec [MP3]	12,0	350	OM 541.978 <501 LA Euro4/5>	06.08→	TW	<b>0 414 799 015</b>	<b>0 986 445 020</b>
						<b>0 414 799 024</b>	<b>F 00E 200 413</b>
							<b>0 986 445 022</b>
						<b>0 414 799 025</b>	<b>0 986 445 102</b>
						<b>0 414 799 035</b>	<b>0 986 445 025</b>
<b>4151</b> BlueTec [MP3]	15,9	375	OM 542.960 <502 LA Euro4/5>	06.08→	TW	<b>0 414 799 015</b>	<b>0 986 445 020</b>
						<b>0 414 799 024</b>	<b>F 00E 200 413</b>
							<b>0 986 445 022</b>
						<b>0 414 799 025</b>	<b>0 986 445 102</b>
						<b>0 414 799 035</b>	<b>0 986 445 025</b>
<b>4155</b> BlueTec [MP3]	15,9	405	OM 542.962 <502 LA Euro4/5>	06.08→	TW	<b>0 414 799 015</b>	<b>0 986 445 020</b>
						<b>0 414 799 024</b>	<b>F 00E 200 413</b>
							<b>0 986 445 022</b>
						<b>0 414 799 025</b>	<b>0 986 445 102</b>
						<b>0 414 799 035</b>	<b>0 986 445 025</b>
<b>4160</b> BlueTec [MP3]	15,9	440	OM 542.964 <502 LA Euro4/5>	06.08→	TW	<b>0 414 799 015</b>	<b>0 986 445 020</b>
						<b>0 414 799 024</b>	<b>F 00E 200 413</b>
							<b>0 986 445 022</b>
						<b>0 414 799 025</b>	<b>0 986 445 102</b>
						<b>0 414 799 035</b>	<b>0 986 445 025</b>





◀ MERCEDES-BENZ

<b>4165</b> Blue Tec [MP3]	15,9	480	OM 542.96... <OM 502 LA Euro 4/5>	08.08→	TW	<b>0 414 799 015</b> <b>0 414 799 024</b> <b>0 414 799 025</b> <b>0 414 799 035</b>	<b>0 986 445 020</b> <b>F 00E 200 413</b> <b>0 986 445 022</b> <b>0 986 445 102</b> <b>0 986 445 025</b>
<b>4440</b> B [MP3]	12,0	290	OM 541.923 <(501) LA Euro2> Komp.Nr. 505108/01 Komp.Nr. 505108/05	09.08→ 09.08→	TNK TNK	<b>0 414 799 025</b> <b>0 414 799 015</b>	<b>0 986 445 102</b> <b>0 986 445 020</b>
<b>Atego</b>							
<b>712</b> [LKN]	4,3	90	OM 904.909 LA <Euro2>; OM 904.915 LA <Euro 3>	01.98-09.04		<b>0 414 799 008</b>	<b>F 00E 200 403</b> <b>0 986 445 003</b>
<b>714</b> , L [LKN]	4,3	100	OM 904.910 LA <Euro2>; OM 904.916 LA <Euro 3>	01.98-09.04		<b>0 414 799 008</b>	<b>F 00E 200 403</b> <b>0 986 445 003</b>
<b>715</b> [LKN]	4,3	110	OM 904.950 LA <Euro 3> Komp.Nr. 505012/05 Komp.Nr. 505012/17	09.00-09.04 09.00-09.04	TNK TNK	<b>0 414 799 008</b> <b>0 414 799 029</b>	<b>F 00E 200 403</b> <b>0 986 445 003</b> <b>0 986 445 019</b>
, L [LKN]	4,3	112	OM 904.922 LA <Euro2> Komp.Nr. 505012/05	01.98-09.04	TNK	<b>0 414 799 008</b>	<b>F 00E 200 403</b> <b>0 986 445 003</b>
<b>717</b> , L [LKN]	4,3	125	OM 904.911 LA <Euro2>; OM 904.917 LA <Euro 3>	01.98-09.04		<b>0 414 799 008</b>	<b>F 00E 200 403</b> <b>0 986 445 003</b>
<b>812</b> [LKN]	4,3	90	OM 904.909 LA <Euro2>	01.98-10.04		<b>0 414 799 008</b>	<b>F 00E 200 403</b> <b>0 986 445 003</b>
<b>814</b> , L [LKN]	4,3	100	OM 904.910 LA <Euro2>; OM 904.916 LA <Euro 3>	01.98-09.04		<b>0 414 799 008</b>	<b>F 00E 200 403</b> <b>0 986 445 003</b>
<b>815</b> [LKN]	4,3	110	OM 904.950 LA <Euro 3> Komp.Nr. 505012/05 Komp.Nr. 505012/17	09.00-09.04 09.00-09.04	TNK TNK	<b>0 414 799 008</b> <b>0 414 799 029</b>	<b>F 00E 200 403</b> <b>0 986 445 003</b> <b>0 986 445 019</b>
, F, L [LKN]	4,3	112	OM 904.922 LA <Euro2> Komp.Nr. 505012/05	01.98-09.04	TNK	<b>0 414 799 008</b>	<b>F 00E 200 403</b> <b>0 986 445 003</b>
<b>817</b> , L [LKN]	4,3	125	OM 904.911 LA <Euro2>; OM 904.917 LA <Euro 3>	01.98-09.04		<b>0 414 799 008</b>	<b>F 00E 200 403</b> <b>0 986 445 003</b>
F [LKN]	4,3	112	OM 904.922 LA <Euro2> Komp.Nr. 505012/05	01.98-09.04	TNK	<b>0 414 799 008</b>	<b>F 00E 200 403</b> <b>0 986 445 003</b>
<b>818</b> [LKN]	4,3	130	OM 904.951 LA <Euro 3> Komp.Nr. 505012/05 Komp.Nr. 505012/17	09.00-09.04 09.00-09.04	TNK TNK	<b>0 414 799 008</b> <b>0 414 799 029</b>	<b>F 00E 200 403</b> <b>0 986 445 003</b> <b>0 986 445 019</b>
<b>823</b> [LKN]	6,4	170	OM 906.925 LA <Euro 3> Komp.Nr. 505012/14	09.00-09.04 09.00-09.04	TNK	<b>0 414 799 008</b> <b>0 414 799 029</b>	<b>F 00E 200 403</b> <b>0 986 445 003</b> <b>0 986 445 019</b>
, L [LKN]	6,4	170	OM 906.910 LA <Euro2>	01.98-09.04		<b>0 414 799 008</b>	<b>F 00E 200 403</b> <b>0 986 445 003</b>
<b>915</b> [LKN]	4,3	110	OM 904.950 LA <Euro 3> Komp.Nr. 505012/05 Komp.Nr. 505012/17	09.00-09.04 09.00-09.04	TNK TNK	<b>0 414 799 008</b> <b>0 414 799 029</b>	<b>F 00E 200 403</b> <b>0 986 445 003</b> <b>0 986 445 019</b>
<b>917</b> , AF, KO, L [LKN]	4,3	125-128	OM 904... <Euro 3>; OM 904.911 LA <Euro2>	01.98-09.04		<b>0 414 799 008</b>	<b>F 00E 200 403</b> <b>0 986 445 003</b>
<b>918</b> [LKN]	4,3	130	OM 904.951 LA <Euro 3> Komp.Nr. 505012/05 Komp.Nr. 505012/17	09.00-09.04 09.00-09.04	TNK TNK	<b>0 414 799 008</b> <b>0 414 799 029</b>	<b>F 00E 200 403</b> <b>0 986 445 003</b> <b>0 986 445 019</b>
<b>923</b> [LKN]	6,4	170	OM 906.925 LA <Euro 3> Komp.Nr. 505012/14	09.00-09.04 09.00-09.04	TNK	<b>0 414 799 008</b> <b>0 414 799 029</b>	<b>F 00E 200 403</b> <b>0 986 445 003</b> <b>0 986 445 019</b>
, L [LKN]	6,4	170	OM 906.910 LA <Euro2>	01.98-09.04		<b>0 414 799 008</b>	<b>F 00E 200 403</b> <b>0 986 445 003</b>





<b>925 AF</b> [LKN]	6,4	180	OM 906... <Euro 2/3>	01.98-09.04	<b>0 414 799 008</b>	<b>F 00E 200 403</b> <b>0 986 445 003</b>
<b>1015</b> [LKN]	4,3	110	OM 904.950 LA <Euro 3> Komp.Nr. 505012/05	09.00-09.04 TNK	<b>0 414 799 008</b>	<b>F 00E 200 403</b> <b>0 986 445 003</b>
			Komp.Nr. 505012/17	09.00-09.04 TNK	<b>0 414 799 029</b>	<b>0 986 445 019</b>
<b>1017</b>	4,3	125	OM 904.951 LA <Euro 3>	09.00→	<b>0 414 799 008</b>	<b>F 00E 200 403</b> <b>0 986 445 003</b>
, A, AK, KO, L [LKN]	4,3	125	OM 904.911 LA <Euro2>; OM 904.917 LA <Euro 3>	01.98-09.04	<b>0 414 799 008</b>	<b>F 00E 200 403</b> <b>0 986 445 003</b>
<b>1018</b> [LKN]	4,3	130	OM 904.951 LA <Euro 3> Komp.Nr. 505012/05	09.00-09.04 TNK	<b>0 414 799 008</b>	<b>F 00E 200 403</b> <b>0 986 445 003</b>
			Komp.Nr. 505012/17	09.00-09.04 TNK	<b>0 414 799 029</b>	<b>0 986 445 019</b>
<b>1023</b> [LKN]	6,4	170	OM 906.925 LA <Euro 3>	09.00-09.04	<b>0 414 799 008</b>	<b>F 00E 200 403</b> <b>0 986 445 003</b>
			Komp.Nr. 505012/14	09.00-09.04 TNK	<b>0 414 799 029</b>	<b>0 986 445 019</b>
, L [LKN]	6,4	170	OM 906.910 LA <Euro2>	01.98-09.04	<b>0 414 799 008</b>	<b>F 00E 200 403</b> <b>0 986 445 003</b>
<b>1214</b> , L [LKN]	4,3	100	OM 904.910 LA <Euro2>	01.98-09.04	<b>0 414 799 008</b>	<b>F 00E 200 403</b> <b>0 986 445 003</b>
<b>1215</b> [LKN]	4,3	110	OM 904.950 LA <Euro 3> Komp.Nr. 505012/05	09.00-09.04 TNK	<b>0 414 799 008</b>	<b>F 00E 200 403</b> <b>0 986 445 003</b>
			Komp.Nr. 505012/17	09.00-09.04 TNK	<b>0 414 799 029</b>	<b>0 986 445 019</b>
, L [LKN]	4,3	112	OM 904.922 LA <Euro2> Komp.Nr. 505012/05	01.98-09.04 TNK	<b>0 414 799 008</b>	<b>F 00E 200 403</b> <b>0 986 445 003</b>
<b>1216</b>	4,3	115	OM 900.912 LA <Euro 4/5>	09.04→	<b>0 414 799 008</b>	<b>F 00E 200 403</b> <b>0 986 445 003</b>
<b>1217</b> , KO, L [LKN]	4,3	125	OM 904.911 LA <Euro2>; OM 904.917 LA <Euro 3>	01.98-09.04	<b>0 414 799 008</b>	<b>F 00E 200 403</b> <b>0 986 445 003</b>
<b>1218</b> [LKN]	4,3	130	OM 904.951 LA <Euro 3> Komp.Nr. 505012/05	09.00-09.04 TNK	<b>0 414 799 008</b>	<b>F 00E 200 403</b> <b>0 986 445 003</b>
			Komp.Nr. 505012/17	09.00-09.04 TNK	<b>0 414 799 029</b>	<b>0 986 445 019</b>
<b>1223</b> [LKN]	6,4	170	OM 906.925 LA <Euro 3>	09.00-09.04	<b>0 414 799 008</b>	<b>F 00E 200 403</b> <b>0 986 445 003</b>
			Komp.Nr. 505012/14	09.00-09.04 TNK	<b>0 414 799 029</b>	<b>0 986 445 019</b>
, L [LKN]	6,4	170	OM 906.910 LA <Euro2>	01.98-09.04	<b>0 414 799 008</b>	<b>F 00E 200 403</b> <b>0 986 445 003</b>
<b>1225 AF</b> , F [LKN]	6,4	180	OM 906... <Euro 2/3>	01.98-09.04	<b>0 414 799 008</b>	<b>F 00E 200 403</b> <b>0 986 445 003</b>
<b>1228</b> [LKN]	6,4	205	OM 906.926 LA <Euro3>	09.00-10.04	<b>0 414 799 008</b>	<b>F 00E 200 403</b> <b>0 986 445 003</b>
			Komp.Nr. 505012/14	09.00-10.04 TNK	<b>0 414 799 029</b>	<b>0 986 445 019</b>
, L [LKN]	6,4	205	OM 906.911 LA <Euro2>	01.98-09.04	<b>0 414 799 008</b>	<b>F 00E 200 403</b> <b>0 986 445 003</b>
<b>1317</b> , A, AK, KO, L [LKN]	4,3	125	OM 904.911 LA <Euro2>; OM 904.917 LA <Euro 3>	01.98→	<b>0 414 799 008</b>	<b>F 00E 200 403</b> <b>0 986 445 003</b>
<b>1318</b> [LKN]	4,3	130	OM 904.951 LA <Euro 3> Komp.Nr. 505012/05	09.00-09.04 TNK	<b>0 414 799 008</b>	<b>F 00E 200 403</b> <b>0 986 445 003</b>
			Komp.Nr. 505012/17	09.00-09.04 TNK	<b>0 414 799 029</b>	<b>0 986 445 019</b>
<b>1323</b> , L, LKO [LKN]	6,4	170	OM 906.910 LA <Euro2>	01.98-09.04	<b>0 414 799 008</b>	<b>F 00E 200 403</b> <b>0 986 445 003</b>
<b>1325 AF</b> , F [LKN]	6,4	180	OM 906... <Euro 2/3>	01.98-09.04	<b>0 414 799 008</b>	<b>F 00E 200 403</b> <b>0 986 445 003</b>
<b>1328</b> [LKN]	6,4	205	OM 906.926 LA <Euro3>	09.00-09.04	<b>0 414 799 008</b>	<b>F 00E 200 403</b> <b>0 986 445 003</b>
			Komp.Nr. 505012/14	09.00-09.04 TNK	<b>0 414 799 029</b>	<b>0 986 445 019</b>
, AF, F, L [LKN]	6,4	205	OM 906.911 LA <Euro2>	01.98-09.04	<b>0 414 799 008</b>	<b>F 00E 200 403</b> <b>0 986 445 003</b>





◀ MERCEDES-BENZ

<b>1517</b> , L [LKN]	4,3	125	OM 904.911 LA <Euro2>; OM 904.917 LA <Euro 3>	01.98-09.04		<b>0 414 799 008</b>	<b>F 00E 200 403</b> <b>0 986 445 003</b>
<b>1518</b> [LKN]	4,3	130	OM 904.951 LA <Euro 3> Komp.Nr. 505012/05	09.00-09.04	TNK	<b>0 414 799 008</b>	<b>F 00E 200 403</b> <b>0 986 445 003</b>
			Komp.Nr. 505012/17	09.00-09.04	TNK	<b>0 414 799 029</b>	<b>0 986 445 019</b>
<b>1523</b> [LKN]	6,4	170	OM 906.925 LA <Euro 3>	09.00-10.04		<b>0 414 799 008</b>	<b>F 00E 200 403</b> <b>0 986 445 003</b>
			Komp.Nr. 505012/14	09.00-10.04	TNK	<b>0 414 799 029</b>	<b>0 986 445 019</b>
, A, AK, KO, L [LKN]	6,4	170	OM 906.910 LA <Euro2>	01.98-09.04		<b>0 414 799 008</b>	<b>F 00E 200 403</b> <b>0 986 445 003</b>
<b>1525AF</b> [LKN]	6,4	180	OM 906... <Euro 2/3>	01.98-09.04		<b>0 414 799 008</b>	<b>F 00E 200 403</b> <b>0 986 445 003</b>
<b>1528</b> [LKN]	6,4	205	OM 906.926 LA <Euro3>	09.00-09.04		<b>0 414 799 008</b>	<b>F 00E 200 403</b> <b>0 986 445 003</b>
			Komp.Nr. 505012/14	09.00-09.04	TNK	<b>0 414 799 029</b>	<b>0 986 445 019</b>
, AF, F, L [LKN]	6,4	205	OM 906.911 LA <Euro2>	01.98-09.04		<b>0 414 799 008</b>	<b>F 00E 200 403</b> <b>0 986 445 003</b>
<b>1823</b> [LKN]	6,4	170	OM 906.925 LA <Euro 3>	09.00-09.04		<b>0 414 799 008</b>	<b>F 00E 200 403</b> <b>0 986 445 003</b>
			Komp.Nr. 505012/14	09.00-09.04	TNK	<b>0 414 799 029</b>	<b>0 986 445 019</b>
, AK, K, L, LS [LKN]	6,4	170	OM 906.920 LA <Euro2>; OM 906.922 LA <Euro2> Komp.Nr. 505012/05/06	05.98-09.04	TNK	<b>0 414 799 008</b>	<b>F 00E 200 403</b> <b>0 986 445 003</b>
			Komp.Nr. 505012/14	05.98-09.04	TNK	<b>0 414 799 029</b>	<b>0 986 445 019</b>
<b>1828</b> [LKN]	6,4	205	OM 906.926 LA <Euro3>	09.00-09.04		<b>0 414 799 008</b>	<b>F 00E 200 403</b> <b>0 986 445 003</b>
			Komp.Nr. 505012/14	09.00-09.04	TNK	<b>0 414 799 029</b>	<b>0 986 445 019</b>
, A, AK, K, L, LS [LKN]	6,4	205	OM 906.921 LA <Euro2>; OM 906.923 LA <Euro2> Komp.Nr. 505012/05/06	05.98-09.04	TNK	<b>0 414 799 008</b>	<b>F 00E 200 403</b> <b>0 986 445 003</b>
			Komp.Nr. 505012/14	05.98-09.04	TNK	<b>0 414 799 029</b>	<b>0 986 445 019</b>
<b>1833</b> [LKN]	7,2	240	OM 926.913 LA <Euro3> Komp.Nr. 505012/05/06	09.00-09.04	TNK	<b>0 414 799 008</b>	<b>F 00E 200 403</b> <b>0 986 445 003</b>
			Komp.Nr. 505012/14	09.00-09.04	TNK	<b>0 414 799 029</b>	<b>0 986 445 019</b>
<b>2124C</b>	6,4	175	OM 902.916 <(906 LA) Euro 4>	09.04-→		<b>0 414 799 008</b>	<b>F 00E 200 403</b> <b>0 986 445 003</b>
<b>2523L</b> [LKN]	6,4	170	OM 906.920 LA <Euro2> Komp.Nr. 505012/05/06	05.98-09.04	TNK	<b>0 414 799 008</b>	<b>F 00E 200 403</b> <b>0 986 445 003</b>
			Komp.Nr. 505012/14	05.98-09.04	TNK	<b>0 414 799 029</b>	<b>0 986 445 019</b>
<b>2528</b> [LKN]	6,4	205	OM 906.926 LA <Euro3>	09.00-09.04		<b>0 414 799 008</b>	<b>F 00E 200 403</b> <b>0 986 445 003</b>
			Komp.Nr. 505012/14	09.00-09.04	TNK	<b>0 414 799 029</b>	<b>0 986 445 019</b>
L [LKN]	6,4	205	OM 906.921 LA <Euro2> Komp.Nr. 505012/05/06	05.98-09.04	TNK	<b>0 414 799 008</b>	<b>F 00E 200 403</b> <b>0 986 445 003</b>
			Komp.Nr. 505012/14	05.98-09.04	TNK	<b>0 414 799 029</b>	<b>0 986 445 019</b>
<b>2533</b> [LKN]	7,2	240	OM 926.913 LA <Euro3> Komp.Nr. 505012/05/06	09.00-09.04	TNK	<b>0 414 799 008</b>	<b>F 00E 200 403</b> <b>0 986 445 003</b>
			Komp.Nr. 505012/14	09.00-09.04	TNK	<b>0 414 799 029</b>	<b>0 986 445 019</b>
<b>2628</b> [LKN]	6,4	205	OM 906.926 LA <Euro3>	09.00-09.04		<b>0 414 799 008</b>	<b>F 00E 200 403</b> <b>0 986 445 003</b>
			Komp.Nr. 505012/14	09.00-09.04	TNK	<b>0 414 799 029</b>	<b>0 986 445 019</b>
, B, K [LKN]	6,4	205	OM 906.921 LA <Euro2> Komp.Nr. 505012/05/06	05.98-09.04	TNK	<b>0 414 799 008</b>	<b>F 00E 200 403</b> <b>0 986 445 003</b>
			Komp.Nr. 505012/14	05.98-09.04	TNK	<b>0 414 799 029</b>	<b>0 986 445 019</b>





<b>2633</b> [LKN]	7,2	240	OM 926.913 LA <Euro3> Komp.Nr. 505012/05/06	09.00-09.04	TNK	<b>0 414 799 008</b>	<b>F 00E 200 403</b> <b>0 986 445 003</b>
			Komp.Nr. 505012/14	09.00-09.04	TNK	<b>0 414 799 029</b>	<b>0 986 445 019</b>
<b>Atego II</b>							
<b>712</b>	4,3	90	OM 904.9... <Euro2>	10.04→		<b>0 414 799 008</b>	<b>F 00E 200 403</b> <b>0 986 445 003</b>
<b>713</b> BlueTec	4,3	95	OM 900.911 <(904 LA) Euro 4>	02.06→		<b>0 414 799 008</b>	<b>F 00E 200 403</b> <b>0 986 445 003</b>
<b>715</b>	4,3	112	OM 904.922 LA <Euro2>	10.04→		<b>0 414 799 008</b>	<b>F 00E 200 403</b> <b>0 986 445 003</b>
<b>716</b> BlueTec	4,3	115	OM 900... <Euro 4/5>	02.06→		<b>0 414 799 008</b>	<b>F 00E 200 403</b> <b>0 986 445 003</b>
<b>812</b>	4,3	90	OM 904.9... <Euro 3>	10.04→		<b>0 414 799 008</b>	<b>F 00E 200 403</b> <b>0 986 445 003</b>
<b>813</b> BlueTec	4,3	95	OM 900.911 <(904 LA) Euro 4>	02.06→		<b>0 414 799 008</b>	<b>F 00E 200 403</b> <b>0 986 445 003</b>
<b>815</b>	4,3	112	OM 904.922 LA <Euro2>	10.04→		<b>0 414 799 008</b>	<b>F 00E 200 403</b> <b>0 986 445 003</b>
<b>816</b> BlueTec	4,3	115	OM 900... <Euro 4/5>	02.06→		<b>0 414 799 008</b>	<b>F 00E 200 403</b> <b>0 986 445 003</b>
<b>818</b> , BlueTec	4,3	130	OM 900.913 <(904) Euro 4>; OM 904.917 LA <Euro 3>	09.04→		<b>0 414 799 008</b>	<b>F 00E 200 403</b> <b>0 986 445 003</b>
<b>822</b>	4,8	160	OM 924.920 <Euro 3>	09.04→		<b>0 414 799 008</b>	<b>F 00E 200 403</b> <b>0 986 445 003</b>
BlueTec	4,8	160	OM 924.922 LA <Euro 4>	06.06→		<b>0 414 799 012</b>	<b>0 986 445 017</b>
			OM 924.930 LA <Euro 5/EEV>	06.06→		<b>0 414 799 017</b>	<b>F 00E 200 412</b> <b>0 986 445 021</b>
<b>823</b>	6,4	170	OM 906.915 <Euro 3>	09.04→		<b>0 414 799 008</b>	<b>F 00E 200 403</b> <b>0 986 445 003</b>
<b>824</b> BlueTec	6,4	175	OM 902.916 <(906 LA) Euro 4>	02.06→		<b>0 414 799 008</b>	<b>F 00E 200 403</b> <b>0 986 445 003</b>
	7,2	175	OM 925.920 <(926 LA) EU 4/5/EEV>	10.10→	TW	<b>0 414 799 017</b>	<b>F 00E 200 412</b> <b>0 986 445 021</b>
						<b>0 414 799 038</b>	
<b>826</b> BlueTec	7,2	188	OM 925.920 <(926 LA) EU 4/5/EEV>	09.05→	TW	<b>0 414 799 017</b>	<b>F 00E 200 412</b> <b>0 986 445 021</b>
						<b>0 414 799 038</b>	
<b>829</b>	7,2	210	OM 925.920 <(926 LA) EU 4/5/EEV>	09.05→	TW	<b>0 414 799 017</b>	<b>F 00E 200 412</b> <b>0 986 445 021</b>
						<b>0 414 799 038</b>	
<b>915</b>	4,3	112	OM 904.922 LA <Euro2>	10.04→		<b>0 414 799 008</b>	<b>F 00E 200 403</b> <b>0 986 445 003</b>
<b>916</b> BlueTec	4,3	115	OM 900... <Euro 4/5>	02.06→		<b>0 414 799 008</b>	<b>F 00E 200 403</b> <b>0 986 445 003</b>
<b>918</b> BlueTec	4,3	130	OM 900.913 <(904) Euro 4>	02.06→		<b>0 414 799 008</b>	<b>F 00E 200 403</b> <b>0 986 445 003</b>
<b>922</b>	4,8	160	OM 924.920 <Euro 3>	09.04→		<b>0 414 799 008</b>	<b>F 00E 200 403</b> <b>0 986 445 003</b>
BlueTec	4,8	160	OM 924.922 LA <Euro 4>	06.06→		<b>0 414 799 012</b>	<b>0 986 445 017</b>
			OM 924.930 LA <Euro 5/EEV>	06.06→		<b>0 414 799 017</b>	<b>F 00E 200 412</b> <b>0 986 445 021</b>
<b>923</b>	6,4	170	OM 906.915 <Euro 3>	09.04→		<b>0 414 799 008</b>	<b>F 00E 200 403</b> <b>0 986 445 003</b>
<b>924</b> BlueTec	6,4	175	OM 902.916 <(906 LA) Euro 4>	02.06→		<b>0 414 799 008</b>	<b>F 00E 200 403</b> <b>0 986 445 003</b>
	7,2	175	OM 925.920 <(926 LA) EU 4/5/EEV>	09.05→	TW	<b>0 414 799 017</b>	<b>F 00E 200 412</b> <b>0 986 445 021</b>
						<b>0 414 799 038</b>	
<b>926</b> BlueTec	6,4	188	OM 902.917 <(906 LA) Euro 4>	02.06→		<b>0 414 799 008</b>	<b>F 00E 200 403</b> <b>0 986 445 003</b>







◀ MERCEDES-BENZ

<b>926</b> BlueTec	7,2	188	OM 925.920 <(926 LA) EU 4/5/EEV>	09.05→	TW	<b>0 414 799 017</b>	<b>F 00E 200 412</b> <b>0 986 445 021</b>
						<b>0 414 799 038</b>	
<b>929</b> BlueTec	7,2	210	OM 925.920 <(926 LA) EU 4/5/EEV>	09.05→	TW	<b>0 414 799 017</b>	<b>F 00E 200 412</b> <b>0 986 445 021</b>
						<b>0 414 799 038</b>	
<b>1015</b>	4,3	112	OM 904.922 LA <Euro2>	10.04→		<b>0 414 799 008</b>	<b>F 00E 200 403</b> <b>0 986 445 003</b>
<b>1016</b> BlueTec	4,3	115	OM 900... <Euro 4/5>	02.06→		<b>0 414 799 008</b>	<b>F 00E 200 403</b> <b>0 986 445 003</b>
<b>1017</b>	4,3	125	OM 904.91... <Euro 3>	10.04→		<b>0 414 799 008</b>	<b>F 00E 200 403</b> <b>0 986 445 003</b>
<b>1018</b> BlueTec	4,3	130	OM 900.913 <(904) Euro 4>	02.06→		<b>0 414 799 008</b>	<b>F 00E 200 403</b> <b>0 986 445 003</b>
<b>1022</b>	4,8	160	OM 924.920 <Euro 3>	09.04→		<b>0 414 799 008</b>	<b>F 00E 200 403</b> <b>0 986 445 003</b>
BlueTec	4,8	160	OM 924.922 LA <Euro 4>	06.06→		<b>0 414 799 012</b>	<b>0 986 445 017</b>
			OM 924.930 LA <Euro 5/EEV>	06.06→		<b>0 414 799 017</b>	<b>F 00E 200 412</b> <b>0 986 445 021</b>
<b>1023</b>	6,4	170	OM 906.915 <Euro 3>	09.04→		<b>0 414 799 008</b>	<b>F 00E 200 403</b> <b>0 986 445 003</b>
<b>1024</b> BlueTec	6,4	175	OM 902.916 <(906 LA) Euro 4>	02.06→		<b>0 414 799 008</b>	<b>F 00E 200 403</b> <b>0 986 445 003</b>
	7,2	175	OM 925.920 <(926 LA) EU 4/5/EEV>	09.05→	TW	<b>0 414 799 017</b>	<b>F 00E 200 412</b> <b>0 986 445 021</b>
						<b>0 414 799 038</b>	
<b>1026</b> BlueTec	6,4	188	OM 902.917 <(906 LA) Euro 4>	09.05→		<b>0 414 799 008</b>	<b>F 00E 200 403</b> <b>0 986 445 003</b>
	7,2	188	OM 925.920 <(926 LA) EU 4/5/EEV>	09.05→	TW	<b>0 414 799 017</b>	<b>F 00E 200 412</b> <b>0 986 445 021</b>
						<b>0 414 799 038</b>	
<b>1029</b> BlueTec	7,2	210	OM 925.920 <(926 LA) EU 4/5/EEV>	09.05→	TW	<b>0 414 799 017</b>	<b>F 00E 200 412</b> <b>0 986 445 021</b>
						<b>0 414 799 038</b>	
<b>1215</b>	4,3	112	OM 904.922 LA <Euro2>	10.04→		<b>0 414 799 008</b>	<b>F 00E 200 403</b> <b>0 986 445 003</b>
<b>1216</b> BlueTec	4,3	115	OM 900... <Euro 4/5>	02.06→		<b>0 414 799 008</b>	<b>F 00E 200 403</b> <b>0 986 445 003</b>
<b>1218</b> BlueTec	4,3	130	OM 900.913 <(904) Euro 4>	02.06→		<b>0 414 799 008</b>	<b>F 00E 200 403</b> <b>0 986 445 003</b>
<b>1222</b>	4,8	160	OM 924.920 <Euro 3>	09.04→		<b>0 414 799 008</b>	<b>F 00E 200 403</b> <b>0 986 445 003</b>
BlueTec	4,8	160	OM 924.922 LA <Euro 4>	06.06→		<b>0 414 799 012</b>	<b>0 986 445 017</b>
			OM 924.930 LA <Euro 5/EEV>	06.06→		<b>0 414 799 017</b>	<b>F 00E 200 412</b> <b>0 986 445 021</b>
<b>1223</b>	6,4	170	OM 906.915 <Euro 3>	09.04→		<b>0 414 799 008</b>	<b>F 00E 200 403</b> <b>0 986 445 003</b>
<b>1224</b> BlueTec	6,4	175	OM 902.916 <(906 LA) Euro 4>	02.06→		<b>0 414 799 008</b>	<b>F 00E 200 403</b> <b>0 986 445 003</b>
	7,2	175	OM 925.920 <(926 LA) EU 4/5/EEV>	03.10→	TW	<b>0 414 799 017</b>	<b>F 00E 200 412</b> <b>0 986 445 021</b>
						<b>0 414 799 038</b>	
<b>1226</b> BlueTec	6,4	188	OM 902.917 <(906 LA) Euro 4>	02.06→		<b>0 414 799 008</b>	<b>F 00E 200 403</b> <b>0 986 445 003</b>
	7,2	188	OM 925.920 <(926 LA) EU 4/5/EEV>	03.10→	TW	<b>0 414 799 017</b>	<b>F 00E 200 412</b> <b>0 986 445 021</b>
						<b>0 414 799 038</b>	
<b>1228</b>	6,4	205	OM 906.916 <(906) Euro 3>	09.04→		<b>0 414 799 008</b>	<b>F 00E 200 403</b> <b>0 986 445 003</b>
<b>1229</b>	6,4	210	OM 902.918 <(906 LA) Euro 4>	02.06→		<b>0 414 799 008</b>	<b>F 00E 200 403</b> <b>0 986 445 003</b>





<b>1229</b> BlueTec	7,2	210	OM 925.920 <(926 LA) EU 4/5/EEV>	03.10→	TW	<b>0 414 799 017</b>	<b>F 00E 200 412</b> <b>0 986 445 021</b>
						<b>0 414 799 038</b>	
<b>1317</b>	4,3	125	OM 904.91... <Euro 3>	10.04→		<b>0 414 799 008</b>	<b>F 00E 200 403</b> <b>0 986 445 003</b>
<b>1318</b> BlueTec	4,3	130	OM 900.913 <(904) Euro 4>	02.06→		<b>0 414 799 008</b>	<b>F 00E 200 403</b> <b>0 986 445 003</b>
<b>1322</b>	4,8	160	OM 924.920 <Euro 3>	09.04→		<b>0 414 799 008</b>	<b>F 00E 200 403</b> <b>0 986 445 003</b>
BlueTec	4,8	160	OM 924.922 LA <Euro 4>	06.06→		<b>0 414 799 012</b>	<b>0 986 445 017</b>
			OM 924.930 LA <Euro 5/EEV>	06.06→		<b>0 414 799 017</b>	<b>F 00E 200 412</b> <b>0 986 445 021</b>
<b>1323</b>	6,4	170	OM 906.915 <Euro 3>	09.04→		<b>0 414 799 008</b>	<b>F 00E 200 403</b> <b>0 986 445 003</b>
<b>1324</b> BlueTec	6,4	175	OM 902.916 <(906 LA) Euro 4>	02.06→		<b>0 414 799 008</b>	<b>F 00E 200 403</b> <b>0 986 445 003</b>
	7,2	175	OM 925.920 <(926 LA) EU 4/5/EEV>	03.10→	TW	<b>0 414 799 017</b>	<b>F 00E 200 412</b> <b>0 986 445 021</b>
						<b>0 414 799 038</b>	
<b>1326</b> BlueTec	6,4	188	OM 902.917 <(906 LA) Euro 4>	02.06→		<b>0 414 799 008</b>	<b>F 00E 200 403</b> <b>0 986 445 003</b>
	7,2	188	OM 925.920 <(926 LA) EU 4/5/EEV>	03.10→	TW	<b>0 414 799 017</b>	<b>F 00E 200 412</b> <b>0 986 445 021</b>
						<b>0 414 799 038</b>	
<b>1328</b>	6,4	205	OM 906.916 <(906) Euro 3>	09.04→		<b>0 414 799 008</b>	<b>F 00E 200 403</b> <b>0 986 445 003</b>
<b>1329</b>	6,4	210	OM 902.918 <(906 LA) Euro 4>	02.06→		<b>0 414 799 008</b>	<b>F 00E 200 403</b> <b>0 986 445 003</b>
BlueTec	7,2	210	OM 925.920 <(926 LA) EU 4/5/EEV>	03.10→	TW	<b>0 414 799 017</b>	<b>F 00E 200 412</b> <b>0 986 445 021</b>
						<b>0 414 799 038</b>	
<b>1422</b> F BlueTec	4,8	160	OM 924.930 LA <Euro 5/EEV>	03.10→		<b>0 414 799 017</b>	<b>F 00E 200 412</b> <b>0 986 445 021</b>
<b>1425</b> F	6,4	180	OM 906.939 LA <Euro 2/3>	10.04→		<b>0 414 799 008</b>	<b>F 00E 200 403</b> <b>0 986 445 003</b>
<b>1426</b> F BlueTec	6,4	188	OM 902.917 <(906 LA) Euro 4>	03.10→		<b>0 414 799 008</b>	<b>F 00E 200 403</b> <b>0 986 445 003</b>
	7,2	188	OM 925.920 <(926 LA) EU 4/5/EEV>	03.10→	TW	<b>0 414 799 017</b>	<b>F 00E 200 412</b> <b>0 986 445 021</b>
						<b>0 414 799 038</b>	
<b>1428</b> F	6,4	205	OM 906.916 <(906) Euro 3>	10.04→		<b>0 414 799 008</b>	<b>F 00E 200 403</b> <b>0 986 445 003</b>
<b>1429</b> F	6,4	210	OM 902.918 <(906 LA) Euro 4>	03.10→		<b>0 414 799 008</b>	<b>F 00E 200 403</b> <b>0 986 445 003</b>
F BlueTec	7,2	210	OM 925.920 <(926 LA) EU 4/5/EEV>	03.10→	TW	<b>0 414 799 017</b>	<b>F 00E 200 412</b> <b>0 986 445 021</b>
						<b>0 414 799 038</b>	
<b>1518</b> BlueTec	4,3	130	OM 900.913 <(904) Euro 4>	02.06→		<b>0 414 799 008</b>	<b>F 00E 200 403</b> <b>0 986 445 003</b>
<b>1522</b>	4,8	160	OM 924.920 <Euro 3>	09.04→		<b>0 414 799 008</b>	<b>F 00E 200 403</b> <b>0 986 445 003</b>
BlueTec	4,8	160	OM 924.922 LA <Euro 4>	06.06→		<b>0 414 799 012</b>	<b>0 986 445 017</b>
			OM 924.930 LA <Euro 5/EEV>	06.06→		<b>0 414 799 017</b>	<b>F 00E 200 412</b> <b>0 986 445 021</b>
<b>1523</b>	6,4	170	OM 906.915 <Euro 3>	09.04→		<b>0 414 799 008</b>	<b>F 00E 200 403</b> <b>0 986 445 003</b>
<b>1524</b> BlueTec	6,4	175	OM 902.916 <(906 LA) Euro 4>	02.06→		<b>0 414 799 008</b>	<b>F 00E 200 403</b> <b>0 986 445 003</b>
	7,2	175	OM 925.920 <(926 LA) EU 4/5/EEV>	03.10→	TW	<b>0 414 799 017</b>	<b>F 00E 200 412</b> <b>0 986 445 021</b>
						<b>0 414 799 038</b>	
<b>1526</b> BlueTec	6,4	188	OM 902.917 <(906 LA) Euro 4>	02.06→		<b>0 414 799 008</b>	<b>F 00E 200 403</b> <b>0 986 445 003</b>





◀ MERCEDES-BENZ

<b>1526</b> BlueTec	7,2	188	OM 925.920 <(926 LA) EU 4/5/EEV>	03.10→	TW	<b>0 414 799 017</b>	<b>F 00E 200 412</b> <b>0 986 445 021</b>
						<b>0 414 799 038</b>	
<b>1528</b>	6,4	205	OM 906.916 <(906) Euro 3>	09.04→		<b>0 414 799 008</b>	<b>F 00E 200 403</b> <b>0 986 445 003</b>
<b>1529</b>	6,4	210	OM 902.918 <(906 LA) Euro 4>	02.06→		<b>0 414 799 008</b>	<b>F 00E 200 403</b> <b>0 986 445 003</b>
BlueTec	7,2	210	OM 925.920 <(926 LA) EU 4/5/EEV>	03.10→	TW	<b>0 414 799 017</b>	<b>F 00E 200 412</b> <b>0 986 445 021</b>
						<b>0 414 799 038</b>	
<b>1924</b> L BlueTec	6,4	175	OM 902.916 <(906 LA) Euro 4>	10.04→		<b>0 414 799 008</b>	<b>F 00E 200 403</b> <b>0 986 445 003</b>
<b>1926</b> L BlueTec	6,4	188	OM 902.917 <(906 LA) Euro 4>	10.04→		<b>0 414 799 008</b>	<b>F 00E 200 403</b> <b>0 986 445 003</b>
<b>1929</b> L BlueTec	6,4	210	OM 902.918 <(906 LA) Euro 4>	10.04→		<b>0 414 799 008</b>	<b>F 00E 200 403</b> <b>0 986 445 003</b>
<b>2224</b> L BlueTec	6,4	175	OM 902.916 <(906 LA) Euro 4>	10.04→		<b>0 414 799 008</b>	<b>F 00E 200 403</b> <b>0 986 445 003</b>
<b>2226</b> L BlueTec	6,4	210	OM 902.917 <(906 LA) Euro 4>	10.04→		<b>0 414 799 008</b>	<b>F 00E 200 403</b> <b>0 986 445 003</b>
<b>2229</b> L BlueTec	6,4	188	OM 902.918 <(906 LA) Euro 4>	10.04→		<b>0 414 799 008</b>	<b>F 00E 200 403</b> <b>0 986 445 003</b>
<b>Axor</b>							
<b>1823</b>	6,4	170	OM 906... <Euro2> Komp.Nr. 505012/05/06	01.02-08.06	TNK	<b>0 414 799 008</b>	<b>F 00E 200 403</b> <b>0 986 445 003</b>
			Komp.Nr. 505012/14	01.02-08.06	TNK	<b>0 414 799 029</b>	<b>0 986 445 019</b>
<b>1828</b>	6,4	205	OM 906... <Euro2> Komp.Nr. 505012/05/06	01.02-08.06	TNK	<b>0 414 799 008</b>	<b>F 00E 200 403</b> <b>0 986 445 003</b>
			Komp.Nr. 505012/14	01.02-08.06	TNK	<b>0 414 799 029</b>	<b>0 986 445 019</b>
<b>1835</b> LS	12,0	260	OM 457.937 LA Komp.Nr. 505108/03/04	01.02-08.06	TNK	<b>0 414 799 026</b>	<b>0 986 445 016</b>
			Komp.Nr. 505108/01	01.02-08.06	TNK	<b>0 414 799 025</b>	<b>0 986 445 102</b>
			Komp.Nr. 505108/05/06	01.02-08.06	TNK	<b>0 414 799 015</b>	<b>0 986 445 020</b>
<b>1840</b> LS	12,0	295	OM 457.937 LA Komp.Nr. 505108/03/04	01.02-08.06	TNK	<b>0 414 799 026</b>	<b>0 986 445 016</b>
			Komp.Nr. 505108/01	01.02-08.06	TNK	<b>0 414 799 025</b>	<b>0 986 445 102</b>
			Komp.Nr. 505108/05/06	01.02-08.06	TNK	<b>0 414 799 015</b>	<b>0 986 445 020</b>
<b>1843</b> LS	12,0	315	OM 457.937 LA Komp.Nr. 505108/03/04	01.02-08.06	TNK	<b>0 414 799 026</b>	<b>0 986 445 016</b>
			Komp.Nr. 505108/01	01.02-08.06	TNK	<b>0 414 799 025</b>	<b>0 986 445 102</b>
			Komp.Nr. 505108/05/06	01.02-08.06	TNK	<b>0 414 799 015</b>	<b>0 986 445 020</b>
<b>2523</b>	6,4	170	OM 906.920 LA <Euro2> Komp.Nr. 505012/05/06	01.02-08.06	TNK	<b>0 414 799 008</b>	<b>F 00E 200 403</b> <b>0 986 445 003</b>
			Komp.Nr. 505012/14	01.02-08.06	TNK	<b>0 414 799 029</b>	<b>0 986 445 019</b>
<b>2528</b>	6,4	205	OM 906.921 LA <Euro2> Komp.Nr. 505012/05/06	01.02-08.06	TNK	<b>0 414 799 008</b>	<b>F 00E 200 403</b> <b>0 986 445 003</b>
			Komp.Nr. 505012/14	01.02-08.06	TNK	<b>0 414 799 029</b>	<b>0 986 445 019</b>
<b>2535</b> LS	12,0	260	OM 457.937 LA Komp.Nr. 505108/03/04	01.02-08.06	TNK	<b>0 414 799 026</b>	<b>0 986 445 016</b>
			Komp.Nr. 505108/01	01.02-08.06	TNK	<b>0 414 799 025</b>	<b>0 986 445 102</b>
			Komp.Nr. 505108/05/06	01.02-08.06	TNK	<b>0 414 799 015</b>	<b>0 986 445 020</b>
<b>2540</b> LS	12,0	295	OM 457.937 LA Komp.Nr. 505108/03/04	01.02-08.06	TNK	<b>0 414 799 026</b>	<b>0 986 445 016</b>
			Komp.Nr. 505108/01	01.02-08.06	TNK	<b>0 414 799 025</b>	<b>0 986 445 102</b>
			Komp.Nr. 505108/05/06	01.02-08.06	TNK	<b>0 414 799 015</b>	<b>0 986 445 020</b>
<b>2543</b> LS	12,0	315	OM 457.937 LA Komp.Nr. 505108/03/04	01.02-08.06	TNK	<b>0 414 799 026</b>	<b>0 986 445 016</b>
			Komp.Nr. 505108/01	01.02-08.06	TNK	<b>0 414 799 025</b>	<b>0 986 445 102</b>
			Komp.Nr. 505108/05/06	01.02-08.06	TNK	<b>0 414 799 015</b>	<b>0 986 445 020</b>





2628	6,4	205	OM 906.921 LA <Euro2>	01.02-08.06	TNK	0 414 799 008	F 00E 200 403			
			Komp.Nr. 505012/05/06				0 986 445 003			
			Komp.Nr. 505012/14	01.02-08.06	TNK	0 414 799 029	0 986 445 019			
3028	6,4	205	OM 906.921 <OM 906 LA>	03.03→	TNK	0 414 799 008	F 00E 200 403			
			Komp.Nr. 505012/06				0 986 445 003			
			Komp.Nr. 505012/14	03.03→	TNK	0 414 799 029	0 986 445 019			
<b>Axor II</b>										
1824	6,4	175	OM 902.9... <(906 LA) Euro 4>	09.06→		0 414 799 008	F 00E 200 403			
							0 986 445 003			
1826	6,4	188	OM 902.9... <(906 LA) Euro 4>	09.06→		0 414 799 008	F 00E 200 403			
							0 986 445 003			
1829	6,4	210	OM 902.915 (OM 906) <Euro 4 (BlueTec)>	09.06→		0 414 799 008	F 00E 200 403			
							0 986 445 003			
1833	7,2	240	OM 926... <Euro3>	09.04-08.06	TNK	0 414 799 008	F 00E 200 403			
			Komp.Nr. 505012/05/06				0 986 445 003			
			Komp.Nr. 505012/14				09.04-08.06	TNK	0 414 799 029	0 986 445 019
			OM 926.919 LA <Euro 4 (BlueTec)>				09.06→		0 414 799 012	0 986 445 017
			OM 926.945 LA <Euro 5/EEV (BlueTec)>				12.09→	TNK	0 414 799 017	F 00E 200 412
			Komp.Nr. 505012/ 13							0 986 445 021
			Komp.Nr. 505012/ 22				12.09→	TNK	0 414 799 028	0 986 445 018
			Komp.Nr. 505012/06				12.09→	TNK	0 414 799 008	F 00E 200 403
										0 986 445 003
			Komp.Nr. 505012/14				12.09→	TNK	0 414 799 029	0 986 445 019
Komp.Nr. 505012/16	12.09→	TNK	0 414 799 012	0 986 445 017						
Komp.Nr. 505012/21	12.09→	TNK	0 414 799 033	0 986 445 023						
1836	12,0	265	OM 457.948 LA <Euro 4/5 (BlueTec)>	09.06→	TW	0 414 799 015	0 986 445 020			
							0 414 799 025	0 986 445 102		
1840	12,0	295	OM 457.948 LA <Euro 4/5 (BlueTec)>	09.06→	TW	0 414 799 015	0 986 445 020			
						0 414 799 025	0 986 445 102			
1843	12,0	315	OM 457.948 LA <Euro 4/5 (BlueTec)>	09.06→	TW	0 414 799 015	0 986 445 020			
						0 414 799 025	0 986 445 102			
2529	6,4	210	OM 902.915 (OM 906) <Euro 4 (BlueTec)>	09.06→		0 414 799 008	F 00E 200 403			
							0 986 445 003			
2533	7,2	240	OM 926.913 LA <Euro3>	09.04-08.06	TNK	0 414 799 008	F 00E 200 403			
			Komp.Nr. 505012/05/06				0 986 445 003			
			Komp.Nr. 505012/14				09.04-08.06	TNK	0 414 799 029	0 986 445 019
			OM 926.919 LA <Euro 4 (BlueTec)>				09.06→		0 414 799 012	0 986 445 017
			OM 926.945 LA <Euro 5/EEV (BlueTec)>				12.09→	TNK	0 414 799 017	F 00E 200 412
			Komp.Nr. 505012/ 13							0 986 445 021
			Komp.Nr. 505012/ 22				12.09→	TNK	0 414 799 028	0 986 445 018
			Komp.Nr. 505012/06				12.09→	TNK	0 414 799 008	F 00E 200 403
										0 986 445 003
			Komp.Nr. 505012/14				12.09→	TNK	0 414 799 029	0 986 445 019
Komp.Nr. 505012/16	12.09→	TNK	0 414 799 012	0 986 445 017						
Komp.Nr. 505012/21	12.09→	TNK	0 414 799 033	0 986 445 023						
2536	12,0	265	OM 457.948 LA <Euro 4/5 (BlueTec)>	09.06→	TW	0 414 799 015	0 986 445 020			
							0 414 799 025	0 986 445 102		
2540	12,0	295	OM 457.948 LA <Euro 4/5 (BlueTec)>	09.06→	TW	0 414 799 015	0 986 445 020			
						0 414 799 025	0 986 445 102			
2543	12,0	315	OM 457.948 LA <Euro 4/5 (BlueTec)>	09.06→	TW	0 414 799 015	0 986 445 020			
						0 414 799 025	0 986 445 102			
2623 L	6,4	170	OM 906.92... <Euro2>	09.05→	TNK	0 414 799 008	F 00E 200 403			
			Komp.Nr. 505012/06				0 986 445 003			
			Komp.Nr. 505012/14	09.05→	TNK	0 414 799 029	0 986 445 019			
2629	6,4	210	OM 902.915 (OM 906) <Euro 4 (BlueTec)>	09.06→		0 414 799 008	F 00E 200 403			
							0 986 445 003			





◀ MERCEDES-BENZ

<b>2633</b>	7,2	240	OM 926.913 LA <Euro3>	09.04-08.06	TNK	<b>0 414 799 008</b>	<b>F 00E 200 403</b>	
			Komp.Nr. 505012/05/06				<b>0 986 445 003</b>	
				Komp.Nr. 505012/14	09.04-08.06	TNK	<b>0 414 799 029</b>	<b>0 986 445 019</b>
				OM 926.919 LA <Euro 4 (BlueTec)>	09.06→		<b>0 414 799 012</b>	<b>0 986 445 017</b>
				OM 926.945 LA <Euro 5/EEV (BlueTec)>				
				Komp.Nr. 505012/ 13	12.09→	TNK	<b>0 414 799 017</b>	<b>F 00E 200 412</b>
								<b>0 986 445 021</b>
				Komp.Nr. 505012/ 22	12.09→	TNK	<b>0 414 799 028</b>	<b>0 986 445 018</b>
				Komp.Nr. 505012/06	12.09→	TNK	<b>0 414 799 008</b>	<b>F 00E 200 403</b>
								<b>0 986 445 003</b>
			Komp.Nr. 505012/14	12.09→	TNK	<b>0 414 799 029</b>	<b>0 986 445 019</b>	
			Komp.Nr. 505012/16	12.09→	TNK	<b>0 414 799 012</b>	<b>0 986 445 017</b>	
			Komp.Nr. 505012/21	12.09→	TNK	<b>0 414 799 033</b>	<b>0 986 445 023</b>	
<b>2635</b>	12,0	260	OM 457.956 <(457 LA) Euro 3>	09.04→	TW	<b>0 414 799 015</b>	<b>0 986 445 020</b>	
						<b>0 414 799 025</b>	<b>0 986 445 102</b>	
<b>2636</b>	12,0	265	OM 457... <Euro 4/5 (BlueTec)>	09.06→	TW	<b>0 414 799 015</b>	<b>0 986 445 020</b>	
						<b>0 414 799 025</b>	<b>0 986 445 102</b>	
<b>2640</b>	12,0	295	OM 457... <Euro 4/5 (BlueTec)>	09.06→	TW	<b>0 414 799 015</b>	<b>0 986 445 020</b>	
						<b>0 414 799 025</b>	<b>0 986 445 102</b>	
<b>2643</b>	12,0	315	OM 457... <Euro 4/5 (BlueTec)>	09.06→	TW	<b>0 414 799 015</b>	<b>0 986 445 020</b>	
						<b>0 414 799 025</b>	<b>0 986 445 102</b>	
<b>3229</b>	6,4	210	OM 902.915 (OM 906) <Euro 4 (BlueTec)>	09.05→		<b>0 414 799 008</b>	<b>F 00E 200 403</b>	
							<b>0 986 445 003</b>	
<b>3236</b>	12,0	265	OM 457... <Euro 4/5 (BlueTec)>	09.06→	TW	<b>0 414 799 015</b>	<b>0 986 445 020</b>	
						<b>0 414 799 025</b>	<b>0 986 445 102</b>	
<b>3240</b>	12,0	295	OM 457... <Euro 4/5 (BlueTec)>	09.06→	TW	<b>0 414 799 015</b>	<b>0 986 445 020</b>	
						<b>0 414 799 025</b>	<b>0 986 445 102</b>	
<b>3243</b>	12,0	315	OM 457... <Euro 4/5 (BlueTec)>	09.06→	TW	<b>0 414 799 015</b>	<b>0 986 445 020</b>	
						<b>0 414 799 025</b>	<b>0 986 445 102</b>	
<b>3335</b>	12,0	260	OM 457.956 LA <Euro 3>	09.04→	TW	<b>0 414 799 015</b>	<b>0 986 445 020</b>	
						<b>0 414 799 025</b>	<b>0 986 445 102</b>	
<b>3340</b>	12,0	295	OM 457.956 LA <Euro 3>	09.04→	TW	<b>0 414 799 015</b>	<b>0 986 445 020</b>	
						<b>0 414 799 025</b>	<b>0 986 445 102</b>	
<b>3343</b>	12,0	315	OM 457.956 LA <Euro 3>	09.04→	TW	<b>0 414 799 015</b>	<b>0 986 445 020</b>	
						<b>0 414 799 025</b>	<b>0 986 445 102</b>	
<b>4135</b>	12,0	260	OM 457.956 <(457 LA) Euro 3>	09.04→	TW	<b>0 414 799 015</b>	<b>0 986 445 020</b>	
						<b>0 414 799 025</b>	<b>0 986 445 102</b>	
<b>4140</b>	12,0	295	OM 457.956 <(457 LA) Euro 3>; OM 457.957 <Euro 4/5 (BlueTec)>	09.04→	TW	<b>0 414 799 015</b>	<b>0 986 445 020</b>	
						<b>0 414 799 025</b>	<b>0 986 445 102</b>	
<b>4143</b>	12,0	315	OM 457.956 <(457 LA) Euro 3>; OM 457.957 <Euro 4/5 (BlueTec)>	09.04→	TW	<b>0 414 799 015</b>	<b>0 986 445 020</b>	
						<b>0 414 799 025</b>	<b>0 986 445 102</b>	
<b>Citaro</b>								
<b>0 530</b>	6,4	210	OM 902... <(906 HLA)>	11.11→	TW	<b>0 414 799 008</b>	<b>F 00E 200 403</b>	
							<b>0 986 445 003</b>	
							<b>0 414 799 029</b>	<b>0 986 445 019</b>
				OM 926... <Euro 4/5>				
				Mot.-Typ 926.939	10.06→	TW	<b>0 414 799 008</b>	<b>F 00E 200 403</b>
								<b>0 986 445 003</b>
							<b>0 414 799 012</b>	<b>0 986 445 017</b>
							<b>0 414 799 029</b>	<b>0 986 445 019</b>
							<b>0 414 799 033</b>	<b>0 986 445 023</b>
				Mot.-Typ 926.949	10.06→	TW	<b>0 414 799 017</b>	<b>F 00E 200 412</b>
							<b>0 986 445 021</b>	
						<b>0 414 799 028</b>	<b>0 986 445 018</b>	
	12,0	220	OM 457.9... <Euro 4/5 (BlueTec)>					
			Mot.-Typ 457.950 Mot.-Typ 457.959	11.11→	TW	<b>0 414 799 015</b>	<b>0 986 445 020</b>	
						<b>0 414 799 025</b>	<b>0 986 445 102</b>	





<b>0 530 , G</b>	12,0	260	OM 457.9... <Euro 4/5 (BlueTec)> Mot.-Typ 457.951	10.06→	TW	<b>0 414 799 025</b>	<b>0 986 445 102</b>
			Mot.-Typ 457.951 Mot.-Typ 457.967	10.06→	TW	<b>0 414 799 015</b>	<b>0 986 445 020</b>
			Mot.-Typ 457.975	10.06→	TW	<b>0 414 799 024</b>	<b>F 00E 200 413</b>
							<b>0 986 445 022</b>
						<b>0 414 799 035</b>	<b>0 986 445 025</b>
, G, G/GÜ, GL CapaCity, GUE, L, Low Entry UE, MUE, UE	12,0	220-260	OM 457.9... <Euro 4/5 (BlueTec)> Mot.-Typ 457.973	10.06→		<b>0 414 799 035</b>	<b>0 986 445 025</b>
, G, GL CapaCity, GUE, L, Low Entry UE, MUE, UE	12,0	220-260	OM 457.9... <Euro 4/5 (BlueTec)> Mot.-Typ 457.950,959	10.06→	TW	<b>0 414 799 015</b>	<b>0 986 445 020</b>
						<b>0 414 799 025</b>	<b>0 986 445 102</b>
, K, Low Entry MUE, UE	6,4	210	OM 902.9... <(906 HLA)>; OM 902.925 LA(906) <Euro 4 (BlueTec)> Komp.Nr. 505012/06	10.06→	TNK	<b>0 414 799 008</b>	<b>F 00E 200 403</b>
			Komp.Nr. 505012/14	10.06→	TNK	<b>0 414 799 029</b>	<b>0 986 445 019</b>
G/GÜ	12,0	220-260	OM 457.9... <Euro 4/5 (BlueTec)> Mot.-Typ 457.950 Mot.-Typ 457.959	11.11→	TW	<b>0 414 799 015</b>	<b>0 986 445 020</b>
						<b>0 414 799 025</b>	<b>0 986 445 102</b>
GNUE3, GN3, GN3 UESTRA, N3	12,0	185/220/ 260	OM 457.933 HLA <Euro 2>; OM 457.934 HLA <Euro 2>; OM 457.935 HLA <Euro 2> Komp.Nr. 505108/05	01.98-09.04	TNK	<b>0 414 799 015</b>	<b>0 986 445 020</b>
			Komp.Nr. 522020/01 Komp.Nr. 505108/01	01.98-09.04	TNK	<b>0 414 799 025</b>	<b>0 986 445 102</b>
GNUE3, GN3, GN3 UESTRA, N3, N3 UESTRA, N3/NUE3	6,4	170/180/ 205	OM 906.961 <Euro 3>; OM 906.962 <Euro 3>; OM 906.963 HLA <Euro 3>; OM 909... <Euro 2>; OM 909.901 LA <Euro 2> Komp.Nr. 505012/05	01.99-09.06	TNK	<b>0 414 799 008</b>	<b>F 00E 200 403</b>
			Komp.Nr. 505012/06				<b>0 986 445 003</b>
			Komp.Nr. 505012/09				
			Komp.Nr. 505012/14	01.99-09.06	TNK	<b>0 414 799 029</b>	<b>0 986 445 019</b>
GNUE3, GN3, N3/NUE3	0,0	205	OM 909.921 LA <Euro 2> Komp.Nr. 505012/05	01.99-09.04	TNK	<b>0 414 799 008</b>	<b>F 00E 200 403</b>
			Komp.Nr. 505012/06				<b>0 986 445 003</b>
			Komp.Nr. 505012/09				
			Komp.Nr. 505012/14	01.99-09.04	TNK	<b>0 414 799 029</b>	<b>0 986 445 019</b>
GN3, NUE3, N3	6,4	205	OM 906.960 LA <Euro 3> Komp.Nr. 505012/05/06	04.99-09.06	TNK	<b>0 414 799 008</b>	<b>F 00E 200 403</b>
			Komp.Nr. 505012/14	04.99-09.06	TNK	<b>0 414 799 029</b>	<b>0 986 445 019</b>
	12,0	185-260	OM 457.942 HLA <Euro 3> Komp.Nr. 505108/01/02	04.99-10.06	TNK	<b>0 414 799 025</b>	<b>0 986 445 102</b>
			Komp.Nr. 505108/05/06	04.99-10.06	TNK	<b>0 414 799 015</b>	<b>0 986 445 020</b>
GN3, NUE3, N3, N3 UESTRA	6,4	205	OM 906.930 HLA <Euro 2>	01.98-09.04		<b>0 414 799 008</b>	<b>F 00E 200 403</b>
							<b>0 986 445 003</b>
Low Entry	12,0	220-260	OM 457.941 HLA <Euro 3> Komp.Nr. 505108/01	09.05-09.06	TNK	<b>0 414 799 025</b>	<b>0 986 445 102</b>
			Komp.Nr. 522020/01				
			Komp.Nr. 505108/02				
			Komp.Nr. 505108/05/06	09.05-09.06	TNK	<b>0 414 799 015</b>	<b>0 986 445 020</b>
N3	12,0	195	OM 457.943 LA <Euro 3> Komp.Nr. 505108/01	04.00-09.06	TNK	<b>0 414 799 025</b>	<b>0 986 445 102</b>
			Komp.Nr. 505108/05/06	04.00-09.06	TNK	<b>0 414 799 015</b>	<b>0 986 445 020</b>
N3/NUE3	0,0	170	OM 906.931 HLA <Euro 2>	01.98-09.04		<b>0 414 799 008</b>	<b>F 00E 200 403</b>
							<b>0 986 445 003</b>
<b>Citaro L</b>							
<b>0 530 N3</b>	0,0	205	OM 909.921 LA <Euro 2> Komp.Nr. 505012/05	01.99-09.04	TNK	<b>0 414 799 008</b>	<b>F 00E 200 403</b>
			Komp.Nr. 505012/06				<b>0 986 445 003</b>
			Komp.Nr. 505012/09				
			Komp.Nr. 505012/14	01.99-09.04	TNK	<b>0 414 799 029</b>	<b>0 986 445 019</b>
	6,4	205	OM 906.930 HLA <Euro 2>	01.99-09.04		<b>0 414 799 008</b>	<b>F 00E 200 403</b>
							<b>0 986 445 003</b>







◀ MERCEDES-BENZ

<b>0 530 N3</b>	6,4	205	OM 906.960 LA <Euro 3> Komp.Nr. 505012/05/06	01.01-09.06	TNK	<b>0 414 799 008</b>	<b>F 00E 200 403</b> <b>0 986 445 003</b>
			Komp.Nr. 505012/14	01.01-09.06	TNK	<b>0 414 799 029</b>	<b>0 986 445 019</b>
			OM 909.901 LA <Euro 2> Komp.Nr. 505012/05 Komp.Nr. 505012/06 Komp.Nr. 505012/09 Komp.Nr. 505012/14	01.99-09.04	TNK	<b>0 414 799 008</b>	<b>F 00E 200 403</b> <b>0 986 445 003</b>
	12,0	185/220	OM 457.934 HLA <Euro 2>; OM 457.935 HLA <Euro 2> Komp.Nr. 505108/05 Komp.Nr. 522020/01 Komp.Nr. 505108/01	01.99-09.04	TNK	<b>0 414 799 015</b>	<b>0 986 445 020</b>
				01.99-09.04	TNK	<b>0 414 799 025</b>	<b>0 986 445 102</b>
<b>Conecto</b>							
<b>6.4 [628]</b>	6,4	210	OM 902.925 (906 LA) <Euro 4> Komp.Nr. 505012/06	09.07→	TNK	<b>0 414 799 008</b>	<b>F 00E 200 403</b> <b>0 986 445 003</b>
			Komp.Nr. 505012/14	09.07→	TNK	<b>0 414 799 029</b>	<b>0 986 445 019</b>
[671]	6,4	205	OM 906.960 (906 LA) <Euro 2> Komp.Nr. 505012/05	05.01-08.07	TNK	<b>0 414 799 008</b>	<b>F 00E 200 403</b> <b>0 986 445 003</b>
			Komp.Nr. 505012/14	05.01-08.07	TNK	<b>0 414 799 029</b>	<b>0 986 445 019</b>
<b>7.2 [628]</b>	7,2	210	OM 926... <Euro 4/5> Mot.-Typ 926.939	09.07→	TW	<b>0 414 799 008</b>	<b>F 00E 200 403</b> <b>0 986 445 003</b>
						<b>0 414 799 012</b>	<b>0 986 445 017</b>
						<b>0 414 799 029</b>	<b>0 986 445 019</b>
						<b>0 414 799 033</b>	<b>0 986 445 023</b>
			Mot.-Typ 926.949	09.07→	TW	<b>0 414 799 017</b>	<b>F 00E 200 412</b> <b>0 986 445 021</b>
						<b>0 414 799 028</b>	<b>0 986 445 018</b>
<b>12.0 [628]</b>	12,0	260	OM 457.9... <Euro 4/5 (BlueTec)> Mot.-Typ 457.951 Mot.-Typ 457.951 Mot.-Typ 457.967 Mot.-Typ 457.975	09.07→	TW	<b>0 414 799 025</b>	<b>0 986 445 102</b>
				09.07→	TW	<b>0 414 799 015</b>	<b>0 986 445 020</b>
				09.07→	TW	<b>0 414 799 024</b>	<b>F 00E 200 413</b> <b>0 986 445 022</b>
						<b>0 414 799 035</b>	<b>0 986 445 025</b>
[671]	12,0	185-260	OM 457.94... <Euro 3> Komp.Nr. 505108/01 Komp.Nr. 505108/05	10.01-08.07	TNK	<b>0 414 799 025</b>	<b>0 986 445 102</b>
				10.01-08.07	TNK	<b>0 414 799 015</b>	<b>0 986 445 020</b>
<b>Econic</b>							
<b>1823 L [957]</b>	6,4	170	OM 906...; OM 906.951 LA <Euro 3>	03.98-09.06		<b>0 414 799 008</b>	<b>F 00E 200 403</b> <b>0 986 445 003</b>
<b>1824 [957]</b>	6,4	175	OM 902.933 (OM 906) <Euro 4 (BlueTec)>	09.06→	TW	<b>0 414 799 008</b>	<b>F 00E 200 403</b> <b>0 986 445 003</b>
						<b>0 414 799 029</b>	<b>0 986 445 019</b>
<b>1828 L [957]</b>	6,4	205	OM 906.941 LA <Euro 2>; OM 906.950 LA <Euro 3>; OM 906.952 LA <Euro 3>	03.98-09.06		<b>0 414 799 008</b>	<b>F 00E 200 403</b> <b>0 986 445 003</b>
<b>1829 [957]</b>	6,4	210	OM 902.927 (OM 906) <Euro 4 (BlueTec)>	09.06→	TW	<b>0 414 799 008</b>	<b>F 00E 200 403</b> <b>0 986 445 003</b>
						<b>0 414 799 029</b>	<b>0 986 445 019</b>
<b>1833 [957]</b>	7,2	240	OM 926.924 LA <Euro 3> OM 926.934 LA <Euro 4 (BlueTec)>	03.00-09.06		<b>0 414 799 008</b>	<b>F 00E 200 403</b> <b>0 986 445 003</b>
				09.06→	TW	<b>0 414 799 008</b>	<b>F 00E 200 403</b> <b>0 986 445 003</b>
						<b>0 414 799 029</b>	<b>0 986 445 019</b>
<b>2628 L [957]</b>	6,4	205	OM 906.941 LA <Euro 2>; OM 906.952 LA <Euro 3>	03.98-09.06		<b>0 414 799 008</b>	<b>F 00E 200 403</b> <b>0 986 445 003</b>
<b>2629 [957]</b>	6,4	210	OM 902.927 (OM 906) <Euro 4 (BlueTec)>	09.06→	TW	<b>0 414 799 008</b>	<b>F 00E 200 403</b> <b>0 986 445 003</b>
						<b>0 414 799 029</b>	<b>0 986 445 019</b>
<b>2633 [957]</b>	7,2	240	OM 926.924 LA <Euro 3>	03.00-09.06		<b>0 414 799 008</b>	<b>F 00E 200 403</b> <b>0 986 445 003</b>





2633 [957]	7,2	240	OM 926.934 LA <Euro 4 (BlueTec)>	09.06→	TW	0 414 799 008	F 00E 200 403 0 986 445 003
3233 [957]	7,2	240	OM 926.934 LA <Euro 4 (BlueTec)>	09.06→	TW	0 414 799 008	F 00E 200 403 0 986 445 003
<b>Integro I</b>							
<b>O 550 L, Ü, ÜH</b>	12,0	185-260	OM 457 HLA Euro 3 <457>	11.01-09.06		0 414 799 025	0 986 445 102
<b>Integro II</b>							
	7,2	210	OM 926.939 LA <Euro 4/5> Komp.Nr. 505012/06	09.06→	TNK	0 414 799 008	F 00E 200 403 0 986 445 003
			Komp.Nr. 505012/14	09.06→	TNK	0 414 799 029	0 986 445 019
			Komp.Nr. 505012/16	09.06→	TNK	0 414 799 012	0 986 445 017
			Komp.Nr. 505012/21	09.06→	TNK	0 414 799 033	0 986 445 023
	12,0	220-300	OM 457... <Euro 4/5 (BlueTec)> Mot.-Typ 457.952/964	09.06→	TW	0 414 799 025	0 986 445 102
			Mot.-Typ 457.952/964/965	09.06→	TW	0 414 799 015	0 986 445 020
			Mot.-Typ 457.974	09.06→		0 414 799 035	0 986 445 025
<b>L</b>	7,2	210	OM 926.939 LA <Euro 4/5> Komp.Nr. 505012/06	09.06→	TNK	0 414 799 008	F 00E 200 403 0 986 445 003
			Komp.Nr. 505012/14	09.06→	TNK	0 414 799 029	0 986 445 019
			Komp.Nr. 505012/16	09.06→	TNK	0 414 799 012	0 986 445 017
			Komp.Nr. 505012/21	09.06→	TNK	0 414 799 033	0 986 445 023
	12,0	220-300	OM 457... <Euro 4/5 (BlueTec)> Mot.-Typ 457.952/964	09.06→	TW	0 414 799 025	0 986 445 102
			Mot.-Typ 457.952/964/965	09.06→	TW	0 414 799 015	0 986 445 020
			Mot.-Typ 457.974	09.06→		0 414 799 035	0 986 445 025
<b>M</b>	7,2	210	OM 926.939 LA <Euro 4/5> Komp.Nr. 505012/06	09.06→	TNK	0 414 799 008	F 00E 200 403 0 986 445 003
			Komp.Nr. 505012/14	09.06→	TNK	0 414 799 029	0 986 445 019
			Komp.Nr. 505012/16	09.06→	TNK	0 414 799 012	0 986 445 017
			Komp.Nr. 505012/21	09.06→	TNK	0 414 799 033	0 986 445 023
	12,0	220-300	OM 457... <Euro 4/5 (BlueTec)> Mot.-Typ 457.952/964	09.06→	TW	0 414 799 025	0 986 445 102
			Mot.-Typ 457.952/964/965	09.06→	TW	0 414 799 015	0 986 445 020
			Mot.-Typ 457.974	09.06→		0 414 799 035	0 986 445 025
<b>Intouro</b>							
	7,2	210	OM 926... <Euro 4/5> Komp.Nr. 505012/ 13 Mot.-Typ 926.949	03.07→	TNK	0 414 799 017	F 00E 200 412 0 986 445 021
			Komp.Nr. 505012/ 22 Mot.-Typ 926.949	03.07→	TNK	0 414 799 028	0 986 445 018
			Komp.Nr. 505012/06 Mot.-Typ 926.939	03.07→	TNK	0 414 799 008	F 00E 200 403 0 986 445 003
			Komp.Nr. 505012/14 Mot.-Typ 926.939	03.07→	TNK	0 414 799 029	0 986 445 019
			Komp.Nr. 505012/16 Mot.-Typ 926.939	03.07→	TNK	0 414 799 012	0 986 445 017
			Komp.Nr. 505012/21 Mot.-Typ 926.939	03.07→	TNK	0 414 799 033	0 986 445 023
	12,0	220/260/ 300	OM 457.9... <Euro 4/5 (BlueTec)> Mot.-Typ 457.965	03.07→		0 414 799 015	0 986 445 020
			Mot.-Typ 457.974	03.07→		0 414 799 035	0 986 445 025
<b>Medio</b>							
4.2	4,2	110	OM 904.936 LA <Euro 2>	01.01-09.06		0 414 799 008	F 00E 200 403 0 986 445 003





◀ MERCEDES-BENZ

O 345									
	6,4	205	OM 906.960 (906 LA) <Euro 2> Komp.Nr. 505012/05/06	10.01-08.07	TNK	0 414 799 008	F 00E 200 403		
			Komp.Nr. 505012/14	10.01-08.07	TNK	0 414 799 029	0 986 445 019		
G									
	12,0	185-260	OM 457.942 (457 HLA) <Euro 3> Komp.Nr. 505108/05	10.01-08.07	TNK	0 414 799 015	0 986 445 020		
			Komp.Nr. 522020/01 Komp.Nr. 505108/01	10.01-08.07	TNK	0 414 799 025	0 986 445 102		
Tourino									
O 510									
	6,4	180-205	OM 906... <Euro 3> Komp.Nr. 505012/06	01.04→	TNK	0 414 799 008	F 00E 200 403		
			Komp.Nr. 505012/14	01.04→	TNK	0 414 799 029	0 986 445 019		
	7,2	210	OM 926... <Euro 4/5> Komp.Nr. 505012/ 13 Mot.-Typ 926.949	09.06→	TNK	0 414 799 017	F 00E 200 412		
			Komp.Nr. 505012/ 22 Mot.-Typ 926.949	09.06→	TNK	0 414 799 028	0 986 445 018		
			Komp.Nr. 505012/06 Mot.-Typ 926.939	09.06→	TNK	0 414 799 008	F 00E 200 403		
			Komp.Nr. 505012/14 Mot.-Typ 926.939	09.06→	TNK	0 414 799 029	0 986 445 019		
			Komp.Nr. 505012/16 Mot.-Typ 926.939	09.06→	TNK	0 414 799 012	0 986 445 017		
			Komp.Nr. 505012/21 Mot.-Typ 926.939	09.06→	TNK	0 414 799 033	0 986 445 023		
Tourismo									
	12,0	260-300	OM 457... <Euro 4/5 (BlueTec)> Mot.-Typ 457.952	10.06→	TW	0 414 799 015	0 986 445 020		
			Mot.-Typ 457.965	10.06→		0 414 799 025	0 986 445 102		
			Mot.-Typ 457.974	10.06→		0 414 799 035	0 986 445 025		
M, L									
	12,0	315	OM 457... <Euro 4/5 (BlueTec)> Mot.-Typ 457.953 Mot.-Typ 457.961	10.06→	TW	0 414 799 015	0 986 445 020		
			Mot.-Typ 457.976	10.06→	TW	0 414 799 024	F 00E 200 413		
						0 986 445 022			
						0 414 799 035	0 986 445 025		
RH									
	12,0	260-300	OM 457... <Euro 4/5 (BlueTec)> Mot.-Typ 457.965	09.09→		0 414 799 015	0 986 445 020		
			Mot.-Typ 457.974	09.09→		0 414 799 035	0 986 445 025		
RH-M									
	12,0	260-300	OM 457... <Euro 4/5 (BlueTec)> Mot.-Typ 457.965	09.09→		0 414 799 015	0 986 445 020		
			Mot.-Typ 457.974	09.09→		0 414 799 035	0 986 445 025		
15 RHD/SHD									
	12,0	260-310	OM 457.944 LA <Euro 3> Komp.Nr. 505108/03/04	10.99-09.04	TNK	0 414 799 026	0 986 445 016		
			Komp.Nr. 505108/05	10.99-09.04	TNK	0 414 799 015	0 986 445 020		
			Komp.Nr. 522020/01 Komp.Nr. 505108/01	10.99-09.04	TNK	0 414 799 025	0 986 445 102		
		310	OM 457.944 HLA <Euro 3> Komp.Nr. 505108/05	10.04-09.06	TNK	0 414 799 015	0 986 445 020		
Touro									
OC 500									
	12,0	260-310	OM 457.944 LA <Euro 3> Komp.Nr. 505108/05	10.02-08.08	TNK	0 414 799 015	0 986 445 020		
			Komp.Nr. 522020/01 Komp.Nr. 505108/01	10.02-08.08	TNK	0 414 799 025	0 986 445 102		
Travego									
O 580									
	12,0	260-355	OM 457.9... <(OM 457 LA) Euro 4> Komp.Nr. 505108/01	02.06→	TNK	0 414 799 025	0 986 445 102		
			Komp.Nr. 505108/05	02.06→	TNK	0 414 799 015	0 986 445 020		
	15,9	320-350	OM 542.948 <(OM 502 LA)> Komp.Nr. 505108/01/02	02.06→	TNK	0 414 799 025	0 986 445 102		
			Komp.Nr. 505108/06	02.06→	TNK	0 414 799 015	0 986 445 020		
	350		OM 542.966 <(OM 502 LA) Euro 4> Komp.Nr. 505108/02	02.06→	TNK	0 414 799 025	0 986 445 102		
			Komp.Nr. 505108/06	02.06→	TNK	0 414 799 015	0 986 445 020		





<b>0 580 RHD, RHD-L, RHD-M</b>	12,0	315	OM 457.9... <Euro 4/5 (BlueTec)> Mot.-Typ 457.961	09.09→	TW	<b>0 414 799 015</b>	<b>0 986 445 020</b>
			Mot.-Typ 457.976	09.09→	TW	<b>0 414 799 025</b>	<b>0 986 445 102</b>
						<b>0 414 799 024</b>	<b>F 00E 200 413</b>
							<b>0 986 445 022</b>
						<b>0 414 799 035</b>	<b>0 986 445 025</b>
RHD-15	12,0	185-310	OM 457.9... <Euro 3> Komp.Nr. 505108/05	10.99-02.06	TNK	<b>0 414 799 015</b>	<b>0 986 445 020</b>
			Komp.Nr. 522020/01 Komp.Nr. 505108/01	10.99-02.06	TNK	<b>0 414 799 025</b>	<b>0 986 445 102</b>
	15,9	300-350	OM 942.900 LA <(OM 502 LA) Euro 3>	02.01-02.06		<b>0 414 799 025</b>	<b>0 986 445 102</b>
RHD-16/17	12,0	310	OM 457.944 LA <Euro 3> Komp.Nr. 505108/05	10.99-02.06	TNK	<b>0 414 799 015</b>	<b>0 986 445 020</b>
			Komp.Nr. 522020/01 Komp.Nr. 505108/01	10.99-02.06	TNK	<b>0 414 799 025</b>	<b>0 986 445 102</b>
<b>Unimog</b>							
<b>U 20 [405]</b>	4,3	110	OM 900.915 LA <Euro 4 (BlueTec)>	10.07→		<b>0 414 799 008</b>	<b>F 00E 200 403</b>
							<b>0 986 445 003</b>
<b>U 300 [405]</b>	4,3	100/115/ 125	OM 900.915 LA <Euro 4 (BlueTec)>; OM 904.927 LA <Euro3>; OM 904.928 LA <Euro3>	04.00→		<b>0 414 799 008</b>	<b>F 00E 200 403</b>
							<b>0 986 445 003</b>
<b>U 300/400 [405]</b>	4,3	130	OM 900.916 LA <Euro 4 (BlueTec)>	09.06→		<b>0 414 799 008</b>	<b>F 00E 200 403</b>
							<b>0 986 445 003</b>
<b>U 400 [405]</b>	4,3	125	OM 904.928 LA <Euro3>	04.00→		<b>0 414 799 008</b>	<b>F 00E 200 403</b>
							<b>0 986 445 003</b>
	6,4	170	OM 906.935 LA <Euro 3>	04.00→		<b>0 414 799 008</b>	<b>F 00E 200 403</b>
							<b>0 986 445 003</b>
<b>U 400/500 [405]</b>	6,4	175	OM 902.923 LA (906) <Euro 4 (BlueTec)>	09.06→		<b>0 414 799 008</b>	<b>F 00E 200 403</b>
							<b>0 986 445 003</b>
<b>U 500 [405]</b>	6,4	170/205/ 210	OM 902.924 LA (906) <Euro 4 (BlueTec)>; OM 906.935 LA <Euro 3>; OM 906.955 LA <Euro3>	02.01→		<b>0 414 799 008</b>	<b>F 00E 200 403</b>
							<b>0 986 445 003</b>
<b>U 3000/4000 [437]</b>	4,3	110/130	OM 900.921 LA <Euro 4 (BlueTec)>; OM 904.952 LA <Euro3>; OM 904.953 LA <Euro3>	09.02→		<b>0 414 799 008</b>	<b>F 00E 200 403</b>
							<b>0 986 445 003</b>
<b>U 4000 [437]</b>	4,8	160	OM 924.931 <OM 924 LA (Euro 5)>	04.09→		<b>0 414 799 017</b>	<b>F 00E 200 412</b>
							<b>0 986 445 021</b>
<b>U 5000 [437]</b>	4,3	160	OM 924.916 <Euro 3>	03.03→		<b>0 414 799 008</b>	<b>F 00E 200 403</b>
							<b>0 986 445 003</b>
	4,8	160	OM 924.923 <Euro 4 (BlueTec)>	09.06→		<b>0 414 799 012</b>	<b>0 986 445 017</b>
			OM 924.931 <OM 924 LA (Euro 5)>	04.09→		<b>0 414 799 017</b>	<b>F 00E 200 412</b>
							<b>0 986 445 021</b>
	6,4	170	OM 906.935 LA <Euro 3>	03.03→		<b>0 414 799 008</b>	<b>F 00E 200 403</b>
							<b>0 986 445 003</b>
<b>Vario</b>							
<b>613 D [T2W]</b>	4,2	95	OM 900.917 (904 LA) <Euro 4 (BlueTec)>	09.06-12.13		<b>0 414 799 008</b>	<b>F 00E 200 403</b>
							<b>0 986 445 003</b>
<b>614 D [T2W]</b>	4,2	100	OM 904.914 LA <Euro 3>	01.01-09.06		<b>0 414 799 008</b>	<b>F 00E 200 403</b>
							<b>0 986 445 003</b>
	4,3	100	OM 904.908 LA <Euro 2>	09.96-01.01		<b>0 414 799 008</b>	<b>F 00E 200 403</b>
							<b>0 986 445 003</b>
<b>615 D [T2W]</b>	4,2	110	OM 904.936 LA <Euro 2>	01.01-09.06		<b>0 414 799 008</b>	<b>F 00E 200 403</b>
							<b>0 986 445 003</b>
	4,3	112	OM 904.923 LA <Euro 2>	10.98-01.01		<b>0 414 799 008</b>	<b>F 00E 200 403</b>
							<b>0 986 445 003</b>
<b>616 D [T2W]</b>	4,2	115	OM 900.918 (904 LA) <Euro 4 (BlueTec)>	09.06-12.13		<b>0 414 799 008</b>	<b>F 00E 200 403</b>
							<b>0 986 445 003</b>
<b>618 D [T2W]</b>	4,2	130	OM 900.919 (904 LA) <Euro 4 (BlueTec)>; OM 904.964 LA <Euro 3>; OM 904.964 (904 LA)	06.03-12.13		<b>0 414 799 008</b>	<b>F 00E 200 403</b>
							<b>0 986 445 003</b>
<b>810 , DT [T2W]</b>	4,2	75	OM 904.904 LA <Euro 2>	09.96-09.06		<b>0 414 799 008</b>	<b>F 00E 200 403</b>
							<b>0 986 445 003</b>
<b>813 D/DA [T2W]</b>	4,2	95	OM 900.917 (904 LA) <Euro 4 (BlueTec)>	09.06-12.13		<b>0 414 799 008</b>	<b>F 00E 200 403</b>
							<b>0 986 445 003</b>
<b>814 , D, DA [T2W]</b>	4,3	100	OM 904... <Euro 2>; OM 904.908 LA <Euro 2>	09.96-01.01		<b>0 414 799 008</b>	<b>F 00E 200 403</b>
							<b>0 986 445 003</b>
D [T2W]	4,2	100	OM 904.914 LA <Euro 3>	01.01-09.06		<b>0 414 799 008</b>	<b>F 00E 200 403</b>
							<b>0 986 445 003</b>





◀ MERCEDES-BENZ

<b>815</b> , D, DA [T2W]	4,3	110-112	OM 904... <Euro 2>; OM 904.923 LA <Euro 2>	01.96-01.01	<b>0 414 799 008</b>	<b>F 00E 200 403</b> <b>0 986 445 003</b>
D [T2W]	4,2	110	OM 904.936 LA <Euro 2>	01.01-09.06	<b>0 414 799 008</b>	<b>F 00E 200 403</b> <b>0 986 445 003</b>
<b>816</b> D/DA [T2W]	4,2	115	OM 900.918 (904 LA) <Euro 4 (BlueTec)>	09.06-12.13	<b>0 414 799 008</b>	<b>F 00E 200 403</b> <b>0 986 445 003</b>
<b>818</b> D, D/DA [T2W]	4,2	130	OM 900.919 (904 LA) <Euro 4 (BlueTec)>; OM 904.964 LA <Euro 3>; OM 904.964 (904 LA)	06.03-12.13	<b>0 414 799 008</b>	<b>F 00E 200 403</b> <b>0 986 445 003</b>
<b>Zetros</b>						
<b>1833</b>	7,2	240	OM 926.935 <(926 LA) Euro 3>	09.08→	<b>0 414 799 008</b>	<b>F 00E 200 403</b> <b>0 986 445 003</b>
			OM 926.947 <(926 LA) Euro 5>	09.09→	<b>0 414 799 017</b>	<b>F 00E 200 412</b> <b>0 986 445 021</b>
<b>2733</b>	7,2	240	OM 926.935 <(926 LA) Euro 3>	09.08→	<b>0 414 799 008</b>	<b>F 00E 200 403</b> <b>0 986 445 003</b>
			OM 926.947 <(926 LA) Euro 5>	09.09→	<b>0 414 799 017</b>	<b>F 00E 200 412</b> <b>0 986 445 021</b>
<b>7t</b>						
<b>711</b> [LK]	4,3	90	OM 904.905 LA <Euro 2> Komp.Nr. 505012/05/06	03.96-12.99 TNK	<b>0 414 799 008</b>	<b>F 00E 200 403</b> <b>0 986 445 003</b>
<b>8t</b>						
<b>811</b> [LK]	4,3	90	OM 904.905 LA <Euro 2> Komp.Nr. 505012/05/06	03.96-12.99 TNK	<b>0 414 799 008</b>	<b>F 00E 200 403</b> <b>0 986 445 003</b>
<b>814</b> , F, L, LO [LK]	4,3	100	OM 904.906 LA <Euro 2>	03.96-12.99	<b>0 414 799 008</b>	<b>F 00E 200 403</b> <b>0 986 445 003</b>
<b>817</b> , F, L, LO [LK]	4,3	125	OM 904.907 LA <Euro 2>	03.96-12.99	<b>0 414 799 008</b>	<b>F 00E 200 403</b> <b>0 986 445 003</b>
<b>9t</b>						
<b>917</b> , KO [LK]	4,3	125	OM 904.907 LA <Euro 2>	03.96-12.99	<b>0 414 799 008</b>	<b>F 00E 200 403</b> <b>0 986 445 003</b>
<b>11t</b>						
<b>1117</b> , L, LO [LK]	4,3	125	OM 904.907 LA <Euro 2>	03.96-12.99	<b>0 414 799 008</b>	<b>F 00E 200 403</b> <b>0 986 445 003</b>
<b>13t</b>						
<b>1317</b> , KO, L [LK]	4,3	125	OM 904.907 LA <Euro 2>	03.96-12.99	<b>0 414 799 008</b>	<b>F 00E 200 403</b> <b>0 986 445 003</b>
<b>15t</b>						
<b>1517</b> , L [LK]	4,3	125	OM 904.907 LA <Euro 2>	03.96-12.99	<b>0 414 799 008</b>	<b>F 00E 200 403</b> <b>0 986 445 003</b>



**RENAULT**

<b>Magnum</b>						
<b>400</b> E.TECH	12,0	294	MACK E-TECH A <Euro 3>	03.01-09.04	<b>0 414 755 006</b>	<b>0 986 445 008</b>
		295	MIDR 06.24.65 A46 <Euro 2>	11.99-03.01	<b>0 414 755 003</b>	
<b>440</b> E. TECH	12,0	324	MACK E-TECH B <Euro 3>	03.01-09.04	<b>0 414 755 006</b>	<b>0 986 445 008</b>
			MIDR 06.24.65 B46 <Euro 2>	11.99-03.01	<b>0 414 755 003</b>	
<b>480</b> E. TECH	12,0	347	MIDR 06.24.65 C46 <Euro 2>	11.99-03.01	<b>0 414 755 003</b>	
		353	MACK E-TECH C <Euro 3>	03.01-01.05	<b>0 414 755 006</b>	<b>0 986 445 008</b>

**SETRA**

<b>Serie 300</b>						
<b>S 313</b> UL	12,0	185	OM 457 HLA <Euro 3>	07.01-09.05	<b>0 414 799 025</b>	<b>0 986 445 102</b>
<b>S 315</b> H, NF, UL	12,0	185/220	OM 457 HLA <Euro 3>	07.01-09.05	<b>0 414 799 025</b>	<b>0 986 445 102</b>
<b>S 316</b> UL	12,0	185	OM 457 HLA <Euro 3>	07.01-09.05	<b>0 414 799 025</b>	<b>0 986 445 102</b>
<b>S 317</b> UL	12,0	185	OM 457 HLA <Euro 3>	07.01-09.05	<b>0 414 799 025</b>	<b>0 986 445 102</b>
<b>S 319</b> NF, UL	12,0	185	OM 457 HLA <Euro 3>	07.01-09.05	<b>0 414 799 025</b>	<b>0 986 445 102</b>
<b>SG 321</b> UL	12,0	220	OM 457 HLA <Euro 3>	07.01-09.05	<b>0 414 799 025</b>	<b>0 986 445 102</b>



Serie 400							
<b>S 415 ComfortClass</b> GT, GT-HD	12,0	185-310	OM 457.941 hLA <Euro 3>; OM 457.944 hLA <Euro 3>		02.03→	<b>0 414 799 025</b>	<b>0 986 445 102</b>
<b>S 416 ComfortClass</b> GT-HD	12,0	310	OM 457.944 hLA <Euro 3>		02.03→	<b>0 414 799 025</b>	<b>0 986 445 102</b>
<b>S 417 ComfortClass</b> GT-HD	12,0	260-310	OM 457.944 hLA <Euro 3>		02.03→	<b>0 414 799 025</b>	<b>0 986 445 102</b>



Tourmalin							
<b>12,13</b>	9,2	228	PR228S1 <Euro 3>		08.05→	<b>0 414 755 008</b>	<b>0 986 445 013</b>







**MERCEDES-BENZ**

OM							
<b>OM 501</b>	12,0	300/320/ 335/350	OM 541.974 <501 LA Euro4/5>; OM 541.976 OM 541.980 <501 LA Euro4/5>	02.05→	TW	<b>0 414 799 015</b> <b>0 414 799 024</b> <b>0 414 799 025</b> <b>0 414 799 035</b>	<b>0 986 445 020</b> <b>F 00E 200 413</b> <b>0 986 445 022</b> <b>0 986 445 102</b> <b>0 986 445 025</b>
<b>OM 904</b>	4,3	125	OM 904.911 <OM 904 LA>	01.97→		<b>0 414 799 008</b>	<b>F 00E 200 403</b> <b>0 986 445 003</b>
<b>OM 906</b>	6,4	170	OM 906.910 <OM 906 LA>	01.98→		<b>0 414 799 008</b>	<b>F 00E 200 403</b> <b>0 986 445 003</b>





AUDI

A2									
1.2 TDI 3L [8Z0]	1,2	45	ANY		03.01-08.05	0 414 720 084 0 986 441 555			
1.4 TDI [8Z0]	1,4	55	AMF		09.99-08.03	0 414 720 085 0 986 441 551			
			BHC		05.03-08.05	0 414 720 265 0 986 441 559			
			ATL		11.03-08.05	0 414 720 266 0 986 441 560			
A3									
1.9 TDI [8L1]	1,9	74	ATD		09.00-06.03	0 414 720 087 0 986 441 556			
			AXR		11.01-06.03	0 414 720 213 0 986 441 559			
			TDI [8P1]	1,9	77	BKC		06.03-05.06	0 414 720 265 0 986 441 559
BLS <D3W>		11.05-05.10				0 414 720 363 0 986 441 568			
TDI, TDI quattro [8L1]	1,9	96	BXE <D3W>		06.06-05.10	0 414 720 265 0 986 441 559			
			ASZ		05.00-06.03	0 414 720 089 0 986 441 557			
2.0 TDI [8P1]	2,0	103	BKD	Fg.-Nr. →8P..4..160 000	05.03-03.04	0 414 720 453 0 986 441 580			
				Fg.-Nr. 8P..4..160 001→	04.04-06.08	0 414 720 454 0 986 441 566			
			TDI quattro [8P1]	11.04-06.08	0 414 720 454 0 986 441 566				
			TDI, TDI quattro [8P1]	2,0	100	AZV	Fg.-Nr. →8P..4..160 000	05.03-03.04	0 414 720 453 0 986 441 580
							Fg.-Nr. 8P..4..160 001→	04.04-06.08	0 414 720 454 0 986 441 566
		103	BMM		01.05-06.08	0 414 720 362 0 986 441 567			
A3 Cabriolet									
1.9 TDI [8P7]	1,9	77	BLS <D3W>		04.08-05.09	0 414 720 363 0 986 441 568			
A3 Sportback									
1.9 TDI [8PA]	1,9	77	BKC		09.04-05.06	0 414 720 265 0 986 441 559			
			BLS <D3W>		11.05-05.10	0 414 720 363 0 986 441 568			
			BXE <D3W>		06.06-05.10	0 414 720 265 0 986 441 559			
2.0 TDI, TDI quattro [8PA]	2,0	100/103	AZV; BKD		09.04-06.08	0 414 720 454 0 986 441 566			
		103	BMM		02.05-06.08	0 414 720 362 0 986 441 567			
A4									
1.9 TDI [8EC; B7]	1,9	84	BKE		11.04-11.05	0 414 720 280 0 986 441 525			
			BRB		01.06-06.08	0 414 720 364 0 986 441 577			
			TDI [8E2; B6]	1,9	74	AVB		04.01-05.04	0 414 720 087 0 986 441 556
						BKE			
						Fg.-Nr. →8E..5..070 250	06.04-07.04	0 414 720 276 0 986 441 571	
			Fg.-Nr. 8E..5..070 251→	08.04-12.04	0 414 720 280 0 986 441 525				
TDI, TDI quattro [8D2; B5]	1,9	85	AJM; ATJ		08.98-11.00	0 414 720 007 0 986 441 551			
TDI, TDI quattro [8E2; B6]	1,9	96	AVF; AWX		12.00-12.04	0 414 720 266 0 986 441 560			
2.0 TDI [8EC; B7]	2,0	89/93/	BRE; BRF; BVF; BVG		06.05-06.08	0 414 720 454 0 986 441 566			
		100/103							
		100/103	BLB; BNA		11.04-10.05	0 414 720 454 0 986 441 566			
TDI, TDI quattro [8EC; B7]	2,0	103	BPW		11.04-06.08	0 414 720 279 0 986 441 574			
A4 Avant									
1.9 TDI [8ED; B7]	1,9	85	BKE		11.04-12.05	0 414 720 280 0 986 441 525			
			BRB		01.06-06.08	0 414 720 364 0 986 441 577			
			TDI [8E5; B6]	1,9	74	AVB		09.01-05.04	0 414 720 087 0 986 441 556
						BKE			
						Fg.-Nr. →8E..5..070 250	06.04-07.04	0 414 720 276 0 986 441 571	
			Fg.-Nr. 8E..5..070 251→	08.04-12.04	0 414 720 280 0 986 441 525				
TDI, TDI quattro [8D5; B5]	1,9	85	AJM; ATJ		08.98-09.01	0 414 720 007 0 986 441 551			
TDI, TDI quattro [8E5; B6]	1,9	96	AVF; AWX		09.01-12.04	0 414 720 266 0 986 441 560			
2.0 TDI [8ED; B7]	2,0	89/93/	BRE; BRF; BVF; BVG		10.05-06.08	0 414 720 454 0 986 441 566			
		100/103							
		100/103	BLB; BNA		11.04-11.05	0 414 720 454 0 986 441 566			
TDI, TDI quattro [8ED; B7]	2,0	103	BPW		11.04-06.08	0 414 720 279 0 986 441 574			
A4 Cabriolet									
2.0 TDI [8HE; B7]	2,0	100/103	BPW; BRC		01.06-03.09	0 414 720 279 0 986 441 574			
A6									
1.9 TDI [4B2; C5]	1,9	85	AJM		05.99-04.01	0 414 720 085 0 986 441 551			
		96	AVF; AWX		06.01-05.04	0 414 720 266 0 986 441 560			





◀ AUDI

<b>2.0 TDI [4F2; C6]</b>	2,0	89/100/103	BLB; BNA; BRE; BRF; BVG	07.04-06.08	<b>0 414 720 454</b>	<b>0 986 441 566</b>
<b>A6 Avant</b>						
<b>1.9 TDI [4B5; C5]</b>	1,9	85/96	AJM AVF; AWX	02.98-04.01 06.01-01.05	<b>0 414 720 085</b> <b>0 414 720 266</b>	<b>0 986 441 551</b> <b>0 986 441 560</b>
<b>2.0 TDI [4F5; C6]</b>	2,0	89/100/103	BLB; BNA; BRE; BRF; BVG	06.05-10.08	<b>0 414 720 454</b>	<b>0 986 441 566</b>

**FORD**









<b>Galaxy</b>						
<b>1.9 TDI [00]</b>	1,9	66	ANU <19NPD>	04.00-04.01 05.01-08.06	<b>0 414 720 014</b> <b>0 414 720 086</b>	<b>0 986 441 553</b>
			85 96	AUY <19PPD> ASZ <19PPD>	04.00-08.06 01.03-08.06	<b>0 414 720 088</b> <b>0 414 720 266</b>
<b>TDI [95]</b>	1,9	66	ANU <19NPD>	09.99-03.00	<b>0 414 720 014</b>	<b>0 986 441 553</b>

**MITSUBISHI**

<b>Grandis</b>						
<b>2.0 DI-D</b>	2,0	100-103	B...	06.05-11.10	<b>0 414 720 454</b>	<b>0 986 441 566</b>
<b>Lancer</b>						
<b>2.0 DI-D [CY/CZ]</b>	2,0	103	B...	02.08-08.10	<b>0 414 720 454</b>	<b>0 986 441 566</b>
<b>Lancer Sportback</b>						
<b>2.0 DI-D [CX]</b>	2,0	103	B...	08.08-08.10	<b>0 414 720 454</b>	<b>0 986 441 566</b>
<b>Outlander</b>						
<b>2.0 DI-D 4WD [CW]</b>	2,0	103	BSY	02.07-06.10	<b>0 414 720 454</b>	<b>0 986 441 566</b>

**SEAT**

<b>Alhambra</b>						
<b>1.9 TDI [7V9]</b>	1,9	66	ANU	06.00-03.10	<b>0 414 720 086</b>	<b>0 986 441 553</b>
<b>TDI, TDI 4Motion [7V9]</b>	1,9	85	AUY	06.00-03.10	<b>0 414 720 088</b>	<b>0 986 441 554</b>
			BVK	06.05-03.10	<b>0 414 720 364</b>	<b>0 986 441 577</b>
			96	ASZ	11.02-11.08	<b>0 414 720 266</b>
<b>2.0 TDI [7V9]</b>	2,0	103	BRT	11.05-03.10	<b>0 414 720 279</b>	<b>0 986 441 574</b>
<b>Altea</b>						
<b>1.9 TDI [5P1]</b>	1,9	66/77	BXE <D3W>; BXF <MF7>	02.06-12.10	<b>0 414 720 265</b>	<b>0 986 441 559</b>
		77	BJB; BKC	04.04-05.06	<b>0 414 720 265</b>	<b>0 986 441 559</b>
			BLS <D3W>	10.05-05.10	<b>0 414 720 363</b>	<b>0 986 441 568</b>
<b>2.0 TDI [5P1]</b>	2,0	100	AZV	04.04-03.09	<b>0 414 720 454</b>	<b>0 986 441 566</b>
		103	BKD <D3X>			
			Fg.-Nr. →5P..4..003 500	03.04-03.04	<b>0 414 720 453</b>	<b>0 986 441 580</b>
			Fg.-Nr. 5P..4..003 501→	04.04-07.11	<b>0 414 720 454</b>	<b>0 986 441 566</b>
			BMM <D7N>	11.05-11.10	<b>0 414 720 362</b>	<b>0 986 441 567</b>
<b>Altea Freetrack</b>						
<b>2.0 TDI, TDI 4WD [5P5/5P8]</b>	2,0	103	BMM <D7N>	06.07-10.10	<b>0 414 720 362</b>	<b>0 986 441 567</b>
<b>Altea XL</b>						
<b>1.9 TDI [5P5]</b>	1,9	66/77	BXE <D3W>; BXF <MF7>	10.06-12.10	<b>0 414 720 265</b>	<b>0 986 441 559</b>
		77	BLS <D3W>	10.06-09.10	<b>0 414 720 363</b>	<b>0 986 441 568</b>
<b>2.0 TDI [5P5]</b>	2,0	100/103	AZV; BKD <D3X>	05.06-09.11	<b>0 414 720 454</b>	<b>0 986 441 566</b>
		103	BMM <D7N>	10.06-11.10	<b>0 414 720 362</b>	<b>0 986 441 567</b>
<b>Arosa</b>						
<b>1.4 TDI [6H1]</b>	1,4	55	AMF	01.98-06.04	<b>0 414 720 085</b>	<b>0 986 441 551</b>
<b>Cordoba</b>						
<b>1.4 TDI [6L2]</b>	1,4	51/58	BNM <D4S>; BNV	05.05-11.09	<b>0 414 720 265</b>	<b>0 986 441 559</b>
		55	AMF	10.02-12.05	<b>0 414 720 085</b>	<b>0 986 441 551</b>
		59	BMS	06.06-11.09	<b>0 414 720 364</b>	<b>0 986 441 577</b>
<b>1.9 TDI [6L2]</b>	1,9	74	ATD	09.02-07.05	<b>0 414 720 087</b>	<b>0 986 441 556</b>
			AXR	05.05-11.09	<b>0 414 720 265</b>	<b>0 986 441 559</b>

									
1.9 TDI [6L2]	1,9	74	BMT		09.06-11.09	0 414 720 363	0 986 441 568		
		96	ASZ		10.02-09.05	0 414 720 089	0 986 441 557		
			BLT		05.05-11.09	0 414 720 266	0 986 441 560		
<b>Ibiza</b>									
1.4 TDI [6J5]	1,4	59	BMS <D4T>		08.08-06.10	0 414 720 364	0 986 441 577		
TDI [6L1]	1,4	51/59	BNM <D4S>; BNV		05.05-11.09	0 414 720 265	0 986 441 559		
		55	AMF		05.02-12.05	0 414 720 085	0 986 441 551		
		59	BMS		06.06-11.09	0 414 720 364	0 986 441 577		
1.9 TDI [6J5]	1,9	66/77	BLS <D3W>; BXJ		02.08-06.10	0 414 720 363	0 986 441 568		
TDI [6L1]	1,9	74	ATD		09.01-05.05	0 414 720 087	0 986 441 556		
			AXR		05.05-11.09	0 414 720 265	0 986 441 559		
			BMT		09.06-11.09	0 414 720 363	0 986 441 568		
		96	ASZ		11.01-09.05	0 414 720 089	0 986 441 557		
			BLT		05.05-11.09	0 414 720 266	0 986 441 560		
<b>Ibiza Cupra R</b>									
1.9 TDI [6L1]	1,9	118	BPX		03.04-11.05	0 414 720 089	0 986 441 557		
			BUK		11.05-02.08	0 414 720 279	0 986 441 574		
<b>Ibiza SC</b>									
1.4 TDI [6J1]	1,4	59	BMS <D4T>		07.08-06.10	0 414 720 364	0 986 441 577		
1.9 TDI [6J1]	1,9	66/77	BLS <D3W>; BXJ		02.08-06.10	0 414 720 363	0 986 441 568		
<b>Leon</b>									
1.9 TDI [1M1]	1,9	74	AXR		10.05-06.06	0 414 720 265	0 986 441 559		
TDI [1P1]	1,9	66/77	BXE <D3W>; BXF <MF7>		02.06-12.10	0 414 720 265	0 986 441 559		
		77	BKC		07.05-02.06	0 414 720 265	0 986 441 559		
			BLS <D3W>		11.05-05.10	0 414 720 363	0 986 441 568		
TDI, TDI Syncro [1M1]	1,9	96/110	ARL; ASZ		09.00-06.06	0 414 720 089	0 986 441 557		
2.0 TDI [1P1]	2,0	100/103	AZV; BKD <D3X>		07.05-12.12	0 414 720 453	0 986 441 580		
		103	BMM <D7N>		10.05-10.10	0 414 720 362	0 986 441 567		
<b>Toledo</b>									
1.9 TDI [1M2]	1,9	96	ASZ		05.03-07.04	0 414 720 089	0 986 441 557		
		110	ARL		09.00-05.02	0 414 720 089	0 986 441 557		
		77	BJB; BKC		09.04-02.06	0 414 720 265	0 986 441 559		
BLS <D3W>			10.05-05.09	0 414 720 363	0 986 441 568				
BXE <D3W>			02.06-05.09	0 414 720 265	0 986 441 559				
2.0 TDI [5P2]	2,0	100/103	AZV; BKD <D3X>		09.04-05.09	0 414 720 453	0 986 441 580		
		103	BMM <D7N>		01.06-05.09	0 414 720 362	0 986 441 567		
<b>SKODA</b>									
<b>Fabia</b>									
1.4 TDI [5J2]	1,4	51/59	BNM <D4S>; BNV <D4T>		01.07-03.10	0 414 720 265	0 986 441 559		
		59	BMS <D4T>		01.07-03.10	0 414 720 364	0 986 441 577		
		51/59	BNM <D4S>; BNV <D4T>		10.05-12.07	0 414 720 265	0 986 441 559		
55	AMF			05.03-10.05	0 414 720 085	0 986 441 551			
1.9 TDI [5J2]	1,9	77	BLS <D3W>		04.07-03.10	0 414 720 363	0 986 441 568		
TDI [6Y3]	1,9	74	BSW <D3W>		04.07-03.10	0 414 720 265	0 986 441 559		
			ATD		09.99-10.05	0 414 720 087	0 986 441 556		
			AXR <MS7>		10.05-12.07	0 414 720 265	0 986 441 559		
<b>Fabia Combi</b>									
1.4 TDI [5J5]	1,4	51/59	BNM <D4S>; BNV <D4T>		10.07-03.10	0 414 720 265	0 986 441 559		
		59	BMS <D4T>		10.07-03.10	0 414 720 364	0 986 441 577		
		51/59	BNM <D4S>; BNV <D4T>		10.05-12.07	0 414 720 265	0 986 441 559		
55	AMF			05.03-10.05	0 414 720 085	0 986 441 551			
1.9 TDI [5J5]	1,9	77	BLS <D3W>		10.07-03.10	0 414 720 363	0 986 441 568		
TDI [6Y5]	1,9	74	BSW <D3W>		10.07-03.10	0 414 720 265	0 986 441 559		
			ATD		08.00-10.05	0 414 720 087	0 986 441 556		
			AXR <MS7>		10.05-12.07	0 414 720 265	0 986 441 559		
<b>Fabia Schrägheck</b>									
1.4 TDI [6Y2]	1,4	51/59	BNM <D4S>; BNV <D4T>		10.05-04.07	0 414 720 265	0 986 441 559		
		55	AMF		05.03-04.07	0 414 720 085	0 986 441 551		
1.9 TDI [6Y2]	1,9	74	ATD		09.99-10.05	0 414 720 087	0 986 441 556		
			AXR <MS7>		10.05-04.07	0 414 720 265	0 986 441 559		



◀ SKODA

Fabia Schrägheck RS							
1.9 TDI [6Y2]	1,9	96	ASZ		06.03-10.05	0 414 720 089	0 986 441 557
			BLT		10.05-04.07	0 414 720 266	0 986 441 560
Octavia							
1.9 TDI [1U2]	1,9	74	AXR <MS7>		10.05-12.10	0 414 720 265	0 986 441 559
		96	ASZ		01.03-09.04	0 414 720 089	0 986 441 557
TDI [1Z3]	1,9	77	BJB <D3W>; BKC <D3W>		05.04-12.10	0 414 720 265	0 986 441 559
			BXE <D3W>		03.06-04.13	0 414 720 265	0 986 441 559
TDI, TDI 4x4 [1Z3]	1,9	77	BLS <D3W>		05.06-05.10	0 414 720 363	0 986 441 568
2.0 TDI [1Z3]	2,0	100/103	AZV <MS9>; BKD <D7N>		05.04-05.10	0 414 720 454	0 986 441 566
		103	BMM <D7N>		11.05-05.10	0 414 720 362	0 986 441 567
Octavia Combi							
1.9 TDI [1U5]	1,9	74	AXR <MS7>		10.05-12.10	0 414 720 265	0 986 441 559
		96	ASZ		01.03-09.04	0 414 720 089	0 986 441 557
TDI, TDI 4x4 [1U5]	1,9	74	ATD		08.00-01.06	0 414 720 087	0 986 441 556
TDI, TDI 4x4 [1Z5]	1,9	77	BJB <D3W>; BKC <D3W>		05.04-12.10	0 414 720 265	0 986 441 559
			BLS <D3W>		05.06-05.10	0 414 720 363	0 986 441 568
			BXE <D3W>		11.04-04.13	0 414 720 265	0 986 441 559
2.0 TDI [1Z5]	2,0	100/103	AZV <MS9>; BKD <D7N>		05.04-05.10	0 414 720 454	0 986 441 566
TDI, TDI 4x4 [1Z5]	2,0	103	BMM <D7N>		11.05-05.10	0 414 720 362	0 986 441 567
Praktik							
1.4 TDI [5J7]	1,4	51/59	BMS <D4T>; BNM <D4S>; BNV <D4T>		03.07-03.10	0 414 720 364	0 986 441 577
Roomster							
1.4 TDI [5J7]	1,4	51/59	BMS <D4T>; BNM <D4S>; BNV <D4T>		05.06-03.10	0 414 720 364	0 986 441 577
1.9 TDI [5J7]	1,9	74	AXR <MS7>		03.06-05.06	0 414 720 265	0 986 441 559
		77	BLS <D3W>		11.06-03.10	0 414 720 363	0 986 441 568
			BSW <D3W>		05.06-03.10	0 414 720 265	0 986 441 559
Superb							
1.9 TDI [3T4]	1,9	77	BLS <D3W>		03.08-09.10	0 414 720 363	0 986 441 568
			BXE <D3W>		03.08-11.10	0 414 720 265	0 986 441 559
TDI [3U4]	1,9	74	AVB		02.02-10.05	0 414 720 087	0 986 441 556
		77/85	BPZ; BSV		10.05-03.08	0 414 720 280	0 986 441 525
		96	AVF		01.04-03.08	0 414 720 266	0 986 441 560
			AWX				
			Fg.-Nr. →3U..3..039 898		12.01-03.03	0 414 720 214	0 986 441 560
			Fg.-Nr. 3U..3..039 899→		04.03-03.08	0 414 720 266	0 986 441 560
2.0 TDI [3T4]	2,0	103	BKD <D7N>		01.09-03.10	0 414 720 454	0 986 441 566
			BMP <D7N>		03.08-03.10	0 414 720 362	0 986 441 567
TDI [3U4]	2,0	91/103	BSS; BWW		10.05-03.08	0 414 720 279	0 986 441 574
Superb Combi							
1.9 TDI [3T5]	1,9	77	BLS <D3W>		09.09-09.10	0 414 720 363	0 986 441 568
			BXE <D3W>		09.09-11.10	0 414 720 265	0 986 441 559
2.0 TDI [3T5]	2,0	103	BKD <D7N>		09.09-03.10	0 414 720 454	0 986 441 566
			BMP <D7N>		09.09-03.10	0 414 720 362	0 986 441 567



**VW (VOLKSWAGEN)**

Bora							
1.9 TDI [1J2]	1,9	74	AXR		05.01-05.05	0 414 720 265	0 986 441 559
TDI, TDI 4Motion [1J2]	1,9	74	ATD		01.00-05.05	0 414 720 087	0 986 441 556
		85	AJM		09.98-05.01	0 414 720 085	0 986 441 551
			AUY		01.00-04.01	0 414 720 085	0 986 441 551
		96/110	ARL; ASZ		01.00-05.05	0 414 720 089	0 986 441 557
Bora Variant							
1.9 TDI [1J6]	1,9	74	AXR		05.01-05.05	0 414 720 265	0 986 441 559
TDI, TDI 4Motion [1J6]	1,9	74	ATD		05.00-05.05	0 414 720 087	0 986 441 556
		85	AJM		05.99-05.00	0 414 720 085	0 986 441 551
			AUY		01.00-04.01	0 414 720 085	0 986 441 551
		96/110	ARL; ASZ		01.01-05.05	0 414 720 089	0 986 441 557
Caddy							
1.9 TDI [2K]	1,9	77	BJB <D3W>		02.04-08.10	0 414 720 265	0 986 441 559
TDI, TDI 4Motion [2K]	1,9	55/77	BLS <D3W>; BSU <D4U>		06.05-08.10	0 414 720 363	0 986 441 568



2.0 SDI [2K]	2,0	51	BDJ <D0K>	02.04-08.10		0 414 720 271	0 986 441 562
			BST <D0K>	06.05-08.10		0 414 720 282	0 986 441 564
TDI [2K]	2,0	103	BMM <D7N>	09.07-08.10		0 414 720 362	0 986 441 567
<b>Caddy Panel Van</b>							
1.9 TDI [2K]	1,9	77	BJB <D3W>	06.04→		0 414 720 265	0 986 441 559
<b>Eos</b>							
2.0 TDI [1F7]	2,0	103	BMM <D7N>	05.06-05.08		0 414 720 362	0 986 441 567
<b>Fox</b>							
1.4 TDI [5Z1]	1,4	51	BNM <D4S>	04.05-12.12		0 414 720 265	0 986 441 559
<b>Golf IV</b>							
1.9 TDI [1J1]	1,9	74	AXR	05.01-05.04		0 414 720 265	0 986 441 559
TDI, TDI 4Motion [1J1]	1,9	74	ATD	02.00-06.05		0 414 720 087	0 986 441 556
		85	AJM	05.99-07.01		0 414 720 085	0 986 441 551
			AUY	01.00-07.01		0 414 720 085	0 986 441 551
		96/110	ARL; ASZ	09.00-06.05		0 414 720 089	0 986 441 557
<b>Golf IV Variant</b>							
1.9 TDI [1J5]	1,9	74	AXR	05.01-06.06		0 414 720 265	0 986 441 559
TDI, TDI 4Motion [1J5]	1,9	74	ATD	01.00-06.06		0 414 720 087	0 986 441 556
		85	AJM	05.99-07.01		0 414 720 085	0 986 441 551
			AUY	11.99-07.01		0 414 720 085	0 986 441 551
		96/110	ARL; ASZ	04.01-06.06		0 414 720 089	0 986 441 557
<b>Golf Plus</b>							
1.9 TDI [5M1]	1,9	66	BXJ	11.07-01.09		0 414 720 363	0 986 441 568
		66/77	BRU; BXE <D3W>; BXF	05.05-01.09		0 414 720 265	0 986 441 559
		77	BKC	01.05-05.06		0 414 720 265	0 986 441 559
			BLS <D3W>	06.05-01.09		0 414 720 363	0 986 441 568
2.0 TDI [5M1]	2,0	100/103	AZV; BKD	01.05-12.08		0 414 720 454	0 986 441 566
		103	BMM <D7N>	12.05-01.09		0 414 720 362	0 986 441 567
<b>Golf V</b>							
1.9 TDI [1K1]	1,9	66	BXJ	05.07-11.08		0 414 720 363	0 986 441 568
TDI, TDI 4Motion [1K1]	1,9	66/77	BRU; BXE <D3W>; BXF	05.04-11.08		0 414 720 265	0 986 441 559
		77	BKC	10.03-02.06		0 414 720 265	0 986 441 559
			BLS <D3W>	08.05-11.08		0 414 720 363	0 986 441 568
2.0 SDI [1K1]	2,0	55	BDK	01.04-11.08		0 414 720 282	0 986 441 564
TDI [1K1]	2,0	100	AZV				
			Fg.-Nr. →1K..4B055 531 →1K..4P049 474	10.03-02.04		0 414 720 453	0 986 441 580
			→1K..4U000 050 →1K..4W098 000				
			Fg.-Nr. 1K..4B055 532→1K..4B070 759	03.04-03.04	AG	0 414 720 454	0 986 441 566
			1K..4P049 475→1K..4P060 890		GS	0 414 720 453	0 986 441 580
			1K..4U000 051→1K..4U000 169				
			1K..4W098 001→1K..4W124 231				
			Fg.-Nr. 1K..4B070 760→1K..4P060 891→	04.04-11.08		0 414 720 454	0 986 441 566
			1K..4U000 170→1K..4W124 232→				
TDI, TDI 4Motion [1K1]	2,0	103	BKD				
			Fg.-Nr. →1K..4B055 531 →1K..4P049 474	10.03-02.04		0 414 720 453	0 986 441 580
			→1K..4U000 050 →1K..4W098 000				
			Fg.-Nr. 1K..4B055 532→1K..4B070 759	03.04-03.04	AG	0 414 720 454	0 986 441 566
			1K..4P049 475→1K..4P060 890		GS	0 414 720 453	0 986 441 580
			1K..4U000 051→1K..4U000 169				
			1K..4W098 001→1K..4W124 231				
			Fg.-Nr. 1K..4B070 760→1K..4P060 891→	04.04-11.08		0 414 720 454	0 986 441 566
			1K..4U000 170→1K..4W124 232→				
			BMM <D7N>	12.04-11.08		0 414 720 362	0 986 441 567
<b>Golf V Variant</b>							
1.9 TDI [1K5]	1,9	77	BXE <D3W>	05.07-11.08		0 414 720 265	0 986 441 559
TDI, TDI 4Motion [1K5]	1,9	77	BLS <D3W>	05.07-06.09		0 414 720 363	0 986 441 568
2.0 TDI [1K5]	2,0	103	BMM <D7N>	05.07-05.08		0 414 720 362	0 986 441 567
TDI, TDI 4Motion [1K5]	2,0	100/103	AZV; BKD	05.07-06.09		0 414 720 454	0 986 441 566
<b>Golf VI Variant</b>							
2.0 TDI [AJ5]	2,0	103	BMM <D7N>	07.09-04.13		0 414 720 362	0 986 441 567
<b>Jetta</b>							
1.9 TDI [1K2]	1,9	77	BKC	05.05-02.06		0 414 720 265	0 986 441 559
			BLS <D3W>	09.05-10.10		0 414 720 363	0 986 441 568







◀ VW

1.9 TDI [1K2]	1,9	77	BXE <D3W>	03.06-10.10	0 414 720 265	0 986 441 559
2.0 TDI [1K2]	2,0	100/103	AZV; BKD	08.05-06.08	0 414 720 454	0 986 441 566
		103	BMM <D7N>	10.05-06.08	0 414 720 362	0 986 441 567
<b>Jetta V</b>						
2.0 TDI [1K6]	2,0	103	BKD	03.06→	0 414 720 454	0 986 441 566
<b>Lupo</b>						
1.2 TDI 3L [6X1]	1,2	45	ANY			
			Fg.-Nr. →6E..Y..010 000 →6X..Y..070 000	10.98-04.00	0 414 720 083	0 986 441 552
			Fg.-Nr. 6E..1..000 001 → 6X..1..000 001→	05.00-11.00	0 414 720 084	0 986 441 555
			AYZ	11.00-07.05	0 414 720 084	0 986 441 555
1.4 TDI [6X1]	1,4	55	AMF	06.98-07.05	0 414 720 085	0 986 441 551
<b>New Beetle</b>						
1.9 TDI [1C1/9C1]	1,9	74	ATD	10.00-06.05	0 414 720 087	0 986 441 556
		74/77	BEW; BSW <D3W>	06.03-12.10	0 414 720 265	0 986 441 559
<b>New Beetle Cabriolet</b>						
1.9 TDI [1Y7]	1,9	74/77	AXR; BSW <D3W>	06.03-09.10	0 414 720 265	0 986 441 559
<b>Passat</b>						
1.9 TDI [3B2]	1,9	74	AVB	02.00-11.00	0 414 720 087	0 986 441 556
TDI [3B3]	1,9	74	AVB	10.00-05.05	0 414 720 087	0 986 441 556
		96	AVF			
			Fg.-Nr. →3B..2..290 300	10.00-12.01	0 414 720 089	0 986 441 557
			Fg.-Nr. 3B..2..290 301→	01.02-05.05	0 414 720 266	0 986 441 560
			AWX			
			Fg.-Nr. →3B..2..290 300	10.00-12.01	0 414 720 089	0 986 441 557
			Fg.-Nr. 3B..2..290 301→	01.02-05.05	0 414 720 266	0 986 441 560
TDI [3C2]	1,9	77	BKC	03.05-02.06	0 414 720 265	0 986 441 559
			BLS <D3W>	03.05-11.08	0 414 720 363	0 986 441 568
			BXE <D3W>	02.06-11.08	0 414 720 265	0 986 441 559
TDI, TDI Syncro [3B2]	1,9	85	AJM; ATJ	01.98-11.00	0 414 720 085	0 986 441 551
TDI 4Motion [3B3]	1,9	96	AVF			
			Fg.-Nr. →3B..2..300 000	10.00-12.01	0 414 720 089	0 986 441 557
			Fg.-Nr. 3B..2..300 001→	01.02-05.05	0 414 720 266	0 986 441 560
2.0 TDI [3B3]	2,0	100	BGW	11.03-05.05	0 414 720 272	0 986 441 569
			BHW	11.03-05.05	0 414 720 277	0 986 441 572
TDI, TDI 4Motion [3C2]	2,0	103	BMP	03.05-06.08	0 414 720 362	0 986 441 567
<b>Passat Variant</b>						
1.9 TDI [3B5]	1,9	74	AVB	02.00-11.00	0 414 720 087	0 986 441 556
TDI [3B6]	1,9	74	AVB	10.00-05.05	0 414 720 087	0 986 441 556
		96	AVF			
			Fg.-Nr. →3B..2..290 300	10.00-12.01	0 414 720 089	0 986 441 557
			Fg.-Nr. 3B..2..290 301→	01.02-05.05	0 414 720 266	0 986 441 560
			AWX			
			Fg.-Nr. →3B..2..290 300	10.00-12.01	0 414 720 089	0 986 441 557
			Fg.-Nr. 3B..2..290 301→	01.02-05.05	0 414 720 266	0 986 441 560
TDI [3C5]	1,9	77	BKC	08.05-02.06	0 414 720 265	0 986 441 559
			BLS <D3W>	08.05-11.08	0 414 720 363	0 986 441 568
			BXE <D3W>	02.06-11.08	0 414 720 265	0 986 441 559
TDI, TDI Syncro [3B5]	1,9	85	AJM; ATJ	01.99-11.00	0 414 720 085	0 986 441 551
TDI 4Motion [3B6]	1,9	96	AVF			
			Fg.-Nr. →3B..2..300 000	10.00-12.01	0 414 720 089	0 986 441 557
			Fg.-Nr. 3B..2..300 001→	01.02-05.05	0 414 720 266	0 986 441 560
2.0 TDI [3B6]	2,0	100	BGW	11.03-05.05	0 414 720 272	0 986 441 569
TDI, TDI 4Motion [3C5]	2,0	103	BMP	08.05-06.08	0 414 720 362	0 986 441 567
<b>Phaeton</b>						
5.0 TDI 4Motion [3D]	5,0	230	AJS	11.02-10.06	0 414 720 270	0 986 441 565
<b>Polo</b>						
1.4 TDI [6N2]	1,4	55	AMF	10.99-09.01	0 414 720 085	0 986 441 551
TDI [9N1]	1,4	55	AMF	09.01-06.05	0 414 720 085	0 986 441 551
			BAY	09.01-06.05	0 414 720 265	0 986 441 559
TDI [9N2]	1,4	55	BAY	07.03-05.07	0 414 720 265	0 986 441 559
TDI [9N3]	1,4	51	BWB	10.05-12.09	0 414 720 364	0 986 441 577
		51/58	BNM <D4S>; BNV	04.05-12.09	0 414 720 363	0 986 441 568
		59	BMS	10.05-12.09	0 414 720 364	0 986 441 577



1.4 TDI [9N4]	1,4	58	BNV		04.05→	0 414 720 363	0 986 441 568
TDI [9V4]	1,4	55	AMF		10.02-12.03	0 414 720 085	0 986 441 551
1.9 TDI [9N1]	1,9	74	ATD		09.01-05.05	0 414 720 087	0 986 441 556
			AXR		09.01-05.05	0 414 720 265	0 986 441 559
		96	ASZ		11.03-05.05	0 414 720 089	0 986 441 557
			BLT		05.04-05.05	0 414 720 266	0 986 441 560
TDI [9N2]	1,9	74	ATD		07.03-05.07	0 414 720 087	0 986 441 556
TDI [9N3]	1,9	74	ATD		04.05-12.09	0 414 720 087	0 986 441 556
			AXR		04.05-12.09	0 414 720 265	0 986 441 559
			BMT		05.06-12.09	0 414 720 363	0 986 441 568
		96	ASZ		04.05-12.09	0 414 720 089	0 986 441 557
			BLT		04.05-12.09	0 414 720 266	0 986 441 560
<b>Polo Sedan</b>							
1.9 TDI	1,9	74	ATD		11.02-07.06	0 414 720 087	0 986 441 556
<b>Sharan</b>							
1.9 TDI [7M8]	1,9	66	ANU		03.99-02.00	0 414 720 086	0 986 441 553
TDI [7M9, 7M6]	1,9	66	ANU		04.00-03.10	0 414 720 086	0 986 441 553
		96	ASZ		11.02-03.10	0 414 720 266	0 986 441 560
TDI, TDI 4Motion [7M9, 7M6]	1,9	85	AUY		05.00-03.10	0 414 720 088	0 986 441 554
			BVK		11.05-03.10	0 414 720 364	0 986 441 577
2.0 TDI [7M9, 7M6]	2,0	100/103	BRT; BVH		11.05-03.10	0 414 720 279	0 986 441 574
<b>Touareg</b>							
2.5 TDI [7LA]	2,5	120/128	BAC; BLK				
			Fg.-Nr. →7L..5..060 000		01.03-12.04	0 414 720 260	0 986 441 561
			Fg.-Nr. 7L..5..060 001→		01.05-11.06	0 414 720 278	0 986 441 573
			BPD; BPE		01.06-11.06	0 414 720 278	0 986 441 573
TDI [7L6]	2,5	120/128	BPD; BPE		12.06-05.10	0 414 720 278	0 986 441 573
5.0 TDI [7LA]	5,0	230	AYH				
			Fg.-Nr. →7L..3..020 000		11.02-05.03	0 414 720 260	0 986 441 561
			Fg.-Nr. 7L..4..000 001→		06.03-11.06	0 414 720 270	0 986 441 565
			BLE		11.04-05.05	0 414 720 305	0 986 441 576
					06.05-11.06	0 414 720 361	0 986 441 576
TDI [7L6]	5,0	230	BLE; BWF		12.06-05.10	0 414 720 361	0 986 441 576
		258	CBWA		08.07-05.10	0 414 720 359	0 986 441 578
<b>Touran</b>							
1.9 TDI [1T1]	1,9	66	BXJ		07.06-11.06	0 414 720 363	0 986 441 568
		66/77	BRU; BXE <D3W>; BXF		06.05-11.06	0 414 720 265	0 986 441 559
		74/77	AVQ; BKC		02.03-02.06	0 414 720 265	0 986 441 559
		77	BLS <D3W>		11.05-11.06	0 414 720 363	0 986 441 568
TDI [1T2]	1,9	66	BXJ		11.06-05.10	0 414 720 363	0 986 441 568
		66/77	BXE <D3W>; BXF		11.06-05.10	0 414 720 265	0 986 441 559
		77	BLS <D3W>		11.06-05.10	0 414 720 363	0 986 441 568
2.0 TDI [1T1]	2,0	100	AZV				
			Fg.-Nr. →1T..4..200 000		02.03-04.04	0 414 720 453	0 986 441 580
			Fg.-Nr. 1T..4..200 001→		05.04-11.06	0 414 720 454	0 986 441 566
		103	BKD				
			Fg.-Nr. →1T..4..133 827		08.03-02.04	0 414 720 453	0 986 441 580
			Fg.-Nr. 1T..4..133 828→1T..4..172 000		03.04-04.04	AG GS	0 414 720 454 0 986 441 566
			Fg.-Nr. 1T..4..172 001→		05.04-11.06	0 414 720 454	0 986 441 566
			BMM <D7N>		06.05-11.06	0 414 720 362	0 986 441 567
TDI [1T2]	2,0	100/103	AZV; BKD		11.06-05.10	0 414 720 454	0 986 441 566
		103	BMM <D7N>		11.06-05.10	0 414 720 362	0 986 441 567





0 444 ... 0 444 ... \* 0 444 ... \*\* F 01C ... 0 986 ...

**AUDI**

**A3**

1.6 TDI [8V1]	1,6	85	DDYA <DK8>; DGTE <DK8>	03.17→	4	025 042	** 600 266
2.0 TDI [8V1]	2,0	110	CRUA <DN4>	05.14-05.15	4	025 046	** 600 266
			DCYA <DN4>	05.17→	4	025 042	** 600 266
TDI, TDI quattro [8V1]	2,0	81/105/ 110	CRFA <DN1>; CRFC <DN6>; CRLB <DN4>	10.12-06.15	4	025 046	
				10.12→	4		** 600 266
				07.15→	4	025 042	
		110	DEJA <DN4>	05.15-06.15	4	025 046	
				05.15→	4		** 600 266
				07.15→	4	025 042	
		110/135	CUNA <DK7>; DBGA <DN4>	05.13-06.15	4	025 046	
				05.13-05.17	4		** 600 266
				07.15-05.17	4	025 042	
			DFGA <DN4>; DGCA <DK7>; DJGA <DK7>	05.17→	4	025 042	** 600 266

**A3 Limousine**

1.6 TDI [8VS]	1,6	85	DDYA <DK8>; DGTE <DK8>	03.17→	4	025 042	** 600 266
2.0 TDI [8VS]	2,0	110	CRUA <DN4>	05.14-05.15	4	025 046	** 600 266
			DCYA <DN4>	05.17→	4	025 042	** 600 266
TDI, TDI quattro [8VS]	2,0	81/105/ 110	CRFA <DN1>; CRFC <DN6>; CRLB <DN4>	05.13-06.15	4	025 046	
				05.13→	4		** 600 266
				07.15→	4	025 042	
		110	DBGA <DN4>	05.15-06.15	4	025 046	
				05.15-08.16	4		** 600 266
				07.15-08.16	4	025 042	
			DEJA <DN4>	05.15-06.15	4	025 046	
				05.15→	4		** 600 266
				07.15→	4	025 042	
		110/135	DFGA <DN4>; DGCA <DK7>; DJGA <DK7>	05.17→	4	025 042	** 600 266

**A3 Sportback**

1.6 TDI [8VA]	1,6	85	DDYA <DK8>; DGTE <DK8>	03.17→	4	025 042	** 600 266
2.0 TDI [8VA]	2,0	110	CRUA <DN4>	05.14-05.15	4	025 046	** 600 266
			DCYA <DN4>	05.17→	4	025 042	** 600 266
TDI, TDI quattro [8VA]	2,0	81/105/ 110	CRFA <DN1>; CRFC <DN6>; CRLB <DN4>	10.12-06.15	4	025 046	
				10.12→	4		** 600 266
				07.15→	4	025 042	
		110	DBGA <DN4>	05.15-06.15	4	025 046	
				05.15-08.16	4		** 600 266
				07.15-08.16	4	025 042	
			DEJA <DN4>	05.15-06.15	4	025 046	
				05.15→	4		** 600 266
				07.15→	4	025 042	
		110/135	DFGA <DN4>; DGCA <DK7>; DJGA <DK7>	05.17→	4	025 042	** 600 266











**A4**

2.0 TDI [8W2; B9]	2,0	90	DEUC <D45>	05.16-08.16	4	025 048	
TDI, TDI quattro [8W2; B9]	2,0	100/110/ 140	CZHA <DN4>; DESA <DE5>; DETA <DE5>; DEUA <DN4>; DEUB <D94>	05.15→	4	025 048	
3.0 TDI quattro [8K2; B8]	3,0	155/176/ 180	CAPA <D50>; CCLA <D50>; CCWA <D50>; CCWB <D1V>; CKVB <D43>	11.07-09.13	6	021 021	
TDI, TDI quattro [8W2; B9]	3,0	160/200	CRTC <DJ3>; CSWB <DD5>	05.15→	6	025 054	

**A4 Allroad**

2.0 TDI [8KH]	2,0	100/110/ 120/140	CNHA <DE5>; CNHC <D95>; CSUA <DN4>; CSUB <D94>	09.13-05.16	4	025 048	
TDI [8WH]	2,0	120/140	DESA <DE5>; DETA <DE5>; DETB <DE5>; DFVA <DE5>	01.16-08.16	4	025 048	



									<b>A</b>	<b>B</b>		
									0 444 ...	0 444 ...	*0 444 ...	**F 01C ... 0 986 ...
<b>3.0</b>	TDI [8KH]	3,0	180	CKVB <D43>	01.12-03.13	6				<b>021 021</b>		
					04.13-05.13	6				<b>021 035</b>		
				CKVC <D43>	05.13-04.16	6				<b>021 035</b>		
	TDI [8WH]	3,0	160/200	CRTC <DJ3>; CSWB <DD5>	01.16→	6				<b>025 054</b>		
<b>A4 Avant</b>												
<b>2.0</b>	TDI [8W5; B9]	2,0	90	DEUC <D45>	05.16-08.16	4				<b>025 048</b>		
	TDI, TDI quattro [8W5; B9]	2,0	100/110/ 140	CZHA <DN4>; DESA <DE5>; DETA <DE5>; DEUA <DN4>; DEUB <D94>	05.15→	4				<b>025 048</b>		
<b>3.0</b>	TDI quattro [8K5; B8]	3,0	155/176/ 180	CAPA <D50>; CCLA <D50>; CCWA <D50>; CCWB <D1V>; CKVB <D43>	04.08-09.13	6				<b>021 021</b>		
	TDI, TDI quattro [8W5; B9]	3,0	160/200	CRTC <DJ3>; CSWB <DD5>	05.15→	6				<b>025 054</b>		
<b>A5 Cabriolet</b>												
<b>2.0</b>	TDI, TDI quattro [8F7]	2,0	110/140	CNHA <DE5>; CSUA <DN4>	09.13-01.17	4				<b>025 048</b>		
<b>3.0</b>	TDI quattro [8F7]	3,0	160/180	CKVC <D43>; CKVD <DD5>	06.13-01.17	6				<b>021 035</b>		
	TDI, TDI quattro [F57]	3,0	160/210	CSWB <DD5>; DCPC <DV8>	11.16→	6				<b>025 054</b>		
<b>A5 Coupé</b>												
<b>2.0</b>	TDI, TDI quattro [F53]	2,0	100/110/ 140	CZHA <DN4>; DESA <DE5>; DETA <DE5>; DEUA <DN4>; DEUB <D94>; DFVA <DE5>	06.16→	4				<b>025 048</b>		
<b>3.0</b>	TDI quattro [8T3]	3,0	160	CKVD <DD5>	05.15-01.17	6				<b>021 035</b>		
			180	CKVC <D43>	06.13-01.17	6				<b>021 021</b>		
	TDI, TDI quattro [F53]	3,0	160/200/ 210	CRTC <DJ3>; CSWB <DD5>; DCPC <DV8>	06.16→	6				<b>025 054</b>		
<b>A5 Sportback</b>												
<b>2.0</b>	TDI [8TA]	2,0	100/110	CSUA <DN4>; CSUB <D94>	04.14-01.17	4				<b>025 048</b>		
	TDI, TDI quattro [F5A]	2,0	100/110/ 140	CZHA <DN4>; DESA <DE5>; DETA <DE5>; DEUA <DN4>; DEUB <D94>; DFVA <DE5>	06.16→	4				<b>025 048</b>		
<b>3.0</b>	TDI quattro [8F7]	3,0	160	CKVD <DD5>	05.15-01.17	6				<b>021 035</b>		
	TDI quattro [8TA]	3,0	180	CKVC <D43>	06.13-01.17	6				<b>021 021</b>		
	TDI, TDI quattro [F5A]	3,0	160/200/ 210	CRTC <DJ3>; CSWB <DD5>; DCPC <DV8>	10.16→	6				<b>025 054</b>		
<b>A6</b>												
<b>2.0</b>	TDI [4G; C7]	2,0	100/110/ 140	CNHA <DE5>; CSUD <DN4>; CSUE <D94>	11.13→	4				<b>025 048</b>		
	TDI, TDI quattro [4G; C7]	2,0	100/110/ 140	CZJA <DE5>; DDCA <D94>; DDCB <DN4>; DDDA <DE5>	05.15-08.16	4				<b>025 048</b>		
<b>3.0</b>	TDI [4G; C7]	3,0	155/160	CTCB <TH1>; CTCC <TH1>	09.14-07.15	6				<b>025 055</b>		
	TDI quattro [4G; C7]	3,0	155/160/ 200	CRTD <DJ3>; CRTE <DD5>; CRTF <D1V>	09.14→	6				<b>025 054</b>		
			176	CPNB <D50>	05.13→	6				<b>021 034</b>		
			180	CDUC <D43>	11.10-05.12 EU6	6				<b>021 021</b>		
				CKVB <D43>	11.11-05.12 EU6	6				<b>021 021</b>		
				CKVC <D43>	04.12-02.13 EU6	6				<b>021 021</b>		
				PR-Code 7MK	03.13-04.15 EU6	6				<b>021 035</b>		
			230	CGQB <DD3>	12.11-04.15	6				<b>021 034</b>		
			235/240	CVUA <TG1>; CVUB <DD6>	09.14→	6				<b>021 034</b>		
	TDI, TDI quattro [4G; C7]	3,0	155/160	CZVA <DD5>; CZVB <DD5>; CZVC <D1V>; CZVD <D1V>	08.15→	6				<b>025 054</b>		
<b>A6 Allroad</b>												
<b>3.0</b>	TDI [4G; C7]	3,0	140/155/ 160	CZVA <DD5>; CZVC <D1V>; CZVF <DJ0>	11.15→	6				<b>025 054</b>		
			155/160/ 200	CRTD <DJ3>; CRTE <DD5>; CRTF <D1V>	09.14→	6				<b>025 054</b>		
			180	CKVC <D43>	01.12-12.14	6				<b>021 021</b>		
			235	CVUA <TG1>	09.14→	6				<b>021 034</b>		
<b>A6 Avant</b>												
<b>2.0</b>	TDI, TDI quattro [4G; C7]	2,0	100/110/ 140	CNHA <DE5>; CSUD <DN4>; CSUE <D94>	11.13→	4				<b>025 048</b>		
				CZJA <DE5>; DDCA <D94>; DDCB <DN4>; DDDA <DE5>	05.15-08.16	4				<b>025 048</b>		





◀ AUDI						0 444 ...	0 444 ...	* 0 444 ...	** F 01C ...	0 986 ...
<b>3.0</b>	TDI [4G; C7]	3,0	155/160	CTCB <TH1>; CTCC <TH1>	09.14-07.15	6				
	TDI quattro [4G; C7]	3,0	155/160/200	CRTD <DJ3>; CRTE <DD5>; CRTF <D1V>	09.14→	6				
			180	CDUC <D43>	05.11-05.12	EU6	6			<b>021 021</b>
				CKVB <D43>	11.11-05.12	EU6	6			<b>021 021</b>
				CKVC <D43>	04.12-02.13	EU6	6			<b>021 021</b>
				PR-Code 7MK	03.13-04.15	EU6	6			<b>021 035</b>
			230	CGQB <DD3>	12.11-04.15		6			<b>021 034</b>
			235/240	CVUA <TG1>; CVUB <DD6>	09.14→		6			<b>021 034</b>
	TDI, TDI quattro [4G; C7]	3,0	155/160	CZVA <DD5>; CZVB <DD5>; CZVC <D1V>; CZVD <D1V>	08.15→		6			<b>025 054</b>
<b>A7 Sportback</b>										
<b>3.0</b>	TDI quattro [4G; C7]	3,0	155/160/200	CRTD <DJ3>; CRTE <DD5>; CRTF <D1V>	05.14-05.18		6			<b>025 054</b>
			180	CKVB <D43>; CKVC <D43>	11.11-03.15		6			<b>021 021</b>
			235/240	CVUA <TG1>; CVUB <DD6>	05.14-05.18		6			<b>021 034</b>
	TDI, TDI quattro [4G; C7]	3,0	140/155/160	CZVA <DD5>; CZVB <DD5>; CZVC <D1V>; CZVD <D1V>; CZVE <DJ0>; CZVF <DJ0>	08.15-05.18		6			<b>025 054</b>
			155/160	CTCB <TH1>; CTCC <TH1>	07.14-11.15	ULE	6			<b>021 034</b>
						6PL	6			<b>025 055</b>
<b>A8</b>										
<b>3.0</b>	TDI quattro [4H; D4]	3,0	155/176/190/193	CPNB <D50>; CTBA <DD7>; CTBB <TH1>; CTBD <DV7>	09.13-01.18	ULE	6			<b>021 034</b>
			176/184	CMHA <D13>; CPNA <TH1>	03.12-04.14	EU6	6			<b>021 021</b>
						ULE	6			<b>021 034</b>
			184	CDTC <TF1>	09.13-01.18	ULE	6			<b>021 034</b>
						Z25	6			<b>025 055</b>
	4.2 TDI quattro [4H; D4]	4,2	283	CTEC <TE5>	10.13-01.18		8			<b>021 034</b>
<b>Q2</b>										
<b>1.6</b>	TDI [GAB]	1,6	85	DDYA <DK8>	06.16-07.18		4			<b>025 042 ** 600 266</b>
<b>2.0</b>	TDI, TDI quattro [GAB]	2,0	105/110/140	CRFC <DN6>; DCYA <DN4>; DFGA <DN4>; DFHA <DE5>	07.16→		4			<b>025 042 ** 600 266</b>
<b>Q3</b>										
<b>2.0</b>	TDI, TDI quattro [8U]	2,0	88/100/110/135	CUVB <TL4>; CUVC <DN4>; CUVD <D90>; CUWA <DK7>; CYLA <DK7>; DBBA <DN4>; DFTA <DN4>; DFTB <DE9>; DFTC <D90>; DFUA <DK7>	11.14→		4			<b>025 046 ** 600 266</b>
<b>Q5</b>										
<b>2.0</b>	TDI quattro [8RB]	2,0	120/125	CGLA <D95>; CGLB <D93>	05.10-09.12		4			<b>021 021</b>
			125	CMGA <D93>	10.10-09.12		4			<b>021 021</b>
			130	CMGB <DE2>	06.12-03.13		4			<b>021 021</b>
					04.13-05.17		4			<b>021 035</b>
	TDI, TDI quattro [8RB]	2,0	100/105/120/130	CGLC <DE2>; CGLD <D95>; CJCA <D92>; CJCB <D94>	05.10-03.13		4			<b>021 021</b>
			110	CJCD <DN4>	04.13-05.17		4			<b>021 035</b>
					05.13-06.16		4			<b>021 035</b>
<b>3.0</b>	TDI quattro [8RB]	3,0	176/184/190	CPNB <D50>; CTBA <DD7>; CTBC <D51>	09.13-05.17		6			<b>021 034</b>
			180	CDUD <D43>	06.12-03.13		6			<b>021 021</b>
					04.13-05.17		6			<b>021 034</b>
<b>Q7</b>										
<b>3.0</b>	TDI [4LB]	3,0	165/176	CATA <D1T>; CCMA <D50>; CNRB <D50>	11.08-08.15		6			<b>021 021</b>
	TDI [4MB]	3,0	155/160/183/190/200	CRTC <DJ3>; CRTE <DD5>; CUEA <DD7>; CVMD <DD9>; CZZA <DD5>; CZZB <D1V>	01.15→		6			<b>025 054</b>
<b>SQ5</b>										
<b>3.0</b>	TDI quattro [8RB]	3,0	230	CGQB <DD3>	12.12-03.13		6			<b>021 021</b>
					04.13-05.15		6			<b>021 034</b>
			230/240/250	CVUB <DD6>; CVUC <DD3>; DEHA <DD4>	05.15-05.17		6			<b>021 034</b>





0 444 ... 0 444 ... \*0 444 ... \*\*F 01C ... 0 986 ...

<b>SQ7</b>							
4.0 TDI quattro [4MB]	4,0	310/320	CZAC <DK4>; DCDB <DJ7>	04.16→	8		<b>025 054</b>

**BENTLEY**

<b>Bentayga</b>							
4.0 TDI	4,0	310/320	CZAA; CZAC <DK4>	11.16→	8		<b>025 054</b>

**BMW**

<b>Serie M</b>							
<b>M 550 Touring</b> d xDrive [F 11]	3,0	280	N57 D30C	03.12-02.17	6		<b>025 010 ** 600 265</b>
<b>X 5 M 50</b> d xDrive [F 15]	3,0	280	N57 D30C	11.13→	6		<b>025 010 ** 600 265</b>
<b>X 6 M 50</b> d [F 16]	3,0	280	N57 D30C	11.14→	6		<b>025 010 ** 600 265</b>
<b>Serie X5</b>							
<b>25</b> d sDrive, d xDrive [F 15]	2,0	160/170	B47 D20B <B47>; N47 D20D	12.13→	4		<b>025 010 ** 600 265</b>
d xDrive [F 15]	3,0	160	N57 D30A <N57>	07.15→	6		<b>025 010 ** 600 265</b>
<b>30</b> d xDrive [E 70]	3,0	155-190	N57 D30A	04.10-06.13	6		<b>021 013 ** 600 210</b>
d xDrive [F 15]	3,0	190-210	N57 D30A <N57>	11.13→	6		<b>025 010 ** 600 265</b>
<b>40</b> d xDrive [F 15]	3,0	230	N57 D30B	03.14→	6		<b>025 010 ** 600 265</b>
<b>Serie X6</b>							
<b>30</b> d xDrive [E 71]	3,0	155-180	N57 D30A	04.10-06.14	6		<b>021 013 ** 600 210</b>
d xDrive [F 16]	3,0	155-210	N57 D30A	11.14→	6		<b>025 010 ** 600 265</b>
<b>40</b> d xDrive [F 16]	3,0	230	N57 D30B	12.14→	6		<b>025 010 ** 600 265</b>
<b>Serie 1</b>							
<b>114</b> d [F 20]	1,5	70	B37 D15A	07.15→	3		<b>025 010</b>
d [F 21]	1,5	70	B37 D15A	07.15→	3		<b>025 010</b>
<b>116</b> d, d ed [F 20]	1,5	85	B37 D15A	03.15→	3		<b>025 010</b>
d, d ed [F 21]	1,5	85	B37 D15A	03.15→	3		<b>025 010</b>
<b>118</b> d [F 21]	2,0	110	B47 D20A	03.15→	4		<b>025 010</b>
d, d xDrive [F 20]	2,0	110	B47 D20A	03.15→	4		<b>025 010</b>
<b>120</b> d, d xDrive [F 20]	2,0	140-151	B47 D20A	03.15→	4		<b>025 010</b>
d, d xDrive [F 21]	2,0	140-151	B47 D20A	03.15→	4		<b>025 010</b>
<b>125</b> d [F 20]	2,0	165	B47 D20B <B47>	03.15→	4		<b>025 010</b>
d [F 21]	2,0	165	B47 D20B <B47>	03.15→	4		<b>025 010</b>
<b>Serie 2 Cabrio</b>							
<b>218</b> d [F 23]	2,0	100-110	B47 D20A	07.15→	4		<b>025 010</b>
<b>220</b> d [F 23]	2,0	120-155	B47 D20A	11.14→	4		<b>025 010</b>
<b>225</b> d [F 23]	2,0	165	B47 D20B <B47>	07.15→	4		<b>025 010</b>
<b>Serie 2 Coupé</b>							
<b>218</b> d [F 22]	2,0	100-110	B47 D20A	07.15→	4		<b>025 010</b>
<b>220</b> d, d xDrive [F 22]	2,0	120-155	B47 D20A	11.14→	4		<b>025 010</b>
<b>225</b> d [F 22]	2,0	165	B47 D20B <B47>	07.15→	4		<b>025 010</b>
<b>Serie 3</b>							
<b>316</b> d [F 30]	2,0	85	B47 D20A	03.15→	4		<b>025 010 ** 600 265</b>
<b>318</b> d, d xDrive [F 30]	2,0	110	B47 D20A	07.15→	4		<b>025 010 ** 600 265</b>
<b>320</b> d, d ed, d xDrive [F 30]	2,0	120/140	B47 D20A	07.15→	4		<b>025 010 ** 600 265</b>
<b>325</b> D [F 30]	2,0	165	B47 D20B <B47>	03.16→	4		<b>** 600 265</b>
<b>330</b> d [F 30]	3,0	190-210	N57 D30A	07.12→	6		<b>025 029</b>
<b>335</b> d xDrive [F 30]	3,0	230	N57 D30B <N57Z>	07.13→	6		<b>025 029</b>
<b>Serie 3 GT</b>							
<b>318</b> d [F 34]	2,0	110	B47 D20A	07.15→	4		<b>025 010</b>
<b>320</b> d, d xDrive [F 34]	2,0	120-140	B47 D20A	07.15→	4		<b>025 010</b>
<b>330</b> d, d xDrive [F 34]	3,0	190-210	N57 D30A <N57>	03.14→	6		<b>025 029</b>
<b>335</b> d xDrive [F 34]	3,0	230	N57 D30B	03.14→	6		<b>025 029</b>
<b>Serie 3 Touring</b>							
<b>316</b> d [F 31]	2,0	85	B47 D20A	03.15→	4		<b>025 010 ** 600 265</b>
<b>318</b> d [F 31]	2,0	110	B47 D20A	07.15→	4		<b>025 010 ** 600 265</b>
d xDrive [F 31]	2,0	110	B47 D20A	07.15→	4		<b>** 600 265</b>
<b>320</b> d, d ed, d xDrive [F 31]	2,0	120/140	B47 D20A	07.15→	4		<b>025 010 ** 600 265</b>
<b>325</b> d [F 31]	2,0	165	B47 D20B <B47>	03.16→	4		<b>** 600 265</b>







BMW						0 444 ...	0 444 ...	* 0 444 ...	** F 01C ...	0 986 ...
<b>330 d, d xDrive [F 31]</b>	3,0	190-210	N57 D30A	09.12→	6		<b>025 029</b>			
<b>335 d xDrive [F 31]</b>	3,0	230	N57 D30B	11.13→	6		<b>025 029</b>			
<b>Serie 4 Cabrio</b>										
<b>420 d [F 33]</b>	2,0	120-140	B47 D20A	07.15→	4		<b>025 010</b>	<b>** 600 265</b>		
<b>425 d [F 33]</b>	2,0	165	B47 D20B <B47>	03.16→	4			<b>** 600 265</b>		
<b>430 d [F 33]</b>	3,0	190-210	N57 D30A	06.14→	6		<b>025 029</b>	<b>** 600 265</b>		
<b>435 d [F 33]</b>	3,0	230	N57 D30B	06.14→	6		<b>025 029</b>	<b>** 600 265</b>		
<b>Serie 4 Coupé</b>										
<b>418 d [F 32]</b>	2,0	100-110	B47 D20A	03.15→	4		<b>025 010</b>	<b>** 600 265</b>		
<b>420 d [F 32]</b>	2,0	120-140	B47 D20A	03.15→	4		<b>025 010</b>	<b>** 600 265</b>		
<b>425 d [F 32]</b>	2,0	165	B47 D20B <B47>	03.16→	4			<b>** 600 265</b>		
<b>430 d, d xDrive [F 32]</b>	3,0	190-210	N57 D30A; N57 D30A <N57>	11.13→	6		<b>025 029</b>	<b>** 600 265</b>		
<b>435 d xDrive [F 32]</b>	3,0	230	N57 D30B <N57Z>	11.13→	6		<b>025 029</b>	<b>** 600 265</b>		
<b>Serie 4 GC</b>										
<b>418 d [F 36]</b>	2,0	100-110	B47 D20A	07.15→	4		<b>025 010</b>	<b>** 600 265</b>		
<b>420 d, d xDrive [F 36]</b>	2,0	120-140	B47 D20A	03.15→	4		<b>025 010</b>	<b>** 600 265</b>		
<b>425 d [F 36]</b>	2,0	165	B47 D20B <B47>	03.16→	4			<b>** 600 265</b>		
<b>430 d [F 36]</b>	3,0	190-210	N57 D30A	06.14→	6		<b>025 029</b>	<b>** 600 265</b>		
d xDrive [E 36]	3,0	190-210	N57 D30A	06.14→	6		<b>025 029</b>	<b>** 600 265</b>		
<b>435 d xDrive [F 36]</b>	3,0	230	N57 D30B	06.14→	6		<b>025 029</b>	<b>** 600 265</b>		
<b>Serie 5</b>										
<b>520 d xDrive [F 10]</b>	2,0	120-155	B47 D20A; N47 D20C <N47N>	07.13-10.16	4		<b>025 010</b>	<b>** 600 265</b>		
<b>525 d xDrive [F 10]</b>	2,0	160	N47 D20D <N47S1>	09.11-10.16	4		<b>025 010</b>	<b>** 600 265</b>		
<b>530 d xDrive [F 10]</b>	3,0	190-210	N57 D30A	03.11-10.16	6		<b>025 010</b>	<b>** 600 265</b>		
<b>535 d xDrive [F 10]</b>	3,0	230	N57 D30B <N57Z>	09.11-10.16	6		<b>025 010</b>	<b>** 600 265</b>		
<b>Serie 5 GT</b>										
<b>520 d [F 07]</b>	2,0	120-135	N47 D20C	07.12-02.17	4		<b>025 010</b>	<b>** 600 265</b>		
<b>530 d xDrive [F 07]</b>	3,0	190	N57 D30A	07.12-02.17	6		<b>025 010</b>	<b>** 600 265</b>		
<b>535 d xDrive [F 07]</b>	3,0	230	N57 D30B <N57Z>	07.12-02.17	6		<b>025 010</b>	<b>** 600 265</b>		
<b>Serie 5 Touring</b>										
<b>520 d xDrive [F 11]</b>	2,0	120-140	B47 D20A; N47 D20C <N47N>	07.13-02.17	4		<b>025 010</b>	<b>** 600 265</b>		
<b>525 d xDrive [F 11]</b>	2,0	155-160	N47 D20D <N47S1>	09.11-02.17	4		<b>025 010</b>	<b>** 600 265</b>		
<b>530 d xDrive [F 11]</b>	3,0	190-210	N57 D30A	03.11-02.17	6		<b>025 010</b>	<b>** 600 265</b>		
<b>535 d xDrive [F 11]</b>	3,0	230	N57 D30B <N57Z>	09.11-02.17	6		<b>025 010</b>	<b>** 600 265</b>		
<b>Serie 7</b>										
<b>725 d [G 11]</b>	2,0	170	B47 D20B <B47>	06.17→	4		<b>025 010</b>	<b>** 600 265</b>		
Ld [G 12]	2,0	170	B47 D20B <B47>	06.17→	4		<b>025 010</b>	<b>** 600 265</b>		
<b>730 d, d xDrive [G 11]</b>	3,0	155-195	B57 D30A	09.15→	6		<b>025 029</b>	<b>** 600 265</b>		
Ld, Ld xDrive [G 12]	3,0	155-195	B57 D30A	09.15→	6		<b>025 029</b>	<b>** 600 265</b>		
<b>740 d xDrive [G 11]</b>	3,0	235	B57 D30B	11.15→	6		<b>025 029</b>	<b>** 600 265</b>		
Ld xDrive [G 12]	3,0	235	B57 D30B	11.15→	6		<b>025 029</b>	<b>** 600 265</b>		
<b>750 d xDrive [G 11]</b>	3,0	294	B57 D30C	07.16→	6		<b>025 029</b>	<b>** 600 265</b>		
Ld xDrive [G 12]	3,0	294	B57 D30C	07.16→	6		<b>025 029</b>	<b>** 600 265</b>		



## JAGUAR

<b>E-Pace</b>										
<b>D150 , AWD [X540]</b>	2,0	110	204DTD	09.17→	4		<b>021 050</b>			
<b>D180 AWD [X540]</b>	2,0	132	204DTD	09.17→	4		<b>021 050</b>			
<b>D240 AWD [X540]</b>	2,0	177	204DTA	09.17→	4		<b>021 050</b>			
<b>F-Pace</b>										
<b>E-Performance [X761]</b>	2,0	120	204DTD	02.17→	4		<b>021 050</b>			
<b>2.0 D AWD [X761]</b>	2,0	132	204DTD	04.16→	4		<b>021 050</b>			
<b>3.0 TDV6 AWD [X761]</b>	3,0	221	306DT	04.16→	6		<b>021 050</b>			
<b>XE</b>										
<b>2.0 E-performance</b>	2,0	120	204PT	06.15→	4		<b>021 049</b>			
<b>20d , AWD</b>	2,0	132	204DTD; 204PT	06.15→	4		<b>021 049</b>			
<b>XF</b>										
<b>2.0 E-Performance [X260]</b>	2,0	120	204PT	10.15→	4		<b>021 050</b>			
<b>20d , AWD [X260]</b>	2,0	132-177	204DTD	10.15→	4		<b>021 050</b>			
<b>30d [X260]</b>	3,0	221	306DT	10.15→	6		<b>021 050</b>			



0 444 ... 0 444 ... \*0 444 ... \*\*F 01C ... 0 986 ...

<b>XF Sportbrake</b>						
<b>20d</b> [X260]	2,0	132	204DTD	07.17→	4	<b>021 050</b>
<b>XJ</b>						
<b>3.0</b> DV6, DV6 S [X351]	3,0	202/221	AJV6D; 306DT	08.10→	6	<b>021 050</b>

**LAND ROVER GROUP**

<b>Discovery IV</b>						
<b>3.0</b> TDV6 [LA]	3,0	155/180-200	306DT	09.10→	EU6 6	<b>021 053</b>
<b>Discovery V</b>						
<b>2.0</b> Sd4 AWD, Td4 AWD [LR,B6]	2,0	132/177	AJ200 <204DTD>; 204DTA	04.17→	4	<b>021 042</b>
<b>3.0</b> Td6 AWD [LR,B6]	3,0	155-190	306DTX	04.17→	6	<b>021 042</b>
<b>Range Rover IV</b>						
<b>3.0</b> TD AWD [LG,L405]	3,0	155-190	306DT	02.13→	6	<b>021 042</b>
<b>4.4</b> SD AWD [LG,L405]	4,4	250	448DT	01.14→	8	<b>021 042</b>
<b>Range Rover Sport</b>						
<b>2.0</b> SD4 [LW,L494]	2,0	177	AJ200 <204DTD>	09.16→	4	<b>021 042</b>
<b>3.0</b> SDV6, TDV6 [LW,L494]	3,0	183-190/215-225	306DT; 306DTX	09.13→	6	<b>021 042</b>
<b>4.4</b> SDV8 [LW,L494]	4,4	250	448DT	01.14→	8	<b>021 042</b>

**MAZDA**

<b>CX-7</b>						
<b>2.2</b> MZR CD 4x4 [ER]	2,2	120/127	R2	06.09→	4	<b>021 012</b>

**MERCEDES-BENZ**

<b>Serie C</b>						
<b>180</b> BlueTec, d [205]	1,6	85	OM 626.951 <DE 16 LA>	05.14→	4	<b>025 017</b>
<b>200</b> BlueTec, d [205]	1,6	100	OM 626.951 <DE 16 LA>	05.14→	4	<b>025 017</b>
<b>220</b> BlueTec, d, d 4MATIC [205]	2,1	120/125	OM 651.921 <D 22 LHD>	11.13→	4	<b>025 017</b>
<b>250</b> BlueTec, BlueTec 4MATIC, d [205]	2,1	150	OM 651.921 <D 22 LHD>	02.14→	4	<b>025 017</b>
<b>Serie C (Cabrio)</b>						
<b>220</b> d, d 4MATIC [205]	2,1	125	OM 651.921 <D 22 LHD>	09.16→	4	<b>025 017</b>
<b>250</b> d [205]	2,1	150	OM 651.921 <D 22 LHD>	09.16→	4	<b>025 017</b>
<b>Serie C (Coupé)</b>						
<b>220</b> d, d 4MATIC [205]	2,1	120-125	OM 651.921 <D 22 LHD>	10.15→	4	<b>025 017</b>
<b>250</b> d, d 4MATIC [205]	2,1	150	OM 651.921 <D 22 LHD>	10.15→	4	<b>025 017</b>
<b>Serie C (T-Modell)</b>						
<b>180</b> BlueTec [205]	1,6	85	OM 626.951 <DE 16 LA>	05.14-12.15	4	<b>025 017</b>
<b>200</b> BlueTec [205]	1,6	100	OM 626.951 <DE 16 LA>	05.14-12.15	4	<b>025 017</b>
<b>220</b> d BlueTec, d 4MATIC [205]	2,1	125	OM 651.921 <D 22 LHD>	05.14→	4	<b>025 017</b>
<b>250</b> BlueTec, BlueTec 4MATIC, d [205]	2,1	150	OM 651.921 <D 22 LHD>	05.14→	4	<b>025 017</b>
<b>Serie C (T-Serie)</b>						
<b>220</b> d [205]	2,1	125	OM 651.921 <D 22 LHD>	12.15→	4	<b>025 017</b>
<b>Serie CLS (Coupé)</b>						
<b>220</b> BlueTec, d [218]	2,1	120-130	OM 651.924 <D 22 LHD>	05.14→	4	<b>021 033</b>
<b>250</b> BlueTec, BlueTec 4MATIC, d, d 4MATIC [218]	2,1	150	OM 651.924 <D 22 LHD>	05.14→	4	<b>021 033</b>
<b>350</b> BlueTec [218]	3,0	185-190	OM 642.85... <D 30>; OM 642.853 <D 30>			
			Mod.Jahr →2012	11.12-02.16	6	<b>021 024</b>
			Mod.Jahr 2013→	11.12-02.16	6	<b>021 033</b>
d, d 4MATIC [218]	3,0	190	OM 642.85... <D 30>; OM 642.853 <D 30>	04.15→	6	<b>021 033</b>





◀ MERCEDES-BENZ

0 444 ... 0 444 ... \*0 444 ... \*\* F01C ... 0 986 ...

Serie CLS (Shooting Brake)							
220 BlueTec, d [218]	2,1	120-130	OM 651.924 <D 22 LHD>	05.14→	4		021 033
250 BlueTec, BlueTec 4MATIC, d [218]	2,1	150	OM 651.924 <D 22 LHD>	05.14→	4		021 033
350 BlueTec, BlueTec 4MATIC, CDI 4MATIC, d 4MATIC [218]	3,0	185-190/195	OM 642.85... <D 30>; OM 642.854 <D 30>	10.12→	6		021 033
Serie E							
200 BlueTec [212]	2,1	100	OM 651.925 <D 22 LHD RED>	07.14-08.16	4		021 033
220 BlueTec, BlueTec 4MATIC, CDI [212]	2,1	120-130	OM 651.924 <D 22 LL>	12.08-08.16	4		021 033
250 BlueTec, BlueTec 4MATIC, CDI, CDI 4MATIC [212]	2,1	150	OM 651.924 <D 22 LHD>; OM 651.924 <D 22 LL>	12.08-08.16	4		021 033
300 BlueTec [212]	3,0	170	OM 642.852 <D 30>	08.12-08.16	6		021 033
CDI [212]	3,0	150/170	OM 642.850 <D 30>	12.09-12.13	6		021 024
		170	OM 642.852 <D 30>	08.11-12.13	6		021 024
350 BlueTec [212]	3,0	155	OM 642.850 <D 30>	04.09-12.13 TW	6		021 024
					6		021 033
		185-190	OM 642.852 <D 30>	08.12-08.16	6		021 033
BlueTec 4MATIC [212]	3,0	185-190	OM 642.85... <D 30>	08.12-08.16	6		021 033
CDI [212]	3,0	170	OM 642.850 <D 30>	08.08-11.10	6		021 024
		195	OM 642.852 <D 30>	12.10-12.13	6		021 024
CDI 4MATIC [212]	3,0	170/195	OM 642.856 <D 30>; OM 642.858 <D 30>	04.09-12.13	6		021 024
d, d 4MATIC [213]	3,0	190	OM 642.855 <D 30>; OM 642.873 <D30 LHD>	01.16→	6		025 017
Serie E (Cabrio)							
220 BlueTec, d [207]	2,1	125-130	OM 651.911 <D 22 G>	05.14-04.17	4		021 033
250 BlueTec, d [207]	2,1	150	OM 651.911 <D 22 G>	07.14-04.17	4		021 033
350 BlueTec [207]	3,0	185-190	OM 642.838 <D 30>	01.13-08.15	6		021 033
d 4MATIC [238]	3,0	190	OM 642.873 <D30 LHD>	09.17→	6		025 017
Serie E (Coupé)							
220 BlueTec, d [207]	2,1	125-130	OM 651.911 <D 22 G>	05.14-11.16	4		021 033
250 BlueTec, d [207]	2,1	150	OM 651.911 <D 22 G>	07.14-11.16	4		021 033
350 BlueTec [207]	3,0	185-190	OM 642.838 <D 30>	01.13-08.15	6		021 033
d 4MATIC [238]	3,0	190	OM 642.873 <D30 LHD>	06.17→	6		025 017
Serie E (T-Modell)							
200 BlueTec [212]	2,1	100	OM 651.925 <D 22 LHD RED>	07.14-08.16	4		021 033
CDI [212]	2,1	100	OM 651.925 <D 22 LHD RED>	08.09-08.14	4		021 024
220 BlueTec, BlueTec 4MATIC [212]	2,1	125	OM 651.924 <D 22 LHD>	07.14-08.16	4		021 033
CDI [212]	2,1	125	OM 651.924 <D 22 LHD>	08.09-08.14	4		021 024
250 BlueTec, BlueTec 4MATIC [212]	2,1	150	OM 651.924 <D 22 LHD>	07.14-08.16	4		021 033
CDI, CDI 4MATIC [212]	2,1	150	OM 651.924 <D 22 LHD>	08.09-08.14	4		021 024
300 BlueTec [212]	3,0	170	OM 642.852 <D 30>	08.12-08.16	6		021 033
CDI [212]	3,0	150	OM 642.850 <D 30>	12.09-12.10	6		021 024
		170	OM 642.852 <D 30>	08.11-12.13	6		021 024
350 BlueTec [212]	3,0	155	OM 642.850 <D 30>				
			Mod.Jahr →2012	08.09-12.13	6		021 024
			Mod.Jahr 2013→	08.09-12.13	6		021 033
		185	OM 642.852 <D 30>	08.12-08.16	6		021 033
BlueTec 4MATIC [212]	3,0	185-190	OM 642.85... <D 30>	08.12-08.16	6		021 033
CDI [212]	3,0	170	OM 642.850 <D 30>	08.09-11.10	6		021 024
		195	OM 642.852 <D 30>	12.10-12.13	6		021 024
CDI 4MATIC [212]	3,0	170/195	OM 642.856 <D 30>; OM 642.858 <D 30>	08.09-12.13	6		021 024
d, d All-Terrain 4Matic [213]	3,0	190	OM 642.855 <D 30>; OM 642.873 <D30 LHD>	06.16→	6		025 017
Serie G							
350 BlueTec, d [463]	3,0	155-165/180	OM 642...; OM 642.886; OM 642.887	07.10→	6		021 024
Serie GL							
320 CDI BlueTec 4MATIC [164]	3,0	155	OM 642.820 <D 30>	09.08-08.09	6		021 024
CDI BlueTec 4MATIC [164]	3,0	155	OM 642.820 <D 30>	04.09-12.12	6		021 024





									0 444 ...	0 444 ...	*0 444 ... **F 01C ... 0 986 ...
<b>350 CDI BlueTec 4MATIC [166]</b>	3,0	190	OM 642.826 <D 30>								
			Mod.Jahr →2013	08.12-12.15		6					<b>021 024</b>
			Mod.Jahr 2014→	08.12-12.15		6					<b>025 005</b>
<b>Serie GLC</b>											
<b>200 d [253]</b>	2,1	100	OM 651.921 <D 22 LHD>	05.16→		4					<b>025 017</b>
<b>250 d 4MATIC [253]</b>	2,1	150	OM 651.921 <D 22 LHD>	07.15→		4					<b>025 017</b>
<b>350 d 4MATIC [253]</b>	3,0	190	OM 642.873 <D30 LHD>	09.16→		6					<b>025 017</b>
<b>Serie GLC (Coupé)</b>											
<b>220 d 4MATIC [253]</b>	2,1	120-125	OM 651.921 <D 22 LHD>	10.16→		4					<b>025 017</b>
<b>250 d 4MATIC [253]</b>	2,1	150	OM 651.921 <D 22 LHD>	10.16→		4					<b>025 017</b>
<b>350 d 4MATIC [253]</b>	3,0	190	OM 642.873 <D30 LHD>	10.16→		6					<b>025 017</b>
<b>Serie GLE</b>											
<b>250 d, d 4MATIC [166]</b>	2,1	150	OM 651.960 <D 22 LHD>	04.15→	TW	4					<b>021 024</b>
						4					<b>025 005</b>
<b>350 d 4MATIC [166]</b>	3,0	190	OM 642.826 <D 30>	04.15→	TW	6					<b>021 024</b>
						6					<b>025 005</b>
<b>Serie GLE (Coupé)</b>											
<b>350 d 4MATIC [292]</b>	3,0	190	OM 642.826 <D 30>	04.15→	TW	6					<b>021 024</b>
						6					<b>025 005</b>
<b>Serie GLK</b>											
<b>200 CDI [204]</b>	2,1	100-105	OM 651.91... <D 22 LHD RED>	07.10-08.15		4					<b>021 024</b>
<b>220 BlueTec 4MATIC, CDI [204]</b>	2,1	120-125	OM 651.912 <D 22 LHD>; OM 651.916 <D 22 LHD>	04.09-08.16		4					<b>021 024</b>
<b>250 BlueTec 4MATIC [204]</b>	2,1	150	OM 651.912 <D 22 LHD>	03.12-08.16		4					<b>021 024</b>
<b>Serie GLS</b>											
<b>350 d [166]</b>	3,0	190	OM 642.826 <D 30>	09.15→	TW	6					<b>021 024</b>
						6					<b>025 005</b>
<b>Serie ML</b>											
<b>250 CDI BlueTec 4MATIC [166]</b>	2,1	150	OM 651.960 <D 22 LHD>								
			Mod.Jahr →2013	06.11-08.15		4					<b>021 024</b>
			Mod.Jahr 2014→	06.11-08.15		4					<b>025 005</b>
<b>300 CDI 4MATIC [164]</b>	3,0	150	OM 642.820 <D 30>	05.09-07.11		6					<b>021 024</b>
<b>350 BlueTec 4MATIC [166]</b>	3,0	190	OM 642.826 <D 30>								
			Mod.Jahr →2013	06.11-08.15		6					<b>021 024</b>
			Mod.Jahr 2014→	06.11-08.15		6					<b>025 005</b>
BlueTec 4MATIC, CDI 4MATIC [164]	3,0	155/165/170	OM 642.820 <D 30>; OM 642.940 <D 30>	05.09-08.11		6					<b>021 024</b>
<b>Serie R</b>											
<b>350 BlueTec 4MATIC [251]</b>	3,0	155	OM 642.870 <D 30>	05.09-10.12		6					<b>021 024</b>
<b>Serie S</b>											
<b>350 BlueTec, BlueTec 4MATIC [221]</b>	3,0	190	OM 642.862 <D 30>; OM 642.868 <D 30>	07.10-12.13		6					<b>021 024</b>
BlueTec, BlueTec 4MATIC, d, d 4MATIC [222]	3,0	185-190	OM 642.861 <D 30>; OM 642.867 <D 30>	05.13→		6					<b>025 003</b>
<b>Serie SLK</b>											
<b>250 CDI [172]</b>	2,1	150	OM 651.980 <D 22 LHD GST>	09.11-08.16		4					<b>025 008</b>

**OPEL**

<b>Insignia</b>											
<b>2.0 CDTI, CDTI 4x4 [A]</b>	2,0	125	B 20 DTH	01.15-12.17		4					<b>021 038</b>
<b>Insignia Sports Tourer</b>											
<b>2.0 CDTI [A]</b>	2,0	125	B 20 DTH	01.15-12.17		4					<b>021 038</b>
<b>Mokka</b>											
<b>1.6 , 4x4</b>	1,6	100	<LVL>	02.15→		4					<b>021 038</b>
<b>Zafira</b>											
<b>1.6 CDTI [C]</b>	1,6	88/100	B 16 DTH; B 16 DTL	05.13→		4					<b>021 038</b>
<b>2.0 CDTI [C]</b>	2,0	96/125	B 20 DTH; B 20 DTJ	02.15→		4					<b>021 038</b>





0 444 ... 0 444 ... \*0 444 ... \*\* F01C... 0 986 ...

**PORSCHE**

<b>Cayenne</b>						
3.0 Diesel [92A]	3,0	155/184/ 193	MCV.VA <DD7>; MCV.VB <D51>; MCV.VC <D1V>	09.14-08.17	6	<b>025 025</b>
<b>Cayenne S</b>						
4.2 [92A]	4,1	283	MCU.DC <DD8>	09.14→	8	<b>025 025</b>
<b>Macan S</b>						
3.0 Diesel [95B]	3,0	155/176/ 184/190	MCN.RB <D50>; MCP.NB <D50>; MCT.BA <DD7>; MCT.BB <D1V>; MCT.BC	03.14→	6	<b>025 022</b>
<b>Panamera Sport Turismo 4S</b>						
4.0 Diesel [971]	4,0	310	MDB.U... <DJ7>	03.17→	8	<b>025 058</b>
<b>Panamera 4S</b>						
4.0 Diesel [971]	4,0	310	MDB.U... <DJ7>	11.16→	8	<b>025 058</b>

**RENAULT**

<b>Talisman</b>						
1.6 dCi [LP]	1,6	118	R9M 452	12.15→	4	<b>021 045 ** 600 343</b>
<b>Talisman Grandtour</b>						
1.6 dCi [KP]	1,6	118	R9M 452	03.16→	4	<b>021 045 ** 600 343</b>

**SEAT**

<b>Alhambra</b>						
2.0 TDI, TDI 4Drive [710]	2,0	85/100/ 103/125/ 130	CFFA; CFFB <D91>; CFFE <DE4>; CFGB <D93>; CFGC <DE2>	05.10-07.15	4	<b>021 021 ** 600 194</b>

**SKODA**

<b>Karoq</b>						
2.0 TDI 4x4 [NU7]	2,0	110	DFFA <DN4>	07.17→	4	<b>025 042 ** 600 266</b>
<b>Kodiaq</b>						
2.0 TDI, TDI 4x4 [NS7]	2,0	110/140	DBGA <DN4>; DBGC <DN4>; DFGA <DN4>; DFHA <DE5>	03.17→	4	<b>025 042 ** 600 266</b>
<b>Superb</b>						
1.6 TDI [3V3]	1,6	88	DCXA <DK5>; DCZA <DN8>	05.15→	4	<b>025 042 ** 600 266</b>
2.0 TDI, TDI 4x4 [3V3]	2,0	110/140	CRLB <DN4>; DDAA <DE5>; DFCA <DE5>; DFEA <DN4>; DFGA <DN4>; DFHA <DE5>	05.15→	4	<b>025 042 ** 600 266</b>
<b>Superb Combi</b>						
1.6 TDI [3V5]	1,6	88	DCXA <DK5>; DCZA <DN8>	05.15→	4	<b>025 042 ** 600 266</b>
2.0 TDI, TDI 4x4 [3V5]	2,0	110/140	CRLB <DN4>; DDAA <DE5>; DFCA <DE5>; DFEA <DN4>; DFGA <DN4>; DFHA <DE5>	05.15→	4	<b>025 042 ** 600 266</b>
<b>Yeti</b>						
2.0 TDI, TDI 4x4 [5L7]	2,0	81/110	CUUA <DN1>; CUUB <DN4>; DFSA <DN1>; DFSB <DN4>	05.15-12.17	4	<b>021 021 ** 600 266</b>

**VAUXHALL**

<b>Insignia</b>						
2.0 CDTI, CDTI 4x4 [A]	2,0	125	B 20 DTH	01.15-12.17	4	<b>021 038</b>
<b>Insignia Sports Tourer</b>						
2.0 CDTI, CDTI 4x4 [A]	2,0	125	B 20 DTH	01.15-12.17	4	<b>021 038</b>



0 444 ... 0 444 ... \*0 444 ... \*\*F 01C ... 0 986 ...

<b>Mokka</b>							
1.6 , 4x4	1,6	100	<LVL>	02.15→	4		<b>021 038</b>
<b>Zafira</b>							
1.6 CDTI [C]	1,6	100	B 16 DTH	05.13→	4		<b>021 038</b>
2.0 CDTI [C]	2,0	125	B 20 DTH	02.15→	4		<b>021 038</b>

**VW (VOLKSWAGEN)**

<b>Amarok</b>							
2.0 TDI, TDI 4Motion [S6, S7]	2,0	103/132	CNEA <D49>; CNFB <D91>; CSHA <D49>	06.16→	4		<b>025 045 ** 600 266</b>
3.0 TDI, TDI 4Motion, TDI 4MOTION [S6, S7]	3,0	120/150/165	DDXA <DJ1>; DDXB <D1Q>; DDXC <D4E>; DDXD <D4E>	06.16→	6		<b>025 045 ** 600 266</b>
<b>Arteon</b>							
2.0 TDI, TDI 4Motion [3H7]	2,0	110/140/176	CUAA <DK9>; DBGA <DN4>; DFGA <DN4>; DFHA <DE5>	03.17→	4		<b>025 042 ** 600 266</b>
<b>Beetle</b>							
2.0 TDI [5C2]	2,0	81/110	CUUA <DN1>; CUUB <DN4>	07.16→	4		<b>** 600 266</b>
<b>Beetle Cabriolet</b>							
2.0 TDI [5C7]	2,0	81/110	CUUA <DN1>; CUUB <DN4>	12.14-07.16	4		<b>025 020 ** 600 266</b>
TDI [5C8]	2,0	81/110	CUUA <DN1>; CUUB <DN4>	07.16→	4		<b>** 600 266</b>
<b>Caddy</b>							
1.6 TDI [SA]	1,6	55/75	CAYD <D27>; CAYE <D37>	05.15→	4		<b>** 600 266</b>
					RLE	4	<b>021 021</b>
2.0 TDI, TDI 4Motion [SA]	2,0	55/75/81/90/103/110	CFHC <D91>; CFHF <D96>; CUUB <DN4>; CUUC <DS2>; CUUD <M0H>; CUUE <DN9>; CUUF <DS2>; DFSB <DN4>; DFSC <DS2>; DFSD <M0H>; DFSE <DN9>; DFSF <DS2>	05.15→	4		<b>** 600 266</b>
					RLE	4	<b>021 021</b>
<b>CC</b>							
2.0 TDI, TDI 4Motion [358]	2,0	103/110/135	CFFB <D91>; CUVC <DN4>; CUWA <DK7>	11.11-12.16	4		<b>021 021 ** 600 194</b>
<b>Golf Alltrack</b>							
2.0 GTD 4Motion, TDI, TDI 4Motion [BV5]	2,0	110/135	CRLB <DN4>; DCYA <DN4>; DGCA <DK7>	11.16→	4		<b>** 600 266</b>
GTD 4Motion, TDI 4Motion [BA5]	2,0	110/135	CRBC <DN4>; CRLB <DN4>; CUNA <DK7>	12.14-03.17	4		<b>025 042 ** 600 266</b>
<b>Golf Sportsvan</b>							
1.6 TDI [AM1]	1,6	66/85	DDYA <DK8>; DDYB <D36>	11.16→	4		<b>025 042 ** 600 266</b>
2.0 TDI [AM1]	2,0	110	DCYA <DN4>	11.16→	4		<b>025 042 ** 600 266</b>
<b>Golf VII</b>							
1.6 TDI [BQ1]	1,6	66/77/85	CLHA <D38>; DDYA <DK8>; DDYB <D36>	11.16→	4		<b>** 600 266</b>
TDI, TDI 4Motion [5G1]	1,6	66/77/81	CLHA <D38>; CLHB <D36>; CRKA <D36>; CRKB <DK5>; CXXA <D36>; CXXB <DK5>; DBKA <DK5>	08.12-03.17	4		<b>025 042 ** 600 266</b>
2.0 GTD, TDI, TDI 4Motion [BQ1]	2,0	81/110/135	CRBC <DN4>; CRLB <DN4>; CRLD <DN1>; CYKB <DN1>; DCYA <DN4>; DCYB <DN1>; DEJA <DN4>; DEJB <DN1>; DGCA <DK7>	11.16→	4		<b>** 600 266</b>
GTD, TDI, TDI 4Motion, TSI 4Motion [5G1]	2,0	81/105/110/135	CRBB <DN6>; CRBC <DN4>; CRLB <DN4>; CRVA <DN1>; CRVC <DN6>; CUNA <DK7>; CYKB <DN1>; DEJA <DN4>; DEJB <DN1>	08.12-03.17	4		<b>025 042 ** 600 266</b>
<b>Golf VII Variant</b>							
1.6 TDI [BV5]	1,6	66/85	DDYA <DK8>; DDYB <D36>	11.16→	4		<b>** 600 266</b>







◀ VW 0 444 ... 0 444 ... \* 0 444 ... \*\* F 01C ... 0 986 ...

2.0 GTD, TDI, TDI 4Motion [BV5]	2,0	81/110/135	CRBC <DN4>; CRLB <DN4>; CRLD <DN1>; CYKB <DN1>; DCYA <DN4>; DCYB <DN1>; DEJA <DN4>; DEJB <DN1>; DGCA <DK7>	11.16→	4		<b>** 600 266</b>
TDI, TDI 4Motion [BA5]	2,0	81/110/135	CRBC <DN4>; CRLB <DN4>; CRLD <DN1>; CRVA <DN1>; CUNA <DK7>; CYKB <DN1>; DEJA <DN4>; DEJB <DN1>	04.13-03.17	4	025 042	<b>** 600 266</b>

<b>Passat</b>							
1.6 TDI [3G2]	1,6	88	DCZA <DN8>	05.15→	4	025 042	<b>** 600 266</b>
2.0 TDI [A32]	2,0		CKRA	09.11-08.14	4	021 021	<b>** 600 194</b>
TDI [3C2]	2,0	105	CBAC <D92>	11.08-11.10	4	021 021	<b>** 600 194</b>
TDI, TDI 4Motion [3G2]	2,0	81/110/140	CRLD <DN1>; DFCA <DE5>; DFEA <DN4>; DFGA <DN4>; DFHA <DE5>	05.15→	4	025 042	<b>** 600 266</b>
TDI, TDI 4Motion [362]	2,0	100/103/125/130	CFFA <D94>; CFFB <D91>; CFGB <D93>; CFGC <DE2>; CLLA <D93>	08.10-12.14	4	021 021	<b>** 600 194</b>

<b>Passat Alltrack</b>							
2.0 TDI, TDI 4Motion [3G5]	2,0	110/140	DFCA <DE5>; DFEA <DN4>; DFGA <DN4>; DFHA <DE5>	05.15→	4	025 042	<b>** 600 266</b>
TDI, TDI 4Motion [365]	2,0	103/125/130	CFFB <D91>; CFGB <D93>; CFGC <DE2>	01.12-12.14	4	021 021	<b>** 600 194</b>

<b>Passat CC</b>							
2.0 TDI, TDI 4Motion [357]	2,0	103/105	CBAC <D92>; CFFB <D91>	05.09-05.12	4	021 021	<b>** 600 194</b>

<b>Passat Variant</b>							
1.6 TDI [3G5]	1,6	88	DCZA <DN8>	05.15→	4	025 042	<b>** 600 266</b>
2.0 TDI [3C5]	2,0	105	CBAC <D92>	11.08-11.10	4	021 021	<b>** 600 194</b>
TDI, TDI 4Motion [3G5]	2,0	81/110/140	CRLD <DN1>; DFCA <DE5>; DFEA <DN4>; DFGA <DN4>; DFHA <DE5>	05.15→	4	025 042	<b>** 600 266</b>
TDI, TDI 4Motion [365]	2,0	100/103/125/130	CFFA <D94>; CFFB <D91>; CFGB <D93>; CFGC <DE2>; CLLA <D93>	08.10-12.14	4	021 021	<b>** 600 194</b>

<b>Polo</b>							
1.6 TDI [AW1]	1,6	59/70	DGTC <DA8>; DGTD <DA9>	11.17→	4	025 042	<b>** 600 266</b>

<b>Sharan</b>							
2.0 TDI, TDI 4Motion [7N1]	2,0	85/100/103/125/130	CFFA <D94>; CFFB <D91>; CFFE <DE4>; CFGB <D93>; CFGC <DE2>	05.10-11.15	4	021 021	<b>** 600 194</b>
TDI, TDI 4Motion [7N2]	2,0	85/110/135	CUVA <DE4>; CUVC <DN4>; CUWA <DK7>; DFLA <DN4>; DFLD <DE4>; DFMA <DK7>	05.15→	4	025 020	<b>** 600 266</b>

<b>Tiguan</b>							
1.6 TDI [AD1]	1,6	85	DGDB <DK8>	05.16→	4	025 042	<b>** 600 266</b>
2.0 TDI, TDI 4Motion [AD1]	2,0	85/110/140	DFGA <DN4>; DFGC <DE4>; DFHA <DE5>	01.16→	4	025 042	<b>** 600 266</b>
TDI, TDI 4Motion [5N2]	2,0	81/110/135	CUVC <DN4>; CUVE <DN1>; CUWA <DK7>	05.15-12.16	4	025 020	<b>** 600 266</b>
TDI 4Motion [AD1]	2,0	176	CUAA <DK9>	05.16→	4	025 049	<b>** 600 266</b>

<b>Tiguan Allspace</b>							
2.0 TDI, TDI 4Motion [BW2]	2,0	110/140	DFGA <DN4>; DFHA <DE5>	06.17→	4	025 042	<b>** 600 266</b>
TDI 4Motion [BW2]	2,0	176	CUAA <DK9>	06.17→	4	025 049	<b>** 600 266</b>

<b>Touareg</b>							
3.0 TDI [CR7]	3,0	183/190/210	CVMC <DD7>; CVMD <DD9>; DENA <DV8>	11.17-02.18	6	025 054	
TDI [7P5]	3,0	150/180	CJMA; CRCA <D43>	05.11-12.14	6	021 021	<b>** 600 194</b>
TDI [7P6]	3,0	150/193	CVVA <DV7>; CVWA <D1Q>	08.14→	6		<b>** 600 194</b>
					UV2 6	021 034	

4.2 TDI [7P5]	4,2	250	CKDA <D57>	01.10-12.14	8	021 021	<b>** 600 194</b>
---------------	-----	-----	------------	-------------	---	---------	-------------------

<b>Touran</b>							
1.6 TDI [5T1]	1,6	81/85	CRKB <DK5>; DGDA <DK8>	05.15→	4	025 042	<b>** 600 266</b>



							0 444 ...	0 444 ...	* 0 444 ...	** F 01C ... 0 986 ...
<b>2.0 TDI [5T1]</b>	2,0	81/110/ 140	CRVA <DN1>; CYKB <DN1>; DFEA <DN4>; DFEB <DN1>; DFGA <DN4>; DFGB <DN1>; DFHA <DE5>	05.15→	4			<b>025 042</b>	<b>** 600 266</b>	
<b>T-Roc</b>										
<b>2.0 TDI, TDI 4Motion [A11]</b>	2,0	110	DFFA <DN4>	09.17→	4			<b>025 042</b>	<b>** 600 266</b>	





0 444 ... 0 444 ... \*0 444 ...  
 \*\* F01C... 0 986 ...

**ASTRA**

HD9C-Serie						
<b>HD9</b>	12,9	302/353/ 382/412 368/412	F3B E3681F; F3BE3681A; F3BE3681D; F3BE3681E F3HFE611A+; F3HFE611B+	01.12→  10.15→	6  6	<b>023 058</b>  <b>043 150</b>
HD9-Series						
<b>12.9</b>	12,9	324/353	F3B E0681 <Euro 3>	01.12→	6	<b>023 058</b>

**DAF**

CF						
<b>75</b> .250, .310, .360	9,2	183/228/ 265	PR 183 <Euro 4/5/EEV>; PR 228 <Euro 3/4/5/EEV>; PR 265 <Euro 4/5/EEV>	04.06→	6 THD,TW 6 6 TW 6 6 6	<b>012 003</b>    <b>011 013</b> <b>011 023</b> <b>011 024</b>  <b>*010 021</b> <b>*010 036 44D 002</b>
<b>76</b> .290, .330, .370 [Euro 6]	10,8	210/240/ 271	MX-11.210 <Euro 6>; MX-11.240 <Euro 6>; MX-11.271 <Euro 6>	09.13→	6	<b>043 033</b>
<b>85</b> .360, .410, .460, .510	12,9	265/300/ 340/375	MX 265 <Euro 3/4/5/EEV>; MX 300 <Euro 3/4/5/EEV>; MX 340 <Euro 4/5/EEV>; MX 375 <Euro 4/5/EEV>	04.06→	6 THD,TW 6 6 TW 6 6 6	<b>012 003</b>    <b>011 013</b> <b>011 023</b> <b>011 024</b>  <b>*010 021</b> <b>*010 036 44D 002</b>
<b>86</b> .400, .440 [Euro 6]	10,8	291/320	MX-11.291 <Euro 6>; MX-11.320 <Euro 6>	09.13→	6	<b>043 033</b>
.410, .460, .510 [Euro 6]	12,9	303/340/ 375	MX-13.300 <Euro 6>; MX-13.340 <Euro 6>; MX-13.375 <Euro 6>	07.13→	6	<b>043 033</b>
XF						
<b>95</b> .460	12,9	340	MX 340 <Euro 4>	11.03-10.05	6 THD,TW 6 TW 6 6	<b>012 003</b>  <b>011 013</b> <b>011 023</b>
.560	12,9	410	MX 410 <Euro 3/4>	11.03-12.04	6	<b>011 023</b>
<b>105</b> .410, .460, .510 [Euro 6]	12,9	302/339/ 375	MX 300 <Euro 3/4/5>; MX 340 <Euro 3/4/5>; MX 375 <Euro 4/5>	01.06→	6 THD,TW 6 6 TW 6 6 6	<b>012 003</b>    <b>011 013</b> <b>011 023</b> <b>011 024</b>  <b>*010 021</b> <b>*010 036 44D 002</b>
.560 [Euro 6]	12,9	410	MX 410 <Euro 3/4>	02.04-12.05	6 THD,TW 6 TW 6 6	<b>012 003</b>  <b>011 013</b> <b>011 023</b>
<b>106</b> .410, .460, .510 [Euro 6]	12,9	303/340/ 375	MX-13.300 <Euro 6>; MX-13.340 <Euro 6>; MX-13.375 <Euro 6>	11.12→	6	<b>043 033</b>
.440 [Euro 6]	10,8	320	MX-11.320 <Euro 6>	09.13→	6	<b>043 033</b>

**FIAT**

Ducato 14						
<b>130</b> MultiJet [290]	2,3	96	F1AGL411...	06.16→	4	<b>** 600 249</b>
<b>150</b> EcoJet [290]	2,3	110	F1AGL411A	06.15→	4	<b>** 600 249</b>





0 444 ... 0 444 ... \*0 444 ... \*\*F 01C ... 0 986 ...

**FORD**

Transit						
FT 330 2.2 TDCi [14]	2,2	92	USR6 <Euro6 HDT>	01.14-12.16	4	021 058
FT 350 2.2 TDCi [14]	2,2	92/114	USR6 <Euro6 HDT>; UYR6 <Euro6 HDT>	01.14-12.16	4	021 058
FT 370 2.2 TDCi [14]	2,2	92/114	USR6 <Euro6 HDT>; UYR6 <Euro6 HDT>	01.14-12.16	4	021 058
FT 410 2.2 TDCi [14]	2,2	92/114	USR6 <Euro6 HDT>; UYR6 <Euro6 HDT>	01.14-12.16	4	021 058
FT 430 2.2 TDCi [14]	2,2	92/114	USR6 <Euro6 HDT>; UYR6 <Euro6 HDT>	01.14-12.16	4	021 058
FT 440 2.2 TDCi [14]	2,2	114	UYR6 <Euro6 HDT>	01.14→	4	021 058
FT 460 2.2 TDCi [14]	2,2	92/114	USR6 <Euro6 HDT>; UYR6 <Euro6 HDT>	01.14→	4	021 058

**HEULIEZ**

Access` Bus GX							
427 ,BHNS	7,8	213/280	F2BE3682... <Euro 4/5>; F2CFE612C <EEV>	09.07-12.13	THD	6	* 010 008
					TW	6	011 003
						6	011 014
						6	023 058
					6	043 064	
GX Acces Bus							
127, 127 L	5,9	194	F4AE3682 <EEV>	06.09→	THD	6	* 010 008
					TW	6	011 003
						6	011 014
						6	043 064
					6	043 064	
327 ,BHNS	7,8	180/213	F2BE3682C <Euro 4/5>; F2BE3682D <Euro 4/5>	09.07-12.13	THD	6	* 010 008
					TW	6	011 003
						6	011 014
						6	011 014
GX Access Bus							
127, 127 L	5,9	160	F4AE3682 <Euro 4/5>	03.06→	THD	6	* 010 008
					TW	6	011 003
						6	011 014
						6	043 064
Serie GX							
Access` Bus 137, 137 L, 337, 337 L	6,7	184/210-213	F4AFE612F <Tector 7 - Euro 6>	09.15→	6	043 064	
437, 437 L	8,7	265/294	F2CFE612A <Cursor 9 - Euro 6>; F2CFE612B <Cursor 9 - Euro 6>	09.15→	6	043 064	

**HINO**

Profia								
12.9 D Turbo	12,9	265-410	E13C	10.03→		6	043 061	44D 282
					24S, HIW	6	* 042 095	44D 213

**HYUNDAI**

H 350							
2.5 D Turbo	2,5	110/125	D4CB	04.15→		4	021 041
					TW	4	** 600 249
H-1 Cargo							
2.5 CRDi	2,5	81-85/100/120-125	D4CB... <(6A) A25>; D4CB... <(6A) A25/(6B) A25B>; D4CB <(6A) A25/(6B) A25B>	03.08→	4	021 041	





◀ HYUNDAI 0 444 ... 0 444 ... \*0 444 ... \*\* F01C... 0 986 ...

H-1 Travel						
2.5 CRDI	2,5	81-85/ 100/120- 125	D4CB <(6A) A25>; D4CB... <(6A) A25/(6B) A25B>; D4CB <(6A) A25/(6B) A25B>	03.08→	4	<b>021 041</b>

## ISUZU

Forward						
5.2 D Turbo	5,2	140/154	4HK1-TCC; 4HK1-TCS	04.07→	4	<b>*042 103 44D 217</b>

## IVECO











Crossway						
6.7	6,7	210/235	F4AFE612D <Tector 7 - Euro 6>; F4AFE612F <Tector 7 - Euro 6>	07.14→	6 THD 6	<b>043 064</b> <b>*010 008</b>

8.7	8,7	265/294	F2CFE612A <Cursor 9 - Euro 6>; F2CFE612B <Cursor 9 - Euro 6>	07.14→	6 THD 6	<b>043 064</b> <b>*010 008</b>
-----	-----	---------	---	--------	------------	-----------------------------------

Crossway LE						
6.7	6,7	210/235	F4AFE612D <Tector 7 - Euro 6>; F4AFE612F <Tector 7 - Euro 6>	07.14→	6 THD 6	<b>043 064</b> <b>*010 008</b>
8.7	8,7	265/294	F2CFE612A <Cursor 9 - Euro 6>; F2CFE612B <Cursor 9 - Euro 6>	07.14→	6 THD 6	<b>043 064</b> <b>*010 008</b>

Daily						
30 S 18 [14]	3,0	132	F1CFL411W <Euro 6>	07.17→	4	<b>021 040</b>
33-160 [16]	2,3	110-114,6	F1AGL411... <Euro 6>	07.16→	4	<b>021 040</b>
35 C 17 [14]	3,0	125	F1CFL411F*C; F1CFL411H*C	05.14→	4	<b>021 040</b>
35 S 15, 17 [14]	3,0	107/125	F1CFL411E*C; F1CFL411F*C	05.14→	4	<b>021 040</b>
35-140 [16]	2,3	100	F1AGL411... <EURO 6>	07.16→	4	<b>021 040</b>
35-150 [16]	3,0	110	F1C... <Euro 6>	07.16→	4	<b>021 040</b>
35-160 [16]	2,3	110-114,6	F1AGL411... <Euro 6>; F1AGL411... <EURO 6>	07.16→	4	<b>021 040</b>
35-180 [16]	3,0	132	F1C... <Euro 6>	07.16→	4	<b>021 040</b>
35-210 [16]	3,0	150	F1CGL411C <Euro 6>	07.16→	4	<b>021 040</b>
40 C 15, 17 [14]	3,0	107/125	F1CFL411E*C; F1CFL411F*C	05.14→	4	<b>021 040</b>
40-150 [16]	3,0	110	F1C... <Euro 6>	07.16→	4	<b>021 040</b>
40-180 [16]	3,0	132	F1C... <Euro 6>	07.16→	4	<b>021 040</b>
40-210 [16]	3,0	150	F1CGL411C <Euro 6>	07.16→	4	<b>021 040</b>
50 C 15, 17 [14]	3,0	107/125	F1CFL411E*C; F1CFL411F*C	05.14→	4	<b>021 040</b>
50-150 [16]	3,0	110	F1C... <Euro 6>	07.16→	4	<b>021 040</b>
50-180 [16]	3,0	132	F1C... <Euro 6>	07.16→	4	<b>021 040</b>
50-210 [16]	3,0	150	F1CGL411C <Euro 6>	07.16→	4	<b>021 040</b>
55 S 17 [14]	3,0	125	F1CFL411F*C	09.15→	4	<b>021 040</b>
55-180 [16]	3,0	132	F1C... <Euro 6>	07.16→	4	<b>021 040</b>
60 C 17 [14]	3,0	107/125	F1CFL411E*C; F1CFL411F*C	05.14→	4	<b>021 040</b>
60-150 [16]	3,0	110	F1C... <Euro 6>	02.17→	4	<b>021 040</b>
60-180 [16]	3,0	132	F1C... <Euro 6>	02.17→	4	<b>021 040</b>
65 C 15, 17 [14]	3,0	107/125	F1CFL411E*C; F1CFL411F*C	05.14→	4	<b>021 040</b>
65-150 [16]	3,0	110	F1C... <Euro 6>	07.16→	4	<b>021 040</b>
65-180 [16]	3,0	132	F1C... <Euro 6>	07.16→	4	<b>021 040</b>
65-210 [16]	3,0	150	F1CGL411C <Euro 6>	07.16→	4	<b>021 040</b>
70 C 15, 17 [14]	3,0	107/125	F1CFL411E*C; F1CFL411F*C	05.14→	4	<b>021 040</b>
70-150 [16]	3,0	110	F1C... <Euro 6>	07.16→	4	<b>021 040</b>
70-180 [16]	3,0	132	F1C... <Euro 6>	07.16→	4	<b>021 040</b>
70-210 [16]	3,0	150	F1CGL411C <Euro 6>	07.16→	4	<b>021 040</b>

EuroCargo						
14, 16, 18 [03]3,9		103/118/F4AE3481B*...; F4AE3481C*...; F4AE3481D*...				
	130		Fg.-Nr. →575389	09.05-01.14	4	<b>023 057</b>
			Fg.-Nr. →2575388	09.05-01.14 THD	4	<b>*022 019 44D 106</b>
			Fg.-Nr. 575390→	09.05-01.14	4	<b>023 058</b>
			Fg.-Nr. 2575389→	09.05-01.14 THD	4	<b>*022 021 44D 131</b>

									<b>A</b>	<b>B</b>		
									0 444 ...	0 444 ...	* 0 444 ...	* F 01C ... 0 986 ...
<b>75 E</b> 16, 19, 21 [14]	4,5	118/137/152	F4AFE411... <Tector 5>; F4AFE411C* <Tector 5>	09.13→	4						* <b>042 031</b>	<b>44D 232</b>
					4					<b>043 064</b>		
<b>80 E</b> 18 [03]	3,9	130	F4AE3481B*...									
			Fg.-Nr. →575389	09.05-01.14	4						<b>023 057</b>	
			Fg.-Nr. →2575388	09.05-01.14 THD	4						* <b>022 019</b>	<b>44D 106</b>
			Fg.-Nr. 575390→	09.05-01.14	4						<b>023 058</b>	
			Fg.-Nr. 2575389→	09.05-01.14 THD	4						* <b>022 021</b>	<b>44D 131</b>
<b>100 E</b> 18 [03]	3,9	130	F4AE3481B*...									
			Fg.-Nr. →575389	09.06-01.14	4						<b>023 057</b>	
			Fg.-Nr. →2575388	09.06-01.14 THD	4						* <b>022 019</b>	<b>44D 106</b>
			Fg.-Nr. 575390→	09.06-01.14	4						<b>023 058</b>	
			Fg.-Nr. 2575389→	09.06-01.14 THD	4						* <b>022 021</b>	<b>44D 131</b>
18, 22 [03]	5,9	135/160	F4AE3681B*...; F4AE3681C*...									
			Fg.-Nr. →575389	09.05-01.14	6						<b>023 057</b>	
			Fg.-Nr. →2575388	09.05-01.14 THD	6						* <b>022 019</b>	<b>44D 106</b>
			Fg.-Nr. 575390→	09.05-01.14	6						<b>023 058</b>	
			Fg.-Nr. 2575389→	09.05-01.14 THD	6						* <b>022 021</b>	<b>44D 131</b>
19, 21 [14]	4,5	137/152	F4AFE411... <Tector 5>; F4AFE411C* <Tector 5>	09.13→	4						* <b>042 031</b>	<b>44D 232</b>
					4					<b>043 064</b>		
22 [14]	6,7	162	F4AFE611A* <Tector 7>	09.13→	6						* <b>042 031</b>	<b>44D 232</b>
					6					<b>043 064</b>		
<b>110 E</b> 22 [03]	5,9	160	F4AE3681B*...									
			Fg.-Nr. →575389	09.07-01.14	6						<b>023 057</b>	
			Fg.-Nr. →2575388	09.07-01.14 THD	6						* <b>022 019</b>	<b>44D 106</b>
			Fg.-Nr. 575390→	09.07-01.14	6						<b>023 058</b>	
			Fg.-Nr. 2575389→	09.07-01.14 THD	6						* <b>022 021</b>	<b>44D 131</b>
22 [14]	6,7	162	F4AFE611A* <Tector 7>	07.14→	6						* <b>042 031</b>	<b>44D 232</b>
					6					<b>043 064</b>		
22 [16]	5,9	162	F4AEE681 <Tector 6 - Euro 3>									
			Fg.-Nr. →2575389	01.18→	6						<b>023 057</b>	
			Fg.-Nr. 2575390→	01.18→	6						<b>023 058</b>	
<b>120 E</b> 18 [03]	3,9	134	F4AE3481A*...									
			Fg.-Nr. →575389	09.05-01.14	4						<b>023 057</b>	
			Fg.-Nr. →2575388	09.05-01.14 THD	4						* <b>022 019</b>	<b>44D 106</b>
			Fg.-Nr. 575390→	09.05-01.14	4						<b>023 058</b>	
			Fg.-Nr. 2575389→	09.05-01.14 THD	4						* <b>022 021</b>	<b>44D 131</b>
	5,9	134	F4AE0681E*C..									
			Fg.-Nr. →575389	09.03-08.05	6						<b>023 057</b>	
			Fg.-Nr. 575390→	09.03-08.05	6						<b>023 058</b>	
18, 22 [16]	5,9	132/162	F4AEE681 <Tector 6 - Euro 3>									
			Fg.-Nr. →2575389	01.18→	6						<b>023 057</b>	
			Fg.-Nr. 2575390→	01.18→	6						<b>023 058</b>	
19, 21 [14]	4,5	137/152	F4AFE411... <Tector 5>; F4AFE411C* <Tector 5>	09.13→	4						* <b>042 031</b>	<b>44D 232</b>
					4					<b>043 064</b>		
22 [03]	5,9	160	F4AE3681B*...									
			Fg.-Nr. →575389	09.05-01.14	6						<b>023 057</b>	
			Fg.-Nr. →2575388	09.05-01.14 THD	6						* <b>022 019</b>	<b>44D 106</b>
			Fg.-Nr. 575390→	09.05-01.14	6						<b>023 058</b>	
			Fg.-Nr. 2575389→	09.05-01.14 THD	6						* <b>022 021</b>	<b>44D 131</b>
22 [14]	6,7	162	F4AFE611A* <Tector 7>	09.13→	6						* <b>042 031</b>	<b>44D 232</b>
					6					<b>043 064</b>		
18 [03] 3,9	134	F4AE3481A*...										
			Fg.-Nr. →575389	09.05-01.14	4						<b>023 057</b>	
			Fg.-Nr. →2575388	09.05-01.14 THD	4						* <b>022 019</b>	<b>44D 106</b>
			Fg.-Nr. 575390→	09.05-01.14	4						<b>023 058</b>	
			Fg.-Nr. 2575389→	09.05-01.14 THD	4						* <b>022 021</b>	<b>44D 131</b>
19, 21 [14]	4,5	137/152	F4AFE411... <Tector 5>; F4AFE411C* <Tector 5>	09.13→	4						* <b>042 031</b>	<b>44D 232</b>
					4					<b>043 064</b>		

















◀ IVECO

0 444 ... 0 444 ... \* 0 444 ... \*\* F 01C ... 0 986 ...

<b>140 E</b> 22, 25, 28 [03]	5,9	160/185/205	F4AE3681B*...; F4AE3681D*...; F4AE3681E*...						
			Fg.-Nr. →575389	09.05-01.14	6		<b>023 057</b>		
			Fg.-Nr. →2575388	09.05-01.14 THD	6			<b>*022 019</b>	<b>44D 106</b>
			Fg.-Nr. 575390→	09.05-01.14	6		<b>023 058</b>		
			Fg.-Nr. 2575389→	09.05-01.14 THD	6			<b>*022 021</b>	<b>44D 131</b>
22, 25, 28 [14]	6,7	162/185/206	F4AFE611A* <Tector 7>; F4AFE611C* <Tector 7>; F4AFE611E* <Tector 7>	09.13→	6			<b>*042 031</b>	<b>44D 232</b>
					6		<b>043 064</b>		
22, 25, 28 [16]	5,9	162/185/202	F4AEE681 <Tector 6 - Euro 3>; F4AE3681D*..						
			Fg.-Nr. →2575389	01.18→	6		<b>023 057</b>		
			Fg.-Nr. 2575390→	01.18→	6		<b>023 058</b>		
<b>150 E</b> 18 [03]	3,9	134	F4AE3481A*..						
			Fg.-Nr. →575389	09.05-01.14	4		<b>023 057</b>		
			Fg.-Nr. →2575388	09.05-01.14 THD	4			<b>*022 019</b>	<b>44D 106</b>
			Fg.-Nr. 575390→	09.05-01.14	4		<b>023 058</b>		
			Fg.-Nr. 2575389→	09.05-01.14 THD	4			<b>*022 021</b>	<b>44D 131</b>
22 [14]	6,7	162	F4AFE611A* <Tector 7>						
			Fg.-Nr. →2575389	09.13→	6		<b>023 057</b>		
			Fg.-Nr. 2575390→	09.13→	6		<b>023 058</b>		
22, 25, 28, 30 [03]	5,9	160/185/205/220	F4AE3681A*...; F4AE3681B*...; F4AE3681D*...; F4AE3681E*..						
			Fg.-Nr. →575389	09.05-01.14	6		<b>023 057</b>		
			Fg.-Nr. →2575388	09.05-01.14 THD	6			<b>*022 019</b>	<b>44D 106</b>
			Fg.-Nr. 575390→	09.05-01.14	6		<b>023 058</b>		
			Fg.-Nr. 2575389→	09.05-01.14 THD	6			<b>*022 021</b>	<b>44D 131</b>
25, 28 [16]	5,9	185/202	F4AEE681 <Tector 6 - Euro 3>; F4AE3681D*..						
			Fg.-Nr. →2575389	01.18→	6		<b>023 057</b>		
			Fg.-Nr. 2575390→	01.18→	6		<b>023 058</b>		
25, 28, 32 [14]	6,7	185/206/235	F4AFE611C* <Tector 7>; F4AFE611D* <Tector 7>; F4AFE611E* <Tector 7>	09.13→	6			<b>*042 031</b>	<b>44D 232</b>
					6		<b>043 064</b>		
<b>160 E</b> 18 [03]	3,9	134	F4AE3481A*..						
			Fg.-Nr. →575389	09.05-01.14	4		<b>023 057</b>		
			Fg.-Nr. →2575388	09.05-01.14 THD	4			<b>*022 019</b>	<b>44D 106</b>
			Fg.-Nr. 575390→	09.05-01.14	4		<b>023 058</b>		
			Fg.-Nr. 2575389→	09.05-01.14 THD	4			<b>*022 021</b>	<b>44D 131</b>
19, 21 [14]	4,5	137/152	F4AFE411... <Tector 5>; F4AFE411C* <Tector 5>	09.13→	4			<b>*042 031</b>	<b>44D 232</b>
					4		<b>043 064</b>		
22, 25, 28, 30 [03]	5,9	160/185/205/220	F4AE3681A*...; F4AE3681B*...; F4AE3681D*...; F4AE3681E*..						
			Fg.-Nr. →575389	09.05-01.14	6		<b>023 057</b>		
			Fg.-Nr. →2575388	09.05-01.14 THD	6			<b>*022 019</b>	<b>44D 106</b>
			Fg.-Nr. 575390→	09.05-01.14	6		<b>023 058</b>		
			Fg.-Nr. 2575389→	09.05-01.14 THD	6			<b>*022 021</b>	<b>44D 131</b>
22, 25, 28, 32 [14]	6,7	162/185/206/235	F4AFE611A* <Tector 7>; F4AFE611C* <Tector 7>; F4AFE611D* <Tector 7>; F4AFE611E* <Tector 7>	09.13→	6			<b>*042 031</b>	<b>44D 232</b>
					6		<b>043 064</b>		
25, 28 [16]	5,9	185/202	F4AEE681 <Tector 6 - Euro 3>; F4AE3681D*..						
			Fg.-Nr. →2575389	01.18→	6		<b>023 057</b>		
			Fg.-Nr. 2575390→	01.18→	6		<b>023 058</b>		
<b>180 E</b> 25, 28 [16]	5,9	185/202	F4AEE681 <Tector 6 - Euro 3>; F4AE3681D*..						
			Fg.-Nr. →2575389	01.18→	6		<b>023 057</b>		
			Fg.-Nr. 2575390→	01.18→	6		<b>023 058</b>		
25, 28, 30 [03]	5,9	185/205/220	F4AE3681A*...; F4AE3681B*...; F4AE3681E*..						
			Fg.-Nr. →575389	09.05-01.14	6		<b>023 057</b>		
			Fg.-Nr. →2575388	09.05-01.14 THD	6			<b>*022 019</b>	<b>44D 106</b>
			Fg.-Nr. 575390→	09.05-01.14	6		<b>023 058</b>		
			Fg.-Nr. 2575389→	09.05-01.14 THD	6			<b>*022 021</b>	<b>44D 131</b>
25, 28, 32 [14]	6,7	185/206/235	F4AFE611C* <Tector 7>; F4AFE611D* <Tector 7>; F4AFE611E* <Tector 7>	09.13→	6			<b>*042 031</b>	<b>44D 232</b>
					6		<b>043 064</b>		
<b>Euromidi CC</b>									
<b>100 E</b> 22, 25	6,7	162/185	F4AFE611C* <Tector 7>; F4AFE611E* <Tector 7>	12.13→	6			<b>*042 031</b>	<b>44D 232</b>
					6		<b>043 064</b>		











								<b>A</b>	<b>B</b>		
								0 444 ...	0 444 ...	* 0 444 ...	** F 01C ... 0 986 ...
<b>150 E 25</b>	6,7	185	F4AFE611E* <Tector 7>	09.13→				6		* 042 031	44D 232
								6	<b>043 064</b>		
<b>Magelys</b>											
	8,7	294	F2CFE612A <Cursor 9 - Euro 6>	07.14→				6		<b>043 064</b>	
								THD 6		* 010 008	
<b>10.3</b>	10,3	279/331	F3AE3682A <Euro 4/5>; F3AE3682C <Euro 4/5>								
			Fg.-Nr. →330	06.13→				6		<b>011 003</b>	
			Fg.-Nr. 331→	06.13→				6		<b>011 014</b>	
<b>Stralis</b>											
<b>L 190 S 42, 45 [07]</b>	10,3	309/331	F3AE3681A*...; F3AE3681D*...								
			Fg.-Nr. →2575388	04.07-12.12	THD			6		* 022 019	44D 106
			Fg.-Nr. →4379288 →C236472	04.07-12.12				6		<b>023 057</b>	
			Fg.-Nr. 2575389→	04.07-12.12	THD			6		* 022 021	44D 131
			Fg.-Nr. 4379289→ C236473→	04.07-12.12				6		<b>023 058</b>	
50 [07]	12,9	368	F3AE3681B*...								
			Fg.-Nr. →2575388	04.07-12.12	THD			6		* 022 019	44D 106
			Fg.-Nr. →4379288 →C236472	04.07-12.12				6		<b>023 057</b>	
			Fg.-Nr. 2575389→	04.07-12.12	THD			6		* 022 021	44D 131
			Fg.-Nr. 4379289→ C236473→	04.07-12.12				6		<b>023 058</b>	
<b>L 260 S 50, 56 [07]</b>	12,9	368/412	F3BE3681A*...; F3BE3681B*...								
			Fg.-Nr. →2575388	04.07-12.12	THD			6		* 022 019	44D 106
			Fg.-Nr. →4379288 →C236472	04.07-12.12				6		<b>023 057</b>	
			Fg.-Nr. 2575389→	04.07-12.12	THD			6		* 022 021	44D 131
			Fg.-Nr. 4379289→ C236473→	04.07-12.12				6		<b>023 058</b>	
<b>L 320 S 42, 45 [07]</b>	10,3	309/331	F3AE3681A*...; F3AE3681D*...								
			Fg.-Nr. →2575388	06.11-12.12	THD			6		* 022 019	44D 106
			Fg.-Nr. →4379288 →C236472	06.11-12.12				6		<b>023 057</b>	
			Fg.-Nr. 2575389→	06.11-12.12	THD			6		* 022 021	44D 131
			Fg.-Nr. 4379289→ C236473→	06.11-12.12				6		<b>023 058</b>	
50 [07]	12,9	368	F3BE3681B*...								
			Fg.-Nr. →2575388	06.11-12.12	THD			6		* 022 019	44D 106
			Fg.-Nr. →4379288 →C236472	06.11-12.12				6		<b>023 057</b>	
			Fg.-Nr. 2575389→	06.11-12.12	THD			6		* 022 021	44D 131
			Fg.-Nr. 4379289→ C236473→	06.11-12.12				6		<b>023 058</b>	
<b>L 440 S 42, 45 [07]</b>	10,3	309/331	F3AE3681A*...; F3AE3681D*...								
			Fg.-Nr. →2575388	04.07-12.12	THD			6		* 022 019	44D 106
			Fg.-Nr. →4379288 →C236472	04.07-12.12				6		<b>023 057</b>	
			Fg.-Nr. 2575389→	04.07-12.12	THD			6		* 022 021	44D 131
			Fg.-Nr. 4379289→ C236473→	04.07-12.12				6		<b>023 058</b>	
48 [07]	13,0	353	F3BE3681H*..	08.06-12.12				6		<b>023 057</b>	
			Fg.-Nr. →2575388	08.06-12.12	THD			6		* 022 019	44D 106
			Fg.-Nr. 2575389→	08.06-12.12	THD			6		* 022 021	44D 131
50, 56 [07]	12,9	368/412	F3BE3681A*...; F3BE3681B*...								
			Fg.-Nr. →2575388	04.07-12.12	THD			6		* 022 019	44D 106
			Fg.-Nr. →4379288 →C236472	04.07-12.12				6		<b>023 057</b>	
			Fg.-Nr. 2575389→	04.07-12.12	THD			6		* 022 021	44D 131
			Fg.-Nr. 4379289→ C236473→	04.07-12.12				6		<b>023 058</b>	
<b>N 190 S 31, 33, 36 [07]</b>	7,8	228/243/ 265	F2BE3681A*...; F2BE3681B*...; F2BE3681C*..								
			Fg.-Nr. →2575388	04.07-12.12	THD			6		* 022 019	44D 106
			Fg.-Nr. →4379288 →C236472	04.07-12.12				6		<b>023 057</b>	
			Fg.-Nr. 2575389→	04.07-12.12	THD			6		* 022 021	44D 131
			Fg.-Nr. 4379289→ C236473→	04.07-12.12				6		<b>023 058</b>	
<b>N 260 S 31, 36 [07]</b>	7,8	228/265	F2BE3681A*...; F2BE3681C*...								
			Fg.-Nr. →2575388	04.07-12.12	THD			6		* 022 019	44D 106
			Fg.-Nr. →4379288 →C236472	04.07-12.12				6		<b>023 057</b>	
			Fg.-Nr. 2575389→	04.07-12.12	THD			6		* 022 021	44D 131
			Fg.-Nr. 4379289→ C236473→	04.07-12.12				6		<b>023 058</b>	





◀ IVECO		0 444 ...	0 444 ...	* 0 444 ...	** F 01C ...	0 986 ...
<b>N 260 S 33 [07]</b>	12,9 243	F3AE3681B*...				
		Fg.-Nr. →2575388	04.07-12.12 THD	6		<b>*022 019 44D 106</b>
		Fg.-Nr. →4379288 →C236472	04.07-12.12	6	<b>023 057</b>	
		Fg.-Nr. 2575389→	04.07-12.12 THD	6		<b>*022 021 44D 131</b>
		Fg.-Nr. 4379289→ C236473→	04.07-12.12	6	<b>023 058</b>	
<b>N 440 S 33, 36 [07]</b>	7,8 243/265	F2BE3681A*...; F2BE3681B*..				
		Fg.-Nr. →2575388	04.07-12.12 THD	6		<b>*022 019 44D 106</b>
		Fg.-Nr. →4379288 →C236472	04.07-12.12	6	<b>023 057</b>	
		Fg.-Nr. 2575389→	04.07-12.12 THD	6		<b>*022 021 44D 131</b>
		Fg.-Nr. 4379289→ C236473→	04.07-12.12	6	<b>023 058</b>	
<b>190 S 31, 33, 36</b>	7,8 228/243/265	F2BE3681A*...; F2BE3681B*...; F2BE3681C*...				
		Fg.-Nr. →2575388	04.06-12.12 THD	6		<b>*022 019 44D 106</b>
		Fg.-Nr. →4379288 →C236472	04.06-12.12	6	<b>023 057</b>	
		Fg.-Nr. 2575389→	04.06-12.12 THD	6		<b>*022 021 44D 131</b>
		Fg.-Nr. 4379289→ C236473→	04.06-12.12	6	<b>023 058</b>	
42, 45	10,3 309/331	F3AE3681A*...; F3AE3681D*...				
		Fg.-Nr. →2575388	04.06-12.12 THD	6		<b>*022 019 44D 106</b>
		Fg.-Nr. →4379288 →C236472	04.06-12.12	6	<b>023 057</b>	
		Fg.-Nr. 2575389→	04.06-12.12 THD	6		<b>*022 021 44D 131</b>
		Fg.-Nr. 4379289→ C236473→	04.06-12.12	6	<b>023 058</b>	
50	12,9 368	F3AE3681B*...				
		Fg.-Nr. →2575388	04.06-12.12 THD	6		<b>*022 019 44D 106</b>
		Fg.-Nr. →4379288 →C236472	04.06-12.12	6	<b>023 057</b>	
		Fg.-Nr. 2575389→	04.06-12.12 THD	6		<b>*022 021 44D 131</b>
		Fg.-Nr. 4379289→ C236473→	04.06-12.12	6	<b>023 058</b>	
<b>260 S 31, 33, 36</b>	7,8 228/243/265	F2BE3681A*...; F2BE3681B*...; F2BE3681C*...				
		Fg.-Nr. →2575388	04.06-12.12 THD	6		<b>*022 019 44D 106</b>
		Fg.-Nr. →4379288 →C236472	04.06-12.12	6	<b>023 057</b>	
		Fg.-Nr. 2575389→	04.06-12.12 THD	6		<b>*022 021 44D 131</b>
		Fg.-Nr. 4379289→ C236473→	04.06-12.12	6	<b>023 058</b>	
42 Cube, 45 Cube [07]	10,3 309/331	F3AE3681A*...; F3AE3681D*...				
		Fg.-Nr. →2575388	04.07-12.12 THD	6		<b>*022 019 44D 106</b>
		Fg.-Nr. →4379288 →C236472	04.07-12.12	6	<b>023 057</b>	
		Fg.-Nr. 2575389→	04.07-12.12 THD	6		<b>*022 021 44D 131</b>
		Fg.-Nr. 4379289→ C236473→	04.07-12.12	6	<b>023 058</b>	
42, 45	10,3 309/331	F3AE3681A*...; F3AE3681D*...				
		Fg.-Nr. →2575388	04.06-12.12 THD	6		<b>*022 019 44D 106</b>
		Fg.-Nr. →4379288 →C236472	04.06-12.12	6	<b>023 057</b>	
		Fg.-Nr. 2575389→	04.06-12.12 THD	6		<b>*022 021 44D 131</b>
		Fg.-Nr. 4379289→ C236473→	04.06-12.12	6	<b>023 058</b>	
43	10,5 316	F3AE0681D*..	08.02-03.06 THD	6		<b>*010 003</b>
48	13,0 353	F3BE0681E*..	08.02-03.06 THD	6		<b>*010 003</b>
50, 56	12,9 368/412	F3BE3681A*M; F3BE3681B*...				
		Fg.-Nr. →2575388	04.06-12.12 THD	6		<b>*022 019 44D 106</b>
		Fg.-Nr. →4379288 →C236472	04.06-12.12	6	<b>023 057</b>	
		Fg.-Nr. 2575389→	04.06-12.12 THD	6		<b>*022 021 44D 131</b>
		Fg.-Nr. 4379289→ C236473→	04.06-12.12	6	<b>023 058</b>	
<b>320 S 36</b>	7,8 265	F2BE3681A*..				
		Fg.-Nr. →2575388	04.06-12.12 THD	6		<b>*022 019 44D 106</b>
		Fg.-Nr. →4379288 →C236472	04.06-12.12	6	<b>023 057</b>	
		Fg.-Nr. 2575389→	04.06-12.12 THD	6		<b>*022 021 44D 131</b>
		Fg.-Nr. 4379289→ C236473→	04.06-12.12	6	<b>023 058</b>	
<b>440 S 33, 36</b>	7,8 243/265	F2BE3681A*...; F2BE3681B*M				
		Fg.-Nr. →2575388	04.06-12.12 THD	6		<b>*022 019 44D 106</b>
		Fg.-Nr. →4379288 →C236472	04.06-12.12	6	<b>023 057</b>	
		Fg.-Nr. 2575389→	04.06-12.12 THD	6		<b>*022 021 44D 131</b>
		Fg.-Nr. 4379289→ C236473→	04.06-12.12	6	<b>023 058</b>	



										<b>A</b>	<b>B</b>			
										0 444 ...	0 444 ...	* 0 444 ...	* F 01C ...	0 986 ...
<b>440 S</b>	42, 45	10,3	309/331	F3AE3681A*...; F3AE3681D*...										
				Fg.-Nr. →2575388	04.06-12.12	THD	6						* 022 019 44D 106	
				Fg.-Nr. →4379288 →C236472	04.06-12.12		6				<b>023 057</b>			
				Fg.-Nr. 2575389→	04.06-12.12	THD	6						* 022 021 44D 131	
				Fg.-Nr. 4379289→C236473→	04.06-12.12		6				<b>023 058</b>			
	43	10,5	316	F3AE0681D*..	08.02-12.12	THD	6						* 010 003	
	50, 56	12,9	368/412	F3...										
				Fg.-Nr. →2575388	04.06-12.12	THD	6						* 022 019 44D 106	
				Fg.-Nr. →4379288 →C236472	04.06-12.12		6				<b>023 057</b>			
				Fg.-Nr. 2575389→	04.06-12.12	THD	6						* 022 021 44D 131	
				Fg.-Nr. 4379289→C236473→	04.06-12.12		6				<b>023 058</b>			
<b>Stralis Hi-Way</b>														
<b>310</b>		7,8	228	F2BE3681C*...										
				Fg.-Nr. →4379288 →C236472	07.12→		6				<b>023 057</b>			
						THD	6						* 022 019 44D 106	
				Fg.-Nr. 4379289→C236473→	07.12→		6				<b>023 058</b>			
						THD	6						* 022 021 44D 131	
		8,7	228	F2CFE611D*C <CURSOR 9>	07.13→		6				<b>043 064</b>			
[16]		8,7	228	F2CFE611D*C <CURSOR 9>	01.17→		6						* 042 031 44D 232	
							6				<b>043 064</b>			
<b>330</b>		7,8	243	F2BE3681B*...										
				Fg.-Nr. →4379288 →C236472	07.12→		6				<b>023 057</b>			
						THD	6						* 022 019 44D 106	
				Fg.-Nr. 4379289→C236473→	07.12→		6				<b>023 058</b>			
						THD	6						* 022 021 44D 131	
		8,7	243	F2CFE611C*C <CURSOR 9>	07.13→		6				<b>043 064</b>			
[16]		8,7	243	F2CFE611C*C <CURSOR 9>	01.17→		6						* 042 031 44D 232	
							6				<b>043 064</b>			
<b>360</b>		7,8	265	F2BE3681A*...										
				Fg.-Nr. →4379288 →C236472	07.12→		6				<b>023 057</b>			
						THD	6						* 022 019 44D 106	
				Fg.-Nr. 4379289→C236473→	07.12→		6				<b>023 058</b>			
						THD	6						* 022 021 44D 131	
		8,7	265	F2CFE611B <Euro 6>	07.13→		6				<b>043 064</b>			
[16]		8,7	265	F2CFE611B <Euro 6>	08.16→		6						* 042 031 44D 232	
							6				<b>043 064</b>			
<b>400</b>		8,7	294	F2CFE611A <Euro 6>	07.13→		6				<b>043 064</b>			
[16]		8,7	294	F2CFE611A <Euro 6>	08.16→		6				<b>043 064</b>			
					01.17→		6						* 042 031 44D 232	
<b>420</b>		10,3	309	F3AE3681D*...										
				Fg.-Nr. →4379288 →C236472	07.12→		6				<b>023 057</b>			
						THD	6						* 022 019 44D 106	
				Fg.-Nr. 4379289→C236473→	07.12→		6				<b>023 058</b>			
						THD	6						* 022 021 44D 131	
		11,1	309	F3GFE611D* <Cursor 11>	07.13→		6				<b>043 064</b>			
[16]		11,1	309	F3GFE611F <Euro 6>	08.16→		4				<b>043 065</b>			
<b>460</b>		10,3	338	F3AE3681Y*...										
				Fg.-Nr. →4379288 →C236472	07.12→		6				<b>023 057</b>			
						THD	6						* 022 019 44D 106	
				Fg.-Nr. 4379289→C236473→	07.12→		6				<b>023 058</b>			
						THD	6						* 022 021 44D 131	
		11,1	338	F3GFE611B* <Cursor 11>	07.13→		6				<b>043 064</b>			
[16]		11,1	338	F3GFE611E <Euro 6>	08.16→		4				<b>043 065</b>			
<b>480</b>		11,1	353	F3GFE611A* <Cursor 11>	07.13→		6				<b>043 065</b>			
						TW	6				<b>043 064</b>			
							6				<b>043 065</b>			
		13,0	353	F3BE3681H*..										
				Fg.-Nr. →4379288 →C236472	07.12→		6				<b>023 057</b>			
						THD	6						* 022 019 44D 106	
				Fg.-Nr. 4379289→C236473→	07.12→		6				<b>023 058</b>			
						THD	6						* 022 021 44D 131	
[16]		12,9	358	F3GF... <Euro 6>; F3GFL611D <Euro 6>	08.16→		6				<b>043 065</b>			















◀ IVECO

0 444 ... 0 444 ... \* 0 444 ... \*\* F 01C ... 0 986 ...

<b>500</b>	12,9	368	F3BE3681B*...						
			Fg.-Nr. →4379288 →C236472	07.12→		6		<b>023 057</b>	
					THD	6			<b>* 022 019 44D 106</b>
			Fg.-Nr. 4379289→C236473→	07.12→		6		<b>023 058</b>	
					THD	6			<b>* 022 021 44D 131</b>
			F3HFE611B* <Cursor 13>	07.13→		6		<b>043 065</b>	
					TW	6		<b>043 064</b>	
						6		<b>043 065</b>	
[16]	12,9	368	F3HFE611B* <Cursor 13>	08.16→		6		<b>043 065</b>	
<b>510 [16]</b>	12,9	375	F3HFE611G <Euro 6>	08.16→		4		<b>043 065</b>	
<b>560</b>	12,9	412	F3BE3681A*...						
			Fg.-Nr. →4379288 →C236472	07.12→		6		<b>023 057</b>	
					THD	6			<b>* 022 019 44D 106</b>
			Fg.-Nr. 4379289→C236473→	07.12→		6		<b>023 058</b>	
					THD	6			<b>* 022 021 44D 131</b>
			F3HFE611A* <Cursor 13>	07.13→		6		<b>043 065</b>	
					TW	6		<b>043 064</b>	
						6		<b>043 065</b>	
[16]	8,7	228	F2CFE611D* <CURSOR 9>	01.17→		6			<b>* 042 031 44D 232</b>
						6		<b>043 064</b>	
	12,9	412	F3HFE611A* <Cursor 13>	08.16→		6		<b>043 065</b>	
<b>570 [16]</b>	12,9	420	F3HF... <Cursor 13>	08.16→		6		<b>043 065</b>	
<b>Stralis X-Way</b>									
<b>330</b>	8,7	243	F2CFE611C* <CURSOR 9>	01.18→		6			<b>* 042 031 44D 232</b>
						6		<b>043 064</b>	
<b>360</b>	8,7	265	F2CFE611B <Euro 6>	08.17→		6			<b>* 042 031 44D 232</b>
						6		<b>043 064</b>	
<b>400</b>	8,7	294	F2CFE611A <Euro 6>	08.17→		6			<b>* 042 031 44D 232</b>
						6		<b>043 064</b>	
<b>420</b>	11,1	309	F3GFE611F <Euro 6>	08.17→		4		<b>043 065</b>	
<b>460</b>	11,1	338	F3GFE611E <Euro 6>	08.17→		4		<b>043 065</b>	
<b>480</b>	11,1	358	F3GF... <Euro 6>; F3GFE611G <Euro 6>	08.17→		6		<b>043 065</b>	
	12,9	358	F3GF... <Euro 6>	08.17→		6		<b>043 065</b>	
<b>510</b>	12,9	375	F3HFE611G <Euro 6>	08.17→		4		<b>043 065</b>	
<b>570</b>	12,9	420	F3HF... <Cursor 13>	08.17→		6		<b>043 065</b>	
			F3HF... <Euro 6>	01.18→		4		<b>043 065</b>	
<b>Trakker</b>									
<b>N 190 T 31, 33, 36 [07]</b>	7,8	228/243/265	F2BE3681A*...; F2BE3681B*...; F2BE3681C*...	07.07-06.13		6		<b>023 057</b>	
			Fg.-Nr. →2575388	07.07-06.13	THD	6			<b>* 022 019 44D 106</b>
			Fg.-Nr. 2575389→	07.07-06.13	THD	6			<b>* 022 021 44D 131</b>
41, 45 [07]	13,0	302/331	F3BE3681C*...; F3BE3681D*...	07.07-06.13		6		<b>023 057</b>	
			Fg.-Nr. →2575388	07.07-06.13	THD	6			<b>* 022 019 44D 106</b>
			Fg.-Nr. 2575389→	07.07-06.13	THD	6			<b>* 022 021 44D 131</b>
<b>N 260 T 33, 36 [07]</b>	7,8	243/265	F2BE3681A*...; F2BE3681B*...	07.07-06.13		6		<b>023 057</b>	
			Fg.-Nr. →2575388	07.07-06.13	THD	6			<b>* 022 019 44D 106</b>
			Fg.-Nr. 2575389→	07.07-06.13	THD	6			<b>* 022 021 44D 131</b>
41, 45 [07]	13,0	302/331	F3BE3681C*...; F3BE3681D*...	07.07-06.13		6		<b>023 057</b>	
			Fg.-Nr. →2575388	07.07-06.13	THD	6			<b>* 022 019 44D 106</b>
			Fg.-Nr. 2575389→	07.07-06.13	THD	6			<b>* 022 021 44D 131</b>
50 [07]	12,9	368	F3BE3681B*...	07.07-06.13		6		<b>023 057</b>	
			Fg.-Nr. →2575388	07.07-06.13	THD	6			<b>* 022 019 44D 106</b>
			Fg.-Nr. 2575389→	07.07-06.13	THD	6			<b>* 022 021 44D 131</b>
<b>N 340 T 36 [07]</b>	7,8	265	F2BE3681A*...	07.07-06.13		6		<b>023 057</b>	
			Fg.-Nr. →2575388	07.07-06.13	THD	6			<b>* 022 019 44D 106</b>
			Fg.-Nr. 2575389→	07.07-06.13	THD	6			<b>* 022 021 44D 131</b>
41, 45 [07]	13,0	302/331	F3BE3681C*...; F3BE3681D*...	07.07-06.13		6		<b>023 057</b>	
			Fg.-Nr. →2575388	07.07-06.13	THD	6			<b>* 022 019 44D 106</b>
			Fg.-Nr. 2575389→	07.07-06.13	THD	6			<b>* 022 021 44D 131</b>
41, 45 [07] 13,0	302/331	F3BE3681C*...; F3BE3681D*...	07.07-06.13		6		<b>023 057</b>		
			Fg.-Nr. →2575388	07.07-06.13	THD	6			<b>* 022 019 44D 106</b>
			Fg.-Nr. 2575389→	07.07-06.13	THD	6			<b>* 022 021 44D 131</b>

									<b>A</b>	<b>B</b>		
									0 444 ...	0 444 ...	* 0 444 ...	** F 01C ... 0 986 ...
<b>N 380T 50 [07]</b>		12,9	368	F3BE3681B*...	07.07-06.13		6			<b>023 057</b>		
				Fg.-Nr. →2575388	07.07-06.13	THD	6				* 022 019	44D 106
				Fg.-Nr. 2575389→	07.07-06.13	THD	6				* 022 021	44D 131
<b>N 400T 36 [07]</b>		7,8	265	F2BE3681A*...	07.07-06.13		6			<b>023 057</b>		
				Fg.-Nr. →2575388	07.07-06.13	THD	6				* 022 019	44D 106
				Fg.-Nr. 2575389→	07.07-06.13	THD	6				* 022 021	44D 131
41, 45 [07]		13,0	302/331	F3BE3681C*...; F3BE3681D*...	07.07-06.13		6			<b>023 057</b>		
				Fg.-Nr. →2575388	07.07-06.13	THD	6				* 022 019	44D 106
				Fg.-Nr. 2575389→	07.07-06.13	THD	6				* 022 021	44D 131
50 [07]		12,9	368	F3BE3681B*...	07.07-06.13		6			<b>023 057</b>		
				Fg.-Nr. →2575388	07.07-06.13	THD	6				* 022 019	44D 106
				Fg.-Nr. 2575389→	07.07-06.13	THD	6				* 022 021	44D 131
<b>N 410T 41, 45 [07]</b>		13,0	302/331	F3BE3681C*...; F3BE3681D*...	07.07-06.13		6			<b>023 057</b>		
				Fg.-Nr. →2575388	07.07-06.13	THD	6				* 022 019	44D 106
				Fg.-Nr. 2575389→	07.07-06.13	THD	6				* 022 021	44D 131
50 [07]		12,9	368	F3BE3681B*...	07.07-06.13		6			<b>023 057</b>		
				Fg.-Nr. →2575388	07.07-06.13	THD	6				* 022 019	44D 106
				Fg.-Nr. 2575389→	07.07-06.13	THD	6				* 022 021	44D 131
<b>N 440T 41, 45 [07]</b>		13,0	302/331	F3BE3681C*...; F3BE3681D*...	07.07-06.13		6			<b>023 057</b>		
				Fg.-Nr. →2575388	07.07-06.13	THD	6				* 022 019	44D 106
				Fg.-Nr. 2575389→	07.07-06.13	THD	6				* 022 021	44D 131
50 [07]		12,9	368	F3BE3681B*...	07.07-06.13		6			<b>023 057</b>		
				Fg.-Nr. →2575388	07.07-06.13	THD	6				* 022 019	44D 106
				Fg.-Nr. 2575389→	07.07-06.13	THD	6				* 022 021	44D 131
<b>N 720T 41, 45 [07]</b>		13,0	302/331	F3BE3681C*...; F3BE3681D*...	07.07-06.13		6			<b>023 057</b>		
				Fg.-Nr. →2575388	07.07-06.13	THD	6				* 022 019	44D 106
				Fg.-Nr. 2575389→	07.07-06.13	THD	6				* 022 021	44D 131
50 [07]		12,9	368	F3BE3681B*...	07.07-06.13		6			<b>023 057</b>		
				Fg.-Nr. →2575388	07.07-06.13	THD	6				* 022 019	44D 106
				Fg.-Nr. 2575389→	07.07-06.13	THD	6				* 022 021	44D 131
<b>190T 31, 33, 36</b>		7,8	228/243/ 265	F2BE3681A*...; F2BE3681B*...; F2BE3681C*...	04.06-12.12		6			<b>023 057</b>		
				Fg.-Nr. →2575388	04.06-12.12	THD	6				* 022 019	44D 106
				Fg.-Nr. 2575389→	04.06-12.12	THD	6				* 022 021	44D 131
41, 45		13,0	302/331	F3BE3681C*...; F3BE3681D*...	04.06-12.12		6			<b>023 057</b>		
				Fg.-Nr. →2575388	04.06-12.12	THD	6				* 022 019	44D 106
				Fg.-Nr. 2575389→	04.06-12.12	THD	6				* 022 021	44D 131
<b>190T 31, 33, 36 [13]</b>		7,8	228/243/ 265	F2BE3681A*...; F2BE3681B*...; F2BE3681C*...			6			<b>023 057</b>		
				Fg.-Nr. →4379288 →C236472	01.13→		6				* 022 019	44D 106
						THD	6				* 022 021	44D 131
				Fg.-Nr. 4379289→C236473→	01.13→		6			<b>023 058</b>		
						THD	6				* 022 021	44D 131
		8,7	228/243/ 265	F2CFE611B <Euro 6>; F2CFE611C* <CURSOR 9>; F2CFE611D* <CURSOR 9>	11.13→		6			<b>043 064</b>		
41, 45 [13]		12,9	302/331	F3HFE611C* <CURSOR 13>; F3HFE611D* <CURSOR 13>	11.13→	TW	6			<b>043 064</b>		
							6			<b>043 065</b>		
		13,0	301/332	F3BE3681C*S; F3BE3681D*S			6			<b>023 057</b>		
				Fg.-Nr. →4379288 →C236472	01.13→		6				* 022 019	44D 106
						THD	6				* 022 021	44D 131
				Fg.-Nr. 4379289→C236473→	01.13→		6			<b>023 058</b>		
						THD	6				* 022 021	44D 131
<b>260T 33, 36</b>		7,8	243/265	F2BE3681A*...; F2BE3681B*...	04.06-12.12		6			<b>023 057</b>		
				Fg.-Nr. →2575388	04.06-12.12	THD	6				* 022 019	44D 106
				Fg.-Nr. 2575389→	04.06-12.12	THD	6				* 022 021	44D 131
41, 45		13,0	302/331	F3BE3681C*...; F3BE3681D*...	04.06-12.12		6			<b>023 057</b>		
				Fg.-Nr. →2575388	04.06-12.12	THD	6				* 022 019	44D 106
				Fg.-Nr. 2575389→	04.06-12.12	THD	6				* 022 021	44D 131
50		12,9	368	F3BE3681B*...	04.06-12.12		6			<b>023 057</b>		
				Fg.-Nr. →2575388	04.06-12.12	THD	6				* 022 019	44D 106
				Fg.-Nr. 2575389→	04.06-12.12	THD	6				* 022 021	44D 131















◀ IVECO 0 444 ... 0 444 ... \*0 444 ... \*\* F 01C ... 0 986 ...

<b>260T</b> 33, 36 [13]	7,8	243/265	F2BE3681A*...; F2BE3681B*... Fg.-Nr. →4379288 →C236472	01.13→		6		<b>023 057</b>	
						THD	6		<b>*022 019 44D 106</b>
			Fg.-Nr. 4379289→C236473→	01.13→		6		<b>023 058</b>	
						THD	6		<b>*022 021 44D 131</b>
33, 36, 41 [13]	8,7	243/265/ 302	F2CFE611A <Euro 6>; F2CFE611B <Euro 6>; F2CFE611C* <CURSOR 9>	11.13→		6		<b>043 064</b>	
41, 45 [13]	12,9	302/331	F3HFE611C* <CURSOR 13>; F3HFE611D* <CURSOR 13>	11.13→	TW	6		<b>043 064</b>	
						6		<b>043 065</b>	
	13,0	301/332	F3BE3681C*S; F3BE3681D*S Fg.-Nr. →4379288 →C236472	01.13→		6		<b>023 057</b>	
						THD	6		<b>*022 019 44D 106</b>
			Fg.-Nr. 4379289→C236473→	01.13→		6		<b>023 058</b>	
						THD	6		<b>*022 021 44D 131</b>
50 [13]	12,9	368	F3BE3681B*... Fg.-Nr. →4379288 →C236472	01.13→		6		<b>023 057</b>	
						THD	6		<b>*022 019 44D 106</b>
			Fg.-Nr. 4379289→C236473→	01.13→		6		<b>023 058</b>	
						THD	6		<b>*022 021 44D 131</b>
			F3HFE611... <Cursor 13>	11.13→		6		<b>043 065</b>	
<b>340 T</b> 36	7,8	265	F2BE3681A*... Fg.-Nr. →2575388	04.06-12.12		6		<b>023 057</b>	
			Fg.-Nr. 2575389→	04.06-12.12	THD	6			<b>*022 019 44D 106</b>
				04.06-12.12	THD	6			<b>*022 021 44D 131</b>
41, 45	13,0	302/331	F3BE3681C*...; F3BE3681D*... Fg.-Nr. →2575388	04.06-12.12	THD	6		<b>023 057</b>	
			Fg.-Nr. 2575389→	04.06-12.12	THD	6			<b>*022 019 44D 106</b>
				04.06-12.12	THD	6			<b>*022 021 44D 131</b>
<b>340T</b> 36 [13]	7,8	265	F2BE3681A*... Fg.-Nr. →4379288 →C236472	01.13→		6		<b>023 057</b>	
						THD	6		<b>*022 019 44D 106</b>
			Fg.-Nr. 4379289→C236473→	01.13→		6		<b>023 058</b>	
						THD	6		<b>*022 021 44D 131</b>
36, 40 [13]	8,7	265/294	F2CFE611A <Euro 6>; F2CFE611B <Euro 6>	11.13→		6		<b>043 064</b>	
41, 45 [13]	12,9	302/331	F3HFE611C* <CURSOR 13>; F3HFE611D* <CURSOR 13>	11.13→	TW	6		<b>043 064</b>	
						6		<b>043 065</b>	
	13,0	301/332	F3BE3681C*S; F3BE3681D*S Fg.-Nr. →4379288 →C236472	01.13→		6		<b>023 057</b>	
						THD	6		<b>*022 019 44D 106</b>
			Fg.-Nr. 4379289→C236473→	01.13→		6		<b>023 058</b>	
						THD	6		<b>*022 021 44D 131</b>
50 [13]	12,9	368	F3BE3681B*... Fg.-Nr. →2575389	01.18→		6		<b>023 057</b>	
			Fg.-Nr. 2575390→	01.18→		6		<b>023 058</b>	
			F3HFE611... <Cursor 13>	09.14→		6		<b>043 065</b>	
<b>380 T</b> 36	7,8	265	F2BE3681A*... Fg.-Nr. →2575388	04.06-12.12		6		<b>023 057</b>	
			Fg.-Nr. 2575389→	04.06-12.12	THD	6			<b>*022 019 44D 106</b>
				04.06-12.12	THD	6			<b>*022 021 44D 131</b>
41, 45	13,0	302/331	F3BE3681C*...; F3BE3681D*... Fg.-Nr. →2575388	04.06-12.12		6		<b>023 057</b>	
			Fg.-Nr. 2575389→	04.06-12.12	THD	6			<b>*022 019 44D 106</b>
				04.06-12.12	THD	6			<b>*022 021 44D 131</b>
50	12,9	368	F3BE3681B*... Fg.-Nr. →2575388	04.06-12.12		6		<b>023 057</b>	
			Fg.-Nr. 2575389→	04.06-12.12	THD	6			<b>*022 019 44D 106</b>
				04.06-12.12	THD	6			<b>*022 021 44D 131</b>
<b>380T</b> 36 [13]	7,8	265	F2BE3681A*... Fg.-Nr. →4379288 →C236472	01.13→		6		<b>023 057</b>	
			Fg.-Nr. 4379289→C236473→	01.13→		6		<b>023 058</b>	
	8,7	265	F2CFE611B <Euro 6>	11.13→		6		<b>043 064</b>	
						6		<b>043 065</b>	
41, 45 [13]	12,9	302/331	F3HFE611C* <CURSOR 13>; F3HFE611D* <CURSOR 13>	11.13→	TW	6		<b>043 064</b>	
						6		<b>043 065</b>	



									<b>A</b>	<b>B</b>		
									0 444 ...	0 444 ...	* 0 444 ... ** F 01C ...	0 986 ...
<b>380T</b> 41, 45 [13]	13,0	301/332	F3BE3681C*S; F3BE3681D*S									
			Fg.-Nr. →4379288 →C236472	01.13→				6		<b>023 057</b>		
								THD 6			* 022 019	<b>44D 106</b>
			Fg.-Nr. 4379289→C236473→	01.13→				6		<b>023 058</b>		
								THD 6			* 022 021	<b>44D 131</b>
42 [13]	10,3	309	F3AE3681D*...									
			Fg.-Nr. →4379288 →C236472	07.13→				6		<b>023 057</b>		
								THD 6			* 022 019	<b>44D 106</b>
			Fg.-Nr. 4379289→C236473→	07.13→				6		<b>023 058</b>		
								THD 6			* 022 021	<b>44D 131</b>
50 [13]	12,9	368	F3BE3681B*...									
			Fg.-Nr. →4379288 →C236472	01.13→				6		<b>023 057</b>		
								THD 6			* 022 019	<b>44D 106</b>
			Fg.-Nr. 4379289→C236473→	01.13→				6		<b>023 058</b>		
								THD 6			* 022 021	<b>44D 131</b>
			F3HFE611... <Cursor 13>	11.13→				6		<b>043 065</b>		
<b>400T</b> 36	7,8	265	F2BE3681A*...	04.06-12.12				6		<b>023 057</b>		
			Fg.-Nr. →2575388	04.06-12.12	THD			6			* 022 019	<b>44D 106</b>
			Fg.-Nr. 2575389→	04.06-12.12	THD			6			* 022 021	<b>44D 131</b>
41	13,0	302	F3BE3681D*...	04.06-12.12				6		<b>023 057</b>		
			Fg.-Nr. →2575388	04.06-12.12	THD			6			* 022 019	<b>44D 106</b>
			Fg.-Nr. 2575389→	04.06-12.12	THD			6			* 022 021	<b>44D 131</b>
50	12,9	368	F3BE3681B*...	04.06-12.12				6		<b>023 057</b>		
			Fg.-Nr. →2575388	04.06-12.12	THD			6			* 022 019	<b>44D 106</b>
			Fg.-Nr. 2575389→	04.06-12.12	THD			6			* 022 021	<b>44D 131</b>
<b>400T</b> 36 [13]	8,7	265	F2CFE611B <Euro 6>	11.13→				6		<b>043 064</b>		
41, 45 [13]	12,9	302/331	F3HFE611C*C <CURSOR 13>; F3HFE611D*C <CURSOR 13>	11.13→	TW			6		<b>043 064</b>		
								6		<b>043 065</b>		
	13,0	301	F3BE3681C*S; F3BE3681D*...									
			Fg.-Nr. →4379288 →C236472	01.13→				6		<b>023 057</b>		
								THD 6			* 022 019	<b>44D 106</b>
			Fg.-Nr. 4379289→C236473→	01.13→				6		<b>023 058</b>		
								THD 6			* 022 021	<b>44D 131</b>
50 [13]	12,9	368	F3BE3681B*...									
			Fg.-Nr. →4379288 →C236472	01.13→				6		<b>023 057</b>		
			Fg.-Nr. 4379289→C236473→	01.13→				6		<b>023 058</b>		
			F3HFE611... <Cursor 13>	11.13→				6		<b>043 065</b>		
<b>410T</b> 36	7,8	265	F2BE3681A*...	04.06-12.12				6		<b>023 057</b>		
			Fg.-Nr. →2575388	04.06-12.12	THD			6			* 022 019	<b>44D 106</b>
			Fg.-Nr. 2575389→	04.06-12.12	THD			6			* 022 021	<b>44D 131</b>
41, 45	13,0	302/331	F3BE3681C*...; F3BE3681D*...	04.06-12.12				6		<b>023 057</b>		
			Fg.-Nr. →2575388	04.06-12.12	THD			6			* 022 019	<b>44D 106</b>
			Fg.-Nr. 2575389→	04.06-12.12	THD			6			* 022 021	<b>44D 131</b>
50	12,9	368	F3BE3681B*...	04.06-12.12				6		<b>023 057</b>		
			Fg.-Nr. →2575388	04.06-12.12	THD			6			* 022 019	<b>44D 106</b>
			Fg.-Nr. 2575389→	04.06-12.12	THD			6			* 022 021	<b>44D 131</b>
<b>410T</b> 36 [13]	8,7	265	F2CFE611B <Euro 6>	11.13→				6		<b>043 064</b>		
41, 45 [13]	12,9	302/331	F3HFE611C*C <CURSOR 13>; F3HFE611D*C <CURSOR 13>	11.13→	TW			6		<b>043 064</b>		
								6		<b>043 065</b>		
	13,0	301	F3BE3681C*S; F3BE3681D*S									
			Fg.-Nr. →4379288 →C236472	01.13→				6		<b>023 057</b>		
								THD 6			* 022 019	<b>44D 106</b>
			Fg.-Nr. 4379289→C236473→	01.13→				6		<b>023 058</b>		
								THD 6			* 022 021	<b>44D 131</b>
42 [13]	10,3	309	F3AE3681D*...									
			Fg.-Nr. →4379288 →C236472	07.13→				6		<b>023 057</b>		
								THD 6			* 022 019	<b>44D 106</b>
			Fg.-Nr. 4379289→C236473→	07.13→				6		<b>023 058</b>		
								THD 6			* 022 021	<b>44D 131</b>





◀ IVECO 0 444 ... 0 444 ... \* 0 444 ... \*\* F 01C ... 0 986 ...

<b>410T 50</b> [13]	12,9	368	F3BE3681B*...						
			Fg.-Nr. →4379288 →C236472	01.13→		6		<b>023 057</b>	
					THD	6			<b>* 022 019 44D 106</b>
			Fg.-Nr. 4379289→ C236473→	01.13→		6		<b>023 058</b>	
					THD	6			<b>* 022 021 44D 131</b>
			F3HFE611... <Cursor 13>	11.13→		6		<b>043 065</b>	
<b>440 T 41, 45</b>	13,0	302/331	F3BE3681C*...; F3BE3681D*...	04.06-12.12		6		<b>023 057</b>	
			Fg.-Nr. →2575388	04.06-12.12	THD	6			<b>* 022 019 44D 106</b>
			Fg.-Nr. 2575389→	04.06-12.12	THD	6			<b>* 022 021 44D 131</b>
50	12,9	368	F3BE3681B*...	04.06-12.12		6		<b>023 057</b>	
			Fg.-Nr. →2575388	04.06-12.12	THD	6			<b>* 022 019 44D 106</b>
			Fg.-Nr. 2575389→	04.06-12.12	THD	6			<b>* 022 021 44D 131</b>
<b>440T 41</b> [13]	12,9	302	F3HFE611D*C <CURSOR 13>	11.13→		6		<b>043 064</b>	
					TW	6		<b>043 064</b>	
						6		<b>043 065</b>	
41, 45 [13]	13,0	301/332	F3BE3681C*S; F3BE3681D*...						
			Fg.-Nr. →4379288 →C236472	01.13→		6		<b>023 057</b>	
					THD	6			<b>* 022 019 44D 106</b>
			Fg.-Nr. 4379289→ C236473→	01.13→		6		<b>023 058</b>	
					THD	6			<b>* 022 021 44D 131</b>
45 [13]	12,9	331	F3HFE611C*C <CURSOR 13>	11.13→	TW	6		<b>043 064</b>	
						6		<b>043 065</b>	
50 [13]	12,9	368	F3BE3681B*...						
			Fg.-Nr. →4379288 →C236472	01.13→		6		<b>023 057</b>	
			Fg.-Nr. 4379289→ C236473→	01.13→		6		<b>023 058</b>	
			F3HFE611... <Cursor 13>	11.13→		6		<b>043 065</b>	
<b>720 T 41, 45</b>	13,0	302/331	F3BE3681C*...; F3BE3681D*...	04.06-12.12		6		<b>023 057</b>	
			Fg.-Nr. →2575388	04.06-12.12	THD	6			<b>* 022 019 44D 106</b>
			Fg.-Nr. 2575389→	04.06-12.12	THD	6			<b>* 022 021 44D 131</b>
50	12,9	368	F3BE3681B*...	04.06-12.12		6		<b>023 057</b>	
			Fg.-Nr. →2575388	04.06-12.12	THD	6			<b>* 022 019 44D 106</b>
			Fg.-Nr. 2575389→	04.06-12.12	THD	6			<b>* 022 021 44D 131</b>
<b>720T 41, 45</b> [13]	12,9	302/331	F3HFE611C*C <CURSOR 13>; F3HFE611D*C <CURSOR 13>	11.13→	TW	6		<b>043 064</b>	
						6		<b>043 065</b>	
	13,0	301/332	F3BE3681C*S; F3BE3681D*...						
			Fg.-Nr. →4379288 →C236472	01.13→		6		<b>023 057</b>	
					THD	6			<b>* 022 019 44D 106</b>
			Fg.-Nr. 4379289→ C236473→	01.13→		6		<b>023 058</b>	
					THD	6			<b>* 022 021 44D 131</b>
50 [13]	12,9	368	F3BE3681B*...						
			Fg.-Nr. →4379288 →C236472	01.13→		6		<b>023 057</b>	
					THD	6			<b>* 022 019 44D 106</b>
			Fg.-Nr. 4379289→ C236473→	01.13→		6		<b>023 058</b>	
					THD	6			<b>* 022 021 44D 131</b>
			F3HFE611... <Cursor 13>	11.13→		6		<b>043 065</b>	

<b>Urbanway</b>									
<b>12</b>	8,7	228/294	F2CFE612A <Cursor 9 - Euro 6>; F2CFE612D <Cursor 9 - Euro 6>	06.13→		6		<b>043 064</b>	
					THD	6			<b>* 010 008</b>
<b>18</b>	8,7	228/294	F2CFE612A <Cursor 9 - Euro 6>; F2CFE612D <Cursor 9 - Euro 6>	06.13→		6		<b>043 064</b>	

**MAN**

<b>Bus</b>									
<b>26.480</b> HOCLN-SD [RR4]	12,4	353	D 2676 LOH33 <Euro 4>; D 2676 LOH34 <Euro 5/EEV>	03.15→		6		<b>011 006</b>	
					THD	6			<b>* 010 037</b>
<b>TGA</b>									
<b>18.320</b> F, FL, FC, FK, FL	10,5	235	D 2066 LF20 <Euro 5/OBD1>; D 2066 LF28 <Euro 5/OBD1>; D 2066 LF30 <Euro 5/OBD1>	04.07-08.08		6		<b>011 006</b>	
					THD, TW	6			<b>* 010 013</b>
						6			<b>* 010 022</b>

									<b>A</b>	<b>B</b>	
									0 444 ...	0 444 ...	* 0 444 ... ** F 01C ... 0 986 ...
<b>18.360</b> F, FL	10,5	265	D 2066 LF19 <Euro 5/OBD1>; D 2066 LF27 <Euro 5/OBD1>; D 2066 LF29 <V5500, Euro 5>	04.07-08.08	6				<b>011 006</b>		
					THD,TW	6					* 010 013
						6					* 010 022
<b>18.400</b> F, FL	10,5	294	D 2066 LF18 <Euro 5/OBD1>	04.08-08.08	6				<b>011 006</b>		
					THD,TW	6					* 010 013
						6					* 010 022
F, FL, FC, FK, FL	10,5	294	D 2066 LF24 <Euro 5/OBD1>; D 2066 LF26 <Euro 5/OBD1>	01.06-08.08	6				<b>011 006</b>		
					THD,TW	6					* 010 013
						6					* 010 022
FC, FK, FL	10,5	294	D 2066 LF22 <V5500, Euro 5>	01.06-11.06	6				<b>011 006</b>		
					THD,TW	6					* 010 006
						6					* 010 013
<b>18.440</b> F, FL	10,5	321/324	D 2066 LF23 <Euro 5/OBD1>; D 2066 LF25 <Euro 5/OBD1>	02.07-08.08	6				<b>011 006</b>		
					THD,TW	6					* 010 013
						6					* 010 022
		324	D 2066 LF17 <Euro 5/OBD1>	04.08-08.08	6				<b>011 006</b>		
					THD,TW	6					* 010 013
						6					* 010 022
FC, FK, FL	10,5	321	D 2066 LF21 <V5500, Euro 5>	01.06-11.06	6				<b>011 006</b>		
					THD,TW	6					* 010 006
						6					* 010 013
<b>18.480</b> F, FL	12,4	353	D 2676 LF12 <Euro 5/OBD1>; D 2676 LF14 <Euro 5/OBD1>; D 2676 LF16 <Euro 5/OBD1>	07.06-08.08	6				<b>011 006</b>		
					THD,TW	6					* 010 013
						6					* 010 022
<b>18.540</b> F, FL	12,4	397	D 2676 LF11 <Euro 5/OBD1>; D 2676 LF13 <Euro 5/OBD1>; D 2676 LF15 <Euro 5/OBD1>	02.07-08.08	6				<b>011 006</b>		
					THD,TW	6					* 010 013
						6					* 010 022
<b>24.360</b> DF	10,5	265	D 2066 LF19 <Euro 5/OBD1>; D 2066 LF27 <Euro 5/OBD1>; D 2066 LF29 <V5500, Euro 5>	04.07-08.08	6				<b>011 006</b>		
					THD,TW	6					* 010 013
						6					* 010 022
<b>24.400</b> DF	10,5	294	D 2066 LF18 <Euro 5/OBD1>	04.08-08.08	6				<b>011 006</b>		
					THD,TW	6					* 010 013
						6					* 010 022
			D 2066 LF22 <V5500, Euro 5>	07.06-11.06	6				<b>011 006</b>		
					THD,TW	6					* 010 006
						6					* 010 013
			D 2066 LF24 <Euro 5/OBD1>; D 2066 LF26 <Euro 5/OBD1>	07.06-08.08	6				<b>011 006</b>		
					THD,TW	6					* 010 013
						6					* 010 022
<b>24.440</b> DF	10,5	321	D 2066 LF21 <V5500, Euro 5>	07.06-11.06	6				<b>011 006</b>		
					THD,TW	6					* 010 006
						6					* 010 013
		324	D 2066 LF17 <Euro 5/OBD1>	04.08-08.08	6				<b>011 006</b>		
					THD,TW	6					* 010 013
						6					* 010 022
DF, FD	10,5	321/324	D 2066 LF23 <Euro 5/OBD1>; D 2066 LF25 <Euro 5/OBD1>	02.07-08.08	6				<b>011 006</b>		
					THD,TW	6					* 010 013
						6					* 010 022
<b>24.480</b> DF	12,4	353	D 2676 LF12 <Euro 5/OBD1>; D 2676 LF14 <Euro 5/OBD1>; D 2676 LF16 <Euro 5/OBD1>	07.06-08.08	6				<b>011 006</b>		
					THD,TW	6					* 010 013
						6					* 010 022
<b>24.540</b> DF	12,4	397	D 2676 LF11 <Euro 5/OBD1>; D 2676 LF13 <Euro 5/OBD1>; D 2676 LF15 <Euro 5/OBD1>	02.07-08.08	6				<b>011 006</b>		
					THD,TW	6					* 010 013
						6					* 010 022
<b>26.320</b> FD, FH, FN, FV	10,5	235	D 2066 LF20 <Euro 5/OBD1>; D 2066 LF28 <Euro 5/OBD1>; D 2066 LF30 <Euro 5/OBD1>	04.07-08.08	6				<b>011 006</b>		
					THD,TW	6					* 010 013
						6					* 010 022
<b>26.360</b> FD, FH, FN, FV	10,5	265	D 2066 LF19 <Euro 5/OBD1>; D 2066 LF27 <Euro 5/OBD1>; D 2066 LF29 <V5500, Euro 5>	04.07-08.08	6				<b>011 006</b>		
					THD,TW	6					* 010 013
						6					* 010 022
<b>26.400</b> FD, FH, FN, FV	10,5	294	D 2066 LF18 <Euro 5/OBD1>	04.08-08.08	6				<b>011 006</b>		
					THD,TW	6					* 010 013
						6					* 010 022





◀ MAN

						0 444 ...	0 444 ...	*0 444 ...	** F01C ...	0 986 ...
<b>26.400</b>	FD, FH, FN, FV	10,5	294	D 2066 LF22 <Euro 5>	01.06-11.06	6	<b>011 006</b>			
						THD, TW 6		<b>*010 006</b>		
						6		<b>*010 013</b>		
				D 2066 LF24 <Euro 5/OBD1>; D 2066 LF26 <Euro 5/OBD1>	01.06-08.08	6	<b>011 006</b>			
						THD, TW 6		<b>*010 013</b>		
						6		<b>*010 022</b>		
<b>26.440</b>	F, FL, FD, FH, FN, FV	10,5	321/324	D 2066 LF23 <Euro 5/OBD1>; D 2066 LF25 <Euro 5/OBD1>	02.07-08.08	6	<b>011 006</b>			
						THD, TW 6		<b>*010 013</b>		
						6		<b>*010 022</b>		
	FD, FH, FN, FV	10,5	321	D 2066 LF17 <Euro 5/OBD1>	04.08-08.08	6	<b>011 006</b>			
						THD, TW 6		<b>*010 013</b>		
						6		<b>*010 022</b>		
				D 2066 LF21 <Euro 5>	01.06-11.06	6	<b>011 006</b>			
						THD, TW 6		<b>*010 006</b>		
						6		<b>*010 013</b>		
<b>26.480</b>	FD, FH, FN, FV	12,4	353	D 2676 LF12 <Euro 5/OBD1>; D 2676 LF14 <Euro 5/OBD1>; D 2676 LF16 <Euro 5/OBD1>	07.06-08.08	6	<b>011 006</b>			
						THD, TW 6		<b>*010 013</b>		
						6		<b>*010 022</b>		
<b>26.540</b>	FD, FH, FN, FV	12,4	397	D 2676 LF11 <Euro 5/OBD1>; D 2676 LF13 <Euro 5/OBD1>; D 2676 LF15 <Euro 5/OBD1>	02.07-08.08	6	<b>011 006</b>			
						THD, TW 6		<b>*010 013</b>		
						6		<b>*010 022</b>		
<b>28.320</b>	FN	10,5	235/236	D 2066 LF20 <Euro 5/OBD1>; D 2066 LF28 <Euro 5/OBD1>; D 2066 LF30 <Euro 5/OBD1>	04.07-08.08	6	<b>011 006</b>			
						THD, TW 6		<b>*010 013</b>		
						6		<b>*010 022</b>		
<b>28.360</b>	FN	10,5	265	D 2066 LF19 <Euro 5/OBD1>; D 2066 LF27 <Euro 5/OBD1>; D 2066 LF29 <Euro 5>	04.07-08.08	6	<b>011 006</b>			
						THD, TW 6		<b>*010 013</b>		
						6		<b>*010 022</b>		
<b>28.400</b>	FN	10,5	294	D 2066 LF18 <Euro 5/OBD1>	04.08-08.08	6	<b>011 006</b>			
						THD, TW 6		<b>*010 013</b>		
						6		<b>*010 022</b>		
				D 2066 LF22 <Euro 5>	07.06-11.06	6	<b>011 006</b>			
						THD, TW 6		<b>*010 006</b>		
						6		<b>*010 013</b>		
				D 2066 LF24 <Euro 5/OBD1>; D 2066 LF26 <Euro 5/OBD1>	07.06-08.08	6	<b>011 006</b>			
						THD, TW 6		<b>*010 013</b>		
						6		<b>*010 022</b>		
<b>28.440</b>	DF	10,5	321	D 2066 LF21 <Euro 5>	01.06-11.06	6	<b>011 006</b>			
						THD, TW 6		<b>*010 006</b>		
						6		<b>*010 013</b>		
	FN	10,5	321/324	D 2066 LF23 <Euro 5/OBD1>; D 2066 LF25 <Euro 5/OBD1>	02.07-08.08	6	<b>011 006</b>			
						THD, TW 6		<b>*010 013</b>		
						6		<b>*010 022</b>		
			324	D 2066 LF17 <Euro 5/OBD1>	04.08-08.08	6	<b>011 006</b>			
						THD, TW 6		<b>*010 013</b>		
						6		<b>*010 022</b>		
<b>28.480</b>	FN	12,4	353	D 2676 LF12 <Euro 5/OBD1>	07.06-09.07	6	<b>011 006</b>			
						THD 6		<b>*010 013</b>		
				D 2676 LF14 <Euro 5/OBD1>; D 2676 LF16 <Euro 5/OBD1>	10.07-08.08	6	<b>011 006</b>			
						THD, TW 6		<b>*010 013</b>		
						6		<b>*010 022</b>		
<b>28.540</b>	FN	12,4	397	D 2676 LF11 <Euro 5/OBD1>	02.07-09.07	6	<b>011 006</b>			
						THD 6		<b>*010 013</b>		
				D 2676 LF13 <Euro 5/OBD1>; D 2676 LF15 <Euro 5/OBD1>	10.07-08.08	6	<b>011 006</b>			
						THD, TW 6		<b>*010 013</b>		
						6		<b>*010 022</b>		
<b>41.540</b>	FV	12,4	397	D 2676 LF11 <Euro 5/OBD1>	04.07-09.07	6	<b>011 006</b>			
						THD 6		<b>*010 013</b>		
				D 2676 LF13 <Euro 5/OBD1>	10.07-07.08	6	<b>011 006</b>			
						THD, TW 6		<b>*010 013</b>		
						6		<b>*010 022</b>		
<b>TGL</b>										
<b>7.160</b>		4,6	118	D 0834 LFL77 <Euro 6/OBDC>	09.17→	4	<b>063 001</b>	<b>*062 002</b>		
<b>7.190</b>		4,6	140	D 0834 LFL78 <Euro 6/OBDC>	09.17→	4	<b>063 001</b>	<b>*062 002</b>		





										*0 444 ... ** F 01C ... 0 986 ...
						0 444 ...	0 444 ...			
<b>8.160</b>	4,6	118	D 0834 LFL77 <Euro 6/OBDC>	09.17→		4	<b>063 001</b>	<b>* 062 002</b>		
<b>8.190</b>	4,6	140	D 0834 LFL78 <Euro 6/OBDC>	09.17→		4	<b>063 001</b>	<b>* 062 002</b>		
<b>8.220</b>	4,6	162	D 0834 LFL79 <Euro 6/OBDC>	09.17→		4	<b>063 001</b>	<b>* 062 002</b>		
<b>8.250</b>	6,9	184	D 0836 LFL79 <Euro 6/OBDC>	09.17→		6	<b>063 001</b>	<b>* 062 002</b>		
<b>10.190</b>	4,6	140	D 0834 LFL78 <Euro 6/OBDC>	09.17→		4	<b>063 001</b>	<b>* 062 002</b>		
<b>10.220</b>	4,6	162	D 0834 LFL79 <Euro 6/OBDC>	09.17→		4	<b>063 001</b>	<b>* 062 002</b>		
<b>10.250</b>	6,9	184	D 0836 LFL79 <Euro 6/OBDC>	09.17→		6	<b>063 001</b>	<b>* 062 002</b>		
<b>12.190</b>	4,6	140	D 0834 LFL78 <Euro 6/OBDC>	09.17→		4	<b>063 001</b>	<b>* 062 002</b>		
<b>12.220</b>	4,6	162	D 0834 LFL79 <Euro 6/OBDC>	09.17→		4	<b>063 001</b>	<b>* 062 002</b>		
<b>12.250</b>	6,9	184	D 0836 LFL79 <Euro 6/OBDC>	09.17→		6	<b>063 001</b>	<b>* 062 002</b>		
<b>TGM</b>										
<b>12.250</b>	6,9	184	D 0836 LFL79 <Euro 6/OBDC>	09.17→		6	<b>063 001</b>	<b>* 062 002</b>		
<b>12.290</b>	6,9	213	D 0836 LFL80 <Euro 6/OBDC>	09.17→		6	<b>063 001</b>	<b>* 062 002</b>		
<b>13.250</b>	6,9	184	D 0836 LFL79 <Euro 6/OBDC>	09.17→		6	<b>063 001</b>	<b>* 062 002</b>		
<b>13.290</b>	6,9	213	D 0836 LFL80 <Euro 6/OBDC>	09.17→		6	<b>063 001</b>	<b>* 062 002</b>		
<b>15.250</b>	6,9	184	D 0836 LFL79 <Euro 6/OBDC>	09.17→		6	<b>063 001</b>	<b>* 062 002</b>		
<b>15.290</b>	6,9	213	D 0836 LFL80 <Euro 6/OBDC>	09.17→		6	<b>063 001</b>	<b>* 062 002</b>		
<b>15.320</b>	6,9	235	D 0836 LFL81 <Euro 6/OBDC>	09.17→		6	<b>063 001</b>	<b>* 062 002</b>		
<b>18.250</b>	6,9	184	D 0836 LFL79 <Euro 6/OBDC>	09.17→		6	<b>063 001</b>	<b>* 062 002</b>		
<b>18.290</b>	6,9	213	D 0836 LFL80 <Euro 6/OBDC>	09.17→		6	<b>063 001</b>	<b>* 062 002</b>		
<b>18.320</b>	6,9	235	D 0836 LFL81 <Euro 6/OBDC>	09.17→		6	<b>063 001</b>	<b>* 062 002</b>		
<b>19.250</b>	6,9	184	D 0836 LFL79 <Euro 6/OBDC>	09.17→		6	<b>063 001</b>	<b>* 062 002</b>		
<b>19.290</b>	6,9	213	D 0836 LFL80 <Euro 6/OBDC>	09.17→		6	<b>063 001</b>	<b>* 062 002</b>		
<b>19.320</b>	6,9	235	D 0836 LFL81 <Euro 6/OBDC>	09.17→		6	<b>063 001</b>	<b>* 062 002</b>		
<b>26.290</b>	6,9	213	D 0836 LFL80 <Euro 6/OBDC>	09.17→		6	<b>063 001</b>	<b>* 062 002</b>		
<b>26.320</b>	6,9	235	D 0836 LFL81 <Euro 6/OBDC>	09.17→		6	<b>063 001</b>	<b>* 062 002</b>		
<b>TGS</b>										
<b>18.320</b>	10,5	235	D 2066 LF20 <Euro 5/OBD1>; D 2066 LF28 <Euro 5/OBD1>	10.07-05.11		6	<b>011 006</b>			
						THD,TW	6	<b>* 010 013</b>		
						6		<b>* 010 022</b>		
			D 2066 LF43 <Euro 5/OBD2>; D 2066 LF60 <Euro 5/EEV/OBD2>	09.09→		6	<b>011 006</b>			
				09.09-06.13	THD	6		<b>* 010 026</b>		
				07.13→	THD	6		<b>* 010 037</b>		
<b>18.360</b>	10,5	265	D 2066 LF19 <Euro 5/OBD1>; D 2066 LF27 <Euro 5/OBD1>	10.07-05.11		6	<b>011 006</b>			
						THD,TW	6	<b>* 010 013</b>		
						6		<b>* 010 022</b>		
			D 2066 LF42 <Euro 5/OBD2>; D 2066 LF59 <Euro 5/EEV/OBD2>	09.09→		6	<b>011 006</b>			
				09.09-06.13	THD	6		<b>* 010 026</b>		
				07.13→	THD	6		<b>* 010 037</b>		
WW	10,5	265	D 2066 LF42 <Euro 5/OBD2>; D 2066 LF59 <Euro 5/EEV/OBD2>	06.16→		6	<b>011 006</b>			
						THD	6	<b>* 010 037</b>		
			D 2066 LF64 <Euro 4/OBD2>	06.10→		6	<b>011 006</b>			
				06.10-06.13	THD	6		<b>* 010 027</b>		
				07.13→	THD	6		<b>* 010 037</b>		
<b>18.400</b>	10,5	294	D 2066 LF18 <Euro 5/OBD1>; D 2066 LF26 <Euro 5/OBD1>	10.07-05.11		6	<b>011 006</b>			
						THD,TW	6	<b>* 010 013</b>		
						6		<b>* 010 022</b>		
			D 2066 LF41 <Euro 5/OBD2>; D 2066 LF58 <Euro 5/EEV/OBD2>	09.09→		6	<b>011 006</b>			
				09.09-06.13	THD	6		<b>* 010 026</b>		
				07.13→	THD	6		<b>* 010 037</b>		
WW	10,5	294	D 2066 LF41 <Euro 5/OBD2>; D 2066 LF58 <Euro 5/EEV/OBD2>	06.16→		6	<b>011 006</b>			
						THD	6	<b>* 010 037</b>		
			D 2066 LF63 <Euro 4/OBD2>	06.10→		6	<b>011 006</b>			
				06.10-06.13	THD	6		<b>* 010 027</b>		
				07.13→	THD	6		<b>* 010 037</b>		
10,5	324		D 2066 LF17 <Euro 5/OBD1>; D 2066 LF25 <Euro 5/OBD1>	10.07-05.11		6	<b>011 006</b>			
						THD,TW	6	<b>* 010 013</b>		
						6		<b>* 010 022</b>		
			D 2066 LF40 <Euro 5/OBD2>; D 2066 LF57 <Euro 5/EEV/OBD2>	09.09→		6	<b>011 006</b>			
				09.09-06.13	THD	6		<b>* 010 026</b>		
				07.13→	THD	6		<b>* 010 037</b>		
WW	10,5	324	D 2066 LF40 <Euro 5/OBD2>; D 2066 LF57 <Euro 5/EEV/OBD2>	06.16→		6	<b>011 006</b>			
						THD	6	<b>* 010 037</b>		

















◀ MAN				0 444 ...	0 444 ...	* 0 444 ...	** F 01C ...	0 986 ...
<b>18.440 WW</b>	10,5	324	D 2066 LF62 <Euro 4/OBD2>	06.10→	6	<b>011 006</b>		
				06.10-06.13 THD	6		<b>* 010 027</b>	
				07.13→	THD 6		<b>* 010 037</b>	
<b>18.480</b>	12,4	353	D 2676 LF07 <Euro 5/OBD2>	09.09→	6	<b>011 006</b>		
				09.09-06.13 THD	6		<b>* 010 026</b>	
				07.13→	THD 6		<b>* 010 037</b>	
			D 2676 LF18 <Euro 5/EEV/OBD2>	09.09→	6	<b>011 006</b>		
				09.09-06.13 THD	6		<b>* 010 026</b>	
				07.13→	THD 6		<b>* 010 037</b>	
, F, FL	12,4	353	D 2676 LF14 <Euro 5/OBD1>; D 2676 LF16 <Euro 5/OBD1>	10.07-05.11	6	<b>011 006</b>		
				THD,	6		<b>* 010 013</b>	
				TW	6		<b>* 010 022</b>	
WW	12,4	353	D 2676 LF07 <Euro 5/OBD2>	06.16→	6	<b>011 006</b>		
				THD	6		<b>* 010 037</b>	
			D 2676 LF20 <Euro 4/OBD2>	06.10→	6	<b>011 006</b>		
				06.10-06.13 THD	6		<b>* 010 027</b>	
				07.13→	THD 6		<b>* 010 037</b>	
<b>18.540</b>	12,4	397	D 2676 LF06 <Euro 5/OBD2>	09.09→	6	<b>011 006</b>		
				09.09-06.13 THD	6		<b>* 010 026</b>	
				07.13→	THD 6		<b>* 010 037</b>	
			D 2676 LF13 <Euro 5/OBD1>; D 2676 LF15 <Euro 5/OBD1>	10.07-05.11	6	<b>011 006</b>		
				THD,	6		<b>* 010 013</b>	
				TW	6		<b>* 010 022</b>	
<b>19.320 WW</b>	10,5	235	D 2066 LF43 <Euro 5/OBD2>	06.16→	6	<b>011 006</b>		
				THD	6		<b>* 010 037</b>	
<b>19.360 WW</b>	10,5	265	D 2066 LF42 <Euro 5/OBD2>; D 2066 LF59 <Euro 5/EEV/OBD2> D 2066 LF64 <Euro 4/OBD2>	06.16→	6	<b>011 006</b>		
				THD	6		<b>* 010 037</b>	
				02.11→	6	<b>011 006</b>		
				02.11-06.13 THD	6		<b>* 010 027</b>	
				07.13→	THD 6		<b>* 010 037</b>	
<b>19.400 WW</b>	10,5	294	D 2066 LF41 <Euro 5/OBD2>; D 2066 LF58 <Euro 5/EEV/OBD2> D 2066 LF63 <Euro 4/OBD2>	06.16→	6	<b>011 006</b>		
				THD	6		<b>* 010 037</b>	
				02.11→	6	<b>011 006</b>		
				02.11-06.13 THD	6		<b>* 010 027</b>	
				07.13→	THD 6		<b>* 010 037</b>	
<b>19.440 WW</b>	10,5	324	D 2066 LF40 <Euro 5/OBD2>; D 2066 LF57 <Euro 5/EEV/OBD2> D 2066 LF62 <Euro 4/OBD2>	06.16→	6	<b>011 006</b>		
				THD	6		<b>* 010 037</b>	
				02.11→	6	<b>011 006</b>		
				02.11-06.13 THD	6		<b>* 010 027</b>	
				07.13→	THD 6		<b>* 010 037</b>	
<b>19.480 WW</b>	12,4	353	D 2676 LF07 <Euro 5/OBD2>; D 2676 LF18 <Euro 5/EEV/OBD2> D 2676 LF20 <Euro 4/OBD2>	06.16→	6	<b>011 006</b>		
				THD	6		<b>* 010 037</b>	
				02.11→	6	<b>011 006</b>		
				02.11-06.13 THD	6		<b>* 010 027</b>	
				07.13→	THD 6		<b>* 010 037</b>	
<b>20.320 , WW</b>	10,5	235	D 2066 LF43 <Euro 5/OBD2>; D 2066 LF60 <Euro 5/EEV/OBD2>	07.17→	6	<b>011 006</b>		
				THD	6		<b>* 010 037</b>	
<b>20.360 , WW</b>	10,5	265	D 2066 LF42 <Euro 5/OBD2>; D 2066 LF59 <Euro 5/EEV/OBD2>	07.17→	6	<b>011 006</b>		
				THD	6		<b>* 010 037</b>	
<b>20.400 , WW</b>	10,5	294	D 2066 LF41 <Euro 5/OBD2>; D 2066 LF58 <Euro 5/EEV/OBD2>	07.17→	6	<b>011 006</b>		
				THD	6		<b>* 010 037</b>	
<b>20.440 , WW</b>	10,5	324	D 2066 LF40 <Euro 5/OBD2>; D 2066 LF57 <Euro 5/EEV/OBD2>	07.17→	6	<b>011 006</b>		
				THD	6		<b>* 010 037</b>	
<b>21.320 WW</b>	10,5	235	D 2066 LF43 <Euro 5/OBD2>	06.16→	6	<b>011 006</b>		
				THD	6		<b>* 010 037</b>	
<b>21.360 WW</b>	10,5	265	D 2066 LF42 <Euro 5/OBD2>; D 2066 LF59 <Euro 5/EEV/OBD2> D 2066 LF64 <Euro 4/OBD2>	06.16→	6	<b>011 006</b>		
				THD	6		<b>* 010 037</b>	
				05.12→	6	<b>011 006</b>		
				05.12-06.13 THD	6		<b>* 010 027</b>	
				07.13→	THD 6		<b>* 010 037</b>	
<b>21.400 WW</b>	10,5	294	D 2066 LF41 <Euro 5/OBD2>; D 2066 LF58 <Euro 5/EEV/OBD2>	06.16→	6	<b>011 006</b>		
				THD	6		<b>* 010 037</b>	



									<b>A</b>	<b>B</b>		
									0 444 ...	0 444 ...	* 0 444 ...	** F 01C ... 0 986 ...
<b>21.400 WW</b>		10,5	294	D 2066 LF63 <Euro 4/OBD2>	05.12→			6		<b>011 006</b>		
					05.12-06.13	THD		6				* 010 027
					07.13→	THD		6				* 010 037
<b>21.440 WW</b>		10,5	324	D 2066 LF40 <Euro 5/OBD2>; D 2066 LF57 <Euro 5/EEV/OBD2>	06.16→			6		<b>011 006</b>		
						THD		6				* 010 037
				D 2066 LF62 <Euro 4/OBD2>	05.12→			6		<b>011 006</b>		
					05.12-06.13	THD		6				* 010 027
					07.13→	THD		6				* 010 037
<b>21.480 WW</b>		12,4	353	D 2676 LF07 <Euro 5/OBD2>; D 2676 LF18 <Euro 5/EEV/OBD2>	06.16→			6		<b>011 006</b>		
						THD		6				* 010 037
				D 2676 LF20 <Euro 4/OBD2>	05.12→			6		<b>011 006</b>		
					05.12-06.13	THD		6				* 010 027
					07.13→	THD		6				* 010 037
<b>24.320</b>		10,5	235	D 2066 LF20 <Euro 5/OBD1>; D 2066 LF28 <Euro 5/OBD1>	10.07-05.11			6		<b>011 006</b>		
						THD,		6				* 010 013
						TW		6				* 010 022
				D 2066 LF43 <Euro 5/OBD2>; D 2066 LF60 <Euro 5/EEV/OBD2>	09.09→			6		<b>011 006</b>		
					09.09-06.13	THD		6				* 010 026
					07.13→	THD		6				* 010 037
<b>24.360</b>		10,5	265	D 2066 LF19 <Euro 5/OBD1>; D 2066 LF27 <Euro 5/OBD1>	10.07-05.11			6		<b>011 006</b>		
						THD,		6				* 010 013
						TW		6				* 010 022
				D 2066 LF42 <Euro 5/OBD2>; D 2066 LF59 <Euro 5/EEV/OBD2>	09.09→			6		<b>011 006</b>		
					09.09-06.13	THD		6				* 010 026
					07.13→	THD		6				* 010 037
<b>24.400</b>		10,5	294	D 2066 LF18 <Euro 5/OBD1>; D 2066 LF26 <Euro 5/OBD1>	10.07-05.11			6		<b>011 006</b>		
						THD,		6				* 010 013
						TW		6				* 010 022
				D 2066 LF41 <Euro 5/OBD2>; D 2066 LF58 <Euro 5/EEV/OBD2>	09.09→			6		<b>011 006</b>		
					09.09-06.13	THD		6				* 010 026
					07.13→	THD		6				* 010 037
<b>24.440</b>		10,5	324	D 2066 LF17 <Euro 5/OBD1>; D 2066 LF25 <Euro 5/OBD1>	10.07-05.11			6		<b>011 006</b>		
						THD,		6				* 010 013
						TW		6				* 010 022
				D 2066 LF40 <Euro 5/OBD2>; D 2066 LF57 <Euro 5/EEV/OBD2>	09.09→			6		<b>011 006</b>		
					09.09-06.13	THD		6				* 010 026
					07.13→	THD		6				* 010 037
<b>24.480</b>		12,4	353	D 2676 LF07 <Euro 5/OBD2>	09.09→			6		<b>011 006</b>		
					09.09-06.13	THD		6				* 010 026
					07.13→	THD		6				* 010 037
				D 2676 LF18 <Euro 5/EEV/OBD2>	09.09→			6		<b>011 006</b>		
					09.09-06.13	THD		6				* 010 026
					07.13→	THD		6				* 010 037
, DF		12,4	353	D 2676 LF14 <Euro 5/OBD1>; D 2676 LF16 <Euro 5/OBD1>	10.07-05.11			6		<b>011 006</b>		
						THD,		6				* 010 013
						TW		6				* 010 022
<b>24.540</b>		12,4	397	D 2676 LF06 <Euro 5/OBD2>	09.09→			6		<b>011 006</b>		
					09.09-06.13	THD		6				* 010 026
					07.13→	THD		6				* 010 037
<b>26.320</b>		10,5	235	D 2066 LF20 <Euro 5/OBD1>; D 2066 LF28 <Euro 5/OBD1>	10.07-05.11			6		<b>011 006</b>		
						THD,		6				* 010 013
						TW		6				* 010 022
				D 2066 LF43 <Euro 5/OBD2>; D 2066 LF60 <Euro 5/EEV/OBD2>	09.09→			6		<b>011 006</b>		
					09.09-06.13	THD		6				* 010 026
					07.13→	THD		6				* 010 037
<b>26.360</b>		10,5	265	D 2066 LF19 <Euro 5/OBD1>; D 2066 LF27 <Euro 5/OBD1>	10.07-05.11			6		<b>011 006</b>		
						THD,		6				* 010 013
						TW		6				* 010 022
				D 2066 LF42 <Euro 5/OBD2>; D 2066 LF59 <Euro 5/EEV/OBD2>	09.09→			6		<b>011 006</b>		
					09.09-06.13	THD		6				* 010 026
					07.13→	THD		6				* 010 037
WW		10,5	265	D 2066 LF42 <Euro 5/OBD2>; D 2066 LF59 <Euro 5/EEV/OBD2>	06.16→			6		<b>011 006</b>		
						THD		6				* 010 037















◀ MAN

0 444 ... 0 444 ... \*0 444 ... \*\* F 01C ... 0 986 ...

<b>26.360 WW</b>	10,5 265	D 2066 LF64 <Euro 4/OBD2>	02.11→	6	<b>011 006</b>	
			02.11-06.13 THD	6	<b>*010 027</b>	
			07.13→ THD	6	<b>*010 037</b>	
<b>26.400</b>	10,5 294	D 2066 LF18 <Euro 5/OBD1>; D 2066 LF26 <Euro 5/OBD1>	10.07-05.11	6	<b>011 006</b>	
			THD,	6	<b>*010 013</b>	
		TW	6	<b>*010 022</b>		
		D 2066 LF41 <Euro 5/OBD2>; D 2066 LF58 <Euro 5/EEV/OBD2>	09.09→	6	<b>011 006</b>	
		09.09-06.13 THD	6	<b>*010 026</b>		
		07.13→ THD	6	<b>*010 037</b>		
WW	10,5 294	D 2066 LF41 <Euro 5/OBD2>; D 2066 LF58 <Euro 5/EEV/OBD2> D 2066 LF63 <Euro 4/OBD2>	06.16→	6	<b>011 006</b>	
			THD	6	<b>*010 037</b>	
			02.11→	6	<b>011 006</b>	
<b>26.440</b>	10,5 324	D 2066 LF17 <Euro 5/OBD1>; D 2066 LF25 <Euro 5/OBD1>	10.07-05.11	6	<b>011 006</b>	
			THD,	6	<b>*010 013</b>	
		TW	6	<b>*010 022</b>		
		D 2066 LF40 <Euro 5/OBD2>; D 2066 LF44 <Euro 5/OBD2>; D 2066 LF57 <Euro 5/EEV/OBD2>	09.09→	6	<b>011 006</b>	
		09.09-06.13 THD	6	<b>*010 026</b>		
		07.13→ THD	6	<b>*010 037</b>		
WW	10,5 324	D 2066 LF40 <Euro 5/OBD2>; D 2066 LF44 <Euro 5/OBD2>; D 2066 LF57 <Euro 5/EEV/OBD2> D 2066 LF62 <Euro 4/OBD2>	06.16→	6	<b>011 006</b>	
			THD	6	<b>*010 037</b>	
			02.11→	6	<b>011 006</b>	
			02.11-06.13 THD	6	<b>*010 027</b>	
			07.13→ THD	6	<b>*010 037</b>	
			<b>26.480</b>	12,4 353	D 2676 LF07 <Euro 5/OBD2>	09.09→
09.09-06.13 THD	6	<b>*010 026</b>				
07.13→ THD	6	<b>*010 037</b>				
D 2676 LF14 <Euro 5/OBD1>; D 2676 LF16 <Euro 5/OBD1>	10.07-05.11	6			<b>011 006</b>	
	THD,	6			<b>*010 013</b>	
	TW	6			<b>*010 022</b>	
WW	12,4 353	D 2676 LF18 <Euro 5/EEV/OBD2>	09.09→	6	<b>011 006</b>	
			09.09-06.13 THD	6	<b>*010 026</b>	
			07.13→ THD	6	<b>*010 037</b>	
			D 2676 LF07 <Euro 5/OBD2>	06.16→	6	<b>011 006</b>
			THD	6	<b>*010 037</b>	
			D 2676 LF20 <Euro 4/OBD2>	02.11→	6	<b>011 006</b>
<b>26.540</b>	12,4 397	D 2676 LF06 <Euro 5/OBD2>	02.11-06.13 THD	6	<b>*010 027</b>	
			07.13→ THD	6	<b>*010 037</b>	
			09.09→	6	<b>011 006</b>	
		D 2676 LF13 <Euro 5/OBD1>; D 2676 LF15 <Euro 5/OBD1>	09.09-06.13 THD	6	<b>*010 026</b>	
			07.13→ THD	6	<b>*010 037</b>	
			10.07-05.11	6	<b>011 006</b>	
<b>28.320</b>	10,5 235	D 2066 LF43 <Euro 5/OBD2>; D 2066 LF60 <Euro 5/EEV/OBD2>	THD,	6	<b>*010 013</b>	
			TW	6	<b>*010 022</b>	
			09.09→	6	<b>011 006</b>	
	236	D 2066 LF20 <Euro 5/OBD1>; D 2066 LF28 <Euro 5/OBD1>	09.09-06.13 THD	6	<b>*010 026</b>	
			07.13→ THD	6	<b>*010 037</b>	
			09.07-05.11	6	<b>011 006</b>	
<b>28.360</b>	10,5 265	D 2066 LF19 <Euro 5/OBD1>; D 2066 LF27 <Euro 5/OBD1>	THD,	6	<b>*010 013</b>	
			TW	6	<b>*010 022</b>	
			09.09→	6	<b>011 006</b>	
		D 2066 LF42 <Euro 5/OBD2>; D 2066 LF59 <Euro 5/EEV/OBD2>	09.09-06.13 THD	6	<b>*010 026</b>	
			07.13→ THD	6	<b>*010 037</b>	
			09.07-05.11	6	<b>011 006</b>	
WW	10,5 265	D 2066 LF42 <Euro 5/OBD2>; D 2066 LF59 <Euro 5/EEV/OBD2> D 2066 LF64 <Euro 4/OBD2>	06.16→	6	<b>011 006</b>	
			THD	6	<b>*010 037</b>	
			02.11→	6	<b>011 006</b>	
			02.11-06.13 THD	6	<b>*010 027</b>	
			07.13→ THD	6	<b>*010 037</b>	
			09.07-05.11	6	<b>011 006</b>	



									<b>A</b>	<b>B</b>		
									0 444 ...	0 444 ...	*0 444 ...	**F 01C ... 0 986 ...
<b>28.400</b>		10,5	294	D 2066 LF18 <Euro 5/OBD1>; D 2066 LF26 <Euro 5/OBD1>	09.07-05.11				6	<b>011 006</b>		
									THD,	6		*010 013
									TW	6		*010 022
				D 2066 LF41 <Euro 5/OBD2>; D 2066 LF58 <Euro 5/EEV/OBD2>	09.09→				6	<b>011 006</b>		
					09.09-06.13	THD			6			*010 026
					07.13→	THD			6			*010 037
WW		10,5	294	D 2066 LF41 <Euro 5/OBD2>; D 2066 LF58 <Euro 5/EEV/OBD2>	06.16→				6	<b>011 006</b>		
									THD	6		*010 037
				D 2066 LF63 <Euro 4/OBD2>	02.11→				6	<b>011 006</b>		
					02.11-06.13	THD			6			*010 027
					07.13→	THD			6			*010 037
<b>28.440</b>		10,5	324	D 2066 LF17 <Euro 5/OBD1>; D 2066 LF25 <Euro 5/OBD1>	09.07-05.11				6	<b>011 006</b>		
									THD,	6		*010 013
									TW	6		*010 022
				D 2066 LF40 <Euro 5/OBD2>; D 2066 LF57 <Euro 5/EEV/OBD2>	09.09→				6	<b>011 006</b>		
					09.09-06.13	THD			6			*010 026
					07.13→	THD			6			*010 037
WW		10,5	324	D 2066 LF40 <Euro 5/OBD2>; D 2066 LF57 <Euro 5/EEV/OBD2>	06.16→				6	<b>011 006</b>		
									THD	6		*010 037
				D 2066 LF62 <Euro 4/OBD2>	02.11→				6	<b>011 006</b>		
					02.11-06.13	THD			6			*010 027
					07.13→	THD			6			*010 037
<b>28.480</b>		12,4	353	D 2676 LF07 <Euro 5/OBD2>	09.09→				6	<b>011 006</b>		
					09.09-06.13	THD			6			*010 026
					07.13→	THD			6			*010 037
				D 2676 LF14 <Euro 5/OBD1>; D 2676 LF16 <Euro 5/OBD1>	09.07-05.11				6	<b>011 006</b>		
									THD,	6		*010 013
									TW	6		*010 022
				D 2676 LF18 <Euro 5/EEV/OBD2>	09.09→				6	<b>011 006</b>		
					09.09-06.13	THD			6			*010 026
					07.13→	THD			6			*010 037
WW		12,4	353	D 2676 LF07 <Euro 5/OBD2>	06.16→				6	<b>011 006</b>		
									THD	6		*010 037
				D 2676 LF20 <Euro 4/OBD2>	02.11→				6	<b>011 006</b>		
					02.11-06.13	THD			6			*010 027
					07.13→	THD			6			*010 037
<b>28.540</b>		12,4	397	D 2676 LF06 <Euro 5/OBD2>	09.09→				6	<b>011 006</b>		
					09.09-06.13	THD			6			*010 026
					07.13→	THD			6			*010 037
				D 2676 LF13 <Euro 5/OBD1>; D 2676 LF15 <Euro 5/OBD1>	09.07-05.11				6	<b>011 006</b>		
									THD,	6		*010 013
									TW	6		*010 022
<b>32.320</b>		10,5	235	D 2066 LF20 <Euro 5/OBD1>; D 2066 LF28 <Euro 5/OBD1>	10.07-05.11				6	<b>011 006</b>		
									THD,	6		*010 013
									TW	6		*010 022
				D 2066 LF43 <Euro 5/OBD2>; D 2066 LF60 <Euro 5/EEV/OBD2>	09.09→				6	<b>011 006</b>		
					09.09-06.13	THD			6			*010 026
					07.13→	THD			6			*010 037
<b>32.360</b>		10,5	265	D 2066 LF19 <Euro 5/OBD1>; D 2066 LF27 <Euro 5/OBD1>	10.07-05.11				6	<b>011 006</b>		
									THD,	6		*010 013
									TW	6		*010 022
				D 2066 LF42 <Euro 5/OBD2>; D 2066 LF59 <Euro 5/EEV/OBD2>	09.09→				6	<b>011 006</b>		
					09.09-06.13	THD			6			*010 026
					07.13→	THD			6			*010 037
<b>32.400</b>		10,5	294	D 2066 LF18 <Euro 5/OBD1>; D 2066 LF26 <Euro 5/OBD1>	10.07-05.11				6	<b>011 006</b>		
									THD,	6		*010 013
									TW	6		*010 022
				D 2066 LF41 <Euro 5/OBD2>; D 2066 LF58 <Euro 5/EEV/OBD2>	09.09→				6	<b>011 006</b>		
					09.09-06.13	THD			6			*010 026
					07.13→	THD			6			*010 037
<b>32.440</b>		10,5	324	D 2066 LF17 <Euro 5/OBD1>; D 2066 LF25 <Euro 5/OBD1>	10.07-05.11				6	<b>011 006</b>		
									THD,	6		*010 013
									TW	6		*010 022















◀ MAN

0 444 ... 0 444 ... \*0 444 ...  
 \*\* F 01C ... 0 986 ...

<b>32.440</b>	10,5	324	D 2066 LF40 <Euro 5/OBD2>; D 2066 LF57 <Euro 5/EEV/OBD2>	09.09→ 09.09-06.13 THD 07.13→ THD	6 6 6	<b>011 006</b>  <b>*010 026</b> <b>*010 037</b>
<b>32.480</b>	12,4	353	D 2676 LF07 <Euro 5/OBD2>	09.09→ 09.09-06.13 THD 07.13→ THD	6 6 6	<b>011 006</b>  <b>*010 026</b> <b>*010 037</b>
			D 2676 LF14 <Euro 5/OBD1>; D 2676 LF16 <Euro 5/OBD1>	10.07-05.11 THD, TW	6 6 6	<b>011 006</b>  <b>*010 013</b> <b>*010 022</b>
			D 2676 LF18 <Euro 5/EEV/OBD2>	09.09→ 09.09-06.13 THD 07.13→ THD	6 6 6	<b>011 006</b>  <b>*010 026</b> <b>*010 037</b>
<b>33.320</b>	10,5	235	D 2066 LF20 <Euro 5/OBD1>; D 2066 LF28 <Euro 5/OBD1>	10.07-05.11 THD, TW	6 6 6	<b>011 006</b>  <b>*010 013</b> <b>*010 022</b>
			D 2066 LF43 <Euro 5/OBD2>; D 2066 LF60 <Euro 5/EEV/OBD2>	09.09→ 09.09-06.13 THD 07.13→ THD	6 6 6	<b>011 006</b>  <b>*010 026</b> <b>*010 037</b>
<b>33.360</b>	10,5	265	D 2066 LF19 <Euro 5/OBD1>; D 2066 LF27 <Euro 5/OBD1>	10.07-05.11 THD, TW	6 6 6	<b>011 006</b>  <b>*010 013</b> <b>*010 022</b>
			D 2066 LF42 <Euro 5/OBD2>; D 2066 LF59 <Euro 5/EEV/OBD2>	09.09→ 09.09-06.13 THD 07.13→ THD	6 6 6	<b>011 006</b>  <b>*010 026</b> <b>*010 037</b>
WW	10,5	265	D 2066 LF42 <Euro 5/OBD2>; D 2066 LF59 <Euro 5/EEV/OBD2> D 2066 LF64 <Euro 4/OBD2>	06.16→ THD 02.11→ 02.11-06.13 THD 07.13→ THD	6 6 6 6 6	<b>011 006</b>  <b>*010 037</b> <b>011 006</b>  <b>*010 027</b> <b>*010 037</b>
<b>33.400</b>	10,5	294	D 2066 LF18 <Euro 5/OBD1>; D 2066 LF26 <Euro 5/OBD1>	10.07-05.11 THD, TW	6 6 6	<b>011 006</b>  <b>*010 013</b> <b>*010 022</b>
			D 2066 LF41 <Euro 5/OBD2>; D 2066 LF58 <Euro 5/EEV/OBD2>	09.09→ 09.09-06.13 THD 07.13→ THD	6 6 6	<b>011 006</b>  <b>*010 026</b> <b>*010 037</b>
WW	10,5	294	D 2066 LF41 <Euro 5/OBD2>; D 2066 LF58 <Euro 5/EEV/OBD2> D 2066 LF63 <Euro 4/OBD2>	06.16→ THD 02.11→ 02.11-06.13 THD 07.13→ THD	6 6 6 6 6	<b>011 006</b>  <b>*010 037</b> <b>011 006</b>  <b>*010 027</b> <b>*010 037</b>
<b>33.440</b>	10,5	324	D 2066 LF17 <Euro 5/OBD1>; D 2066 LF25 <Euro 5/OBD1>	10.07-05.11 THD, TW	6 6 6	<b>011 006</b>  <b>*010 013</b> <b>*010 022</b>
			D 2066 LF40 <Euro 5/OBD2>; D 2066 LF57 <Euro 5/EEV/OBD2>	09.09→ 09.09-06.13 THD 07.13→ THD	6 6 6	<b>011 006</b>  <b>*010 026</b> <b>*010 037</b>
WW	10,5	324	D 2066 LF40 <Euro 5/OBD2>; D 2066 LF57 <Euro 5/EEV/OBD2> D 2066 LF62 <Euro 4/OBD2>	06.16→ THD 02.11→ 02.11-06.13 THD 07.13→ THD	6 6 6 6 6	<b>011 006</b>  <b>*010 037</b> <b>011 006</b>  <b>*010 027</b> <b>*010 037</b>
<b>33.480</b>	12,4	353	D 2676 LF07 <Euro 5/OBD2>	09.09→ 09.09-06.13 THD 07.13→ THD	6 6 6	<b>011 006</b>  <b>*010 026</b> <b>*010 037</b>
			D 2676 LF18 <Euro 5/EEV/OBD2>	09.09→ 09.09-06.13 THD 07.13→ THD	6 6 6	<b>011 006</b>  <b>*010 026</b> <b>*010 037</b>
,DF	12,4	353	D 2676 LF14 <Euro 5/OBD1>; D 2676 LF16 <Euro 5/OBD1>	10.07-05.11 THD, TW	6 6 6	<b>011 006</b>  <b>*010 013</b> <b>*010 022</b>
WW	12,4	353	D 2676 LF07 <Euro 5/OBD2>	06.16→ THD	6 6	<b>011 006</b>  <b>*010 037</b>



									<b>A</b>	<b>B</b>		
									0 444 ...	0 444 ...	*0 444 ...	**F 01C ... 0 986 ...
<b>33.480</b>	WW	12,4	353	D 2676 LF20 <Euro 4/OBD2>	02.11→		6			<b>011 006</b>		
					02.11-06.13	THD	6					*010 027
					07.13→	THD	6					*010 037
<b>33.540</b>		12,4	397	D 2676 LF06 <Euro 5/OBD2>	09.09→		6			<b>011 006</b>		
					09.09-06.13	THD	6					*010 026
					07.13→	THD	6					*010 037
				D 2676 LF13 <Euro 5/OBD1>; D 2676 LF15 <Euro 5/OBD1>	10.07-05.11		6			<b>011 006</b>		
						THD,	6					*010 013
						TW	6					*010 022
<b>35.320</b>		10,5	235	D 2066 LF20 <Euro 5/OBD1>; D 2066 LF28 <Euro 5/OBD1>	10.07-05.11		6			<b>011 006</b>		
						THD,	6					*010 013
						TW	6					*010 022
				D 2066 LF43 <Euro 5/OBD2>; D 2066 LF60 <Euro 5/EEV/OBD2>	09.09→		6			<b>011 006</b>		
					09.09-06.13	THD	6					*010 026
					07.13→	THD	6					*010 037
<b>35.360</b>		10,5	265	D 2066 LF19 <Euro 5/OBD1>; D 2066 LF27 <Euro 5/OBD1>	10.07-05.11		6			<b>011 006</b>		
						THD,	6					*010 013
						TW	6					*010 022
				D 2066 LF42 <Euro 5/OBD2>; D 2066 LF59 <Euro 5/EEV/OBD2>	09.09→		6			<b>011 006</b>		
					09.09-06.13	THD	6					*010 026
					07.13→	THD	6					*010 037
WW		10,5	265	D 2066 LF64 <Euro 4/OBD2>	02.11-12.13		6			<b>011 006</b>		
					02.11-06.13	THD	6					*010 027
					07.13-12.13	THD	6					*010 037
<b>35.400</b>		10,5	294	D 2066 LF18 <Euro 5/OBD1>; D 2066 LF26 <Euro 5/OBD1>	10.07-05.11		6			<b>011 006</b>		
						THD,	6					*010 013
						TW	6					*010 022
				D 2066 LF41 <Euro 5/OBD2>; D 2066 LF58 <Euro 5/EEV/OBD2>	09.09→		6			<b>011 006</b>		
					09.09-06.13	THD	6					*010 026
					07.13→	THD	6					*010 037
WW		10,5	294	D 2066 LF63 <Euro 4/OBD2>	02.11-12.13		6			<b>011 006</b>		
					02.11-06.13	THD	6					*010 027
					07.13-12.13	THD	6					*010 037
<b>35.440</b>		10,5	324	D 2066 LF17 <Euro 5/OBD1>; D 2066 LF25 <Euro 5/OBD1>	10.07-05.11		6			<b>011 006</b>		
						THD,	6					*010 013
						TW	6					*010 022
				D 2066 LF40 <Euro 5/OBD2>; D 2066 LF57 <Euro 5/EEV/OBD2>	09.09→		6			<b>011 006</b>		
					09.09-06.13	THD	6					*010 026
					07.13→	THD	6					*010 037
WW		10,5	324	D 2066 LF62 <Euro 4/OBD2>	02.11-12.13		6			<b>011 006</b>		
					02.11-06.13	THD	6					*010 027
					07.13-12.13	THD	6					*010 037
<b>35.480</b>		12,4	353	D 2676 LF07 <Euro 5/OBD2>	09.09→		6			<b>011 006</b>		
					09.09-06.13	THD	6					*010 026
					07.13→	THD	6					*010 037
				D 2676 LF14 <Euro 5/OBD1>; D 2676 LF16 <Euro 5/OBD1>	10.07-05.11		6			<b>011 006</b>		
						THD,	6					*010 013
						TW	6					*010 022
				D 2676 LF18 <Euro 5/EEV/OBD2>	09.09→		6			<b>011 006</b>		
					09.09-06.13	THD	6					*010 026
					07.13→	THD	6					*010 037
WW		12,4	353	D 2676 LF20 <Euro 4/OBD2>	02.11-12.13		6			<b>011 006</b>		
					02.11-06.13	THD	6					*010 027
					07.13-12.13	THD	6					*010 037
<b>35.540</b>		12,4	397	D 2676 LF06 <Euro 5/OBD2>	09.09→		6			<b>011 006</b>		
					09.09-06.13	THD	6					*010 026
					07.13→	THD	6					*010 037
				D 2676 LF13 <Euro 5/OBD1>; D 2676 LF15 <Euro 5/OBD1>	10.07-05.11		6			<b>011 006</b>		
						THD,	6					*010 013
						TW	6					*010 022
<b>37.320</b>		10,5	235	D 2066 LF20 <Euro 5/OBD1>; D 2066 LF28 <Euro 5/OBD1>	10.07-05.11		6			<b>011 006</b>		
						THD,	6					*010 013
						TW	6					*010 022

















◀ MAN

0 444 ... 0 444 ... \*0 444 ...  
 \*\* F 01C ... 0 986 ...

<b>37.320</b>	10,5	235	D 2066 LF43 <Euro 5/OBD2>; D 2066 LF60 <Euro 5/EEV/OBD2>	09.09→	6	<b>011 006</b>	
				09.09-06.13 THD	6	<b>*010 026</b>	
				07.13→ THD	6	<b>*010 037</b>	
<b>37.360</b>	10,5	265	D 2066 LF19 <Euro 5/OBD1>; D 2066 LF27 <Euro 5/OBD1>	10.07-05.11	6	<b>011 006</b>	
				THD,	6	<b>*010 013</b>	
				TW	6	<b>*010 022</b>	
				D 2066 LF42 <Euro 5/OBD2>; D 2066 LF59 <Euro 5/EEV/OBD2>	09.09→	6	<b>011 006</b>
				09.09-06.13 THD	6	<b>*010 026</b>	
				07.13→ THD	6	<b>*010 037</b>	
<b>37.400</b>	10,5	294	D 2066 LF26 <Euro 5/OBD1>	10.07-05.11	6	<b>011 006</b>	
				THD,	6	<b>*010 013</b>	
				TW	6	<b>*010 022</b>	
				D 2066 LF41 <Euro 5/OBD2>; D 2066 LF58 <Euro 5/EEV/OBD2>	09.09→	6	<b>011 006</b>
				09.09-06.13 THD	6	<b>*010 026</b>	
				07.13→ THD	6	<b>*010 037</b>	
<b>37.440</b>	10,5	324	D 2066 LF17 <Euro 5/OBD1>; D 2066 LF25 <Euro 5/OBD1>	10.07-05.11	6	<b>011 006</b>	
				THD,	6	<b>*010 013</b>	
				TW	6	<b>*010 022</b>	
				D 2066 LF40 <Euro 5/OBD2>; D 2066 LF57 <Euro 5/EEV/OBD2>	09.09→	6	<b>011 006</b>
				09.09-06.13 THD	6	<b>*010 026</b>	
				07.13→ THD	6	<b>*010 037</b>	
<b>37.480</b>	12,4	353	D 2676 LF07 <Euro 5/OBD2>	09.09→	6	<b>011 006</b>	
				09.09-06.13 THD	6	<b>*010 026</b>	
				07.13→ THD	6	<b>*010 037</b>	
				D 2676 LF14 <Euro 5/OBD1>; D 2676 LF16 <Euro 5/OBD1>	10.07-05.11	6	<b>011 006</b>
				THD,	6	<b>*010 013</b>	
				TW	6	<b>*010 022</b>	
<b>37.540</b>	12,4	397	D 2676 LF06 <Euro 5/OBD2>	09.09→	6	<b>011 006</b>	
				09.09-06.13 THD	6	<b>*010 026</b>	
				07.13→ THD	6	<b>*010 037</b>	
				D 2676 LF13 <Euro 5/OBD1>; D 2676 LF15 <Euro 5/OBD1>	10.07-05.11	6	<b>011 006</b>
				THD,	6	<b>*010 013</b>	
				TW	6	<b>*010 022</b>	
<b>40.360 WW</b>	10,5	265	D 2066 LF42 <Euro 5/OBD2>	06.16→	6	<b>011 006</b>	
				THD	6	<b>*010 037</b>	
				D 2066 LF64 <Euro 4/OBD2>	12.11→	6	<b>011 006</b>
				12.11-06.13 THD	6	<b>*010 027</b>	
				07.13→ THD	6	<b>*010 037</b>	
				<b>40.400 WW</b>	10,5	294	D 2066 LF41 <Euro 5/OBD2>
THD	6	<b>*010 037</b>					
D 2066 LF63 <Euro 4/OBD2>	12.11→	6	<b>011 006</b>				
12.11-06.13 THD	6	<b>*010 027</b>					
07.13→ THD	6	<b>*010 037</b>					
<b>40.440 WW</b>	10,5	324	D 2066 LF40 <Euro 5/OBD2>				
				THD	6	<b>*010 037</b>	
				D 2066 LF62 <Euro 4/OBD2>	12.11→	6	<b>011 006</b>
				12.11-06.13 THD	6	<b>*010 027</b>	
				07.13→ THD	6	<b>*010 037</b>	
				<b>40.480 WW</b>	12,4	353	D 2676 LF07 <Euro 5/OBD2>
THD	6	<b>*010 037</b>					
D 2676 LF20 <Euro 4/OBD2>	12.11→	6	<b>011 006</b>				
12.11-06.13 THD	6	<b>*010 027</b>					
07.13→ THD	6	<b>*010 037</b>					
<b>40.540 WW</b>	12,4	397	D 2676 LF06 <Euro 5/OBD2>; D 2676 LF19 <Euro 4/OBD2>				
				THD	6	<b>*010 037</b>	
				<b>41.320</b>	10,5	235	D 2066 LF20 <Euro 5/OBD1>; D 2066 LF28 <Euro 5/OBD1>
THD,	6	<b>*010 013</b>					
TW	6	<b>*010 022</b>					













								<b>A</b>	<b>B</b>		
								0 444 ...	0 444 ...	* 0 444 ...	** F 01C ... 0 986 ...
<b>41.320</b>	10,5	235	D 2066 LF43 <Euro 5/OBD2>; D 2066 LF60 <Euro 5/EEV/OBD2>	09.09→		6		<b>011 006</b>			
				09.09-06.13	THD	6		<b>* 010 026</b>			
				07.13→	THD	6		<b>* 010 037</b>			
<b>41.360</b>	10,5	265	D 2066 LF19 <Euro 5/OBD1>; D 2066 LF27 <Euro 5/OBD1>	10.07-05.11		6		<b>011 006</b>			
					THD,	6		<b>* 010 013</b>			
					TW	6		<b>* 010 022</b>			
				09.09→		6		<b>011 006</b>			
				09.09-06.13	THD	6		<b>* 010 026</b>			
				07.13→	THD	6		<b>* 010 037</b>			
WW	10,5	265	D 2066 LF42 <Euro 5/OBD2>; D 2066 LF59 <Euro 5/EEV/OBD2>	06.16→		6		<b>011 006</b>			
					THD	6		<b>* 010 037</b>			
				02.11→		6		<b>011 006</b>			
				02.11-06.13	THD	6		<b>* 010 027</b>			
				07.13→	THD	6		<b>* 010 037</b>			
<b>41.400</b>	10,5	294	D 2066 LF18 <Euro 5/OBD1>; D 2066 LF26 <Euro 5/OBD1>	10.07-05.11		6		<b>011 006</b>			
					THD,	6		<b>* 010 013</b>			
					TW	6		<b>* 010 022</b>			
				09.09→		6		<b>011 006</b>			
				09.09-06.13	THD	6		<b>* 010 026</b>			
				07.13→	THD	6		<b>* 010 037</b>			
WW	10,5	294	D 2066 LF41 <Euro 5/OBD2>; D 2066 LF58 <Euro 5/EEV/OBD2>	06.16→		6		<b>011 006</b>			
					THD	6		<b>* 010 037</b>			
				02.11→		6		<b>011 006</b>			
				02.11-06.13	THD	6		<b>* 010 027</b>			
				07.13→	THD	6		<b>* 010 037</b>			
<b>41.440</b>	10,5	324	D 2066 LF17 <Euro 5/OBD1>; D 2066 LF25 <Euro 5/OBD1>	10.07-05.11		6		<b>011 006</b>			
					THD,	6		<b>* 010 013</b>			
					TW	6		<b>* 010 022</b>			
				09.09→		6		<b>011 006</b>			
				09.09-06.13	THD	6		<b>* 010 026</b>			
				07.13→	THD	6		<b>* 010 037</b>			
WW	10,5	324	D 2066 LF40 <Euro 5/OBD2>; D 2066 LF57 <Euro 5/EEV/OBD2>	06.16→		6		<b>011 006</b>			
					THD	6		<b>* 010 037</b>			
				02.11→		6		<b>011 006</b>			
				02.11-06.13	THD	6		<b>* 010 027</b>			
				07.13→	THD	6		<b>* 010 037</b>			
<b>41.480</b>	12,4	353	D 2676 LF07 <Euro 5/OBD2>	09.09→		6		<b>011 006</b>			
				09.09-06.13	THD	6		<b>* 010 026</b>			
				07.13→	THD	6		<b>* 010 037</b>			
				10.07-05.11		6		<b>011 006</b>			
					THD,	6		<b>* 010 013</b>			
					TW	6		<b>* 010 022</b>			
WW	12,4	353	D 2676 LF14 <Euro 5/OBD1>; D 2676 LF16 <Euro 5/OBD1>	09.09→		6		<b>011 006</b>			
				09.09-06.13	THD	6		<b>* 010 026</b>			
				07.13→	THD	6		<b>* 010 037</b>			
				06.16→		6		<b>011 006</b>			
					THD	6		<b>* 010 037</b>			
<b>41.540</b>	12,4	397	D 2676 LF18 <Euro 5/EEV/OBD2>	09.09→		6		<b>011 006</b>			
				09.09-06.13	THD	6		<b>* 010 026</b>			
				07.13→	THD	6		<b>* 010 037</b>			
				02.11→		6		<b>011 006</b>			
				02.11-06.13	THD	6		<b>* 010 027</b>			
				07.13→	THD	6		<b>* 010 037</b>			
<b>TGX</b>	<b>18.360</b>	10,5	265	D 2676 LF06 <Euro 5/OBD2>	09.09→		6		<b>011 006</b>		
					09.09-06.13	THD	6		<b>* 010 026</b>		
					07.13→	THD	6		<b>* 010 037</b>		
					10.07-05.11		6		<b>011 006</b>		
						THD,	6		<b>* 010 013</b>		
						TW	6		<b>* 010 022</b>		
<b>18.360</b>	10,5	265	D 2066 LF19 <Euro 5/OBD1>; D 2066 LF27 <Euro 5/OBD1>	10.07-05.11		6		<b>011 006</b>			
					THD,	6		<b>* 010 013</b>			
					TW	6		<b>* 010 022</b>			
				09.09→		6		<b>011 006</b>			
				09.09-06.13	THD	6		<b>* 010 026</b>			
				07.13→	THD	6		<b>* 010 037</b>			





MAN						0 444 ...	0 444 ...	*0 444 ...	** F01C ...	0 986 ...
18.400	10,5	294	D 2066 LF18 <Euro 5/OBD1>;	10.07-05.11	6		<b>011 006</b>			
			D 2066 LF26 <Euro 5/OBD1>		THD, 6		<b>*010 013</b>			
					TW 6		<b>*010 022</b>			
			D 2066 LF41 <Euro 5/OBD2>;	09.09→	6	<b>011 006</b>				
			D 2066 LF58 <Euro 5/EEV/OBD2>	09.09-06.13	THD 6		<b>*010 026</b>			
			07.13→	THD 6		<b>*010 037</b>				
18.440	10,5	324	D 2066 LF17 <Euro 5/OBD1>;	10.07-05.11	6		<b>011 006</b>			
			D 2066 LF25 <Euro 5/OBD1>		THD, 6		<b>*010 013</b>			
					TW 6		<b>*010 022</b>			
			D 2066 LF40 <Euro 5/OBD2>;	09.09→	6	<b>011 006</b>				
			D 2066 LF57 <Euro 5/EEV/OBD2>	09.09-06.13	THD 6		<b>*010 026</b>			
			07.13→	THD 6		<b>*010 037</b>				
18.480	12,4	353	D 2676 LF07 <Euro 5/OBD2>	09.09→	6		<b>011 006</b>			
				09.09-06.13	THD 6		<b>*010 026</b>			
				07.13→	THD 6		<b>*010 037</b>			
			D 2676 LF18 <Euro 5/EEV/OBD2>	09.09→	6	<b>011 006</b>				
				09.09-06.13	THD 6		<b>*010 026</b>			
			07.13→	THD 6		<b>*010 037</b>				
, F, FL	12,4	353	D 2676 LF14 <Euro 5/OBD1>;	10.07-05.11	6		<b>011 006</b>			
			D 2676 LF16 <Euro 5/OBD1>		THD, 6		<b>*010 013</b>			
					TW 6		<b>*010 022</b>			
			D 2676 LF06 <Euro 5/OBD2>	09.09→	6	<b>011 006</b>				
				09.09-06.13	THD 6		<b>*010 026</b>			
			07.13→	THD 6		<b>*010 037</b>				
18.540	12,4	397	D 2676 LF13 <Euro 5/OBD1>;	10.07-05.11	6		<b>011 006</b>			
			D 2676 LF15 <Euro 5/OBD1>		THD, 6		<b>*010 013</b>			
					TW 6		<b>*010 022</b>			
			D 2676 LF06 <Euro 5/OBD2>	09.09→	6	<b>011 006</b>				
				09.09-06.13	THD 6		<b>*010 026</b>			
			07.13→	THD 6		<b>*010 037</b>				
18.680	16,2	500	D 2868 LF02 <Euro 5/OBD1>	01.08-05.11	8		<b>011 006</b>			
					THD 8		<b>*010 022</b>			
			D 2868 LF05 <Euro 5/EEV/OBD2>	09.09-05.14	8	<b>011 006</b>				
				09.09-06.13	THD 8		<b>*010 026</b>			
				07.13-05.14	THD 8		<b>*010 037</b>			
20.360	10,5	265	D 2066 LF42 <Euro 5/OBD2>;	07.17→	6		<b>011 006</b>			
			D 2066 LF59 <Euro 5/EEV/OBD2>		THD 6		<b>*010 037</b>			
20.400	10,5	294	D 2066 LF41 <Euro 5/OBD2>;	07.17→	6		<b>011 006</b>			
			D 2066 LF58 <Euro 5/EEV/OBD2>		THD 6		<b>*010 037</b>			
20.440	10,5	324	D 2066 LF40 <Euro 5/OBD2>;	07.17→	6		<b>011 006</b>			
			D 2066 LF57 <Euro 5/EEV/OBD2>		THD 6		<b>*010 037</b>			
20.480	12,4	353	D 2676 LF07 <Euro 5/OBD2>;	07.17→	6		<b>011 006</b>			
			D 2676 LF18 <Euro 5/EEV/OBD2>		THD 6		<b>*010 037</b>			
20.540	12,4	397	D 2676 LF06 <Euro 5/OBD2>	07.17→	6		<b>011 006</b>			
					THD 6		<b>*010 037</b>			
24.360	10,5	265	D 2066 LF19 <Euro 5/OBD1>;	10.07-05.11	6		<b>011 006</b>			
			D 2066 LF27 <Euro 5/OBD1>		THD, 6		<b>*010 013</b>			
					TW 6		<b>*010 022</b>			
			D 2066 LF42 <Euro 5/OBD2>;	09.09→	6	<b>011 006</b>				
			D 2066 LF59 <Euro 5/EEV/OBD2>	09.09-06.13	THD 6		<b>*010 026</b>			
			07.13→	THD 6		<b>*010 037</b>				
24.400	10,5	294	D 2066 LF18 <Euro 5/OBD1>;	10.07-05.11	6		<b>011 006</b>			
			D 2066 LF26 <Euro 5/OBD1>		THD, 6		<b>*010 013</b>			
					TW 6		<b>*010 022</b>			
			D 2066 LF41 <Euro 5/OBD2>;	09.09→	6	<b>011 006</b>				
			D 2066 LF58 <Euro 5/EEV/OBD2>	09.09-06.13	THD 6		<b>*010 026</b>			
			07.13→	THD 6		<b>*010 037</b>				
24.440	10,5	324	D 2066 LF17 <Euro 5/OBD1>;	10.07-05.11	6		<b>011 006</b>			
			D 2066 LF25 <Euro 5/OBD1>		THD, 6		<b>*010 013</b>			
					TW 6		<b>*010 022</b>			
			D 2066 LF40 <Euro 5/OBD2>;	09.09→	6	<b>011 006</b>				
			D 2066 LF57 <Euro 5/EEV/OBD2>	09.09-06.13	THD 6		<b>*010 026</b>			
			07.13→	THD 6		<b>*010 037</b>				
24.480	12,4	353	D 2676 LF07 <Euro 5/OBD2>	09.09→	6		<b>011 006</b>			
				09.09-06.13	THD 6		<b>*010 026</b>			
				07.13→	THD 6		<b>*010 037</b>			



									<b>A</b>	<b>B</b>		
									0 444 ...	0 444 ...	*0 444 ...	**F 01C ... 0 986 ...
<b>24.480</b>	12,4	353	D 2676 LF14 <Euro 5/OBD1>; D 2676 LF16 <Euro 5/OBD1>	10.07-05.11		6			<b>011 006</b>			
						THD,	6					*010 013
						TW	6					*010 022
			D 2676 LF18 <Euro 5/EEV/OBD2>	09.09→		6			<b>011 006</b>			
				09.09-06.13	THD	6						*010 026
				07.13→	THD	6						*010 037
<b>24.540</b>	12,4	397	D 2676 LF06 <Euro 5/OBD2>	09.09→		6			<b>011 006</b>			
				09.09-06.13	THD	6						*010 026
				07.13→	THD	6						*010 037
<b>26.360</b>	10,5	265	D 2066 LF19 <Euro 5/OBD1>; D 2066 LF27 <Euro 5/OBD1>	10.07-05.11		6			<b>011 006</b>			
						THD,	6					*010 013
						TW	6					*010 022
			D 2066 LF42 <Euro 5/OBD2>; D 2066 LF59 <Euro 5/EEV/OBD2>	09.09→		6			<b>011 006</b>			
				09.09-06.13	THD	6						*010 026
				07.13→	THD	6						*010 037
<b>26.400</b>	10,5	294	D 2066 LF18 <Euro 5/OBD1>; D 2066 LF26 <Euro 5/OBD1>	10.07-05.11		6			<b>011 006</b>			
						THD,	6					*010 013
						TW	6					*010 022
			D 2066 LF41 <Euro 5/OBD2>; D 2066 LF58 <Euro 5/EEV/OBD2>	09.09→		6			<b>011 006</b>			
				09.09-06.13	THD	6						*010 026
				07.13→	THD	6						*010 037
<b>26.440</b>	10,5	324	D 2066 LF17 <Euro 5/OBD1>; D 2066 LF25 <Euro 5/OBD1>	10.07-05.11		6			<b>011 006</b>			
						THD,	6					*010 013
						TW	6					*010 022
			D 2066 LF40 <Euro 5/OBD2>; D 2066 LF57 <Euro 5/EEV/OBD2>	09.09→		6			<b>011 006</b>			
				09.09-06.13	THD	6						*010 026
				07.13→	THD	6						*010 037
<b>26.480</b>	12,4	353	D 2676 LF07 <Euro 5/OBD2>	09.09→		6			<b>011 006</b>			
				09.09-06.13	THD	6						*010 026
				07.13→	THD	6						*010 037
			D 2676 LF14 <Euro 5/OBD1>; D 2676 LF16 <Euro 5/OBD1>	10.07-05.11		6			<b>011 006</b>			
						THD,	6					*010 013
						TW	6					*010 022
			D 2676 LF18 <Euro 5/EEV/OBD2>	09.09→		6			<b>011 006</b>			
				09.09-06.13	THD	6						*010 026
				07.13→	THD	6						*010 037
<b>26.540</b>	12,4	397	D 2676 LF06 <Euro 5/OBD2>	09.09→		6			<b>011 006</b>			
				09.09-06.13	THD	6						*010 026
				07.13→	THD	6						*010 037
			D 2676 LF13 <Euro 5/OBD1>; D 2676 LF15 <Euro 5/OBD1>	10.07-05.11		6			<b>011 006</b>			
						THD,	6					*010 013
						TW	6					*010 022
<b>28.360</b>	10,5	265	D 2066 LF19 <Euro 5/OBD1>; D 2066 LF27 <Euro 5/OBD1>	10.07-05.11		6			<b>011 006</b>			
						THD,	6					*010 013
						TW	6					*010 022
			D 2066 LF42 <Euro 5/OBD2>; D 2066 LF59 <Euro 5/EEV/OBD2>	09.09→		6			<b>011 006</b>			
				09.09-06.13	THD	6						*010 026
				07.13→	THD	6						*010 037
<b>28.400</b>	10,5	294	D 2066 LF18 <Euro 5/OBD1>; D 2066 LF26 <Euro 5/OBD1>	10.07-05.11		6			<b>011 006</b>			
						THD,	6					*010 013
						TW	6					*010 022
			D 2066 LF41 <Euro 5/OBD2>; D 2066 LF58 <Euro 5/EEV/OBD2>	09.09→		6			<b>011 006</b>			
				09.09-06.13	THD	6						*010 026
				07.13→	THD	6						*010 037
<b>28.440</b>	10,5	324	D 2066 LF17 <Euro 5/OBD1>; D 2066 LF25 <Euro 5/OBD1>	10.07-05.11		6			<b>011 006</b>			
						THD,	6					*010 013
						TW	6					*010 022
			D 2066 LF40 <Euro 5/OBD2>; D 2066 LF57 <Euro 5/EEV/OBD2>	09.09→		6			<b>011 006</b>			
				09.09-06.13	THD	6						*010 026
				07.13→	THD	6						*010 037
<b>28.480</b>	12,4	353	D 2676 LF07 <Euro 5/OBD2>	09.09→		6			<b>011 006</b>			
				09.09-06.13	THD	6						*010 026
				07.13→	THD	6						*010 037





◀ MAN

0 444 ... 0 444 ... \*0 444 ... \*\* F01C ... 0 986 ...

<b>28.480</b>	12,4	353	D 2676 LF14 <Euro 5/OBD1>	10.07-05.11	6	<b>011 006</b>
				THD,	6	<b>*010 013</b>
				TW	6	<b>*010 022</b>
			D 2676 LF18 <Euro 5/EEV/OBD2>	09.09→	6	<b>011 006</b>
				09.09-06.13 THD	6	<b>*010 026</b>
				07.13→ THD	6	<b>*010 037</b>
<b>28.540</b>	12,4	397	D 2676 LF06 <Euro 5/OBD2>	09.09→	6	<b>011 006</b>
				09.09-06.13 THD	6	<b>*010 026</b>
				07.13→ THD	6	<b>*010 037</b>
			D 2676 LF13 <Euro 5/OBD1>; D 2676 LF15 <Euro 5/OBD1>	10.07-05.11	6	<b>011 006</b>
				THD,	6	<b>*010 013</b>
				TW	6	<b>*010 022</b>
<b>33.360</b>	10,5	265	D 2066 LF19 <Euro 5/OBD1>; D 2066 LF27 <Euro 5/OBD1>	10.07-05.11	6	<b>011 006</b>
				THD,	6	<b>*010 013</b>
				TW	6	<b>*010 022</b>
			D 2066 LF42 <Euro 5/OBD2>; D 2066 LF59 <Euro 5/EEV/OBD2>	09.09→	6	<b>011 006</b>
				09.09-06.13 THD	6	<b>*010 026</b>
				07.13→ THD	6	<b>*010 037</b>
<b>33.400</b>	10,5	294	D 2066 LF18 <Euro 5/OBD1>; D 2066 LF26 <Euro 5/OBD1>	10.07-05.11	6	<b>011 006</b>
				THD,	6	<b>*010 013</b>
				TW	6	<b>*010 022</b>
			D 2066 LF41 <Euro 5/OBD2>; D 2066 LF58 <Euro 5/EEV/OBD2>	09.09→	6	<b>011 006</b>
				09.09-06.13 THD	6	<b>*010 026</b>
				07.13→ THD	6	<b>*010 037</b>
<b>33.440</b>	10,5	324	D 2066 LF17 <Euro 5/OBD1>; D 2066 LF25 <Euro 5/OBD1>	10.07-05.11	6	<b>011 006</b>
				THD,	6	<b>*010 013</b>
				TW	6	<b>*010 022</b>
			D 2066 LF40 <Euro 5/OBD2>; D 2066 LF57 <Euro 5/EEV/OBD2>	09.09→	6	<b>011 006</b>
				09.09-06.13 THD	6	<b>*010 026</b>
				07.13→ THD	6	<b>*010 037</b>
<b>33.480</b>	12,4	353	D 2676 LF07 <Euro 5/OBD2>	09.09→	6	<b>011 006</b>
				09.09-06.13 THD	6	<b>*010 026</b>
				07.13→ THD	6	<b>*010 037</b>
			D 2676 LF18 <Euro 5/EEV/OBD2>	09.09→	6	<b>011 006</b>
				09.09-06.13 THD	6	<b>*010 026</b>
				07.13→ THD	6	<b>*010 037</b>
, DF	12,4	353	D 2676 LF14 <Euro 5/OBD1>; D 2676 LF16 <Euro 5/OBD1>	10.07-05.11	6	<b>011 006</b>
				THD,	6	<b>*010 013</b>
				TW	6	<b>*010 022</b>
<b>33.540</b>	12,4	397	D 2676 LF06 <Euro 5/OBD2>	09.09→	6	<b>011 006</b>
				09.09-06.13 THD	6	<b>*010 026</b>
				07.13→ THD	6	<b>*010 037</b>
			D 2676 LF13 <Euro 5/OBD1>; D 2676 LF15 <Euro 5/OBD1>	10.07-05.11	6	<b>011 006</b>
				THD,	6	<b>*010 013</b>
				TW	6	<b>*010 022</b>
<b>33.680</b>	16,2	500	D 2868 LF02 <Euro 5/OBD1>	01.08-05.11	8	<b>011 006</b>
				THD	8	<b>*010 022</b>
			D 2868 LF05 <Euro 5/EEV/OBD2>	09.09-05.14	8	<b>011 006</b>
				09.09-06.13 THD	8	<b>*010 026</b>
				07.13-05.14 THD	8	<b>*010 037</b>
<b>35.360</b>	10,5	265	D 2066 LF19 <Euro 5/OBD1>; D 2066 LF27 <Euro 5/OBD1>	09.07-05.11	6	<b>011 006</b>
				THD,	6	<b>*010 013</b>
				TW	6	<b>*010 022</b>
			D 2066 LF42 <Euro 5/OBD2>; D 2066 LF59 <Euro 5/EEV/OBD2>	09.09→	6	<b>011 006</b>
				09.09-06.13 THD	6	<b>*010 026</b>
				07.13→ THD	6	<b>*010 037</b>
<b>35.400</b>	10,5	294	D 2066 LF18 <Euro 5/OBD1>; D 2066 LF26 <Euro 5/OBD1>	09.07-05.11	6	<b>011 006</b>
				THD,	6	<b>*010 013</b>
				TW	6	<b>*010 022</b>
			D 2066 LF41 <Euro 5/OBD2>; D 2066 LF58 <Euro 5/EEV/OBD2>	09.09→	6	<b>011 006</b>
				09.09-06.13 THD	6	<b>*010 026</b>
				07.13→ THD	6	<b>*010 037</b>



									<b>A</b>	<b>B</b>		
									0 444 ...	0 444 ...	* 0 444 ...	** F 01C ... 0 986 ...
<b>35.440</b>		10,5	324	D 2066 LF17 <Euro 5/OBD1>; D 2066 LF25 <Euro 5/OBD1>	09.07-05.11			6		<b>011 006</b>		
								THD,	6			* 010 013
								TW	6			* 010 022
				D 2066 LF40 <Euro 5/OBD2>; D 2066 LF57 <Euro 5/EEV/OBD2>	09.09→			6		<b>011 006</b>		
					09.09-06.13	THD	6					* 010 026
					07.13→	THD	6					* 010 037
<b>35.480</b>		12,4	353	D 2676 LF07 <Euro 5/OBD2>	09.09→			6		<b>011 006</b>		
					09.09-06.13	THD	6					* 010 026
					07.13→	THD	6					* 010 037
				D 2676 LF14 <Euro 5/OBD1>; D 2676 LF16 <Euro 5/OBD1>	09.07-05.11			6		<b>011 006</b>		
						THD,	6					* 010 013
						TW	6					* 010 022
				D 2676 LF18 <Euro 5/EEV/OBD2>	09.09→			6		<b>011 006</b>		
					09.09-06.13	THD	6					* 010 026
					07.13→	THD	6					* 010 037
<b>35.540</b>		12,4	397	D 2676 LF06 <Euro 5/OBD2>	09.09→			6		<b>011 006</b>		
					09.09-06.13	THD	6					* 010 026
					07.13→	THD	6					* 010 037
				D 2676 LF13 <Euro 5/OBD1>; D 2676 LF15 <Euro 5/OBD1>	09.07-05.11			6		<b>011 006</b>		
						THD,	6					* 010 013
						TW	6					* 010 022
<b>41.540</b>		12,4	397	D 2676 LF06 <Euro 5/OBD2>	09.09→			6		<b>011 006</b>		
					09.09-06.13	THD	6					* 010 026
					07.13→	THD	6					* 010 037
				D 2676 LF13 <Euro 5/OBD1>; D 2676 LF15 <Euro 5/OBD1>	10.07-05.11			6		<b>011 006</b>		
						THD,	6					* 010 013
						TW	6					* 010 022
<b>41.680</b>		16,2	500	D 2868 LF03 <Euro 5/OBD1>	01.08-05.11			8		<b>011 006</b>		
						THD	8					* 010 022
				D 2868 LF06 <Euro 5/OBD2>	09.09→			8		<b>011 006</b>		
					09.09-06.13	THD	8					* 010 026
					07.13→	THD	8					* 010 037



**MERCEDES-BENZ**

<b>Sprinter</b>												
<b>210</b> CDI [NCV3]		2,1	70	OM 651.955 D 22 LA	03.09→			4		<b>021 031</b>		** 600 268
<b>211</b> CDI [NCV3]		2,1	84-85	OM 651.955 D 22 LA	06.11→			4		<b>021 031</b>		
<b>213</b> CDI [NCV3]		2,1	95	OM 651.95...	03.09→			4		<b>021 031</b>		** 600 268
<b>214</b> CDI [NCV3]		2,1	105	OM 651.955 D 22 LA	04.16→			4		<b>021 031</b>		
<b>215</b> CDI [NCV3]		2,1	110	OM 651.955 DE 22 LA	06.11→			4		<b>021 031</b>		
<b>216</b> CDI [NCV3]		2,1	120	OM 651.95...	03.09→			4		<b>021 031</b>		** 600 268
<b>219</b> CDI [NCV3]		3,0	140	OM 642... <Euro 5>	03.09→		TW	6				** 600 194
								6				** 600 268
<b>310</b> CDI [NCV3]		2,1	70	OM 651.955 D 22 LA	03.09→			4		<b>021 031</b>		** 600 268
<b>311</b> CDI [NCV3]		2,1	84-85	OM 651.955 D 22 LA	06.11→			4		<b>021 031</b>		
<b>313</b> CDI [NCV3]		2,1	95	OM 651.95...	03.09→			4		<b>021 031</b>		** 600 268
<b>314</b> CDI [NCV3]		2,1	105	OM 651.955 D 22 LA	05.16→			4		<b>021 031</b>		
<b>315</b> CDI [NCV3]		2,1	110	OM 651.955 DE 22 LA	06.11→			4		<b>021 031</b>		
<b>316</b> CDI [NCV3]		2,1	120	OM 651.95...	03.09→			4		<b>021 031</b>		** 600 268
<b>319</b> CDI [NCV3]		3,0	140	OM 642... <Euro 5>	03.09→		TW	6				** 600 194
								6				** 600 268
<b>413</b> CDI [NCV3]		2,1	95	OM 651.95...	03.09→			4		<b>021 031</b>		** 600 268
<b>414</b> CDI [NCV3]		2,1	105	OM 651.955 D 22 LA	05.16→			4		<b>021 031</b>		
<b>416</b> CDI [NCV3]		2,1	120	OM 651.95...	03.09→			4		<b>021 031</b>		** 600 268
<b>419</b> CDI [NCV3]		3,0	140	OM 642... <Euro 5>	03.09→		TW	6				** 600 194
								6				** 600 268
<b>510</b> CDI [NCV3]		2,1	70	OM 651.955 D 22 LA	03.09→			4		<b>021 031</b>		** 600 268
<b>511</b> CDI [NCV3]		2,1	84	OM 651.955 D 22 LA	05.16→			4		<b>021 031</b>		
<b>513</b> CDI [NCV3]		2,1	95	OM 651.95...	03.09→			4		<b>021 031</b>		** 600 268
<b>514</b> CDI [NCV3]		2,1	105	OM 651.955 D 22 LA	05.16→			4		<b>021 031</b>		
<b>516</b> CDI [NCV3]		2,1	120	OM 651.95...	03.09→			4		<b>021 031</b>		** 600 268





◀ MERCEDES-BENZ

							0 444 ...	0 444 ...	* 0 444 ...	** F 01C ...	0 986 ...
<b>519 CDI [NCV3]</b>	3,0	140	OM 642... <Euro 5>	03.09→	TW	6				<b>** 600 194</b>	
						6				<b>** 600 268</b>	
<b>Vito</b>											
<b>109 CDI [447]</b>	1,6	65	622.951 <OM 622 DE 16 LA>	09.14→		4		<b>021 031</b>		<b>** 600 268</b>	
<b>111 CDI [447]</b>	1,6	84	622.951 <OM 622 DE 16 LA>	09.14→		4		<b>021 031</b>		<b>** 600 268</b>	
<b>114 CDI [447]</b>	2,1	100	OM 651.950 <OM 651 D22 LHD>	09.14→		4		<b>021 031</b>		<b>** 600 268</b>	
<b>116 CDI [447]</b>	2,1	120	OM 651.950 <OM 651 D22 LHD>	09.14→		4		<b>021 031</b>		<b>** 600 268</b>	
<b>119 CDI BlueTEC [447]</b>	2,1	140	OM 651.950 <OM 651 D22 LHD>	09.14→		4		<b>021 031</b>		<b>** 600 268</b>	

**MITSUBISHI FUSO TRUCK & BUS CO**

<b>Canter</b>											
<b>3C13; 3C13D</b>	3,0	96	4P10-HAT2 <Euro 6>	05.16→		4		<b>021 014</b>		<b>44D 320</b>	
<b>3C15; 3C15D</b>	3,0	110	4P10-HAT4 <Euro 6>	05.16→		4		<b>021 014</b>		<b>44D 320</b>	
<b>3S13</b>	3,0	96	4P10-HAT2 <Euro 6>	05.16→		4		<b>021 014</b>		<b>44D 320</b>	
<b>3S15</b>	3,0	110	4P10-HAT4 <Euro 6>	05.16→		4		<b>021 014</b>		<b>44D 320</b>	
<b>3.0 D Turbo</b>	3,0	81/96/ 110	4P10(T1); 4P10(T2); 4P10-T4 <Euro 5/EEV>	11.10→		4				<b>** 600 211</b>	
<b>6C18D, D 4x4</b>	3,0	129	4P10 OAT6 <Euro 5>; 4P10-AAT6 <Euro 6>; 4P10-T6 <Euro 5/EEV>	07.09→		4		<b>021 014</b>		<b>44D 320</b>	
<b>6C18; 6C18D</b>	3,0	129	4P10-HAT6 <Euro 6>	05.16→		4		<b>021 014</b>		<b>44D 320</b>	
<b>6S15</b>	3,0	110	4P10-HAT4 <Euro 6>	05.16→		4		<b>021 014</b>		<b>44D 320</b>	
<b>7C15D</b>	3,0	110	4P10-AAT4 <Euro 6>	08.13→		4		<b>021 014</b>		<b>44D 320</b>	
<b>7C15; 7C15D</b>	3,0	110	4P10-HAT4 <Euro 6>	05.16→		4		<b>021 014</b>		<b>44D 320</b>	
<b>7C18D</b>	3,0	129	4P10 OAT6 <Euro 5>; 4P10-AAT6 <Euro 6>; 4P10-T6 <Euro 5/EEV>	07.09→		4		<b>021 014</b>		<b>44D 320</b>	
<b>7C18; 7C18D</b>	3,0	129	4P10-HAT6 <Euro 6>	05.16→		4		<b>021 014</b>		<b>44D 320</b>	
<b>9C15</b>	3,0	110	4P10-AAT4 <Euro 6>	08.13→		4		<b>021 014</b>		<b>44D 320</b>	
<b>9C18</b>	3,0	129	4P10-AAT6 <Euro 6>; 4P10-HAT6 <Euro 6>	08.13→		4		<b>021 014</b>		<b>44D 320</b>	



**NISSAN**

<b>Cabstar NT400</b>											
<b>3.0 DDTI [F24]</b>	3,0	96/110	ZD30DDTI	11.16→		4		<b>043 047</b>		<b>* 042 068</b>	
<b>NT500</b>											
<b>35.15 [G40M]</b>	3,0	110	ZD30VNT	12.13→		4		<b>043 047</b>		<b>* 042 068</b>	
<b>56.15 [G40M]</b>	3,0	110	ZD30VNT	12.13→		4		<b>043 047</b>		<b>* 042 068</b>	
<b>65.15 [G40M]</b>	3,0	110	ZD30VNT	12.13→		4		<b>043 047</b>		<b>* 042 068</b>	
<b>75.18 [G40M]</b>	3,0	130	ZD30TT	01.14→		4		<b>043 047</b>		<b>* 042 068</b>	

**OPEL**

<b>Vivaro</b>											
<b>1.6 CDTI, CDTI BiTurbo [B]</b>	1,6	66/70/85/ 88/92/ 103/107	R9M	10.14→		4		<b>021 045</b>			

**RENAULT**

<b>C</b>											
<b>380 10.8</b>	10,8	279	DTi 11 <Euro 6>	06.13→	TW	6		<b>023 065</b>			
<b>430 10.8</b>	10,8	316	DTi 11 <Euro 6>	06.13→	TW	6		<b>023 065</b>			
<b>440 12.8</b>	12,8	324	DTi 13 <Euro 6>	06.13→	TW	6		<b>023 067</b>			
<b>460 10.8</b>	10,8	338	DTi 11 <Euro 6>	06.13→	TW	6		<b>023 065</b>			
<b>480 12.8</b>	12,8	353	DTi 13 <Euro 6>	06.13→	TW	6		<b>023 067</b>			
<b>520 12.8</b>	12,8	382	DTi 13 <Euro 6>	06.13→	TW	6		<b>023 067</b>			
<b>D</b>											
<b>380 10.8</b>	10,8	280	DTi 11 <Euro 6>	12.15→	TW	6		<b>023 065</b>			



							0 444 ...	0 444 ...	*0 444 ...	**F 01C ...	0 986 ...
<b>430</b>	10.8	10,8	316	DTi 11 <Euro 6>	12.15→	TW	6	<b>023 065</b>			
<b>K</b>											
<b>380</b>	10.8	10,8	279	DTi 11 <Euro 6>	06.13→	TW	6	<b>023 065</b>			
<b>430</b>	10.8	10,8	316	DTi 11 <Euro 6>	06.13→	TW	6	<b>023 065</b>			
<b>440</b>	12.8	12,8	324	DTi 13 <Euro 6>	06.13→	TW	6	<b>023 065</b>			
<b>460</b>	10.8	10,8	338	DTi 11 <Euro 6>	06.13→	TW	6	<b>023 065</b>			
<b>480</b>	12.8	12,8	353	DTi 13 <Euro 6>	06.13→	TW	6	<b>023 065</b>			
<b>520</b>	12.8	12,8	382	DTi 13 <Euro 6>	06.13→	TW	6	<b>023 065</b>			
<b>Kerax</b>											
<b>370</b>	10.8	10,8	272	DXi 11 370 <Euro 4>; DXi 11 370 <Euro 5>	05.06-08.08		6	<b>023 017</b>			
					09.08-03.09		6	<b>023 049</b>			
						VBS	6		<b>* 022 059</b>	<b>44D 110</b>	
					05.06-08.08	VTF	6		<b>* 022 039</b>	<b>44D 103</b>	
<b>380</b>	10.8	10,8	280	DXi 11 380 <Euro 5>	04.09-09.11		6	<b>023 049</b>			
						VBS	6		<b>* 022 059</b>	<b>44D 110</b>	
					10.11-12.14	VBS	6		<b>* 022 059</b>	<b>44D 110</b>	
<b>410</b>	10.8	10,8	302	DXi 11 410 <Euro 4>; DXi 11 410 <Euro 5>	05.06-08.08		6	<b>023 017</b>			
					09.08-03.09		6	<b>023 049</b>			
						VBS	6		<b>* 022 059</b>	<b>44D 110</b>	
					05.06-08.08	VTF	6		<b>* 022 039</b>	<b>44D 103</b>	
<b>430</b>	10.8	10,8	316	DXi 11 430 <Euro 5>	04.09-09.11		6	<b>023 049</b>			
						VBS	6		<b>* 022 059</b>	<b>44D 110</b>	
					10.11-12.14	VBS	6		<b>* 022 059</b>	<b>44D 110</b>	
<b>450</b>	10.8	10,8	331	DXi 11 450 <Euro 4>; DXi 11 450 <Euro 5>	05.06-08.08		6	<b>023 017</b>			
					09.08-03.09		6	<b>023 049</b>			
						VBS	6		<b>* 022 059</b>	<b>44D 110</b>	
					05.06-08.08	VTF	6		<b>* 022 039</b>	<b>44D 103</b>	
<b>460</b>	10.8	10,8	339	DXi 11 460 <Euro 5>	04.09-09.11		6	<b>023 049</b>			
						VBS	6		<b>* 022 059</b>	<b>44D 110</b>	
					10.11-12.14	VBS	6		<b>* 022 059</b>	<b>44D 110</b>	
		12,8	339	DXi 13 460 <Euro 4>	03.08-08.08		6	<b>023 018</b>			
					09.08-03.09		6	<b>023 053</b>			
						VBS	6		<b>* 022 059</b>	<b>44D 110</b>	
					03.08-08.08	VTF	6		<b>* 022 039</b>	<b>44D 103</b>	
<b>480</b>	12.8	12,8	353	DXi 13 480 <Euro 5>	04.09-12.14		6	<b>023 053</b>			
						VBS	6		<b>* 022 059</b>	<b>44D 110</b>	
<b>500</b>	12.8	12,8	369	DXi 13 500 <Euro 4>	03.08-08.08		6	<b>023 018</b>			
					09.08-03.09		6	<b>023 053</b>			
						VBS	6		<b>* 022 059</b>	<b>44D 110</b>	
					03.08-08.08	VTF	6		<b>* 022 039</b>	<b>44D 103</b>	
<b>520</b>	12.8	12,8	383	DXi 13 520 <Euro 5>	04.09-12.14		6	<b>023 053</b>			
						VBS	6		<b>* 022 059</b>	<b>44D 110</b>	
<b>Magnum</b>											
<b>440</b>	12.8	12,8	323	DXi 13 440 <Euro 5>	04.09-12.14		6	<b>023 053</b>			
						VBS	6		<b>* 022 059</b>	<b>44D 110</b>	
<b>460 E. TECH</b>	12.8	12,8	339	DXi 13 460 <2001/72B1, Euro 4>; DXi 13 460 <2001/72B2, Euro 5>	05.06-08.08		6	<b>023 018</b>			
					09.08-03.09		6	<b>023 053</b>			
						VBS	6		<b>* 022 059</b>	<b>44D 110</b>	
					05.06-08.08	VTF	6		<b>* 022 039</b>	<b>44D 103</b>	
<b>480</b>	12.8	12,8	353	DXi 13 480 <Euro 5>	04.09-12.14		6	<b>023 053</b>			
						VBS	6		<b>* 022 059</b>	<b>44D 110</b>	
<b>500 E. TECH, E.TECH</b>	12.8	12,8	368	DXi 13 500 <2001/72B1, Euro 4>; DXi 13 500 <2001/72B2, Euro 5>	05.06-08.08		6	<b>023 018</b>			
					09.08-03.09		6	<b>023 053</b>			
						VBS	6		<b>* 022 059</b>	<b>44D 110</b>	
					05.06-08.08	VTF	6		<b>* 022 039</b>	<b>44D 103</b>	
<b>520</b>	12.8	12,8	382	DXi 13 520 <Euro 5>	04.09-12.14		6	<b>023 053</b>			
						VBS	6		<b>* 022 059</b>	<b>44D 110</b>	
<b>Master III</b>											
<b>2.3 dCi</b>	2,3	74-92	M9T 670 <120BU/BV>	02.10-12.15			4		<b>** 600 343</b>		
		92/107	M9T...; M9T 6... <120CG/CH/CK>	02.10→			4		<b>** 600 343</b>		
dCi 100 FWD, dCi 100 RWD, dCi 110, dCi 125 RWD, dCi 150 FWD, dCi 150 RWD	2,3	74/81/92/110	M9T 870; M9T 880; M9T 890; M9T 898	10.12→			4		<b>** 600 343</b>		





◀ RENAULT

						0 444 ...	0 444 ...	* 0 444 ...	** F 01C ...	0 986 ...
<b>2.3</b>	dCi 110	2,3	81	M9T 704	07.16→	4	<b>021 045</b>	<b>** 600 343</b>		
	dCi 135, dCi 145, dCi 165, dCi 170	2,3	96-100/107/120/125	M9T 7...	05.14→	4	<b>021 045</b>	<b>** 600 343</b>		

**Midlum II**

<b>160</b>		4,8	118	DXi 5 160 <Euro 3/4>	05.06-08.08	4	<b>023 016</b>			
					09.08-03.09	4	<b>023 043</b>			
						VBS	4	<b>*022 059</b>	<b>44D 110</b>	
					05.06-08.08	VTF	4	<b>*022 039</b>	<b>44D 103</b>	
<b>180</b>		4,8	132	DXi 5 180 <Euro 5>	04.09-12.14	4	<b>023 056</b>			
						VBS	4	<b>*022 059</b>	<b>44D 110</b>	
<b>190</b>		4,8	140	DXi 5 190 <Euro 3/4>	05.06-08.08	4	<b>023 016</b>			
					09.08-03.09	4	<b>023 043</b>			
						VBS	4	<b>*022 059</b>	<b>44D 110</b>	
					05.06-08.08	VTF	4	<b>*022 039</b>	<b>44D 103</b>	
<b>220</b>		4,8	158	DXi 5 220 <Euro 3/4>	05.06-08.08	4	<b>023 016</b>			
					09.08-03.09	4	<b>023 043</b>			
						VBS	4	<b>*022 059</b>	<b>44D 110</b>	
					05.06-08.08	VTF	4	<b>*022 039</b>	<b>44D 103</b>	
				DXi 5 220 <Euro 5>	03.07-12.14	4	<b>023 056</b>			
					09.08-12.14	VBS	4	<b>*022 059</b>	<b>44D 110</b>	
					03.07-08.08	VTF	4	<b>*022 039</b>	<b>44D 103</b>	
			162	DXi 5 220 <Euro 5>	04.09-12.14	4	<b>023 056</b>			
						VBS	4	<b>*022 059</b>	<b>44D 110</b>	
<b>240</b>		7,2	177	DXi 7 240 <Euro 3/4>	05.06-08.08	6	<b>023 016</b>			
					09.08-03.09	6	<b>023 043</b>			
						VBS	6	<b>*022 059</b>	<b>44D 110</b>	
					05.06-08.08	VTF	6	<b>*022 039</b>	<b>44D 103</b>	
<b>270</b>		7,2	199	DXi 7 270 <Euro 5>	04.09-12.14	6	<b>023 056</b>			
						VBS	6	<b>*022 059</b>	<b>44D 110</b>	
<b>280</b>		7,2	206	DXi 7 280 <Euro 3/4>	05.06-08.08	6	<b>023 016</b>			
					09.08-03.09	6	<b>023 043</b>			
						VBS	6	<b>*022 059</b>	<b>44D 110</b>	
					05.06-08.08	VTF	6	<b>*022 039</b>	<b>44D 103</b>	
				DXi 7 280 <Euro 5>	03.07-03.09	6	<b>023 056</b>			
					09.08-03.09	VBS	6	<b>*022 059</b>	<b>44D 110</b>	
					03.07-08.08	VTF	6	<b>*022 039</b>	<b>44D 103</b>	
<b>300</b>		7,2	221	DXi 7 300 <Euro 5>	04.09-12.14	6	<b>023 056</b>			
						VBS	6	<b>*022 059</b>	<b>44D 110</b>	

**Premium II**

<b>240</b>	Distribution	7,2	177	DXi 7 240 <122CX, Euro 4>	06.06-03.09	6	<b>023 016</b>			
					09.08-03.09	VBS	6	<b>*022 059</b>	<b>44D 110</b>	
					06.06-08.08	VTF	6	<b>*022 039</b>	<b>44D 103</b>	
<b>270</b>	Distribution, Lander	7,2	199	DXi 7 270 <Euro 5>	04.09-12.14	6	<b>023 056</b>			
						VBS	6	<b>*022 059</b>	<b>44D 110</b>	
<b>280</b>	Distribution, Lander	7,2	206	DXi 7 280 <Euro 5>	03.07-03.09	6	<b>023 056</b>			
					09.08-03.09	VBS	6	<b>*022 059</b>	<b>44D 110</b>	
					03.07-08.08	VTF	6	<b>*022 039</b>	<b>44D 103</b>	
				DXi 7 280 <122CW, Euro 4>	06.06-03.09	6	<b>023 016</b>			
					09.08-03.09	VBS	6	<b>*022 059</b>	<b>44D 110</b>	
					06.06-08.08	VTF	6	<b>*022 039</b>	<b>44D 103</b>	
<b>310</b>	Distribution, Lander	7,2	228	DXi 7 310 <Euro 5>	04.09-12.14	6	<b>023 056</b>			
						VBS	6	<b>*022 059</b>	<b>44D 110</b>	
<b>320</b>	Distribution, Lander	7,2	235	DXi 7 320 <Euro 5>	03.07-03.09	6	<b>023 056</b>			
					09.08-03.09	VBS	6	<b>*022 059</b>	<b>44D 110</b>	
					03.07-08.08	VTF	6	<b>*022 039</b>	<b>44D 103</b>	
				DXi 7 320 <122CY, Euro 4>	05.06-03.09	6	<b>023 016</b>			
					09.08-03.09	VBS	6	<b>*022 059</b>	<b>44D 110</b>	
					05.06-08.08	VTF	6	<b>*022 039</b>	<b>44D 103</b>	
<b>340</b>	Distribution, Lander	7,2	250	DXi 7 340 <Euro 5>	04.09-12.14	6	<b>023 056</b>			
						VBS	6	<b>*022 059</b>	<b>44D 110</b>	





							0 444 ...	0 444 ...	* 0 444 ...	** F 01C ...	0 986 ...
<b>370</b> Distribution, Lander, Route	10,8	272	DXi 11 370 <Euro 5>; DXi 11 370 <2001/72B1 Euro 4>; DXi 11 370 <2001/72B2 Euro 5>	05.06-08.08	6			<b>023 017</b>			
				09.08-03.09	6		<b>023 049</b>				
				VBS	6			<b>* 022 059</b>	<b>44D 110</b>		
				05.06-08.08	VTF	6		<b>* 022 039</b>	<b>44D 103</b>		
<b>380</b> Distribution	10,8	280	DXi 11 380 <Euro 5>	04.09-09.11	6		<b>023 049</b>				
				VBS	6			<b>* 022 059</b>	<b>44D 110</b>		
				10.11-12.14	VBS	6		<b>* 022 059</b>	<b>44D 110</b>		
				Lander	10,8	280	DXi 11 380 <Euro 5>	04.09-09.11	6		<b>023 049</b>
VBS	6							<b>* 022 059</b>	<b>44D 110</b>		
10.11-12.14	VBS	6						<b>* 022 059</b>	<b>44D 110</b>		
Route	10,8	280	DXi 11 380 <Euro 5/ EEV>	04.09-09.11	6		<b>023 049</b>				
				VBS	6			<b>* 022 059</b>	<b>44D 110</b>		
				10.11-12.14	VBS	6		<b>* 022 059</b>	<b>44D 110</b>		
<b>410</b> Distribution, Lander, Route	10,8	302	DXi 11 410 <2001/72B1 Euro 4>; DXi 11 410 <2001/72B2 Euro 5>	05.06-08.08	6		<b>023 017</b>				
				09.08-03.09	6		<b>023 049</b>				
				VBS	6			<b>* 022 059</b>	<b>44D 110</b>		
				05.06-08.08	VTF	6		<b>* 022 039</b>	<b>44D 103</b>		
<b>430</b> Distribution	10,8	316	DXi 11 430 <Euro 5>	04.09-09.11	6		<b>023 049</b>				
				VBS	6			<b>* 022 059</b>	<b>44D 110</b>		
				10.11-12.14	VBS	6		<b>* 022 059</b>	<b>44D 110</b>		
				Lander	10,8	316	DXi 11 430 <Euro 5>	04.09-09.11	6		<b>023 049</b>
VBS	6							<b>* 022 059</b>	<b>44D 110</b>		
10.11-12.14	VBS	6						<b>* 022 059</b>	<b>44D 110</b>		
Route	10,8	316	DXi 11 430 <Euro 5/ EEV>	04.09-09.11	6		<b>023 049</b>				
				VBS	6			<b>* 022 059</b>	<b>44D 110</b>		
				10.11-12.14	VBS	6		<b>* 022 059</b>	<b>44D 110</b>		
<b>450</b> Distribution, Lander, Route	10,8	331	DXi 11 450 <Euro 5>; DXi 11 450 <2001/72B1 Euro 4>; DXi 11 450 <2001/72B2 Euro 5>	05.06-08.08	6		<b>023 017</b>				
				09.08-03.09	6		<b>023 049</b>				
				VBS	6			<b>* 022 059</b>	<b>44D 110</b>		
				05.06-08.08	VTF	6		<b>* 022 039</b>	<b>44D 103</b>		
<b>460</b> Distribution	10,8	339	DXi 11 460 <Euro 5>	04.09-09.11	6		<b>023 049</b>				
				VBS	6			<b>* 022 059</b>	<b>44D 110</b>		
				10.11-12.14	VBS	6		<b>* 022 059</b>	<b>44D 110</b>		
				Lander	10,8	339	DXi 11 460 <Euro 5>	04.09-09.11	6		<b>023 049</b>
VBS	6							<b>* 022 059</b>	<b>44D 110</b>		
10.11-12.14	VBS	6						<b>* 022 059</b>	<b>44D 110</b>		
Route	10,8	339	DXi 11 460 <Euro 5/ EEV>	04.09-09.11	6		<b>023 049</b>				
				VBS	6			<b>* 022 059</b>	<b>44D 110</b>		
				10.11-12.14	VBS	6		<b>* 022 059</b>	<b>44D 110</b>		
<b>T</b>											
<b>380</b>	10,8	10,8	279	DTi 11 <Euro 6>	06.13→	TW	6		<b>023 065</b>		
<b>430</b>	10,8	10,8	316	DTi 11 <Euro 6>	06.13→	TW	6		<b>023 065</b>		
<b>440</b>	12,8	12,8	324	DTi 13 <Euro 6>	06.13→	TW	6		<b>023 067</b>		
<b>460</b>	10,8	10,8	338	DTi 11 <Euro 6>	06.13→	TW	6		<b>023 065</b>		
<b>480</b>	12,8	12,8	353	DTi 13 <Euro 6>	06.13→	TW	6		<b>023 067</b>		
<b>520</b>	12,8	12,8	382	DTi 13 <Euro 6>	06.13→	TW	6		<b>023 067</b>		
<b>Traffic III</b>											
<b>1.6</b> dCi [EG/FG/JG]	1,6	70	R9M 413		08.15→		4		<b>021 045</b>	<b>** 600 343</b>	

SCANIA

<b>G</b>											
<b>230</b>	8,9	169	DC 9.16 <Euro 4>	09.07→	THD	5			<b>* 010 038</b>		
					TW	5		<b>011 016</b>			
						5		<b>011 026</b>			
	9,3	169	DC 9.30 <Euro 5/ EEV>; DC 9.35 <Euro 5>; DC 9.39 <Euro 5>	09.07→	THD	5			<b>* 010 034</b>		
					TW	5		<b>011 016</b>			
						5		<b>011 026</b>			
<b>250</b>	9,3	184	DC09 111 250 <Euro 6>	10.12→	THD	5			<b>* 010 038</b>		
					TW	5		<b>011 016</b>			
						5		<b>011 026</b>			





SCANIA							0 444 ...	0 444 ...	* 0 444 ...	** F 01C ...	0 986 ...	
270	8,9	198	DC 9.17 <Euro 4>	09.07→	THD	5					<b>* 010 038</b>	
					TW	5			<b>011 016</b>			
						5			<b>011 026</b>			
280	9,3	206	DC 9.29 <Euro 5 / EEV>; DC 9.36 <Euro 5>; DC 9.38 <Euro 5>	09.07→	THD	5					<b>* 010 034</b>	
					TW	5			<b>011 016</b>			
						5			<b>011 026</b>			
			DC09 113 280 <Euro 6>	10.12→	THD	5						<b>* 010 038</b>
					TW	5			<b>011 016</b>			
						5			<b>011 026</b>			
DC09 130 280 <Euro 6>	09.17→	TW	5			<b>011 016</b>						
310	8,9	228	DC 9.18 <Euro 4>	09.07→	THD	5					<b>* 010 038</b>	
					TW	5			<b>011 016</b>			
						5			<b>011 026</b>			
320	9,3	235	DC 9.22 <Euro 5>; DC 9.28 <Euro 5 / EEV>; DC 9.32 <Euro 5/EEV>; DC 9.37 <Euro 5>	09.07→	THD	5					<b>* 010 034</b>	
					TW	5			<b>011 016</b>			
						5			<b>011 026</b>			
		236	DC09 108 320 <Euro 6>	03.13→	THD	5					<b>* 010 038</b>	
					TW	5			<b>011 016</b>			
						5			<b>011 026</b>			
DC09 126 320 <EURO 6>	09.17→	TW	5			<b>011 016</b>						
340	10,6	250	DC 11.08 <Euro 3>	09.07→	THD	6					<b>* 010 038</b>	
					TW	6			<b>011 016</b>			
						6			<b>011 026</b>			
	12,0	250	DC 12.10 <Euro 4>	09.07→	THD	6					<b>* 010 038</b>	
					TW	6			<b>011 016</b>			
						6			<b>011 026</b>			
360	9,3	265	DC09 112 360 <Euro 6>	03.13→	THD	5					<b>* 010 038</b>	
					TW	5			<b>011 016</b>			
						5			<b>011 026</b>			
			DC09 127 360 <EURO 6>	09.17→	TW	5			<b>011 016</b>			
					DC09 134 360 <Euro 6>	03.16→	THD	5				<b>* 010 038</b>
							TW	5			<b>011 016</b>	
	5			<b>011 026</b>								
13,0	265	DC 13.06 <Euro 5>	09.08→	THD	6					<b>* 010 038</b>		
				TW	6			<b>011 016</b>				
					6			<b>011 026</b>				
370	12,7	272	DC13 116 370	11.13→		6					<b>* 010 038</b>	
					THD,TW	6			<b>011 016</b>			
					DC13 149 370 <EURO 6>	09.17→	TW	6			<b>011 016</b>	
380	11,0	280	DC 11.09 <Euro 3>	09.07→	THD	6					<b>* 010 038</b>	
					TW	6			<b>011 016</b>			
						6			<b>011 026</b>			
	11,7	280	DC 12.13 <Euro 4>	09.07→	THD	6					<b>* 010 038</b>	
					TW	6			<b>011 016</b>			
						6			<b>011 026</b>			
DC 12.18 <Euro 5>	09.07→		6			<b>011 016</b>						
		THD	6				<b>* 010 034</b>					
		12,0	280	DC 12.17 <Euro 3>	09.08→	THD	6					<b>* 010 038</b>
TW	6							<b>011 016</b>				
	6							<b>011 026</b>				
400	12,7	294	DC 13.05 <Euro 5>	09.08→	THD	6					<b>* 010 038</b>	
					TW	6			<b>011 016</b>			
						6			<b>011 026</b>			
410	12,7	302	DC13 107 <Euro 3>	10.11→	THD	6					<b>* 010 038</b>	
					TW	6			<b>011 016</b>			
						6			<b>011 026</b>			
			DC13 115 410 <Euro 6>	03.13→		6			<b>011 016</b>			
					THD,TW	6				<b>* 010 038</b>		
					DC13 141 410 <Euro 6>	09.17→	TW	6			<b>011 016</b>	
420	11,7	309	DC 12.22 <Euro 5/EEV>	09.07→		6					<b>011 016</b>	
					THD	6				<b>* 010 034</b>		









◀ SCANIA						0 444 ...	0 444 ...	* 0 444 ...	** F 01C ...	0 986 ...
320	9,3	236	DC09 108 320 <Euro 6>	03.13→	THD	5				<b>*010 038</b>
					TW	5			<b>011 016</b>	
						5			<b>011 026</b>	
					DC09 126 320 <EURO 6>	09.17→	TW	5		<b>011 016</b>
340	10,6	250	DC 11.08 <Euro 3>	09.04→	THD	6			<b>*010 038</b>	
					TW	6			<b>011 016</b>	
						6			<b>011 026</b>	
					DC09 133 320 <Euro 6>	03.16→	THD	5		<b>*010 038</b>
360	9,3	265	DC09 112 360 <Euro 6>	03.13→	THD	5			<b>*010 038</b>	
					TW	5			<b>011 016</b>	
						5			<b>011 026</b>	
					DC09 127 360 <EURO 6>	09.17→	TW	5		<b>011 016</b>
370	12,7	272	DC13 116 370	11.13→	THD	5			<b>*010 038</b>	
					TW	5			<b>011 016</b>	
						5			<b>011 026</b>	
					DC09 134 360 <Euro 6>	03.16→	THD	5		<b>*010 038</b>
380	11,0	280	DC 11.09 <Euro 3>	09.04→	THD	6			<b>*010 038</b>	
					TW	6			<b>011 016</b>	
						6			<b>011 026</b>	
					DC13 149 370 <EURO 6>	09.17→	TW	6		<b>011 016</b>
400	12,7	294	DC 12.13 <Euro 4>	09.05→	THD	6			<b>*010 038</b>	
					TW	6			<b>011 016</b>	
						6			<b>011 026</b>	
					DC 12.18 <Euro 5>	09.06→	THD	6		<b>*010 034</b>
410	12,7	302	DC 12.17 <Euro 3>	09.07→	THD	6			<b>*010 038</b>	
					TW	6			<b>011 016</b>	
						6			<b>011 026</b>	
					DC 13.05 <Euro 5>	09.07→	THD	6		<b>*010 038</b>
420	11,7	309	DC 13.05 <Euro 5>	09.07→	THD	6			<b>*010 034</b>	
					TW	6			<b>011 016</b>	
						6			<b>011 026</b>	
					DC 12.12 <Euro 3>	09.04→	THD	6		<b>*010 038</b>
450	12,7	331	DC 12.15 <Euro 5>	02.06→	THD	6			<b>*010 034</b>	
					TW	6			<b>011 016</b>	
						6			<b>011 026</b>	
					DC 12.22 <Euro 5/EEV>	09.07→	THD	6		<b>*010 034</b>
470	12,0	346	DT 12.12 <Euro 4>	09.04→	THD	6			<b>*010 038</b>	
					TW	6			<b>011 016</b>	
						6			<b>011 026</b>	
					DC13 124 450 <Euro 6>	03.13→	THD	6		<b>*010 038</b>
480	12,0	346	DC13 148 450 <Euro 6>; DC13 155 500 <Euro 6>	09.17→	TW	6			<b>011 016</b>	
					THD	6			<b>*010 038</b>	
					TW	6			<b>011 016</b>	
						6			<b>011 026</b>	





							0 444 ...	0 444 ...	*0 444 ...	**F 01C ...	0 986 ...
480	12,0	353	DT 12.17 <Euro 4>	09.06→	THD	6			*010 038		
					TW	6		011 016			
						6		011 026			
<b>R</b>											
230	8,9	169	DC 9.16 <Euro 4>	09.05→	THD	5			*010 038		
					TW	5		011 016			
						5		011 026			
270	8,9	198	DC 9.17 <Euro 4>	09.05→	THD	5			*010 038		
					TW	5		011 016			
						5		011 026			
280	9,3	206	DC09 130 280 <Euro 6>	09.17→	TW	5		011 016			
310	8,9	228	DC 9.18 <Euro 4>	09.05→	THD	5			*010 038		
					TW	5		011 016			
						5		011 026			
320	9,3	236	DC09 126 320 <EURO 6>	09.17→	TW	5		011 016			
340	10,6	250	DC 11.08 <Euro 3>	03.04→	THD	6			*010 038		
					TW	6		011 016			
		6		011 026							
		12,0	250	DC 12.10 <Euro 4>	09.05→		6		011 016		
360	9,3	265	DC09 127 360 <EURO 6>	09.17→	THD	6			*010 034		
					TW	5		011 016			
						5		011 026			
	13,0	265	DC 13.06 <Euro 5>	09.07→	THD	6			*010 038		
					TW	6		011 016			
						6		011 026			
370	12,7	272	DC13 116 370	11.13→		6			*010 038		
					THD,TW	6		011 016			
						6		011 026			
380	11,0	280	DC 11.09 <Euro 3>	03.04→	TW	6			*010 038		
					THD	6		011 016			
						6		011 026			
	11,7	280	DC 12.13 <Euro 4>; DC 12.18 <Euro 5>	09.05→		6			*010 034		
					THD	6		011 016			
						6		011 026			
400	12,7	294	DC 13.05 <Euro 5>	09.07→	THD	6			*010 038		
					TW	6		011 016			
						6		011 026			
410	12,7	302	DC13 107 <Euro 3>	10.11→	THD	6			*010 038		
					TW	6		011 016			
						6		011 026			
						6		011 016			
					THD,TW	6		011 016			
420	11,7	309	DC 12.22 <Euro 5/EEV>	09.07→	TW	6			*010 038		
					THD	6		011 016			
						6		011 026			
						6		011 016			
					THD	6		011 016			
	12,0	309	DC 12.06 <Euro 3>	09.07→	THD	6			*010 038		
					TW	6		011 016			
						6		011 026			
						6		011 016			
					THD	6		011 016			
			DC 12.15 <Euro 5>	02.06→		6			*010 034		
					THD	6		011 016			
						6		011 026			
						6		011 016			
					THD	6		011 016			
			DT 12.11 <Euro 4>; DT 12.12 <Euro 4>	09.04→	THD	6			*010 038		
					TW	6		011 016			
						6		011 026			
						6		011 016			
					THD	6		011 016			
440	12,0	324	DT 12.18 <Euro 3>	09.07→	THD	6			*010 038		
					TW	6		011 016			
						6		011 026			
	12,7	324	DC 13.10 <Euro 5>; DC13 109 440 <Euro 6>	09.07→	THD	6			*010 038		
					TW	6		011 016			
						6		011 026			
450	12,7	331	DC13 124 450 <Euro 6>; DC13 147 450 <Euro 6>	03.13→	THD	6			*010 038		
					TW	6		011 016			
						6		011 026			
			DC13 148 450 <Euro 6>	08.16→	TW	6		011 016			





◀ SCANIA 0 444 ... 0 444 ... \*0 444 ... \*\* F01C ... 0 986 ...

470	12,0	346	DT 12.03 <Euro 4>; DT 12.06 <Euro 3>	04.04 →	THD	6	<b>*010 038</b>						
					TW	6		<b>011 016</b>					
						6		<b>011 026</b>					
480	12,0	353	DT 12.17 <Euro 4>	09.06 →	THD	6	<b>*010 038</b>						
					TW	6		<b>011 016</b>					
						6		<b>011 026</b>					
	12,7	353	DC13 110 480 <Euro 6>	10.12 →	THD	6	<b>*010 038</b>						
					TW	6		<b>011 016</b>					
						6		<b>011 026</b>					
13,0	353	DC 13.07 <Euro 5>	09.07 →	THD	6	<b>*010 038</b>							
				TW	6		<b>011 016</b>						
					6		<b>011 026</b>						
490	12,7	361	DC13 125 490 <Euro 6>	03.13 →	THD	6	<b>*010 038</b>						
					TW	6		<b>011 016</b>					
						6		<b>011 026</b>					
500	12,7	368	DC13 155 500 <Euro 6>	08.16 →	TW	6	<b>011 016</b>						
					15,6	368		DC 16.04 <Euro 3>	03.04 →	THD	8	<b>*010 038</b>	
										TW	8		<b>011 016</b>
		8	<b>011 026</b>										
	16,0	368	DC 16.06 <Euro 4>; DC 16.09 <Euro 5>; DC 16.19 <Euro 5>	02.06 →	THD	8	<b>*010 038</b>						
					TW	8		<b>011 016</b>					
					8	<b>011 026</b>							
520	16,3	383	DC16 116 520 <EURO 6>	09.17 →	TW	8	<b>011 016</b>						
					16,4	383		DC16 101 520 <Euro 6>	03.13 →	THD	8	<b>*010 038</b>	
										TW	8		<b>011 016</b>
		8	<b>011 026</b>										
	DC16 105 520 <Euro 6>	08.16 →	TW	8	<b>011 016</b>								
			560	16,0	412	DC 16.05 <Euro 4>; DC 16.18 <Euro 5>	02.06 →	THD	8	<b>*010 038</b>			
TW								8	<b>011 016</b>				
	8	<b>011 026</b>											
580	16,0	426	DC 16.03 <Euro 3>	04.04 →	THD	8	<b>*010 038</b>						
					TW	8		<b>011 016</b>					
						8		<b>011 026</b>					
	16,3	427	DC16 117 580 <EURO 6>	09.17 →	TW	8	<b>011 016</b>						
					16,4	427		DC16 102 580 <Euro 6>	03.13 →	THD	8	<b>*010 038</b>	
										TW	8		<b>011 016</b>
	8	<b>011 026</b>											
DC16 106 580 <Euro 6>	08.16 →	TW	8	<b>011 016</b>									
		620	16,0	456	DC 16.08 <Euro 4>; DC 16.17 <Euro 5>	02.06 →	THD	8	<b>*010 038</b>				
							TW	8		<b>011 016</b>			
	8						<b>011 026</b>						
650	16,3	478	DC16 118 650 <EURO 6>	09.17 →	TW	8	<b>011 016</b>						
					730	16,4		537	DC 16.21 <Euro 5/EEV>; DC16 103 730	04.10 →	THD	8	<b>*010 038</b>
											TW	8	
	8	<b>011 026</b>											
DC16 107 730 <Euro 6>; DC16 108 730 <EURO 6>	08.16 →	TW	8	<b>011 016</b>									
		<b>S</b>											
		370	12,7	272	DC13 149 370 <EURO 6>	09.17 →	TW	6	<b>011 016</b>				
410	12,7	302	DC13 141 410 <Euro 6>	08.16 →	TW	6	<b>011 016</b>						
450	12,7	331	DC13 148 450 <Euro 6>	08.16 →	TW	6	<b>011 016</b>						
500	12,7	368	DC13 155 500 <Euro 6>	08.16 →	TW	6	<b>011 016</b>						
520	16,3	383	DC16 116 520 <EURO 6>	09.17 →	TW	8	<b>011 016</b>						
								16,4	383	DC16 105 520 <Euro 6>	08.16 →	TW	8
580	16,3	427	DC16 117 580 <EURO 6>	09.17 →	TW	8	<b>011 016</b>						
								16,4	427	DC16 106 580 <Euro 6>	08.16 →	TW	8
650	16,3	478	DC16 118 650 <EURO 6>	09.17 →	TW	8	<b>011 016</b>						
								730	16,4	537	DC16 107 730 <Euro 6>; DC16 108 730 <EURO 6>	08.16 →	TW





0 444 ... 0 444 ... \*0 444 ...  
 \*\*F 01C ... 0 986 ...

## TEMSA

Avenue									
Diesel	9,2	228	PR228 U2 <Euro 5/EEV>	06.09→	6	012 003	011 013		
					THD	6		*010 033	
LF 12	6,7	206	ISB6.7 <Euro 6>	04.15→	6			*042 014	44D 123
									44D 206
HD 12									
	10,8	320	MX-11.320 <Euro 6>	01.15→	6		043 033		
HD 13									
	10,8	320	MX-11.320 <Euro 6>	07.15→	6		043 033		
LD									
12,13 IC	10,8	271	MX-11.271 <Euro 6>	05.14→	6		043 033		
SB	6,7	228	ISB	03.14-09.15	6			*042 014	44D 123
									44D 206
Maraton									
12,13	10,8	320	MX-11.320 <Euro 6>	08.15→	6		043 033		
MD 7									
	4,5	132	ISBe4.5 <Euro 6>	12.15→	4			*042 014	44D 123
									44D 206
MD 9									
	6,7	184	ISB6.7 <Euro 6>	10.14→	6			*042 014	44D 123
									44D 206
Safari									
12,13 [HD]	12,9	302	MX 300 <Euro 4>	10.06→	6	012 003	011 013		
					THD	6		*010 036	
[RD]	9,2	265	PR 265 S1 <Euro 4>	02.07→	6	012 003			
					THD	6		*010 036	
Safir									
12, 13	12,9	300	MX 300 <Euro 5>	10.09→	6	012 003	011 013		
					THD	6		*010 033	
Safir Plus									
	10,8	320	MX-11.320 <Euro 6>	03.16→	6		043 033		
Tourmalin									
12, 12, IC 12; IC 13	9,2	228	PR 228 S <Euro 4>; PR 228 S <Euro 5/EEV>	05.06→	6	012 003	011 013		
				05.06-08.07	THD	6		*010 036	
				09.07→	THD	6		*010 021	
TS									
45	11,9	313	ISX	02.14-09.15	6			*042 014	44D 123
									44D 206

## VAUXHALL

Vivara									
1.6 CDTI [B]	1,6	70/92	R9M	11.15→	4		021 045		
Vivaro									
1.6 CDTI [B]	1,6	66/85/88/103/107	R9M	10.14→	4		021 045		

## VOLVO











B									
9 L, LA	9,4	191/228/265	D9B260; D9B310; D9B360	09.06→	THD, TW	6		*022 047	44D 110
									44D 115
					TW	6		023 050	
						6		023 071	
					TW, VBS	6		*022 074	44D 110
					TW, VTF	6		*022 039	44D 103
11 33 R, 370 R, 410 R	10,8	243/272/302	D11C330; D11C370; D11C410	09.11→		6	023 049		
					VBS	6		*022 059	44D 110



◀ VOLVO

						0 444 ...	0 444 ...	* 0 444 ...	** F 01C ...	0 986 ...
<b>12 B</b>	12,0	250/279/ 309	DH12E340; DH12E380; DH12E420	01.05 →	6	<b>012 002</b>				
					THD, TW	6		<b>* 022 047</b>	<b>44D 110</b>	<b>44D 115</b>
					TW	6	<b>023 050</b>			
						6	<b>023 071</b>			
					TW, VTF	6		<b>* 022 039</b>	<b>44D 103</b>	
	12,1	338	DH12E460	01.05 →	6	<b>012 002</b>				
					THD, TW	6		<b>* 022 047</b>	<b>44D 110</b>	<b>44D 115</b>
					TW	6	<b>023 050</b>			
						6	<b>023 071</b>			
					TW, VTF	6		<b>* 022 039</b>	<b>44D 103</b>	
<b>13 R 420</b>	12,8	309/338	D13C420; D13C460	09.09 →	6	<b>023 053</b>				
					THD, TW	6		<b>* 022 047</b>	<b>44D 110</b>	<b>44D 115</b>
					TW, VBS	6		<b>* 022 059</b>	<b>44D 110</b>	
						6		<b>* 022 074</b>	<b>44D 110</b>	
<b>FE</b>										
<b>240</b>	7,1	177	D7E240	05.06 →	THD	6		<b>* 022 065</b>	<b>44D 115</b>	
					TW	6	<b>023 016</b>			
						6	<b>023 043</b>			
			D7F240	05.09 →	THD	6		<b>* 022 065</b>	<b>44D 115</b>	
					TW	6	<b>023 016</b>			
						6	<b>023 056</b>			
<b>260</b>	7,1	191	D7F260	05.09 →	THD	6		<b>* 022 065</b>	<b>44D 115</b>	
					TW	6	<b>023 016</b>			
						6	<b>023 056</b>			
<b>280</b>	7,1	206	D7E280	05.06 →	THD	6		<b>* 022 065</b>	<b>44D 115</b>	
					TW	6	<b>023 016</b>			
						6	<b>023 043</b>			
<b>300</b>	7,1	221	D7F300	05.09 →	THD	6		<b>* 022 065</b>	<b>44D 115</b>	
					TW	6	<b>023 016</b>			
						6	<b>023 056</b>			
<b>320</b>	7,1	235	D7E320	05.06 →	THD	6		<b>* 022 065</b>	<b>44D 115</b>	
					TW	6	<b>023 016</b>			
						6	<b>023 043</b>			
<b>340</b>	7,1	250	D7F340	05.09 →	THD	6		<b>* 022 065</b>	<b>44D 115</b>	
					TW	6	<b>023 016</b>			
						6	<b>023 056</b>			
<b>FH</b>										
<b>16 540, 550, 580, 600, 610, 660, 700</b>	16,0	397/404/ 426/442/ 449/485/ 515	D16C550; D16C610; D16E540; D16E580; D16E660; D16G540; D16G600; D16G700	01.03 →	THD, TW	6		<b>* 022 047</b>	<b>44D 110</b>	<b>44D 115</b>
					TW	6		<b>* 042 012</b>	<b>44D 211</b>	<b>44D 222</b>
						6	<b>023 053</b>			
						6	<b>043 004</b>			
<b>380</b>	12,8	280	D13C380	01.09 →	THD, TW	6		<b>* 022 065</b>	<b>44D 115</b>	
					TW	6		<b>* 042 012</b>	<b>44D 211</b>	<b>44D 222</b>
						6	<b>023 018</b>			
						6	<b>023 053</b>			
						6	<b>043 004</b>			
					TW, VTF	6		<b>* 022 039</b>	<b>44D 103</b>	
<b>400</b>	12,8	294	D13A400	09.06-12.11	THD, TW	6		<b>* 022 047</b>	<b>44D 110</b>	<b>44D 115</b>
					TW	6		<b>* 042 012</b>	<b>44D 211</b>	<b>44D 222</b>
						6	<b>023 053</b>			
						6	<b>043 004</b>			



									<b>A</b>	<b>B</b>		
									0 444 ...	0 444 ...	* 0 444 ...	** F 01C ... 0 986 ...
<b>400</b>		12,8	294	D13B400	09.06→	THD,TW	6				* 022 065	44D 115
						TW	6				* 042 012	44D 211
												44D 222
							6				023 018	
							6				023 053	
							6				043 004	
						TW,VTF	6				* 022 039	44D 103
<b>420</b>		12,8	309	D13C420	01.09→	THD,TW	6				* 022 065	44D 115
						TW	6				* 042 012	44D 211
												44D 222
							6				023 018	
							6				023 053	
							6				043 004	
						TW,VTF	6				* 022 039	44D 103
<b>440</b>		12,8	324	D13A440	09.06-12.11	THD,TW	6				* 022 047	44D 110
												44D 115
						TW	6				* 042 012	44D 211
												44D 222
							6				023 053	
							6				043 004	
				D13B440	09.06→	THD,TW	6				* 022 065	44D 115
						TW	6				* 042 012	44D 211
												44D 222
							6				023 018	
							6				023 053	
							6				043 004	
						TW,VTF	6				* 022 039	44D 103
<b>460</b>		12,8	339	D13C460	01.09→	THD,TW	6				* 022 065	44D 115
						TW	6				* 042 012	44D 211
												44D 222
							6				023 018	
							6				023 053	
							6				043 004	
						TW,VTF	6				* 022 039	44D 103
<b>480</b>		12,8	353	D13A480	09.06-12.11	THD,TW	6				* 022 047	44D 110
												44D 115
						TW	6				* 042 012	44D 211
												44D 222
							6				023 053	
							6				043 004	
<b>500</b>		12,8	368	D13B500; D13C500	09.06→	THD,TW	6				* 022 065	44D 115
						TW	6				* 042 012	44D 211
												44D 222
							6				023 018	
							6				023 053	
							6				043 004	
						TW,VTF	6				* 022 039	44D 103
<b>520</b>		12,8	382	D13A520	09.06-12.11	THD,TW	6				* 022 047	44D 110
												44D 115
						TW	6				* 042 012	44D 211
												44D 222
							6				023 053	
							6				043 004	
<b>540</b>		12,8	397	D13C540	01.09→	THD,TW	6				* 022 065	44D 115
						TW	6				* 042 012	44D 211
												44D 222
							6				023 018	
							6				023 053	
							6				043 004	
						TW,VTF	6				* 022 039	44D 103







◀ VOLVO 0 444 ... 0 444 ... \* 0 444 ... \*\* F 01C ... 0 986 ...

FH II											
420	12,8	309	D13C420; D13K420 <Euro 6>	09.12→	TW	6		* 042 012	44D 211		
									44D 222		
								* 042 027	44D 224		
								023 067			
						6	043 087	44D 280			
460	12,8	338	D13C460; D13K460 <Euro 6>	09.12→	TW	6		* 042 012	44D 211		
									44D 222		
								* 042 027	44D 224		
								023 067			
						6	043 087	44D 280			
500	12,8	368	D13C500; D13K500 <Euro 6>	09.12→	TW	6		* 042 012	44D 211		
									44D 222		
								* 042 027	44D 224		
								023 067			
						6	043 087	44D 280			
540	12,8	397	D13C540; D13K540 <Euro 6>	09.12→	TW	6		* 042 012	44D 211		
									44D 222		
								* 042 027	44D 224		
								023 067			
						6	043 087	44D 280			
	16,0	397	D16G540	09.12→	TW	6		* 042 012	44D 211		
									44D 222		
								* 042 027	44D 224		
								023 067			
						6	043 087	44D 280			
550	16,1	405	D16K550 <Euro 6>	08.14→	TW	6		* 042 012	44D 211		
									44D 222		
								* 042 027	44D 224		
								023 067			
						6	043 087	44D 280			
600	16,0	441	D16G600	09.12→	TW	6		* 042 012	44D 211		
									44D 222		
								* 042 027	44D 224		
								023 067			
						6	043 087	44D 280			
650	16,1	479	D16K650 <Euro 6>	08.14→	TW	6		* 042 012	44D 211		
									44D 222		
								* 042 027	44D 224		
								023 067			
						6	043 087	44D 280			
700	16,0	515	D16G700	09.12→	TW	6		* 042 012	44D 211		
									44D 222		
								* 042 027	44D 224		
								023 067			
						6	043 087	44D 280			
750	16,1	552	D16G750; D16K750 <Euro 6>	09.12→	TW	6		* 042 012	44D 211		
									44D 222		
								* 042 027	44D 224		
								023 067			
						6	043 087	44D 280			
FL											
240	7,1	177	D7E240	05.06→	THD	6		* 022 065	44D 115		
									6	023 016	
									6	023 043	
			D7F240	04.09→		6	023 056				
					THD	6	* 022 065	44D 115			
260	7,1	191	D7F260	04.09→		6	023 056				
					THD	6	* 022 065	44D 115			
280	7,1	206	D7E280	05.06→	THD	6	* 022 065	44D 115			
					TW	6	023 016				
						6	023 043				







◀ VOLVO

						0 444 ...	0 444 ...	* 0 444 ...	** F 01C ...	0 986 ...
450	10,8	331	D11C450	05.09→		6	<b>023 049</b>			
					THD	6		<b>* 022 065</b>	<b>44D 115</b>	
			D11K450 <Euro 6>	04.13→		6	<b>023 065</b>			
					TW	6		<b>* 042 027</b>	<b>44D 224</b>	
460	12,8	338	D13K460 <Euro 6>	04.13→		6	<b>023 067</b>			
					TW	6		<b>* 042 027</b>	<b>44D 224</b>	
		339	D13C460	05.09→		6		<b>* 022 065</b>	<b>44D 115</b>	
					THD	6		<b>* 022 065</b>	<b>44D 115</b>	
						6	<b>023 018</b>			
					TW	6		<b>023 053</b>		
480	12,8	353	D13A480	09.05-09.09	THD,TW	6		<b>* 022 065</b>	<b>44D 115</b>	
					TW	6		<b>023 018</b>		
						6	<b>023 053</b>			
					TW	6		<b>023 053</b>		
500	12,8	368	D13C500	05.09→		6		<b>* 022 065</b>	<b>44D 115</b>	
					THD	6		<b>* 022 065</b>	<b>44D 115</b>	
						6	<b>023 018</b>			
					TW	6		<b>023 053</b>		
			D13K500 <Euro 6>	04.13→		6	<b>023 067</b>			
					TW	6		<b>* 042 027</b>	<b>44D 224</b>	
<b>FMX</b>										
330	10,8	243	D11C330	03.10→		6	<b>023 049</b>			
					THD	6		<b>* 022 065</b>	<b>44D 115</b>	
			D11K330 <Euro 6>	04.13→		6	<b>023 065</b>			
					TW	6		<b>* 042 027</b>	<b>44D 224</b>	
370	10,8	272	D11C370	03.10→		6	<b>023 049</b>			
					THD	6		<b>* 022 065</b>	<b>44D 115</b>	
			D11K370 <Euro 6>	04.13→		6	<b>023 065</b>			
					TW	6		<b>* 042 027</b>	<b>44D 224</b>	
380	12,8	280	D13C380	03.10→	THD,TW	6		<b>* 022 065</b>	<b>44D 115</b>	
					TW	6		<b>023 018</b>		
						6	<b>023 053</b>			
					TW,VTF	6		<b>* 022 039</b>	<b>44D 103</b>	
410	10,8	302	D11C410	03.10→		6	<b>023 049</b>			
					THD	6		<b>* 022 065</b>	<b>44D 115</b>	
			D11K410 <Euro 6>	04.13→		6	<b>023 065</b>			
					TW	6		<b>* 042 027</b>	<b>44D 224</b>	
420	12,8	309	D13C420	03.10→	THD,TW	6		<b>* 022 065</b>	<b>44D 115</b>	
					TW	6		<b>023 018</b>		
						6	<b>023 053</b>			
					TW,VTF	6		<b>* 022 039</b>	<b>44D 103</b>	
			D13K420 <Euro 6>	04.13→		6	<b>023 067</b>			
					TW	6		<b>* 042 027</b>	<b>44D 224</b>	
450	10,8	332	D11C450	03.10→		6	<b>023 049</b>			
					THD	6		<b>* 022 065</b>	<b>44D 115</b>	
			D11K450 <Euro 6>	04.13→		6	<b>023 065</b>			
					TW	6		<b>* 042 027</b>	<b>44D 224</b>	
460	12,8	338	D13C460	03.10→	THD,TW	6		<b>* 022 065</b>	<b>44D 115</b>	
					TW	6		<b>023 018</b>		
						6	<b>023 053</b>			
					TW,VTF	6		<b>* 022 039</b>	<b>44D 103</b>	
			D13K460 <Euro 6>	04.13→		6	<b>023 067</b>			
					TW	6		<b>* 042 027</b>	<b>44D 224</b>	
500	12,8	368	D13C500	03.10→	THD,TW	6		<b>* 022 065</b>	<b>44D 115</b>	
					TW	6		<b>023 018</b>		
						6	<b>023 053</b>			
					TW,VTF	6		<b>* 022 039</b>	<b>44D 103</b>	
			D13K500 <Euro 6>	04.13→		6	<b>023 067</b>			
					TW	6		<b>* 042 027</b>	<b>44D 224</b>	
540	12,8	397	D13K540 <Euro 6>	04.13→		6	<b>023 067</b>			
					TW	6		<b>* 042 027</b>	<b>44D 224</b>	





0 444 ... 0 444 ... \*0 444 ... \*\*F 01C ... 0 986 ...

7700						
260	9,4	191	D9B260	06.06→	THD,TW 6	* 022 047 44D 110 44D 115
					TW 6	023 050
					6	023 071
					TW,VBS 6	* 022 074 44D 110
					TW,VTF 6	* 022 039 44D 103
310	9,4	228	D9B310	06.06→	THD,TW 6	* 022 047 44D 110 44D 115
					TW 6	023 050
					6	023 071
					TW,VBS 6	* 022 074 44D 110
					TW,VTF 6	* 022 039 44D 103
360	9,4	265	D9B360	06.06→	THD,TW 6	* 022 047 44D 110 44D 115
					TW 6	023 050
					6	023 071
					TW,VBS 6	* 022 074 44D 110
					TW,VTF 6	* 022 039 44D 103

9700						
	12,1	338	DH12E460	10.07→	6	012 002
					THD,TW 6	* 022 047 44D 110 44D 115
					TW 6	023 050
					6	023 071
					TW,VTF 6	* 022 039 44D 103
	12,8	309/338	D13C420; D13C460	09.08→	6	023 053
					THD,TW 6	* 022 047 44D 110 44D 115
					TW,VBS 6	* 022 059 44D 110
					6	* 022 074 44D 110

9900						
	12,1	338	DH12E460	10.07→	6	012 002
					THD,TW 6	* 022 047 44D 110 44D 115
					TW 6	023 050
					6	023 071
					TW,VTF 6	* 022 039 44D 103
	12,8	309/338	D13C420; D13C460	10.09→	6	023 053
					THD,TW 6	* 022 047 44D 110 44D 115
					TW,VBS 6	* 022 059 44D 110
					6	* 022 074 44D 110



**VW (VOLKSWAGEN)**

California T6						
2.0 TDI, TDI 4Motion [SG]	2,0	62/75/84/ 103/110/ 132/150	CAAB <D55>; CAAC <D94>; CFCA <D49>; CXEB <DN7>; CXFA <DN4>; CXGA <MOI>; CXGB <MOH>; CXHA <DN4>; CXHB <DM6>	04.15→	4	** 600 266

Caravelle T6						
2.0 TDI, TDI 4Motion [SG]	2,0	62/75/84/ 103/110/ 132/150	CAAA <D54>; CAAB <D55>; CAAC <D94>; CFCA <D49>; CXEB <DN7>; CXFA <DN4>; CXGA <MOI>; CXGB <MOH>; CXHA <DN4>; CXHB <DM6>	04.15→	4	** 600 266



◀ VW 0 444 ... 0 444 ... \* 0 444 ... \*\* F 01C ... 0 986 ...

**Crafter 30**

2.0 BitDI, TDI [2E, 2F]	2,0	80/84/	CKTB <DK2>; CKTC <D94>;	05.11-01.16	4	** 600 283
		100/103/	CKUB <D92>; CKUC <D46>;	05.11-12.16	4	021 021
		105/120	CSLA <DK2>; CSLB <DK3>; CSLC <D91>; CSNA	02.16-12.16	4	** 600 266
TDI [SY, SZ]	2,0	75/103/ 130	DAUA <DNO>; DAUB <MOH>; DAVA <DJ8>	09.16→	4	** 600 266
2.5 TDI [2E, 2F]	2,5	65/80/ 100/120	CEBA <D5K>; CEBB <D5L>; CECA <D5M>; CECB <D5N>	05.09-05.13	5	021 021 ** 600 194

**Crafter 35**

2.0 BitDI, TDI [2E, 2F]	2,0	80/84/	CKTB <DK2>; CKTC <D94>;	05.11-01.16	4	** 600 283
		100/103/	CKUB <D92>; CKUC <D46>;	05.11-12.16	4	021 021
		105/120	CSLA <DK2>; CSLB <DK3>; CSLC <D91>; CSNA	02.16-12.16	4	** 600 266
TDI [SY, SZ]	2,0	75/103/ 130	DASB <DNO>; DAUA <DNO>; DAUB <MOH>; DAVA <DJ8>	09.16→	4	** 600 266
2.5 TDI [2E, 2F]	2,5	65/80/ 100/120	CEBA <D5K>; CEBB <D5L>; CECA <D5M>; CECB <D5N>	05.09-05.13	5	021 021 ** 600 194

**Crafter 50**

2.0 BitDI, TDI [2E, 2F]	2,0	80/84/	CKTB <DK2>; CKTC <D94>;	05.11-01.16	4	** 600 283
		100/103/	CKUB <D92>; CKUC <D46>;	05.11-12.16	4	021 021
		105/120	CSLA <DK2>; CSLB <DK3>; CSLC <D91>; CSNA	02.16-12.16	4	** 600 266
TDI [SY, SZ]	2,0	90/103/ 130	DASA <DNO>; DASB <DNO>; DAWA <DJ8>	05.17→	4	** 600 266
2.5 TDI [2E, 2F]	2,5	80/100/ 120	CEBB <D5L>; CECA <D5M>; CECB <D5N>	05.09-05.13	5	021 021 ** 600 194

**Multivan T6**

2.0 TDI, TDI 4Motion [SG]	2,0	62/75/84/ 103/110/ 132/150	CAAB <D55>; CAAC <D94>; CFCA <D49>; CXEB <DN7>; CXFA <DN4>; CXGA <M01>; CXGB <MOH>; CXHA <DN4>; CXHB <DM6>	04.15→	4	** 600 266
		TDI 4Motion [SSG]	2,0	103	CAAC <D94>	04.15→

**Transporter T6**

2.0 TDI [DI]	2,0	84	CXHB <DM6>	05.16→	4	** 600 266
TDI, TDI 4Motion [SF]	2,0	62/75/ 110/150	CXEB <DN7>; CXGA <M01>; CXGB <MOH>; CXHA <DN4>	07.15→	4	** 600 266
		TDI, TDI 4Motion [SG]	2,0	62/75/84/ 103/110/ 132/150	CAAA <D54>; CAAB <D55>; CAAC <D94>; CFCA <D49>; CXEB <DN7>; CXFA <DN4>; CXGA <M01>; CXGB <MOH>; CXHA <DN4>; CXHB <DM6>	04.15→



de

## Gegenüberstellung

## Benutzerhinweise

Im nachfolgenden Katalogteil sind Bestellnummern von Herstellern anderer Marken, für die es einbaugleiche Bosch-Erzeugnisse oder -Teile gibt, aufgeführt. Da die verschiedenartigsten Bezeichnungssysteme angewendet werden, konnten die fremden Bestellnummern nur in einer einheitlichen, alphanumerischen Sortierfolge geordnet werden. Sie weicht bei einigen Herstellern von der dort üblichen Sortierfolge ab.

„Werden Bosch-Teile mit Teilenummern versehen, sind aus wettbewerbsrechtlichen Gründen in jedem Fall die jeweiligen Bosch-Teilenummern zu verwenden und als solche kenntlich zu machen. Daneben können auch fremde Teilenummern verwendet werden, um die technische bzw. funktionale Gleichwertigkeit der jeweiligen Produkte zum Ausdruck zu bringen. Ggf. sollten nach Möglichkeit fremde Teilenummern sogleich mehrerer Hersteller aufgeführt werden.“

Eine fremde Teilenummer ist dabei eindeutig als solche eines anderen Herstellers kenntlich zu machen, wie insbesondere durch gleichzeitige Nennung des fremden Herstellers bzw. der fremden Marke sowie deren eindeutige Zuordnung zu der fremden Teilenummer.

Alle Angaben dürfen nur in Standard-Schrift erfolgen. Insbesondere dürfen keine Logos oder besondere Schriftzüge der fremden Hersteller verwendet und ihre Marken bzw. Namen auch sonst nicht besonders hervorgehoben werden.

Vielmehr sollte die Nennung fremder Namen, Marken und Teilenummern generell möglichst unauffällig erfolgen.“

en

## Cross-reference

## Notes for users

The following catalog section lists part numbers of non-Bosch equipment for which there are interchangeable Bosch products or components available. Since a wide range of different designation systems are used, we were forced to arrange the non-Bosch part numbers in a uniform alphanumerical order. This differs from the customary order employed by some manufacturers.

“If part numbers are assigned to Bosch parts, the corresponding Bosch part numbers are always to be used and clearly identified as such to satisfy the law on competition. Use can additionally be made of non-Bosch part numbers to express the equivalent technical and functional properties of the products concerned.

If applicable, the non-Bosch part numbers of several manufacturers should be listed wherever possible. When doing so, a non-Bosch part number is to be clearly identified as that of another manufacturer, in particular by naming the other manufacturer or the non-Bosch make and clearly assigning this to the non-Bosch part number.

All such information must always be given in standard typeface. In particular, use is not to be made of any logos or special emblems of other manufacturers and their brands and names are not to be specially highlighted in any other way.

On the contrary, mention should only be made of non-Bosch names, makes and part numbers as inconspicuously as possible.”

fr

## Table de correspondance

## A l'attention de l'utilisateur

Cette section du catalogue reprend les références des fabricants d'autres marques pour lesquelles il existe des produits ou des composants Bosch de montage identique. De multiples systèmes de codage étant utilisés, les références des produits d'autres marques ne peuvent être reprises que suivant un classement alphanumérique uniforme. Pour certains fabricants, ce classement peut différer de celui qu'ils utilisent habituellement.

«Si des pièces Bosch sont munies de références, pour des raisons liées à la législation sur la concurrence, les références Bosch correspondantes doivent être utilisées dans tous les cas et être rendues identifiables comme telles. Parallèlement, des références étrangères peuvent également être utilisées pour exprimer l'équivalence technique ou fonctionnelle des produits considérés.

Le cas échéant, indiquer si possible conjointement les références étrangères de plusieurs fabricants.

Une référence étrangère doit être identifiée clairement comme étant celle d'un autre fabricant, notamment par l'indication simultanée de l'autre fabricant ou de l'autre marque, de même que par leur correspondance claire à la référence étrangère.

Toutes les indications doivent être effectuées dans la police standard. Aucun logo ou monogramme particulier des fabricants étrangers ne doit en particulier être utilisé et leurs marques ou noms ne doivent être mis en valeur d'aucune autre façon.

Au contraire, les noms, marques et références étrangers doivent, d'une manière générale, être cités de façon aussi discrète que possible.»

it

## Comparazione

## Avvertenze per la consultazione

Nella seguente parte del catalogo vengono riportati i numeri di ordinazione di costruttori di prodotti d'altra marca, per i quali sono disponibili prodotti o parti di prodotti Bosch di corrispondente applicazione. Dato che vengono utilizzati i più diversi sistemi di denominazione, si è potuto ordinare i numeri di ordinazione di altra marca solo in una sequenza di classificazione unitaria ed alfanumerica. Per alcune case costruttrici si differenzia perciò dalla sequenza di classificazione normalmente usata. In questo confronto le sigle Bosch vanno considerate come dati indicativi.

«Qualora componenti Bosch vengano coredati di codici, per motivi legati alle leggi che regolano la concorrenza si devono utilizzare in ogni caso i relativi codici Bosch evidenziandoli come tali. L'utilizzo di codici di altra marca è comunque possibile per esprimere una equivalenza tecnica o funzionale dei relativi prodotti.

Possibilmente è da prediligere l'indicazione contemporanea di codici di diversi costruttori.

Un codice che non sia Bosch va evidenziato in modo univoco in tal senso, in particolare nominando contestualmente il costruttore o la marca di appartenenza. Tutte le indicazioni devono essere riportate ricorrendo a caratteri standard. In particolare non si devono utilizzare loghi o scritte particolari usati dai costruttori di prodotti di altra marca né si devono mettere in risalto i relativi marchi o nomi.

Al contrario, l'indicazione di nomi, marche e codici diversi da Bosch dovrebbe essere in genere quanto più discreta possibile.»

es

## Equivalencias

## Indicaciones para el usuario

A continuación se han relacionado números de pedido de fabricantes de otras marcas para los que existen productos o piezas Bosch de iguales características. Dado que se utilizan los más diversos sistemas de designación, los números de pedido ajenos han podido relacionarse tan sólo en un orden unificado, alfanumérico. En el caso de algunos fabricantes, el orden de esta clasificación difiere del que utilizan habitualmente.

«Si piezas Bosch se dotan de números de pieza, por motivos de índole legal relativos a la competencia se deben utilizar en cualquier caso los respectivos números de pieza Bosch, identificándolos como tales debidamente. Paralelamente se pueden usar también números de pieza ajenos para poner de manifiesto la equivalencia técnica o funcional de los respectivos productos.

En su caso y en la medida de lo posible, se deberían citar al mismo tiempo números de pieza ajenos de varios fabricantes. Un número de pieza ajeno se debe identificar en estos casos claramente como perteneciente a otro fabricante, por ejemplo citando simultáneamente al fabricante ajeno o la marca ajena así como estableciendo la correspondencia de éstos con el número de pieza ajeno.

Todos los datos se deben escribir solo con letra estándar. En particular, no se permite utilizar logotipos o caracteres gráficos propios de los fabricantes ajenos, ni tampoco destacar sus marcas y nombres de manera especial.

Por el contrario, los nombres, las marcas y los números de piezas de empresas ajenas se deberían citar, en general, de la forma más discreta posible.»

pt

## Comparação

## Instruções para o utilizador

Na parte do catálogo que se segue, apresentam-se os números de referência de fabricantes de outras marcas e, em alguns casos, de fabricantes de veículos, para as quais existem produtos ou peças equivalentes aos da Bosch.

Sendo os sistemas de designação dos mais variados tipos, os números de referência de fabricantes externos só puderam ser catalogados numa sequência alfanumérica única. Esta desvia-se da sequência de catalogação normalmente utilizada por alguns fabricantes.

«Se as peças Bosch estiverem identificadas com um número de peça, devem ser usados sempre os respectivos números de peça Bosch e ser identificados como tal, por motivos relacionados com a lei da concorrência. Podem ser usados adicionalmente números de peça de terceiros para destacar a equivalência técnica ou funcional dos respectivos produtos.

Se necessário, e consoante a possibilidade, deveriam ser indicados os números de peça de terceiros de vários fabricantes em simultâneo.

Contudo, um número de peça de terceiros deve ser claramente identificado como sendo de outro fabricante, nomeando tanto o outro fabricante ou a outra marca, como a respectiva atribuição inequívoca do número de peça de terceiros.

Todas as indicações têm de ser expressas em letra standard. Não podem, sobretudo, ser usados quaisquer logótipos ou inscrições especiais de outros fabricantes, nem ser destacada, de modo algum, a marca ou o nome.

Por norma, é desejável que a menção de nomes, marcas e números de peça de terceiros seja feita da forma menos visível.»

sv

## Jämförelse

## Bruksanvisning

I efterföljande katalogdel ingår artikelnumrer på de produkter av annan tillverkning, för vilka utbytbara Boschprodukter eller delar finns. Eftersom olika beteckningssystem används, har de främmande artikelnumren endast kunnat sorteras i en enhetlig, alfanumerisk följd, som avviker från sedvanlig sorteringsföljd när det gäller en del tillverkare.

»Om Bosch reservdelar förses med reservdelsnummer ska av konkurrensrättsliga skäl alltid respektive Bosch-reservdelsnummer användas och kännetecknas som sådant. Därutöver kan även främmande reservdelsnummer användas, för att markera att teknisk resp. funktionell likvärdighet består med respektive produkt. Om möjligt bör samtidigt främmande reservdelsnummer för flera tillverkare anges.

Därvid ska det entydigt framgå att det främmande reservdelsnumret härrör från en annan tillverkare, genom att framför allt den främmande tillverkaren eller det främmande märket samtidigt nämns samt dess entydiga allokering till det främmande reservdelsnumret.

Alla angivelser får bara göras med standardskrift. I synnerhet får inga logotypen eller speciella fonter från den främmande tillverkaren användas och inte heller dess märke eller namn speciellt framhållas. Tvärtom ska främmande namn, märken och reservdelsnummer generellt sett användas så diskret som möjligt.»

fi

## Vertailu

## Esitteen käyttäjälle

Esitteen seuraavassa osassa on annettu valmistajien tilausnumero vierastuotteille, joille on olemassa vaihtokelpoisia Bosch-tuotteita tai -osia.

Koska tuotteiden merkinnät eroavat toisistaan suuresti, vierastuotteiden tilausnumeroihin on sovellettu yhtenäistettyä, aakkosnumeerista järjestystä.

Se poikkeaa osittain valmistajien omasta ryhmittelystä ja järjestyksestä. Jos Bosch-osin liitetään osanumerot, on kilpailuoikeudellista systä pakko käyttää ko. osan Bosch-osanumeroa, joka on lisäksi merkittävä selvästi valmistajan numerona. Lisäksi voidaan käyttää myös muiden valmistajien osanumeroita, mikäli näin halutaan ilmaista ko. tuotteen tekninen tai toiminnallinen samanvertaisuus. Tarpeen mukaan on mahdollista mainita usemman valmistajan osanumerot rinnakkain.

Vieraan valmistajan osanumero on silloin merkittävä selvästi vieraana osanumerona mainitsemalla esimerkiksi ko. valmistajan tai merkin nimi sekä ilmoittamalla, mihin vieras osanumero viittaa. Em. tiedot on annettava aina normaalin kirjjasim. Vieraiden valmistajien logoja tai vastaavia ei saa käyttää eikä korostaa merkien tai valmistajien nimiä tekstitehostein.

Vieraiden nimien, merkien ja osanumeron kirjoitustavan on oltava mahdollisimman neutraali. sett användas så diskret som möjligt.»

pl

## Zamienniki

## Wskazówki dla użytkownika

W następnej części katalogu podane są numery katalogowe producentów innych marek, dla których istnieją zamienniki lub części firmy Bosch. Ponieważ stosowane są bardzo różne systemy nazewnictwa, numery katalogowe innych firm podane są jedynie w jednolitej kolejności alfanumerycznej. W przypadku niektórych producentów odbiega ona od stosowanej przez nich kolejności sortowania.

«Jeśli części Bosch będą miały numery katalogowe, to ze względu na przepisy dotyczące konkurencji, w każdym przypadku należy użyć poszczególnych numerów katalogowych Bosch i wyrazić je tak oznaczyć. Ponadto można użyć obcych numerów katalogowych, aby zademonstrować techniczną lub funkcjonalną jednorodność z poszczególnymi produktami.

Eventualnie w razie możliwości można wymienić jednocześnie obce numery katalogowe kilku innych producentów. Obcy numer katalogowy musi zostać wyraźnie oznaczony jako dotyczący innego producenta, a w szczególności poprzez jednoczesne wymienienie innego producenta lub innej marki oraz ich jednoczynnego przyporządkowania do obcego numeru katalogowego.

Wszystkie informacje muszą być sporządzone w standardowym sposobie napisów. W szczególności nie można używać żadnych logotypów ani specjalnych napisów innych producentów, a ich marki lub nazwy nie mogą być wyróżnione w specjalny sposób.

Wymienienie obcych nazw, marek i numerów katalogowych powinno raczej zasadniczo nastąpić w sposób jak najmniej widoczny.»

ru

## Сопоставления

## Вниманию пользователей

В следующей части каталога приводятся номера заказов производителей других марок, для которых имеются идентичные изделия или запчасти компании Bosch. Поскольку используются различные системы обозначений, номера заказов других производителей располагаются в едином алфавитно-цифровом порядке. Для некоторых производителей они отличаются от используемого у них порядка классификации.

«Если изделия Bosch имеют номера деталей, то по причинам законодательных положений в области конкуренции в любом случае необходимо использовать соответствующие номера Bosch и показывать их. Кроме того, можно использовать также номера деталей других производителей, чтобы показать техническую и функциональную равноценность соответствующих изделий.

В отдельных случаях необходимо по возможности указывать номера деталей нескольких производителей. Номер детали другого производителя явно показывать как таковой, например, одновременно называя другого производителя или другую марку, а также их однозначное отношение к номеру детали другого производителя. Все данные должны указываться стандартным шрифтом. В особенности, не разрешается использовать логотипы и специальные надписи других производителей и особым образом выделять их марки и названия.

Напротив, названия, марки и номера деталей других производителей всегда необходимо указывать по возможности неброско.»



**AGCO (DEUTZ-ALLIS)**

E842201110050	<b>0 444 043 073</b>
V837079432	<b>F 00E 200 468</b>
V837079858	<b>F 00E 200 527</b>

836772606	<b>0 460 424 495</b>
836772607	<b>0 460 424 495</b>
836772608	<b>0 460 424 493</b>
836872609	<b>0 460 426 499</b>
836872610	<b>0 460 426 499</b>

836872611	<b>0 460 426 496</b>
837069405	<b>0 445 120 063</b>
837069405	<b>0 445 120 340</b>
837069405	<b>0 986 435 547</b>
837074663	<b>0 444 043 056</b>

837074845	<b>0 444 043 054</b>
837074846	<b>0 444 042 071</b>
837074848	<b>0 444 042 075</b>
837084092	<b>0 444 042 077</b>
837084093	<b>0 444 042 079</b>

89709700	<b>0 432 191 212</b>
89709800	<b>0 432 191 213</b>

**AGCO SISU POWER**

V837069326	<b>0 445 120 062</b>
V837069326	<b>0 986 435 546</b>
V867069326	<b>0 445 120 062</b>

V867069326	<b>0 986 435 546</b>
836864609	<b>0 470 506 042</b>
836869461	<b>0 470 006 008</b>
837072654	<b>0 444 022 026</b>
837073791	<b>0 445 110 408</b>

837073791	<b>0 445 110 563</b>
837074805	<b>0 445 020 611</b>
837081020	<b>0 445 025 035</b>
837086092	<b>0 445 120 458</b>
837086246	<b>0 445 020 290</b>

**AGRALE**

6007 001 451 00 3	<b>0 460 424 128</b>
6007 001 508 00 0	<b>9 430 082 767</b>
6007 001 583 00 3	<b>0 460 424 194</b>

6007 001 585 00 8	<b>9 430 082 759</b>
6008001213005	<b>0 460 424 138</b>
6008 001 748 00 0	<b>0 460 424 210</b>
6008 001 749 00 8	<b>0 460 424 211</b>
6008 001 768 00 8	<b>F 000 439 005</b>

6009 001 090 00 5	<b>0 460 424 369</b>
6012.301.133.00.4	<b>0 460 426 464</b>
6013 101 144 00 1	<b>0 445 020 033</b>
6025.001.071.00.1	<b>0 444 042 014</b>
6033.101.096.00.1	<b>0 444 042 018</b>

6033.101.121.00.7	<b>0 444 042 137</b>
7.003.008.006.00.6	<b>9 430 082 332</b>
7.004.008.007.00.2	<b>9 430 082 277</b>
7.006.008.006.00.9	<b>9 430 082 212</b>
7.006.008.038.00.2	<b>9 430 082 229</b>

7.006.008.046.00.5	<b>9 430 082 328</b>
7.006.008.048.00.1	<b>9 430 082 327</b>
7.007.008.006.00.7	<b>0 432 291 838</b>
7.008.008.028.00.9	<b>9 430 082 332</b>
9229 0727 0014	<b>0 445 025 628</b>

**AGRIFULL (N.H.GEOTECH)**

4792442	<b>0 432 291 654</b>
4794588	<b>0 460 414 013</b>

4794588	<b>0 986 440 024</b>
4794589	<b>0 460 414 015</b>
4800029	<b>0 432 291 655</b>
4804869	<b>0 460 414 024</b>

**ALFA ROMEO**

0000046472233	<b>0 445 110 002</b>
0000046472233	<b>0 986 435 001</b>
0000046559804	<b>0 281 002 309</b>

0000055198217	<b>0 445 110 244</b>
0000055198217	<b>0 986 435 161</b>
00150 62 012	<b>0 986 430 249</b>
195 46 11 013 00	<b>0 280 202 105</b>
46407008	<b>0 280 217 111</b>

46416748	<b>0 280 217 514</b>
464302102	<b>0 986 435 001</b>
46444287	<b>0 280 217 531</b>
46444287	<b>0 986 280 233</b>
46447503	<b>0 986 280 236</b>

46447508	<b>0 281 002 199</b>
46461616	<b>0 432 217 296</b>
464629710	<b>0 986 435 001</b>
46464928	<b>0 280 217 102</b>
464649280	<b>0 280 217 102</b>

46469917	<b>0 986 280 234</b>
46472233	<b>0 986 435 001</b>
46522786	<b>0 986 437 001</b>
46522787	<b>0 445 010 007</b>
46522787	<b>0 986 437 002</b>

46533308	<b>0 986 280 235</b>
46541253	<b>0 986 280 236</b>
46547897	<b>0 986 435 006</b>
46552161	<b>0 460 484 154</b>
46554997	<b>0 460 484 083</b>

46559804	<b>0 281 002 309</b>
46559828	<b>0 281 002 308</b>
46749246	<b>0 280 218 054</b>
46749246	<b>0 986 280 238</b>
46787376	<b>0 445 110 068</b>

46808221	<b>0 281 002 533</b>
46811122	<b>0 280 218 120</b>
46811229	<b>0 445 010 006</b>
46811230	<b>0 445 010 007</b>
46811230	<b>0 986 437 002</b>

46811312	<b>0 280 218 113</b>
46811312	<b>0 986 280 239</b>
46824377	<b>0 281 002 598</b>
500305724	<b>0 986 440 163</b>
504095664	<b>0 445 020 046</b>

504095664	<b>0 986 437 321</b>
51782033	<b>0 281 002 861</b>
51782034	<b>0 281 002 980</b>
51782035	<b>0 281 002 860</b>
51782035	<b>0 281 002 917</b>

51792729	<b>0 280 218 237</b>
51827033	<b>0 281 006 048</b>
51831050	<b>0 281 006 054</b>
55183650	<b>0 281 002 792</b>
55187290	<b>0 445 110 119</b>

55187290	<b>0 986 435 083</b>
55187291	<b>0 445 110 119</b>
55187291	<b>0 986 435 083</b>
55187722	<b>0 986 280 241</b>
55190587	<b>0 281 002 763</b>

55190587	<b>0 281 002 764</b>
55190587	<b>0 281 006 048</b>
55192534	<b>0 445 110 111</b>
55192534	<b>0 986 435 081</b>
55192948	<b>0 445 110 119</b>

55192948	<b>0 986 435 083</b>
55193048	<b>0 281 002 309</b>
55193049	<b>0 280 218 054</b>
55193049	<b>0 986 280 238</b>
55193808	<b>0 445 110 111</b>

55193808	<b>0 986 435 081</b>
55196385	<b>0 280 218 182</b>
55198217	<b>0 445 110 244</b>
55198217	<b>0 986 435 161</b>
55198218	<b>0 445 110 243</b>

55198218	<b>0 445 110 391</b>
55198218	<b>0 986 435 208</b>
55198219	<b>0 445 110 213</b>
55198219	<b>0 986 435 162</b>
55198519	<b>0 445 010 123</b>

55198519	<b>0 445 010 285</b>
55198519	<b>0 445 010 349</b>
55200259	<b>0 445 110 276</b>
55200259	<b>0 986 435 148</b>
55204428	<b>0 445 010 150</b>

55204428	<b>0 445 010 286</b>
55204429	<b>0 445 010 123</b>
55204429	<b>0 445 010 285</b>
55204429	<b>0 445 010 349</b>
55205935	<b>0 445 010 150</b>

55205935	<b>0 445 010 286</b>
55205935	<b>0 986 437 035</b>
55206489	<b>0 445 010 293</b>
55206489	<b>0 986 437 036</b>
55206704	<b>0 445 110 300</b>

55206704	<b>0 986 435 171</b>
55208183	<b>0 445 110 308</b>
55208183	<b>0 986 435 197</b>
55208726	<b>0 280 218 237</b>
55209062	<b>0 445 010 185</b>

55209382	<b>0 445 110 299</b>
55209382	<b>0 986 435 230</b>
55217235	<b>0 445 110 213</b>
55217235	<b>0 986 435 162</b>
55218785	<b>0 445 110 341</b>

55219886	<b>0 445 110 351</b>
55219886	<b>0 986 435 204</b>
55221020	<b>0 445 110 243</b>
55221020	<b>0 445 110 391</b>
55221020	<b>0 986 435 104</b>

55221020	<b>0 986 435 208</b>
55221023	<b>0 445 110 300</b>
55221023	<b>0 986 435 171</b>
55221024	<b>0 445 110 299</b>
55221024	<b>0 986 435 230</b>

55230348	<b>0 445 010 292</b>
55233955	<b>0 445 110 419</b>
55233955	<b>0 986 435 213</b>
55234362	<b>0 445 010 302</b>
55234362	<b>0 445 010 305</b>

55234364	<b>0 445 010 308</b>
55234364	<b>0 445 010 309</b>
55236707	<b>0 445 010 265</b>
55236707	<b>0 445 010 425</b>
55236707	<b>0 986 437 097</b>

55237687	<b>0 445 010 308</b>
55237687	<b>0 445 010 309</b>
55237688	<b>0 445 010 304</b>
55237688	<b>0 445 010 305</b>
55237688	<b>0 986 437 094</b>

55237690	<b>0 445 010 310</b>
55237690	<b>0 986 437 038</b>
55246223	<b>0 445 110 524</b>
55246223	<b>0 986 435 280</b>
55254750	<b>0 445 010 424</b>

55254750	<b>0 986 437 095</b>
55255406	<b>0 445 110 614</b>
55255406	<b>0 986 435 249</b>
55255416	<b>0 445 010 425</b>
55255416	<b>0 986 437 097</b>

55260836	<b>0 445 110 673</b>
55262755	<b>0 445 110 680</b>
55263233	<b>0 445 110 682</b>
55267246	<b>0 445 010 466</b>
55267246	<b>0 986 437 095</b>



55272459	<b>0 445 010 737</b>
55274845	<b>0 445 010 747</b>
55350048	<b>0 281 002 683</b>
6053 48 380	<b>0 280 202 105</b>
6057940	<b>0 280 202 212</b>

60589472	<b>0 280 217 503</b>
60604589	<b>0 432 217 249</b>
60616998	<b>0 460 404 991</b>
60663029	<b>0 280 218 036</b>
60663029	<b>0 986 280 237</b>

60755046	<b>0 280 200 001</b>
6080915	<b>0 280 202 212</b>
60810813	<b>0 280 217 111</b>
6081145	<b>0 280 217 514</b>
60814750	<b>0 445 010 007</b>

60814750	<b>0 986 437 002</b>
60814852	<b>0 986 280 236</b>
60816137	<b>0 281 002 309</b>
60816392	<b>0 445 110 068</b>
60816615	<b>0 445 010 007</b>

60816616	<b>0 445 010 006</b>
71788020	<b>0 986 280 234</b>
71795163	<b>0 445 110 419</b>
73501003	<b>0 445 010 072</b>
73501013	<b>0 445 010 071</b>

73501139	<b>0 445 110 119</b>
73501139	<b>0 986 435 083</b>
73503097	<b>0 445 110 111</b>
73503097	<b>0 986 435 081</b>
7662850	<b>0 432 217 273</b>

95400103	<b>0 445 110 002</b>
95400103	<b>0 986 435 001</b>

## ALPINA

13 53 118	<b>0 445 110 031</b>
-----------	----------------------

## ANDORIA

2 77 123	<b>0 281 002 932</b>
27712311	<b>0 281 002 932</b>

## ASHOK LEYLAND

FHL00100	<b>0 445 025 043</b>
F2016500	<b>0 281 005 540</b>
F8095100	<b>F 002 C7Z 201</b>

X7406000	<b>F 002 C7Z 204</b>
X7414800	<b>F 002 C7Z 105</b>
X7419100	<b>0 460 426 338</b>
X7420700	<b>F 002 C7Z 109</b>
X7473500	<b>F 002 C7Z 120</b>

X7473600	<b>0 432 193 464</b>
X7478200	<b>0 445 020 091</b>
X7478400	<b>0 445 120 101</b>
X7492300	<b>0 460 426 463</b>
X7495000	<b>0 445 020 141</b>

## ASTRA

500331074	<b>0 414 701 083</b>
500331074	<b>0 986 441 113</b>
504287069	<b>0 414 703 004</b>

5801453888	<b>0 445 124 015</b>
5801453888	<b>0 986 435 663</b>
5801486599	<b>0 445 020 195</b>
5801486599	<b>0 986 437 512</b>
5801730656	<b>0 444 023 058</b>

5801906153	<b>0 445 124 036</b>
5801906153	<b>0 986 435 674</b>

## AUDI

028 130 108 M	<b>0 986 440 560</b>
028 130 109 H	<b>0 460 404 971</b>
028 130 109 J	<b>0 986 440 559</b>

028 130 109 L	<b>0 986 440 558</b>
028 130 115 A	<b>0 460 404 969</b>
028 130 115 A	<b>0 986 440 554</b>
028 130 115 M	<b>0 460 404 971</b>
028 130 115 M	<b>0 986 440 555</b>

028 130 115 N	<b>0 986 440 558</b>
028 130 201	<b>0 986 430 253</b>
028 130 201 B	<b>0 432 217 284</b>
028 130 201 B	<b>0 986 430 206</b>
028 130 201 G	<b>0 432 193 838</b>

028 130 201 H	<b>0 432 193 837</b>
028 130 201 T	<b>0 432 193 746</b>
028 130 202 H	<b>0 432 193 704</b>
028 130 202 J	<b>0 432 193 702</b>
028 130 202 P	<b>0 432 193 695</b>

028 130 202 Q	<b>0 432 193 693</b>
028 906 301	<b>0 281 002 072</b>
028 906 461	<b>0 281 002 216</b>
028 906 461	<b>0 986 284 001</b>
03G 130 073 B	<b>0 414 720 402</b>

03G 130 073 B	<b>0 414 720 453</b>
03G 130 073 B	<b>0 986 441 580</b>
03G 130 073 G	<b>0 414 720 454</b>
03G 130 073 G	<b>0 986 441 566</b>
03G 906 461 C	<b>0 281 002 735</b>

03H906461	<b>0 280 218 175</b>
03L 130 277	<b>0 445 116 029</b>
03L 130 277	<b>0 986 435 360</b>
03L 130 277 A	<b>0 445 116 010</b>
03L 130 277 A	<b>0 986 435 367</b>

03L 130 277 C	<b>0 986 435 369</b>
03L 130 277 J	<b>0 986 435 166</b>
03L 130 277 Q	<b>0 445 110 646</b>
03L 130 277 Q	<b>0 986 435 166</b>
03L 130 755	<b>0 445 010 546</b>

03L 130 755	<b>0 986 437 410</b>
03L 130 755 A	<b>0 445 010 543</b>
03L 130 755 A	<b>0 986 437 410</b>
03L 130 755 AA	<b>0 445 010 565</b>
03L 130 755 AA	<b>0 986 437 405</b>

03L 130 755 AC	<b>0 445 010 562</b>
03L 130 755 AC	<b>0 986 437 434</b>
03L 130 755 AE	<b>0 445 010 568</b>
03L 130 755 AE	<b>0 986 437 434</b>
03L 130 755 L	<b>0 445 010 560</b>

03L 130 855 BX	<b>0 986 435 369</b>
03L 906 461 A	<b>0 281 002 956</b>
034 133 471 K	<b>0 986 280 137</b>
034 133 471 N	<b>0 986 280 139</b>
037 906 461 C	<b>0 280 217 117</b>

038 130 073 AA	<b>0 414 720 028</b>
038 130 073 AA	<b>0 986 441 557</b>
038 130 073 AG	<b>0 414 720 265</b>
038 130 073 AG	<b>0 986 441 559</b>
038 130 073 AJ	<b>0 414 720 087</b>

038 130 073 AJ	<b>0 986 441 556</b>
038 130 073 AL	<b>0 414 720 089</b>
038 130 073 AL	<b>0 986 441 557</b>
038 130 073 AQ	<b>0 414 720 213</b>
038 130 073 AQ	<b>0 986 441 559</b>

038 130 073 BA	<b>0 414 720 116</b>
038 130 073 BA	<b>0 414 720 266</b>
038 130 073 BA	<b>0 986 441 560</b>
038 130 073 BD	<b>0 414 720 276</b>
038 130 073 BD	<b>0 986 441 571</b>

038 130 073 BH	<b>0 414 720 280</b>
038 130 073 BH	<b>0 986 441 575</b>
038 130 073 BJ	<b>0 414 720 279</b>
038 130 073 BJ	<b>0 986 441 574</b>
038 130 073 BL	<b>0 414 720 307</b>

038 130 073 BL	<b>0 986 441 568</b>
038 130 073 BN	<b>0 414 720 363</b>
038 130 073 BN	<b>0 986 441 568</b>
038 130 073 BP	<b>0 414 720 364</b>
038 130 073 BP	<b>0 986 441 577</b>

038 130 073 BQ	<b>0 414 720 362</b>
038 130 073 BQ	<b>0 986 441 567</b>
038 130 073 F	<b>0 414 720 007</b>
038 130 073 F	<b>0 986 441 551</b>
038 130 073 J	<b>0 414 720 015</b>

038 130 073 J	<b>0 986 441 556</b>
038 130 107 D	<b>0 460 404 977</b>
038 130 107 D	<b>0 986 440 557</b>
038 130 107 DX	<b>0 460 404 977</b>
038 130 107 DX	<b>0 986 440 557</b>

038 130 107 H	<b>0 986 440 561</b>
038 130 107 J	<b>0 986 440 561</b>
038 130 201 F	<b>0 432 193 734</b>
038 130 201 G	<b>0 432 193 732</b>
038 130 202 A	<b>0 432 193 594</b>

038 130 202 B	<b>0 432 193 592</b>
038 906 461 B	<b>0 986 284 009</b>
038 906 461 C	<b>0 280 217 121</b>
038 906 461 C	<b>0 281 002 757</b>
038 906 461 C	<b>0 986 280 202</b>

038 906 461 C	<b>0 986 284 010</b>
038 906 461 CX	<b>0 986 280 202</b>
04L 130 277	<b>0 445 110 468</b>
04L 130 277	<b>0 986 435 258</b>
04L 130 277 A	<b>0 445 110 472</b>

04L 130 277 A	<b>0 986 435 259</b>
04L 130 277 AA	<b>0 445 110 638</b>
04L 130 277 AB	<b>0 445 110 641</b>
04L 130 277 AC	<b>0 445 110 468</b>
04L 130 277 AC	<b>0 986 435 258</b>

04L 130 277 AD	<b>0 445 110 472</b>
04L 130 277 AE	<b>0 445 110 470</b>
04L 130 277 AE	<b>0 986 435 257</b>
04L 130 277 AF	<b>0 445 110 644</b>
04L 130 277 AJ	<b>0 445 110 476</b>

04L 130 277 AK	<b>0 445 110 474</b>
04L 130 277 AK	<b>0 986 435 242</b>
04L 130 277 AL	<b>0 445 110 704</b>
04L 130 277 AM	<b>0 445 110 702</b>
04L 130 277 E	<b>0 445 110 474</b>

04L 130 277 E	<b>0 986 435 242</b>
04L 130 277 G	<b>0 445 110 476</b>
04L 130 277 G	<b>0 986 435 241</b>
04L 130 277 K	<b>0 445 110 470</b>
04L 130 277 K	<b>0 986 435 257</b>

04L 130 277 N	<b>0 445 110 553</b>
04L 130 277 P	<b>0 445 110 555</b>
04L 130 755 D	<b>0 445 010 570</b>
04L 130 755 D	<b>0 986 437 440</b>
04L 130 755 E	<b>0 445 010 583</b>

04L 130 755 E	<b>0 986 437 440</b>
045 130 073 AA	<b>0 414 720 084</b>
045 130 073 AA	<b>0 986 441 555</b>
045 130 073 P	<b>0 414 720 030</b>
045 130 073 P	<b>0 986 441 555</b>

045 130 073 T	<b>0 414 720 085</b>
045 130 073 T	<b>0 986 441 551</b>
046 130 108 A	<b>0 986 440 566</b>
046 130 108 D	<b>0 460 415 994</b>
046 130 108 D	<b>0 986 440 563</b>

046 130 108 G	<b>0 986 440 563</b>
05A 130 277	<b>0 445 117 011</b>
05A 130 277	<b>0 986 435 384</b>
05A 130 755 B	<b>0 445 010 663</b>
05A 130 755 B	<b>0 986 437 414</b>



**BAW**

1111010-55D	<b>0 445 010 158</b>
-------------	----------------------

**BENTLEY**

057130755AL	<b>0 445 010 826</b>
07D 906 461	<b>0 986 280 222</b>

**BERLIET**

25 851 058	<b>0 432 291 819</b>
------------	----------------------

**BERU**

0 135 100 210	<b>0 432 193 693</b>
0 135 100 210	<b>0 432 193 695</b>
0 135 200 040	<b>0 432 193 746</b>

0 135 200 056	<b>0 432 193 786</b>
0 135 200 201	<b>0 432 193 837</b>
0 135 200 205	<b>0 432 193 768</b>
0 135 200 206	<b>0 432 193 621</b>

**BFCEC (BEIJING FOTON CUMM.)**

4990601	<b>0 445 020 119</b>
5264272	<b>0 445 120 297</b>

5283275	<b>0 445 120 134</b>
---------	----------------------

**BHARATBENZ**

A4000700287	<b>0 445 110 716</b>
-------------	----------------------

**BMW**

11788579894	<b>0 444 025 029</b>
13 51 1 460 447	<b>0 986 280 083</b>
13 51 2 242 200	<b>0 986 440 518</b>

13 51 2 242 864	<b>0 986 440 518</b>
13 51 2 244 025	<b>0 986 440 517</b>
13 51 2 244 518	<b>0 986 440 517</b>
13 51 2 244 539	<b>0 986 440 517</b>
13 51 2 244 966	<b>0 460 406 994</b>

13 51 2 244 966	<b>0 986 440 516</b>
13 51 2 245 206	<b>0 460 406 994</b>
13 51 2 245 206	<b>0 986 440 516</b>
13 51 2 245 733	<b>0 986 440 515</b>
13 51 2 245 735	<b>0 986 440 515</b>

13 51 2 245 810	<b>0 432 217 278</b>
13 51 2 245 810	<b>0 986 430 302</b>
13 51 2 245 812	<b>0 460 494 995</b>
13 51 2 245 812	<b>0 986 440 538</b>
13 51 2 245 813	<b>0 460 494 995</b>

13 51 2 246 082	<b>0 432 217 278</b>
13 51 2 246 826	<b>0 470 504 005</b>
13 51 2 246 826	<b>0 986 444 004</b>
13 51 2 247 416	<b>0 470 504 005</b>
13 51 2 247 416	<b>0 986 444 004</b>

13 51 2 247 798	<b>0 445 010 009</b>
13 51 2 247 798	<b>0 986 437 004</b>
13 51 2 247 801	<b>0 445 010 011</b>
13 51 2 247 801	<b>0 986 437 006</b>
13 51 2 249 967	<b>0 445 010 009</b>

13 51 2 249 967	<b>0 986 437 004</b>
13 51 2 249 999	<b>0 445 010 012</b>
13 51 3 465 678	<b>0 445 010 755</b>
13 51 3 465 678	<b>0 986 437 457</b>
13 51 4 732 845	<b>0 445 010 665</b>

13 51 4 740 611	<b>0 445 010 558</b>
13 51 4 740 611	<b>0 986 437 426</b>
13 51 4 740 612	<b>0 445 010 547</b>
13 51 4 740 613	<b>0 445 010 553</b>
13 51 4 740 613	<b>0 986 437 424</b>

13 51 7 785 434	<b>0 445 010 012</b>
13 51 7 785 434	<b>0 986 437 313</b>
13 51 7 785 895	<b>0 986 437 313</b>
13 51 7 786 016	<b>0 445 010 012</b>
13 51 7 786 016	<b>0 986 437 313</b>

13 51 7 786 091	<b>0 470 504 020</b>
13 51 7 786 091	<b>0 986 444 019</b>
13 51 7 786 288	<b>0 470 504 020</b>
13 51 7 787 199	<b>0 445 010 045</b>
13 51 7 787 199	<b>0 986 437 323</b>

13 51 7 787 513	<b>0 470 504 025</b>
13 51 7 787 513	<b>0 986 444 035</b>
13 51 7 787 514	<b>0 470 504 005</b>
13 51 7 787 514	<b>0 986 444 004</b>
13 51 7 787 515	<b>0 470 504 025</b>

13 51 7 787 515	<b>0 986 444 035</b>
13 51 7 787 532	<b>0 470 504 020</b>
13 51 7 787 532	<b>0 986 444 019</b>
13 51 7 787 562	<b>0 470 504 005</b>
13 51 7 787 562	<b>0 986 444 004</b>

13 51 7 787 563	<b>0 445 010 009</b>
13 51 7 787 563	<b>0 986 437 004</b>
13 51 7 787 632	<b>0 445 010 009</b>
13 51 7 787 632	<b>0 986 437 004</b>
13 51 7 788 798	<b>0 445 010 074</b>

13 51 7 788 798	<b>0 986 437 314</b>
13 51 7 788 799	<b>0 445 010 074</b>
13 51 7 788 933	<b>0 445 010 073</b>
13 51 7 788 933	<b>0 986 437 320</b>
13 51 7 789 843	<b>0 986 437 314</b>

13 51 7 791 782	<b>0 445 010 074</b>
13 51 7 791 782	<b>0 986 437 314</b>
13 51 7 793 650	<b>0 445 010 108</b>
13 51 7 793 650	<b>0 986 437 315</b>
13 51 7 793 651	<b>0 445 010 108</b>

13 51 7 793 651	<b>0 986 437 315</b>
13 51 7 795 713	<b>0 445 010 126</b>
13 51 7 795 713	<b>0 986 437 323</b>
13 51 7 795 714	<b>0 445 010 126</b>
13 51 7 795 714	<b>0 986 437 323</b>

13 51 7 797 413	<b>0 445 010 045</b>
13 51 7 797 413	<b>0 445 010 126</b>
13 51 7 797 413	<b>0 986 437 323</b>
13 51 7 797 414	<b>0 445 010 073</b>
13 51 7 797 414	<b>0 986 437 320</b>

13 51 7 797 874	<b>0 445 010 580</b>
13 51 7 797 874	<b>0 986 437 402</b>
13 51 7 797 876	<b>0 445 010 580</b>
13 51 7 797 876	<b>0 986 437 402</b>
13 51 7 800 123	<b>0 445 010 688</b>

13 51 7 800 593	<b>0 445 010 688</b>
13 51 7 800 593	<b>0 986 437 427</b>
13 51 7 801 055	<b>0 445 010 581</b>
13 51 7 801 055	<b>0 986 437 455</b>
13 51 7 804 409	<b>0 445 010 194</b>

13 51 7 805 419	<b>0 445 010 665</b>
13 51 7 805 420	<b>0 445 010 665</b>
13 51 7 805 420	<b>0 986 437 428</b>
13 51 7 805 522	<b>0 445 010 126</b>
13 51 7 805 522	<b>0 986 437 323</b>

13 51 7 805 523	<b>0 445 010 073</b>
13 51 7 805 523	<b>0 986 437 320</b>
13 51 7 805 525	<b>0 445 010 012</b>
13 51 7 805 526	<b>0 445 010 074</b>
13 51 7 805 527	<b>0 445 010 108</b>

13 51 7 807 288	<b>0 445 010 126</b>
13 51 7 807 288	<b>0 986 437 323</b>
13 51 7 807 833	<b>0 445 010 582</b>
13 51 7 807 833	<b>0 986 437 406</b>
13 51 7 810 697	<b>0 445 010 553</b>

13 51 7 810 697	<b>0 986 437 424</b>
13 51 7 812 051	<b>0 445 010 580</b>
13 51 7 812 051	<b>0 986 437 402</b>
13 51 7 812 052	<b>0 445 010 582</b>
13 51 7 812 052	<b>0 986 437 406</b>

13 51 7 812 053	<b>0 445 010 581</b>
13 51 7 812 053	<b>0 986 437 455</b>
13 51 7 823 452	<b>0 445 010 554</b>
13 51 7 823 453	<b>0 445 010 554</b>
13 51 7 823 453	<b>0 986 437 425</b>

13 51 7 823 457	<b>0 445 010 561</b>
13 51 7 823 457	<b>0 986 437 401</b>
13 51 8 472 282	<b>0 445 010 767</b>
13 51 8 508 152	<b>0 445 010 672</b>
13 51 8 508 152	<b>0 986 437 458</b>

13 51 8 509 950	<b>0 445 010 547</b>
13 51 8 509 951	<b>0 445 010 547</b>
13 51 8 510 865	<b>0 445 010 558</b>
13 51 8 510 865	<b>0 986 437 426</b>
13 51 8 510 866	<b>0 445 010 558</b>

13 51 8 510 866	<b>0 986 437 426</b>
13 51 8 511 626	<b>0 445 010 587</b>
13 51 8 511 626	<b>0 986 437 452</b>
13 51 8 511 627	<b>0 445 010 587</b>
13 51 8 511 627	<b>0 986 437 452</b>

13 51 8 511 824	<b>0 445 010 126</b>
13 51 8 511 824	<b>0 986 437 323</b>
13 51 8 511 825	<b>0 445 010 194</b>
13 51 8 514 135	<b>0 445 010 828</b>
13 51 8 514 139	<b>0 445 010 732</b>

13 51 8 515 058	<b>0 445 010 572</b>
13 51 8 515 058	<b>0 986 437 403</b>
13 51 8 515 059	<b>0 445 010 572</b>
13 51 8 515 059	<b>0 986 437 403</b>
13 51 8 517 556	<b>0 445 010 818</b>

13 51 8 571 796	<b>0 445 010 553</b>
13 51 8 571 796	<b>0 445 010 573</b>
13 51 8 571 796	<b>0 986 437 424</b>
13 51 8 573 160	<b>0 445 010 667</b>
13 51 8 573 160	<b>0 986 437 429</b>

13 51 8 573 161	<b>0 445 010 668</b>
13 51 8 573 161	<b>0 986 437 453</b>
13 51 8 573 162	<b>0 445 010 667</b>
13 51 8 573 162	<b>0 445 010 678</b>
13 51 8 573 162	<b>0 986 437 429</b>

13 51 8 573 249	<b>0 445 010 554</b>
13 51 8 573 249	<b>0 986 437 425</b>
13 51 8 573 250	<b>0 445 010 572</b>
13 51 8 573 250	<b>0 986 437 403</b>
13 51 8 576 514	<b>0 445 010 554</b>

13 51 8 576 514	<b>0 986 437 425</b>
13 51 8 576 515	<b>0 445 010 572</b>
13 51 8 576 515	<b>0 986 437 403</b>
13 51 8 577 643	<b>0 445 010 580</b>
13 51 8 577 643	<b>0 986 437 402</b>

13 51 8 577 644	<b>0 445 010 581</b>
13 51 8 577 644	<b>0 986 437 455</b>
13 51 8 577 645	<b>0 445 010 547</b>
13 51 8 577 646	<b>0 445 010 582</b>
13 51 8 577 646	<b>0 986 437 406</b>

13 51 8 577 647	<b>0 445 010 558</b>
13 51 8 577 647	<b>0 986 437 426</b>
13 51 8 577 648	<b>0 445 010 554</b>
13 51 8 577 648	<b>0 986 437 425</b>
13 51 8 577 649	<b>0 445 010 554</b>

13 51 8 577 649	<b>0 986 437 425</b>
13 51 8 577 650	<b>0 445 010 572</b>
13 51 8 577 650	<b>0 986 437 403</b>
13 51 8 577 651	<b>0 445 010 572</b>
13 51 8 577 651	<b>0 986 437 403</b>





◀ BMW

1351 8577 653	<b>0 445 010 561</b>
1351 8577 653	<b>0 986 437 401</b>
1351 8577 654	<b>0 445 010 688</b>
1351 8577 654	<b>0 986 437 427</b>
1351 8577 655	<b>0 445 010 665</b>

1351 8577 655	<b>0 986 437 428</b>
1351 8577 657	<b>0 445 010 668</b>
1351 8577 657	<b>0 986 437 453</b>
1351 8579 228	<b>0 445 010 776</b>
1351 8579 229	<b>0 445 010 776</b>

1351 8579 230	<b>0 445 010 774</b>
1351 8579 231	<b>0 445 010 774</b>
1351 8594 560	<b>0 445 010 792</b>
1351 8597 647	<b>0 445 010 767</b>
1351 8597 648	<b>0 445 010 769</b>

1351 8597 649	<b>0 445 010 840</b>
1351 8597 650	<b>0 445 010 856</b>
1351 8597 819	<b>0 445 010 794</b>
1351 8597 820	<b>0 445 010 784</b>
1351 8597 821	<b>0 445 010 852</b>

1351 8597 822	<b>0 445 010 854</b>
1351 8597 823	<b>0 445 010 848</b>
1351 9068 820	<b>0 460 406 994</b>
1351 9068 820	<b>0 986 440 516</b>
1351 9070 766	<b>0 986 440 517</b>

1351 9070 769	<b>0 986 440 515</b>
1351 9070 770	<b>0 460 406 994</b>
1351 9070 770	<b>0 986 440 516</b>
1353 2241 187	<b>0 432 217 185</b>
1353 2241 188	<b>0 986 430 176</b>

1353 2242 187	<b>0 432 217 185</b>
1353 2242 188	<b>0 986 430 176</b>
1353 2243 409	<b>0 432 217 223</b>
1353 2243 409	<b>0 986 430 241</b>
1353 2243 410	<b>0 432 217 236</b>

1353 2244 401	<b>0 986 430 241</b>
1353 2244 402	<b>0 432 217 236</b>
1353 2244 641	<b>0 432 217 185</b>
1353 2244 642	<b>0 986 430 176</b>
1353 2245 811	<b>0 432 217 279</b>

1353 2246 082	<b>0 986 430 302</b>
1353 2246 083	<b>0 432 217 279</b>
1353 2246 828	<b>0 432 191 528</b>
1353 2246 829	<b>0 432 191 527</b>
1353 2247 365	<b>0 986 435 010</b>

1353 2247 689	<b>0 432 191 528</b>
1353 2247 866	<b>0 986 435 009</b>
1353 2248 880	<b>0 986 435 011</b>
1353 2354 000	<b>0 445 110 028</b>
1353 2354 000	<b>0 986 435 009</b>

1353 2354 045	<b>0 445 110 030</b>
1353 2354 045	<b>0 986 435 011</b>
1353 2354 093	<b>0 445 110 029</b>
1353 2354 093	<b>0 986 435 010</b>
1353 4701 464	<b>0 986 435 022</b>

1353 4741 061	<b>0 445 110 601</b>
1353 7749 652	<b>0 986 435 151</b>
1353 7785 437	<b>0 445 110 029</b>
1353 7785 437	<b>0 986 435 010</b>
1353 7785 438	<b>0 445 110 028</b>

1353 7785 438	<b>0 986 435 009</b>
1353 7785 573	<b>0 445 110 047</b>
1353 7785 573	<b>0 445 110 266</b>
1353 7785 573	<b>0 986 435 022</b>
1353 7785 574	<b>0 445 110 048</b>

1353 7785 574	<b>0 986 435 094</b>
1353 7785 983	<b>0 445 110 049</b>
1353 7785 983	<b>0 986 435 095</b>
1353 7785 984	<b>0 445 110 047</b>
1353 7785 984	<b>0 445 110 266</b>

1353 7785 984	<b>0 986 435 022</b>
1353 7785 985	<b>0 445 110 048</b>
1353 7785 985	<b>0 986 435 094</b>
1353 7786 870	<b>0 432 191 398</b>
1353 7786 871	<b>0 432 191 401</b>

1353 7786 872	<b>0 432 191 398</b>
1353 7786 873	<b>0 432 191 401</b>
1353 7787 185	<b>0 445 010 045</b>
1353 7787 185	<b>0 986 437 323</b>
1353 7787 187	<b>0 445 110 080</b>

1353 7787 187	<b>0 445 110 131</b>
1353 7787 187	<b>0 986 435 084</b>
1353 7787 234	<b>0 445 110 080</b>
1353 7787 234	<b>0 445 110 131</b>
1353 7787 234	<b>0 986 435 084</b>

1353 7788 609	<b>0 445 110 080</b>
1353 7788 609	<b>0 445 110 131</b>
1353 7788 609	<b>0 986 435 084</b>
1353 7788 812	<b>0 445 110 122</b>
1353 7788 954	<b>0 445 110 122</b>

1353 7789 573	<b>0 445 110 130</b>
1353 7789 573	<b>0 986 435 096</b>
1353 7789 661	<b>0 445 110 131</b>
1353 7789 661	<b>0 986 435 084</b>
1353 7789 670	<b>0 445 110 131</b>

1353 7789 670	<b>0 986 435 084</b>
1353 7790 093	<b>0 445 110 216</b>
1353 7790 093	<b>0 986 435 091</b>
1353 7790 117	<b>0 986 435 144</b>
1353 7790 629	<b>0 986 435 157</b>

1353 7790 630	<b>0 445 110 149</b>
1353 7790 630	<b>0 986 435 157</b>
1353 7791 545	<b>0 986 435 151</b>
1353 7792 096	<b>0 986 435 092</b>
1353 7792 721	<b>0 445 115 070</b>

1353 7793 030	<b>0 445 110 219</b>
1353 7793 030	<b>0 986 435 092</b>
1353 7793 652	<b>0 445 115 009</b>
1353 7793 652	<b>0 986 435 421</b>
1353 7793 836	<b>0 445 110 216</b>

1353 7793 836	<b>0 986 435 091</b>
1353 7794 334	<b>0 445 110 216</b>
1353 7794 334	<b>0 986 435 091</b>
1353 7794 343	<b>0 445 115 008</b>
1353 7794 434	<b>0 986 435 151</b>

1353 7794 435	<b>0 986 435 144</b>
1353 7794 555	<b>0 445 110 209</b>
1353 7794 555	<b>0 986 435 144</b>
1353 7794 652	<b>0 445 110 212</b>
1353 7794 652	<b>0 986 435 151</b>

1353 7794 919	<b>0 445 110 212</b>
1353 7794 919	<b>0 986 435 151</b>
1353 7796 042	<b>0 986 435 359</b>
1353 7796 043	<b>0 986 435 359</b>
1353 7797 877	<b>0 445 116 001</b>

1353 7797 877	<b>0 986 435 363</b>
1353 7797 878	<b>0 445 116 001</b>
1353 7797 878	<b>0 986 435 363</b>
1353 7798 446	<b>0 445 110 289</b>
1353 7798 446	<b>0 445 110 600</b>

1353 7798 446	<b>0 445 110 601</b>
1353 7798 446	<b>0 986 435 179</b>
1353 7798 446	<b>0 986 435 245</b>
1353 7798 447	<b>0 445 110 289</b>
1353 7798 447	<b>0 445 110 600</b>

1353 7798 447	<b>0 445 110 601</b>
1353 7798 447	<b>0 986 435 179</b>
1353 7798 447	<b>0 986 435 245</b>
1353 7800 123	<b>0 986 437 427</b>
1353 7800 599	<b>0 445 117 001</b>

1353 7800 600	<b>0 445 117 001</b>
1353 7801 607	<b>0 445 115 008</b>
1353 7801 608	<b>0 445 115 009</b>
1353 7801 608	<b>0 986 435 421</b>
1353 7801 940	<b>0 986 435 354</b>

1353 7801 941	<b>0 445 115 009</b>
1353 7801 941	<b>0 986 435 421</b>
1353 7804 978	<b>0 445 110 259</b>
1353 7805 428	<b>0 445 116 024</b>
1353 7805 428	<b>0 986 435 394</b>

1353 7805 429	<b>0 445 116 024</b>
1353 7805 429	<b>0 986 435 394</b>
1353 7805 430	<b>0 445 117 017</b>
1353 7805 430	<b>0 986 435 411</b>
1353 7805 431	<b>0 445 117 017</b>

1353 7805 431	<b>0 986 435 411</b>
1353 7805 684	<b>0 445 115 009</b>
1353 7805 684	<b>0 986 435 421</b>
1353 7805 685	<b>0 445 115 008</b>
1353 7805 685	<b>0 986 435 354</b>

1353 7805 686	<b>0 986 435 359</b>
1353 7807 207	<b>0 445 115 009</b>
1353 7807 207	<b>0 986 435 421</b>
1353 7807 208	<b>0 445 115 070</b>
1353 7807 208	<b>0 986 435 354</b>

1353 7807 209	<b>0 986 435 359</b>
1353 7808 089	<b>0 445 115 077</b>
1353 7808 089	<b>0 986 435 359</b>
1353 7808 094	<b>0 445 115 077</b>
1353 7808 094	<b>0 986 435 359</b>

1353 7809 190	<b>0 445 116 001</b>
1353 7809 190	<b>0 986 435 363</b>
1353 7809 192	<b>0 445 115 009</b>
1353 7809 192	<b>0 986 435 421</b>
1353 7809 193	<b>0 445 115 070</b>

1353 7809 193	<b>0 986 435 354</b>
1353 7809 194	<b>0 986 435 359</b>
1353 7810 702	<b>0 445 110 382</b>
1353 7810 702	<b>0 445 110 478</b>
1353 7810 702	<b>0 445 110 479</b>

1353 7810 702	<b>0 445 110 480</b>
1353 7810 702	<b>0 445 110 596</b>
1353 7810 702	<b>0 445 110 616</b>
1353 7810 702	<b>0 445 110 617</b>
1353 7810 702	<b>0 986 435 207</b>

1353 7810 702	<b>0 986 435 244</b>
1353 7810 703	<b>0 445 110 382</b>
1353 7810 703	<b>0 445 110 478</b>
1353 7810 703	<b>0 986 435 207</b>
1353 7810 703	<b>0 986 435 244</b>

1353 7812 055	<b>0 445 117 001</b>
1353 7812 881	<b>0 445 110 289</b>
1353 7812 881	<b>0 445 110 600</b>
1353 7812 881	<b>0 445 110 601</b>
1353 7812 881	<b>0 986 435 179</b>

1353 7812 881	<b>0 986 435 245</b>
1353 7823 461	<b>0 445 117 030</b>
1353 7823 461	<b>0 986 435 425</b>
1353 7823 462	<b>0 445 117 030</b>
1353 7823 462	<b>0 986 435 425</b>

1353 8503 153	<b>0 445 118 001</b>
1353 8506 548	<b>0 445 110 597</b>
1353 8506 548	<b>0 986 435 256</b>
1353 8506 902	<b>0 445 110 401</b>
1353 8506 902	<b>0 445 110 600</b>

1353 8506 902	<b>0 986 435 210</b>
1353 8506 902	<b>0 986 435 245</b>
1353 8506 903	<b>0 445 110 401</b>
1353 8506 903	<b>0 445 110 600</b>
1353 8506 903	<b>0 986 435 210</b>

1353 8506 903	<b>0 986 435 245</b>
1353 8508 154	<b>0 445 118 001</b>
1353 8511 630	<b>0 445 110 598</b>
1353 8514 146	<b>0 445 110 613</b>
1353 8514 148	<b>0 445 110 570</b>

1353 8514 148	<b>0 445 110 712</b>
1353 8514 148	<b>0 986 435 261</b>
1353 8514 151	<b>0 445 118 004</b>
1353 8514 151	<b>0 445 118 022</b>
1353 8514 151	<b>0 445 118 036</b>



13538514151-05	<b>0 445 118 036</b>
13538515060	<b>0 445 110 503</b>
13538515061	<b>0 445 110 503</b>
13538515061	<b>0 445 110 599</b>
13538515061	<b>0 986 435 253</b>

1353851560	<b>0 986 435 253</b>
13538571563	<b>0 445 118 010</b>
13538571563	<b>0 445 118 018</b>
13538571563	<b>0 445 118 038</b>
13538571565	<b>0 445 118 005</b>

13538571565	<b>0 445 118 017</b>
13538571565	<b>0 445 118 023</b>
13538571795	<b>0 445 110 597</b>
13538571795	<b>0 986 435 256</b>
13538572474	<b>0 445 110 382</b>

13538572474	<b>0 445 110 478</b>
13538572474	<b>0 986 435 207</b>
13538572474	<b>0 986 435 244</b>
13538576298	<b>0 445 110 595</b>
13538576298	<b>0 445 110 617</b>

13538576298	<b>0 986 435 207</b>
13538576298	<b>0 986 435 244</b>
13538579232	<b>0 445 110 819</b>
13538579234	<b>0 445 110 818</b>
13538579236	<b>0 445 110 814</b>

13538579236	<b>0 445 111 009</b>
13617798413	<b>0 445 010 126</b>
13617798413	<b>0 986 437 323</b>
13621273238	<b>0 280 202 029</b>
13621276113	<b>0 280 203 014</b>

13621358915	<b>0 280 203 001</b>
13621403123	<b>0 280 217 806</b>
13621433565	<b>0 280 217 124</b>
13621433566	<b>0 280 217 533</b>
13621438687	<b>0 280 218 075</b>

13621718521	<b>0 986 280 111</b>
13621722489	<b>0 280 213 011</b>
13621722489	<b>0 986 280 116</b>
13621730074	<b>0 280 213 011</b>
13621730074	<b>0 986 280 116</b>

13621733678	<b>0 986 280 111</b>
13622247074	<b>0 928 400 527</b>
13624557557	<b>0 280 218 228</b>
13627501554	<b>0 280 218 077</b>
13627502055	<b>0 280 218 076</b>

13627524136	<b>0 280 218 135</b>
13627527518	<b>0 986 280 116</b>
13627527525	<b>0 986 280 111</b>
13627531702	<b>0 280 218 159</b>
13627537488	<b>0 280 218 169</b>

13627542418	<b>0 280 218 205</b>
13627566986	<b>0 280 218 075</b>
13627566987	<b>0 280 218 076</b>
13627566988	<b>0 280 218 135</b>
13627566989	<b>0 280 218 159</b>

13627566990	<b>0 280 218 169</b>
13627582337	<b>0 280 218 230</b>
13627582338	<b>0 280 218 234</b>
13627582553	<b>0 280 218 228</b>
13627787076	<b>0 928 400 527</b>

13627788743	<b>0 281 002 567</b>
13627788744	<b>0 928 400 529</b>
13627790657	<b>0 281 002 621</b>
13627791347	<b>0 281 002 621</b>
13627793633	<b>0 281 002 713</b>

13627801951	<b>0 281 002 849</b>
13627801951	<b>0 281 002 936</b>
13627805415	<b>0 281 002 936</b>
13627830359	<b>0 280 218 062</b>
13627839014	<b>0 280 218 062</b>

13628509725	<b>0 281 002 936</b>
13712247002	<b>0 928 400 527</b>
13712247592	<b>0 928 400 520</b>
16197244137	<b>F 01C 600 155</b>
16197244137	<b>F 01C 600 210</b>

16197351665	<b>F 01C 600 250</b>
16197351665	<b>F 01C 600 265</b>
18307807206	<b>0 444 021 013</b>
18308514448	<b>0 444 025 010</b>
2245813	<b>0 986 440 538</b>

2246828	<b>0 432 193 697</b>
2247365	<b>0 445 110 007</b>
2247690	<b>0 432 191 527</b>
2248440	<b>0 445 010 012</b>
2248880	<b>0 445 110 016</b>

3465678	<b>0 445 010 755</b>
3465678	<b>0 986 437 457</b>
4709397	<b>0 281 002 621</b>
4732841	<b>0 445 010 580</b>
4732841	<b>0 986 437 402</b>

4732842	<b>0 445 010 582</b>
4732842	<b>0 986 437 406</b>
4732843	<b>0 445 010 581</b>
4732844	<b>0 445 010 688</b>
4732844	<b>0 986 437 427</b>

4732845	<b>0 986 437 428</b>
4736481	<b>0 445 010 688</b>
4736481	<b>0 986 437 427</b>
4739997	<b>0 445 110 382</b>
4739997	<b>0 986 435 207</b>

4741061	<b>0 445 110 289</b>
4741061	<b>0 445 110 600</b>
4741061	<b>0 986 435 179</b>
4741061	<b>0 986 435 245</b>
4754903	<b>0 445 010 755</b>

4754903	<b>0 986 437 457</b>
4780105	<b>0 445 010 011</b>
4780105	<b>0 986 437 006</b>
7527518	<b>0 280 213 011</b>
7749652	<b>0 445 110 212</b>

7785125	<b>0 445 010 041</b>
7785685	<b>0 986 435 354</b>
7785895	<b>0 445 010 012</b>
7788670	<b>0 445 010 045</b>
7788670	<b>0 986 437 323</b>

7788678	<b>0 445 010 073</b>
7788678	<b>0 986 437 320</b>
7788812	<b>0 445 110 122</b>
7789843	<b>0 445 010 074</b>
7790092	<b>0 445 110 216</b>

7790117	<b>0 445 110 209</b>
7790629	<b>0 445 110 149</b>
7791518	<b>0 445 110 164</b>
7791545	<b>0 445 110 212</b>
7792096	<b>0 445 110 219</b>

7792097	<b>0 445 115 009</b>
7792097	<b>0 986 435 421</b>
7792721	<b>0 445 115 008</b>
7792721	<b>0 986 435 354</b>
7794434	<b>0 445 110 212</b>

7794435	<b>0 445 110 209</b>
7798111	<b>0 445 010 126</b>
7798111	<b>0 986 437 323</b>
7798333	<b>0 445 010 146</b>
7798333	<b>0 986 437 323</b>

7801000	<b>0 445 010 581</b>
7805419	<b>0 986 437 428</b>
7807495	<b>0 445 010 582</b>
7807495	<b>0 986 437 406</b>
7823452	<b>0 986 437 425</b>

7824028	<b>0 445 010 045</b>
7824028	<b>0 445 010 126</b>
7824028	<b>0 986 437 323</b>
7824029	<b>0 986 437 320</b>
8511821	<b>0 445 010 012</b>

8511826	<b>0 986 437 320</b>
8514138	<b>0 445 010 732</b>
8514148	<b>0 986 435 261</b>
8514148	<b>0 986 435 269</b>
8514151	<b>0 445 118 016</b>

8514151-05	<b>0 445 118 036</b>
8515058	<b>0 986 437 403</b>
8517556	<b>0 445 010 818</b>
8571556	<b>0 986 435 269</b>
8571563-04	<b>0 445 118 038</b>

8571565_04	<b>0 445 118 037</b>
8579236-03	<b>0 445 111 009</b>

<b>BOMAG</b>	
05714369	<b>0 432 291 752</b>
05714371	<b>0 432 291 753</b>
05714371	<b>0 986 430 067</b>

05714401	<b>0 432 291 807</b>
05714401	<b>0 986 430 124</b>
05717004	<b>0 432 227 027</b>
05717010	<b>0 432 191 878</b>
05717016	<b>0 432 291 699</b>

05725218	<b>0 432 291 838</b>
05726067	<b>0 432 297 023</b>
05726068	<b>0 432 297 024</b>
05726070	<b>0 432 291 650</b>

<b>BOMBARDIER</b>	
270600102	<b>F 00H K00 371</b>

<b>BOSCH</b>	
B444520086	<b>F 00B L0P 031</b>
B444540097	<b>F 00B L0P 037</b>
B444540109	<b>F 00B L0P 035</b>

B444550009	<b>F 00B L0P 029</b>
B444550016	<b>F 00B L0P 033</b>
F00B C00 042	<b>F 00B C00 041</b>
F00B C00 044	<b>F 00B C00 043</b>
F00B J00 002	<b>0 986 435 902</b>

F00B J00 004	<b>0 986 435 903</b>
F00B J00 006	<b>0 986 435 904</b>
F00B L0P 029	<b>0 986 437 917</b>
F00B L0P 031	<b>0 986 437 914</b>
F00B L0P 033	<b>0 986 437 918</b>

F00B L0P 035	<b>0 986 437 916</b>
F00B L0P 037	<b>0 986 437 915</b>
F00E 200 273	<b>0 445 117 008</b>
F00E 200 273	<b>0 986 435 409</b>
F00E 200 308	<b>F 00E 200 308</b>

F00E 200 390	<b>F 00E 200 431</b>
F00E 200 392	<b>F 00E 200 392</b>
F00E 200 392	<b>0 445 020 146</b>
F00E 200 392	<b>0 986 437 334</b>
F00E 200 401	<b>F 00E 200 401</b>

F00E 200 401	<b>0 986 445 102</b>
F00E 200 404	<b>F 00E 200 404</b>
F00E 200 412	<b>0 986 445 021</b>
F00E 200 423	<b>0 445 020 030</b>
F00E 200 427	<b>0 445 020 105</b>

F00E 200 433	<b>0 445 020 005</b>
F00E 200 440	<b>F 00E 200 440</b>
F00E 200 440	<b>0 986 435 128</b>
F00E 200 440	<b>0 986 435 263</b>
F00E 200 536	<b>0 986 441 028</b>

F00E 200 536	<b>0 986 441 029</b>
F00E 200 536	<b>0 986 441 031</b>
F00E 200 553	<b>0 986 435 518</b>
F00E 200 553	<b>0 986 435 519</b>
F00E 200 553	<b>0 986 435 573</b>





◀ BOSCH

F00E200553	<b>0986 435 574</b>
F00E200553	<b>0986 435 621</b>
F00TE0064N	<b>0445 110 101</b>
F00TE0064X	<b>0445 110 101</b>
F00TE0064Y	<b>0445 110 101</b>

F00TE0064Z	<b>0445 110 101</b>
F00TE0126X	<b>0445 110 290</b>
F00TE0126Y	<b>0445 110 290</b>
F00TE0126Z	<b>0445 110 290</b>
F00TE01851	<b>0445 110 283</b>

F00TE01852	<b>0445 110 283</b>
F00TE01853	<b>0445 110 283</b>
F00TE01861	<b>0445 110 279</b>
F00TE01862	<b>0445 110 279</b>
F00TE01863	<b>0445 110 279</b>

F00TE02231	<b>0445 110 222</b>
F00TE02232	<b>0445 110 222</b>
F00TE02233	<b>0445 110 222</b>
F01C600155	<b>F01C600194</b>
F01G001010	<b>0986 435 639</b>

0280200003	<b>0281 002 605</b>
0280200040	<b>0986 280 083</b>
0280212002	<b>0986 280 106</b>
0280212005	<b>0986 280 112</b>
0280212007	<b>0986 280 102</b>

0280212008	<b>0986 280 104</b>
0280212009	<b>0986 280 135</b>
0280212010	<b>0986 280 111</b>
0280212011	<b>0986 280 131</b>
0280212012	<b>0986 280 128</b>

0280212013	<b>0986 280 109</b>
0280212014	<b>0986 280 108</b>
0280212015	<b>0986 280 113</b>
0280212016	<b>0986 280 101</b>
0280212017	<b>0986 280 119</b>

0280212019	<b>0986 280 117</b>
0280212021	<b>0986 280 107</b>
0280212022	<b>0986 280 133</b>
0280212024	<b>0986 280 123</b>
0280212025	<b>0986 280 111</b>

0280213004	<b>0986 280 103</b>
0280213006	<b>0986 280 115</b>
0280213007	<b>0986 280 137</b>
0280213008	<b>0986 280 137</b>
0280213009	<b>0986 280 105</b>

0280213010	<b>0986 280 138</b>
0280213011	<b>0986 280 116</b>
0280213012	<b>0986 280 110</b>
0280213015	<b>0986 280 126</b>
0280213016	<b>0986 280 126</b>

0280213017	<b>0986 280 139</b>
0280213018	<b>0986 280 125</b>
0280213019	<b>0986 280 125</b>
0280213020	<b>0986 280 132</b>
0280213021	<b>0986 280 122</b>

0280213022	<b>0986 280 122</b>
0280213024	<b>0986 280 140</b>
0280213025	<b>0986 280 114</b>
0280214004	<b>0986 280 121</b>
0280214005	<b>0986 280 121</b>

0280217104	<b>0280 217 103</b>
0280217107	<b>0281 002 195</b>
0280217113	<b>0280 217 112</b>
0280217117	<b>0986 280 201</b>
0280217118	<b>0280 217 117</b>

0280217118	<b>0986 280 201</b>
0280217121	<b>0281 002 757</b>
0280217121	<b>0986 280 202</b>
0280217121	<b>0986 284 010</b>
0280217122	<b>0280 217 121</b>

0280217505	<b>0280 217 504</b>
0280217507	<b>0280 217 506</b>
0280217512	<b>0986 280 203</b>
0280217513	<b>0280 217 512</b>
0280217513	<b>0986 280 203</b>

0280217518	<b>0280 217 517</b>
0280217524	<b>0280 217 523</b>
0280217526	<b>0280 217 525</b>
0280217529	<b>0986 280 204</b>
0280217530	<b>0280 217 529</b>

0280217530	<b>0986 280 204</b>
0280217531	<b>0986 280 233</b>
0280217805	<b>0280 217 804</b>
0280217813	<b>0280 217 817</b>
0280218001	<b>0986 280 234</b>

0280218004	<b>0986 280 235</b>
0280218006	<b>0280 218 005</b>
0280218014	<b>0280 218 013</b>
0280218015	<b>0986 280 207</b>
0280218016	<b>0280 218 015</b>

0280218016	<b>0986 280 207</b>
0280218017	<b>0986 280 208</b>
0280218018	<b>0280 218 017</b>
0280218018	<b>0986 280 208</b>
0280218019	<b>0986 280 236</b>

0280218021	<b>0280 218 020</b>
0280218023	<b>0986 280 209</b>
0280218024	<b>0280 218 023</b>
0280218024	<b>0986 280 209</b>
0280218030	<b>0280 218 029</b>

0280218031	<b>0986 280 230</b>
0280218032	<b>0986 280 210</b>
0280218033	<b>0986 280 210</b>
0280218034	<b>0986 280 211</b>
0280218035	<b>0280 218 034</b>

0280218035	<b>0986 280 211</b>
0280218036	<b>0986 280 237</b>
0280218038	<b>0986 280 212</b>
0280218039	<b>0280 218 038</b>
0280218039	<b>0986 280 212</b>

0280218047	<b>0986 280 213</b>
0280218048	<b>0986 280 213</b>
0280218054	<b>0986 280 238</b>
0280218056	<b>0986 280 214</b>
0280218057	<b>0986 280 214</b>

0280218058	<b>0986 280 215</b>
0280218059	<b>0280 218 058</b>
0280218059	<b>0986 280 215</b>
0280218060	<b>0986 280 216</b>
0280218061	<b>0986 280 216</b>

0280218063	<b>0986 280 217</b>
0280218064	<b>0986 280 217</b>
0280218065	<b>0986 280 218</b>
0280218066	<b>0280 218 065</b>
0280218066	<b>0986 280 218</b>

0280218067	<b>0986 280 219</b>
0280218068	<b>0280 218 067</b>
0280218068	<b>0986 280 219</b>
0280218069	<b>0986 280 220</b>
0280218070	<b>0280 218 069</b>

0280218070	<b>0986 280 220</b>
0280218071	<b>0986 280 221</b>
0280218072	<b>0280 218 071</b>
0280218072	<b>0986 280 221</b>
0280218073	<b>0986 280 222</b>

0280218074	<b>0986 280 222</b>
0280218091	<b>0280 218 090</b>
0280218093	<b>0280 218 092</b>
0280218095	<b>0280 218 094</b>
0280218097	<b>0280 218 096</b>

0280218100	<b>0986 280 223</b>
0280218101	<b>0280 218 100</b>
0280218101	<b>0986 280 223</b>
0280218105	<b>0280 218 104</b>
0280218107	<b>0280 218 106</b>

0280218113	<b>0986 280 239</b>
0280218118	<b>0280 218 117</b>
0280218125	<b>0280 218 124</b>
0280218144	<b>0280 218 143</b>
0280218161	<b>0280 218 160</b>

0280218163	<b>0280 218 162</b>
0280218164	<b>0986 280 241</b>
0280218176	<b>0280 218 175</b>
0280218188	<b>0280 218 187</b>
0280218191	<b>0280 218 190</b>

0280218200	<b>0280 218 199</b>
0280218206	<b>0280 218 205</b>
0280218210	<b>0280 218 209</b>
0280218215	<b>0280 218 214</b>
0280218216	<b>0280 218 237</b>

0280218231	<b>0280 218 230</b>
0280218235	<b>0280 218 234</b>
0280218243	<b>0280 218 242</b>
0280218247	<b>0280 218 246</b>
0280218255	<b>0280 218 254</b>

0280218261	<b>0280 218 260</b>
0280218487	<b>0280 218 486</b>
0281001336	<b>0281 002 128</b>
0281002153	<b>0281 002 152</b>
0281002207	<b>0986 284 012</b>

0281002208	<b>0281 002 207</b>
0281002208	<b>0986 284 012</b>
0281002216	<b>0986 284 001</b>
0281002217	<b>0281 002 216</b>
0281002217	<b>0986 284 001</b>

0281002318	<b>0986 284 002</b>
0281002319	<b>0986 284 002</b>
0281002403	<b>0986 284 004</b>
0281002404	<b>0986 284 004</b>
0281002429	<b>0986 284 005</b>

0281002430	<b>0986 284 005</b>
0281002435	<b>0986 284 006</b>
0281002436	<b>0281 002 435</b>
0281002436	<b>0986 284 006</b>
0281002461	<b>0986 284 007</b>

0281002462	<b>0986 284 007</b>
0281002463	<b>0986 284 008</b>
0281002464	<b>0986 284 008</b>
0281002510	<b>0281 002 160</b>
0281002531	<b>0986 284 009</b>

0281002532	<b>0986 284 009</b>
0281002595	<b>0281 002 594</b>
0281002596	<b>0281 002 597</b>
0281002597	<b>0281 002 596</b>
0281002618	<b>0281 002 683</b>

0281002657	<b>0281 002 656</b>
0281002664	<b>0281 002 663</b>
0281002670	<b>0281 002 669</b>
0281002696	<b>0281 002 695</b>
0281002722	<b>0281 002 721</b>

0281002730	<b>0281 006 248</b>
0281002736	<b>0281 002 735</b>
0281002757	<b>0986 280 202</b>
0281002757	<b>0986 284 010</b>
0281002758	<b>0281 002 757</b>

0281002763	<b>0281 002 764</b>
0281002764	<b>0281 002 763</b>
0281002764	<b>0281 006 048</b>
0281002769	<b>0281 002 768</b>
0281002780	<b>0281 002 779</b>

0281002793	<b>0281 002 792</b>
0281002831	<b>0281 002 830</b>
0281002833	<b>0281 002 832</b>
0281002860	<b>0281 002 917</b>
0281002874	<b>0281 002 873</b>

0281002897	<b>0281 002 896</b>
0281002913	<b>0281 002 912</b>
0281002941	<b>0281 002 940</b>
0281002957	<b>0281 002 956</b>
0281002973	<b>0281 002 972</b>



0 281 002 979	<b>0 281 002 978</b>	0 444 022 033	<b>0 986 44D 115</b>	0 445 010 557	<b>0 986 437 405</b>	0 445 010 825	<b>0 445 010 824</b>
0 281 006 055	<b>0 281 006 054</b>	0 444 022 042	<b>0 986 44D 115</b>	0 445 010 560	<b>0 986 437 405</b>	0 445 010 846	<b>0 986 437 466</b>
0 281 006 057	<b>0 281 006 056</b>	0 444 022 043	<b>0 986 44D 115</b>	0 445 010 561	<b>0 986 437 401</b>	0 445 010 847	<b>0 445 010 846</b>
0 281 006 133	<b>0 281 006 132</b>	0 444 022 044	<b>0 986 44D 115</b>	0 445 010 564	<b>0 986 437 448</b>	0 445 010 847	<b>0 986 437 466</b>
0 414 700 006	<b>0 986 441 120</b>	0 444 022 047	<b>0 986 44D 115</b>	0 445 010 565	<b>0 986 437 405</b>	0 445 010 851	<b>0 986 437 422</b>
0 414 720 280	<b>0 986 441 575</b>	0 444 022 048	<b>0 986 44D 115</b>	0 445 010 566	<b>0 986 437 405</b>	0 445 020 005	<b>0 445 020 005</b>
0 414 799 001	<b>0 986 445 102</b>	0 444 022 049	<b>0 986 44D 115</b>	0 445 010 572	<b>0 986 437 403</b>	0 445 020 017	<b>0 445 020 017</b>
0 414 799 003	<b>0 986 445 103</b>	0 444 022 053	<b>0 986 44D 115</b>	0 445 010 575	<b>0 986 437 451</b>	0 445 020 037	<b>0 445 020 105</b>
0 414 799 004	<b>0 986 445 103</b>	0 444 022 054	<b>0 986 44D 115</b>	0 445 010 576	<b>0 986 437 449</b>	0 445 020 049	<b>0 986 437 387</b>
0 414 799 005	<b>0 986 445 102</b>	0 444 022 058	<b>0 986 44D 115</b>	0 445 010 577	<b>0 986 437 449</b>	0 445 020 054	<b>0 986 437 384</b>
0 414 799 006	<b>0 986 445 103</b>	0 444 022 066	<b>0 986 44D 115</b>	0 445 010 578	<b>0 986 437 445</b>	0 445 020 076	<b>F 00E 200 392</b>
0 414 799 007	<b>0 986 445 016</b>	0 444 022 068	<b>0 986 44D 119</b>	0 445 010 579	<b>0 986 437 445</b>	0 445 020 090	<b>0 986 437 383</b>
0 414 799 008	<b>0 986 445 103</b>	0 444 022 076	<b>0 444 022 027</b>	0 445 010 580	<b>0 986 437 402</b>	0 445 020 105	<b>0 445 020 105</b>
0 414 799 010	<b>0 986 445 056</b>	0 444 042 125	<b>0 444 042 124</b>	0 445 010 581	<b>0 986 437 455</b>	0 445 020 106	<b>F 00E 200 392</b>
0 414 799 011	<b>0 986 445 007</b>	0 444 042 136	<b>0 444 042 137</b>	0 445 010 586	<b>0 445 010 585</b>	0 445 020 124	<b>0 986 437 383</b>
0 414 799 011	<b>0 986 445 056</b>	0 444 043 017	<b>0 444 043 018</b>	0 445 010 587	<b>0 986 437 452</b>	0 445 020 135	<b>0 986 437 510</b>
0 414 799 012	<b>0 414 799 012</b>	0 444 043 134	<b>0 444 043 133</b>	0 445 010 591	<b>0 986 437 446</b>	0 445 020 170	<b>0 986 437 383</b>
0 414 799 012	<b>0 414 799 017</b>	0 444 043 199	<b>0 444 043 200</b>	0 445 010 592	<b>0 986 437 446</b>	0 445 020 202	<b>0 986 437 383</b>
0 414 799 012	<b>0 986 445 017</b>	0 445 010 098	<b>0 986 437 386</b>	0 445 010 594	<b>0 445 010 593</b>	0 445 020 249	<b>0 986 437 504</b>
0 414 799 013	<b>0 986 445 018</b>	0 445 010 107	<b>0 986 437 385</b>	0 445 010 595	<b>0 986 437 447</b>	0 445 020 277	<b>0 986 437 383</b>
0 414 799 013	<b>0 986 445 114</b>	0 445 010 131	<b>0 445 010 420</b>	0 445 010 596	<b>0 986 437 447</b>	0 445 110 003	<b>0 445 110 011</b>
0 414 799 014	<b>0 986 445 019</b>	0 445 010 211	<b>0 986 437 374</b>	0 445 010 597	<b>0 986 437 444</b>	0 445 110 004	<b>0 445 110 011</b>
0 414 799 015	<b>0 986 445 020</b>	0 445 010 246	<b>0 986 437 374</b>	0 445 010 598	<b>0 986 437 444</b>	0 445 110 005	<b>0 445 110 014</b>
0 414 799 017	<b>0 986 445 021</b>	0 445 010 260	<b>0 986 437 096</b>	0 445 010 631	<b>0 986 437 454</b>	0 445 110 006	<b>0 445 110 014</b>
0 414 799 018	<b>0 986 445 022</b>	0 445 010 265	<b>0 986 437 097</b>	0 445 010 632	<b>0 986 437 435</b>	0 445 110 009	<b>0 445 110 011</b>
0 414 799 019	<b>0 986 445 023</b>	0 445 010 266	<b>0 986 437 097</b>	0 445 010 638	<b>0 986 437 453</b>	0 445 110 010	<b>0 445 110 011</b>
0 414 799 020	<b>0 986 445 024</b>	0 445 010 307	<b>0 986 437 095</b>	0 445 010 641	<b>0 986 437 454</b>	0 445 110 010	<b>0 986 435 004</b>
0 414 799 021	<b>0 986 445 025</b>	0 445 010 319	<b>0 986 437 096</b>	0 445 010 642	<b>0 986 437 435</b>	0 445 110 011	<b>0 986 435 004</b>
0 414 799 022	<b>0 986 445 026</b>	0 445 010 320	<b>0 986 437 096</b>	0 445 010 644	<b>0 986 437 435</b>	0 445 110 012	<b>0 445 110 011</b>
0 414 799 024	<b>0 414 799 024</b>	0 445 010 322	<b>0 986 437 374</b>	0 445 010 649	<b>0 986 437 422</b>	0 445 110 012	<b>0 986 435 004</b>
0 414 799 024	<b>0 986 445 022</b>	0 445 010 323	<b>0 986 437 374</b>	0 445 010 657	<b>0 986 437 454</b>	0 445 110 015	<b>0 445 110 014</b>
0 414 799 025	<b>0 986 445 102</b>	0 445 010 397	<b>0 986 437 095</b>	0 445 010 658	<b>0 986 437 435</b>	0 445 110 024	<b>0 986 435 020</b>
0 414 799 026	<b>0 986 445 016</b>	0 445 010 424	<b>0 986 437 095</b>	0 445 010 668	<b>0 986 437 453</b>	0 445 110 025	<b>0 986 435 020</b>
0 414 799 027	<b>0 986 445 103</b>	0 445 010 425	<b>0 986 437 097</b>	0 445 010 671	<b>0 986 437 435</b>	0 445 110 033	<b>0 986 435 063</b>
0 414 799 028	<b>0 986 445 018</b>	0 445 010 426	<b>0 986 437 097</b>	0 445 010 676	<b>0 986 437 435</b>	0 445 110 034	<b>0 445 110 095</b>
0 414 799 029	<b>0 986 445 019</b>	0 445 010 457	<b>0 445 010 456</b>	0 445 010 677	<b>0 986 437 435</b>	0 445 110 034	<b>0 986 435 063</b>
0 414 799 030	<b>0 986 445 020</b>	0 445 010 466	<b>0 986 437 095</b>	0 445 010 682	<b>0 986 437 454</b>	0 445 110 035	<b>0 445 110 095</b>
0 414 799 032	<b>0 986 445 021</b>	0 445 010 507	<b>0 986 437 410</b>	0 445 010 683	<b>0 986 437 454</b>	0 445 110 045	<b>0 445 110 073</b>
0 414 799 033	<b>0 986 445 023</b>	0 445 010 508	<b>0 986 437 410</b>	0 445 010 684	<b>0 986 437 468</b>	0 445 110 046	<b>0 445 110 073</b>
0 414 799 035	<b>0 986 445 025</b>	0 445 010 509	<b>0 986 437 455</b>	0 445 010 687	<b>0 986 437 421</b>	0 445 110 064	<b>0 445 110 101</b>
0 431 YK2 276	<b>F 00B L0J 043</b>	0 445 010 514	<b>0 986 437 405</b>	0 445 010 692	<b>0 986 437 435</b>	0 445 110 069	<b>0 445 110 105</b>
0 432 217 231	<b>0 986 430 225</b>	0 445 010 522	<b>0 986 437 444</b>	0 445 010 693	<b>0 986 437 435</b>	0 445 110 069	<b>0 986 435 053</b>
0 432 217 232	<b>0 986 430 225</b>	0 445 010 523	<b>0 986 437 405</b>	0 445 010 704	<b>0 986 437 442</b>	0 445 110 069	<b>0 986 435 158</b>
0 432 281 873	<b>0 986 430 064</b>	0 445 010 526	<b>0 986 437 405</b>	0 445 010 734	<b>0 986 437 451</b>	0 445 110 070	<b>0 445 110 105</b>
0 444 011 028	<b>0 444 011 025</b>	0 445 010 527	<b>0 986 437 405</b>	0 445 010 738	<b>0 986 437 445</b>	0 445 110 070	<b>0 986 435 053</b>
0 444 022 002	<b>0 986 44D 119</b>	0 445 010 531	<b>0 986 437 448</b>	0 445 010 739	<b>0 986 437 445</b>	0 445 110 071	<b>0 445 110 099</b>
0 444 022 003	<b>0 986 44D 119</b>	0 445 010 532	<b>0 986 437 405</b>	0 445 010 740	<b>0 986 437 444</b>	0 445 110 071	<b>0 986 435 041</b>
0 444 022 004	<b>0 986 44D 119</b>	0 445 010 533	<b>0 986 437 405</b>	0 445 010 741	<b>0 986 437 444</b>	0 445 110 071	<b>0 986 435 061</b>
0 444 022 005	<b>0 986 44D 119</b>	0 445 010 543	<b>0 986 437 410</b>	0 445 010 754	<b>0 445 010 753</b>	0 445 110 072	<b>0 445 110 099</b>
0 444 022 014	<b>0 986 44D 127</b>	0 445 010 544	<b>0 986 437 431</b>	0 445 010 764	<b>0 986 437 452</b>	0 445 110 072	<b>0 986 435 041</b>
0 444 022 017	<b>0 986 44D 127</b>	0 445 010 546	<b>0 986 437 410</b>	0 445 010 772	<b>0 445 010 771</b>	0 445 110 072	<b>0 986 435 061</b>
0 444 022 020	<b>0 986 44D 127</b>	0 445 010 548	<b>0 986 437 448</b>	0 445 010 804	<b>0 445 010 810</b>	0 445 110 074	<b>0 445 110 073</b>
0 444 022 022	<b>0 986 44D 115</b>	0 445 010 549	<b>0 986 437 448</b>	0 445 010 804	<b>0 986 437 441</b>	0 445 110 081	<b>0 986 435 252</b>
0 444 022 023	<b>0 986 44D 115</b>	0 445 010 551	<b>0 986 437 405</b>	0 445 010 808	<b>0 986 437 453</b>	0 445 110 084	<b>0 986 435 173</b>
0 444 022 032	<b>0 986 44D 115</b>	0 445 010 556	<b>0 986 437 444</b>	0 445 010 810	<b>0 986 437 441</b>	0445110087	<b>0 986 435 235</b>



◀ BOSCH

0 445 110 087	<b>0 986 435 274</b>	0 445 110 129	<b>0 445 110 155</b>	0 445 110 265	<b>0 986 435 275</b>	0 445 110 391	<b>0 986 435 208</b>
0 445 110 089	<b>0 445 110 197</b>	0 445 110 141	<b>0 986 435 239</b>	0 445 110 274	<b>0 986 435 180</b>	0445110398	<b>0 986 435 247</b>
0 445 110 089	<b>0 986 435 059</b>	0 445 110 144	<b>0 986 435 097</b>	0 445 110 275	<b>0 986 435 180</b>	0 445 110 400	<b>0 986 435 209</b>
0 445 110 090	<b>0 445 110 197</b>	0 445 110 156	<b>0 445 110 155</b>	0 445 110 276	<b>0 986 435 148</b>	0 445 110 401	<b>0 986 435 210</b>
0 445 110 090	<b>0 986 435 059</b>	0 445 110 162	<b>0 986 435 109</b>	0 445 110 277	<b>0 986 435 181</b>	0 445 110 401	<b>0 986 435 245</b>
0 445 110 095	<b>0 445 110 201</b>	0 445 110 163	<b>0 986 435 109</b>	0 445 110 278	<b>0 986 435 181</b>	0 445 110 410	<b>0 986 435 279</b>
0 445 110 095	<b>0 986 435 012</b>	0 445 110 166	<b>0 986 435 117</b>	0 445 110 279	<b>0 986 435 182</b>	0 445 110 411	<b>0 986 435 279</b>
0 445 110 095	<b>0 986 435 063</b>	0 445 110 167	<b>0 986 435 117</b>	0 445 110 280	<b>0 986 435 192</b>	0 445 110 414	<b>0 986 435 211</b>
0 445 110 096	<b>0 445 110 095</b>	0 445 110 168	<b>0 986 435 175</b>	0 445 110 281	<b>0 986 435 193</b>	0 445 110 418	<b>0 986 435 212</b>
0 445 110 096	<b>0 445 110 201</b>	0 445 110 168	<b>0 986 435 293</b>	0 445 110 283	<b>0 986 435 183</b>	0 445 110 418	<b>0 986 435 248</b>
0 445 110 096	<b>0 986 435 012</b>	0 445 110 169	<b>0 986 435 176</b>	0 445 110 284	<b>0 986 435 290</b>	0 445 110 419	<b>0 986 435 213</b>
0 445 110 096	<b>0 986 435 063</b>	0 445 110 170	<b>0 445 110 181</b>	0 445 110 287	<b>0 986 435 277</b>	0 445 110 423	<b>0 986 435 237</b>
0 445 110 097	<b>0 445 110 203</b>	0 445 110 170	<b>0 986 435 053</b>	0 445 110 288	<b>0 986 435 194</b>	0 445 110 430	<b>0 986 435 214</b>
0 445 110 097	<b>0 986 435 012</b>	0 445 110 170	<b>0 986 435 164</b>	0 445 110 289	<b>0 986 435 179</b>	0 445 110 435	<b>0 986 435 227</b>
0 445 110 097	<b>0 986 435 037</b>	0 445 110 171	<b>0 445 110 170</b>	0 445 110 290	<b>0 986 435 174</b>	0 445 110 437	<b>0 986 435 190</b>
0 445 110 097	<b>0 986 435 055</b>	0 445 110 171	<b>0 445 110 181</b>	0 445 110 296	<b>0 986 435 194</b>	0 445 110 457	<b>0 986 435 254</b>
0 445 110 097	<b>0 986 435 063</b>	0 445 110 171	<b>0 986 435 053</b>	0 445 110 298	<b>0 986 435 195</b>	0 445 110 468	<b>0 986 435 258</b>
0 445 110 097	<b>0 986 435 065</b>	0 445 110 171	<b>0 986 435 164</b>	0 445 110 299	<b>0 986 435 230</b>	0 445 110 469	<b>0 445 110 468</b>
0 445 110 098	<b>0 445 110 203</b>	0 445 110 174	<b>0 986 435 105</b>	0 445 110 301	<b>0 986 435 278</b>	0 445 110 469	<b>0 986 435 258</b>
0 445 110 098	<b>0 986 435 055</b>	0 445 110 175	<b>0 986 435 089</b>	0 445 110 302	<b>0 986 435 184</b>	0 445 110 470	<b>0 986 435 257</b>
0 445 110 098	<b>0 986 435 065</b>	0 445 110 181	<b>0 986 435 053</b>	0 445 110 303	<b>0 986 435 184</b>	0 445 110 471	<b>0 986 435 257</b>
0 445 110 099	<b>0 445 110 199</b>	0 445 110 182	<b>0 445 110 181</b>	0 445 110 305	<b>0 986 435 231</b>	0 445 110 472	<b>0 986 435 259</b>
0 445 110 099	<b>0 986 435 041</b>	0 445 110 182	<b>0 986 435 053</b>	0 445 110 307	<b>0 986 435 196</b>	0 445 110 474	<b>0 986 435 242</b>
0 445 110 099	<b>0 986 435 061</b>	0 445 110 185	<b>0 986 435 183</b>	0 445 110 308	<b>0 986 435 197</b>	0 445 110 475	<b>0 986 435 242</b>
0 445 110 099	<b>0 986 435 071</b>	0 445 110 186	<b>0 986 435 182</b>	0 445 110 310	<b>0 986 435 296</b>	0 445 110 476	<b>0 986 435 241</b>
0 445 110 100	<b>0 445 110 099</b>	0 445 110 189	<b>0 986 435 055</b>	0 445 110 315	<b>0 986 435 198</b>	0 445 110 477	<b>0 986 435 241</b>
0 445 110 100	<b>0 445 110 199</b>	0 445 110 190	<b>0 445 110 189</b>	0 445 110 315	<b>0 986 435 291</b>	0 445 110 478	<b>0 986 435 207</b>
0 445 110 100	<b>0 986 435 041</b>	0 445 110 190	<b>0 986 435 055</b>	0 445 110 316	<b>0 986 435 226</b>	0 445 110 478	<b>0 986 435 244</b>
0 445 110 100	<b>0 986 435 061</b>	0 445 110 191	<b>0 986 435 113</b>	0 445 110 319	<b>0 986 435 186</b>	0 445 110 479	<b>0 986 435 244</b>
0 445 110 100	<b>0 986 435 071</b>	0 445 110 192	<b>0 986 435 113</b>	0 445 110 320	<b>0 986 435 186</b>	0 445 110 480	<b>0 986 435 244</b>
0 445 110 102	<b>0 986 435 106</b>	0 445 110 193	<b>0 986 435 127</b>	0 445 110 323	<b>0 986 435 187</b>	0 445 110 485	<b>0 986 435 240</b>
0 445 110 103	<b>0 986 435 069</b>	0 445 110 195	<b>0 986 435 057</b>	0 445 110 325	<b>0 986 435 199</b>	0 445 110 488	<b>0 986 435 288</b>
0 445 110 104	<b>0 986 435 069</b>	0 445 110 196	<b>0 445 110 195</b>	0 445 110 325	<b>0 986 435 200</b>	0 445 110 489	<b>0 445 110 488</b>
0 445 110 105	<b>0 445 110 170</b>	0 445 110 196	<b>0 986 435 057</b>	0 445 110 326	<b>0 986 435 200</b>	0 445 110 489	<b>0 986 435 288</b>
0 445 110 105	<b>0 986 435 045</b>	0 445 110 198	<b>0 445 110 197</b>	0 445 110 327	<b>0 986 435 201</b>	0 445 110 503	<b>0 986 435 253</b>
0 445 110 105	<b>0 986 435 053</b>	0 445 110 199	<b>0 986 435 041</b>	0 445 110 328	<b>0 986 435 188</b>	0 445 110 520	<b>0 986 435 212</b>
0 445 110 105	<b>0 986 435 164</b>	0 445 110 199	<b>0 986 435 061</b>	0 445 110 329	<b>0 986 435 232</b>	0 445 110 520	<b>0 986 435 248</b>
0 445 110 106	<b>0 445 110 105</b>	0 445 110 200	<b>0 445 110 199</b>	0 445 110 330	<b>0 986 435 232</b>	0 445 110 522	<b>0 986 435 251</b>
0 445 110 106	<b>0 445 110 170</b>	0 445 110 200	<b>0 986 435 041</b>	0 445 110 331	<b>0 986 435 298</b>	0 445 110 523	<b>0 986 435 262</b>
0 445 110 106	<b>0 986 435 045</b>	0 445 110 200	<b>0 986 435 061</b>	0 445 110 338	<b>0 986 435 202</b>	0 445 110 524	<b>0 986 435 280</b>
0 445 110 106	<b>0 986 435 053</b>	0 445 110 201	<b>0 986 435 063</b>	0 445 110 339	<b>0 986 435 172</b>	0 445 110 546	<b>0 986 435 273</b>
0 445 110 106	<b>0 986 435 158</b>	0 445 110 202	<b>0 445 110 201</b>	0 445 110 340	<b>0 986 435 203</b>	0 445 110 550	<b>0 986 435 276</b>
0 445 110 106	<b>0 986 435 164</b>	0 445 110 202	<b>0 986 435 063</b>	0 445 110 351	<b>0 986 435 204</b>	0 445 110 551	<b>0 986 435 276</b>
0 445 110 107	<b>0 445 110 189</b>	0 445 110 204	<b>0 445 110 203</b>	0 445 110 352	<b>0 986 435 233</b>	0 445 110 557	<b>0 986 435 297</b>
0 445 110 107	<b>0 986 435 055</b>	0 445 110 217	<b>F 00E 200 440</b>	0 445 110 368	<b>0 986 435 166</b>	0 445 110 564	<b>0 986 435 255</b>
0 445 110 108	<b>0 445 110 189</b>	0 445 110 217	<b>0 986 435 263</b>	0 445 110 369	<b>0 986 435 166</b>	0 445 110 570	<b>0 986 435 269</b>
0 445 110 108	<b>0 986 435 055</b>	0 445 110 218	<b>0 986 435 128</b>	0 445 110 373	<b>0 986 435 243</b>	0 445 110 573	<b>0 986 435 286</b>
0 445 110 115	<b>0 445 110 195</b>	0 445 110 221	<b>0 986 435 265</b>	0 445 110 374	<b>0 986 435 243</b>	0 445 110 595	<b>0 986 435 207</b>
0 445 110 115	<b>0 986 435 057</b>	0 445 110 227	<b>0 986 435 177</b>	0 445 110 375	<b>0 986 435 205</b>	0 445 110 595	<b>0 986 435 244</b>
0 445 110 116	<b>0 445 110 195</b>	0 445 110 243	<b>0 986 435 208</b>	0 445 110 375	<b>0 986 435 234</b>	0 445 110 596	<b>0 986 435 207</b>
0 445 110 116	<b>0 986 435 057</b>	0 445 110 249	<b>0 986 435 178</b>	0 445 110 377	<b>0 986 435 189</b>	0 445 110 596	<b>0 986 435 244</b>
0 445 110 120	<b>0 986 435 067</b>	0 445 110 250	<b>0 986 435 123</b>	0 445 110 378	<b>0 986 435 189</b>	0 445 110 597	<b>0 986 435 256</b>
0 445 110 121	<b>0 986 435 067</b>	0 445 110 259	<b>0 986 435 126</b>	0 445 110 381	<b>0 986 435 206</b>	0 445 110 599	<b>0 986 435 253</b>
0 445 110 126	<b>0 445 110 290</b>	0 445 110 262	<b>0 986 435 191</b>	0 445 110 382	<b>0 986 435 207</b>	0 445 110 600	<b>0 986 435 179</b>
0 445 110 128	<b>0 445 110 155</b>	0 445 110 265	<b>0 986 435 236</b>	0 445 110 382	<b>0 986 435 244</b>	0 445 110 600	<b>0 986 435 210</b>



0 445 110 600	<b>0 986 435 245</b>	0 445 115 046	<b>0 986 435 391</b>	0 445 116 053	<b>0 986 435 418</b>	0 445 118 017	<b>0 445 118 023</b>
0 445 110 601	<b>0 986 435 179</b>	0 445 115 059	<b>0 986 435 396</b>	0 445 116 054	<b>0 986 435 419</b>	0 445 120 003	<b>0 986 435 509</b>
0 445 110 613	<b>0 986 435 268</b>	0 445 115 060	<b>0 986 435 396</b>	0 445 116 056	<b>0 986 435 443</b>	0 445 120 003	<b>0 986 435 524</b>
0 445 110 614	<b>0 986 435 249</b>	0 445 115 061	<b>0 986 435 398</b>	0 445 116 057	<b>0 986 435 445</b>	0 445 120 004	<b>0 986 435 509</b>
0 445 110 616	<b>0 986 435 207</b>	0 445 115 062	<b>0 986 435 398</b>	0 445 116 058	<b>0 986 435 445</b>	0 445 120 004	<b>0 986 435 524</b>
0 445 110 616	<b>0 986 435 244</b>	0 445 115 065	<b>0 986 435 400</b>	0 445 116 059	<b>0 986 435 395</b>	0 445 120 006	<b>0 986 435 632</b>
0 445 110 617	<b>0 986 435 207</b>	0 445 115 066	<b>0 986 435 400</b>	0 445 116 065	<b>0 445 116 064</b>	0 445 120 007	<b>0 986 435 508</b>
0 445 110 617	<b>0 986 435 244</b>	0 445 115 067	<b>0 986 435 402</b>	0 445 116 072	<b>0 986 435 422</b>	0 445 120 008	<b>0 445 120 008</b>
0 445 110 634	<b>0 986 435 205</b>	0 445 115 068	<b>0 986 435 356</b>	0 445 116 073	<b>0 986 435 423</b>	0 445 120 014	<b>0 986 435 515</b>
0 445 110 639	<b>0 445 110 638</b>	0 445 115 069	<b>0 986 435 356</b>	0 445 116 074	<b>0 986 435 457</b>	0 445 120 015	<b>0 986 435 515</b>
0 445 110 646	<b>0 986 435 166</b>	0 445 115 070	<b>0 986 435 359</b>	0 445 117 001	<b>0 986 435 411</b>	0 445 120 025	<b>0 986 435 625</b>
0 445 110 647	<b>0 986 435 166</b>	0 445 115 073	<b>0 986 435 356</b>	0 445 117 003	<b>0 986 435 380</b>	0 445 120 027	<b>0 986 435 504</b>
0 445 110 664	<b>0 445 110 663</b>	0 445 115 074	<b>0 986 435 356</b>	0 445 117 004	<b>0 986 435 382</b>	0 445 120 028	<b>0 986 435 512</b>
0 445 110 682	<b>0 986 435 289</b>	0 445 115 076	<b>0 986 435 355</b>	0 445 117 005	<b>0 445 117 004</b>	0 445 120 029	<b>0 986 435 522</b>
0 445 110 689	<b>0 445 110 688</b>	0 445 115 080	<b>0 986 435 388</b>	0 445 117 005	<b>0 986 435 382</b>	0 445 120 035	<b>0 986 435 532</b>
0 445 110 712	<b>0 986 435 261</b>	0 445 115 081	<b>0 986 435 353</b>	0 445 117 008	<b>0 445 117 008</b>	0 445 120 036	<b>0 986 435 507</b>
0 445 110 712	<b>0 986 435 269</b>	0 445 115 082	<b>0 986 435 372</b>	0 445 117 008	<b>0 986 435 409</b>	0 445 120 042	<b>0 986 435 521</b>
0 445 110 724	<b>0 445 110 274</b>	0 445 115 083	<b>0 986 435 372</b>	0 445 117 010	<b>0 986 435 410</b>	0 445 120 045	<b>0 986 435 558</b>
0 445 110 725	<b>0 445 110 257</b>	0 445 115 084	<b>0 986 435 435</b>	0 445 117 011	<b>0 986 435 384</b>	0 445 120 050	<b>0 986 435 518</b>
0 445 110 726	<b>0 445 110 253</b>	0 445 115 086	<b>0 986 435 374</b>	0 445 117 012	<b>0 445 117 011</b>	0 445 120 053	<b>0 986 435 670</b>
0 445 110 727	<b>0 445 110 255</b>	0 445 115 087	<b>0 986 435 392</b>	0 445 117 012	<b>0 986 435 384</b>	0 445 120 054	<b>0 986 435 545</b>
0 445 110 729	<b>0 445 110 290</b>	0 445 115 087	<b>0 986 435 434</b>	0 445 117 013	<b>0 986 435 386</b>	0 445 120 055	<b>0 986 435 671</b>
0 445 110 730	<b>0 445 110 279</b>	0 445 115 088	<b>0 986 435 434</b>	0 445 117 014	<b>0 986 435 386</b>	0 445 120 056	<b>0 986 435 672</b>
0 445 110 731	<b>0 445 110 101</b>	0 445 116 001	<b>0 986 435 363</b>	0 445 117 017	<b>0 986 435 411</b>	0 445 120 057	<b>0 986 435 552</b>
0 445 110 743	<b>0 986 435 269</b>	0 445 116 002	<b>0 986 435 377</b>	0 445 117 018	<b>0 986 435 427</b>	0 445 120 058	<b>0 986 435 633</b>
0 445 110 795	<b>0 986 435 292</b>	0 445 116 003	<b>0 986 435 377</b>	0 445 117 019	<b>0 986 435 412</b>	0 445 120 059	<b>0 986 435 597</b>
0 445 110 797	<b>0 986 435 295</b>	0 445 116 006	<b>0 986 435 443</b>	0 445 117 020	<b>0 986 435 412</b>	0 445 120 062	<b>0 986 435 546</b>
0 445 110 831	<b>0 445 110 830</b>	0 445 116 009	<b>0 986 435 418</b>	0 445 117 021	<b>0 986 435 413</b>	0 445 120 063	<b>0 986 435 547</b>
0 445 110 856	<b>0 986 435 295</b>	0 445 116 010	<b>0 986 435 367</b>	0 445 117 022	<b>0 986 435 413</b>	0 445 120 065	<b>0 986 435 559</b>
0 445 110 857	<b>0 986 435 292</b>	0 445 116 011	<b>0 986 435 367</b>	0 445 117 023	<b>0 986 435 415</b>	0 445 120 066	<b>0 986 435 548</b>
0 445 110 870	<b>0 445 110 869</b>	0 445 116 012	<b>0 445 116 064</b>	0 445 117 024	<b>0 986 435 415</b>	0 445 120 067	<b>0 986 435 549</b>
0 445 110 872	<b>0 445 110 871</b>	0 445 116 012	<b>0 986 435 403</b>	0 445 117 026	<b>0 986 435 453</b>	0 445 120 068	<b>0 986 435 640</b>
0 445 110 874	<b>0 445 110 873</b>	0 445 116 013	<b>0 445 116 064</b>	0 445 117 027	<b>0 445 117 026</b>	0 445 120 071	<b>0 986 435 519</b>
0 445 110 876	<b>0 445 110 875</b>	0 445 116 013	<b>0 986 435 403</b>	0 445 117 027	<b>0 986 435 453</b>	0 445 120 073	<b>0 986 435 550</b>
0 445 110 877	<b>0 986 435 291</b>	0 445 116 016	<b>0 986 435 393</b>	0 445 117 028	<b>0 986 435 431</b>	0 445 120 074	<b>0 986 435 536</b>
0 445 110 880	<b>0 986 435 293</b>	0 445 116 017	<b>0 986 435 420</b>	0 445 117 029	<b>0 986 435 431</b>	0 445 120 075	<b>0 986 435 530</b>
0 445 110 881	<b>0 986 435 294</b>	0 445 116 018	<b>0 986 435 420</b>	0 445 117 030	<b>0 986 435 425</b>	0 445 120 082	<b>0 986 435 520</b>
0 445 110 883	<b>0 986 435 290</b>	0 445 116 019	<b>0 986 435 395</b>	0445117032	<b>0 986 435 432</b>	0 445 120 090	<b>0 986 435 634</b>
0 445 115 008	<b>0 986 435 354</b>	0 445 116 024	<b>0 986 435 394</b>	0 445 117 033	<b>0 986 435 432</b>	0 445 120 091	<b>0 986 435 635</b>
0 445 115 009	<b>0 986 435 421</b>	0 445 116 025	<b>0 986 435 404</b>	0 445 117 034	<b>0 986 435 428</b>	0 445 120 092	<b>0 986 435 551</b>
0 445 115 016	<b>0 986 435 355</b>	0 445 116 026	<b>0 986 435 404</b>	0 445 117 035	<b>0 986 435 428</b>	0 445 120 095	<b>0 986 435 636</b>
0 445 115 017	<b>0 986 435 355</b>	0 445 116 027	<b>0 986 435 406</b>	0 445 117 036	<b>0 986 435 414</b>	0 445 120 098	<b>0 986 435 562</b>
0 445 115 018	<b>0 986 435 388</b>	0 445 116 028	<b>0 986 435 406</b>	0 445 117 037	<b>0 986 435 439</b>	0 445 120 099	<b>0 986 435 563</b>
0 445 115 019	<b>0 986 435 353</b>	0 445 116 033	<b>0 986 435 430</b>	0 445 117 038	<b>0 986 435 451</b>	0 445 120 103	<b>0 986 435 505</b>
0 445 115 019	<b>0 986 435 388</b>	0 445 116 035	<b>0 986 435 369</b>	0 445 117 040	<b>0 986 435 433</b>	0 445 120 104	<b>0 986 435 540</b>
0 445 115 022	<b>0 986 435 390</b>	0 445 116 036	<b>0 986 435 408</b>	0 445 117 041	<b>0 986 435 441</b>	0 445 120 109	<b>0 986 435 637</b>
0 445 115 025	<b>0 986 435 450</b>	0445116037	<b>0 986 435 429</b>	0 445 117 042	<b>0 986 435 441</b>	0 445 120 112	<b>0 986 435 532</b>
0 445 115 032	<b>0 986 435 356</b>	0 445 116 039	<b>0 986 435 422</b>	0 445 117 043	<b>0 986 435 433</b>	0 445 120 114	<b>0 986 435 505</b>
0 445 115 033	<b>0 986 435 356</b>	0 445 116 040	<b>0 986 435 422</b>	0 445 117 044	<b>0 986 435 455</b>	0 445 120 120	<b>0 986 435 543</b>
0 445 115 040	<b>0 986 435 364</b>	0 445 116 041	<b>0 986 435 437</b>	0 445 117 049	<b>0 986 435 432</b>	0 445 120 121	<b>0 986 AD1 047</b>
0 445 115 041	<b>0 986 435 364</b>	0 445 116 043	<b>0 986 435 423</b>	0 445 117 050	<b>0 986 435 432</b>	0 445 120 125	<b>0 986 435 522</b>
0 445 115 042	<b>0 986 435 362</b>	0 445 116 044	<b>0 986 435 417</b>	0 445 117 063	<b>0 445 117 062</b>	0 445 120 135	<b>0 445 120 500</b>
0 445 115 043	<b>0 986 435 396</b>	0 445 116 045	<b>0 986 435 424</b>	0 445 117 078	<b>0 445 117 077</b>	0 445 120 135	<b>0 986 435 626</b>
0 445 115 044	<b>0 986 435 396</b>	0 445 116 046	<b>0 986 435 424</b>	0 445 117 080	<b>0 445 117 079</b>	0 445 120 137	<b>0 986 435 529</b>
0 445 115 045	<b>0 986 435 391</b>	0 445 116 052	<b>0 986 435 416</b>	0 445 118 016	<b>0 445 118 022</b>	0 445 120 138	<b>0 986 435 536</b>





◀ BOSCH

0 445 120 147	<b>0 986 435 562</b>
0 445 120 148	<b>0 986 435 563</b>
0 445 120 155	<b>0 986 435 569</b>
0 445 120 157	<b>0 986 435 564</b>
0 445 120 162	<b>0 986 435 565</b>

0 445 120 173	<b>0 986 435 677</b>
0 445 120 174	<b>0 986 435 677</b>
0 445 120 179	<b>0 986 435 566</b>
0 445 120 180	<b>0 986 435 567</b>
0 445 120 184	<b>0 986 435 519</b>

0 445 120 185	<b>0 986 435 518</b>
0 445 120 187	<b>F 00E 200 419</b>
0 445 120 187	<b>0 986 435 573</b>
0 445 120 188	<b>F 00E 200 420</b>
0 445 120 188	<b>0 986 435 574</b>

0 445 120 193	<b>0 986 435 518</b>
0 445 120 194	<b>0 986 435 642</b>
0 445 120 195	<b>0 986 435 642</b>
0 445 120 197	<b>0 986 435 569</b>
0 445 120 201	<b>0 986 435 656</b>

0 445 120 203	<b>0 986 435 658</b>
0 445 120 204	<b>0 986 435 519</b>
0 445 120 207	<b>0 986 435 540</b>
0 445 120 208	<b>0 986 435 505</b>
0 445 120 212	<b>0 986 435 508</b>

0 445 120 231	<b>0 986 435 597</b>
0 445 120 236	<b>0 986 435 522</b>
0 445 120 237	<b>0 986 435 555</b>
0 445 120 238	<b>0 986 435 505</b>
0 445 120 243	<b>0 986 435 638</b>

0 445 120 254	<b>F 00E 200 425</b>
0 445 120 254	<b>0 986 435 575</b>
0 445 120 255	<b>0 986 435 503</b>
0 445 120 256	<b>F 00E 200 435</b>
0 445 120 256	<b>0 986 435 576</b>

0 445 120 267	<b>0 986 435 644</b>
0 445 120 270	<b>0 986 435 598</b>
0 445 120 271	<b>0 986 435 598</b>
0 445 120 272	<b>0 986 435 532</b>
0 445 120 273	<b>0 986 435 571</b>

0 445 120 287	<b>0 986 435 624</b>
0 445 120 288	<b>0 986 435 624</b>
0 445 120 298	<b>0 986 435 622</b>
0 445 120 299	<b>0 986 435 622</b>
0 445 120 302	<b>0 986 435 646</b>

0 445 120 303	<b>0 445 120 302</b>
0 445 120 303	<b>0 986 435 646</b>
0 445 120 326	<b>0 986 435 541</b>
0 445 120 330	<b>0 986 435 542</b>
0 445 120 340	<b>0 986 435 547</b>

0 445 120 341	<b>0 986 435 592</b>
0 445 120 341	<b>0 986 435 593</b>
0 445 120 342	<b>0 986 435 621</b>
0 445 120 346	<b>0 986 435 662</b>
0 445 120 353	<b>0 986 435 593</b>

0 445 120 354	<b>0 986 435 650</b>
0 445 120 384	<b>0 986 435 644</b>
0 445 120 385	<b>0 986 435 647</b>
0 445 120 386	<b>0 986 435 647</b>
0 445 120 420	<b>0 986 435 660</b>

0 445 120 464	<b>0 986 435 632</b>
0 445 120 466	<b>0 986 435 633</b>
0 445 120 467	<b>0 986 435 637</b>
0 445 120 509	<b>0 445 120 508</b>
0 445 120 512	<b>0 986 435 677</b>

0 445 120 513	<b>0 986 435 677</b>
0 445 120 536	<b>0 445 120 535</b>
0 445 120 549	<b>0 445 120 548</b>
0 445 120 551	<b>0 445 120 550</b>
0 445 120 552	<b>0 986 435 677</b>

0 445 120 553	<b>0 445 120 552</b>
0 445 120 553	<b>0 986 435 677</b>
0 445 124 001	<b>0 986 435 572</b>
0 445 124 010	<b>0 986 435 577</b>
0 445 124 011	<b>0 986 435 577</b>

0 445 124 012	<b>0 986 435 578</b>
0 445 124 013	<b>0 986 435 578</b>
0 445 124 014	<b>0 986 435 655</b>
0 445 124 015	<b>0 986 435 663</b>
0 445 124 016	<b>0 986 435 652</b>

0 445 124 036	<b>0 986 435 674</b>
0 445 124 041	<b>0 986 435 572</b>
0 445 124 050	<b>0 445 124 049</b>
0 455 110 286	<b>0 986 435 266</b>
0 460 404 969	<b>0 460 404 969</b>

0 460 404 986	<b>0 460 404 969</b>
0 460 404 994	<b>0 460 404 971</b>
0 460 415 982	<b>0 986 440 576</b>
0 460 415 988	<b>0 986 440 577</b>
0 460 415 991	<b>0 986 440 578</b>

0 460 415 995	<b>0 986 440 580</b>
0 460 494 417	<b>0 986 440 257</b>
0 470 004 014	<b>0 986 444 516</b>
0 470 006 002	<b>0 986 444 517</b>
0 470 006 003	<b>0 986 444 518</b>

0 470 006 005	<b>0 470 006 005</b>
0 470 006 010	<b>0 986 444 518</b>
0 470 504 203	<b>0 470 504 218</b>
0 470 504 218	<b>0 470 504 218</b>
0 470 504 222	<b>0 470 504 218</b>

0 470 504 223	<b>0 470 504 218</b>
0 470 504 227	<b>0 470 504 218</b>
0 470 506 014	<b>0 986 444 009</b>
0 470 506 026	<b>0 986 444 024</b>
0 928 400 357	<b>0 928 400 520</b>

0 928 400 468	<b>0 928 400 527</b>
0 928 400 504	<b>0 928 400 529</b>
0 986 284 001	<b>0 281 002 216</b>
0 986 284 002	<b>0 281 002 318</b>
0 986 284 004	<b>0 281 002 403</b>

0 986 284 005	<b>0 281 002 429</b>
0 986 284 006	<b>0 281 002 435</b>
0 986 284 006	<b>0 986 284 006</b>
0 986 284 007	<b>0 281 002 461</b>
0 986 284 008	<b>0 281 002 463</b>

0 986 284 012	<b>0 281 002 207</b>
0 986 435 126	<b>0 986 435 126</b>
0 986 435 171	<b>0 986 435 171</b>
0 986 435 369	<b>0 986 435 369</b>
0 986 435 508	<b>0 445 120 212</b>

0 986 435 540	<b>0 986 435 540</b>
0 986 435 541	<b>0 445 120 043</b>
0 986 435 541	<b>0 445 120 326</b>
0 986 435 542	<b>0 445 120 089</b>
0 986 435 542	<b>0 445 120 330</b>

0 986 435 543	<b>0 445 120 120</b>
0 986 435 544	<b>0 445 120 140</b>
0 986 435 596	<b>0 445 120 330</b>
0 986 435 600	<b>0 445 120 327</b>
0 986 437 405	<b>0 986 437 405</b>

0 986 437 411	<b>0 986 437 405</b>
0 986 437 412	<b>0 986 437 405</b>
0 986 437 419	<b>0 986 437 405</b>
0 986 437 420	<b>0 986 437 405</b>
0 986 437 436	<b>0 986 437 405</b>

0 986 437 512	<b>0 986 437 512</b>
0 986 445 004	<b>0 414 755 003</b>
1 685 115 158	<b>1 682 666 411</b>

**BOSCH USA**

F 00E 200 549	<b>0 986 437 506</b>
0986435503	<b>0 986 435 503</b>
0986435505	<b>0 986 435 505</b>

**BOSCH WERK SALZGITTER**

044512018756241	<b>0 445 120 187</b>
044512018856241	<b>0 445 120 188</b>

044512019356241	<b>0 445 120 193</b>
044512020456241	<b>0 445 120 204</b>

**BOSCH-EXCHANGE**

F 00B C00 006	<b>0 986 437 910</b>
F 00B C00 008	<b>0 986 437 911</b>
F 00B C00 010	<b>0 986 437 912</b>

F 00E 200 404	<b>0 986 445 110</b>
F 00E 200 407	<b>F 00E 200 407</b>
F 00E 200 407	<b>0 414 799 012</b>
F 00E 200 407	<b>0 986 445 017</b>
F 00E 200 412	<b>F 00E 200 412</b>

F 00E 200 412	<b>0 414 799 017</b>
F 00E 200 413	<b>F 00E 200 413</b>
F 00E 200 413	<b>0 414 799 024</b>
F 00E 200 413	<b>0 986 445 022</b>
F 00E 200 431	<b>F 00E 200 431</b>

F 00E 200 433	<b>0 445 020 017</b>
F 00E 200 528	<b>0 986 44D 123</b>
F 00E 200 549	<b>0 445 020 126</b>
KBAL 100 S52	<b>0 986 430 141</b>
KBAL 100 S52	<b>0 986 430 203</b>

KBAL 100 S52	<b>0 986 430 333</b>
KBAL 100 S52	<b>0 986 430 336</b>
KBAL 100 S52	<b>0 986 430 337</b>
KBAL 100 S52	<b>0 986 430 338</b>
KBAL 116 S66	<b>0 986 430 169</b>

KBAL 116 S75	<b>0 986 430 301</b>
KBAL 65 S 13/13	<b>0 986 430 067</b>
KBAL 65 S 13/13	<b>0 986 430 124</b>
KBAL 96 P 35	<b>0 986 430 490</b>
KBEL 100 P 123	<b>0 986 430 352</b>

KBEL 100 P 202	<b>0 986 430 348</b>
KBEL 100 P64	<b>0 986 430 349</b>
KBEL 100 P64	<b>0 986 430 447</b>
KBEL 108 P51	<b>0 986 430 332</b>
KBEL 109 P 11/13	<b>0 986 430 034</b>

KBEL 109 P81	<b>0 986 430 256</b>
KBEL 109 S 6/13	<b>0 986 430 074</b>
KBEL 110 P 140	<b>0 986 430 522</b>
KBEL 117P 122	<b>0 986 430 369</b>
KBEL 117P 122	<b>0 986 430 370</b>

KBEL 117 P73	<b>0 986 430 250</b>
KBEL 117 P73	<b>0 986 430 263</b>
KBEL 117 P73	<b>0 986 430 353</b>
KBEL 117 P73	<b>0 986 430 354</b>
KBEL 117 P73	<b>0 986 430 359</b>

KBEL 117 P73	<b>0 986 430 366</b>
KBEL 117 P74	<b>0 986 430 000</b>
KBEL 117 P74	<b>0 986 430 001</b>
KBEL 117 P74	<b>0 986 430 032</b>
KBEL 117 P74	<b>0 986 430 164</b>

KBEL 117 P74	<b>0 986 430 165</b>
KBEL 117 P74	<b>0 986 430 166</b>
KBEL 117 P74	<b>0 986 430 167</b>
KBEL 48 P 38	<b>0 986 430 253</b>
KBEL 82 P 58	<b>0 986 430 367</b>

KBEL 95 P 9/ 4	<b>0 986 430 002</b>
KBEL 98P 101	<b>0 986 430 498</b>
KBEL 98P 102	<b>0 986 430 364</b>
KBEL 98P 102	<b>0 986 430 368</b>
KBEL 98P 102	<b>0 986 430 491</b>

KBEL 98P 102	<b>0 986 430 591</b>
KBEL 98P 102	<b>0 986 430 592</b>
KBEL 98P 221	<b>0 986 430 593</b>
KBEL 98 P 27	<b>0 986 430 162</b>
KBEL 98 P 27	<b>0 986 430 163</b>



KBEL 98 P 27	0 986 430 492	KCA 30 S 79	0 986 430 188	KDEL 80 P 33	0 986 430 325	0 414 702 008	0 986 441 905
KBEL 98 P 27	0 986 430 494	KCE 27 S 3	0 986 430 245	KDEL 80 P 33	0 986 430 326	0 414 702 009	0 986 441 109
KBEL 98 P 74	0 986 430 311	KCE 27 S 3	0 986 430 307	KDEL 80 P 33	0 986 430 327	0 414 702 010	0 986 441 106
KBEL 98 P 74	0 986 430 363	KCE 27 S 3	0 986 430 388	KDEL 80 P 33	0 986 430 361	0 414 703 002	0 986 441 028
KBEL 99 P 9/4	0 986 430 033	KCE 30 S 5	0 986 430 381	KDEL 80 P 33	0 986 430 378	0 414 703 003	0 986 441 029
KBE 58 S 4/4	0 986 430 144	KCE 30 S 6	0 986 430 371	KDEL 82 P 12	0 986 430 312	0 414 703 004	0 986 441 025
KBE 58 S 8	0 986 430 532	KDAL 74 S 21/19	0 986 430 046	KDEL 82 P 12	0 986 430 321	0 414 703 007	0 986 441 031
KBL 112 S 21/13	0 986 430 064	KDAL 74 S 21/19	0 986 430 055	KDEL 82 P 12	0 986 430 451	0 414 703 008	0 986 441 026
K BL 7 6S2 114	0 986 430 342	KDAL 74S 319	0 986 430 045	KDEL 82 P 18	0 986 430 252	0 414 703 009	0 986 441 027
KCA 15 S 66	0 986 430 198	KDAL 74S 319	0 986 430 046	KDEL 82 P 18	0 986 430 261	0 414 720 007	0 986 441 551
KCA 15 S 66	0 986 430 270	KDAL 74S 319	0 986 430 055	KDEL 82 P 18	0 986 430 362	0 414 720 009	0 986 441 552
KCA 17 S 38/4	0 986 430 010	K DAL 74S 319	0 986 430 056	KDEL 82 P 23	0 986 430 257	0 414 720 013	0 986 441 557
KCA 17 S 42	0 986 430 015	KDAL 74 S 44	0 986 430 178	KDEL 82 P 38	0 986 430 313	0 414 720 014	0 986 441 553
KCA 17 S 42	0 986 430 028	KDAL 74 S 44	0 986 430 210	KDEL 82 P 7	0 986 430 196	0 414 720 015	0 986 441 556
KCA 17 S 42	0 986 430 240	KDAL 74 S 44	0 986 430 214	KDEL 82 P 7	0 986 430 228	0 414 720 016	0 986 441 555
KCA 17 S 42	0 986 430 244	KDAL 74 S 44	0 986 430 221	KDEL 95 S 17	0 986 430 341	0 414 720 018	0 986 441 554
KCA 17 S 42	0 986 430 267	KDAL 80 S 14/14	0 986 430 038	KDEL 95 S 21	0 986 430 330	0 414 720 021	0 986 441 557
KCA 17 S 42	0 986 430 268	KDAL 80 S 14/14	0 986 430 042	KDEL 96 S 22	0 986 430 329	0 414 720 022	0 986 441 551
KCA 17 S 42	0 986 430 269	KDAL 80 S 14/14	0 986 430 053	KDEL 97 P 10	0 986 430 031	0 414 720 023	0 986 441 554
KCA 17 S 42	0 986 430 375	KDAL 80 S 20/19	0 986 430 159	KDEL 97 P 10	0 986 430 120	0 414 720 024	0 986 441 553
KCA 17 S 42	0 986 430 448	KDAL 80 S 42	0 986 430 038	KDEL 97 P 13	0 986 430 213	0 414 720 025	0 986 441 556
KCA 17 S 70	0 986 430 249	KDAL 80 S 42	0 986 430 042	KDEL 97 P 13	0 986 430 274	0 414 720 028	0 986 441 557
KCA 21 S 71	0 986 430 241	KDAL 80 S 42	0 986 430 053	KDEL 97 P 3	0 986 430 031	0 414 720 029	0 986 441 554
KCA 21 S 71	0 986 430 302	KDAL 80 S 42	0 986 430 168	KDEL 97 S 11	0 986 430 039	0 414 720 030	0 986 441 555
KCA 27 S 55	0 986 430 172	KDAL 80 S 46	0 986 430 133	KDEL 99 P 15	0 986 430 212	0 414 720 031	0 986 441 555
KCA 27 S 55	0 986 430 173	KDAL 80 S 46	0 986 430 205	KDEL 99 P 39	0 986 430 385	0 414 720 033	0 986 441 552
KCA 27 S 55	0 986 430 197	KDAL 80 S 46	0 986 430 211	KDEL 99 P 39	0 986 430 387	0 414 720 034	0 986 441 555
KCA 27 S 55	0 986 430 246	KDAL 80 S 47	0 986 430 038	KDEL 99 P 5	0 986 430 030	0 414 720 035	0 414 720 007
KCA 27 S 55	0 986 430 247	KDAL 80 S 47	0 986 430 042	K 444 540 039	F 00B C00 010	0 414 720 035	0 986 441 551
KCA 27 S 55	0 986 430 505	KDAL 80 S 47	0 986 430 053	R 806 938 4AA	0 986 435 518	0 414 720 036	0 986 441 553
KCA 27 S 77/	0 986 430 206	KDAL 80 S 47	0 986 430 133	0 280 218 005	0 986 280 232	0 414 720 037	0 986 441 556
KCA 27 S 77	0 986 430 206	KDAL 80 S 47	0 986 430 168	0 280 218 006	0 986 280 232	0 414 720 038	0 986 441 554
KCA 27 S 80	0 986 430 449	KDAL 80 S 47	0 986 430 205	0 280 218 051	0 986 280 231	0 414 720 039	0 986 441 557
KCA 27 S 81	0 986 430 243	KDAL 80 S 47	0 986 430 211	0 414 700 002	0 986 441 102	0 414 720 115	0 986 441 559
KCA 30 S 35/4	0 986 430 171	KDAL 80 S 47	0 986 430 360	0 414 700 003	0 986 441 112	0 414 720 201	0 986 441 560
KCA 30 S 36/4	0 986 430 080	KDAL 80 S 56	0 986 430 159	0 414 700 006	0 986 441 020	0 414 720 202	0 986 441 559
KCA 30 S 36/4	0 986 430 190	KDAL 80 S 59	0 986 430 507	0 414 700 009	0 986 441 112	0 414 720 204	0 986 441 560
KCA 30 S 36/4	0 986 430 235	KDAL 80 S 59	0 986 430 508	0 414 701 004	0 986 441 004	0 414 720 206	0 986 441 559
KCA 30 S 44	0 986 430 020	KDAL 80 S 63	0 986 430 092	0 414 701 005	0 986 441 101	0 414 720 208	0 986 441 559
KCA 30 S 44	0 986 430 022	KDAL 80 S 63	0 986 430 093	0 414 701 006	0 986 441 103	0 414 720 209	0 986 441 560
KCA 30 S 44	0 986 430 025	KDAL 80 S 63	0 986 430 094	0 414 701 007	0 986 441 107	0 414 720 210	0 986 441 561
KCA 30 S 44	0 986 430 026	KDAL 80 S 63	0 986 430 095	0 414 701 008	0 986 441 108	0 414 720 213	0 986 441 559
KCA 30 S 44	0 986 430 081	KDAL 80 S 63	0 986 430 563	0 414 701 013	0 986 441 113	0 414 720 214	0 986 441 560
KCA 30 S 44	0 986 430 089	K DEL 109 P47	0 986 430 382	0 414 701 017	0 986 441 114	0 414 720 215	0 986 441 559
KCA 30 S 44	0 986 430 184	K DEL 109 P62	0 986 430 390	0 414 701 019	0 986 441 115	0 414 720 216	0 986 441 560
KCA 30 S 44	0 986 430 189	KDEL 75 P 16	0 986 430 347	0 414 701 020	0 986 441 116	0 414 720 220	0 986 441 565
KCA 30 S 44	0 986 430 208	KDEL 75 P 20	0 986 430 450	0 414 701 044	0 414 701 066	0 414 720 221	0 986 441 562
KCA 30 S 44	0 986 430 225	KDEL 75 S 20	0 986 430 445	0 414 701 084	0 986 441 103	0 414 720 222	0 986 441 569
KCA 30 S 44	0 986 430 234	KDEL 77 P 59	0 986 430 511	0 414 702 002	0 986 441 005	0 414 720 223	0 986 441 570
KCA 30 S 44	0 986 430 304	KDEL 77 S 15	0 986 430 334	0 414 702 002	0 986 441 905	0 414 720 224	0 986 441 564
KCA 30 S 44	0 986 430 520	KDEL 77 S 15	0 986 430 344	0 414 702 003	0 986 441 106	0 414 720 225	0 986 441 563
KCA 30 S 46	0 986 430 151	KDEL 80 P 33	0 986 430 090	0 414 702 005	0 986 441 106	0 414 720 226	0 986 441 571
KCA 30 S 57	0 986 430 176	KDEL 80 P 33	0 986 430 091	0 414 702 006	0 986 441 110	0 414 720 227	0 986 441 572
KCA 30 S 70	0 986 430 249	KDEL 80 P 33	0 986 430 264	0 414 702 007	0 986 441 111	0 414 720 228	0 986 441 573
KCA 30 S 79	0 986 430 187	KDEL 80 P 33	0 986 430 265	0 414 702 008	0 986 441 005	0 414 720 229	0 986 441 574





◀ BOSCH-EXCHANGE

0 414 720 230	<b>0 986 441 575</b>
0 414 720 231	<b>0 986 441 560</b>
0 414 720 232	<b>0 986 441 564</b>
0 414 720 265	<b>0 986 441 559</b>
0 414 720 305	<b>0 986 441 576</b>

0 432 131 793	<b>0 986 430 362</b>
0 432 131 794	<b>0 986 430 252</b>
0 432 131 798	<b>0 986 430 261</b>
0 432 131 800	<b>0 986 430 264</b>
0 432 131 801	<b>0 986 430 265</b>

0 432 191 863	<b>0 986 430 032</b>
0 432 191 870	<b>0 986 430 033</b>
0 432 192 881	<b>0 986 430 034</b>
0 432 193 757	<b>0 986 430 522</b>
0 432 193 845	<b>0 986 430 256</b>

0 432 217 263	<b>0 986 430 267</b>
0 432 217 264	<b>0 986 430 190</b>
0 432 217 266	<b>0 986 430 247</b>
0 432 217 267	<b>0 986 430 304</b>
0 432 217 268	<b>0 986 430 381</b>

0 414 720 306	<b>0 986 441 567</b>
0 414 720 307	<b>0 986 441 568</b>
0 414 720 308	<b>0 986 441 577</b>
0 414 720 309	<b>0 986 441 578</b>
0 414 720 310	<b>0 986 441 579</b>

0 432 131 802	<b>0 986 430 378</b>
0 432 131 820	<b>0 986 430 257</b>
0 432 131 823	<b>0 986 430 450</b>
0 432 131 824	<b>0 986 430 212</b>
0 432 131 825	<b>0 986 430 213</b>

0 432 193 850	<b>0 986 430 253</b>
0 432 193 851	<b>0 986 430 253</b>
0 432 217 066	<b>0 986 430 171</b>
0 432 217 078	<b>0 986 430 080</b>
0 432 217 079	<b>0 986 430 080</b>

0 432 217 269	<b>0 986 430 371</b>
0 432 217 271	<b>0 986 430 187</b>
0 432 217 272	<b>0 986 430 187</b>
0 432 217 278	<b>0 986 430 302</b>
0 432 217 280	<b>0 986 430 388</b>

0 414 720 311	<b>0 986 441 576</b>
0 414 720 312	<b>0 986 441 567</b>
0 414 720 313	<b>0 986 441 568</b>
0 414 720 314	<b>0 986 441 577</b>
0 414 720 363	<b>0 986 441 568</b>

0 432 131 831	<b>0 986 430 228</b>
0 432 131 846	<b>0 986 430 274</b>
0 432 131 850	<b>0 986 430 031</b>
0 432 131 853	<b>0 986 430 196</b>
0 432 131 857	<b>0 986 430 321</b>

0 432 217 083	<b>0 986 430 081</b>
0 432 217 084	<b>0 986 430 081</b>
0 432 217 090	<b>0 986 430 010</b>
0 432 217 110	<b>0 986 430 089</b>
0 432 217 111	<b>0 986 430 015</b>

0 432 217 283	<b>0 986 430 206</b>
0 432 217 284	<b>0 986 430 206</b>
0 432 217 287	<b>0 986 430 307</b>
0 432 217 289	<b>0 986 430 375</b>
0 432 217 290	<b>0 986 430 505</b>

0 414 720 401	<b>0 986 441 580</b>
0 414 720 402	<b>0 986 441 580</b>
0 414 720 403	<b>0 986 441 580</b>
0 414 720 404	<b>0 986 441 566</b>
0 414 720 453	<b>0 986 441 580</b>

0 432 131 860	<b>0 986 430 196</b>
0 432 131 866	<b>0 986 430 228</b>
0 432 131 871	<b>0 986 430 120</b>
0 432 131 873	<b>0 986 430 030</b>
0 432 131 878	<b>0 986 430 031</b>

0 432 217 111	<b>0 986 430 028</b>
0 432 217 113	<b>0 986 430 089</b>
0 432 217 118	<b>0 986 430 089</b>
0 432 217 125	<b>0 986 430 151</b>
0 432 217 131	<b>0 986 430 022</b>

0 432 217 293	<b>0 986 430 520</b>
0 432 217 299	<b>0 986 430 449</b>
0 432 231 599	<b>0 986 430 563</b>
0 432 231 659	<b>0 986 430 095</b>
0 432 231 661	<b>0 986 430 092</b>

0 414 720 454	<b>0 986 441 566</b>
0 414 755 002	<b>0 986 445 001</b>
0 414 755 002	<b>0 986 445 004</b>
0 414 755 003	<b>0 986 445 004</b>
0 414 755 004	<b>0 986 445 005</b>

0 432 133 855	<b>0 986 430 313</b>
0 432 191 405	<b>0 986 430 593</b>
0 432 191 460	<b>0 986 430 592</b>
0 432 191 506	<b>0 986 430 591</b>
0 432 191 529	<b>0 986 430 491</b>

0 432 217 141	<b>0 986 430 025</b>
0 432 217 142	<b>0 986 430 020</b>
0 432 217 146	<b>0 986 430 026</b>
0 432 217 147	<b>0 986 430 184</b>
0 432 217 153	<b>0 986 430 028</b>

0 432 231 663	<b>0 986 430 093</b>
0 432 231 664	<b>0 986 430 094</b>
0 432 231 665	<b>0 986 430 205</b>
0 432 231 667	<b>0 986 430 330</b>
0 432 231 668	<b>0 986 430 329</b>

0 414 755 005	<b>0 986 445 005</b>
0 414 755 006	<b>0 986 445 008</b>
0 414 755 007	<b>0 986 445 008</b>
0 414 755 008	<b>0 986 445 013</b>
0 414 755 014	<b>0 986 445 011</b>

0 432 191 611	<b>0 986 430 370</b>
0 432 191 612	<b>0 986 430 369</b>
0 432 191 616	<b>0 986 430 348</b>
0 432 191 630	<b>0 986 430 349</b>
0 432 191 633	<b>0 986 430 352</b>

0 432 217 157	<b>0 986 430 197</b>
0 432 217 161	<b>0 986 430 172</b>
0 432 217 165	<b>0 986 430 190</b>
0 432 217 169	<b>0 986 430 173</b>
0 432 217 186	<b>0 986 430 176</b>

0 432 231 673	<b>0 986 430 507</b>
0 432 231 674	<b>0 986 430 508</b>
0 432 231 676	<b>0 986 430 360</b>
0 432 231 677	<b>0 986 430 211</b>
0 432 231 678	<b>0 986 430 205</b>

0 414 755 015	<b>0 986 445 011</b>
0 414 799 008	<b>F 00E 200 403</b>
0 414 799 009	<b>F 00E 200 404</b>
0 414 799 009	<b>0 986 445 110</b>
0 414 799 016	<b>0 986 445 114</b>

0 432 191 634	<b>0 986 430 368</b>
0 432 191 635	<b>0 986 430 367</b>
0 432 191 655	<b>0 986 430 490</b>
0 432 191 658	<b>0 986 430 498</b>
0 432 191 669	<b>0 986 430 364</b>

0 432 217 188	<b>0 986 430 208</b>
0 432 217 191	<b>0 986 430 198</b>
0 432 217 196	<b>0 986 430 448</b>
0 432 217 198	<b>0 986 430 189</b>
0 432 217 206	<b>0 986 430 234</b>

0 432 231 680	<b>0 986 430 038</b>
0 432 231 684	<b>0 986 430 042</b>
0 432 231 687	<b>0 986 430 053</b>
0 432 231 688	<b>0 986 430 221</b>
0 432 231 699	<b>0 986 430 445</b>

0 414 799 017	<b>F 00E 200 412</b>
0 414 799 020	<b>0 986 441 024</b>
0 414 799 024	<b>F 00E 200 413</b>
0 414 799 037	<b>0 986 445 115</b>
0 430 211 079	<b>0 986 430 249</b>

0 432 191 694	<b>0 986 430 447</b>
0 432 191 710	<b>0 986 430 366</b>
0 432 191 715	<b>0 986 430 354</b>
0 432 191 719	<b>0 986 430 359</b>
0 432 191 721	<b>0 986 430 250</b>

0 432 217 207	<b>0 986 430 189</b>
0 432 217 210	<b>0 986 430 234</b>
0 432 217 214	<b>0 986 430 235</b>
0 432 217 215	<b>0 986 430 235</b>
0 432 217 218	<b>0 986 430 240</b>

0 432 231 702	<b>0 986 430 341</b>
0 432 231 703	<b>0 986 430 168</b>
0 432 231 704	<b>0 986 430 133</b>
0 432 231 713	<b>0 986 430 210</b>
0 432 231 714	<b>0 986 430 211</b>

0 432 131 632	<b>0 986 430 090</b>
0 432 131 667	<b>0 986 430 196</b>
0 432 131 703	<b>0 986 430 390</b>
0 432 131 707	<b>0 986 430 091</b>
0 432 131 714	<b>0 986 430 511</b>

0 432 191 724	<b>0 986 430 311</b>
0 432 191 730	<b>0 986 430 263</b>
0 432 191 736	<b>0 986 430 363</b>
0 432 191 737	<b>0 986 430 353</b>
0 432 191 759	<b>0 986 430 332</b>

0 432 217 222	<b>0 986 430 249</b>
0 432 217 223	<b>0 986 430 241</b>
0 432 217 226	<b>0 986 430 268</b>
0 432 217 237	<b>0 986 430 270</b>
0 432 217 239	<b>0 986 430 187</b>

0 432 231 717	<b>0 986 430 205</b>
0 432 231 722	<b>0 986 430 214</b>
0 432 231 724	<b>0 986 430 221</b>
0 432 231 736	<b>0 986 430 178</b>
0 432 231 741	<b>0 986 430 344</b>

0 432 131 726	<b>0 986 430 326</b>
0 432 131 727	<b>0 986 430 325</b>
0 432 131 728	<b>0 986 430 327</b>
0 432 131 751	<b>0 986 430 387</b>
0 432 131 758	<b>0 986 430 382</b>

0 432 191 770	<b>0 986 430 165</b>
0 432 191 771	<b>0 986 430 166</b>
0 432 191 778	<b>0 986 430 492</b>
0 432 191 788	<b>0 986 430 167</b>
0 432 191 801	<b>0 986 430 494</b>

0 432 217 240	<b>0 986 430 187</b>
0 432 217 241	<b>0 986 430 188</b>
0 432 217 242	<b>0 986 430 188</b>
0 432 217 243	<b>0 986 430 206</b>
0 432 217 244	<b>0 986 430 206</b>

0 432 231 747	<b>0 986 430 334</b>
0 432 231 760	<b>0 986 430 168</b>
0 432 231 764	<b>0 986 430 038</b>
0 432 231 766	<b>0 986 430 133</b>
0 432 231 778	<b>0 986 430 159</b>

0 432 131 760	<b>0 986 430 451</b>
0 432 131 767	<b>0 986 430 347</b>
0 432 131 773	<b>0 986 430 385</b>
0 432 131 781	<b>0 986 430 361</b>
0 432 131 788	<b>0 986 430 312</b>

0 432 191 815	<b>0 986 430 164</b>
0 432 191 822	<b>0 986 430 162</b>
0 432 191 825	<b>0 986 430 163</b>
0 432 191 848	<b>0 986 430 000</b>
0 432 191 854	<b>0 986 430 002</b>

0 432 217 246	<b>0 986 430 243</b>
0 432 217 248	<b>0 986 430 244</b>
0 432 217 253	<b>0 986 430 245</b>
0 432 217 258	<b>0 986 430 269</b>
0 432 217 262	<b>0 986 430 246</b>

0 432 231 797	<b>0 986 430 038</b>
0 432 231 799	<b>0 986 430 039</b>
0 432 231 814	<b>0 986 430 042</b>
0 432 231 823	<b>0 986 430 045</b>
0 432 231 824	<b>0 986 430 046</b>



0 432 231 873	<b>0 986 430 053</b>	0 444 022 018	<b>0 986 44D 113</b>	0 444 042 004	<b>0 986 44D 123</b>	0 444 042 155	<b>0 986 44D 224</b>
0 432 231 886	<b>0 986 430 055</b>	0 444 022 019	<b>0 986 44D 106</b>	0 444 042 004	<b>0 986 44D 206</b>	0 444 042 156	<b>0 444 042 155</b>
0 432 231 887	<b>0 986 430 056</b>	0 444 022 020	<b>0 986 44D 113</b>	0 444 042 004	<b>0 986 44D 209</b>	0 444 042 156	<b>0 986 44D 224</b>
0 432 281 695	<b>0 986 430 342</b>	0 444 022 021	<b>0 986 44D 131</b>	0 444 042 005	<b>0 986 44D 124</b>	0 444 042 165	<b>0 986 44D 228</b>
0 432 291 534	<b>0 986 430 301</b>	0 444 022 022	<b>0 444 022 024</b>	0 444 042 005	<b>0 986 44D 200</b>	0 444 042 166	<b>0 986 44D 228</b>
0 432 291 558	<b>0 986 430 337</b>	0 444 022 022	<b>0 986 44D 110</b>	0 444 042 006	<b>0 986 44D 124</b>	0 444 042 167	<b>0 986 44D 230</b>
0 432 291 621	<b>0 986 430 338</b>	0 444 022 023	<b>0 444 022 024</b>	0 444 042 006	<b>0 986 44D 200</b>	0 444 042 168	<b>0 986 44D 230</b>
0 432 291 635	<b>0 986 430 169</b>	0 444 022 023	<b>0 986 44D 110</b>	0 444 042 009	<b>0 986 44D 124</b>	0 444 043 008	<b>0 444 043 007</b>
0 432 291 661	<b>0 986 430 203</b>	0 444 022 025	<b>0 444 022 029</b>	0 444 042 009	<b>0 986 44D 200</b>	0 444 043 060	<b>0 444 043 001</b>
0 432 291 672	<b>0 986 430 336</b>	0 444 022 026	<b>0 444 022 007</b>	0 444 042 011	<b>0 444 042 012</b>	0 444 043 060	<b>0 986 44D 282</b>
0 432 291 710	<b>0 986 430 333</b>	0 444 022 031	<b>0 444 022 009</b>	0 444 042 011	<b>0 986 44D 211</b>	0 444 043 061	<b>0 986 44D 282</b>
0 432 291 718	<b>0 986 430 141</b>	0 444 022 032	<b>0 444 022 034</b>	0 444 042 011	<b>0 986 44D 222</b>	0 444 043 071	<b>0 986 44D 284</b>
0 432 291 753	<b>0 986 430 067</b>	0 444 022 032	<b>0 986 44D 110</b>	0 444 042 012	<b>0 986 44D 211</b>	0 444 043 072	<b>0 986 44D 284</b>
0 432 291 807	<b>0 986 430 124</b>	0 444 022 033	<b>0 444 022 034</b>	0 444 042 012	<b>0 986 44D 222</b>	0 444 043 087	<b>0 986 44D 280</b>
0 432 292 881	<b>0 986 430 074</b>	0 444 022 033	<b>0 986 44D 110</b>	0 444 042 013	<b>0 986 44D 122</b>	0 444 043 088	<b>0 986 44D 280</b>
0 432 297 034	<b>0 986 430 144</b>	0 444 022 035	<b>0 444 022 037</b>	0 444 042 013	<b>0 986 44D 205</b>	0 444 043 107	<b>0 986 44D 286</b>
0 432 297 057	<b>0 986 430 532</b>	0 444 022 039	<b>0 986 44D 103</b>	0 444 042 013	<b>0 986 44D 207</b>	0 444 043 108	<b>0 986 44D 286</b>
0 444 010 004	<b>0 444 010 032</b>	0 444 022 042	<b>0 986 44D 110</b>	0 444 042 014	<b>0 986 44D 123</b>	0 444 043 111	<b>0 986 44D 288</b>
0 444 010 005	<b>0 986 44D 002</b>	0 444 022 043	<b>0 444 022 042</b>	0 444 042 014	<b>0 986 44D 206</b>	0 444 043 112	<b>0 986 44D 288</b>
0 444 010 009	<b>0 986 44D 002</b>	0 444 022 043	<b>0 986 44D 110</b>	0 444 042 014	<b>0 986 44D 209</b>	0 444 043 113	<b>0 986 44D 290</b>
0 444 010 012	<b>0 444 010 021</b>	0 444 022 044	<b>0 444 022 042</b>	0 444 042 016	<b>0 986 44D 211</b>	0 444 043 114	<b>0 986 44D 290</b>
0 444 010 012	<b>0 444 010 033</b>	0 444 022 044	<b>0 986 44D 110</b>	0 444 042 027	<b>0 986 44D 224</b>	0 444 043 148	<b>0 444 043 149</b>
0 444 010 012	<b>0 986 44D 004</b>	0 444 022 045	<b>0 444 022 042</b>	0 444 042 028	<b>0 444 042 027</b>	0 444 050 175	<b>0 444 050 174</b>
0 444 010 017	<b>0 444 010 021</b>	0 444 022 046	<b>0 444 022 042</b>	0 444 042 028	<b>0 986 44D 224</b>	0 445 010 006	<b>0 986 437 001</b>
0 444 010 017	<b>0 444 010 033</b>	0 444 022 047	<b>0 986 44D 110</b>	0 444 042 031	<b>0 986 44D 232</b>	0 445 010 007	<b>0 986 437 002</b>
0 444 010 017	<b>0 986 44D 004</b>	0 444 022 048	<b>0 444 022 047</b>	0 444 042 033	<b>0 986 44D 200</b>	0 445 010 008	<b>0 445 010 268</b>
0 444 010 018	<b>0 444 010 021</b>	0 444 022 048	<b>0 986 44D 110</b>	0 444 042 056	<b>0 444 042 052</b>	0 445 010 008	<b>0 986 437 100</b>
0 444 010 018	<b>0 986 44D 004</b>	0 444 022 049	<b>0 444 022 047</b>	0 444 042 057	<b>0 444 042 047</b>	0 445 010 009	<b>0 986 437 004</b>
0 444 010 020	<b>0 986 44D 002</b>	0 444 022 049	<b>0 986 44D 110</b>	0 444 042 058	<b>0 444 042 048</b>	0 445 010 010	<b>0 986 437 005</b>
0 444 010 025	<b>0 444 010 033</b>	0 444 022 050	<b>0 444 022 047</b>	0 444 042 059	<b>0 986 44D 228</b>	0 445 010 011	<b>0 986 437 006</b>
0 444 010 025	<b>0 986 44D 004</b>	0 444 022 051	<b>0 444 022 047</b>	0 444 042 060	<b>0 986 44D 228</b>	0 445 010 012	<b>0 986 437 313</b>
0 444 010 033	<b>0 444 010 021</b>	0 444 022 053	<b>0 986 44D 110</b>	0 444 042 061	<b>0 986 44D 230</b>	0 445 010 013	<b>0 445 010 269</b>
0 444 010 033	<b>0 986 44D 004</b>	0 444 022 054	<b>0 986 44D 110</b>	0 444 042 062	<b>0 986 44D 230</b>	0 445 010 013	<b>0 986 437 101</b>
0 444 010 035	<b>0 444 010 034</b>	0 444 022 059	<b>0 986 44D 110</b>	0 444 042 067	<b>0 986 44D 236</b>	0 445 010 014	<b>0 445 010 270</b>
0 444 010 036	<b>0 986 44D 002</b>	0 444 022 060	<b>0 444 022 059</b>	0 444 042 094	<b>0 444 042 002</b>	0 445 010 014	<b>0 986 437 102</b>
0 444 011 015	<b>0 444 011 016</b>	0 444 022 062	<b>0 444 022 059</b>	0 444 042 094	<b>0 986 44D 213</b>	0 445 010 015	<b>0 986 437 009</b>
0 444 011 023	<b>0 444 011 011</b>	0 444 022 064	<b>0 444 022 059</b>	0 444 042 095	<b>0 986 44D 213</b>	0 445 010 018	<b>0 986 437 010</b>
0 444 011 027	<b>0 444 011 026</b>	0 444 022 064	<b>0 986 44D 110</b>	0 444 042 096	<b>0 444 042 001</b>	0 445 010 019	<b>0 445 010 271</b>
0 444 021 014	<b>0 986 44D 320</b>	0 444 022 065	<b>0 986 44D 115</b>	0 444 042 096	<b>0 986 44D 215</b>	0 445 010 019	<b>0 986 437 104</b>
0 444 021 017	<b>0 444 021 058</b>	0 444 022 067	<b>0 986 44D 110</b>	0 444 042 097	<b>0 986 44D 215</b>	0 445 010 021	<b>0 986 437 012</b>
0 444 021 052	<b>0 444 021 056</b>	0 444 022 069	<b>0 986 44D 115</b>	0 444 042 103	<b>0 986 44D 217</b>	0 445 010 024	<b>0 445 010 272</b>
0 444 022 001	<b>0 986 44D 106</b>	0 444 022 070	<b>0 986 44D 115</b>	0 444 042 104	<b>0 986 44D 219</b>	0 445 010 024	<b>0 986 437 103</b>
0 444 022 002	<b>0 444 022 039</b>	0 444 022 073	<b>0 986 44D 110</b>	0 444 042 128	<b>0 986 44D 205</b>	0 445 010 025	<b>0 445 010 273</b>
0 444 022 002	<b>0 986 44D 103</b>	0 444 022 074	<b>0 986 44D 110</b>	0 444 042 129	<b>0 986 44D 206</b>	0 445 010 025	<b>0 986 437 019</b>
0 444 022 003	<b>0 444 022 039</b>	0 444 022 075	<b>0 986 44D 110</b>	0 444 042 132	<b>0 986 44D 205</b>	0 445 010 027	<b>0 445 010 274</b>
0 444 022 003	<b>0 986 44D 103</b>	0 444 023 004	<b>0 444 023 018</b>	0 444 042 133	<b>0 986 44D 206</b>	0 445 010 027	<b>0 986 437 100</b>
0 444 022 004	<b>0 444 022 039</b>	0 444 023 005	<b>0 444 023 016</b>	0 444 042 134	<b>0 986 44D 207</b>	0 445 010 028	<b>0 986 437 015</b>
0 444 022 004	<b>0 986 44D 103</b>	0 444 023 008	<b>0 444 023 017</b>	0 444 042 135	<b>0 986 44D 207</b>	0 445 010 029	<b>0 445 010 334</b>
0 444 022 005	<b>0 444 022 039</b>	0 444 023 009	<b>0 444 023 017</b>	0 444 042 136	<b>0 986 44D 209</b>	0 445 010 029	<b>0 986 437 360</b>
0 444 022 005	<b>0 986 44D 103</b>	0 444 023 020	<b>0 444 023 024</b>	0 444 042 137	<b>0 986 44D 209</b>	0 445 010 030	<b>0 445 010 275</b>
0 444 022 014	<b>0 986 44D 113</b>	0 444 023 073	<b>0 444 023 022</b>	0 444 042 142	<b>0 986 44D 230</b>	0 445 010 030	<b>0 986 437 106</b>
0 444 022 015	<b>0 986 44D 113</b>	0 444 036 020	<b>0 444 010 036</b>	0 444 042 143	<b>0 986 44D 230</b>	0 445 010 031	<b>0 986 437 301</b>
0 444 022 016	<b>0 986 44D 113</b>	0 444 042 003	<b>0 986 44D 122</b>	0 444 042 145	<b>0 986 44D 232</b>	0 445 010 033	<b>0 986 437 302</b>
0 444 022 017	<b>0 986 44D 113</b>	0 444 042 003	<b>0 986 44D 205</b>	0 444 042 150	<b>0 986 44D 217</b>	0 445 010 036	<b>0 986 437 316</b>
0 444 022 018	<b>0 444 022 020</b>	0 444 042 003	<b>0 986 44D 207</b>	0 444 042 151	<b>0 986 44D 219</b>	0 445 010 038	<b>0 445 010 279</b>



## ◀ BOSCH-EXCHANGE

0 445 010 038	<b>0 986 437 020</b>	0 445 010 127	<b>0 986 437 362</b>	0 445 010 245	<b>0 986 437 340</b>	0 445 010 358	<b>0 986 437 346</b>
0 445 010 039	<b>0 986 437 317</b>	0 445 010 128	<b>0 986 437 026</b>	0 445 010 247	<b>0 986 437 072</b>	0 445 010 367	<b>0 986 437 034</b>
0 445 010 042	<b>0 986 437 309</b>	0 445 010 129	<b>0 445 010 294</b>	0 445 010 248	<b>0 986 437 027</b>	0 445 010 371	<b>0 986 437 047</b>
0 445 010 043	<b>0 986 437 312</b>	0 445 010 132	<b>0 986 437 018</b>	0 445 010 250	<b>0 986 437 045</b>	0 445 010 381	<b>0 986 437 072</b>
0 445 010 045	<b>0 986 437 323</b>	0 445 010 133	<b>0 986 437 093</b>	0 445 010 258	<b>0 986 437 338</b>	0 445 010 382	<b>0 986 437 027</b>
0 445 010 046	<b>0 986 437 017</b>	0 445 010 134	<b>0 986 437 372</b>	0 445 010 268	<b>0 986 437 100</b>	0 445 010 392	<b>0 986 437 338</b>
0 445 010 048	<b>0 986 437 364</b>	0 445 010 135	<b>0 986 437 363</b>	0 445 010 269	<b>0 986 437 101</b>	0 445 010 399	<b>0 986 437 029</b>
0 445 010 050	<b>0 445 010 280</b>	0 445 010 136	<b>0 986 437 031</b>	0 445 010 270	<b>0 986 437 102</b>	0 445 010 404	<b>0 986 437 070</b>
0 445 010 050	<b>0 986 437 021</b>	0 445 010 137	<b>0 986 437 085</b>	0 445 010 271	<b>0 986 437 104</b>	0 445 010 406	<b>0 986 437 071</b>
0 445 010 052	<b>0 445 010 354</b>	0 445 010 138	<b>0 445 010 278</b>	0 445 010 272	<b>0 986 437 103</b>	0 445 010 422	<b>0 986 437 036</b>
0 445 010 073	<b>0 986 437 320</b>	0 445 010 138	<b>0 986 437 024</b>	0 445 010 273	<b>0 986 437 019</b>	0 445 010 441	<b>0 986 437 047</b>
0 445 010 074	<b>0 986 437 314</b>	0 445 010 138	<b>0 986 437 201</b>	0 445 010 274	<b>0 986 437 100</b>	0 445 010 442	<b>0 986 437 047</b>
0 445 010 075	<b>0 986 437 301</b>	0 445 010 139	<b>0 445 010 367</b>	0 445 010 275	<b>0 986 437 106</b>	0 445 010 443	<b>0 986 437 027</b>
0 445 010 076	<b>0 986 437 317</b>	0 445 010 139	<b>0 986 437 034</b>	0 445 010 276	<b>0 986 437 023</b>	0 445 010 444	<b>0 986 437 027</b>
0 445 010 078	<b>0 986 437 364</b>	0 445 010 140	<b>0 986 437 033</b>	0 445 010 277	<b>0 986 437 024</b>	0 445 010 506	<b>0 986 437 402</b>
0 445 010 079	<b>0 445 010 281</b>	0 445 010 141	<b>0 986 437 356</b>	0 445 010 277	<b>0 986 437 201</b>	0 445 010 507	<b>0 445 010 546</b>
0 445 010 079	<b>0 986 437 022</b>	0 445 010 142	<b>0 986 437 032</b>	0 445 010 278	<b>0 986 437 024</b>	0 445 010 508	<b>0 445 010 543</b>
0 445 010 080	<b>0 986 437 023</b>	0 445 010 143	<b>0 986 437 364</b>	0 445 010 278	<b>0 986 437 201</b>	0 445 010 510	<b>0 986 437 406</b>
0 445 010 082	<b>0 445 010 358</b>	0 445 010 145	<b>0 986 437 365</b>	0 445 010 279	<b>0 986 437 020</b>	0 445 010 511	<b>0 986 437 431</b>
0 445 010 082	<b>0 986 437 346</b>	0 445 010 148	<b>0 986 437 043</b>	0 445 010 280	<b>0 986 437 021</b>	0 445 010 512	<b>0 986 437 437</b>
0 445 010 085	<b>0 445 010 114</b>	0 445 010 149	<b>0 445 010 347</b>	0 445 010 281	<b>0 986 437 022</b>	0 445 010 516	<b>0 986 437 430</b>
0 445 010 086	<b>0 986 437 317</b>	0 445 010 150	<b>0 986 437 035</b>	0 445 010 282	<b>0 986 437 005</b>	0 445 010 517	<b>0 986 437 424</b>
0 445 010 089	<b>0 986 437 322</b>	0 445 010 154	<b>0 986 437 093</b>	0 445 010 283	<b>0 445 010 163</b>	0 445 010 519	<b>0 986 437 425</b>
0 445 010 090	<b>0 986 437 348</b>	0 445 010 155	<b>0 986 437 026</b>	0 445 010 283	<b>0 986 437 017</b>	0 445 010 520	<b>0 986 437 433</b>
0 445 010 091	<b>0 986 437 366</b>	0 445 010 156	<b>0 986 437 025</b>	0 445 010 284	<b>0 445 010 164</b>	0 445 010 523	<b>0 986 437 420</b>
0 445 010 092	<b>0 445 010 277</b>	0 445 010 157	<b>0 986 437 036</b>	0 445 010 284	<b>0 986 437 018</b>	0 445 010 524	<b>0 986 437 426</b>
0 445 010 092	<b>0 986 437 024</b>	0 445 010 162	<b>0 986 437 005</b>	0 445 010 286	<b>0 986 437 035</b>	0 445 010 525	<b>0 986 437 437</b>
0 445 010 092	<b>0 986 437 201</b>	0 445 010 163	<b>0 445 010 283</b>	0 445 010 287	<b>0 986 437 026</b>	0 445 010 528	<b>0 986 437 401</b>
0 445 010 095	<b>0 986 437 363</b>	0 445 010 163	<b>0 986 437 017</b>	0 445 010 288	<b>0 986 437 025</b>	0 445 010 529	<b>0 986 437 434</b>
0 445 010 096	<b>0 986 437 368</b>	0 445 010 164	<b>0 445 010 284</b>	0 445 010 289	<b>0 986 437 030</b>	0 445 010 530	<b>0 986 437 439</b>
0 445 010 097	<b>0 986 437 025</b>	0 445 010 164	<b>0 986 437 018</b>	0 445 010 290	<b>0 986 437 042</b>	0 445 010 533	<b>0 986 437 420</b>
0 445 010 099	<b>0 986 437 355</b>	0 445 010 170	<b>0 986 437 044</b>	0 445 010 293	<b>0 986 437 036</b>	0 445 010 534	<b>0 986 437 438</b>
0 445 010 101	<b>0 445 010 355</b>	0 445 010 171	<b>0 445 010 331</b>	0 445 010 296	<b>0 986 437 028</b>	0 445 010 535	<b>0 986 437 434</b>
0 445 010 101	<b>0 986 437 369</b>	0 445 010 171	<b>0 986 437 093</b>	0 445 010 302	<b>0 986 437 094</b>	0 445 010 536	<b>0 986 437 459</b>
0 445 010 102	<b>0 445 010 296</b>	0 445 010 180	<b>0 445 010 332</b>	0 445 010 303	<b>0 986 437 094</b>	0 445 010 537	<b>0 986 437 440</b>
0 445 010 102	<b>0 986 437 028</b>	0 445 010 181	<b>0 986 437 085</b>	0 445 010 304	<b>0 986 437 094</b>	0 445 010 538	<b>0 986 437 440</b>
0 445 010 104	<b>F 00E 200 391</b>	0 445 010 183	<b>0 986 437 048</b>	0 445 010 305	<b>0 986 437 094</b>	0 445 010 539	<b>0 986 437 460</b>
0 445 010 105	<b>0 986 437 335</b>	0 445 010 185	<b>0 986 437 094</b>	0 445 010 310	<b>0 986 437 038</b>	0 445 010 540	<b>0 986 437 403</b>
0 445 010 108	<b>0 986 437 315</b>	0 445 010 193	<b>0 445 010 371</b>	0 445 010 311	<b>0 986 437 038</b>	0 445 010 541	<b>0 986 437 433</b>
0 445 010 110	<b>0 986 437 325</b>	0 445 010 193	<b>0 986 437 047</b>	0 445 010 317	<b>0 986 437 085</b>	0 445 010 542	<b>0 986 437 433</b>
0 445 010 111	<b>0 986 437 325</b>	0 445 010 196	<b>0 986 437 039</b>	0 445 010 318	<b>0 986 437 085</b>	0 445 010 543	<b>0 445 010 543</b>
0 445 010 117	<b>0 986 437 367</b>	0 445 010 202	<b>0 986 437 036</b>	0 445 010 331	<b>0 445 010 331</b>	0 445 010 545	<b>0 986 437 437</b>
0 445 010 118	<b>0 986 437 029</b>	0 445 010 203	<b>0 445 010 278</b>	0 445 010 331	<b>0 986 437 093</b>	0 445 010 546	<b>0 445 010 546</b>
0 445 010 119	<b>0 445 010 340</b>	0 445 010 203	<b>0 986 437 024</b>	0 445 010 334	<b>0 986 437 360</b>	0 445 010 552	<b>0 986 437 430</b>
0 445 010 119	<b>0 986 437 344</b>	0 445 010 203	<b>0 986 437 201</b>	0 445 010 335	<b>0 986 437 316</b>	0 445 010 553	<b>0 986 437 424</b>
0 445 010 120	<b>0 986 437 368</b>	0 445 010 204	<b>0 986 437 036</b>	0 445 010 340	<b>0 445 010 340</b>	0 445 010 554	<b>0 986 437 425</b>
0 445 010 121	<b>0 445 010 342</b>	0 445 010 205	<b>0 986 437 041</b>	0 445 010 340	<b>0 986 437 344</b>	0 445 010 555	<b>0 986 437 433</b>
0 445 010 121	<b>0 986 437 354</b>	0 445 010 206	<b>0 445 010 290</b>	0 445 010 342	<b>0 445 010 342</b>	0 445 010 557	<b>0 986 437 420</b>
0 445 010 122	<b>0 986 437 036</b>	0 445 010 206	<b>0 986 437 042</b>	0 445 010 342	<b>0 986 437 354</b>	0 445 010 558	<b>0 986 437 426</b>
0 445 010 124	<b>0 445 010 289</b>	0 445 010 210	<b>0 986 437 340</b>	0 445 010 343	<b>0 445 010 343</b>	0 445 010 559	<b>0 986 437 437</b>
0 445 010 124	<b>0 986 437 030</b>	0 445 010 214	<b>0 986 437 338</b>	0 445 010 343	<b>0 986 437 348</b>	0 445 010 562	<b>0 986 437 434</b>
0 445 010 125	<b>0 445 010 343</b>	0 445 010 218	<b>0 986 437 043</b>	0 445 010 344	<b>0 445 010 344</b>	0 445 010 566	<b>0 986 437 420</b>
0 445 010 125	<b>0 986 437 348</b>	0 445 010 223	<b>0 986 437 044</b>	0 445 010 344	<b>0 986 437 362</b>	0 445 010 567	<b>0 986 437 438</b>
0 445 010 126	<b>0 986 437 323</b>	0 445 010 234	<b>0 986 437 086</b>	0 445 010 347	<b>0 445 010 347</b>	0 445 010 568	<b>0 986 437 434</b>
0 445 010 127	<b>0 445 010 344</b>	0 445 010 244	<b>0 986 437 340</b>	0 445 010 355	<b>0 986 437 369</b>	0 445 010 569	<b>0 986 437 459</b>

0 445 010 570	<b>0 986 437 440</b>	0 445 010 686	<b>0 986 437 404</b>	0 445 020 100	<b>0 986 437 359</b>	0 445 110 023	<b>0 986 435 008</b>
0 445 010 571	<b>0 986 437 460</b>	0 445 010 688	<b>0 986 437 427</b>	0 445 020 105	<b>F 00E 200 431</b>	0 445 110 028	<b>0 986 435 009</b>
0 445 010 573	<b>0 986 437 424</b>	0 445 010 690	<b>0 986 437 463</b>	0 445 020 106	<b>0 986 437 334</b>	0 445 110 029	<b>0 986 435 010</b>
0 445 010 574	<b>0 986 437 424</b>	0 445 010 691	<b>0 986 437 463</b>	0 445 020 107	<b>0 986 437 333</b>	0 445 110 030	<b>0 986 435 011</b>
0 445 010 582	<b>0 986 437 406</b>	0 445 010 701	<b>0 986 437 403</b>	0 445 020 109	<b>0 986 437 375</b>	0 445 110 034	<b>0 986 435 012</b>
0 445 010 583	<b>0 986 437 440</b>	0 445 010 702	<b>0 986 437 425</b>	0 445 020 113	<b>0 986 437 370</b>	0 445 110 034	<b>0 986 435 037</b>
0 445 010 585	<b>0 986 437 461</b>	0 445 010 705	<b>0 986 437 462</b>	0 445 020 122	<b>0 986 437 310</b>	0 445 110 035	<b>0 986 435 012</b>
0 445 010 586	<b>0 986 437 461</b>	0 445 010 706	<b>0 986 437 462</b>	0 445 020 123	<b>0 986 437 337</b>	0 445 110 036	<b>0 986 435 013</b>
0 445 010 593	<b>0 986 437 461</b>	0 445 010 707	<b>0 986 437 402</b>	0 445 020 125	<b>0 986 437 350</b>	0 445 110 036	<b>0 986 435 014</b>
0 445 010 594	<b>0 986 437 461</b>	0 445 010 713	<b>0 986 437 426</b>	0 445 020 126	<b>F 00E 200 549</b>	0 445 110 036	<b>0 986 435 015</b>
0 445 010 611	<b>0 445 010 659</b>	0 445 010 715	<b>0 986 437 406</b>	0 445 020 126	<b>0 445 020 126</b>	0 445 110 038	<b>0 986 435 016</b>
0 445 010 611	<b>0 986 437 404</b>	0 445 010 719	<b>0 986 437 401</b>	0 445 020 126	<b>0 986 437 506</b>	0 445 110 044	<b>0 986 435 002</b>
0 445 010 612	<b>0 986 437 465</b>	0 445 010 721	<b>0 986 437 403</b>	0 445 020 129	<b>0 986 437 359</b>	0 445 110 044	<b>0 986 435 003</b>
0 445 010 613	<b>0 445 010 654</b>	0 445 010 725	<b>0 986 437 425</b>	0 445 020 130	<b>0 986 437 352</b>	0 445 110 047	<b>0 986 435 022</b>
0 445 010 614	<b>0 986 437 432</b>	0 445 010 727	<b>0 986 437 403</b>	0 445 020 137	<b>0 986 437 319</b>	0 445 110 048	<b>0 986 435 094</b>
0 445 010 616	<b>0 986 437 421</b>	0 445 010 755	<b>0 986 437 457</b>	0 445 020 138	<b>0 986 437 507</b>	0 445 110 049	<b>0 986 435 095</b>
0 445 010 617	<b>0 986 437 427</b>	0 445 010 756	<b>0 986 437 457</b>	0 445 020 146	<b>0 986 437 334</b>	0 445 110 054	<b>0 986 435 133</b>
0 445 010 618	<b>0 986 437 423</b>	0 445 010 771	<b>0 986 437 462</b>	0 445 020 147	<b>0 986 437 304</b>	0 445 110 055	<b>0 986 435 133</b>
0 445 010 619	<b>0 986 437 414</b>	0 445 010 772	<b>0 986 437 462</b>	0 445 020 148	<b>0 986 437 333</b>	0 445 110 057	<b>0 986 435 093</b>
0 445 010 620	<b>0 986 437 416</b>	0 445 010 801	<b>0 986 437 418</b>	0 445 020 149	<b>0 986 437 337</b>	0 445 110 059	<b>0 986 435 149</b>
0 445 010 622	<b>0 986 437 422</b>	0 445 010 802	<b>0 986 437 421</b>	0 445 020 150	<b>0 986 437 342</b>	0 445 110 062	<b>0 986 435 077</b>
0 445 010 623	<b>0 986 437 428</b>	0 445 010 805	<b>0 986 437 456</b>	0 445 020 155	<b>0 986 437 350</b>	0 445 110 063	<b>0 986 435 075</b>
0 445 010 624	<b>0 986 437 418</b>	0 445 010 806	<b>0 986 437 456</b>	0 445 020 156	<b>0 986 437 359</b>	0 445 110 064	<b>0 986 435 147</b>
0 445 010 629	<b>0 445 010 662</b>	0 445 010 807	<b>0 986 437 428</b>	0 445 020 160	<b>0 986 437 512</b>	0 445 110 068	<b>0 986 435 083</b>
0 445 010 629	<b>0 986 437 432</b>	0 445 010 809	<b>0 986 437 427</b>	0 445 020 175	<b>0 986 437 341</b>	0 445 110 070	<b>0 986 435 158</b>
0 445 010 634	<b>0 986 437 429</b>	0 445 010 813	<b>0 986 437 456</b>	0 445 020 189	<b>0 986 437 507</b>	0 445 110 071	<b>0 986 435 071</b>
0 445 010 639	<b>0 986 437 404</b>	0 445 010 814	<b>0 986 437 456</b>	0 445 020 190	<b>0 986 437 507</b>	0 445 110 072	<b>0 986 435 071</b>
0 445 010 640	<b>0 445 010 656</b>	0 445 010 817	<b>0 986 437 421</b>	0 445 020 191	<b>0 986 437 503</b>	0 445 110 073	<b>0 986 435 031</b>
0 445 010 642	<b>0 445 010 658</b>	0 445 010 832	<b>0 986 437 432</b>	0 445 020 195	<b>0 986 437 512</b>	0 445 110 074	<b>0 986 435 031</b>
0 445 010 643	<b>0 986 437 463</b>	0 445 010 833	<b>0 986 437 432</b>	0 445 020 198	<b>0 986 437 504</b>	0 445 110 075	<b>0 986 435 076</b>
0 445 010 645	<b>0 986 437 458</b>	0 445 010 844	<b>0 986 437 422</b>	0 445 020 199	<b>0 986 437 504</b>	0 445 110 076	<b>0 986 435 077</b>
0 445 010 646	<b>0 445 010 673</b>	0 445 020 002	<b>0 986 437 501</b>	0 445 020 203	<b>0 986 437 352</b>	0 445 110 078	<b>0 986 435 120</b>
0 445 010 646	<b>0 986 437 404</b>	0 445 020 005	<b>0 986 437 303</b>	0 445 020 206	<b>0 986 437 359</b>	0 445 110 080	<b>0 445 110 131</b>
0 445 010 650	<b>0 986 437 418</b>	0 445 020 006	<b>0 986 437 502</b>	0 445 020 208	<b>0 986 437 350</b>	0 445 110 080	<b>0 986 435 084</b>
0 445 010 655	<b>0 986 437 423</b>	0 445 020 007	<b>0 986 437 341</b>	0 445 020 215	<b>0 986 437 506</b>	0 445 110 083	<b>0 986 435 078</b>
0 445 010 656	<b>0 445 010 656</b>	0 445 020 008	<b>0 986 437 318</b>	0 445 020 235	<b>0 986 437 507</b>	0 445 110 087	<b>0 986 435 079</b>
0 445 010 658	<b>0 445 010 658</b>	0 445 020 011	<b>0 986 437 304</b>	0 445 020 236	<b>0 986 437 507</b>	0 445 110 089	<b>0 986 435 033</b>
0 445 010 659	<b>0 445 010 659</b>	0 445 020 017	<b>0 986 437 303</b>	0 445 020 237	<b>0 986 437 508</b>	0 445 110 090	<b>0 986 435 033</b>
0 445 010 659	<b>0 986 437 404</b>	0 445 020 018	<b>0 986 437 353</b>	0 445 020 238	<b>0 986 437 508</b>	0 445 110 091	<b>0 986 435 154</b>
0 445 010 662	<b>0 445 010 662</b>	0 445 020 023	<b>0 986 437 351</b>	0 445 020 249	<b>0 986 437 504</b>	0 445 110 092	<b>0 986 435 154</b>
0 445 010 662	<b>0 986 437 432</b>	0 445 020 030	<b>0 986 437 308</b>	0 445 020 250	<b>0 986 437 504</b>	0 445 110 093	<b>0 986 435 035</b>
0 445 010 663	<b>0 986 437 414</b>	0 445 020 034	<b>0 986 437 352</b>	0 445 020 300	<b>0 986 437 370</b>	0 445 110 094	<b>0 986 435 035</b>
0 445 010 664	<b>0 986 437 416</b>	0 445 020 037	<b>F 00E 200 431</b>	0 445 110 002	<b>0 986 435 001</b>	0 445 110 095	<b>0 986 435 037</b>
0 445 010 665	<b>0 986 437 428</b>	0 445 020 039	<b>0 986 437 304</b>	0 445 110 005	<b>0 986 435 005</b>	0 445 110 096	<b>0 986 435 037</b>
0 445 010 667	<b>0 986 437 429</b>	0 445 020 045	<b>0 986 437 342</b>	0 445 110 006	<b>0 986 435 005</b>	0 445 110 097	<b>0 986 435 039</b>
0 445 010 669	<b>0 986 437 404</b>	0 445 020 046	<b>0 986 437 321</b>	0 445 110 007	<b>0 986 435 010</b>	0 445 110 097	<b>0 986 435 047</b>
0 445 010 670	<b>0 986 437 463</b>	0 445 020 051	<b>0 986 437 350</b>	0 445 110 008	<b>0 445 110 044</b>	0 445 110 098	<b>0 986 435 039</b>
0 445 010 672	<b>0 986 437 458</b>	0 445 020 060	<b>0 986 437 352</b>	0 445 110 008	<b>0 986 435 003</b>	0 445 110 098	<b>0 986 435 047</b>
0 445 010 673	<b>0 986 437 404</b>	0 445 020 069	<b>0 986 437 503</b>	0 445 110 013	<b>0 986 435 009</b>	0 445 110 101	<b>0 986 435 147</b>
0 445 010 675	<b>0 986 437 418</b>	0 445 020 070	<b>0 986 437 082</b>	0 445 110 014	<b>0 986 435 005</b>	0 445 110 103	<b>0 986 435 043</b>
0 445 010 678	<b>0 986 437 429</b>	0 445 020 072	<b>0 986 437 333</b>	0 445 110 015	<b>0 986 435 005</b>	0 445 110 104	<b>0 986 435 043</b>
0 445 010 679	<b>0 986 437 429</b>	0 445 020 075	<b>0 986 437 350</b>	0 445 110 016	<b>0 986 435 011</b>	0 445 110 107	<b>0 986 435 039</b>
0 445 010 680	<b>0 986 437 423</b>	0 445 020 076	<b>0 986 437 334</b>	0 445 110 019	<b>0 986 435 006</b>	0 445 110 107	<b>0 986 435 047</b>
0 445 010 681	<b>0 986 437 423</b>	0 445 020 080	<b>0 986 437 358</b>	0 445 110 021	<b>0 986 435 007</b>	0 445 110 108	<b>0 986 435 039</b>
0 445 010 685	<b>0 986 437 404</b>	0 445 020 093	<b>0 986 437 389</b>	0 445 110 022	<b>0 986 435 008</b>	0 445 110 108	<b>0 986 435 047</b>





## ◀ BOSCH-EXCHANGE

0 445 110 109	<b>0 986 435 100</b>	0 445 110 213	<b>0 986 435 162</b>	0 445 115 029	<b>0 986 435 352</b>	0 445 120 032	<b>0 986 435 505</b>
0 445 110 110	<b>0 986 435 080</b>	0 445 110 216	<b>0 986 435 091</b>	0 445 115 034	<b>0 986 435 358</b>	0 445 120 044	<b>0 986 435 527</b>
0 445 110 111	<b>0 986 435 081</b>	0 445 110 219	<b>0 986 435 092</b>	0 445 115 035	<b>0 986 435 358</b>	0 445 120 060	<b>0 986 435 533</b>
0 445 110 112	<b>0 986 435 101</b>	0 445 110 222	<b>0 986 435 160</b>	0 445 115 036	<b>0 986 435 358</b>	0 445 120 061	<b>0 986 435 526</b>
0 445 110 118	<b>0 986 435 082</b>	0 445 110 223	<b>0 445 110 222</b>	0 445 115 037	<b>0 986 435 358</b>	0 445 120 064	<b>0 986 435 529</b>
0 445 110 119	<b>0 986 435 083</b>	0 445 110 223	<b>0 986 435 160</b>	0 445 115 038	<b>0 986 435 353</b>	0 445 120 082	<b>0 986 435 520</b>
0 445 110 120	<b>0 986 435 051</b>	0 445 110 230	<b>0 986 435 124</b>	0 445 115 039	<b>0 986 435 353</b>	0 445 120 100	<b>0 986 435 528</b>
0 445 110 121	<b>0 986 435 051</b>	0 445 110 236	<b>0 986 435 145</b>	0 445 115 048	<b>0 986 435 354</b>	0 445 120 104	<b>0 986 435 539</b>
0 445 110 126	<b>0 986 435 174</b>	0 445 110 237	<b>0 986 435 139</b>	0 445 115 049	<b>0 986 435 402</b>	0 445 120 110	<b>0 986 AD1 037</b>
0 445 110 128	<b>0 986 435 135</b>	0 445 110 238	<b>0 986 435 139</b>	0 445 115 050	<b>0 986 435 359</b>	0 445 120 113	<b>0 986 435 503</b>
0 445 110 129	<b>0 986 435 135</b>	0 445 110 239	<b>0 986 435 122</b>	0 445 115 051	<b>0 986 435 358</b>	0 445 120 131	<b>0 986 435 561</b>
0 445 110 130	<b>0 986 435 096</b>	0 445 110 243	<b>0 986 435 104</b>	0 445 115 052	<b>0 986 435 358</b>	0 445 120 136	<b>0 986 435 529</b>
0 445 110 131	<b>0 986 435 084</b>	0 445 110 244	<b>0 986 435 161</b>	0 445 115 053	<b>0 986 435 353</b>	0 445 120 156	<b>0 986 AD1 038</b>
0 445 110 135	<b>0 986 435 085</b>	0 445 110 247	<b>0 986 435 163</b>	0 445 115 054	<b>0 986 435 353</b>	0 445 120 163	<b>0 986 AD1 039</b>
0 445 110 136	<b>0 986 435 090</b>	0 445 110 248	<b>0 986 435 163</b>	0 445 115 057	<b>0 986 435 364</b>	0 445 120 164	<b>0 986 AD1 040</b>
0 445 110 139	<b>0 986 435 107</b>	0 445 110 251	<b>0 986 435 125</b>	0 445 115 058	<b>0 986 435 364</b>	0 445 120 173	<b>0 986 435 557</b>
0 445 110 140	<b>0 986 435 107</b>	0 445 110 252	<b>0 986 435 143</b>	0 445 115 063	<b>0 986 435 355</b>	0 445 120 174	<b>0 986 435 557</b>
0 445 110 141	<b>0 986 435 086</b>	0 445 110 253	<b>0 986 435 155</b>	0 445 115 064	<b>0 986 435 355</b>	0 445 120 186	<b>0 986 435 568</b>
0 445 110 146	<b>0 986 435 007</b>	0 445 110 254	<b>0 445 110 253</b>	0 445 115 070	<b>0 986 435 354</b>	0 445 120 194	<b>0 986 435 537</b>
0 445 110 149	<b>0 986 435 157</b>	0 445 110 254	<b>0 986 435 155</b>	0 445 115 071	<b>0 986 435 355</b>	0 445 120 195	<b>0 986 435 537</b>
0 445 110 150	<b>0 986 435 124</b>	0 445 110 255	<b>0 986 435 152</b>	0 445 115 072	<b>0 986 435 355</b>	0 445 120 202	<b>0 986 435 570</b>
0 445 110 155	<b>0 986 435 135</b>	0 445 110 256	<b>0 445 110 255</b>	0 445 115 077	<b>0 986 435 359</b>	0 445 120 206	<b>0 986 435 051</b>
0 445 110 156	<b>0 986 435 135</b>	0 445 110 256	<b>0 986 435 152</b>	0 445 115 078	<b>0 986 435 358</b>	0 445 120 207	<b>0 986 435 539</b>
0 445 110 157	<b>0 986 435 168</b>	0 445 110 257	<b>0 986 435 156</b>	0 445 115 079	<b>0 986 435 358</b>	0 445 120 210	<b>0 986 435 503</b>
0 445 110 159	<b>0 986 435 088</b>	0 445 110 258	<b>0 445 110 257</b>	0 445 115 080	<b>0 986 435 353</b>	0 445 120 215	<b>0 986 AD1 015</b>
0 445 110 160	<b>0 986 435 098</b>	0 445 110 258	<b>0 986 435 156</b>	0 445 115 085	<b>0 986 435 364</b>	0 445 120 217	<b>0 986 435 526</b>
0 445 110 161	<b>0 986 435 091</b>	0 445 110 263	<b>0 986 435 115</b>	0 445 115 085	<b>0 986 435 374</b>	0 445 120 218	<b>0 986 435 517</b>
0 445 110 165	<b>0 986 435 103</b>	0 445 110 264	<b>0 986 435 115</b>	0 445 115 086	<b>0 986 435 364</b>	0 445 120 219	<b>0 986 435 528</b>
0 445 110 172	<b>0 986 435 145</b>	0 445 110 265	<b>0 986 435 170</b>	0 445 116 004	<b>0 986 435 360</b>	0 445 120 250	<b>0 986 435 533</b>
0 445 110 176	<b>0 986 435 111</b>	0 445 110 266	<b>0 986 435 022</b>	0 445 116 005	<b>0 986 435 360</b>	0 445 124 010	<b>0 986 435 652</b>
0 445 110 177	<b>0 986 435 111</b>	0 445 110 268	<b>0 445 110 267</b>	0 445 116 007	<b>0 986 435 357</b>	0 445 124 011	<b>0 986 435 652</b>
0 445 110 183	<b>0 986 435 102</b>	0 445 110 269	<b>0 986 435 153</b>	0 445 116 008	<b>0 986 435 357</b>	0 445 124 012	<b>0 986 435 652</b>
0 445 110 185	<b>0 445 110 283</b>	0 445 110 270	<b>0 445 110 269</b>	0 445 116 014	<b>0 986 435 357</b>	0 445 124 013	<b>0 986 435 652</b>
0 445 110 186	<b>0 445 110 279</b>	0 445 110 270	<b>0 986 435 153</b>	0 445 116 015	<b>0 986 435 357</b>	0 460 404 074	<b>0 986 440 002</b>
0 445 110 187	<b>0 986 435 099</b>	0 445 110 273	<b>0 986 435 165</b>	0 445 116 022	<b>0 986 435 357</b>	0 460 404 959	<b>0 986 440 557</b>
0 445 110 188	<b>0 986 435 090</b>	0 445 110 275	<b>0 445 110 274</b>	0 445 116 023	<b>0 986 435 357</b>	0 460 404 961	<b>0 986 440 570</b>
0 445 110 189	<b>0 986 435 037</b>	0 445 110 278	<b>0 445 110 277</b>	0 445 116 026	<b>0 445 116 025</b>	0 460 404 964	<b>0 986 440 551</b>
0 445 110 189	<b>0 986 435 047</b>	0 445 110 281	<b>0 986 435 150</b>	0 445 116 029	<b>0 986 435 360</b>	0 460 404 966	<b>0 986 440 552</b>
0 445 110 190	<b>0 986 435 037</b>	0 445 110 294	<b>0 986 435 159</b>	0 445 116 030	<b>0 986 435 360</b>	0 460 404 967	<b>0 986 440 553</b>
0 445 110 190	<b>0 986 435 047</b>	0 445 110 295	<b>0 986 435 159</b>	0 445 116 034	<b>0 986 435 369</b>	0 460 404 968	<b>0 986 440 567</b>
0 445 110 197	<b>0 986 435 059</b>	0 445 110 297	<b>0 986 435 150</b>	0 445 116 047	<b>0 445 116 022</b>	0 460 404 969	<b>0 986 440 554</b>
0 445 110 198	<b>0 986 435 059</b>	0 445 110 300	<b>0 986 435 171</b>	0 445 117 002	<b>0 986 435 380</b>	0 460 404 970	<b>0 986 440 568</b>
0 445 110 201	<b>0 986 435 063</b>	0 445 110 311	<b>0 986 435 146</b>	0 445 120 002	<b>0 986 435 501</b>	0 460 404 971	<b>0 986 440 555</b>
0 445 110 202	<b>0 986 435 063</b>	0 445 110 411	<b>0 445 110 410</b>	0 445 120 008	<b>0 986 435 502</b>	0 460 404 972	<b>0 986 440 556</b>
0 445 110 203	<b>0 986 435 065</b>	0 445 110 429	<b>0 445 110 437</b>	0 445 120 011	<b>0 986 435 506</b>	0 460 404 973	<b>0 986 440 507</b>
0 445 110 204	<b>0 986 435 065</b>	0 445 110 429	<b>0 986 435 190</b>	0 445 120 012	<b>0 986 435 525</b>	0 460 404 974	<b>0 986 440 508</b>
0 445 110 205	<b>0 986 435 051</b>	0 445 115 003	<b>0 986 435 358</b>	0 445 120 013	<b>0 986 435 525</b>	0 460 404 976	<b>0 986 440 553</b>
0 445 110 205	<b>0 986 435 067</b>	0 445 115 004	<b>0 986 435 358</b>	0 445 120 016	<b>0 986 435 531</b>	0 460 404 977	<b>0 986 440 557</b>
0 445 110 206	<b>0 986 435 067</b>	0 445 115 007	<b>0 986 435 350</b>	0 445 120 017	<b>0 986 435 531</b>	0 460 404 978	<b>0 986 440 568</b>
0 445 110 207	<b>0 986 435 043</b>	0 445 115 018	<b>0 986 435 353</b>	0 445 120 018	<b>0 986 435 503</b>	0 460 404 979	<b>0 986 440 567</b>
0 445 110 207	<b>0 986 435 069</b>	0 445 115 023	<b>0 986 435 358</b>	0 445 120 019	<b>0 986 435 523</b>	0 460 404 982	<b>0 986 440 568</b>
0 445 110 208	<b>0 986 435 043</b>	0 445 115 024	<b>0 986 435 358</b>	0 445 120 020	<b>0 986 435 523</b>	0 460 404 983	<b>0 986 440 558</b>
0 445 110 208	<b>0 986 435 069</b>	0 445 115 026	<b>0 986 435 355</b>	0 445 120 024	<b>0 986 435 527</b>	0 460 404 984	<b>0 986 440 557</b>
0 445 110 209	<b>0 986 435 144</b>	0 445 115 027	<b>0 986 435 355</b>	0 445 120 030	<b>0 986 435 517</b>	0 460 404 985	<b>0 986 440 555</b>
0 445 110 212	<b>0 986 435 151</b>	0 445 115 028	<b>0 986 435 352</b>	0 445 120 031	<b>0 986 435 617</b>	0 460 404 986	<b>0 986 440 554</b>

0 460 404 987	<b>0 986 440 551</b>	0 460 415 988	<b>0 986 440 527</b>	0 460 494 308	<b>0 986 440 248</b>	0 470 504 022	<b>0 986 444 081</b>
0 460 404 989	<b>0 986 440 551</b>	0 460 415 989	<b>0 986 440 563</b>	0 460 494 314	<b>0 986 440 142</b>	0 470 504 023	<b>0 986 444 056</b>
0 460 404 990	<b>0 986 440 568</b>	0 460 415 990	<b>0 986 440 564</b>	0 460 494 330	<b>0 986 440 143</b>	0 470 504 024	<b>0 986 444 079</b>
0 460 404 992	<b>0 986 440 558</b>	0 460 415 991	<b>0 986 440 530</b>	0 460 494 337	<b>0 986 440 146</b>	0 470 504 025	<b>0 986 444 035</b>
0 460 404 993	<b>0 986 440 512</b>	0 460 415 992	<b>0 986 440 531</b>	0 460 494 346	<b>0 986 440 249</b>	0 470 504 028	<b>0 986 444 057</b>
0 460 404 994	<b>0 986 440 555</b>	0 460 415 992	<b>0 986 440 579</b>	0 460 494 351	<b>0 986 440 149</b>	0 470 504 035	<b>0 986 444 075</b>
0 460 404 995	<b>0 986 440 559</b>	0 460 415 994	<b>0 986 440 563</b>	0 460 494 353	<b>0 986 440 150</b>	0 470 504 036	<b>0 986 444 075</b>
0 460 404 998	<b>0 986 440 560</b>	0 460 415 995	<b>0 986 440 533</b>	0 460 494 356	<b>0 986 440 255</b>	0 470 504 040	<b>0 986 444 076</b>
0 460 405 999	<b>0 986 440 550</b>	0 460 415 996	<b>0 986 440 565</b>	0 460 494 359	<b>0 986 440 205</b>	0 470 504 041	<b>0 986 444 076</b>
0 460 406 039	<b>0 986 440 233</b>	0 460 415 997	<b>0 986 440 535</b>	0 460 494 368	<b>0 986 440 250</b>	0 470 504 042	<b>0 986 444 058</b>
0 460 406 040	<b>0 986 440 234</b>	0 460 415 998	<b>0 986 440 566</b>	0 460 494 369	<b>0 986 440 251</b>	0 470 504 201	<b>0 986 444 045</b>
0 460 406 056	<b>0 986 440 015</b>	0 460 424 124	<b>0 986 440 062</b>	0 460 494 372	<b>0 986 440 152</b>	0 470 504 202	<b>0 986 444 028</b>
0 460 406 061	<b>0 986 440 016</b>	0 460 424 125	<b>0 986 440 063</b>	0 460 494 391	<b>0 986 440 257</b>	0 470 504 203	<b>0 986 444 036</b>
0 460 406 063	<b>0 986 440 017</b>	0 460 424 136	<b>0 986 440 064</b>	0 460 494 393	<b>0 986 440 205</b>	0 470 504 204	<b>0 986 444 029</b>
0 460 406 073	<b>0 986 440 235</b>	0 460 424 138	<b>0 986 440 228</b>	0 460 494 413	<b>0 986 440 250</b>	0 470 504 205	<b>0 986 444 028</b>
0 460 406 075	<b>0 986 440 236</b>	0 460 424 146	<b>0 986 440 065</b>	0 460 494 416	<b>0 986 440 251</b>	0 470 504 206	<b>0 986 444 045</b>
0 460 406 079	<b>0 986 440 235</b>	0 460 424 147	<b>0 986 440 066</b>	0 460 494 423	<b>0 986 440 156</b>	0 470 504 207	<b>0 986 444 030</b>
0 460 406 993	<b>0 986 440 515</b>	0 460 426 171	<b>0 986 440 076</b>	0 460 494 444	<b>0 986 440 250</b>	0 470 504 208	<b>0 986 444 046</b>
0 460 406 994	<b>0 986 440 516</b>	0 460 484 022	<b>0 986 440 084</b>	0 460 494 445	<b>0 986 440 251</b>	0 470 504 209	<b>0 986 444 028</b>
0 460 406 995	<b>0 986 440 517</b>	0 460 484 031	<b>0 986 440 237</b>	0 460 494 455	<b>0 986 440 161</b>	0 470 504 210	<b>0 986 444 029</b>
0 460 406 997	<b>0 986 440 518</b>	0 460 484 033	<b>0 986 440 238</b>	0 460 494 466	<b>0 986 440 163</b>	0 470 504 211	<b>0 986 444 037</b>
0 460 413 001	<b>0 986 440 021</b>	0 460 484 036	<b>0 460 484 139</b>	0 460 494 995	<b>0 986 440 538</b>	0 470 504 212	<b>0 986 444 046</b>
0 460 414 008	<b>0 986 440 023</b>	0 460 484 040	<b>0 986 440 240</b>	0 470 004 002	<b>0 986 444 519</b>	0 470 504 213	<b>0 986 444 037</b>
0 460 414 013	<b>0 986 440 024</b>	0 460 484 046	<b>0 986 440 239</b>	0 470 004 003	<b>0 986 444 500</b>	0 470 504 214	<b>0 986 444 030</b>
0 460 414 054	<b>0 986 440 027</b>	0 460 484 064	<b>0 986 440 094</b>	0 470 004 004	<b>0 986 444 522</b>	0 470 504 215	<b>0 986 444 028</b>
0 460 414 067	<b>0 986 440 028</b>	0 460 484 071	<b>0 986 440 240</b>	0 470 004 004	<b>0 986 444 523</b>	0 470 504 216	<b>0 986 444 030</b>
0 460 414 078	<b>0 986 440 032</b>	0 460 484 101	<b>0 986 440 240</b>	0 470 004 005	<b>0 986 444 503</b>	0 470 504 217	<b>0 986 444 030</b>
0 460 414 081	<b>0 986 440 033</b>	0 460 484 102	<b>0 986 440 237</b>	0 470 004 006	<b>0 986 444 521</b>	0 470 504 218	<b>0 986 444 036</b>
0 460 414 086	<b>0 986 440 035</b>	0 460 484 127	<b>0 986 440 240</b>	0 470 004 007	<b>0 986 444 519</b>	0 470 504 219	<b>0 986 444 037</b>
0 460 414 098	<b>0 986 440 038</b>	0 460 484 128	<b>0 986 440 241</b>	0 470 004 008	<b>0 986 444 521</b>	0 470 504 220	<b>0 986 444 030</b>
0 460 414 108	<b>0 986 440 040</b>	0 460 484 143	<b>0 986 440 107</b>	0 470 004 009	<b>0 986 444 520</b>	0 470 504 221	<b>0 986 444 037</b>
0 460 414 109	<b>0 986 440 041</b>	0 460 484 150	<b>0 986 440 225</b>	0 470 004 012	<b>0 986 444 522</b>	0 470 504 222	<b>0 986 444 036</b>
0 460 414 112	<b>0 986 440 042</b>	0 460 484 152	<b>0 986 440 226</b>	0 470 004 012	<b>0 986 444 523</b>	0 470 504 223	<b>0 986 444 036</b>
0 460 414 113	<b>0 986 440 043</b>	0 460 484 160	<b>0 986 440 240</b>	0 470 004 013	<b>0 986 444 520</b>	0 470 504 224	<b>0 986 444 037</b>
0 460 414 119	<b>0 986 440 046</b>	0 460 485 003	<b>0 986 440 242</b>	0 470 004 018	<b>0 986 444 507</b>	0 470 504 225	<b>0 986 444 037</b>
0 460 414 123	<b>0 986 440 048</b>	0 460 485 017	<b>0 986 440 242</b>	0 470 004 019	<b>0 986 444 508</b>	0 470 504 226	<b>0 986 444 030</b>
0 460 414 140	<b>0 986 440 051</b>	0 460 485 019	<b>0 986 440 256</b>	0 470 006 001	<b>0 986 444 511</b>	0 470 504 227	<b>0 986 444 036</b>
0 460 414 141	<b>0 986 440 052</b>	0 460 485 023	<b>0 986 440 256</b>	0 470 006 005	<b>0 986 444 509</b>	0 470 506 002	<b>0 986 444 067</b>
0 460 414 142	<b>0 986 440 217</b>	0 460 485 024	<b>0 986 440 252</b>	0 470 006 006	<b>0 986 444 510</b>	0 470 506 003	<b>0 986 444 009</b>
0 460 414 145	<b>0 986 440 053</b>	0 460 485 025	<b>0 986 440 256</b>	0 470 006 007	<b>0 986 444 511</b>	0 470 506 003	<b>0 986 444 024</b>
0 460 414 146	<b>0 986 440 054</b>	0 460 485 027	<b>0 986 440 243</b>	0 470 006 009	<b>0 986 444 517</b>	0 470 506 003	<b>0 986 444 032</b>
0 460 414 150	<b>0 986 440 055</b>	0 460 485 028	<b>0 986 440 243</b>	0 470 504 002	<b>0 986 444 001</b>	0 470 506 005	<b>0 986 444 007</b>
0 460 414 152	<b>0 986 440 056</b>	0 460 485 029	<b>0 986 440 252</b>	0 470 504 003	<b>0 986 444 002</b>	0 470 506 005	<b>0 986 444 022</b>
0 460 414 153	<b>0 986 440 219</b>	0 460 485 030	<b>0 986 440 243</b>	0 470 504 004	<b>0 986 444 003</b>	0 470 506 005	<b>0 986 444 031</b>
0 460 414 987	<b>0 986 440 561</b>	0 460 485 033	<b>0 986 440 254</b>	0 470 504 005	<b>0 986 444 004</b>	0 470 506 006	<b>0 986 444 068</b>
0 460 414 988	<b>0 986 440 520</b>	0 460 485 035	<b>0 986 440 244</b>	0 470 504 009	<b>0 986 444 005</b>	0 470 506 009	<b>0 986 444 010</b>
0 460 414 989	<b>0 986 440 561</b>	0 460 485 037	<b>0 986 440 253</b>	0 470 504 010	<b>0 986 444 078</b>	0 470 506 009	<b>0 986 444 092</b>
0 460 414 992	<b>0 986 440 522</b>	0 460 494 039	<b>0 986 440 113</b>	0 470 504 011	<b>0 986 444 012</b>	0 470 506 010	<b>0 986 444 070</b>
0 460 414 993	<b>0 986 440 523</b>	0 460 494 040	<b>0 986 440 113</b>	0 470 504 012	<b>0 986 444 013</b>	0 470 506 011	<b>0 986 444 007</b>
0 460 414 996	<b>0 986 440 524</b>	0 460 494 108	<b>0 986 440 246</b>	0 470 504 015	<b>0 986 444 014</b>	0 470 506 011	<b>0 986 444 022</b>
0 460 415 982	<b>0 986 440 525</b>	0 460 494 152	<b>0 986 440 123</b>	0 470 504 016	<b>0 986 444 021</b>	0 470 506 011	<b>0 986 444 031</b>
0 460 415 983	<b>0 986 440 562</b>	0 460 494 182	<b>0 986 440 125</b>	0 470 504 017	<b>0 986 444 090</b>	0 470 506 012	<b>0 986 444 009</b>
0 460 415 984	<b>0 986 440 562</b>	0 460 494 252	<b>0 986 440 135</b>	0 470 504 018	<b>0 986 444 078</b>	0 470 506 012	<b>0 986 444 024</b>
0 460 415 985	<b>0 986 440 571</b>	0 460 494 267	<b>0 986 440 135</b>	0 470 504 020	<b>0 986 444 019</b>	0 470 506 012	<b>0 986 444 032</b>
0 460 415 987	<b>0 986 440 569</b>	0 460 494 286	<b>0 986 440 247</b>	0 470 504 021	<b>0 986 444 079</b>	0 470 506 014	<b>0 986 444 017</b>









◀ BOSCH-EXCHANGE

0986 435 105	<b>0986 435 105</b>	0986 435 175	<b>0986 435 293</b>	0986 435 240	<b>0986 435 240</b>	0986 435 356	<b>0986 435 356</b>
0986 435 106	<b>0986 435 106</b>	0986 435 176	<b>0986 435 176</b>	0986 435 241	<b>0986 435 241</b>	0986 435 357	<b>0986 435 357</b>
0986 435 108	<b>0986 435 107</b>	0986 435 177	<b>0986 435 177</b>	0986 435 242	<b>0986 435 242</b>	0986 435 358	<b>0986 435 358</b>
0986 435 109	<b>0986 435 109</b>	0986 435 178	<b>0986 435 178</b>	0986 435 243	<b>0986 435 243</b>	0986 435 359	<b>0986 435 359</b>
0986 435 111	<b>0986 435 111</b>	0986 435 179	<b>0986 435 179</b>	0986 435 244	<b>0986 435 244</b>	0986 435 360	<b>0986 435 360</b>
0986 435 113	<b>0986 435 113</b>	0986 435 180	<b>0986 435 180</b>	0986 435 245	<b>0986 435 245</b>	0986 435 362	<b>0986 435 362</b>
0986 435 115	<b>0986 435 115</b>	0986 435 181	<b>0986 435 181</b>	0986 435 246	<b>0986 435 290</b>	0986 435 363	<b>0986 435 363</b>
0986 435 117	<b>0986 435 117</b>	0986 435 182	<b>0986 435 182</b>	0986 435 247	<b>0986 435 247</b>	0986 435 364	<b>0986 435 364</b>
0986 435 120	<b>0986 435 120</b>	0986 435 183	<b>0986 435 183</b>	0986 435 248	<b>0986 435 212</b>	0986 435 365	<b>0986 435 352</b>
0986 435 122	<b>0986 435 122</b>	0986 435 184	<b>0986 435 184</b>	0986 435 248	<b>0986 435 248</b>	0986 435 366	<b>0986 435 360</b>
0986 435 123	<b>0986 435 123</b>	0986 435 186	<b>0986 435 186</b>	0986 435 251	<b>0986 435 251</b>	0986 435 367	<b>0986 435 367</b>
0986 435 124	<b>0986 435 124</b>	0986 435 187	<b>0986 435 187</b>	0986 435 252	<b>0986 435 252</b>	0986 435 368	<b>0986 435 367</b>
0986 435 125	<b>0986 435 125</b>	0986 435 188	<b>0986 435 188</b>	0986 435 253	<b>0986 435 253</b>	0986 435 370	<b>0986 435 369</b>
0986 435 127	<b>0986 435 127</b>	0986 435 189	<b>0986 435 189</b>	0986 435 254	<b>0986 435 254</b>	0986 435 372	<b>0986 435 372</b>
0986 435 128	<b>F 00E 200 440</b>	0986 435 190	<b>0986 435 190</b>	0986 435 255	<b>0986 435 255</b>	0986 435 374	<b>0986 435 374</b>
0986 435 128	<b>0986 435 128</b>	0986 435 191	<b>0986 435 191</b>	0986 435 256	<b>0986 435 256</b>	0986 435 375	<b>0986 435 374</b>
0986 435 133	<b>0986 435 133</b>	0986 435 192	<b>0986 435 192</b>	0986 435 257	<b>0986 435 257</b>	0986 435 376	<b>0986 435 388</b>
0986 435 135	<b>0986 435 135</b>	0986 435 193	<b>0986 435 193</b>	0986 435 258	<b>0986 435 258</b>	0986 435 377	<b>0986 435 377</b>
0986 435 139	<b>0986 435 139</b>	0986 435 194	<b>0986 435 194</b>	0986 435 259	<b>0986 435 259</b>	0986 435 378	<b>0986 435 357</b>
0986 435 143	<b>0986 435 143</b>	0986 435 195	<b>0986 435 195</b>	0986 435 260	<b>0986 435 202</b>	0986 435 378	<b>0986 435 377</b>
0986 435 144	<b>0986 435 144</b>	0986 435 196	<b>0986 435 196</b>	0986 435 261	<b>0986 435 261</b>	0986 435 379	<b>0986 435 357</b>
0986 435 145	<b>0986 435 145</b>	0986 435 197	<b>0986 435 197</b>	0986 435 262	<b>0986 435 262</b>	0986 435 380	<b>0986 435 380</b>
0986 435 146	<b>0986 435 146</b>	0986 435 198	<b>0986 435 198</b>	0986 435 263	<b>0986 435 263</b>	0986 435 381	<b>0986 435 380</b>
0986 435 147	<b>0986 435 147</b>	0986 435 198	<b>0986 435 291</b>	0986 435 264	<b>0986 435 234</b>	0986 435 383	<b>0986 435 382</b>
0986 435 148	<b>0986 435 148</b>	0986 435 199	<b>0986 435 199</b>	0986 435 265	<b>0986 435 265</b>	0986 435 385	<b>0986 435 384</b>
0986 435 149	<b>0986 435 149</b>	0986 435 200	<b>0986 435 200</b>	0986 435 266	<b>0986 435 266</b>	0986 435 387	<b>0986 435 386</b>
0986 435 150	<b>0986 435 150</b>	0986 435 201	<b>0986 435 201</b>	0986 435 267	<b>0986 435 292</b>	0986 435 388	<b>0986 435 388</b>
0986 435 151	<b>0986 435 151</b>	0986 435 202	<b>0986 435 202</b>	0986 435 268	<b>0986 435 268</b>	0986 435 389	<b>0986 435 356</b>
0986 435 152	<b>0986 435 152</b>	0986 435 203	<b>0986 435 203</b>	0986 435 269	<b>0986 435 269</b>	0986 435 390	<b>0986 435 390</b>
0986 435 153	<b>0986 435 153</b>	0986 435 204	<b>0986 435 204</b>	0986 435 273	<b>0986 435 273</b>	0986 435 391	<b>0986 435 391</b>
0986 435 154	<b>0986 435 154</b>	0986 435 205	<b>0986 435 205</b>	0986 435 274	<b>0986 435 235</b>	0986 435 392	<b>0986 435 392</b>
0986 435 155	<b>0986 435 155</b>	0986 435 206	<b>0986 435 206</b>	0986 435 275	<b>0986 435 236</b>	0986 435 393	<b>0986 435 393</b>
0986 435 156	<b>0986 435 156</b>	0986 435 207	<b>0986 435 207</b>	0986 435 276	<b>0986 435 276</b>	0986 435 394	<b>0986 435 394</b>
0986 435 157	<b>0986 435 157</b>	0986 435 208	<b>0986 435 208</b>	0986 435 277	<b>0986 435 277</b>	0986 435 395	<b>0986 435 395</b>
0986 435 158	<b>0986 435 053</b>	0986 435 209	<b>0986 435 209</b>	0986 435 278	<b>0986 435 278</b>	0986 435 396	<b>0986 435 396</b>
0986 435 158	<b>0986 435 158</b>	0986 435 210	<b>0986 435 210</b>	0986 435 279	<b>0986 435 279</b>	0986 435 397	<b>0986 435 396</b>
0986 435 159	<b>0986 435 159</b>	0986 435 211	<b>0986 435 211</b>	0986 435 280	<b>0986 435 280</b>	0986 435 398	<b>0986 435 398</b>
0986 435 160	<b>0986 435 160</b>	0986 435 212	<b>0986 435 212</b>	0986 435 281	<b>0986 435 295</b>	0986 435 400	<b>0986 435 400</b>
0986 435 161	<b>0986 435 161</b>	0986 435 212	<b>0986 435 248</b>	0986 435 286	<b>0986 435 286</b>	0986 435 401	<b>0986 435 400</b>
0986 435 162	<b>0986 435 162</b>	0986 435 213	<b>0986 435 213</b>	0986 435 288	<b>0986 435 288</b>	0986 435 402	<b>0986 435 402</b>
0986 435 163	<b>0986 435 163</b>	0986 435 214	<b>0986 435 214</b>	0986 435 289	<b>0986 435 289</b>	0986 435 403	<b>0986 435 403</b>
0986 435 164	<b>0986 435 053</b>	0986 435 226	<b>0986 435 226</b>	0986 435 290	<b>0986 435 290</b>	0986 435 404	<b>0986 435 404</b>
0986 435 164	<b>0986 435 164</b>	0986 435 227	<b>0986 435 227</b>	0986 435 291	<b>0986 435 291</b>	0986 435 406	<b>0986 435 406</b>
0986 435 165	<b>0986 435 165</b>	0986 435 230	<b>0986 435 230</b>	0986 435 292	<b>0986 435 292</b>	0986 435 408	<b>0986 435 408</b>
0986 435 166	<b>0986 435 166</b>	0986 435 231	<b>0986 435 231</b>	0986 435 293	<b>0986 435 293</b>	0986 435 409	<b>0 445 117 008</b>
0986 435 167	<b>0986 435 166</b>	0986 435 232	<b>0986 435 232</b>	0986 435 294	<b>0986 435 294</b>	0986 435 409	<b>0986 435 409</b>
0986 435 168	<b>0986 435 168</b>	0986 435 233	<b>0986 435 233</b>	0986 435 295	<b>0986 435 295</b>	0986 435 410	<b>0 445 117 010</b>
0986 435 169	<b>0986 435 168</b>	0986 435 234	<b>0986 435 234</b>	0986 435 296	<b>0986 435 296</b>	0986 435 410	<b>0986 435 410</b>
0986 435 170	<b>0986 435 170</b>	0986 435 235	<b>0986 435 235</b>	0986 435 297	<b>0986 435 297</b>	0986 435 411	<b>0986 435 411</b>
0986 435 170	<b>0986 435 236</b>	0986 435 235	<b>0986 435 274</b>	0986 435 298	<b>0986 435 298</b>	0986 435 412	<b>0986 435 412</b>
0986 435 170	<b>0986 435 275</b>	0986 435 236	<b>0986 435 170</b>	0986 435 350	<b>0986 435 350</b>	0986 435 413	<b>0986 435 413</b>
0986 435 172	<b>0986 435 172</b>	0986 435 236	<b>0986 435 236</b>	0986 435 352	<b>0986 435 352</b>	0986 435 414	<b>0986 435 414</b>
0986 435 173	<b>0986 435 173</b>	0986 435 236	<b>0986 435 275</b>	0986 435 353	<b>0986 435 353</b>	0986 435 415	<b>0986 435 415</b>
0986 435 174	<b>0986 435 174</b>	0986 435 237	<b>0986 435 237</b>	0986 435 354	<b>0986 435 354</b>	0986 435 416	<b>0986 435 416</b>
0986 435 175	<b>0986 435 175</b>	0986 435 239	<b>0986 435 239</b>	0986 435 355	<b>0986 435 355</b>	0986 435 417	<b>0986 435 417</b>



0986 435 418	<b>0986 435 418</b>	0986 435 531	<b>0986 435 531</b>	0986 435 592	<b>0986 435 592</b>	0986 437 016	<b>0986 437 106</b>
0986 435 419	<b>0986 435 419</b>	0986 435 533	<b>0986 435 533</b>	0986 435 593	<b>0986 435 593</b>	0986 437 017	<b>0986 437 017</b>
0986 435 420	<b>0986 435 420</b>	0986 435 536	<b>0986 435 536</b>	0986 435 597	<b>0986 435 597</b>	0986 437 018	<b>0986 437 018</b>
0986 435 421	<b>0986 435 421</b>	0986 435 537	<b>0986 435 537</b>	0986 435 598	<b>0986 435 598</b>	0986 437 019	<b>0986 437 019</b>
0986 435 422	<b>0986 435 422</b>	0986 435 539	<b>0986 435 539</b>	0986 435 617	<b>0986 435 617</b>	0986 437 020	<b>0986 437 020</b>
0986 435 423	<b>0986 435 423</b>	0986 435 542	<b>0986 435 542</b>	0986 435 621	<b>0986 435 621</b>	0986 437 021	<b>0986 437 021</b>
0986 435 424	<b>0986 435 424</b>	0986 435 543	<b>0986 435 543</b>	0986 435 622	<b>0986 435 622</b>	0986 437 022	<b>0986 437 022</b>
0986 435 425	<b>0986 435 425</b>	0986 435 544	<b>0986 435 544</b>	0986 435 624	<b>0986 435 624</b>	0986 437 023	<b>0986 437 023</b>
0986 435 426	<b>0986 435 350</b>	0986 435 545	<b>0986 435 545</b>	0986 435 625	<b>0986 435 625</b>	0986 437 024	<b>0986 437 024</b>
0986 435 427	<b>0986 435 427</b>	0986 435 546	<b>0986 435 546</b>	0986 435 626	<b>0986 435 626</b>	0986 437 024	<b>0986 437 201</b>
0986 435 428	<b>0986 435 428</b>	0986 435 547	<b>0986 435 547</b>	0986 435 632	<b>0986 435 632</b>	0986 437 025	<b>0986 437 025</b>
0986435429	<b>0986 435 429</b>	0986 435 548	<b>0986 435 548</b>	0986 435 633	<b>0986 435 633</b>	0986 437 026	<b>0986 437 026</b>
0986 435 430	<b>0986 435 430</b>	0986 435 549	<b>0986 435 549</b>	0986 435 634	<b>0986 435 634</b>	0986 437 027	<b>0986 437 027</b>
0986 435 431	<b>0986 435 431</b>	0986 435 550	<b>0986 435 550</b>	0986 435 635	<b>0986 435 635</b>	0986 437 028	<b>0986 437 028</b>
0986 435 432	<b>0986 435 432</b>	0986 435 551	<b>0986 435 551</b>	0986 435 636	<b>0986 435 636</b>	0986 437 029	<b>0986 437 029</b>
0986 435 433	<b>0986 435 433</b>	0986 435 552	<b>0986 435 552</b>	0986 435 637	<b>0986 435 637</b>	0986 437 030	<b>0986 437 030</b>
0986 435 434	<b>0986 435 434</b>	0986 435 555	<b>0986 435 555</b>	0986 435 638	<b>0986 435 638</b>	0986 437 031	<b>0986 437 031</b>
0986 435 435	<b>0986 435 435</b>	0986 435 557	<b>0986 435 557</b>	0986 435 639	<b>0986 435 639</b>	0986 437 032	<b>0986 437 032</b>
0986 435 437	<b>0986 435 437</b>	0986 435 557	<b>0986 435 677</b>	0986 435 640	<b>0986 435 640</b>	0986 437 033	<b>0986 437 033</b>
0986 435 439	<b>0986 435 439</b>	0986 435 558	<b>0986 435 558</b>	0986 435 642	<b>0986 435 642</b>	0986 437 034	<b>0986 437 034</b>
0986 435 441	<b>0986 435 441</b>	0986 435 559	<b>0986 435 559</b>	0986 435 643	<b>0445 120 257</b>	0986 437 035	<b>0986 437 035</b>
0986 435 443	<b>0986 435 443</b>	0986 435 561	<b>0986 435 561</b>	0986 435 644	<b>0445 120 267</b>	0986 437 036	<b>0986 437 036</b>
0986 435 444	<b>0986 435 428</b>	0986 435 562	<b>0986 435 562</b>	0986 435 644	<b>0445 120 384</b>	0986 437 037	<b>0986 437 044</b>
0986 435 445	<b>0986 435 445</b>	0986 435 563	<b>0986 435 563</b>	0986 435 644	<b>0986 435 644</b>	0986 437 038	<b>0986 437 038</b>
0986 435 450	<b>0986 435 450</b>	0986 435 564	<b>0986 435 564</b>	0986 435 645	<b>0445 120 161</b>	0986 437 039	<b>0986 437 039</b>
0986 435 451	<b>0986 435 451</b>	0986 435 565	<b>0986 435 565</b>	0986 435 646	<b>0986 435 646</b>	0986 437 040	<b>0986 437 019</b>
0986 435 453	<b>0986 435 453</b>	0986 435 566	<b>0986 435 566</b>	0986 435 647	<b>0986 435 647</b>	0986 437 041	<b>0986 437 041</b>
0986 435 455	<b>0986 435 455</b>	0986 435 567	<b>0986 435 567</b>	0986 435 650	<b>0986 435 650</b>	0986 437 042	<b>0986 437 042</b>
0986 435 457	<b>0986 435 457</b>	0986 435 568	<b>0986 435 568</b>	0986 435 652	<b>0986 435 652</b>	0986 437 043	<b>0986 437 043</b>
0986 435 501	<b>0986 435 501</b>	0986 435 569	<b>0986 435 569</b>	0986 435 655	<b>0986 435 655</b>	0986 437 044	<b>0986 437 044</b>
0986 435 502	<b>0445 120 008</b>	0986 435 570	<b>0986 435 570</b>	0986 435 656	<b>0986 435 656</b>	0986 437 045	<b>0986 437 045</b>
0986 435 502	<b>0986 435 502</b>	0986 435 571	<b>0986 435 571</b>	0986 435 658	<b>0986 435 658</b>	0986 437 046	<b>0986 437 094</b>
0986 435 503	<b>0986 435 503</b>	0986 435 572	<b>0986 435 572</b>	0986 435 660	<b>0986 435 660</b>	0986 437 047	<b>0986 437 047</b>
0986 435 504	<b>0986 435 504</b>	0986 435 573	<b>F 00E 200 419</b>	0986 435 662	<b>0986 435 662</b>	0986 437 048	<b>0986 437 048</b>
0986 435 505	<b>0986 435 505</b>	0986 435 573	<b>0986 435 573</b>	0986 435 663	<b>0986 435 663</b>	0986 437 050	<b>0986 437 027</b>
0986 435 506	<b>0986 435 506</b>	0986 435 574	<b>F 00E 200 420</b>	0986 435 670	<b>0986 435 670</b>	0986 437 051	<b>0986 437 072</b>
0986 435 507	<b>0986 435 507</b>	0986 435 574	<b>0986 435 574</b>	0986 435 671	<b>0986 435 671</b>	0986 437 052	<b>0986 437 047</b>
0986 435 508	<b>0986 435 508</b>	0986 435 575	<b>F 00E 200 425</b>	0986 435 672	<b>0986 435 672</b>	0986 437 053	<b>0986 437 041</b>
0986 435 509	<b>0986 435 509</b>	0986 435 575	<b>0986 435 575</b>	0986 435 674	<b>0986 435 674</b>	0986 437 054	<b>0986 437 086</b>
0986 435 512	<b>0986 435 512</b>	0986 435 576	<b>F 00E 200 435</b>	0986 435 677	<b>0986 435 677</b>	0986 437 056	<b>0986 437 045</b>
0986 435 515	<b>0986 435 515</b>	0986 435 576	<b>0986 435 576</b>	0986 437 001	<b>0986 437 001</b>	0986 437 058	<b>0986 437 039</b>
0986 435 517	<b>0986 435 517</b>	0986 435 577	<b>0986 435 577</b>	0986 437 002	<b>0986 437 002</b>	0986 437 059	<b>0986 437 033</b>
0986 435 518	<b>0986 435 518</b>	0986 435 578	<b>0986 435 578</b>	0986 437 003	<b>0986 437 100</b>	0986 437 062	<b>0986 437 032</b>
0986 435 520	<b>0986 435 520</b>	0986 435 579	<b>0986 435 517</b>	0986 437 004	<b>0986 437 004</b>	0986 437 063	<b>0986 437 094</b>
0986 435 521	<b>0986 435 521</b>	0986 435 580	<b>0986 435 526</b>	0986 437 005	<b>0986 437 005</b>	0986 437 064	<b>0986 437 070</b>
0986 435 522	<b>0445 120 236</b>	0986 435 581	<b>0986 435 527</b>	0986 437 006	<b>0986 437 006</b>	0986 437 065	<b>0986 437 071</b>
0986 435 522	<b>0986 435 522</b>	0986 435 581	<b>0986 435 528</b>	0986 437 007	<b>0986 437 101</b>	0986 437 066	<b>0986 437 095</b>
0986 435 523	<b>0986 435 523</b>	0986 435 583	<b>0986 435 558</b>	0986 437 008	<b>0986 437 102</b>	0986 437 069	<b>0986 437 097</b>
0986 435 524	<b>0986 435 524</b>	0986 435 584	<b>0986 435 561</b>	0986 437 009	<b>0986 437 009</b>	0986 437 070	<b>0986 437 070</b>
0986 435 525	<b>0986 435 525</b>	0986 435 585	<b>0986 435 562</b>	0986 437 010	<b>0986 437 010</b>	0986 437 071	<b>0986 437 071</b>
0986 435 526	<b>0986 435 526</b>	0986 435 586	<b>0986 435 563</b>	0986 437 011	<b>0986 437 103</b>	0986 437 072	<b>0986 437 072</b>
0986 435 527	<b>0986 435 527</b>	0986 435 587	<b>0986 435 565</b>	0986 437 012	<b>0986 437 012</b>	0986 437 082	<b>0986 437 082</b>
0986 435 528	<b>0986 435 528</b>	0986 435 588	<b>0986 435 569</b>	0986 437 013	<b>0986 437 104</b>	0986 437 085	<b>0986 437 085</b>
0986 435 529	<b>0986 435 529</b>	0986 435 589	<b>0986 435 570</b>	0986 437 014	<b>0986 437 100</b>	0986 437 086	<b>0986 437 086</b>
0986 435 530	<b>0986 435 530</b>	0986 435 591	<b>0986 435 568</b>	0986 437 015	<b>0986 437 015</b>	0986 437 092	<b>0986 437 093</b>





◀ BOSCH-EXCHANGE

0986 437 093	<b>0986 437 093</b>	0986 437 339	<b>0986 437 366</b>	0986 437 410	<b>0986 437 410</b>	0986 437 502	<b>0986 437 502</b>
0986 437 094	<b>0986 437 094</b>	0986 437 340	<b>0986 437 340</b>	0986 437 413	<b>0986 437 414</b>	0986 437 503	<b>0986 437 503</b>
0986 437 095	<b>0986 437 095</b>	0986 437 341	<b>0986 437 341</b>	0986 437 414	<b>0986 437 414</b>	0986 437 504	<b>0986 437 504</b>
0986 437 096	<b>0986 437 096</b>	0986 437 342	<b>0986 437 342</b>	0986 437 415	<b>0986 437 416</b>	0986 437 506	<b>F 00E 200 549</b>
0986 437 097	<b>0986 437 097</b>	0986 437 343	<b>0986 437 344</b>	0986 437 416	<b>0986 437 416</b>	0986 437 506	<b>0986 437 506</b>
0986 437 100	<b>0986 437 100</b>	0986 437 344	<b>0986 437 344</b>	0986 437 418	<b>0986 437 418</b>	0986 437 507	<b>0986 437 507</b>
0986 437 101	<b>0986 437 101</b>	0986 437 345	<b>0986 437 346</b>	0986 437 419	<b>0986 437 420</b>	0986 437 508	<b>0986 437 508</b>
0986 437 102	<b>0986 437 102</b>	0986 437 346	<b>0986 437 346</b>	0986 437 420	<b>0986 437 420</b>	0986 437 910	<b>0986 437 910</b>
0986 437 103	<b>0986 437 103</b>	0986 437 347	<b>0986 437 348</b>	0986 437 421	<b>0986 437 421</b>	0986 437 911	<b>0986 437 911</b>
0986 437 104	<b>0986 437 104</b>	0986 437 348	<b>0986 437 348</b>	0986 437 422	<b>0986 437 422</b>	0986 437 912	<b>0986 437 912</b>
0986 437 105	<b>0986 437 100</b>	0986 437 349	<b>0986 437 316</b>	0986 437 423	<b>0986 437 423</b>	0986 437 913	<b>0986 437 912</b>
0986 437 106	<b>0986 437 106</b>	0986 437 350	<b>0986 437 350</b>	0986 437 424	<b>0986 437 424</b>	0986 44D 000	<b>0986 44D 002</b>
0986 437 201	<b>0986 437 024</b>	0986 437 351	<b>0986 437 351</b>	0986 437 425	<b>0986 437 425</b>	0986 44D 001	<b>0 444 010 033</b>
0986 437 201	<b>0986 437 201</b>	0986 437 352	<b>0986 437 352</b>	0986 437 426	<b>0986 437 426</b>	0986 44D 001	<b>0986 44D 004</b>
0986 437 301	<b>0986 437 301</b>	0986 437 353	<b>0986 437 353</b>	0986 437 427	<b>0986 437 427</b>	0986 44D 002	<b>0 444 010 036</b>
0986 437 302	<b>0986 437 302</b>	0986 437 354	<b>0986 437 354</b>	0986 437 428	<b>0986 437 428</b>	0986 44D 002	<b>0986 44D 002</b>
0986 437 303	<b>0 445 020 005</b>	0986 437 355	<b>0986 437 355</b>	0986 437 429	<b>0986 437 429</b>	0986 44D 004	<b>0 444 010 033</b>
0986 437 303	<b>0 445 020 017</b>	0986 437 356	<b>0986 437 356</b>	0986 437 430	<b>0986 437 430</b>	0986 44D 004	<b>0986 44D 004</b>
0986 437 303	<b>0986 437 303</b>	0986 437 358	<b>0986 437 358</b>	0986 437 431	<b>0986 437 431</b>	0986 44D 106	<b>0986 44D 106</b>
0986 437 304	<b>0986 437 304</b>	0986 437 359	<b>0986 437 359</b>	0986 437 432	<b>0986 437 432</b>	0986 44D 110	<b>0986 44D 110</b>
0986 437 305	<b>0986 437 360</b>	0986 437 360	<b>0986 437 360</b>	0986 437 433	<b>0986 437 433</b>	0986 44D 111	<b>0986 44D 115</b>
0986 437 306	<b>0986 437 364</b>	0986 437 361	<b>0986 437 364</b>	0986 437 434	<b>0986 437 434</b>	0986 44D 112	<b>0986 44D 110</b>
0986 437 308	<b>0986 437 308</b>	0986 437 362	<b>0986 437 362</b>	0986 437 435	<b>0986 437 435</b>	0986 44D 115	<b>0986 44D 115</b>
0986 437 309	<b>0986 437 309</b>	0986 437 363	<b>0986 437 363</b>	0986 437 437	<b>0986 437 437</b>	0986 44D 120	<b>0986 44D 122</b>
0986 437 310	<b>0986 437 310</b>	0986 437 364	<b>0986 437 364</b>	0986 437 438	<b>0986 437 438</b>	0986 44D 120	<b>0986 44D 205</b>
0986 437 311	<b>0986 437 364</b>	0986 437 365	<b>0986 437 365</b>	0986 437 439	<b>0986 437 439</b>	0986 44D 120	<b>0986 44D 207</b>
0986 437 312	<b>0986 437 312</b>	0986 437 366	<b>0986 437 366</b>	0986 437 440	<b>0986 437 440</b>	0986 44D 121	<b>0986 44D 123</b>
0986 437 313	<b>0986 437 313</b>	0986 437 367	<b>0986 437 367</b>	0986 437 441	<b>0986 437 441</b>	0986 44D 121	<b>0986 44D 206</b>
0986 437 314	<b>0986 437 314</b>	0986 437 368	<b>0986 437 368</b>	0986 437 442	<b>0986 437 442</b>	0986 44D 121	<b>0986 44D 209</b>
0986 437 315	<b>0986 437 315</b>	0986 437 369	<b>0986 437 369</b>	0986 437 444	<b>0986 437 444</b>	0986 44D 122	<b>0986 44D 122</b>
0986 437 316	<b>0986 437 316</b>	0986 437 370	<b>0986 437 370</b>	0986 437 445	<b>0986 437 445</b>	0986 44D 122	<b>0986 44D 205</b>
0986 437 317	<b>0986 437 317</b>	0986 437 372	<b>0986 437 372</b>	0986 437 446	<b>0986 437 446</b>	0986 44D 122	<b>0986 44D 207</b>
0986 437 318	<b>0986 437 318</b>	0986 437 373	<b>0986 437 340</b>	0986 437 447	<b>0986 437 447</b>	0986 44D 123	<b>0986 44D 123</b>
0986 437 319	<b>0986 437 319</b>	0986 437 374	<b>0986 437 374</b>	0986 437 448	<b>0986 437 448</b>	0986 44D 123	<b>0986 44D 206</b>
0986 437 321	<b>0986 437 321</b>	0986 437 375	<b>0986 437 375</b>	0986 437 449	<b>0986 437 449</b>	0986 44D 123	<b>0986 44D 209</b>
0986 437 322	<b>0 445 010 089</b>	0986 437 376	<b>0986 437 351</b>	0986 437 451	<b>0986 437 451</b>	0986 44D 130	<b>0986 44D 106</b>
0986 437 322	<b>0986 437 322</b>	0986 437 377	<b>0986 437 352</b>	0986 437 452	<b>0986 437 452</b>	0986 44D 131	<b>0 444 022 021</b>
0986 437 323	<b>0986 437 323</b>	0986 437 378	<b>0986 437 353</b>	0986 437 453	<b>0986 437 453</b>	0986 44D 131	<b>0986 44D 131</b>
0986 437 324	<b>0986 437 367</b>	0986 437 379	<b>0986 437 383</b>	0986 437 454	<b>0986 437 454</b>	0986 44D 132	<b>0 444 022 021</b>
0986 437 325	<b>0986 437 325</b>	0986 437 380	<b>0986 437 359</b>	0986 437 455	<b>0986 437 455</b>	0986 44D 132	<b>0986 44D 131</b>
0986 437 326	<b>0986 437 362</b>	0986 437 381	<b>0986 437 350</b>	0986 437 456	<b>0986 437 456</b>	0986 44D 133	<b>0 444 022 021</b>
0986 437 327	<b>0986 437 363</b>	0986 437 383	<b>0986 437 383</b>	0986 437 457	<b>0986 437 457</b>	0986 44D 133	<b>0986 44D 131</b>
0986 437 328	<b>0986 437 364</b>	0986 437 384	<b>0986 437 384</b>	0986 437 458	<b>0986 437 458</b>	0986 44D 134	<b>0986 44D 115</b>
0986 437 329	<b>0986 437 365</b>	0986 437 385	<b>0986 437 385</b>	0986 437 459	<b>0986 437 459</b>	0986 44D 135	<b>0986 44D 110</b>
0986 437 330	<b>0986 437 368</b>	0986 437 386	<b>0986 437 386</b>	0986 437 460	<b>0986 437 460</b>	0986 44D 136	<b>0986 44D 110</b>
0986 437 331	<b>F 00E 200 391</b>	0986 437 388	<b>0986 437 341</b>	0986 437 461	<b>0986 437 461</b>	0986 44D 200	<b>0986 44D 200</b>
0986 437 332	<b>F 00E 200 431</b>	0986 437 389	<b>0986 437 389</b>	0986 437 462	<b>0986 437 462</b>	0986 44D 201	<b>0986 44D 200</b>
0986 437 332	<b>0 445 020 105</b>	0986 437 401	<b>0986 437 401</b>	0986 437 463	<b>0986 437 463</b>	0986 44D 202	<b>0986 44D 200</b>
0986 437 333	<b>0986 437 333</b>	0986 437 402	<b>0986 437 402</b>	0986 437 465	<b>0986 437 465</b>	0986 44D 203	<b>0986 44D 205</b>
0986 437 334	<b>F 00E 200 392</b>	0986 437 403	<b>0986 437 403</b>	0986 437 466	<b>0986 437 466</b>	0986 44D 204	<b>0986 44D 206</b>
0986 437 334	<b>0 445 020 146</b>	0986 437 404	<b>0986 437 404</b>	0986 437 467	<b>0986 437 437</b>	0986 44D 205	<b>0986 44D 205</b>
0986 437 334	<b>0986 437 334</b>	0986 437 406	<b>0986 437 406</b>	0986 437 468	<b>0986 437 468</b>	0986 44D 206	<b>0986 44D 206</b>
0986 437 335	<b>0986 437 335</b>	0986 437 407	<b>0986 437 410</b>	098643750	<b>0 445 020 126</b>	0986 44D 207	<b>0986 44D 207</b>
0986 437 337	<b>0986 437 337</b>	0986 437 408	<b>0986 437 410</b>	0986 437 501	<b>0986 437 501</b>	0986 44D 208	<b>0986 44D 207</b>
0986 437 338	<b>0986 437 338</b>	0986 437 409	<b>0986 437 410</b>	0986 437 502	<b>F 00E 200 432</b>	0986 44D 209	<b>0986 44D 209</b>



0986 44D 210	<b>0986 44D 209</b>	0986 440 063	<b>0986 440 063</b>	0986 440 241	<b>0986 440 241</b>	0986 440 538	<b>0986 440 538</b>
0986 44D 211	<b>0986 44D 211</b>	0986 440 064	<b>0986 440 064</b>	0986 440 242	<b>0986 440 242</b>	0986 440 540	<b>0986 440 567</b>
0986 44D 213	<b>0986 44D 213</b>	0986 440 065	<b>0986 440 065</b>	0986 440 243	<b>0986 440 243</b>	0986 440 543	<b>0986 440 568</b>
0986 44D 215	<b>0986 44D 215</b>	0986 440 066	<b>0986 440 066</b>	0986 440 244	<b>0986 440 244</b>	0986 440 544	<b>0986 440 569</b>
0986 44D 217	<b>0986 44D 217</b>	0986 440 076	<b>0986 440 076</b>	0986 440 246	<b>0986 440 246</b>	0986 440 547	<b>0986 440 570</b>
0986 44D 219	<b>0986 44D 219</b>	0986 440 084	<b>0986 440 084</b>	0986 440 247	<b>0986 440 247</b>	0986 440 549	<b>0986 440 571</b>
0986 44D 222	<b>0986 44D 222</b>	0986 440 086	<b>0986 440 237</b>	0986 440 248	<b>0986 440 248</b>	0986 440 550	<b>0986 440 550</b>
0986 44D 223	<b>0986 44D 222</b>	0986 440 087	<b>0986 440 238</b>	0986 440 249	<b>0986 440 249</b>	0986 440 551	<b>0986 440 551</b>
0986 44D 224	<b>0986 44D 224</b>	0986 440 091	<b>0986 440 239</b>	0986 440 251	<b>0986 440 251</b>	0986 440 552	<b>0986 440 552</b>
0986 44D 225	<b>0986 44D 224</b>	0986 440 094	<b>0986 440 094</b>	0986 440 252	<b>0986 440 252</b>	0986 440 553	<b>0986 440 553</b>
0986 44D 226	<b>0986 44D 222</b>	0986 440 103	<b>0986 440 240</b>	0986 440 253	<b>0986 440 253</b>	0986 440 554	<b>0986 440 554</b>
0986 44D 227	<b>0986 44D 224</b>	0986 440 104	<b>0986 440 241</b>	0986 440 254	<b>0986 440 254</b>	0986 440 555	<b>0986 440 555</b>
0986 44D 228	<b>0986 44D 228</b>	0986 440 107	<b>0986 440 107</b>	0986 440 255	<b>0986 440 255</b>	0986 440 556	<b>0986 440 556</b>
0986 44D 229	<b>0986 44D 228</b>	0986 440 108	<b>0986 440 242</b>	0986 440 256	<b>0986 440 256</b>	0986 440 557	<b>0986 440 557</b>
0986 44D 230	<b>0986 44D 230</b>	0986 440 109	<b>0986 440 243</b>	0986 440 257	<b>0986 440 257</b>	0986 440 558	<b>0986 440 558</b>
0986 44D 231	<b>0986 44D 230</b>	0986 440 110	<b>0986 440 244</b>	0986 440 501	<b>0986 440 551</b>	0986 440 559	<b>0986 440 559</b>
0986 44D 232	<b>0986 44D 232</b>	0986 440 113	<b>0986 440 113</b>	0986 440 502	<b>0986 440 552</b>	0986 440 560	<b>0986 440 560</b>
0986 44D 233	<b>0986 44D 232</b>	0986 440 118	<b>0986 440 246</b>	0986 440 503	<b>0986 440 553</b>	0986 440 561	<b>0986 440 561</b>
0986 44D 280	<b>0986 44D 280</b>	0986 440 123	<b>0986 440 123</b>	0986 440 504	<b>0986 440 554</b>	0986 440 562	<b>0986 440 562</b>
0986 44D 282	<b>0986 44D 282</b>	0986 440 125	<b>0986 440 125</b>	0986 440 505	<b>0986 440 555</b>	0986 440 563	<b>0986 440 563</b>
0986 44D 284	<b>0986 44D 284</b>	0986 440 135	<b>0986 440 135</b>	0986 440 506	<b>0986 440 556</b>	0986 440 564	<b>0986 440 564</b>
0986 44D 286	<b>0986 44D 286</b>	0986 440 139	<b>0986 440 247</b>	0986 440 507	<b>0986 440 507</b>	0986 440 565	<b>0986 440 565</b>
0986 44D 288	<b>0986 44D 288</b>	0986 440 141	<b>0986 440 248</b>	0986 440 508	<b>0986 440 508</b>	0986 440 566	<b>0986 440 566</b>
0986 44D 290	<b>0986 44D 290</b>	0986 440 142	<b>0986 440 142</b>	0986 440 509	<b>0986 440 557</b>	0986 440 567	<b>0986 440 567</b>
0986 44D 320	<b>0986 44D 320</b>	0986 440 143	<b>0986 440 143</b>	0986 440 510	<b>0986 440 568</b>	0986 440 568	<b>0986 440 568</b>
0986 440 002	<b>0986 440 002</b>	0986 440 146	<b>0986 440 146</b>	0986 440 511	<b>0986 440 558</b>	0986 440 569	<b>0986 440 569</b>
0986 440 011	<b>0986 440 233</b>	0986 440 148	<b>0986 440 249</b>	0986 440 512	<b>0986 440 512</b>	0986 440 570	<b>0986 440 570</b>
0986 440 012	<b>0986 440 234</b>	0986 440 149	<b>0986 440 149</b>	0986 440 513	<b>0986 440 559</b>	0986 440 571	<b>0986 440 571</b>
0986 440 015	<b>0986 440 015</b>	0986 440 150	<b>0986 440 150</b>	0986 440 514	<b>0986 440 560</b>	0986 440 576	<b>0986 440 525</b>
0986 440 016	<b>0986 440 016</b>	0986 440 152	<b>0986 440 152</b>	0986 440 515	<b>0986 440 515</b>	0986 440 576	<b>0986 440 576</b>
0986 440 017	<b>0986 440 017</b>	0986 440 155	<b>0986 440 257</b>	0986 440 516	<b>0986 440 516</b>	0986 440 577	<b>0986 440 527</b>
0986 440 018	<b>0986 440 235</b>	0986 440 156	<b>0986 440 156</b>	0986 440 517	<b>0986 440 517</b>	0986 440 577	<b>0986 440 577</b>
0986 440 019	<b>0986 440 236</b>	0986 440 161	<b>0986 440 161</b>	0986 440 518	<b>0986 440 518</b>	0986 440 578	<b>0986 440 530</b>
0986 440 021	<b>0986 440 021</b>	0986 440 163	<b>0986 440 163</b>	0986 440 519	<b>0986 440 561</b>	0986 440 578	<b>0986 440 578</b>
0986 440 023	<b>0986 440 023</b>	0986 440 205	<b>0986 440 205</b>	0986 440 520	<b>0986 440 520</b>	0986 440 579	<b>0986 440 579</b>
0986 440 024	<b>0986 440 024</b>	0986 440 206	<b>0986 440 250</b>	0986 440 522	<b>0986 440 522</b>	0986 440 580	<b>0986 440 533</b>
0986 440 027	<b>0986 440 027</b>	0986 440 207	<b>0986 440 251</b>	0986 440 523	<b>0986 440 523</b>	0986 440 580	<b>0986 440 580</b>
0986 440 028	<b>0986 440 028</b>	0986 440 208	<b>0986 440 252</b>	0986 440 524	<b>0986 440 524</b>	0986 441 001	<b>0986 441 101</b>
0986 440 032	<b>0986 440 032</b>	0986 440 209	<b>0986 440 253</b>	0986 440 525	<b>0986 440 525</b>	0986 441 002	<b>0986 441 102</b>
0986 440 033	<b>0986 440 033</b>	0986 440 214	<b>0986 440 254</b>	0986 440 525	<b>0986 440 576</b>	0986 441 003	<b>0986 441 103</b>
0986 440 035	<b>0986 440 035</b>	0986 440 215	<b>0986 440 255</b>	0986 440 526	<b>0986 440 562</b>	0986 441 004	<b>0414 701 055</b>
0986 440 038	<b>0986 440 038</b>	0986 440 217	<b>0986 440 217</b>	0986 440 527	<b>0986 440 527</b>	0986 441 004	<b>0986 441 004</b>
0986 440 040	<b>0986 440 040</b>	0986 440 219	<b>0986 440 219</b>	0986 440 527	<b>0986 440 577</b>	0986 441 005	<b>0986 441 005</b>
0986 440 041	<b>0986 440 041</b>	0986 440 225	<b>0986 440 225</b>	0986 440 528	<b>0986 440 563</b>	0986 441 005	<b>0986 441 905</b>
0986 440 042	<b>0986 440 042</b>	0986 440 226	<b>0986 440 226</b>	0986 440 529	<b>0986 440 564</b>	0986 441 006	<b>0986 441 106</b>
0986 440 043	<b>0986 440 043</b>	0986 440 228	<b>0986 440 228</b>	0986 440 530	<b>0986 440 530</b>	0986 441 007	<b>0986 441 107</b>
0986 440 046	<b>0986 440 046</b>	0986 440 229	<b>0986 440 256</b>	0986 440 530	<b>0986 440 578</b>	0986 441 008	<b>0986 441 108</b>
0986 440 048	<b>0986 440 048</b>	0986 440 233	<b>0986 440 233</b>	0986 440 531	<b>0986 440 531</b>	0986 441 009	<b>0986 441 109</b>
0986 440 051	<b>0986 440 051</b>	0986 440 234	<b>0986 440 234</b>	0986 440 531	<b>0986 440 579</b>	0986 441 010	<b>0986 441 110</b>
0986 440 052	<b>0986 440 052</b>	0986 440 235	<b>0986 440 235</b>	0986 440 532	<b>0986 440 563</b>	0986 441 011	<b>0986 441 111</b>
0986 440 053	<b>0986 440 053</b>	0986 440 236	<b>0986 440 236</b>	0986 440 533	<b>0986 440 533</b>	0986 441 012	<b>0986 441 112</b>
0986 440 054	<b>0986 440 054</b>	0986 440 237	<b>0986 440 237</b>	0986 440 533	<b>0986 440 580</b>	0986 441 013	<b>0986 441 113</b>
0986 440 055	<b>0986 440 055</b>	0986 440 238	<b>0986 440 238</b>	0986 440 534	<b>0986 440 565</b>	0986 441 014	<b>0986 441 114</b>
0986 440 056	<b>0986 440 056</b>	0986 440 239	<b>0986 440 239</b>	0986 440 535	<b>0986 440 535</b>	0986 441 015	<b>0986 441 115</b>
0986 440 062	<b>0986 440 062</b>	0986 440 240	<b>0986 440 240</b>	0986 440 536	<b>0986 440 566</b>	0986 441 016	<b>0986 441 116</b>





◀ BOSCH-EXCHANGE

0986 441 020	<b>0986 441 020</b>	0986 441 554	<b>0986 441 554</b>	0986 444 023	<b>0986 444 023</b>	0986 444 084	<b>0986 444 084</b>
0986 441 024	<b>0986 441 024</b>	0986 441 555	<b>0986 441 555</b>	0986 444 024	<b>0 470 506 029</b>	0986 444 085	<b>0986 444 047</b>
0986 441 025	<b>0986 441 025</b>	0986 441 556	<b>0986 441 556</b>	0986 444 024	<b>0986 444 009</b>	0986 444 085	<b>0986 444 085</b>
0986 441 026	<b>0986 441 026</b>	0986 441 557	<b>0986 441 557</b>	0986 444 024	<b>0986 444 024</b>	0986 444 086	<b>0986 444 086</b>
0986 441 027	<b>0986 441 027</b>	0986 441 559	<b>0986 441 559</b>	0986 444 024	<b>0986 444 032</b>	0986 444 087	<b>0986 444 087</b>
0986 441 028	<b>0986 441 028</b>	0986 441 560	<b>0986 441 560</b>	0986 444 028	<b>0986 444 028</b>	0986 444 088	<b>0986 444 088</b>
0986 441 029	<b>0986 441 029</b>	0986 441 561	<b>0986 441 561</b>	0986 444 029	<b>0986 444 029</b>	0986 444 089	<b>0986 444 089</b>
0986 441 031	<b>0986 441 031</b>	0986 441 562	<b>0986 441 562</b>	0986 444 030	<b>0986 444 030</b>	0986 444 090	<b>0986 444 090</b>
0986 441 101	<b>0986 441 101</b>	0986 441 563	<b>0986 441 563</b>	0986 444 031	<b>0986 444 007</b>	0986 444 091	<b>0986 444 091</b>
0986 441 102	<b>0986 441 102</b>	0986 441 564	<b>0986 441 564</b>	0986 444 031	<b>0986 444 022</b>	0986 444 092	<b>0986 444 010</b>
0986 441 103	<b>0986 441 103</b>	0986 441 565	<b>0986 441 565</b>	0986 444 031	<b>0986 444 031</b>	0986 444 092	<b>0986 444 092</b>
0986 441 106	<b>0986 441 106</b>	0986 441 566	<b>0986 441 566</b>	0986 444 032	<b>0986 444 009</b>	0986 444 099	<b>0986 444 014</b>
0986 441 107	<b>0986 441 107</b>	0986 441 567	<b>0986 441 567</b>	0986 444 032	<b>0986 444 024</b>	0986 444 500	<b>0986 444 500</b>
0986 441 108	<b>0986 441 108</b>	0986 441 568	<b>0986 441 568</b>	0986 444 032	<b>0986 444 032</b>	0986 444 501	<b>0986 444 519</b>
0986 441 109	<b>0986 441 109</b>	0986 441 569	<b>0986 441 569</b>	0986 444 035	<b>0986 444 035</b>	0986 444 502	<b>0986 444 520</b>
0986 441 110	<b>0986 441 110</b>	0986 441 570	<b>0986 441 570</b>	0986 444 036	<b>0986 444 036</b>	0986 444 503	<b>0986 444 503</b>
0986 441 111	<b>0986 441 111</b>	0986 441 571	<b>0986 441 571</b>	0986 444 037	<b>0986 444 037</b>	0986 444 504	<b>0986 444 521</b>
0986 441 112	<b>0986 441 112</b>	0986 441 572	<b>0986 441 572</b>	0986 444 039	<b>0986 444 039</b>	0986 444 506	<b>0986 444 522</b>
0986 441 113	<b>0986 441 113</b>	0986 441 573	<b>0986 441 573</b>	0986 444 042	<b>0986 444 082</b>	0986 444 506	<b>0986 444 523</b>
0986 441 114	<b>0986 441 114</b>	0986 441 574	<b>0986 441 574</b>	0986 444 043	<b>0986 444 083</b>	0986 444 507	<b>0986 444 507</b>
0986 441 115	<b>0986 441 115</b>	0986 441 575	<b>0986 441 575</b>	0986 444 044	<b>0986 444 084</b>	0986 444 508	<b>0986 444 508</b>
0986 441 116	<b>0986 441 116</b>	0986 441 576	<b>0986 441 576</b>	0986 444 045	<b>0986 444 045</b>	0986 444 509	<b>0 470 006 005</b>
0986 441 120	<b>0986 441 120</b>	0986 441 577	<b>0986 441 577</b>	0986 444 046	<b>0986 444 046</b>	0986 444 509	<b>0986 444 509</b>
0986 441 501	<b>0986 441 551</b>	0986 441 578	<b>0986 441 578</b>	0986 444 047	<b>0986 444 047</b>	0986 444 510	<b>0986 444 510</b>
0986 441 502	<b>0986 441 552</b>	0986 441 579	<b>0986 441 579</b>	0986 444 048	<b>0986 444 086</b>	0986 444 511	<b>0986 444 511</b>
0986 441 503	<b>0986 441 553</b>	0986 441 580	<b>0986 441 580</b>	0986 444 049	<b>0986 444 087</b>	0986 444 516	<b>0986 444 516</b>
0986 441 504	<b>0986 441 554</b>	0986 444 001	<b>0986 444 001</b>	0986 444 050	<b>0986 444 088</b>	0986 444 517	<b>0986 444 517</b>
0986 441 505	<b>0986 441 555</b>	0986 444 002	<b>0986 444 002</b>	0986 444 051	<b>0986 444 089</b>	0986 444 518	<b>0986 444 518</b>
0986 441 506	<b>0986 441 556</b>	0986 444 003	<b>0986 444 003</b>	0986 444 052	<b>0986 444 052</b>	0986 444 519	<b>0986 444 519</b>
0986 441 507	<b>0986 441 557</b>	0986 444 004	<b>0986 444 004</b>	0986 444 053	<b>0986 444 053</b>	0986 444 520	<b>0986 444 520</b>
0986 441 509	<b>0986 441 559</b>	0986 444 005	<b>0986 444 005</b>	0986 444 054	<b>0986 444 054</b>	0986 444 521	<b>0986 444 521</b>
0986 441 510	<b>0986 441 560</b>	0986 444 006	<b>0986 444 006</b>	0986 444 055	<b>0986 444 090</b>	0986 444 522	<b>0986 444 522</b>
0986 441 511	<b>0986 441 561</b>	0986 444 007	<b>0986 444 007</b>	0986 444 056	<b>0986 444 056</b>	0986 444 523	<b>0986 444 522</b>
0986 441 512	<b>0986 441 562</b>	0986 444 007	<b>0986 444 022</b>	0986 444 057	<b>0986 444 057</b>	0986 444 523	<b>0986 444 523</b>
0986 441 513	<b>0986 441 563</b>	0986 444 007	<b>0986 444 031</b>	0986 444 058	<b>0986 444 058</b>	0986 445 001	<b>0986 445 001</b>
0986 441 514	<b>0986 441 564</b>	0986 444 009	<b>0 470 506 029</b>	0986 444 063	<b>0986 444 063</b>	0986 445 001	<b>0986 445 004</b>
0986 441 515	<b>0986 441 565</b>	0986 444 009	<b>0986 444 009</b>	0986 444 064	<b>0986 444 091</b>	0986 445 002	<b>F 00E 200 401</b>
0986 441 516	<b>0986 441 566</b>	0986 444 009	<b>0986 444 024</b>	0986 444 067	<b>0986 444 067</b>	0986 445 002	<b>0986 445 102</b>
0986 441 517	<b>0986 441 567</b>	0986 444 009	<b>0986 444 032</b>	0986 444 068	<b>0986 444 008</b>	0986 445 003	<b>0986 445 103</b>
0986 441 518	<b>0986 441 568</b>	0986 444 010	<b>0986 444 010</b>	0986 444 068	<b>0986 444 068</b>	0986 445 005	<b>0986 445 005</b>
0986 441 519	<b>0986 441 569</b>	0986 444 012	<b>0986 444 012</b>	0986 444 070	<b>0986 444 070</b>	0986 445 006	<b>0986 445 056</b>
0986 441 520	<b>0986 441 570</b>	0986 444 013	<b>0986 444 013</b>	0986 444 071	<b>0986 444 071</b>	0986 445 007	<b>F 00E 200 406</b>
0986 441 521	<b>0986 441 571</b>	0986 444 014	<b>0986 444 014</b>	0986 444 072	<b>0986 444 072</b>	0986 445 008	<b>0986 445 008</b>
0986 441 522	<b>0986 441 572</b>	0986 444 015	<b>0986 444 070</b>	0986 444 073	<b>0986 444 073</b>	0986 445 010	<b>F 00E 200 404</b>
0986 441 523	<b>0986 441 573</b>	0986 444 017	<b>0986 444 017</b>	0986 444 074	<b>0986 444 074</b>	0986 445 010	<b>0986 445 110</b>
0986 441 524	<b>0986 441 574</b>	0986 444 017	<b>0986 444 023</b>	0986 444 075	<b>0986 444 075</b>	0986 445 011	<b>0986 445 011</b>
0986 441 525	<b>0986 441 575</b>	0986 444 018	<b>0986 444 007</b>	0986 444 076	<b>0986 444 076</b>	0986 445 013	<b>0986 445 013</b>
0986 441 526	<b>0986 441 576</b>	0986 444 018	<b>0986 444 018</b>	0986 444 077	<b>0986 444 039</b>	0986 445 014	<b>0986 445 114</b>
0986 441 527	<b>0986 441 577</b>	0986 444 018	<b>0986 444 022</b>	0986 444 077	<b>0986 444 077</b>	0986 445 015	<b>0986 445 115</b>
0986 441 528	<b>0986 441 578</b>	0986 444 018	<b>0986 444 031</b>	0986 444 078	<b>0986 444 078</b>	0986 445 016	<b>F 00E 200 402</b>
0986 441 529	<b>0986 441 579</b>	0986 444 019	<b>0986 444 019</b>	0986 444 079	<b>0986 444 079</b>	0986 445 016	<b>0986 445 016</b>
0986 441 530	<b>0986 441 580</b>	0986 444 021	<b>0986 444 021</b>	0986 444 080	<b>0986 444 080</b>	0986 445 017	<b>F 00E 200 407</b>
0986 441 551	<b>0986 441 551</b>	0986 444 022	<b>0986 444 022</b>	0986 444 081	<b>0986 444 081</b>	0986 445 017	<b>0 414 799 012</b>
0986 441 552	<b>0986 441 552</b>	0986 444 022	<b>0986 444 031</b>	0986 444 082	<b>0986 444 082</b>	0986 445 017	<b>0986 445 017</b>
0986 441 553	<b>0986 441 553</b>	0986 444 023	<b>0986 444 017</b>	0986 444 083	<b>0986 444 083</b>	0986 445 018	<b>F 00E 200 408</b>



0 986 445 018	<b>0 986 445 018</b>
0 986 445 019	<b>F 00E 200 409</b>
0 986 445 019	<b>0 986 445 019</b>
0 986 445 020	<b>F 00E 200 410</b>
0 986 445 020	<b>0 986 445 020</b>

0 986 445 021	<b>F 00E 200 412</b>
0 986 445 021	<b>0 414 799 017</b>
0 986 445 021	<b>0 986 445 021</b>
0 986 445 022	<b>F 00E 200 413</b>
0 986 445 022	<b>0 414 799 024</b>

0 986 445 022	<b>0 986 445 022</b>
0 986 445 023	<b>F 00E 200 414</b>
0 986 445 023	<b>0 986 445 023</b>
0 986 445 024	<b>F 00E 200 415</b>
0 986 445 025	<b>F 00E 200 416</b>

0 986 445 025	<b>0 986 445 025</b>
0 986 445 026	<b>F 00E 200 417</b>
0 986 445 029	<b>0 986 445 016</b>
0 986 445 031	<b>0 986 445 022</b>
0 986 445 032	<b>0 986 445 020</b>

0 986 445 033	<b>0 986 445 019</b>
0 986 445 034	<b>0 986 445 021</b>
0 986 445 035	<b>0 986 445 018</b>
0 986 445 036	<b>0 986 445 025</b>
0 986 445 037	<b>0 986 445 023</b>

0 986 445 056	<b>F 00E 200 405</b>
0 986 445 056	<b>0 986 445 056</b>
0 986 445 102	<b>F 00E 200 401</b>
0 986 445 102	<b>0 986 445 102</b>
0 986 445 103	<b>F 00E 200 403</b>

0 986 445 103	<b>0 986 445 103</b>
0 986 445 110	<b>F 00E 200 404</b>
0 986 445 110	<b>0 986 445 110</b>
0 986 445 114	<b>0 986 445 114</b>
0 986 445 115	<b>0 986 445 115</b>

1 682 666 411	<b>1 682 666 411</b>
444042004	<b>F 00E 200 528</b>
444042014	<b>F 00E 200 528</b>
9 430 610 006	<b>0 986 433 010</b>
9 430 610 029	<b>0 986 433 012</b>

9 430 610 033	<b>0 986 433 006</b>
9 430 610 037	<b>0 986 433 011</b>
9 430 610 045	<b>0 986 433 005</b>
9 430 610 060	<b>0 986 433 004</b>
9 430 610 065	<b>0 986 433 009</b>

9 430 610 098	<b>0 986 433 013</b>
9 430 610 101	<b>0 986 433 004</b>
9 430 610 105	<b>0 986 433 008</b>
9 430 610 121	<b>0 986 433 000</b>
9 430 610 122	<b>0 986 433 001</b>

9 430 610 128	<b>0 986 433 002</b>
9 430 610 132	<b>0 986 433 007</b>
9 430 610 136	<b>0 986 433 004</b>
9 430 610 137	<b>0 986 433 005</b>
9 430 610 140	<b>0 986 433 001</b>

9 430 610 161	<b>0 986 433 000</b>
9 460 610 596	<b>9 460 610 596</b>
9 460 620 008	<b>9 460 620 008</b>
9 460 620 010	<b>9 460 620 010</b>
9 460 620 015	<b>9 460 620 015</b>

9 460 620 017	<b>9 460 620 017</b>
---------------	----------------------

### CADILLAC

90528435	<b>0 281 002 184</b>
90530442	<b>0 280 217 519</b>
90541591	<b>0 280 217 519</b>

### CAMC

1205A84RQ-010-7	<b>0 444 043 075</b>
618DB1124006A	<b>0 445 120 364</b>
628DB1124006A	<b>0 445 120 352</b>

### CARDONE

74-10130	<b>0 280 218 230</b>
74-10130	<b>0 280 218 234</b>
7410179	<b>0 280 218 198</b>

7410231	<b>0 280 217 525</b>
74-10273	<b>0 280 218 214</b>

### CASE

A 156323	<b>0 432 131 866</b>
A 156329	<b>0 432 131 883</b>
ER5801790338	<b>0 445 110 657</b>

F 1243293	<b>0 432 291 753</b>
F2NN 9F5 93 BB	<b>0 432 191 687</b>
J 908187	<b>0 460 424 046</b>
J 908507	<b>0 432 191 812</b>
J 908511	<b>0 432 191 796</b>

J 908513	<b>0 432 191 794</b>
J 909476	<b>0 432 131 880</b>
J 909532	<b>0 432 131 875</b>
J 911340	<b>0 432 131 869</b>
J 916934	<b>0 460 426 157</b>

J 917027	<b>0 460 424 059</b>
J 919300	<b>0 432 131 834</b>
J 919 343	<b>0 432 131 835</b>
J 919602	<b>0 432 191 738</b>
J 919846	<b>0 460 424 081</b>

J 926 787	<b>0 432 191 632</b>
J 928658	<b>0 460 424 243</b>
J 931735	<b>0 432 191 531</b>
J 931945	<b>0 432 191 576</b>
J 939837	<b>0 432 191 335</b>

J 948529	<b>0 432 191 426</b>
131100080125	<b>0 432 291 619</b>
1329 154 C1	<b>0 986 440 015</b>
162000080855	<b>0 470 006 008</b>
1967 078 C1	<b>0 460 414 084</b>

2830 957	<b>0 445 120 212</b>
2830957	<b>0 986 435 508</b>
2852 046	<b>0 460 424 282</b>
2852 056	<b>0 432 133 780</b>
2852 096	<b>0 432 131 626</b>

2852 167	<b>0 460 424 304</b>
2852 272	<b>0 460 424 274</b>
2852 273	<b>0 432 133 775</b>
2852 342	<b>0 460 426 371</b>
2852 545	<b>0 460 424 286</b>

2852 847	<b>0 460 426 374</b>
2852 853	<b>0 460 424 314</b>
2852 856	<b>0 460 424 284</b>
2852 858	<b>0 432 133 782</b>
2852 869	<b>0 432 133 779</b>

2853 041	<b>0 460 423 003</b>
2853 079	<b>0 460 424 343</b>
2853 343	<b>0 460 426 370</b>
2853 346	<b>0 432 133 771</b>
2853 392	<b>0 460 424 308</b>

2853 524	<b>0 460 424 349</b>
2853 526	<b>0 460 426 410</b>
2853 527	<b>0 460 426 411</b>
2853 528	<b>0 460 426 412</b>
2853 529	<b>0 460 424 351</b>

2853 530	<b>0 460 426 415</b>
2853 682	<b>0 460 424 333</b>
2853 683	<b>0 460 424 346</b>
2853 689	<b>0 460 424 329</b>
2853 810	<b>0 460 424 268</b>

2853 975	<b>0 460 424 316</b>
2854 021	<b>0 460 426 357</b>
2854 045	<b>0 432 133 774</b>
2854 608	<b>0 445 120 057</b>
2854 608	<b>0 986 435 552</b>

2854 716	<b>0 460 424 379</b>
2855 084	<b>0 460 423 013</b>
2855 135	<b>0 445 120 075</b>
2855 135	<b>0 986 435 530</b>
2855392	<b>0 460 426 453</b>

2855396	<b>0 460 426 455</b>
2855399	<b>0 432 133 764</b>
2855 491	<b>0 445 120 054</b>
2855 491	<b>0 986 435 545</b>
2855491R	<b>0 986 435 545</b>

2855 668	<b>0 460 416 105</b>
2855 694	<b>0 460 424 412</b>
2855717	<b>0 460 416 103</b>
2855718	<b>0 460 426 447</b>
2855730	<b>0 460 426 470</b>

285 600 1	<b>0 460 424 413</b>
2856 014	<b>0 460 424 402</b>
2856 054	<b>0 460 424 316</b>
2856 056	<b>0 460 424 425</b>
2856113	<b>0 460 426 452</b>

2856207	<b>0 460 424 424</b>
2856214	<b>0 432 133 763</b>
2856255	<b>0 432 133 761</b>
2856 334	<b>0 460 414 265</b>
2856352	<b>0 460 414 267</b>

285 6382	<b>0 460 424 406</b>
2856534	<b>0 460 424 422</b>
2856537	<b>0 460 424 418</b>
2856 584	<b>0 460 424 404</b>
2856586	<b>0 460 426 449</b>

2856623	<b>0 460 424 421</b>
2856722	<b>0 460 426 457</b>
2856 745	<b>0 460 424 398</b>
2856 901	<b>0 460 424 274</b>
2856 936	<b>0 460 424 386</b>

2856 995	<b>0 460 424 430</b>
2858 016	<b>0 460 424 432</b>
2859 128	<b>0 460 424 441</b>
2859361	<b>0 460 424 445</b>
2859 414	<b>0 460 424 432</b>

2859 414	<b>0 460 424 442</b>
357242	<b>F 000 439 015</b>
3908 513	<b>0 432 191 794</b>
3909 476	<b>0 432 131 880</b>
3916 948	<b>0 460 426 185</b>

3917 526	<b>0 460 424 068</b>
3919 343	<b>0 432 131 835</b>
3929 490	<b>0 432 131 749</b>
425 627 91	<b>0 414 701 052</b>
47506932	<b>0 444 043 080</b>

475 117 25	<b>0 444 023 062</b>
47582622	<b>0 445 020 223</b>
47669601	<b>0 445 020 223</b>
4792 442	<b>0 432 291 654</b>
4794 588	<b>0 460 414 013</b>

4794 589	<b>0 460 414 015</b>
4798 834	<b>0 460 416 036</b>
4800 029	<b>0 432 291 655</b>
4804 869	<b>0 460 414 024</b>
4898 921	<b>0 445 020 007</b>

4898 921	<b>0 445 020 123</b>
500 301 632	<b>0 432 291 519</b>
500 307 410	<b>0 460 424 165</b>
500 307 714	<b>0 432 291 509</b>
500 317 389	<b>0 432 291 504</b>

500 324 954	<b>0 460 413 016</b>
500 324 955	<b>0 460 413 019</b>
500 324 959	<b>0 460 414 182</b>
500 324 961	<b>0 460 414 177</b>
500 324 962	<b>0 460 414 176</b>

◀ CASE

500 324 967	<b>0 460 414 181</b>
500 324 968	<b>0 460 414 175</b>
500 324 969	<b>0 460 424 179</b>
500 324 970	<b>0 460 424 182</b>
500 324 972	<b>0 460 426 296</b>

500 331 074	<b>0 414 701 052</b>
500 331 074	<b>0 414 701 083</b>
5003 342 69	<b>0 432 193 641</b>
500 339 059	<b>0 414 701 084</b>
500 367 520	<b>0 414 700 004</b>

500 385 287	<b>0 432 133 782</b>
500 390 441	<b>0 432 133 780</b>
504 005 534	<b>0 432 291 499</b>
504 026 195	<b>0 460 424 306</b>
504 028 507	<b>0 460 424 270</b>

504 035 897	<b>0 460 424 295</b>
504036727	<b>0 460 413 028</b>
504 041 416	<b>0 460 424 300</b>
504 042 213	<b>0 460 423 006</b>
504 042 214	<b>0 460 424 299</b>

504 042 503	<b>0 460 424 249</b>
504 042 718	<b>0 460 424 280</b>
504 045 835	<b>0 432 133 779</b>
504 054 473	<b>0 460 423 011</b>
504 054 474	<b>0 460 423 012</b>

504 054 475	<b>0 460 423 008</b>
504 054 476	<b>0 460 424 296</b>
504 054 478	<b>0 460 424 298</b>
504 054 479	<b>0 460 424 297</b>
504060084	<b>0 460 426 374</b>

504 060 084	<b>0 460 426 376</b>
504 062 436	<b>0 414 701 021</b>
504 062 438	<b>0 414 701 022</b>
504 063 050	<b>0 460 426 380</b>
504 063 449	<b>0 460 424 302</b>

504 068 392	<b>0 460 424 328</b>
504 068 397	<b>0 460 424 345</b>
504 073 612	<b>0 460 424 330</b>
504 073 613	<b>0 460 424 334</b>
504 073 614	<b>0 460 424 321</b>

504 078 911	<b>0 460 426 378</b>
504 087 264	<b>0 460 426 415</b>
504091505	<b>0 445 120 057</b>
504091505R	<b>0 986 435 552</b>
504 113 228	<b>0 460 424 306</b>

504 117 273	<b>0 445 120 079</b>
504125149	<b>0 432 133 764</b>
504128307	<b>0 445 120 075</b>
504128307R	<b>0 986 435 530</b>
504 129 021	<b>0 460 426 447</b>

504 134 866	<b>0 460 424 413</b>
504 154 922	<b>0 414 703 009</b>
504164563	<b>0 432 193 447</b>
504171001	<b>0 460 426 449</b>
504 173 549	<b>0 460 424 392</b>

504173550	<b>0 460 424 386</b>
504180104	<b>0 460 426 470</b>
504 188 076	<b>0 445 020 093</b>
504 188 076	<b>0 986 437 389</b>
50418942	<b>0 460 426 446</b>

504 191 709	<b>0 460 424 432</b>
504 194 432	<b>0 445 120 092</b>
504 194 432	<b>0 986 435 551</b>
504194432R	<b>0 986 435 551</b>
504215217	<b>0 460 426 494</b>

504218824	<b>0 460 424 422</b>
504 218 826	<b>0 460 424 430</b>
504 247 893	<b>0 460 424 398</b>
504254390	<b>0 432 133 761</b>
504255185	<b>0 445 120 157</b>

504255185R	<b>0 986 435 564</b>
504267147	<b>0 460 426 493</b>
504 275 234	<b>0 432 193 433</b>
504 287 070	<b>0 414 703 008</b>
504287106	<b>0 414 703 009</b>

504 287 108	<b>0 414 703 013</b>
504 303 916	<b>0 460 424 466</b>
504307525	<b>0 460 426 480</b>
504 373 553	<b>0 460 424 491</b>
504 374 935	<b>0 460 424 482</b>

504 374 936	<b>0 460 424 475</b>
504 374 940	<b>0 460 424 478</b>
504 374 942	<b>0 460 424 469</b>
504 374 947	<b>0 460 424 470</b>
504 374 948	<b>0 460 424 477</b>

504 374 949	<b>0 460 424 479</b>
504 374 950	<b>0 460 424 472</b>
504 374 951	<b>0 460 424 483</b>
504374952	<b>0 460 424 471</b>
504 374 953	<b>0 460 424 476</b>

504 374 955	<b>0 460 424 480</b>
504 381 866	<b>0 444 023 062</b>
504 385 419	<b>0 460 424 492</b>
504 385 659	<b>0 460 424 489</b>
504 387 476	<b>0 460 424 491</b>

504 388 75	<b>0 445 124 014</b>
504 388 75	<b>0 986 435 655</b>
504388750	<b>0 445 124 014</b>
504 388 756	<b>0 445 020 160</b>
504 388 756	<b>0 986 437 512</b>

5095 919	<b>0 460 413 031</b>
5096737	<b>0 460 424 372</b>
5096739	<b>0 460 424 370</b>
5526 7246	<b>0 445 010 466</b>
580 138 23 96	<b>0 445 020 175</b>

580 147 00 98	<b>0 445 110 457</b>
580 147 00 98	<b>0 986 435 254</b>
580 147 01 00	<b>0 445 020 516</b>
580 148 65 99	<b>0 445 020 195</b>
580 148 65 99	<b>0 986 437 512</b>

580 156 91 41	<b>0 445 110 540</b>
580 163 39 45	<b>0 445 020 223</b>
580 169 23 83	<b>0 445 124 027</b>
580 179 03 38	<b>0 445 110 657</b>
761 954 94	<b>0 460 426 385</b>

761 956 57	<b>0 432 191 300</b>
818 768 71	<b>0 432 191 688</b>
828 509 95	<b>0 432 191 667</b>
841 361 93	<b>0 444 022 019</b>
841 364 21	<b>0 444 023 057</b>

842 468 92	<b>0 444 022 021</b>
842 470 21	<b>0 444 023 058</b>
842 480 58	<b>0 444 023 062</b>
843 468 12	<b>0 445 120 236</b>
84346812	<b>0 986 435 522</b>

84346812R	<b>0 986 435 522</b>
843 475 19	<b>0 445 120 237</b>
843 475 19	<b>0 986 435 555</b>
84347519R	<b>0 986 435 555</b>
843 851 10	<b>0 445 020 175</b>

843 851 10	<b>0 986 437 341</b>
8448 1762	<b>0 986 440 232</b>
865 533 27	<b>9 430 082 711</b>
874 001 05	<b>0 432 191 342</b>
874 025 26	<b>0 432 191 354</b>

874 221 70	<b>0 432 191 390</b>
875 381 23	<b>0 445 120 240</b>
875 815 65	<b>0 445 120 112</b>
87581565	<b>0 445 120 272</b>
87581565	<b>0 986 435 532</b>

877 080 24	<b>0 445 120 144</b>
878 011 39	<b>0 460 426 266</b>
878 011 40	<b>0 460 426 265</b>
878 013 61	<b>0 460 426 280</b>
878 017 89	<b>0 460 426 303</b>

878 018 35	<b>0 460 426 307</b>
878 018 36	<b>0 460 426 312</b>
878 018 37	<b>0 460 426 313</b>
878 020 91	<b>0 432 191 440</b>
878 024 30	<b>0 432 191 364</b>

878 025 32	<b>0 460 426 344</b>
878 025 33	<b>0 460 426 340</b>
878 025 34	<b>0 460 426 345</b>
878 025 35	<b>0 460 426 343</b>
878 025 36	<b>0 432 191 351</b>

878 025 37	<b>0 432 193 524</b>
878 026 84	<b>0 460 426 361</b>
878 029 09	<b>0 432 193 501</b>
878 033 57	<b>0 470 006 007</b>
878 033 57	<b>0 986 444 511</b>

878 400 66	<b>0 432 191 641</b>
878 400 68	<b>0 432 191 650</b>
878 404 46	<b>0 432 191 621</b>
878 411 16	<b>0 432 191 617</b>
931735	<b>0 432 191 531</b>

984 141 85	<b>0 432 291 555</b>
984 353 68	<b>0 432 291 559</b>
984 413 26	<b>0 460 416 075</b>
984 431 45	<b>0 432 291 554</b>
984 868 79	<b>0 432 191 680</b>

984 999 01	<b>0 432 191 646</b>
994 343 27	<b>0 432 291 516</b>
994 415 84	<b>0 460 413 014</b>
994 415 86	<b>0 460 413 013</b>
994 415 87	<b>0 460 413 012</b>

994 418 47	<b>0 460 414 115</b>
994 591 63	<b>0 460 424 159</b>
994 693 40	<b>0 432 291 505</b>
994 696 00	<b>0 460 416 083</b>
994 720 99	<b>0 460 413 017</b>

994 721 00	<b>0 460 413 015</b>
994 721 01	<b>0 460 414 170</b>
994 721 02	<b>0 460 414 169</b>
994 721 03	<b>0 460 414 183</b>
994 721 04	<b>0 460 414 180</b>

994 729 48	<b>0 432 291 508</b>
994 756 04	<b>0 460 414 179</b>
994 756 05	<b>0 460 414 171</b>

**CASE IH (CASE INTERNATIONAL)**

DC46 5H298 AA	<b>0 444 023 058</b>
DC46 5H298 AB	<b>0 444 023 058</b>

F2NN 9F593 AB	<b>0 432 191 688</b>
F2NN 9F5 93 BB	<b>0 432 191 687</b>
F3NN 9A593 AA	<b>0 432 191 667</b>
2852056	<b>0 432 133 780</b>
2852273	<b>0 432 133 775</b>

2853346	<b>0 432 133 771</b>
2854608	<b>0 445 120 057</b>
2855 135	<b>0 445 120 075</b>
2855392	<b>0 460 426 453</b>
2855396	<b>0 460 426 455</b>

2855399	<b>0 432 133 764</b>
2855 491	<b>0 445 120 054</b>
2855694	<b>0 460 424 412</b>
2856255	<b>0 432 133 761</b>
2856 334	<b>0 460 414 265</b>

2856534	<b>0 460 424 422</b>
2856537	<b>0 460 424 418</b>
2856 584	<b>0 460 424 404</b>
2856623	<b>0 460 424 421</b>
2856 745	<b>0 460 424 398</b>

2856 995	<b>0 460 424 430</b>
390 947 6	<b>0 432 131 880</b>
4 750 405	<b>0 432 281 704</b>
47506932	<b>0 444 043 080</b>
475 117 24	<b>0 444 023 058</b>



475 11 7240	<b>0 444 023 058</b>
475 117 25	<b>0 444 023 062</b>
47582622	<b>0 445 020 223</b>
4792 442	<b>0 432 291 654</b>
4800 029	<b>0 432 291 655</b>

4898921	<b>0 445 020 007</b>
500 301 632	<b>0 432 291 519</b>
500307714	<b>0 432 291 509</b>
500317389	<b>0 432 291 504</b>
500 324 962	<b>0 460 414 176</b>

504041416	<b>0 460 424 300</b>
504041420	<b>0 460 423 007</b>
504 042 213	<b>0 460 423 006</b>
504042214	<b>0 460 424 299</b>
504042718	<b>0 460 424 280</b>

504047343	<b>0 460 414 235</b>
504 054 473	<b>0 460 423 011</b>
504 054 474	<b>0 460 423 012</b>
504 054 475	<b>0 460 423 008</b>
504054479	<b>0 460 424 297</b>

504113228	<b>0 460 424 306</b>
504113991	<b>0 460 424 349</b>
504125329	<b>0 414 703 008</b>
504128307	<b>0 445 120 075</b>
504128354	<b>0 414 703 009</b>

504154922	<b>0 414 703 009</b>
504 188 076	<b>0 445 020 093</b>
504194432	<b>0 445 120 092</b>
504194432	<b>0 986 435 551</b>
504218824	<b>0 460 424 422</b>

504 218 826	<b>0 460 424 430</b>
504255185	<b>0 445 120 157</b>
504275234	<b>0 432 193 433</b>
504287106	<b>0 414 703 009</b>
504374940	<b>0 460 424 478</b>

504 374 947	<b>0 460 424 470</b>
504374949	<b>0 460 424 479</b>
504374950	<b>0 460 424 472</b>
504 381 866	<b>0 444 023 062</b>
504 385 419	<b>0 460 424 492</b>

504387476	<b>0 460 424 491</b>
504388756	<b>0 445 020 195</b>
5090725	<b>0 432 291 494</b>
5096735	<b>0 460 423 029</b>
5096736	<b>0 460 423 030</b>

5096737	<b>0 460 424 372</b>
5096738	<b>0 460 424 373</b>
5096739	<b>0 460 424 370</b>
5099371	<b>0 432 191 231</b>
580 138 23 96	<b>0 445 020 175</b>

5801470100	<b>0 445 020 516</b>
5801496001	<b>0 445 120 346</b>
5801692383	<b>0 445 124 027</b>
5801790338	<b>0 445 110 657</b>
5801906153	<b>0 445 124 036</b>

818 768 71	<b>0 432 191 688</b>
828 509 95	<b>0 432 191 667</b>
842 470 21	<b>0 444 023 058</b>
842 47 0210	<b>0 444 023 058</b>
842 480 58	<b>0 444 023 062</b>

84300598	<b>0 460 423 054</b>
843 851 10	<b>0 445 020 175</b>
84534252	<b>F 002 C7Z 397</b>
87801789	<b>0 460 426 303</b>
87801836	<b>0 460 426 312</b>

87801837	<b>0 460 426 313</b>
878 025 32	<b>0 460 426 344</b>
878 025 33	<b>0 460 426 340</b>
878 025 34	<b>0 460 426 345</b>
878 025 35	<b>0 460 426 343</b>

878 025 37	<b>0 432 193 524</b>
87803357	<b>0 470 006 007</b>
878 400 66	<b>0 432 191 641</b>
878 411 16	<b>0 432 191 617</b>
87 841 118	<b>0 432 191 617</b>

984 353 68	<b>0 432 291 559</b>
994 343 27	<b>0 432 291 516</b>
99472101	<b>0 460 414 169</b>
994 721 02	<b>0 460 414 169</b>
99475605	<b>0 460 414 171</b>

**CASE NEW HOLLAND**

J908505	<b>0 432 191 804</b>
J908513	<b>0 432 191 794</b>
J919304	<b>0 432 131 839</b>

J919339	<b>0 432 131 836</b>
J919343	<b>0 432 131 835</b>
J919602	<b>0 432 191 738</b>
J929490	<b>0 432 131 749</b>
J930131	<b>0 432 131 743</b>

J930525	<b>0 432 191 595</b>
J930573	<b>0 432 131 698</b>
J931735	<b>0 432 191 531</b>
J935213	<b>0 432 131 676</b>
J935677	<b>0 460 424 191</b>

J935679	<b>0 460 424 189</b>
J948529	<b>0 432 191 426</b>
2830957	<b>0 986 435 508</b>
2830957R	<b>0 986 435 508</b>
2855491R	<b>0 986 435 545</b>

474037970	<b>0 444 042 114</b>
475069320	<b>0 444 043 080</b>
47715717	<b>0 444 043 133</b>
500331074	<b>0 986 441 113</b>
500339059	<b>0 986 441 103</b>

504036727	<b>0 460 413 028</b>
504091505R	<b>0 986 435 552</b>
504128307R	<b>0 986 435 530</b>
504194432R	<b>0 986 435 551</b>
504255185R	<b>0 986 435 564</b>

504342423	<b>0 445 010 559</b>
504388750	<b>0 986 435 655</b>
5801453888	<b>0 986 435 663</b>
5801470098	<b>0 445 110 457</b>
5801470098	<b>0 986 435 254</b>

5801486599	<b>0 445 020 195</b>
5801486599	<b>0 986 437 512</b>
5801569141	<b>0 445 110 540</b>
5801594342	<b>0 445 110 520</b>
5801594342	<b>0 986 435 248</b>

5801633945	<b>0 445 020 223</b>
5801665464	<b>0 460 426 545</b>
84246892	<b>0 444 022 021</b>
84246892	<b>0 986 44D 131</b>
84246892R	<b>0 986 44D 131</b>

84346812R	<b>0 986 435 522</b>
84347519R	<b>0 986 435 555</b>
844 817 62	<b>0 986 44D 232</b>
87802994	<b>0 432 193 489</b>

**CATERPILLAR**

20R4049	<b>0 986 44D 228</b>
20R4050	<b>0 986 44D 230</b>
264 4N208	<b>0 460 424 303</b>

264 4N209	<b>0 460 424 255</b>
264 4N408	<b>0 460 424 323</b>
264 5F019	<b>0 432 291 518</b>
3752647	<b>0 445 025 601</b>
398-4746	<b>0 986 44D 228</b>

398-4746-00	<b>0 444 042 059</b>
398-4747	<b>0 986 44D 230</b>
398-4747-00	<b>0 444 042 061</b>
398-5386-00	<b>0 444 043 042</b>
399-6136-00	<b>0 444 043 029</b>

424-4205-00	<b>0 444 043 040</b>
485-9751	<b>0 444 043 192</b>
485-9753	<b>0 986 44D 230</b>
527-5384	<b>0 445 120 504</b>
529-7864	<b>0 445 120 508</b>

538-7297	<b>0 445 120 535</b>
----------	----------------------

**CHERY**

A11-3614011	<b>0 280 218 166</b>
B11-3614011	<b>0 280 218 167</b>
B14-3614011	<b>0 281 002 938</b>

372A-1112011	<b>0 445 110 420</b>
481A 1111011 BA	<b>0 445 010 165</b>
481A 1112011BA	<b>0 445 110 304</b>

**CHEVROLET**

MC 052 002	<b>0 460 426 279</b>
MS 052 003	<b>0 460 424 223</b>
MS 052 004	<b>0 460 424 216</b>

MS 053 001	<b>0 432 193 566</b>
MV 053 001	<b>0 432 193 565</b>
MW 052 001	<b>0 460 426 331</b>
MW 053 002	<b>0 432 193 691</b>
00 077 424	<b>0 432 193 766</b>

00 077 426	<b>0 460 424 175</b>
00 077 485	<b>0 460 414 127</b>
00 077 486	<b>F 000 439 008</b>
10 055 877	<b>0 280 213 009</b>
10 055 877	<b>0 986 280 105</b>

12 620 534	<b>0 445 117 010</b>
12 620 534	<b>0 986 435 410</b>
12 620 535	<b>0 445 117 008</b>
12 620 535	<b>0 986 435 409</b>
12 625 220	<b>0 445 110 354</b>

12 625 220	<b>0 445 110 424</b>
12 645 102	<b>0 445 010 817</b>
12 645 102	<b>0 986 437 421</b>
12 645 103	<b>0 986 437 421</b>
12 661 059	<b>0 445 010 817</b>

12 661 059	<b>0 986 437 421</b>
13 241 771 DA	<b>0 280 218 209</b>
13 301 682	<b>0 280 218 254</b>
14 059 057	<b>0 432 217 104</b>
19 210 900	<b>0 445 117 008</b>

19 210 900	<b>0 986 435 409</b>
19 256 590	<b>0 445 117 010</b>
19 256 590	<b>0 986 435 410</b>
55 585 712	<b>0 986 435 439</b>
90 530 767	<b>0 281 002 180</b>

90 543 463	<b>0 281 002 180</b>
9193454	<b>0 470 504 011</b>
9195729	<b>0 281 002 428</b>
9198651	<b>0 432 193 634</b>
9201510	<b>0 470 504 015</b>

93 171 355	<b>0 281 002 428</b>
93 171 356	<b>0 281 002 180</b>
93 171 527	<b>0 281 002 478</b>
93 171 940	<b>0 432 193 525</b>
93 175 025	<b>0 470 504 217</b>

93 175 025	<b>0 986 444 030</b>
93 175 731	<b>0 470 504 218</b>
93 175 731	<b>0 986 444 036</b>
93 342 272	<b>0 445 110 231</b>
93 342 346	<b>0 445 010 115</b>

93 383 963	<b>0 460 424 216</b>
93 383 964	<b>0 460 424 223</b>
94 459 142	<b>0 986 433 004</b>
94 459 142	<b>9 430 610 136</b>
96 440 341	<b>0 986 437 032</b>





◀ CHEVROLET

96 859 151	<b>0 445 010 332</b>
97 085 182	<b>9 460 620 010</b>
97 303 657	<b>0 986 435 504</b>
97 361 351	<b>F 00E 200 431</b>
97 361 355	<b>0 986 435 521</b>

97 720 662	<b>0 986 437 303</b>
97 729 095	<b>0 986 435 502</b>
97 780 091	<b>0 445 020 030</b>
97 780 091	<b>0 986 437 308</b>
97 780 358	<b>0 986 435 521</b>

97 780 360	<b>0 986 435 520</b>
98 002 368	<b>0 986 435 520</b>

**CHRYSLER**

A6120700587	<b>0 445 110 203</b>
D300 0044A	<b>0 281 002 144</b>
KRX042029AA	<b>0 445 115 067</b>

KRX042029AA	<b>0 986 435 402</b>
K05033109AB	<b>0 281 002 571</b>
K05293155AB	<b>0 281 002 451</b>
K53013009AA	<b>0 281 002 501</b>
RL137 254AB	<b>0 445 110 203</b>

RX046351AA	<b>0 445 010 152</b>
015062012F	<b>0 986 430 249</b>
01506 2014F	<b>0 432 297 047</b>
01506 2016F	<b>0 432 217 249</b>
01506 2019F	<b>0 432 217 282</b>

01506 2020F	<b>0 432 217 294</b>
01506 2024F	<b>0 432 193 699</b>
01506 2028F	<b>0 432 193 628</b>
01506 2038F	<b>0 432 193 698</b>
03502 2001B	<b>0 460 416 035</b>

03502 2052F	<b>0 460 414 131</b>
03502 2064F	<b>0 460 426 999</b>
03502 2065F	<b>0 460 414 157</b>
03502 2069F	<b>0 460 416 086</b>
03502 2079F	<b>0 460 426 318</b>

04612 698	<b>0 281 002 132</b>
04861 076	<b>0 281 002 132</b>
05033 109AB	<b>0 281 002 571</b>
05033 320AA	<b>0 281 002 779</b>
05066 820AA	<b>0 445 110 059</b>

05066 820AA	<b>0 986 435 149</b>
05080 341AB	<b>0 445 010 270</b>
05080 341AB	<b>0 986 437 102</b>
05136 012AA	<b>0 445 010 270</b>
05137 254AB	<b>0 445 110 203</b>

05142 811AA	<b>0 445 110 218</b>
05159 970AA	<b>0 986 435 128</b>
05293 155AB	<b>0 281 002 451</b>
1506 2012F	<b>0 986 430 249</b>
1506 2014F	<b>0 432 297 047</b>

1506 2016F	<b>0 432 217 249</b>
1506 2019F	<b>0 432 217 282</b>
1506 2020F	<b>0 432 217 294</b>
1506 2024F	<b>0 432 193 699</b>
1506 2028F	<b>0 432 193 628</b>

1506 2038F	<b>0 432 193 698</b>
3502 2001B	<b>0 460 416 035</b>
3502 2052F	<b>0 460 414 131</b>
3502 2064F	<b>0 460 426 999</b>
3502 2065F	<b>0 460 414 157</b>

3502 2069F	<b>0 460 416 086</b>
3502 2079F	<b>0 460 426 318</b>
4612 698	<b>0 281 002 132</b>
4861 076	<b>0 281 002 132</b>
5033 109AB	<b>0 281 002 571</b>

5033 320AA	<b>0 281 002 779</b>
5066 820AA	<b>0 445 110 059</b>
5066 820AA	<b>0 986 435 149</b>
5080 341AB	<b>0 445 010 270</b>
5080 341AB	<b>0 986 437 102</b>

5136 012AA	<b>0 445 010 270</b>
5137 254AB	<b>0 445 110 203</b>
5142 811AA	<b>0 445 110 218</b>
5159 970AA	<b>0 986 435 128</b>
5293 155AB	<b>0 281 002 451</b>

53 013 009 AA	<b>0 281 002 501</b>
53013 673AA	<b>0 281 002 896</b>
53030 758	<b>0 281 002 156</b>
64207 00301	<b>0 986 437 363</b>
68018 733AA	<b>0 986 437 365</b>

68028 405AA	<b>0 986 435 355</b>
68042 029AA	<b>0 445 115 067</b>
68042 029AA	<b>0 986 435 402</b>
68046 351AA	<b>0 445 010 152</b>
68240 043AA	<b>F 01C 600 249</b>

68240 043AB	<b>F 01C 600 249</b>
-------------	----------------------

**CITROEN**

1192 W5	<b>0 281 002 184</b>
16 090 972 80	<b>0 445 110 418</b>
16 090 972 80	<b>0 986 435 212</b>

16 090 972 80	<b>0 986 435 248</b>
16 090 980 80	<b>0 445 010 319</b>
16 090 980 80	<b>0 986 437 096</b>
16 098 507 80	<b>0 445 110 297</b>
16 098 507 80	<b>0 986 435 150</b>

1636 75	<b>0 281 002 917</b>
1920 AL	<b>0 445 010 021</b>
1920 AL	<b>0 986 437 012</b>
1920 AZ	<b>0 445 020 002</b>
1920 AZ	<b>0 986 437 501</b>

1920 CY	<b>0 445 010 010</b>
1920 CY	<b>0 445 010 162</b>
1920 CY	<b>0 986 437 005</b>
1920 EA	<b>0 445 010 046</b>
1920 EA	<b>0 445 010 163</b>

1920 EA	<b>0 986 437 017</b>
1920 EC	<b>0 445 010 042</b>
1920 EC	<b>0 986 437 309</b>
1920 FZ	<b>0 445 010 089</b>
1920 FZ	<b>0 986 437 322</b>

1920 HT	<b>0 445 010 296</b>
1920 JE	<b>0 445 010 132</b>
1920 JE	<b>0 445 010 164</b>
1920 JE	<b>0 445 010 284</b>
1920 JE	<b>0 986 437 018</b>

1920 JK	<b>0 445 020 006</b>
1920 JK	<b>0 986 437 502</b>
1920 KY	<b>0 445 010 367</b>
1920 KY	<b>0 986 437 034</b>
1920 NC	<b>0 445 010 162</b>

1920 NC	<b>0 445 010 282</b>
1920 NC	<b>0 986 437 005</b>
1920 NE	<b>0 445 010 163</b>
1920 NE	<b>0 445 010 283</b>
1920 NE	<b>0 986 437 017</b>

1920 NF	<b>0 445 010 164</b>
1920 NF	<b>0 445 010 284</b>
1920 NF	<b>0 986 437 018</b>
1920 N2	<b>0 460 494 310</b>
1920 N6	<b>0 460 494 278</b>

1920 PH	<b>0 445 010 367</b>
1920 PH	<b>0 986 437 034</b>
1920 P7	<b>0 460 484 056</b>
1920 Q0	<b>0 460 494 278</b>
1920 RF	<b>0 445 010 552</b>

1920 RF	<b>0 986 437 430</b>
1920 RG	<b>0 445 010 614</b>
1920 RG	<b>0 986 437 432</b>
1920 R8	<b>0 986 440 094</b>
1920 S4	<b>0 986 440 146</b>

1920 V5	<b>0 986 440 512</b>
1920 W0	<b>0 460 494 278</b>
1920 Z1	<b>0 281 002 128</b>
1920 2N	<b>0 986 440 156</b>
1920 2X	<b>0 460 484 099</b>

1920 3T	<b>0 460 414 140</b>
1920 3T	<b>0 986 440 051</b>
1920 4F	<b>0 460 484 099</b>
1920 6F	<b>0 460 494 459</b>
1920 6X	<b>0 445 010 010</b>

1920 6X	<b>0 445 010 162</b>
1920 6X	<b>0 986 437 005</b>
1920 7H	<b>0 986 440 161</b>
1920 70	<b>0 280 202 097</b>
1920 76	<b>0 986 280 115</b>

1920 8A	<b>0 460 484 131</b>
1979 45	<b>0 986 430 010</b>
1979 46	<b>0 986 430 015</b>
1979 46	<b>0 986 430 028</b>
1979 47	<b>0 986 430 015</b>

1979 47	<b>0 986 430 028</b>
1980 AE	<b>0 986 435 014</b>
1980 AG	<b>0 986 435 014</b>
1980 AJ	<b>0 986 435 014</b>
1980 AL	<b>0 986 435 014</b>

1980 AP	<b>0 986 435 014</b>
1980 AV	<b>0 986 435 077</b>
1980 AW	<b>0 986 435 077</b>
1980 AX	<b>0 986 435 077</b>
1980 A9	<b>0 445 110 135</b>

1980 A9	<b>0 986 435 085</b>
1980 CC	<b>0 986 435 077</b>
1980 CE	<b>0 986 435 077</b>
1980 CF	<b>0 986 435 077</b>
1980 CK	<b>0 986 435 003</b>

1980 CL	<b>0 986 435 093</b>
1980 CN	<b>0 986 435 093</b>
1980 CP	<b>0 986 435 093</b>
1980 CQ	<b>0 986 435 146</b>
1980 CS	<b>0 986 435 090</b>

1980 CT	<b>0 986 435 126</b>
1980 CV	<b>0 986 435 150</b>
1980 CY	<b>0 986 435 085</b>
1980 CZ	<b>0 986 435 076</b>
1980 EA	<b>0 986 435 143</b>

1980 EC	<b>0 986 435 501</b>
1980 EE	<b>0 986 435 501</b>
1980 EJ	<b>0 445 110 339</b>
1980 EJ	<b>0 986 435 172</b>
1980 EL	<b>0 986 435 392</b>

1980 EL	<b>0 986 435 434</b>
1980 E5	<b>0 445 110 136</b>
1980 E5	<b>0 445 110 188</b>
1980 E5	<b>0 986 435 090</b>
1980 H2	<b>0 445 110 239</b>

1980 H2	<b>0 986 435 122</b>
1980 H3	<b>0 445 110 188</b>
1980 H3	<b>0 986 435 090</b>
1980 H4	<b>0 445 110 036</b>
1980 H4	<b>0 986 435 014</b>

1980 H5	<b>0 445 110 036</b>
1980 H5	<b>0 986 435 014</b>
1980 H6	<b>0 445 110 036</b>
1980 H6	<b>0 986 435 014</b>
1980 H7	<b>0 445 110 076</b>

1980 H7	<b>0 986 435 077</b>
1980 H8	<b>0 445 110 076</b>
1980 H8	<b>0 986 435 077</b>
1980 H9	<b>0 445 110 076</b>
1980 H9	<b>0 986 435 077</b>





**CNHTC**

VG1034080002	<b>0 445 120 357</b>
15008	<b>0 444 042 045</b>
15008, CN-HTC	<b>0 444 042 045</b>

200V10100-6126	<b>0 445 120 321</b>
200V10100-6127	<b>0 445 120 415</b>
200V10100-6127	<b>0 445 120 444</b>
202V270120-0007	<b>0 444 042 045</b>
202V27120-0008	<b>0 444 043 044</b>

805011167	<b>0 445 020 201</b>
-----------	----------------------

**CUMMINS**

A028Y791	<b>0 444 043 007</b>
A028Y791	<b>0 444 043 008</b>
A028Y792	<b>0 986 44D 122</b>

A028Y792	<b>0 986 44D 205</b>
A028Y792	<b>0 986 44D 207</b>
A028Y793	<b>0 444 042 014</b>
A028Y793	<b>0 986 44D 123</b>
A028Y793	<b>0 986 44D 206</b>

A028Y793	<b>0 986 44D 209</b>
A 029 C02 3	<b>0 444 042 013</b>
A030F171	<b>0 444 043 031</b>
A030P707	<b>0 444 043 033</b>
A030P708	<b>0 444 042 018</b>

A043C088	<b>0 444 043 051</b>
A045N266	<b>0 444 042 093</b>
A045N268	<b>0 444 042 092</b>
A045N270	<b>0 444 043 074</b>
A052B661	<b>0 986 44D 205</b>

A058S867	<b>0 444 043 196</b>
C0147056200	<b>0 432 217 091</b>
C5268408	<b>0 445 120 289</b>
R5019657AC	<b>0 986 444 023</b>
0 000 5040	<b>0 445 020 122</b>

0 000 5040	<b>0 986 437 310</b>
0 28Y 793	<b>0 444 042 014</b>
0 30P 708	<b>0 444 043 017</b>
0 30P 708	<b>0 444 043 018</b>
0445120342	<b>0 986 435 621</b>

2 830 224	<b>0 986 435 508</b>
2 830 244	<b>0 986 435 508</b>
2 830 251	<b>0 460 424 285</b>
2 830 957	<b>0 986 435 508</b>
2 870 940	<b>F 00B L0P 029</b>

2 871 878	<b>0 444 043 008</b>
2 871 879	<b>0 986 44D 122</b>
2 871 879	<b>0 986 44D 205</b>
2 871 879	<b>0 986 44D 207</b>
2 871 879-RX	<b>0 986 44D 122</b>

2871879-RX	<b>0 986 44D 205</b>
2871879-RX	<b>0 986 44D 207</b>
2 871 880	<b>0 444 042 014</b>
2 871 880	<b>0 986 44D 123</b>
2 871 880	<b>0 986 44D 206</b>

2 871 880	<b>0 986 44D 209</b>
2871880-RX	<b>F 00E 200 528</b>
2871880-RX	<b>0 986 44D 123</b>
2871880-RX	<b>0 986 44D 206</b>
2871880-RX	<b>0 986 44D 209</b>

2 880 156	<b>0 444 043 007</b>
2 880 156	<b>0 444 043 017</b>
2 880 156	<b>0 444 043 018</b>
2 880 157	<b>0 444 042 013</b>
2 880 158	<b>0 444 042 014</b>

2 881 171	<b>F 00B L0P 035</b>
2 884 313	<b>0 445 117 031</b>
2 888 112	<b>0 444 043 031</b>
2 888 173	<b>0 444 043 033</b>
2 888 174	<b>0 444 042 018</b>

2 888 174	<b>0 444 043 018</b>
2 888 712	<b>F 00B L0P 031</b>
2 888 748	<b>F 00B L0P 037</b>
2 888 810	<b>F 00B L0P 033</b>
3 092 022	<b>0 432 191 532</b>

3 092 639	<b>0 432 292 861</b>
3 093 282	<b>0 432 191 409</b>
3 093 346	<b>9 430 612 143</b>
3 280 567	<b>0 432 131 852</b>
3 280 787	<b>0 432 131 849</b>

3 281 191	<b>0 432 133 853</b>
3 281 781	<b>0 460 426 211</b>
3 281 825	<b>0 432 133 868</b>
3 282 191	<b>0 432 133 853</b>
3 282 359	<b>0 432 133 851</b>

3 282 743	<b>0 460 426 249</b>
3 282 753	<b>0 460 426 245</b>
3 282 754	<b>0 432 133 846</b>
3 282 755	<b>0 460 426 254</b>
3 282 756	<b>0 432 133 845</b>

3 282 948	<b>0 432 133 843</b>
3 283 026	<b>0 460 426 249</b>
3 283 160	<b>0 432 191 592</b>
3 283 170	<b>0 460 426 249</b>
3 283 171	<b>0 460 426 249</b>

3 283 172	<b>0 460 426 249</b>
3 283 180	<b>0 432 131 722</b>
3 283 507	<b>0 432 133 838</b>
3 283 561	<b>0 432 133 838</b>
3 283 562	<b>0 432 133 837</b>

3 284 180	<b>0 460 426 249</b>
3 288 249	<b>0 460 426 375</b>
3 288 251	<b>0 460 426 377</b>
3 288 251	<b>0 460 426 383</b>
3 288 253	<b>0 460 426 382</b>

3 288 255	<b>0 460 426 365</b>
3 288 255	<b>0 460 426 377</b>
3 288 255	<b>0 460 426 383</b>
3 288 256	<b>0 432 133 772</b>
3 319 010	<b>0 432 133 853</b>

3 349 084	<b>0 432 131 693</b>
3 355 015	<b>9 430 082 747</b>
3 355 043	<b>9 430 082 748</b>
3 355 246	<b>9 430 082 753</b>
3 355 320	<b>9 430 082 751</b>

3 356 053	<b>9 430 082 762</b>
3 356 163	<b>0 460 424 126</b>
3 356 222	<b>0 460 426 251</b>
3 356 379	<b>0 460 424 144</b>
3 356 407	<b>0 460 424 183</b>

3 356 500	<b>0 460 426 305</b>
3 356 500	<b>0 460 426 324</b>
3 356 501	<b>0 460 426 298</b>
3 356 587	<b>F 000 439 007</b>
3 356 591	<b>F 000 439 004</b>

3 356 610	<b>0 460 426 291</b>
3 356 731	<b>0 460 424 185</b>
3 356 745	<b>0 460 426 299</b>
3 356 852	<b>0 460 424 186</b>
3 356 852	<b>0 460 424 204</b>

3 356 853	<b>F 000 439 009</b>
3 356 857	<b>F 000 439 007</b>
3 356 941	<b>F 000 439 010</b>
3 357 045	<b>0 460 424 204</b>
3 357 046	<b>F 000 439 011</b>

3 357 047	<b>0 460 424 203</b>
3 357 115	<b>0 460 424 208</b>
3 357 117	<b>0 460 424 209</b>
3 357 163	<b>0 460 426 325</b>
3 357 164	<b>0 460 426 322</b>

3 357 165	<b>0 460 426 323</b>
3 357 166	<b>0 460 426 324</b>
3 357 242	<b>F 000 439 015</b>
3 357 250	<b>0 460 426 326</b>
3 357 420	<b>0 460 424 226</b>

3 357 444	<b>0 460 424 231</b>
3 357 445	<b>0 460 424 230</b>
3 357 448	<b>F 000 439 017</b>
3 357 580	<b>0 460 426 342</b>
3 357 582	<b>F 000 439 018</b>

3 357 660	<b>F 000 439 019</b>
3 357 764	<b>0 460 426 352</b>
3 393 7167 RX	<b>0 986 444 009</b>
3 802 486	<b>0 432 191 628</b>
3 802 818	<b>0 432 131 753</b>

3 802 851	<b>0 432 191 569</b>
3 863 102	<b>0 432 131 740</b>
3 863 228	<b>0 432 131 688</b>
3 863 228	<b>0 432 131 741</b>
3 863 231	<b>0 432 131 690</b>

3 863 392	<b>0 432 131 717</b>
3 863 470	<b>0 432 131 689</b>
3 863 470	<b>0 432 131 710</b>
3 863 633	<b>0 432 131 697</b>
3 863 826	<b>0 432 131 679</b>

3 865 968	<b>0 432 131 715</b>
3 897 197	<b>0 432 133 854</b>
3 897 198	<b>0 432 191 636</b>
3 897 205	<b>0 432 191 569</b>
3 897 596	<b>0 432 131 753</b>

3 898 387	<b>0 432 191 628</b>
3 902 980	<b>0 432 131 877</b>
3 903 353	<b>0 460 424 015</b>
3 903 354	<b>0 460 424 006</b>
3 903 355	<b>0 460 424 008</b>

3 903 590	<b>0 460 424 012</b>
3 904 197	<b>0 432 131 880</b>
3 905 438	<b>0 432 133 889</b>
3 905 454	<b>0 432 133 888</b>
3 906 316	<b>0 460 424 019</b>

3 908 182	<b>0 460 424 026</b>
3 908 191	<b>0 460 424 027</b>
3 908 391	<b>0 460 424 031</b>
3 908 505	<b>0 432 191 804</b>
3 908 506	<b>0 432 191 804</b>

3 908 507	<b>0 432 191 812</b>
3 908 509	<b>0 432 191 799</b>
3 908 511	<b>0 432 191 796</b>
3 908 513	<b>0 432 191 794</b>
3 909 306	<b>0 432 131 838</b>

3 909 464	<b>0 432 131 877</b>
3 909 475	<b>0 432 131 881</b>
3 909 476	<b>0 432 131 880</b>
3 909 522	<b>0 432 133 888</b>
3 909 532	<b>0 432 131 875</b>

3 909 533	<b>0 432 131 876</b>
3 911 179	<b>0 460 424 085</b>
3 911 350	<b>9 430 082 715</b>
3 912 133	<b>0 460 426 106</b>
3 913 343	<b>0 432 131 835</b>

3 913 590	<b>0 460 424 012</b>
3 913 735	<b>0 432 191 756</b>
3 914 472	<b>0 432 131 869</b>
3 914 473	<b>0 432 131 856</b>
3 914 474	<b>0 432 131 854</b>

3 914 487	<b>0 460 424 046</b>
3 915 735	<b>0 460 426 132</b>
3 916 894	<b>0 460 426 144</b>
3 916 904	<b>0 460 426 146</b>
3 916 908	<b>0 460 426 148</b>

3 916 910	<b>0 460 426 151</b>
3 916 925	<b>0 460 424 057</b>
3 916 929	<b>0 460 424 062</b>
3 916 931	<b>0 460 426 164</b>
3 916 934	<b>0 460 426 157</b>

3916946	<b>0 460 426 156</b>	3922411	<b>0 460 426 200</b>	3938430	<b>0 432 191 354</b>	3964555	<b>0 470 506 029</b>
3916947	<b>0 460 426 141</b>	3923387	<b>0 432 191 628</b>	3938431	<b>0 432 191 343</b>	3964556	<b>0 470 506 040</b>
3916948	<b>0 460 426 185</b>	3924013	<b>0 432 133 864</b>	3939535	<b>0 432 191 357</b>	3964556	<b>0 986 444 053</b>
3916968	<b>0 460 426 154</b>	3924896	<b>0 432 131 799</b>	3939696	<b>0 432 133 787</b>	3964771	<b>F 000 439 023</b>
3916969	<b>0 460 426 154</b>	3926120	<b>0 432 191 642</b>	3939696	<b>0 432 133 878</b>	3964815	<b>0 460 424 209</b>
3916972	<b>0 460 426 167</b>	3926787	<b>0 432 191 632</b>	3939808	<b>0 432 191 338</b>	3964919	<b>0 432 133 773</b>
3916974	<b>0 460 426 154</b>	3926817	<b>0 432 133 859</b>	3939826	<b>0 432 191 355</b>	3965090	<b>0 445 020 015</b>
3916978	<b>0 460 426 153</b>	3926818	<b>0 432 133 860</b>	3939832	<b>0 432 191 349</b>	3965402	<b>0 470 006 005</b>
3917002	<b>0 460 426 142</b>	3926819	<b>0 432 133 861</b>	3939837	<b>0 432 191 335</b>	3965402	<b>0 986 444 509</b>
3917010	<b>0 460 426 132</b>	3926820	<b>0 432 133 858</b>	3943238	<b>0 986 444 023</b>	3965403	<b>0 470 006 006</b>
3917012	<b>0 460 426 149</b>	3927320	<b>0 432 133 857</b>	3944183	<b>0 432 193 635</b>	3965403	<b>0 986 444 510</b>
3917016	<b>0 460 424 066</b>	3927618	<b>0 432 133 849</b>	3944191	<b>0 432 193 649</b>	3965404	<b>0 470 004 018</b>
3917023	<b>0 460 424 064</b>	3928228	<b>0 432 191 601</b>	3944194	<b>0 432 193 648</b>	3965404	<b>0 986 444 507</b>
3917027	<b>0 460 424 059</b>	3928384	<b>0 432 191 629</b>	3944197	<b>0 432 193 647</b>	3965405	<b>0 470 004 019</b>
3917029	<b>0 460 424 060</b>	3928387	<b>0 432 191 628</b>	3944200	<b>0 432 193 645</b>	3965405	<b>0 986 444 508</b>
3917037	<b>0 460 426 150</b>	3929094	<b>9 430 082 761</b>	3944205	<b>0 432 193 646</b>	3965749	<b>0 445 120 038</b>
3917038	<b>0 460 426 149</b>	3929490	<b>0 432 131 749</b>	3944211	<b>0 432 191 498</b>	3966818	<b>0 432 191 300</b>
3917040	<b>0 432 131 851</b>	3929905	<b>0 460 426 142</b>	3944536	<b>0 470 506 007</b>	3966819	<b>0 432 191 299</b>
3917510	<b>0 460 424 060</b>	3930131	<b>0 432 131 743</b>	3944828	<b>0 432 193 629</b>	3966820	<b>0 432 191 298</b>
3917517	<b>0 460 424 078</b>	3930525	<b>0 432 191 595</b>	3944829	<b>0 432 193 630</b>	3967597	<b>0 432 131 753</b>
3917521	<b>0 460 424 069</b>	3930573	<b>0 432 131 698</b>	3944893	<b>0 470 506 012</b>	3968158	<b>0 445 120 032</b>
3917523	<b>0 460 424 067</b>	3930573	<b>0 432 131 740</b>	3944893	<b>0 986 444 032</b>	3968391	<b>0 460 424 305</b>
3917528	<b>0 460 424 074</b>	3931735	<b>0 432 191 531</b>	3945340	<b>0 432 191 484</b>	3968394	<b>0 460 424 277</b>
3917531	<b>0 460 424 055</b>	3931795	<b>0 432 131 718</b>	3946218	<b>0 986 444 018</b>	3969827	<b>F 000 439 022</b>
3917535	<b>0 460 424 054</b>	3931862	<b>F 002 C8Z 201</b>	3946306	<b>0 432 193 581</b>	3970820	<b>0 460 424 331</b>
3917539	<b>0 460 424 073</b>	3931945	<b>0 432 191 576</b>	3947032	<b>0 470 506 022</b>	3970821	<b>0 460 424 332</b>
3917542	<b>0 460 426 137</b>	3932123	<b>0 432 131 694</b>	3947032-RX	<b>0 986 444 007</b>	3970902	<b>0 460 424 348</b>
3917549	<b>0 460 424 071</b>	3932123	<b>0 432 131 717</b>	3948523	<b>0 432 191 391</b>	3970905	<b>0 432 133 770</b>
3917556	<b>0 460 426 165</b>	3935033	<b>0 432 131 681</b>	3948525	<b>0 432 191 392</b>	3970985	<b>0 445 120 050</b>
3917559	<b>0 460 426 147</b>	3935213	<b>0 432 131 676</b>	3948527	<b>0 432 191 389</b>	3970987	<b>0 445 120 071</b>
3918282	<b>0 460 426 143</b>	3935669	<b>0 460 424 187</b>	3948529	<b>0 432 191 426</b>	3971529	<b>0 445 020 045</b>
3918509	<b>0 432 191 799</b>	3935671	<b>0 460 424 201</b>	3948608	<b>0 432 191 422</b>	3971529	<b>0 986 437 342</b>
3918965	<b>0 432 133 877</b>	3935673	<b>0 460 424 190</b>	3948636	<b>0 432 191 390</b>	3972451	<b>0 460 424 340</b>
3919010	<b>0 432 133 873</b>	3935677	<b>0 460 424 191</b>	3949619	<b>0 445 120 018</b>	3972665	<b>0 460 426 404</b>
3919058	<b>0 432 191 740</b>	3935679	<b>0 460 424 189</b>	3949619	<b>0 986 435 503</b>	3972814	<b>0 445 020 039</b>
3919091	<b>0 432 133 879</b>	3935991	<b>0 460 424 199</b>	3957423	<b>0 460 424 290</b>	3972814	<b>0 986 437 304</b>
3919092	<b>0 432 133 878</b>	3935993	<b>0 460 424 188</b>	3957423	<b>0 460 424 291</b>	3972815	<b>0 445 020 039</b>
3919298	<b>0 432 131 841</b>	3936618	<b>0 460 426 332</b>	3957694	<b>0 460 424 290</b>	3972815	<b>0 986 437 304</b>
3919300	<b>0 432 131 834</b>	3936618	<b>0 460 426 334</b>	3957694	<b>0 460 424 291</b>	3972887	<b>0 445 120 032</b>
3919302	<b>0 432 131 840</b>	3936619	<b>0 460 426 333</b>	3957729	<b>0 432 133 781</b>	3974952	<b>0 460 426 418</b>
3919304	<b>0 432 131 839</b>	3936619	<b>0 460 426 335</b>	3959106	<b>F 000 439 021</b>	3975701	<b>0 445 020 043</b>
3919306	<b>0 432 131 838</b>	3936628	<b>0 460 426 337</b>	3959107	<b>F 000 439 021</b>	3976372	<b>0 445 120 059</b>
3919339	<b>0 432 131 836</b>	3937157	<b>0 470 506 014</b>	3963717	<b>0 460 426 358</b>	3976631	<b>0 445 120 070</b>
3919339	<b>0 432 131 837</b>	3937159	<b>0 986 444 023</b>	3963717	<b>0 460 426 359</b>	3977080	<b>0 445 120 060</b>
3919343	<b>0 432 131 835</b>	3937160	<b>0 470 506 022</b>	3963953	<b>0 460 426 365</b>	3977081	<b>0 445 120 060</b>
3919347	<b>0 432 133 874</b>	3937167	<b>0 986 444 009</b>	3963955	<b>0 460 426 368</b>	3991098	<b>0 460 424 260</b>
3919350	<b>0 432 131 837</b>	3937396	<b>0 460 424 217</b>	3963955-NX	<b>0 460 426 368</b>	3991100	<b>0 460 424 261</b>
3919582	<b>9 430 082 743</b>	3937400	<b>0 460 424 218</b>	3963960	<b>0 460 426 385</b>	3991128	<b>0 460 424 262</b>
3919602	<b>0 432 191 738</b>	3937507	<b>0 432 131 656</b>	3963963	<b>0 460 424 288</b>	3991129	<b>0 460 424 265</b>
3919744	<b>0 432 133 875</b>	3937670	<b>0 470 506 028</b>	3963965	<b>0 460 424 287</b>	3991131	<b>0 460 424 263</b>
3919846	<b>0 460 424 081</b>	3937671	<b>0 470 506 027</b>	3963965	<b>0 460 424 355</b>	3991604	<b>0 460 424 264</b>
3919956	<b>0 432 133 876</b>	3937673	<b>0 470 506 034</b>	3963966	<b>0 460 424 287</b>	3999832	<b>0 445 120 050</b>
3920140	<b>0 432 191 735</b>	3937673	<b>0 986 444 052</b>	3964009	<b>0 445 020 011</b>	3999832	<b>0 445 120 071</b>
3921180	<b>0 460 426 196</b>	3937690	<b>0 470 506 041</b>	3964273	<b>0 445 120 032</b>	4058319	<b>0 432 191 383</b>
3921835	<b>0 432 191 718</b>	3937690	<b>0 986 444 054</b>	3964407	<b>0 445 020 015</b>	4063212	<b>F 01G 0V4 000</b>



◀ CUMMINS

4 063 269	<b>F 01G 0V4 001</b>
4 063 524	<b>0 432 191 341</b>
4 063 526	<b>0 432 191 342</b>
4 063 630	<b>F 01G 001 000</b>
4 063 648	<b>0 432 191 314</b>

4 078 346	<b>0 432 191 356</b>
4 078 400	<b>0 432 191 352</b>
4 078 583	<b>0 432 131 630</b>
4 093 896	<b>0 460 426 407</b>
4 225 543	<b>0 445 117 046</b>

4 329 469	<b>0 444 042 093</b>
4 329 470	<b>0 444 042 092</b>
4 329 472	<b>0 444 043 074</b>
4 376 716	<b>0 444 043 103</b>
4378552	<b>0 445 010 834</b>

4387304	<b>0 444 042 132</b>
4 387 304	<b>0 986 44D 205</b>
4387304-RX	<b>0 986 44D 205</b>
4387305	<b>0 444 042 133</b>
4 387 305	<b>0 986 44D 206</b>

4387305-RX	<b>0 986 44D 206</b>
4387657	<b>0 444 042 134</b>
4 387 657	<b>0 986 44D 207</b>
4387657-RX	<b>0 986 44D 207</b>
4387658	<b>0 444 042 137</b>

4 387 658	<b>0 986 44D 209</b>
4387658-RX	<b>0 986 44D 209</b>
4 390 205	<b>F 00B C00 041</b>
4 390 376	<b>F 00B C00 043</b>
4 897 040	<b>0 445 020 007</b>

4 897 040	<b>0 986 437 341</b>
4 897 271	<b>0 986 435 508</b>
4 898 921	<b>0 445 020 007</b>
4 898 921	<b>0 986 437 341</b>
4 929 594	<b>0 445 020 072</b>

4 929 594	<b>0 986 437 333</b>
4 930 318	<b>0 460 426 430</b>
4 930 485	<b>0 445 120 070</b>
4 931 667	<b>F 000 439 029</b>
4 933 531	<b>0 460 426 430</b>

4 934 123	<b>0 460 424 375</b>
4 934 123	<b>0 460 426 375</b>
4 934 699	<b>0 460 426 444</b>
4 935 675	<b>0 445 120 094</b>
4 937 065	<b>0 445 120 123</b>

4 937 602	<b>0 460 426 445</b>
4 940 096	<b>0 445 120 071</b>
4 940 170	<b>0 445 120 125</b>
4 940 423	<b>F 00E 200 392</b>
4 940 423	<b>0 986 437 334</b>

4 940 439	<b>0 445 120 112</b>
4 940 589	<b>0 986 435 503</b>
4 940 640	<b>0 445 120 121</b>
4 940 640	<b>0 986 AD1 047</b>
4 941 064	<b>0 445 020 039</b>

4 941 064	<b>0 986 437 304</b>
4 941 066	<b>0 445 020 043</b>
4 941 109	<b>0 445 110 307</b>
4 941 109	<b>0 986 435 196</b>
4 941 173	<b>0 445 020 070</b>

4 941 173	<b>0 986 437 082</b>
4 942 359	<b>0 445 120 122</b>
4 944 476	<b>0 445 120 144</b>
4 945 316	<b>0 445 120 140</b>
4 945 316	<b>0 986 435 544</b>

4 945 463	<b>0 445 120 133</b>
4 945 807	<b>0 445 120 120</b>
4 945 807	<b>0 986 435 543</b>
4 945 969	<b>0 445 120 059</b>
4 947 456	<b>F 00E 200 392</b>

4 947 456	<b>0 445 020 106</b>
4 947 456	<b>0 986 437 334</b>
4 978 028	<b>0 445 010 648</b>
4 981 077	<b>0 445 120 184</b>
4 981 126	<b>0 445 120 152</b>

4 982 057	<b>0 445 020 045</b>
4 982 057	<b>0 986 437 342</b>
4 983 267	<b>0 445 120 060</b>
4 983 416	<b>0 445 020 113</b>
4 983 416	<b>0 986 437 370</b>

4 983 514	<b>0 445 120 187</b>
4 983 514	<b>0 986 435 573</b>
4 983 836	<b>0 445 020 099</b>
4 988 593	<b>0 445 020 043</b>
4 988 835	<b>0 445 120 161</b>

4 989 266	<b>0 445 020 109</b>
4 989 266	<b>0 986 437 375</b>
4 990 601	<b>0 445 020 119</b>
4 993 482	<b>0 445 120 133</b>
4 994 541	<b>0 445 120 199</b>

4 994 547	<b>0 445 020 107</b>
4 994 547	<b>0 986 437 333</b>
4 994 925	<b>0 445 120 342</b>
4 994 928	<b>0 986 435 574</b>
5 252 703	<b>0 445 020 176</b>

5 253 220	<b>0 445 120 193</b>
5 253 220	<b>0 986 435 518</b>
5253220-NX	<b>0 445 120 193</b>
5 253 221	<b>0 445 120 204</b>
5 253 221	<b>0 986 435 519</b>

5 254 261	<b>0 445 120 177</b>
5 254 461	<b>0 445 020 123</b>
5 254 461	<b>0 986 437 337</b>
5 254 682	<b>0 445 120 209</b>
5 254 684	<b>0 445 120 211</b>

5 254 686	<b>0 445 120 210</b>
5 255 184	<b>0 445 120 212</b>
5 256 034	<b>0 445 120 187</b>
5 256 034	<b>0 986 435 573</b>
5 256 607	<b>0 445 020 122</b>

5 256 607	<b>0 986 437 310</b>
5256607-NX	<b>0 445 020 122</b>
5256607-NX	<b>0 986 437 310</b>
5 258 264	<b>0 445 020 137</b>
5 258 264	<b>0 445 020 278</b>

5 258 264	<b>0 986 437 319</b>
5258264-RX	<b>0 445 020 137</b>
5 258 744	<b>0 445 110 376</b>
5 258 774	<b>0 445 110 373</b>
5 258 774	<b>0 986 435 243</b>

5 262 128	<b>0 445 120 332</b>
5 262 703	<b>0 445 020 176</b>
5 263 094	<b>0 445 020 227</b>
5 263 230	<b>0 445 120 257</b>
5 263 262	<b>0 445 120 231</b>

5 263 262	<b>0 986 435 597</b>
5 263 304	<b>0 445 120 241</b>
5 263 305	<b>0 445 120 272</b>
5 263 305	<b>0 986 435 532</b>
5263306	<b>0 445 120 240</b>

5 263 307	<b>0 445 120 273</b>
5 263 307	<b>0 986 435 571</b>
5 263 308	<b>0 445 120 236</b>
5 263 308	<b>0 986 435 522</b>
5263310	<b>0 445 120 237</b>

5263310	<b>0 986 435 555</b>
5 263 312	<b>0 445 120 239</b>
5263313	<b>0 445 120 253</b>
5263314	<b>0 445 120 251</b>
5263315	<b>0 445 120 252</b>

5 263 316	<b>0 445 120 238</b>
5 263 316	<b>0 986 435 505</b>
5 263 317	<b>0 445 120 254</b>
5 263 317	<b>0 986 435 575</b>
5 263 318	<b>0 445 120 255</b>

5 263 319	<b>0 445 120 256</b>
5 263 319	<b>0 986 435 576</b>
5 263 321	<b>0 445 120 250</b>
5 263 321	<b>0 986 435 533</b>
5 264 243	<b>0 445 020 149</b>

5 264 243	<b>0 986 437 337</b>
5 264 245	<b>0 445 020 151</b>
5 264 246	<b>0 445 020 147</b>
5 264 246	<b>0 986 437 304</b>
5264246-NX	<b>0 445 020 147</b>

5264246-NX	<b>0 986 437 304</b>
5 264 247	<b>F 00E 200 392</b>
5 264 247	<b>0 445 020 146</b>
5 264 247	<b>0 986 437 334</b>
5 264 248	<b>0 445 020 150</b>

5 264 248	<b>0 986 437 342</b>
5 264 250	<b>0 445 020 148</b>
5 264 250	<b>0 986 437 333</b>
5 264 272	<b>0 445 120 297</b>
5 265 053	<b>0 460 424 490</b>

5 268 436	<b>0 445 120 305</b>
5 269 194	<b>0 445 120 267</b>
5 269 194	<b>0 986 435 644</b>
5 271 684	<b>0 445 120 366</b>
5 272 937	<b>0 445 120 304</b>

5 273 441	<b>0 445 020 182</b>
5 273 750	<b>0 445 120 328</b>
5 289 266	<b>0 445 124 019</b>
5 289 380	<b>0 445 120 336</b>
5 296 096	<b>0 445 020 224</b>

5 302 736	<b>0 445 020 609</b>
5 303 101	<b>0 445 120 356</b>
5 303 387	<b>0 445 020 517</b>
5 303 745	<b>0 445 020 248</b>
5 305 254	<b>0 444 043 051</b>

5 305 413	<b>0 445 020 255</b>
5 308 953	<b>0 432 133 760</b>
5 309 291	<b>0 445 110 594</b>
5 309 291	<b>0 445 110 828</b>
5 310 954	<b>0 445 120 384</b>

5 310 954	<b>0 986 435 644</b>
5 311 830	<b>0 445 020 241</b>
5 317 930	<b>0 445 110 675</b>
5 339 808	<b>0 445 020 284</b>
5344024	<b>0 445 020 286</b>

5 364 204	<b>0 445 124 039</b>
5 364 205	<b>0 445 124 047</b>
5 367 161	<b>0 445 120 455</b>
5 398 300	<b>0 445 010 845</b>
5 398 557	<b>0 445 020 300</b>

5 398 557	<b>0 986 437 370</b>
5 399 800	<b>0 445 020 317</b>
5 529 491	<b>0 460 426 445</b>

**CUMMINS NEWMAN USA**

2871878-NX	<b>0 444 043 007</b>
2888174-NX	<b>0 444 043 018</b>

3965402NX	<b>0 470 006 005</b>
3965404NX	<b>0 470 004 018</b>
5264247NX	<b>0 445 020 146</b>

**DACIA**

16 60 083 99R	<b>0 445 110 485</b>
16 60 083 99R	<b>0 986 435 240</b>
16 70 010 56R	<b>0 445 010 530</b>

16 70 010 56R	<b>0 986 437 439</b>
---------------	----------------------



**DAEWOO**

220S 96859151	<b>0 445 010 332</b>
000 094 05 48	<b>0 280 217 517</b>
003 017 29 21	<b>0 432 217 169</b>

41710201 8	<b>0 460 424 229</b>
41760200 6	<b>0 432 193 538</b>
41760201 7	<b>0 432 193 518</b>
55594059	<b>0 444 021 038</b>
65.10401-7001	<b>0 445 120 040</b>

65.10401-7002	<b>0 445 120 041</b>
65.10501-7001	<b>0 445 020 031</b>
96440341	<b>0 445 010 142</b>
96440341	<b>0 986 437 032</b>
96440397	<b>0 445 110 269</b>

96440397	<b>0 986 435 153</b>
96486983	<b>0 445 010 332</b>
96859151	<b>0 445 010 332</b>

**DAF**

071232	<b>0 432 291 587</b>
0910396	<b>0 432 133 855</b>
0910398	<b>0 432 133 798</b>

096061	<b>0 432 291 587</b>
1249424	<b>0 432 291 543</b>
1249950	<b>0 432 191 702</b>
1250793	<b>0 432 291 538</b>
1256049	<b>0 432 191 704</b>

1256050	<b>0 432 191 703</b>
1267413	<b>0 432 291 528</b>
1278695	<b>0 432 191 673</b>
1287143	<b>0 432 191 644</b>
12871432	<b>0 432 191 644</b>

1295600	<b>0 432 191 604</b>
1296618	<b>0 432 191 626</b>
1296619	<b>0 432 191 626</b>
1301283	<b>0 432 191 606</b>
1314244	<b>0 432 191 583</b>

1317973	<b>0 432 191 570</b>
1322504	<b>0 432 291 528</b>
1338833	<b>0 432 191 604</b>
1338834	<b>0 432 191 583</b>
1338835	<b>0 432 191 570</b>

1339008	<b>0 432 191 504</b>
1345079	<b>0 432 191 504</b>
1379110	<b>0 414 755 005</b>
1392052	<b>0 414 755 005</b>
1392052	<b>0 986 445 005</b>

1392052R	<b>0 986 445 005</b>
1396092	<b>0 432 191 382</b>
1397832	<b>0 432 191 381</b>
1399464	<b>0 445 020 007</b>
1399464	<b>0 986 437 341</b>

1409696	<b>0 445 020 045</b>
1435558	<b>0 414 755 008</b>
1435558	<b>0 986 445 013</b>
1435558R	<b>0 986 445 013</b>
1437211	<b>0 432 191 382</b>

1437212	<b>0 432 191 381</b>
1453001	<b>0 432 191 253</b>
1606963	<b>0 432 191 315</b>
1642684	<b>0 432 191 254</b>
1674654	<b>0 444 011 022</b>

1674655	<b>0 444 010 036</b>
1674655	<b>0 986 44D 002</b>
1674660	<b>0 444 010 036</b>
1674661	<b>0 444 011 013</b>
1674662	<b>0 444 012 003</b>

1693191	<b>0 444 010 036</b>
1693191	<b>0 986 44D 002</b>
1702932	<b>0 445 020 045</b>
1702932	<b>0 445 020 150</b>
1702932	<b>0 986 437 342</b>

1702932R	<b>0 986 437 342</b>
1703934	<b>0 445 120 060</b>
1703947	<b>0 445 020 007</b>
1703947	<b>0 986 437 341</b>
1703947R	<b>0 986 437 341</b>

1704596	<b>0 445 020 137</b>
1735780	<b>0 444 012 003</b>
1738100	<b>0 444 010 021</b>
1738100	<b>0 444 010 033</b>
1738100	<b>0 986 44D 004</b>

1746947	<b>0 444 010 021</b>
1746947	<b>0 444 010 033</b>
1746947	<b>0 986 44D 004</b>
1791500	<b>0 444 010 021</b>
1791500	<b>0 444 010 033</b>

1791500	<b>0 986 44D 004</b>
1791538	<b>0 444 011 011</b>
1791538	<b>0 444 011 023</b>
1791539	<b>0 444 011 024</b>
1791540	<b>0 986 44D 002</b>

1791540R	<b>0 986 44D 002</b>
1791542	<b>0 444 010 033</b>
1818625	<b>0 444 010 033</b>
1818625	<b>0 986 44D 004</b>
1818625R	<b>0 444 010 033</b>

1818625R	<b>0 986 44D 004</b>
1819790	<b>0 444 011 011</b>
1819790	<b>0 444 011 023</b>
1864829R	<b>0 986 435 533</b>
394099	<b>0 432 291 630</b>

**DAIHATSU-DIESEL**

AE01062040CA	<b>H 105 113 586</b>
AE01062044BA	<b>H 105 113 588</b>
AE01062046BA	<b>H 105 113 589</b>

AE02062034BB	<b>H 105 114 344</b>
AE02062036AA	<b>F 01G 09X 06T</b>
AE02062036BB	<b>H 105 114 345</b>
AE02062040BA	<b>H 105 114 356</b>
AE02062045AA	<b>H 105 114 554</b>

AE47062020BA	<b>H 105 113 584</b>
AE48062006AB	<b>F 01G 09X 076</b>
AE48062012A	<b>H 105 114 553</b>
AE48062016AA	<b>H 105 114 571</b>
E166255040ZZ	<b>H 105 113 387</b>

E206250400BZ	<b>H 105 113 575</b>
E206250410BZ	<b>H 105 113 574</b>
E206250420BZ	<b>H 105 113 576</b>
E206255090AZ	<b>H 105 113 577</b>
E206255110AZ	<b>H 105 113 578</b>

E206255210AZ	<b>H 105 113 581</b>
E266285230ZZ	<b>H 105 114 352</b>
E266285240ZA	<b>H 105 114 543</b>
E286275030AZ	<b>H 105 114 346</b>
E366200680CZ	<b>F 01G 09X 05Y</b>

E366205320AZ	<b>H 105 115 518</b>
75320460	<b>F 01G 09X 05Y</b>

**DCD (DONGFENG CHAOYANG DIES.)**

16010BF001	<b>0 445 020 085</b>
16010BZ002	<b>0 445 020 210</b>

40100BM003	<b>0 445 110 383</b>
40100BZ004	<b>0 445 110 692</b>

**DCEC (DONGFENG CUMMINS ENGINE)**

C5307809	<b>0 445 120 377</b>
----------	----------------------

**DELPHI**

AF10078-12B1	<b>0 281 002 318</b>
AF10078-12B1	<b>0 281 002 461</b>
AF10078-12B1	<b>0 281 002 757</b>

AF10078-12B1	<b>0 986 284 010</b>
AF10080-12B1	<b>0 281 002 309</b>
AF10082-12B1	<b>0 281 002 184</b>
AF10082-12B1	<b>0 281 002 613</b>
AF10083-12B1	<b>0 281 002 216</b>

AF10084-12B1	<b>0 281 002 403</b>
AF10084-12B1	<b>0 281 002 429</b>
AF10085-12B1	<b>0 281 002 207</b>
B 029 04 B	<b>0 432 191 359</b>
B 029 05 B	<b>0 432 191 400</b>

B 029 06 B	<b>0 432 191 360</b>
B 029 07 B	<b>0 432 191 363</b>
B 030 03 B	<b>0 432 191 395</b>
SC10028	<b>0 281 002 478</b>

**DETROIT DIESEL CORPORATION**

0414703005	<b>0 414 703 005</b>
0414703007	<b>0 414 703 007</b>

04901195	<b>0 444 022 038</b>
----------	----------------------

**DEUTZ AG**

04611049	<b>0 444 042 063</b>
----------	----------------------

**DEUTZ-FAHR**

02112957	<b>0 432 191 327</b>
0450 4666	<b>0 445 124 001</b>
0490 9357	<b>0 445 124 008</b>

**DODGE**

K04883459AA	<b>0 460 404 980</b>
K4720171	<b>0 432 217 222</b>
R5013925AA	<b>0 470 506 022</b>

R5013925AA	<b>0 986 444 007</b>
R5019657AD	<b>0 470 506 028</b>
R5019657AD	<b>0 986 444 023</b>
R5135154AB	<b>0 445 110 181</b>
R5135154AB	<b>0 986 435 053</b>

R5142257AA	<b>0 445 010 275</b>
R5142257AA	<b>0 986 437 106</b>
R5191780AD	<b>0 445 020 147</b>
R5191780AD	<b>0 986 437 304</b>
04861076	<b>0 281 002 132</b>

05013 847AA	<b>0 432 193 629</b>
05013 848AA	<b>0 432 193 630</b>
05019 658AD	<b>0 470 506 027</b>
05019 658AD	<b>0 986 444 022</b>
05033 320AA	<b>0 281 002 779</b>

05080295AA	<b>0 445 010 271</b>
05080 300AA	<b>0 445 110 203</b>
05080 300AA	<b>0 986 435 039</b>
05080 300AA	<b>0 986 435 065</b>
05135 154AA	<b>0 986 435 053</b>

05135 790AD	<b>0 445 120 238</b>
05135 790AD	<b>0 986 435 505</b>
05136012AA	<b>0 445 010 270</b>
05137 297AA	<b>0 445 110 162</b>
05137 297AA	<b>0 986 435 109</b>



◀ DODGE

05142 257AA	<b>0 986 437 366</b>
05253 220	<b>0 986 435 518</b>
05263 316	<b>0 986 435 505</b>
05263318	<b>0 986 435 503</b>
05264 247	<b>F 00E 200 392</b>

05264 247	<b>0 986 437 334</b>
09864 35519	<b>0 445 120 204</b>
150620012 F	<b>0 460 404 980</b>
4861 076	<b>0 281 002 132</b>
5013847AA	<b>0 432 193 629</b>

5013848AA	<b>0 432 193 630</b>
5019658AD	<b>0 470 506 027</b>
5019658AD	<b>0 986 444 022</b>
5033320AA	<b>0 281 002 779</b>
5080295AA	<b>0 445 010 271</b>

5080 300AA	<b>0 445 110 203</b>
5080 300AA	<b>0 986 435 039</b>
5080 300AA	<b>0 986 435 065</b>
5135 154AA	<b>0 986 435 053</b>
5135 790AD	<b>0 445 120 238</b>

5135 790AD	<b>0 986 435 505</b>
5136 012AA	<b>0 445 010 270</b>
5137 297AA	<b>0 445 110 162</b>
5137 297AA	<b>0 986 435 109</b>
5142 257AA	<b>0 986 437 366</b>

5253 220	<b>0 986 435 518</b>
5263 316	<b>0 986 435 505</b>
5 263 318	<b>0 986 435 503</b>
5264 247	<b>F 00E 200 392</b>
5264 247	<b>0 986 437 334</b>

68014 060AA	<b>0 986 437 363</b>
68014 079AA	<b>0 986 435 398</b>
68027 022AC	<b>0 445 020 146</b>
68027 022AC	<b>0 986 437 334</b>
68042029AA	<b>0 445 115 067</b>

68042029AA	<b>0 986 435 402</b>
68046351AA	<b>0 445 010 152</b>
68086 182AA	<b>0 445 120 188</b>
68210105-AA	<b>0 445 120 342</b>
68210 512AA	<b>0 445 120 187</b>

68210 512AA	<b>0 986 435 574</b>
68211 269AA	<b>0 445 010 684</b>
68211 269AA	<b>0 986 437 468</b>
68211 302AA	<b>0 445 110 522</b>
68211 302AA	<b>0 986 435 251</b>

68226 951AA	<b>0 445 116 059</b>
68226 951AA	<b>0 986 435 255</b>
68246 830AA	<b>0 445 010 593</b>
68246 830AA	<b>0 986 437 461</b>
9864 35519	<b>0 445 120 204</b>

**DONGFENG**

A 3960741	<b>0 460 424 257</b>
D5010222523	<b>0 445 020 219</b>
D5010222559	<b>0 445 120 309</b>

D5010477874	<b>0 445 120 084</b>
D5010553948	<b>0 445 020 062</b>
1111BF11-010	<b>0 445 020 111</b>
1111010 E4101	<b>0 445 010 428</b>
1112BF11-010	<b>0 445 120 242</b>

16010AD001	<b>0 445 025 051</b>
16010BM001	<b>0 445 010 198</b>
16010BZ003	<b>0 445 025 047</b>
16010DE001	<b>0 445 010 199</b>
40100DE001	<b>0 445 110 360</b>

4988595	<b>0 445 020 150</b>
---------	----------------------

**DONGFENG CUMMINS ENGINE (DCEC)**

D4937065	<b>0 445 120 123</b>
D5010222526	<b>0 445 120 106</b>

D5010222526	<b>0 445 120 310</b>
0445120231	<b>0 445 120 231</b>
4940640	<b>0 445 120 121</b>
4940640	<b>0 986 AD1 047</b>
4942359	<b>0 445 120 122</b>

**DOOSAN**

300628-00008	<b>0 444 022 031</b>
300628-00106	<b>0 444 042 082</b>
300628-00302	<b>0 444 110 003</b>

300630-00015	<b>0 444 043 059</b>
300630-00044B	<b>0 444 063 017</b>
400903-00036	<b>0 445 120 295</b>
400903-00104	<b>0 445 120 376</b>
400903-0031	<b>0 445 120 258</b>

400912-00008	<b>0 445 020 132</b>
400912-00030A	<b>0 445 020 152</b>
400912-00007	<b>0 445 020 157</b>
400912-00277	<b>0 445 020 253</b>
65 10101 7097	<b>0 432 191 241</b>

65.10501-7001A	<b>0 445 020 031</b>
65.10501-7002	<b>0 445 020 032</b>
65.10501-7005	<b>0 445 020 067</b>
65.10501-7006	<b>0 445 020 127</b>
65.10501-7007	<b>0 445 020 128</b>

65.15301-7001	<b>0 444 023 015</b>
65.15401-7001	<b>0 444 022 009</b>
65.15401-7001	<b>0 444 022 031</b>

**DPL**

DPL848019	<b>0 280 218 019</b>
DPL848111	<b>0 280 217 111</b>
DPL848117	<b>0 280 217 117</b>

**DTC (DIESEL TECHNOLOGY COMP.)**

5235710	<b>0 414 701 055</b>
5235710	<b>0 986 441 004</b>

5236050	<b>0 414 700 002</b>
5236543	<b>0 414 701 105</b>
5236543	<b>0 986 441 101</b>
5236686	<b>0 414 702 017</b>
5237095	<b>0 986 441 109</b>

5237146	<b>0 986 441 005</b>
5237151	<b>0 986 441 107</b>
5237152	<b>0 986 441 108</b>
5237177	<b>0 986 441 112</b>
5237330	<b>0 986 441 110</b>

**EBERSPAECHER**

90.001.02	<b>0 281 002 216</b>
90.001.02	<b>0 281 002 461</b>
90.001.02	<b>0 281 002 757</b>

90.001.02	<b>0 986 284 010</b>
90.002.02	<b>0 281 002 403</b>
90.002.02	<b>0 281 002 429</b>
90.003.02	<b>0 281 002 479</b>
90.004.02	<b>0 281 002 180</b>

90.004.02	<b>0 281 002 199</b>
90.004.02	<b>0 281 002 309</b>
90.004.02	<b>0 281 002 428</b>
90.004.02	<b>0 281 002 554</b>
90.004.02	<b>0 281 002 579</b>

90.007.02	<b>0 281 002 384</b>
90.009.01	<b>0 281 002 216</b>
90.011.01	<b>0 281 002 429</b>
90.012.01	<b>0 281 002 757</b>
90.012.01	<b>0 986 284 010</b>

90.021.01	<b>0 281 002 461</b>
90.022.01	<b>0 281 002 463</b>
90.033.01	<b>0 281 002 318</b>
90.035.01	<b>0 281 002 403</b>
90.049.01	<b>0 281 002 184</b>

90.061.01	<b>0 281 002 195</b>
90.065.01	<b>0 281 002 309</b>
90.072.01	<b>0 281 002 435</b>
90.072.01	<b>0 986 284 006</b>
90.105.01	<b>0 281 002 308</b>

90.110.01	<b>0 281 002 478</b>
90.121.01	<b>0 281 002 613</b>
90.131.01	<b>0 281 002 207</b>
90.133.01	<b>0 281 002 144</b>
90.136.01	<b>0 281 002 479</b>

90.137.01	<b>0 281 002 428</b>
90.138.01	<b>0 281 002 180</b>

**EICHER**

ID301239	<b>F 002 C7Z 293</b>
----------	----------------------

**EICHER MOTORS LIMITED**

D46056496000	<b>0 460 416 106</b>
ID000191	<b>F 002 C7Z 302</b>

ID000213	<b>0 460 414 201</b>
ID000348	<b>0 460 414 214</b>
ID000466	<b>F 002 C7Z 215</b>
ID201846	<b>0 460 416 095</b>
1461907435	<b>0 460 416 100</b>

**EURO-AUTOMOBILE**

C101872568	<b>0 280 218 119</b>
C101873442	<b>0 281 002 549</b>

**FACET**

10.1017	<b>0 281 002 212</b>
10.1033	<b>0 281 002 533</b>
10.1034	<b>0 281 002 184</b>

10.1126	<b>0 281 002 567</b>
10.1126	<b>0 281 002 585</b>
10.1155	<b>0 281 002 180</b>
10.1155	<b>0 281 002 199</b>
10.1155	<b>0 281 002 309</b>

10.1155	<b>0 281 002 428</b>
10.1158	<b>0 281 002 613</b>
10.1158	<b>0 281 002 619</b>
10.1191	<b>0 281 002 461</b>
10.1192	<b>0 281 002 216</b>

10.1264	<b>0 281 002 447</b>
10.1266	<b>0 281 002 554</b>
10.1276	<b>0 281 002 683</b>
10.1276	<b>0 281 002 861</b>
10.1283	<b>0 281 002 308</b>

10.1284	<b>0 281 002 757</b>
10.1284	<b>0 986 284 010</b>
10.1289	<b>0 281 002 600</b>
10.1293	<b>0 281 002 764</b>
10.1293	<b>0 281 006 048</b>

10.1299	<b>0 281 002 792</b>
10.1299	<b>0 281 002 980</b>
10.1325	<b>0 281 002 757</b>
10.1325	<b>0 986 284 010</b>
10.1348	<b>0 281 002 849</b>

10.1348	<b>0 281 002 936</b>
10.1354	<b>0 281 002 535</b>
10.1359	<b>0 281 002 896</b>
10.1372	<b>0 281 002 723</b>
10.1376	<b>0 281 002 721</b>

10.1384	<b>0 281 006 248</b>
10.1413	<b>0 281 002 917</b>
10.1413	<b>0 281 006 054</b>
10.1443	<b>0 281 002 152</b>
10.1445	<b>0 281 002 537</b>

10.1445	<b>0 281 002 598</b>
10.1446	<b>0 281 002 956</b>
10.1500	<b>0 281 006 248</b>
10.3055	<b>0 281 002 160</b>

**FAMSA TRUCK**

0010178621	<b>0 432 231 824</b>
0010178621	<b>0 986 430 046</b>
0010178721	<b>0 432 231 823</b>

0010178721	<b>0 986 430 045</b>
0020172121	<b>0 432 231 770</b>

**FAUN**

4795 040	<b>0 432 207 006</b>
4795 848	<b>0 432 291 807</b>
4795 848	<b>0 986 430 124</b>

**FAW**

CRP-26E	<b>0 445 020 168</b>
DNOX2.2-6DL-DM	<b>0 444 043 009</b>
S1111010-L40-0000	<b>0 445 020 162</b>

1100010-556-0000	<b>0 445 025 019</b>
1111010AL50-0000	<b>0 445 020 162</b>
1111010A470-0000	<b>0 445 020 061</b>
1111010A630-0000	<b>0 445 020 058</b>
1111010B550-0000	<b>0 445 020 078</b>

1111010-470-0000BL	<b>0 445 020 102</b>
1111010-630-0000BL	<b>0 445 020 144</b>
1111010-68F-0000	<b>0 445 020 177</b>
1111010-73D	<b>0 445 020 077</b>
1111010-853-0000	<b>0 445 020 213</b>

1111100-A51-0000	<b>0 445 025 037</b>
1111100-B81-0000	<b>0 445 025 036</b>
1111300-D01	<b>0 445 010 221</b>
1112010B470-0000	<b>0 445 120 081</b>
1112010-440-0000	<b>0 445 120 324</b>

1112010-470-0000BL	<b>0 445 120 331</b>
1112010-640-0000	<b>0 445 120 395</b>
1112010-68F-0000	<b>0 445 120 396</b>
1112010-853-0000	<b>0 445 120 317</b>
1112100AB81-0000	<b>0 445 110 541</b>

1112100-A51-0000	<b>0 445 110 542</b>
1112100B35	<b>0 445 110 395</b>
1112100-B35	<b>0 445 110 426</b>
1112100-D02	<b>0 445 110 355</b>
1161010A682-0000EM	<b>0 444 110 012</b>

1161210-A12/A	<b>0 444 043 027</b>
1161210-A12/B	<b>0 444 043 027</b>
1161210-51B/A	<b>0 444 043 050</b>
1161210-682-0000	<b>0 444 043 050</b>
1161210-682-0000EM	<b>0 444 043 082</b>

1161210-682-0000(1)	<b>0 444 043 009</b>
2S1111010-L20-0000	<b>0 445 020 162</b>
2S1112010-L20-0000	<b>0 445 120 263</b>
3602300-D01	<b>0 281 006 042</b>

**FEBI**

19374	<b>0 280 217 121</b>
19374	<b>0 281 002 757</b>
19374	<b>0 986 284 010</b>

19380	<b>0 281 002 216</b>
21969	<b>0 928 400 527</b>
23875	<b>0 280 217 123</b>
23877	<b>0 281 002 144</b>
23877	<b>0 281 002 180</b>

27703	<b>0 281 002 428</b>
28340	<b>0 281 002 152</b>
28532	<b>0 281 002 429</b>
28596	<b>0 281 002 757</b>
28596	<b>0 986 284 010</b>

28603	<b>0 281 002 216</b>
29315	<b>0 281 002 535</b>
29517	<b>0 281 002 656</b>
29910	<b>0 281 002 384</b>
31412	<b>0 281 002 461</b>

37228	<b>0 281 002 683</b>
-------	----------------------

**FENDT**

F 131 204 710 171	<b>0 432 291 029</b>
F 339 202 710 060	<b>0 445 120 065</b>
V 836 339 088	<b>0 432 292 866</b>

V 836 339 180	<b>0 432 292 867</b>
V 836 354 615	<b>0 432 191 631</b>
V 836 354 759	<b>0 432 191 517</b>
V 836 669 330	<b>0 460 423 028</b>
V 836 864 609	<b>0 470 506 042</b>

V 836 869 461	<b>0 470 006 008</b>
V 837069146	<b>0 445 020 054</b>
V 837 069 146	<b>0 986 437 384</b>
V 837069148	<b>0 445 020 056</b>
V 837 069 326	<b>0 445 120 062</b>

V 837 069 405	<b>0 445 120 063</b>
V 837 072 107	<b>0 444 023 011</b>
V 837073240	<b>0 445 110 381</b>
V 837 073 240	<b>0 986 435 206</b>
V 837073730	<b>0 445 020 512</b>

V 837073731	<b>0 445 020 610</b>
V 837073791	<b>0 445 110 408</b>
V 837074805	<b>0 445 020 611</b>
422 479 6M1	<b>0 470 006 009</b>

**FERRARI**

154916	<b>0 986 280 110</b>
162530	<b>0 280 217 521</b>
181120	<b>0 280 218 085</b>

208444	<b>0 280 218 217</b>
55 23 43 62	<b>0 445 010 303</b>

**FIAT**

S00005123	<b>0 445 120 334</b>
0000055183650	<b>0 281 002 792</b>
0000055191957	<b>0 445 110 165</b>

0000055191957	<b>0 986 435 103</b>
0000055191958	<b>0 445 110 159</b>
0000055191958	<b>0 986 435 088</b>
0000060816137	<b>0 281 002 309</b>
0000060816448	<b>0 281 002 308</b>

0000071794966	<b>0 445 110 183</b>
0000073503097	<b>0 445 110 111</b>
0000073503097	<b>0 986 435 081</b>
0046447508	<b>0 281 002 199</b>
0055263233	<b>0 445 110 682</b>

0055263233	<b>0 986 435 289</b>
0055263525	<b>0 445 010 455</b>
055236299	<b>0 445 010 388</b>
055237690	<b>0 445 010 292</b>
055238143	<b>0 445 010 388</b>

11140004	<b>0 281 002 683</b>
13243690	<b>0 281 002 184</b>
1324369080	<b>0 281 002 184</b>
1337322080	<b>0 281 002 565</b>
15062012	<b>0 432 217 222</b>

15062016	<b>0 432 217 249</b>
2995486	<b>0 986 441 120</b>
35022001	<b>0 460 416 035</b>
46407008	<b>0 280 217 111</b>
46411675	<b>0 281 002 144</b>

46416748	<b>0 280 217 514</b>
464 3021 02	<b>0 445 110 002</b>
464 3021 02	<b>0 986 435 001</b>
46437382	<b>0 460 484 112</b>
46441787	<b>0 281 002 160</b>

46444287	<b>0 280 217 531</b>
46444287	<b>0 986 280 233</b>
46447503	<b>0 280 218 019</b>
46447503	<b>0 986 280 236</b>
46447508	<b>0 281 002 199</b>

46461616	<b>0 432 217 296</b>
46461617	<b>0 432 217 297</b>
46462971	<b>0 445 110 002</b>
464 6297 10	<b>0 986 435 001</b>
46464928	<b>0 280 217 102</b>

46469917	<b>0 280 218 001</b>
46469917	<b>0 986 280 234</b>
46472182	<b>0 281 002 199</b>
46472233	<b>0 445 110 002</b>
46472233	<b>0 986 435 001</b>

46472711	<b>0 460 484 126</b>
46522786	<b>0 445 010 006</b>
46522786	<b>0 986 437 001</b>
46522787	<b>0 445 010 007</b>
46522787	<b>0 986 437 002</b>

46533308	<b>0 280 218 004</b>
46533308	<b>0 986 280 235</b>
46541253	<b>0 280 218 019</b>
46541253	<b>0 986 280 236</b>
46547897	<b>0 445 110 019</b>

46547897	<b>0 986 435 006</b>
46552161	<b>0 460 484 154</b>
46554997	<b>0 460 484 083</b>
46559804	<b>0 281 002 309</b>
46559828	<b>0 281 002 308</b>

46740023	<b>0 460 484 155</b>
46749246	<b>0 280 218 054</b>
46749246	<b>0 986 280 238</b>
46779630	<b>0 445 010 276</b>
46779630	<b>0 986 437 023</b>

46784582	<b>0 281 002 613</b>
46787376	<b>0 445 110 068</b>
46808221	<b>0 281 002 533</b>
46811122	<b>0 280 218 120</b>
46811229	<b>0 445 010 006</b>

46811230	<b>0 445 010 007</b>
46811230	<b>0 986 437 002</b>
46811312	<b>0 280 218 113</b>
46811312	<b>0 986 280 239</b>
46824377	<b>0 281 002 598</b>

4750504	<b>0 432 281 704</b>
4792442	<b>0 432 291 654</b>
4792992	<b>0 986 440 023</b>
4794588	<b>0 460 414 013</b>
4794588	<b>0 986 440 024</b>

4794589	<b>0 460 414 015</b>
4798834	<b>0 460 416 036</b>
4800029	<b>0 432 291 655</b>
4803490	<b>0 460 416 042</b>
4804869	<b>0 460 414 024</b>

4810522	<b>0 432 291 648</b>
4810552	<b>0 432 291 648</b>
4812995	<b>0 986 440 028</b>
4814197	<b>0 986 440 027</b>
4820872	<b>0 986 440 076</b>



## ◀ FIAT

4830159	<b>0 986 440 032</b>	504 2871 06	<b>0 414 703 009</b>	55191959	<b>0 986 435 099</b>	55200259	<b>0 445 110 276</b>
48989210	<b>0 445 020 007</b>	504 2871 08	<b>0 414 703 013</b>	55192096	<b>0 445 110 083</b>	55200259	<b>0 986 435 148</b>
48989210	<b>0 986 437 341</b>	504381868	<b>0 986 44D 232</b>	55192096	<b>0 986 435 078</b>	55201803	<b>0 445 010 293</b>
500 3034 85	<b>0 432 117 002</b>	504386427	<b>0 445 110 435</b>	55192138	<b>0 445 010 097</b>	55201803	<b>0 986 437 036</b>
500 3057 24	<b>0 986 440 163</b>	504386427	<b>0 986 435 227</b>	55192138	<b>0 986 437 025</b>	55202251	<b>0 445 110 299</b>
500 3131 05	<b>0 445 120 002</b>	5043879290	<b>0 445 120 282</b>	55192488	<b>0 445 110 112</b>	55202251	<b>0 986 435 230</b>
500 3131 05	<b>0 986 435 501</b>	50438875	<b>0 445 124 014</b>	55192488	<b>0 986 435 101</b>	55204428	<b>0 445 010 150</b>
500 3233 62	<b>0 460 424 152</b>	50438875	<b>0 986 435 655</b>	55192489	<b>0 445 110 111</b>	55204428	<b>0 445 010 286</b>
500 3282 86	<b>0 432 193 666</b>	504388756	<b>0 445 020 160</b>	55192489	<b>0 986 435 081</b>	55204429	<b>0 445 010 123</b>
500 3310 74	<b>0 414 701 083</b>	504388756	<b>0 986 437 512</b>	55192495	<b>0 445 110 083</b>	55204429	<b>0 445 010 285</b>
500 3390 59	<b>0 414 701 084</b>	504389548	<b>0 445 110 418</b>	55192495	<b>0 986 435 078</b>	55204429	<b>0 445 010 349</b>
500366314	<b>0 445 020 006</b>	504389548	<b>0 986 435 212</b>	55192534	<b>0 445 110 111</b>	55204599	<b>0 445 010 097</b>
500 3719 47	<b>0 445 020 008</b>	51774531	<b>0 281 002 613</b>	55192534	<b>0 986 435 081</b>	55204599	<b>0 986 437 025</b>
500 3719 47	<b>0 986 437 318</b>	51782033	<b>0 281 002 861</b>	55192579	<b>0 445 110 187</b>	55205935	<b>0 986 437 035</b>
500 3808 84	<b>0 414 700 003</b>	51782034	<b>0 281 002 980</b>	55192579	<b>0 986 435 099</b>	55206489	<b>0 445 010 293</b>
500 3808 84	<b>0 414 700 009</b>	51782035	<b>0 281 002 860</b>	55192739	<b>0 445 110 159</b>	55206489	<b>0 986 437 036</b>
500 3842 84	<b>0 445 120 002</b>	51782035	<b>0 281 002 917</b>	55192739	<b>0 986 435 088</b>	55206679	<b>0 445 010 156</b>
500 3842 84	<b>0 986 435 501</b>	51792707	<b>0 281 002 963</b>	55192740	<b>0 445 110 213</b>	55206679	<b>0 445 010 288</b>
500 3859 52	<b>0 460 424 220</b>	51792729	<b>0 280 218 237</b>	55192740	<b>0 986 435 162</b>	552 0668 00	<b>0 445 010 155</b>
50402200	<b>0 414 700 005</b>	51827033	<b>0 281 006 048</b>	55192741	<b>0 445 110 165</b>	552 0668 00	<b>0 445 010 287</b>
504 0441 91	<b>0 460 424 252</b>	51830257	<b>0 281 006 056</b>	55192947	<b>0 445 110 119</b>	552066800	<b>0 986 437 026</b>
504 0441 93	<b>0 460 424 248</b>	51830368	<b>0 280 218 242</b>	55192947	<b>0 986 435 083</b>	55206704	<b>0 445 110 300</b>
504 0575 67	<b>0 460 426 371</b>	51831050	<b>0 281 006 054</b>	55192948	<b>0 445 110 119</b>	55206704	<b>0 986 435 171</b>
504 0661 41	<b>0 445 120 011</b>	54800156	<b>0 445 110 614</b>	55192948	<b>0 986 435 083</b>	55206756	<b>0 281 002 861</b>
504 0887 55	<b>0 445 110 273</b>	55176442	<b>0 986 435 102</b>	55193048	<b>0 281 002 309</b>	55206757	<b>0 281 002 980</b>
504 0887 55	<b>0 445 117 077</b>	55176443	<b>0 986 435 078</b>	55193049	<b>0 280 218 054</b>	55206758	<b>0 281 002 860</b>
504 0887 55	<b>0 986 435 165</b>	55183650	<b>0 281 002 792</b>	55193049	<b>0 986 280 238</b>	552 0675 90	<b>0 281 002 917</b>
504095664	<b>0 445 020 046</b>	55183651	<b>0 281 002 683</b>	55193731	<b>0 445 010 097</b>	55207200	<b>0 445 010 173</b>
504095664	<b>0 986 437 321</b>	55184535	<b>0 445 110 112</b>	55193731	<b>0 986 437 025</b>	55207676	<b>0 445 010 166</b>
504 0973 32	<b>0 445 010 137</b>	55184536	<b>0 445 110 083</b>	55193808	<b>0 445 110 111</b>	55207676	<b>0 445 010 308</b>
504097332	<b>0 986 437 085</b>	55184536	<b>0 986 435 078</b>	55193808	<b>0 986 435 081</b>	55207676	<b>0 445 010 309</b>
504 1002 87	<b>0 414 700 006</b>	55185333	<b>0 986 435 088</b>	55196294	<b>0 445 110 244</b>	55207676	<b>0 445 010 350</b>
504 1002 87	<b>0 414 700 010</b>	55185339	<b>0 445 010 097</b>	55196294	<b>0 986 435 161</b>	55208183	<b>0 445 110 308</b>
504100287	<b>0 986 441 020</b>	55185339	<b>0 986 437 025</b>	55196295	<b>0 445 110 243</b>	55208183	<b>0 986 435 197</b>
504100287	<b>0 986 441 120</b>	55185549	<b>0 445 010 277</b>	55196385	<b>0 280 218 182</b>	55208726	<b>0 280 218 237</b>
504 1710 01	<b>0 460 426 449</b>	55185549	<b>0 986 437 024</b>	55196442	<b>0 445 110 300</b>	55209062	<b>0 445 010 185</b>
504 1735 49	<b>0 460 424 392</b>	55185549	<b>0 986 437 201</b>	55196442	<b>0 986 435 171</b>	55209062	<b>0 445 010 305</b>
504188076	<b>0 445 020 093</b>	55185577	<b>0 445 110 165</b>	55197124	<b>0 445 110 183</b>	55209062	<b>0 986 437 094</b>
504188076	<b>0 986 437 389</b>	55187290	<b>0 445 110 119</b>	55197124	<b>0 986 435 102</b>	55209063	<b>0 445 010 184</b>
504 1944 32	<b>0 445 120 092</b>	55187290	<b>0 986 435 083</b>	55197875	<b>0 445 110 183</b>	55209063	<b>0 445 010 365</b>
504194432	<b>0 986 435 551</b>	55187291	<b>0 445 110 119</b>	55198208	<b>0 986 437 036</b>	55209382	<b>0 445 110 299</b>
504 2080 96	<b>0 460 414 265</b>	55187291	<b>0 986 435 083</b>	55198217	<b>0 445 110 244</b>	55209382	<b>0 986 435 230</b>
504 2188 23	<b>0 460 424 418</b>	55187718	<b>0 281 002 549</b>	55198217	<b>0 986 435 161</b>	55209803	<b>0 445 110 322</b>
504 2188 24	<b>0 460 424 422</b>	55187722	<b>0 986 280 241</b>	55198218	<b>0 445 110 243</b>	55212707	<b>0 445 010 173</b>
504 2188 27	<b>0 460 424 421</b>	55189276	<b>0 445 110 019</b>	55198218	<b>0 445 110 391</b>	552127070	<b>0 445 010 233</b>
504 2194 02	<b>0 460 424 425</b>	55189276	<b>0 986 435 006</b>	55198218	<b>0 986 435 104</b>	55214159	<b>0 445 110 326</b>
504 2463 16	<b>0 460 424 420</b>	55190587	<b>0 281 002 763</b>	55198218	<b>0 986 435 208</b>	55214192	<b>0 445 110 322</b>
504 2543 90	<b>0 432 133 761</b>	55190587	<b>0 281 002 764</b>	551 9821 80	<b>0 445 110 243</b>	55216288	<b>0 445 010 278</b>
504255185	<b>0 445 120 157</b>	55190587	<b>0 281 006 048</b>	55198219	<b>0 445 110 213</b>	55216288	<b>0 986 437 024</b>
504255185	<b>0 986 435 564</b>	551905878	<b>0 281 002 764</b>	55198219	<b>0 986 435 162</b>	55216288	<b>0 986 437 201</b>
504 2556 37	<b>0 460 424 419</b>	55190808	<b>0 445 110 111</b>	55198519	<b>0 445 010 123</b>	55217235	<b>0 445 110 213</b>
504 2556 37	<b>0 460 424 420</b>	55191957	<b>0 445 110 165</b>	55198519	<b>0 445 010 285</b>	55217235	<b>0 986 435 162</b>
504 2870 69	<b>0 414 703 004</b>	55191958	<b>0 445 110 159</b>	55198519	<b>0 445 010 349</b>	55217826	<b>0 445 010 422</b>
50428707	<b>0 414 703 008</b>	55191958	<b>0 986 435 088</b>	55198522	<b>0 445 010 150</b>	55218067	<b>0 445 110 341</b>
504 2870 71	<b>0 414 703 010</b>	55191959	<b>0 445 110 187</b>	55198522	<b>0 445 010 286</b>	55218785	<b>0 445 110 341</b>

55219886	<b>0 445 110 351</b>	55246508	<b>0 445 010 424</b>	60589472	<b>0 280 217 503</b>	71793290	<b>0 986 435 162</b>
55219886	<b>0 986 435 204</b>	55246508	<b>0 445 010 466</b>	60604589	<b>0 432 217 249</b>	71793564	<b>0 986 435 081</b>
55220380	<b>0 280 218 242</b>	55246508	<b>0 986 437 095</b>	60616998	<b>0 460 404 991</b>	71794071	<b>0 986 435 078</b>
55221017	<b>0 445 110 276</b>	55253490	<b>0 445 010 414</b>	60663029	<b>0 280 218 036</b>	71794088	<b>0 986 435 099</b>
55221017	<b>0 986 435 148</b>	55254728	<b>0 445 110 680</b>	60663029	<b>0 986 280 237</b>	71794089	<b>0 986 435 104</b>
55221018	<b>0 445 110 187</b>	55254750	<b>0 445 010 424</b>	60755046	<b>0 280 200 001</b>	71794167	<b>0 986 435 148</b>
55221018	<b>0 986 435 099</b>	55254750	<b>0 445 010 466</b>	60802028	<b>0 280 218 113</b>	71794168	<b>0 986 435 162</b>
552 2101 80	<b>0 986 435 099</b>	55254750	<b>0 986 437 095</b>	60802028	<b>0 986 280 239</b>	71794966	<b>0 445 110 183</b>
55221019	<b>0 445 110 341</b>	55255406	<b>0 445 110 614</b>	6080915	<b>0 280 202 212</b>	71795021	<b>0 986 435 213</b>
55221020	<b>0 445 110 243</b>	55255406	<b>0 986 435 249</b>	60810813	<b>0 280 217 111</b>	71795163	<b>0 445 110 419</b>
55221020	<b>0 445 110 391</b>	55255416	<b>0 445 010 425</b>	6081145	<b>0 280 217 514</b>	71795164	<b>0 986 435 213</b>
55221020	<b>0 986 435 104</b>	55255416	<b>0 986 437 097</b>	60814750	<b>0 445 010 007</b>	73501003	<b>0 445 010 072</b>
55221020	<b>0 986 435 208</b>	55256104	<b>0 445 010 438</b>	60814750	<b>0 986 437 002</b>	73501013	<b>0 445 010 071</b>
55221021	<b>0 445 110 213</b>	55260836	<b>0 445 110 673</b>	60814852	<b>0 280 218 019</b>	73501139	<b>0 445 110 119</b>
55221021	<b>0 986 435 162</b>	55260837	<b>0 445 010 737</b>	60814852	<b>0 986 280 236</b>	73501139	<b>0 986 435 083</b>
55221022	<b>0 445 110 308</b>	55260837	<b>0 445 110 673</b>	60814977	<b>0 445 010 006</b>	73501140	<b>0 445 110 119</b>
55221022	<b>0 986 435 197</b>	55262755	<b>0 445 110 680</b>	60815616	<b>0 280 217 531</b>	73501140	<b>0 986 435 083</b>
55221023	<b>0 445 110 300</b>	55263233	<b>0 445 110 682</b>	60815616	<b>0 986 280 233</b>	73503097	<b>0 445 110 111</b>
55221023	<b>0 986 435 171</b>	55263233	<b>0 986 435 289</b>	60816137	<b>0 281 002 309</b>	73503097	<b>0 986 435 081</b>
55221024	<b>0 445 110 299</b>	55263525	<b>0 445 010 455</b>	60816392	<b>0 445 110 068</b>	75208927	<b>0 432 191 812</b>
55221024	<b>0 986 435 230</b>	55267246	<b>0 445 010 466</b>	60816448	<b>0 281 002 308</b>	75285539	<b>9 430 082 289</b>
55221909	<b>0 445 010 276</b>	55267246	<b>0 986 437 095</b>	60816615	<b>0 445 010 007</b>	75288114	<b>9 430 082 747</b>
55222114	<b>0 445 010 071</b>	55268335	<b>0 445 010 463</b>	60816616	<b>0 445 010 006</b>	7553412	<b>0 280 202 081</b>
55230348	<b>0 445 010 292</b>	55272459	<b>0 445 010 737</b>	60816693	<b>0 280 218 054</b>	7555128	<b>0 280 200 051</b>
55230478	<b>0 445 010 184</b>	55274521	<b>0 445 010 463</b>	60816693	<b>0 986 280 238</b>	7612319	<b>0 280 202 115</b>
55230478	<b>0 445 010 241</b>	55274694	<b>0 445 010 466</b>	689002	<b>0 432 131 676</b>	7612320	<b>0 986 280 115</b>
55230478	<b>0 445 010 291</b>	55274845	<b>0 445 010 747</b>	71723576	<b>0 986 437 023</b>	76296610	<b>0 460 484 023</b>
552315720	<b>0 445 010 381</b>	55275355	<b>0 445 110 897</b>	71724116	<b>0 986 435 001</b>	76343760	<b>0 432 217 195</b>
552315720	<b>0 986 437 072</b>	55275621	<b>0 445 110 813</b>	717 3599 80	<b>0 281 002 184</b>	7643209	<b>0 432 217 195</b>
552 3395 5	<b>0 445 110 419</b>	55285011	<b>0 445 010 798</b>	71787951	<b>0 986 280 239</b>	7648065	<b>0 986 280 114</b>
55233955	<b>0 986 435 213</b>	55350048	<b>0 281 002 683</b>	71787959	<b>0 986 280 238</b>	7662850	<b>0 432 217 273</b>
55234362	<b>0 445 010 302</b>	55567369	<b>0 445 010 293</b>	71788000	<b>0 986 280 233</b>	76628500	<b>0 432 217 211</b>
55234362	<b>0 445 010 305</b>	55567369	<b>0 986 437 036</b>	71788004	<b>0 986 280 236</b>	7706073	<b>0 280 202 128</b>
55234362	<b>0 986 437 094</b>	5801382396	<b>0 445 020 175</b>	71788020	<b>0 986 280 234</b>	7711878	<b>0 280 212 024</b>
55234363	<b>0 445 010 349</b>	5801382396	<b>0 986 437 341</b>	71788023	<b>0 986 280 235</b>	77118780	<b>0 986 280 123</b>
55234364	<b>0 445 010 308</b>	5801386698	<b>0 445 010 319</b>	71788026	<b>0 986 280 237</b>	771354	<b>0 432 297 034</b>
55234364	<b>0 445 010 309</b>	5801386698	<b>0 445 010 320</b>	71788743	<b>0 986 280 241</b>	7735577	<b>0 460 484 051</b>
55234365	<b>0 445 010 233</b>	5801386698	<b>0 986 437 096</b>	71791192	<b>0 986 430 525</b>	77367803	<b>F 01C 600 249</b>
55236707	<b>0 445 010 265</b>	5801439052	<b>0 445 010 318</b>	71791219	<b>0 986 435 501</b>	7763718	<b>0 280 217 106</b>
55236707	<b>0 445 010 425</b>	5801439052	<b>0 986 437 085</b>	71791222	<b>0 986 435 501</b>	7767750	<b>0 281 002 185</b>
55236707	<b>0 986 437 097</b>	5801453888	<b>0 445 124 015</b>	71791252	<b>0 986 435 006</b>	7778146	<b>0 432 217 274</b>
55237687	<b>0 445 010 308</b>	5801453888	<b>0 986 435 663</b>	71791255	<b>0 986 435 078</b>	7778146	<b>0 986 430 525</b>
55237687	<b>0 445 010 309</b>	5801467085	<b>0 445 020 185</b>	71791264	<b>0 986 435 081</b>	7778147	<b>0 432 217 273</b>
55237688	<b>0 445 010 304</b>	5801486599	<b>0 445 020 195</b>	71791267	<b>0 986 435 083</b>	7778470	<b>0 432 217 273</b>
55237688	<b>0 445 010 305</b>	5801486599	<b>0 986 437 512</b>	71791273	<b>0 986 435 077</b>	80530150	<b>0 445 120 279</b>
55237688	<b>0 986 437 094</b>	5801527580	<b>0 445 010 401</b>	71791439	<b>0 986 435 083</b>	8122175	<b>0 432 291 753</b>
55237689	<b>0 445 010 466</b>	5801692383	<b>0 445 124 027</b>	71791442	<b>0 986 435 083</b>	8122175	<b>0 986 430 067</b>
55237689	<b>0 986 437 095</b>	5801769057	<b>0 445 124 030</b>	71792979	<b>0 986 435 104</b>	8122176	<b>0 432 291 752</b>
55237690	<b>0 445 010 310</b>	5801772746	<b>0 445 020 257</b>	71792982	<b>0 986 435 161</b>	84300595	<b>0 460 423 055</b>
55237690	<b>0 986 437 038</b>	5801800277	<b>0 445 020 257</b>	71792985	<b>0 986 435 162</b>	84300598	<b>0 460 423 054</b>
55243307	<b>0 445 010 414</b>	5801940312	<b>0 445 010 465</b>	71792997	<b>0 986 435 148</b>	84534252	<b>F 002 C7Z 397</b>
55245044	<b>0 445 010 425</b>	580540211	<b>0 445 116 059</b>	71793006	<b>0 986 435 165</b>	93178675	<b>0 445 010 097</b>
55245044	<b>0 986 437 097</b>	60534838	<b>0 280 202 105</b>	71793015	<b>0 986 435 163</b>	93178675	<b>0 986 437 025</b>
55246223	<b>0 445 110 524</b>	60579400	<b>0 280 202 212</b>	71793237	<b>0 986 435 099</b>	9456182380	<b>0 986 435 003</b>
55246223	<b>0 986 435 280</b>	60588419	<b>0 280 217 106</b>	71793240	<b>0 986 435 102</b>	9456182480	<b>0 445 110 044</b>



CV8Q 9F593 AA	<b>0 986 435 288</b>
DC46 5H297 AA	<b>0 444 022 021</b>
DC46 5H298 AA	<b>0 444 023 058</b>
DC46 5H298 AB	<b>0 444 023 058</b>
EB3G-5J281-AA	<b>0 444 021 056</b>

ED E5EF 12B529 BA	<b>0 280 202 121</b>
E4HN 9F593 BB	<b>9 430 082 708</b>
E4HN 9F593 CA	<b>9 430 082 713</b>
E5HN 9F593 BA	<b>9 430 082 711</b>
E5ZF 121B529 AA	<b>0 280 202 071</b>

E6HN 9F593 CA	<b>9 430 082 718</b>
E6HN 9F593 DA	<b>9 430 082 717</b>
E7HN 9F593 BA	<b>9 430 082 719</b>
E7SF 12B529 AA	<b>0 280 203 030</b>
E8HN 9F593 AA	<b>9 430 082 722</b>

E9HN 9F593 EB	<b>9 430 082 735</b>
FC3Q 9B395 AA	<b>0 445 010 810</b>
FC3Q 9B395 AA	<b>0 986 437 441</b>
FC3Q 9K546 AA	<b>0 445 117 043</b>
FC3Q 9K546 AA	<b>0 986 435 433</b>

FC3Z 9A543 A	<b>0 445 010 810</b>
FC3Z 9A543 A	<b>0 986 437 441</b>
FC3Z9H529A	<b>0 445 117 043</b>
FC3Z9H529A	<b>0 986 435 433</b>
FC3Z9H529B	<b>0 445 117 043</b>

FC3Z9H529B	<b>0 986 435 433</b>
FM5Q 9A543 AA	<b>0 445 010 591</b>
FM5Q 9A543 AA	<b>0 986 437 446</b>
FW93 9B395 AA	<b>0 445 010 697</b>
FOHN 9F593 AA	<b>9 430 082 741</b>

FOHN 9F593 BA	<b>9 430 082 742</b>
F2NN 9F593 AB	<b>0 432 191 688</b>
F2NN 9F593 BB	<b>0 432 191 687</b>
GC46 5H297 AA	<b>0 444 042 117</b>
GC46 5J281 AA	<b>0 444 043 105</b>

GC469F593BB	<b>0 445 124 033</b>
G4D3 9B395 AA	<b>0 445 010 705</b>
G4D3 9B395 AA	<b>0 986 437 462</b>
G4D3 9B395 AB	<b>0 986 437 462</b>
G4D3 9K546 AA	<b>0 445 110 653</b>

G4D3 9K546 CA	<b>0 445 110 663</b>
JC469F593AA	<b>0 445 124 053</b>
JL3Q 9K546 AB	<b>0 445 117 077</b>
JL3Z 9A543 A	<b>0 445 010 846</b>
JL3Z 9A543 A	<b>0 986 437 466</b>

JU5A-5L229-AB	<b>F 01C 250 166</b>
JX6Q-9A543-AA	<b>0 445 010 780</b>
JX6Q-9F593-AA	<b>0 445 110 749</b>
KV6Q-9A543-AA	<b>0 445 011 501</b>
KV61-5J281-AA	<b>0 444 025 066</b>

RMXM21 9A543 AA	<b>0 986 441 553</b>
RMXS4Q 9A543 SC	<b>0 986 444 519</b>
RMXS4Q 9A543 SE	<b>0 986 444 519</b>
RMYC1Q 9A543 SC	<b>0 986 444 522</b>
RMYC1Q 9A543 SC	<b>0 986 444 523</b>

RMYC1Q 9A543 SF	<b>0 986 444 522</b>
RMYC1Q 9A543 SF	<b>0 986 444 523</b>
RMYM21 9A543 AA	<b>0 414 720 088</b>
RMYS6Q 9A543 SG	<b>0 986 444 521</b>
RM1S7Q 9A543 SH	<b>0 986 444 520</b>

RM1S7Q 9K546 AD	<b>0 432 133 801</b>
RM1S7Q 9K546 BD	<b>0 432 133 800</b>
RM2C46 9F593 AA	<b>0 986 435 625</b>
RM3M5Q 9A543 DE	<b>0 986 437 028</b>
RM3M5Q 9F593 HD	<b>0 986 435 122</b>

RM3M5Q 9F593 JA	<b>0 986 435 090</b>
RM6C46 9F593 BB	<b>0 986 435 626</b>
RM95VW12B529BB	<b>0 280 217 121</b>
RM95VW12B529BB	<b>0 281 002 757</b>
RM95VW12B529BB	<b>0 986 284 010</b>

RM95VW12B529BC	<b>0 280 217 121</b>
RM95VW12B529BC	<b>0 281 002 757</b>
RM95VW12B529BC	<b>0 986 284 010</b>
RM95VW 9A543 CA	<b>0 986 440 567</b>
RM95VW 9A543 DA	<b>0 986 440 555</b>

RM95VW 9F593 DA	<b>0 432 193 746</b>
RM96FF 9A543 AD	<b>0 986 440 226</b>
RM96FF 9A543 BD	<b>0 986 440 225</b>
RM964F 9A543 AC	<b>0 986 440 056</b>
RM964F 9A543 BC	<b>0 986 440 219</b>

RM974F 9A543 AE	<b>0 986 440 217</b>
RM974F 9A543 BE	<b>0 986 440 054</b>
RM974F 9A543 EE	<b>0 986 440 052</b>
RM974F 9A543 FE	<b>0 986 440 053</b>
RV94DD 9F593 AA	<b>0 986 430 249</b>

RV94DD 9F593 BA	<b>0 432 217 249</b>
R84FF 9F593 AC	<b>0 986 430 026</b>
R89FF 9F593 BB	<b>0 986 430 208</b>
R924F 9A543 DA	<b>0 986 440 035</b>
R95VW 9F593 BA	<b>0 432 193 838</b>

R95VW 9F593 CA	<b>0 432 193 829</b>
R954F 9A543 AC	<b>0 986 440 040</b>
R954F 9A543 AD	<b>0 986 440 046</b>
R954F 9A543 AE	<b>0 986 440 055</b>
R954F 9A543 DB	<b>0 986 440 043</b>

R954F 9A543 DC	<b>0 986 440 048</b>
R96FF 9A543 BC	<b>0 986 440 107</b>
TAF 130201	<b>9 430 082 745</b>
TF3 130201	<b>9 430 082 753</b>
TJG 130201	<b>0 432 191 812</b>

TNN 130105	<b>0 460 424 088</b>
TRA 130201	<b>0 432 191 812</b>
T12 130201	<b>9 430 082 289</b>
V94DD 9F593 AA	<b>0 432 217 222</b>
V94DD 9F593 AA	<b>0 986 430 249</b>

V94DD 9F593 BA	<b>0 432 217 249</b>
V97GB 12B579 AA	<b>0 281 002 164</b>
WE0113800	<b>0 445 010 107</b>
WE0113800	<b>0 986 437 385</b>
WLAA13H50	<b>0 445 110 250</b>

WLAA-13800	<b>0 445 010 213</b>
XF 12B529 A	<b>0 280 202 077</b>
XM219 A543 AA	<b>0 414 720 014</b>
XM219 A543 AB	<b>0 414 720 086</b>
XM219 A543 AB	<b>0 986 441 553</b>

XS3Q 9A543 NK	<b>0 986 444 519</b>
XS4Q 9A543 NG	<b>0 986 444 519</b>
XS4Q 9A543 NH	<b>0 986 444 519</b>
XS4Q 9A543 NJ	<b>0 986 444 519</b>
XS4Q 9A543 NL	<b>0 986 444 519</b>

XS4Q 9A543 SA	<b>0 986 444 519</b>
XS4Q 9A543 SB	<b>0 986 444 519</b>
XS4Q 9A543 SC	<b>0 986 444 519</b>
XS4Q 9A543 SD	<b>0 986 444 519</b>
XS4Q 9A543 SE	<b>0 986 444 519</b>

XS4Q 9A543 SF	<b>0 986 444 519</b>
YC1Q 9A543 DA	<b>0 986 444 078</b>
YC1Q 9A543 DB	<b>0 986 444 078</b>
YC1Q 9A543 DC	<b>0 986 444 078</b>
YC1Q 9A543 DD	<b>0 986 444 078</b>

YC1Q 9A543 DE	<b>0 986 444 078</b>
YC1Q 9A543 DF	<b>0 986 444 076</b>
YC1Q 9A543 EA	<b>0 986 444 522</b>
YC1Q 9A543 EA	<b>0 986 444 523</b>
YC1Q 9A543 EB	<b>0 986 444 522</b>

YC1Q 9A543 EB	<b>0 986 444 523</b>
YC1Q 9A543 EC	<b>0 986 444 522</b>
YC1Q 9A543 EC	<b>0 986 444 523</b>
YC1Q 9A543 ED	<b>0 986 444 522</b>
YC1Q 9A543 ED	<b>0 986 444 523</b>

YC1Q 9A543 EE	<b>0 986 444 522</b>
YC1Q 9A543 EE	<b>0 986 444 523</b>
YC1Q 9A543 SA	<b>0 986 444 522</b>
YC1Q 9A543 SA	<b>0 986 444 523</b>
YC1Q 9A543 SB	<b>0 986 444 522</b>

YC1Q 9A543 SB	<b>0 986 444 523</b>
YC1Q 9A543 SC	<b>0 986 444 522</b>
YC1Q 9A543 SC	<b>0 986 444 523</b>
YC1Q 9A543 SD	<b>0 986 444 522</b>
YC1Q 9A543 SD	<b>0 986 444 523</b>

YC1Q 9A543 SE	<b>0 986 444 522</b>
YC1Q 9A543 SE	<b>0 986 444 523</b>
YC1Q 9A543 TA	<b>0 986 444 078</b>
YC1Q 9A543 TB	<b>0 986 444 078</b>
YC1Q 9A543 TC	<b>0 986 444 078</b>

YC1Q 9A543 TD	<b>0 986 444 078</b>
YC1Q 9A543 TE	<b>0 986 444 078</b>
YC1Q 9A543 TF	<b>0 986 444 076</b>
YM211 2B529 BA	<b>0 280 218 017</b>
YM219 A543 BA	<b>0 414 720 029</b>

YM219 A543 BA	<b>0 414 720 088</b>
YM219 A543 BA	<b>0 986 441 554</b>
YM219 A543 BB	<b>0 414 720 088</b>
YM219 A543 BB	<b>0 986 441 554</b>
YS6Q 9A543 RA	<b>0 986 444 521</b>

YS6Q 9A543 RB	<b>0 986 444 521</b>
YS6Q 9A543 RC	<b>0 986 444 521</b>
YS6Q 9A543 RD	<b>0 986 444 521</b>
YS6Q 9A543 RE	<b>0 986 444 521</b>
YS6Q 9A543 RF	<b>0 986 444 521</b>

YS6Q 9A543 RG	<b>0 986 444 521</b>
YS6Q 9A543 SA	<b>0 986 444 521</b>
YS6Q 9A543 SB	<b>0 986 444 521</b>
YS6Q 9A543 SC	<b>0 986 444 521</b>
YS6Q 9A543 SD	<b>0 986 444 521</b>

YS6Q 9A543 SE	<b>0 986 444 521</b>
YS6Q 9A543 SF	<b>0 986 444 521</b>
YS6Q 9A543 SG	<b>0 986 444 521</b>
0539 06301 1	<b>0 280 202 126</b>
0539 06301 4	<b>0 280 202 136</b>

1C1Q9 A543 AB	<b>0 460 414 216</b>
1C1Q9 A543 AC	<b>0 460 414 216</b>
1C1Q9 A543 BB	<b>0 460 414 215</b>
1C1Q9 A543 CA	<b>0 460 414 218</b>
1C1Q9 A543 DA	<b>0 460 414 219</b>

1S7Q9 A543 AA	<b>0 986 444 079</b>
1S7Q9 A543 AB	<b>0 986 444 079</b>
1S7Q9 A543 AC	<b>0 986 444 079</b>
1S7Q9 A543 AD	<b>0 986 444 079</b>
1S7Q9 A543 AE	<b>0 986 444 075</b>

1S7Q9 A543 AF	<b>0 986 444 075</b>
1S7Q9 A543 BB	<b>0 986 444 520</b>
1S7Q9 A543 BC	<b>0 986 444 520</b>
1S7Q9 A543 BD	<b>0 986 444 520</b>
1S7Q9 A543 BE	<b>0 986 444 520</b>

1S7Q9 A543 BF	<b>0 986 444 520</b>
1S7Q9 A543 BG	<b>0 986 444 520</b>
1S7Q9 A543 BH	<b>0 986 444 520</b>
1S7Q9 A543 BJ	<b>0 986 444 520</b>
1S7Q9 A543 BK	<b>0 986 444 520</b>

1S7Q9 A543 SB	<b>0 986 444 520</b>
1S7Q9 A543 SC	<b>0 986 444 520</b>
1S7Q9 A543 SD	<b>0 986 444 520</b>
1S7Q9 A543 SE	<b>0 986 444 520</b>
1S7Q9 A543 SF	<b>0 986 444 520</b>

1S7Q9 A543 SG	<b>0 986 444 520</b>
1S7Q9 A543 SH	<b>0 986 444 520</b>
1S7Q9 A543 TA	<b>0 986 444 079</b>
1S7Q9 A543 TD	<b>0 470 504 036</b>
1S7Q9 A543 TD	<b>0 986 444 075</b>

1S7Q9 A543 TE	<b>0 470 504 036</b>
1S7Q9 A543 TE	<b>0 986 444 075</b>
1S7Q9 K546 AB	<b>0 432 133 801</b>
1S7Q9 K546 AC	<b>0 432 133 801</b>
1S7Q9 K546 AD	<b>0 432 133 801</b>

1S7Q9 K546 BB	<b>0 432 133 800</b>
1S7Q9 K546 BC	<b>0 432 133 800</b>
1S7Q9 K546 BD	<b>0 432 133 800</b>
1S7Q9 K546 BE	<b>0 432 133 800</b>
1S7Q9 K564 AA	<b>0 432 133 801</b>





◀ FORD

1S7Q9 K564 AC	<b>0 432 133 801</b>
1S7Q9 K564 BA	<b>0 432 133 800</b>
1S7Q9 K564 BC	<b>0 432 133 800</b>
1003090	<b>0 432 193 829</b>
1003759	<b>0 280 217 512</b>
1005830	<b>0 432 217 293</b>
1010441	<b>0 432 193 838</b>
1010442	<b>0 432 193 829</b>
1011035	<b>0 986 440 040</b>
1011037	<b>0 986 440 046</b>
1011039	<b>0 986 440 046</b>
1011042	<b>0 986 440 043</b>
1011044	<b>0 986 440 048</b>
1011048	<b>0 986 440 048</b>
1011059	<b>0 432 217 249</b>
1027140	<b>0 460 404 971</b>
1027140	<b>0 986 440 555</b>
1030438	<b>0 986 440 567</b>
1030582	<b>0 432 193 746</b>
1041359	<b>0 281 002 164</b>
1047197	<b>0 432 217 293</b>
1049608	<b>0 986 440 056</b>
1049609	<b>0 986 440 219</b>
1051396	<b>0 280 217 121</b>
1051396	<b>0 281 002 757</b>
1051396	<b>0 986 280 202</b>
1051396	<b>0 986 284 010</b>
1066353	<b>0 986 440 107</b>
1072298	<b>0 460 404 971</b>
1072298	<b>0 986 440 555</b>
1077607	<b>0 986 440 217</b>
1077608	<b>0 986 440 052</b>
1077609	<b>0 986 440 054</b>
1077610	<b>0 986 440 053</b>
1093872	<b>0 986 444 519</b>
1100801	<b>0 986 440 567</b>
1100802	<b>0 986 440 555</b>
1100984	<b>0 414 720 014</b>
1104228	<b>0 986 444 522</b>
1104228	<b>0 986 444 523</b>
1104229	<b>0 986 444 078</b>
1105530	<b>0 460 484 150</b>
1105530	<b>0 986 440 225</b>
1105531	<b>0 460 484 152</b>
1105531	<b>0 986 440 226</b>
1111908	<b>0 986 444 521</b>
1112131	<b>0 280 218 017</b>
1127405	<b>0 986 440 219</b>
1127406	<b>0 986 440 054</b>
1127407	<b>0 986 440 055</b>
1127456	<b>0 986 440 056</b>
1127470	<b>0 986 440 217</b>
1127478	<b>0 986 440 052</b>
1128170	<b>0 432 133 800</b>
1128172	<b>0 432 133 801</b>

1128394	<b>0 986 440 053</b>
1129660	<b>0 986 444 520</b>
1129661	<b>0 986 444 079</b>
1130379	<b>0 986 444 522</b>
1130379	<b>0 986 444 523</b>
1131699	<b>0 986 444 079</b>
1131701	<b>0 432 133 800</b>
1131702	<b>0 432 133 801</b>
1131855	<b>0 414 720 088</b>
1131855	<b>0 986 441 554</b>
1131971	<b>0 986 441 553</b>
1131973	<b>0 986 444 519</b>
1131977	<b>0 414 720 088</b>
1131977	<b>0 986 441 554</b>
1131978	<b>0 986 444 521</b>
1131980	<b>0 986 444 520</b>
1131982	<b>0 986 440 226</b>
1131983	<b>0 986 440 107</b>
1131984	<b>0 986 440 225</b>
1139871	<b>0 986 444 521</b>
1141377	<b>0 460 414 216</b>
1151423	<b>0 986 444 519</b>
1151425	<b>0 470 504 036</b>
1206303	<b>0 414 720 088</b>
1206303	<b>0 986 441 554</b>
1206322	<b>0 414 720 086</b>
1206322	<b>0 986 441 553</b>
1209109	<b>0 281 002 461</b>
1209171	<b>0 986 444 522</b>
1209171	<b>0 986 444 523</b>
1213937	<b>0 986 444 522</b>
1213937	<b>0 986 444 523</b>
1214221	<b>0 986 444 521</b>
1219313	<b>0 470 504 036</b>
1219313	<b>0 986 444 075</b>
1223521	<b>0 280 218 104</b>
1223678	<b>0 432 133 800</b>
1226232	<b>0 986 444 520</b>
1227039	<b>0 986 444 078</b>
1229572	<b>0 986 444 519</b>
1230996	<b>0 445 010 089</b>
1230996	<b>0 986 437 322</b>
1253765	<b>0 414 720 266</b>
1253765	<b>0 986 441 560</b>
1254398	<b>0 445 110 136</b>
1254398	<b>0 986 435 090</b>
1255376	<b>0 986 444 522</b>
1255376	<b>0 986 444 523</b>
1255378	<b>0 986 444 520</b>
1302192	<b>0 986 444 078</b>
1306485	<b>0 986 444 521</b>
1313844	<b>0 445 010 089</b>
1313844	<b>0 986 437 322</b>
1314310	<b>0 986 444 075</b>
1319288	<b>0 986 444 076</b>

1326820	<b>0 445 110 188</b>
1326820	<b>0 986 435 090</b>
1336633	<b>0 986 444 519</b>
1338377	<b>0 986 444 078</b>
1344951	<b>0 280 217 121</b>
1344951	<b>0 281 002 757</b>
1344951	<b>0 986 284 010</b>
1347282	<b>0 445 010 296</b>
1347283	<b>0 445 110 239</b>
1347283	<b>0 986 435 122</b>
1347778	<b>0 986 444 076</b>
1353014	<b>0 986 444 521</b>
1353015	<b>0 986 444 520</b>
1353439	<b>0 986 444 522</b>
1353439	<b>0 986 444 523</b>
1357621	<b>0 432 133 768</b>
1366613	<b>0 445 110 188</b>
1366613	<b>0 986 435 090</b>
1367827	<b>0 280 218 134</b>
1376261	<b>0 445 010 296</b>
1384275	<b>0 280 217 121</b>
1384275	<b>0 281 002 757</b>
1384275	<b>0 986 280 202</b>
1384275	<b>0 986 284 010</b>
1425514	<b>0 445 110 259</b>
1425514	<b>0 986 435 126</b>
1428448	<b>0 280 217 121</b>
1428448	<b>0 281 002 757</b>
1428448	<b>0 986 280 202</b>
1428448	<b>0 986 284 010</b>
1431650	<b>0 986 441 560</b>
1445695	<b>0 445 110 285</b>
1477146	<b>0 445 110 239</b>
1477146	<b>0 986 435 122</b>
1490844	<b>0 445 010 296</b>
1490844	<b>0 986 437 028</b>
1492204	<b>0 445 010 367</b>
1492204	<b>0 986 437 034</b>
1496269	<b>0 445 010 296</b>
1496269	<b>0 986 437 028</b>
1509239	<b>0 445 115 025</b>
1509239	<b>0 445 115 092</b>
1509239	<b>0 986 435 450</b>
1538758	<b>0 445 110 183</b>
1539539	<b>0 445 010 276</b>
1539539	<b>0 986 437 023</b>
1542478	<b>0 281 002 980</b>
1566173	<b>0 280 218 250</b>
1566426	<b>0 986 437 028</b>
1566431	<b>0 986 435 122</b>
1566432	<b>0 986 435 090</b>
1633633	<b>0 445 110 352</b>
1633633	<b>0 986 435 233</b>
1696606	<b>0 445 010 552</b>
1696606	<b>0 986 437 430</b>

1696927	<b>0 445 110 340</b>
1696927	<b>0 986 435 203</b>
1700694	<b>0 986 435 392</b>
1700694	<b>0 986 435 434</b>
1723813	<b>0 445 110 351</b>
1723813	<b>0 986 435 204</b>
1742498	<b>0 445 010 310</b>
1742498	<b>0 986 437 038</b>
1742911	<b>0 445 010 564</b>
1742911	<b>0 986 437 448</b>
1745052	<b>0 445 110 488</b>
1745052	<b>0 986 435 288</b>
1746390	<b>0 445 010 569</b>
1746390	<b>0 986 437 459</b>
1755941	<b>0 445 010 571</b>
1755941	<b>0 986 437 460</b>
1761389	<b>0 445 010 548</b>
1761389	<b>0 986 437 448</b>
1780420	<b>0 445 010 265</b>
1780420	<b>0 445 010 425</b>
1780420	<b>0 986 437 097</b>
1784745	<b>0 445 010 576</b>
1784745	<b>0 986 437 449</b>
1843536	<b>0 445 115 088</b>
1869454	<b>0 445 010 591</b>
1869454	<b>0 986 437 446</b>
1902467	<b>0 444 021 056</b>
1926710	<b>0 445 010 569</b>
1926710	<b>0 986 437 459</b>
2C246 9F593 AA	<b>0 445 120 025</b>
2C246 9F593 AA	<b>0 986 435 625</b>
2C469 D376 AA	<b>0 445 020 019</b>
2C469 F593 AA	<b>0 445 120 025</b>
2C469 F593 AA	<b>0 986 435 625</b>
2C469 F5936 AA	<b>0 445 120 025</b>
2C469 F5936 AA	<b>0 986 435 625</b>
2RD 130201	<b>9 430 082 752</b>
2SY 130201	<b>0 432 191 812</b>
2S7A1 2B579 CA	<b>0 280 218 104</b>
2191059	<b>0 445 010 780</b>
2191087	<b>0 445 110 749</b>
2200161	<b>0 445 010 846</b>
2200161	<b>0 986 437 466</b>
27 906301	<b>0 280 202 140</b>
3M211 2B529 AA	<b>0 281 002 461</b>
3M219 A543 AA	<b>0 414 720 266</b>
3M219 A543 AA	<b>0 986 441 560</b>
3M5Q9 A543 AA	<b>0 445 010 089</b>
3M5Q9 A543 AA	<b>0 986 437 322</b>
3M5Q9 A543 AB	<b>0 445 010 089</b>
3M5Q9 A543 AB	<b>0 986 437 322</b>
3M5Q9 A543 DB	<b>0 445 010 296</b>
3M5Q9 A543 DC	<b>0 445 010 296</b>
3M5Q9 A543 DD	<b>0 445 010 296</b>
3M5Q9 A543 DE	<b>0 445 010 296</b>



3M5Q9 A593 GA	<b>0 445 110 188</b>
3M5Q9 A593 GA	<b>0 986 435 090</b>
3M5Q9 F593 CA	<b>0 445 110 136</b>
3M5Q9 F593 GA	<b>0 445 110 188</b>
3M5Q9 F593 GA	<b>0 986 435 090</b>

3M5Q9 F593 HB	<b>0 445 110 239</b>
3M5Q9 F593 HB	<b>0 986 435 122</b>
3M5Q9 F593 HD	<b>0 445 110 239</b>
3M5Q9 F593 HD	<b>0 986 435 122</b>
3M5Q9 F593 JA	<b>0 445 110 188</b>

3M5Q9 F593 JA	<b>0 986 435 090</b>
4C109K546AA	<b>0 432 133 769</b>
4C109K546BA	<b>0 432 133 768</b>
4C109 A543 DA	<b>0 460 414 246</b>
4C109 K546 AA	<b>0 432 133 769</b>

4C109 K546 BA	<b>0 432 133 768</b>
4332523	<b>0 460 414 218</b>
4332524	<b>0 460 414 219</b>
5M5Q9 F593 AA	<b>0 445 110 259</b>
5M5Q9 F593 AA	<b>0 986 435 126</b>

5014725	<b>0 986 430 026</b>
5014726	<b>0 986 430 026</b>
5029074	<b>0 986 440 035</b>
5029079	<b>0 986 430 208</b>
5090725	<b>0 432 291 494</b>

5090726	<b>0 432 291 495</b>
55204599	<b>0 445 010 097</b>
55204599	<b>0 986 437 025</b>
6C465 H297 AA	<b>0 444 022 006</b>
6C46 5H297 BD	<b>0 444 022 027</b>

6C46 5H297 BE	<b>0 444 022 027</b>
6C46 5H298 BA	<b>0 444 023 022</b>
6C46 5H298 BB	<b>0 444 023 022</b>
6C46 9D376 AA	<b>0 445 020 079</b>
6C469 F593 AA	<b>0 445 120 116</b>

6C46 9F593 AB	<b>0 445 120 168</b>
6C46 9F593 AC	<b>0 445 120 405</b>
6C46 9F593 A1	<b>0 445 120 116</b>
6C469 F593 BA	<b>0 445 120 135</b>
6C469 F593 BA	<b>0 445 120 500</b>

6C469 F593 BA	<b>0 986 435 626</b>
6C469 F593 BB	<b>0 445 120 135</b>
6C469 F593 BB	<b>0 445 120 500</b>
6C469 F593 BB	<b>0 986 435 626</b>
6G9N9 G760 AA	<b>0 280 218 134</b>

6G9Q9 9A543 AB	<b>0 445 010 367</b>
6G9Q9 9A543 AB	<b>0 986 437 034</b>
6M5Q9 F593 AA	<b>0 445 110 285</b>
6067599	<b>0 432 297 039</b>
6127294	<b>0 280 200 044</b>

6142551	<b>0 280 200 047</b>
6155814	<b>0 986 430 026</b>
6160234	<b>0 280 202 094</b>
6169453	<b>0 986 430 208</b>
6189089	<b>0 986 430 208</b>

6632747	<b>0 986 440 035</b>
7072684	<b>0 432 217 222</b>
7072684	<b>0 986 430 249</b>
7072685	<b>0 432 217 249</b>
7243941	<b>0 986 440 040</b>

7243942	<b>0 986 440 043</b>
8G9Q9 9F593 AA	<b>0 445 115 025</b>
8G9Q9 9F593 AA	<b>0 986 435 450</b>
805F 9K546 AAA	<b>0 432 297 039</b>
83DA 12B529 AA	<b>0 280 202 048</b>

84DA 9H535 AA	<b>0 280 202 077</b>
84FF 9F593 AC	<b>0 986 430 026</b>
85GB 12B529 AA	<b>0 280 200 044</b>
86GB 12B529 AA	<b>0 280 200 047</b>
87GB 12B529 AA	<b>0 280 202 094</b>

87 801 835	<b>0 460 426 307</b>
87 801 836	<b>0 460 426 312</b>
87 801 837	<b>0 460 426 313</b>
87 840 066	<b>0 432 191 641</b>
87 840 068	<b>0 432 191 650</b>

87 840 446	<b>0 432 191 621</b>
89FF 9F593 BA	<b>0 986 430 208</b>
89FF 9F593 BB	<b>0 986 430 208</b>
9M5Q9 9F593 AA	<b>0 445 110 352</b>
9M5Q9 9F593 AA	<b>0 986 435 233</b>

9M51 12B579 AA	<b>0 280 218 250</b>
9S511 2B579 AA	<b>0 281 002 980</b>
9S519 A543 AA	<b>0 445 010 276</b>
9S519 A543 AA	<b>0 986 437 023</b>
9S51 9F593 BA	<b>0 445 110 183</b>

9X2Q9 B395 BA	<b>0 445 010 614</b>
9X2Q9 B395 BA	<b>0 986 437 432</b>
9X2Q9 B395 CA	<b>0 445 010 614</b>
9X2Q9 B395 CA	<b>0 986 437 432</b>
9X2Q9 K546 DA	<b>0 445 116 012</b>

9X2Q9 K546 DA	<b>0 445 116 064</b>
9X2Q9 K546 DA	<b>0 986 435 403</b>
9X2Q9 K546 DB	<b>0 445 116 064</b>
9X2Q9 K546 DB	<b>0 986 435 403</b>
9X2Q9 K546 DC	<b>0 445 116 064</b>

924F9 A543 DA	<b>0 986 440 035</b>
94FF 9F593 BA	<b>0 986 430 304</b>
95VW 12B529 BB	<b>0 280 217 121</b>
95VW 12B529 BB	<b>0 281 002 757</b>
95VW 12B529 BB	<b>0 986 280 202</b>

95VW 12B529 BB	<b>0 986 284 010</b>
95VW 12B529 BC	<b>0 280 217 121</b>
95VW 12B529 BC	<b>0 281 002 757</b>
95VW 12B529 BC	<b>0 986 280 202</b>
95VW 12B529 BC	<b>0 986 284 010</b>

95VW 12B529 DA	<b>0 280 217 504</b>
95VW 12B529 DB	<b>0 280 217 512</b>
95VW 9A543 AA	<b>0 460 404 971</b>
95VW 9A543 AA	<b>0 986 440 555</b>
95VW 9A543 AB	<b>0 460 404 971</b>

95VW 9A543 BA	<b>0 460 404 971</b>
95VW 9A543 BA	<b>0 986 440 555</b>
95VW 9A543 CA	<b>0 986 440 567</b>
95VW 9A543 DA	<b>0 460 404 971</b>
95VW 9A543 DA	<b>0 986 440 555</b>

95VW 9F593 CA	<b>0 432 193 829</b>
95VW 9F593 DA	<b>0 432 193 746</b>
954F9 A543 AA	<b>0 986 440 040</b>
954F9 A543 AB	<b>0 986 440 040</b>
954F9 A543 AC	<b>0 986 440 040</b>

954F9 A543 AD	<b>0 986 440 046</b>
954F9 A543 AE	<b>0 986 440 055</b>
954F9 A543 DA	<b>0 986 440 043</b>
954F9 A543 DB	<b>0 986 440 043</b>
954F9 A543 DC	<b>0 986 440 048</b>

96FF 9A543 AD	<b>0 460 484 152</b>
96FF 9A543 AD	<b>0 986 440 226</b>
96FF 9A543 BD	<b>0 460 484 150</b>
96FF 9A543 BD	<b>0 986 440 225</b>
96FF 9A593 BC	<b>0 986 440 107</b>

96FF 9F593 BB	<b>0 432 217 293</b>
96FF 9F593 BB	<b>0 986 430 520</b>
96FF 9F593 BC	<b>0 432 217 293</b>
96FF 9F593 BC	<b>0 986 430 520</b>
964F9 A543 AC	<b>0 986 440 056</b>

964F9 A543 BC	<b>0 986 440 219</b>
964T9 A543 AA	<b>0 460 414 154</b>
974F9 A543 AE	<b>0 986 440 217</b>
974F9 A543 BA	<b>0 986 440 054</b>
974F9 A543 BB	<b>0 986 440 054</b>

974F9 A543 BD	<b>0 986 440 054</b>
974F9 A543 BE	<b>0 986 440 054</b>
974F9 A543 EA	<b>0 986 440 052</b>
974F9 A543 EB	<b>0 986 440 052</b>
974F9 A543 EC	<b>0 986 440 052</b>

974F9 A543 ED	<b>0 986 440 052</b>
974F9 A543 EE	<b>0 986 440 052</b>
974F9 A543 FA	<b>0 986 440 053</b>
974F9 A543 FB	<b>0 986 440 053</b>
974F9 A543 FD	<b>0 986 440 053</b>

974F9 A543 FE	<b>0 986 440 053</b>
98VW 12B529 BA	<b>0 280 217 117</b>

### FORD NEW HOLLAND

E6HN 9F593 AA	<b>9 430 082 714</b>
F2NN 9F593 AB	<b>0 432 191 688</b>
F2NN 9F593 BB	<b>0 432 191 687</b>

2 853 975	<b>0 460 424 316</b>
2 854 949	<b>0 460 424 275</b>
47 506 932	<b>0 444 043 080</b>
81 876 871	<b>0 432 191 688</b>
84 246 892	<b>0 444 022 021</b>

84 247 021	<b>0 444 023 058</b>
87 801 137	<b>0 460 426 262</b>
87 801 139	<b>0 460 426 266</b>
87 801 140	<b>0 460 426 265</b>
87 801 361	<b>0 460 426 280</b>

87 801 789	<b>0 460 426 303</b>
87 801 835	<b>0 460 426 307</b>
87 801 836	<b>0 460 426 312</b>
87 801 837	<b>0 460 426 313</b>
87 802 091	<b>0 432 191 440</b>

87 802 430	<b>0 432 191 364</b>
87 802 531	<b>0 470 006 001</b>
87 802 531	<b>0 470 006 007</b>
87 802 531	<b>0 986 444 511</b>
87 802 532	<b>0 460 426 344</b>

87 802 533	<b>0 460 426 340</b>
87 802 534	<b>0 460 426 345</b>
87 802 535	<b>0 460 426 343</b>
87 802 536	<b>0 432 191 351</b>
87 802 537	<b>0 432 193 524</b>

87 802 684	<b>0 460 426 361</b>
87 802 909	<b>0 432 193 501</b>
87 802 994	<b>0 432 193 489</b>
87 802 995	<b>0 432 193 488</b>
87 803 276	<b>0 432 191 351</b>

87 803 357	<b>0 470 006 007</b>
87 803 357	<b>0 986 444 511</b>
87 840 066	<b>0 432 191 641</b>
87 840 068	<b>0 432 191 650</b>
87 840 446	<b>0 432 191 621</b>

87 841 116	<b>0 432 191 617</b>
87 841 118	<b>0 432 191 617</b>

### FORSTINGER

E049332000035	<b>0 445 110 445</b>
---------------	----------------------

### FOTON (BEIJING FUTIAN ENVIR.)

E048632000009	<b>0 445 110 366</b>
E049331000173	<b>0 445 025 020</b>

E049331000209	<b>0 445 025 027</b>
E0493320000065	<b>0 445 110 531</b>
E049332000113	<b>0 445 110 691</b>
J0445110313A7596	<b>0 445 110 313</b>
J5283275A7596	<b>0 445 120 134</b>

L112500000082	<b>0 444 043 200</b>
T832360008	<b>0 445 120 264</b>
5256607	<b>0 445 020 122</b>



**FREIGHTLINER**

R5135154AB	<b>0 445 110 181</b>
R5135154AB	<b>0 986 435 053</b>
0020102551	<b>0 432 191 278</b>
0280746902	<b>0 986 445 103</b>
414703005	<b>0 414 703 005</b>

**FUJI HEAVY INDUSTRIES**

2116320108	<b>9 430 615 035</b>
2286320100	<b>9 430 610 040</b>

2296320100	<b>9 430 612 376</b>
27263 20100	<b>9 430 610 198</b>

**GAZ**

651 111201	<b>0 445 120 325</b>
------------	----------------------

**GB REMANUFACTURING INC**

712-501	<b>0 986 435 503</b>
712-502	<b>0 986 435 505</b>

712-503	<b>0 986 435 519</b>
712-504	<b>0 986 435 518</b>
732-501	<b>0 986 435 504</b>
732-502	<b>0 986 435 502</b>
732-503	<b>0 986 435 521</b>

732-504	<b>0 986 435 520</b>
739-105	<b>F 00E 200 431</b>
739-305	<b>F 00E 200 392</b>

**GMC (GENERAL MOTORS CORP.)**

MC 052 002	<b>0 460 426 279</b>
MC 053 002	<b>F 000 439 002</b>

MV 053 001	<b>0 432 193 565</b>
MW 052 001	<b>0 460 426 331</b>
MW 052 003	<b>0 460 426 329</b>
MW 053 002	<b>0 432 193 691</b>
MW 053 003	<b>F 000 439 014</b>

0836006	<b>0 280 218 254</b>
12620534	<b>0 445 117 010</b>
12620534	<b>0 986 435 410</b>
12620535	<b>0 445 117 008</b>
12620535	<b>0 986 435 409</b>

12625220	<b>0 445 110 354</b>
12 625 221	<b>0 445 010 259</b>
12638262	<b>0 445 010 687</b>
12638262	<b>0 986 437 421</b>
12639151	<b>0 445 010 687</b>

12639151	<b>0 986 437 421</b>
12640359	<b>0 444 021 025</b>
12645102	<b>0 445 010 687</b>
12645102	<b>0 445 010 817</b>
12645102	<b>0 986 437 421</b>

12645103	<b>0 445 010 687</b>
12645103	<b>0 986 437 421</b>
12647372	<b>0 444 021 030</b>
12650509	<b>0 445 110 354</b>
12650509	<b>0 445 110 424</b>

12656061	<b>0 444 021 036</b>
12658095	<b>0 445 010 802</b>
12658095	<b>0 986 437 421</b>
12661059	<b>0 445 010 817</b>
12661059	<b>0 986 437 421</b>

13301682	<b>0 280 218 254</b>
14045021	<b>0 432 217 081</b>
14059057	<b>0 432 217 104</b>
14063606	<b>0 432 217 092</b>
19210900	<b>0 445 117 008</b>

19210900	<b>0 986 435 409</b>
19256590	<b>0 445 117 010</b>
19256590	<b>0 986 435 410</b>
22902612	<b>0 928 404 020</b>
22902612	<b>1 410 X00 001</b>

22902634	<b>F 01C 600 200</b>
30551795	<b>0 280 217 105</b>
55255408	<b>0 445 110 618</b>
55485045	<b>0 445 010 703</b>
55488616	<b>0 445 110 713</b>

55494494	<b>0 445 010 759</b>
55496735	<b>0 445 010 773</b>
55573939	<b>0 444 021 026</b>
55577668	<b>0 445 110 423</b>
55577668	<b>0 986 435 237</b>

55582064	<b>0 445 010 393</b>
55585712	<b>0 445 117 037</b>
55585712	<b>0 986 435 439</b>
55597787	<b>0 986 437 047</b>
90528435	<b>0 281 002 184</b>

90541591	<b>0 280 217 519</b>
93189955	<b>0 281 002 830</b>
93216076	<b>0 280 217 506</b>
93216076	<b>0 280 217 525</b>
95517501	<b>0 986 435 200</b>

95517502	<b>0 986 435 201</b>
95517503	<b>0 986 435 148</b>
95517505	<b>0 986 435 237</b>
95517506	<b>0 986 435 205</b>
95517506	<b>0 986 435 234</b>

95517507	<b>0 986 435 079</b>
95517507	<b>0 986 435 235</b>
95517507	<b>0 986 435 274</b>
95517508	<b>0 986 435 427</b>
95517509	<b>0 986 435 230</b>

95517511	<b>0 986 435 170</b>
95517511	<b>0 986 435 236</b>
95517511	<b>0 986 435 275</b>
95517512	<b>0 986 435 171</b>
95517513	<b>0 986 435 204</b>

95517514	<b>0 986 435 350</b>
95521529	<b>0 986 435 202</b>
96806111	<b>0 281 002 873</b>
97208073	<b>0 445 020 005</b>
97208074	<b>0 445 120 008</b>

97208074	<b>0 986 435 502</b>
97303657	<b>0 445 120 027</b>
97303657	<b>0 986 435 504</b>
97303762	<b>0 445 020 030</b>
97303762	<b>0 986 437 308</b>

97361351	<b>F 00E 200 431</b>
97361351	<b>0 445 020 105</b>
97361355	<b>0 445 120 042</b>
97361355	<b>0 986 435 521</b>
97363811	<b>0 445 110 174</b>

97363812	<b>0 445 110 175</b>
97720662	<b>0 986 437 303</b>
97729095	<b>0 986 435 502</b>
97780091	<b>0 445 020 030</b>
97780091	<b>0 986 437 308</b>

97780161	<b>F 00E 200 431</b>
97780358	<b>0 986 435 521</b>
97780360	<b>0 986 435 520</b>
98002368	<b>0 445 120 082</b>
98002368	<b>0 986 435 520</b>

**GMEINDER**

95512428	<b>0 445 010 388</b>
----------	----------------------

**GOLAZ GOLITSINO**

1434121	<b>0 432 191 464</b>
---------	----------------------

**GONOW**

1111100-40300	<b>0 445 010 373</b>
1112300-40300	<b>0 445 110 380</b>

**GREAT WALL**

1100100-ED01B	<b>0 445 110 442</b>
1100100XED15	<b>0 445 110 619</b>
1111100 ED0 1B	<b>0 445 010 261</b>

1111300-E06	<b>0 445 010 159</b>
1111300-E06-B1	<b>0 445 025 018</b>
1111300-E06-C1	<b>0 445 025 046</b>
1112100-E05	<b>0 445 110 332</b>
1112100-E06	<b>0 445 110 293</b>

1112100-E06-A1	<b>0 445 110 407</b>
1112100-E06-C1	<b>0 445 110 719</b>

**GUASCOR**

7660860	<b>0 432 231 048</b>
---------	----------------------

**HATZ**

04293610	<b>0 445 020 535</b>
04293700	<b>0 445 110 615</b>
40006700	<b>0 432 297 023</b>

40006800	<b>0 432 297 024</b>
40072500	<b>0 432 291 838</b>
40120900	<b>0 432 291 692</b>
40120901	<b>0 432 291 692</b>
50257201	<b>0 432 291 650</b>

50257210	<b>0 432 291 650</b>
50357100	<b>0 432 291 590</b>
50415101	<b>0 432 193 752</b>
50444000	<b>0 432 193 722</b>
50475100	<b>0 432 193 612</b>

50475101	<b>0 432 193 612</b>
50493000	<b>0 432 193 559</b>
50493001	<b>0 432 193 559</b>

**HELLA**

8ET 009 142-511	<b>0 281 002 447</b>
8ET 009 142-561	<b>0 281 002 757</b>
8ET 009 142-561	<b>0 986 284 010</b>

8ET 009 142-571	<b>0 281 002 461</b>
8ET 009 142-671	<b>0 281 002 180</b>
8ET 009 142-671	<b>0 281 002 199</b>
8ET 009 142-671	<b>0 281 002 309</b>
8ET 009 142-671	<b>0 281 002 428</b>

8ET 009 142-741	<b>0 281 002 613</b>
8ET 009 142-741	<b>0 281 002 619</b>
8ET 009 142-861	<b>0 281 002 216</b>
8ET 009 149-141	<b>0 281 002 792</b>
8ET 009 149-141	<b>0 281 002 980</b>

8ET 009 149-231	<b>0 281 002 152</b>
-----------------	----------------------



<b>HENSCHEL</b>	
2910 12 159 2877	<b>0 432 291 029</b>

<b>HERTH U. BUSS</b>	
70640129	<b>0 281 002 180</b>
70670003	<b>0 281 002 160</b>

<b>HEULIEZ</b>	
5000592825	<b>0 432 281 695</b>
5000592825	<b>0 986 430 342</b>

<b>HINO</b>	
S17HO-E0011	<b>0 444 042 001</b>
S17HO-E0011	<b>0 444 042 096</b>
S17HO-E0041	<b>0 444 042 100</b>

S17HO-E0010	<b>0 444 042 001</b>
S17HO-E0010	<b>0 444 042 096</b>
S17HO-E0012	<b>0 986 44D 215</b>
S17HO-E0020	<b>0 444 042 002</b>
S17HO-E0020	<b>0 444 042 094</b>

S17HO-E0021	<b>0 444 042 002</b>
S17HO-E0021	<b>0 444 042 094</b>
S17HO-E0022	<b>0 986 44D 213</b>
S17HO-E0030	<b>0 444 042 035</b>
S17HO-E0031	<b>0 444 042 035</b>

S17HO-E0040	<b>0 444 042 064</b>
S17JO-E0010	<b>0 444 043 001</b>
S17JO-E0011	<b>0 444 043 060</b>
S17JO-E0011	<b>0 444 043 062</b>
S17JO-E0011	<b>0 986 44D 282</b>

S17JO-E0020	<b>0 444 043 072</b>
S17JO-E0020	<b>0 986 44D 284</b>
S236001221	<b>9 430 612 972</b>
S236002260A	<b>9 430 611 559</b>
S236002710	<b>9 430 610 520</b>

S236003222	<b>9 430 612 737</b>
22100E0521	<b>0 445 020 135</b>
236000186B	<b>9 430 611 334</b>
236000199A	<b>9 430 611 101</b>
236000571A	<b>9 430 612 992</b>

236001023A	<b>9 430 611 297</b>
236001024A	<b>9 430 611 303</b>
236001024B	<b>9 430 610 746</b>
236001025A	<b>9 430 610 776</b>
236001026A	<b>9 430 610 786</b>

236001050A	<b>9 430 611 291</b>
236001082A	<b>9 430 610 730</b>
236001082B	<b>9 430 610 747</b>
236001152A	<b>9 430 610 740</b>
236001160A	<b>9 430 610 754</b>

236001171B	<b>9 430 610 760</b>
236001181B	<b>9 430 610 763</b>
236001181C	<b>9 430 612 975</b>
236001200A	<b>9 430 610 789</b>
236001210A	<b>9 430 610 784</b>

236001211A	<b>9 430 610 784</b>
236001212A	<b>9 430 610 785</b>
236001220A	<b>9 430 610 787</b>
236001221C	<b>9 430 612 972</b>
236001231A	<b>9 430 610 803</b>

236001231B	<b>9 430 610 804</b>
236001232B	<b>9 430 610 837</b>
236001232C	<b>9 430 610 838</b>
236001261A	<b>9 430 610 450</b>
236001320A	<b>9 430 610 305</b>

236001430A	<b>9 430 610 450</b>
236001460B	<b>9 430 610 853</b>
236001480A	<b>9 430 610 857</b>
236001500A	<b>9 430 610 460</b>
236001550A	<b>9 430 610 880</b>

236001560A	<b>9 430 610 886</b>
236001561A	<b>9 430 610 887</b>
236001580A	<b>9 430 611 782</b>
236001590A	<b>9 430 612 772</b>
236001592A	<b>9 430 611 787</b>

236001600A	<b>9 430 610 953</b>
236001601A	<b>9 430 610 964</b>
236001611A	<b>9 430 610 952</b>
236001621B	<b>9 430 611 071</b>
236001631A	<b>9 430 610 982</b>

236001640A	<b>9 430 610 980</b>
236001641A	<b>9 430 611 072</b>
236001642A	<b>9 430 611 076</b>
236001643A	<b>9 430 611 077</b>
236001650A	<b>9 430 610 979</b>

236001651A	<b>9 430 611 073</b>
236001660A	<b>9 430 610 983</b>
236001670A	<b>9 430 611 068</b>
236001671A	<b>9 430 611 074</b>
236001672A	<b>9 430 611 075</b>

236001680A	<b>9 430 610 993</b>
236001690A	<b>9 430 611 078</b>
236001710A	<b>9 430 610 081</b>
236001720A	<b>9 430 611 083</b>
236001740A	<b>9 430 611 095</b>

236001741A	<b>9 430 611 096</b>
236001750A	<b>9 430 611 100</b>
236001751A	<b>9 430 611 108</b>
236001790A	<b>9 430 611 104</b>
236001800A	<b>9 430 611 795</b>

236001820A	<b>9 430 611 109</b>
236001821A	<b>9 430 611 110</b>
236001830A	<b>9 430 610 153</b>
236001840A	<b>9 430 611 114</b>
236001841A	<b>9 430 611 115</b>

236001842A	<b>9 430 611 128</b>
236001843A	<b>9 430 611 131</b>
236001860C	<b>9 430 611 365</b>
236001870A	<b>9 430 611 360</b>
236001880A	<b>9 430 611 855</b>

236001920A	<b>9 430 613 032</b>
236001930A	<b>9 430 611 124</b>
236001940A	<b>9 430 611 373</b>
236001950A	<b>9 430 611 393</b>
236001970A	<b>9 430 611 378</b>

236002000A	<b>9 430 611 134</b>
236002020A	<b>9 430 611 858</b>
236002030A	<b>9 430 611 392</b>
236002070A	<b>9 430 611 405</b>
236002071A	<b>9 430 613 046</b>

236002100A	<b>9 430 611 862</b>
236002120A	<b>9 430 611 160</b>
236002130A	<b>9 430 611 423</b>
236002131A	<b>9 430 611 438</b>
236002140A	<b>9 430 611 863</b>

236002141A	<b>9 430 611 867</b>
236002160A	<b>9 430 611 865</b>
236002170A	<b>9 430 611 177</b>
236002181A	<b>9 430 611 707</b>
236002181B	<b>9 430 612 861</b>

236002190A	<b>9 430 611 443</b>
236002190B	<b>9 430 613 039</b>
236002191A	<b>9 430 611 444</b>
236002240A	<b>9 430 611 554</b>
236002251A	<b>9 430 611 556</b>

236002251B	<b>9 430 611 557</b>
236002271A	<b>9 430 613 013</b>
236002280A	<b>9 430 611 563</b>
236002281A	<b>9 430 613 017</b>
236002290A	<b>9 430 611 474</b>

236002300A	<b>9 430 613 014</b>
236002310A	<b>9 430 611 567</b>
236002310B	<b>9 430 613 015</b>
236002311A	<b>9 430 611 568</b>
236002320A	<b>9 430 611 570</b>

236002350A	<b>9 430 611 572</b>
236002371A	<b>9 430 612 997</b>
236002372A	<b>9 430 612 996</b>
236002380A	<b>9 430 611 492</b>
236002390A	<b>9 430 613 030</b>

236002391A	<b>9 430 611 579</b>
236002410A	<b>9 430 611 582</b>
236002411A	<b>9 430 613 028</b>
236002412C	<b>9 430 611 585</b>
236002412D	<b>9 430 613 026</b>

236002430A	<b>9 430 611 576</b>
236002430B	<b>9 430 611 577</b>
236002440A	<b>9 430 611 575</b>
236002450A	<b>9 430 613 023</b>
236002470A	<b>9 430 613 021</b>

236002470B	<b>9 430 611 589</b>
236002470C	<b>9 430 611 590</b>
236002480A	<b>9 430 613 004</b>
236002480B	<b>9 430 611 599</b>
236002480C	<b>9 430 611 600</b>

236002480D	<b>9 430 611 601</b>
236002510A	<b>9 430 611 603</b>
236002520A	<b>9 430 611 604</b>
236002520B	<b>9 430 611 605</b>
236002520C	<b>9 430 611 606</b>

236002540A	<b>9 430 612 998</b>
236002550A	<b>9 430 613 002</b>
236002550B	<b>9 430 611 609</b>
236002550C	<b>9 430 611 610</b>
236002560A	<b>9 430 611 871</b>

236002570A	<b>9 430 611 873</b>
236002600A	<b>9 430 612 805</b>
236002610A	<b>9 430 611 618</b>
236002620A	<b>9 430 612 987</b>
236002650A	<b>9 430 611 527</b>

236002660A	<b>9 430 612 941</b>
236002661A	<b>9 430 611 626</b>
236002662A	<b>9 430 612 951</b>
236002663A	<b>9 430 612 836</b>
236002663B	<b>9 430 612 837</b>

236002670A	<b>9 430 613 187</b>
236002671A	<b>9 430 610 514</b>
236002680A	<b>9 430 613 188</b>
236002681A	<b>9 430 610 515</b>
236002690A	<b>9 430 613 189</b>

236002691A	<b>9 430 610 516</b>
236002710A	<b>9 430 610 520</b>
236002720A	<b>9 430 612 834</b>
236002730A	<b>9 430 612 828</b>
236002731A	<b>9 430 611 633</b>

236002740A	<b>9 430 612 832</b>
236002741A	<b>9 430 611 635</b>
236002750A	<b>9 430 611 638</b>
236002760A	<b>9 430 611 639</b>
236002770A	<b>9 430 611 646</b>

236002770B	<b>9 430 611 647</b>
236002780A	<b>9 430 612 842</b>
236002790A	<b>9 430 611 650</b>
236002791A	<b>9 430 611 652</b>
236002792A	<b>9 430 611 653</b>

236002800A	<b>9 430 611 655</b>
236002810A	<b>9 430 612 838</b>
236002870A	<b>9 430 613 086</b>
236002880A	<b>9 430 613 087</b>
236002881A	<b>9 430 611 669</b>

236002890A	<b>9 430 611 667</b>
236002940A	<b>9 430 610 560</b>
236002950A	<b>9 430 611 670</b>
236002960A	<b>9 430 611 672</b>
236002961A	<b>9 430 611 673</b>



◀ HINO

236002962A	<b>9 430 611 674</b>
236002970A	<b>9 430 610 562</b>
236002971A	<b>9 430 610 562</b>
236002990A	<b>9 430 611 678</b>
236003000A	<b>9 430 611 683</b>

236003030A	<b>9 430 611 686</b>
236003050A	<b>9 430 611 692</b>
236003060A	<b>9 430 611 689</b>
236003070A	<b>9 430 613 079</b>
236003080A	<b>9 430 612 827</b>

236003110A	<b>9 430 611 690</b>
236003140A	<b>9 430 612 845</b>
236003150A	<b>9 430 612 841</b>
236003200A	<b>9 430 613 072</b>
236003210A	<b>9 430 613 071</b>

236003210B	<b>9 430 612 738</b>
236003220A	<b>9 430 611 694</b>
236003221A	<b>9 430 611 701</b>
236003222A	<b>9 430 611 702</b>
236003222B	<b>9 430 612 737</b>

236003230A	<b>9 430 611 695</b>
236003231A	<b>9 430 611 696</b>
236003232A	<b>9 430 612 848</b>
236003233A	<b>9 430 611 697</b>
236003240A	<b>9 430 610 581</b>

236003250A	<b>9 430 611 700</b>
236003260A	<b>9 430 611 879</b>
236003270A	<b>9 430 612 849</b>
236003300A	<b>9 430 611 880</b>
236003301A	<b>9 430 611 881</b>

236003310A	<b>9 430 612 782</b>
236003341A	<b>9 430 611 712</b>
236003350A	<b>9 430 611 710</b>
236003360A	<b>9 430 611 711</b>
236003400A	<b>9 430 613 096</b>

236003410A	<b>9 430 612 857</b>
236003580A	<b>9 430 613 827</b>
236003600A	<b>9 430 613 722</b>
236003620A	<b>9 430 613 821</b>
236201024B	<b>9 430 615 066</b>

23670-E0470-B	<b>F01G 001 010</b>
23670-E0470-B	<b>0 986 435 639</b>
23670E0490	<b>0 445 120 243</b>
23670E0490	<b>0 986 435 638</b>
6051176001	<b>9 430 610 305</b>

6071170030	<b>9 430 611 264</b>
6071170064	<b>9 430 610 464</b>
6071170073	<b>9 430 610 465</b>
6071170075	<b>9 430 610 467</b>
89550E0072	<b>0 445 120 267</b>

**HOLDEN**

89 725 345 61	<b>0 281 002 537</b>
90 510 154	<b>0 280 217 106</b>
90 510 156	<b>0 280 217 503</b>

90 541 591	<b>0 280 217 519</b>
92 017 809	<b>0 280 202 052</b>
92 023 996	<b>0 280 202 074</b>
92 024 661	<b>0 280 212 008</b>
92 024 661	<b>0 986 280 104</b>

93 179 927	<b>0 280 218 119</b>
------------	----------------------

**HOLLINGSWORTH LOGISTICS**

JL3Q 9K546 AB	<b>0 445 117 077</b>
---------------	----------------------

**HONDA**

16300-P5T-G00	<b>0 460 414 992</b>
16400-PLZ-E01	<b>0 281 002 482</b>
16400 PLZ E011	<b>0 281 002 482</b>

16400-P5T-G00	<b>0 281 002 120</b>
16410-ZG3-013	<b>9 430 610 072</b>
16410 ZG3 0130	<b>9 430 610 072</b>
16410-ZG5-003	<b>9 430 612 697</b>
16410-ZG5-0030	<b>9 430 612 697</b>

16410-ZJ7-003	<b>9 430 612 716</b>
16410ZJ70030	<b>9 430 612 716</b>
16410ZJ7 0031	<b>9 430 612 716</b>
16411-ZG5-003	<b>9 430 615 057</b>
16411-ZG5-0030	<b>9 430 615 057</b>

16450-P5T-G00	<b>0 432 193 820</b>
16450-P5T-G01	<b>0 432 193 571</b>
16450-P5T-G10	<b>0 432 193 819</b>
16450-P5T-G11	<b>0 432 193 601</b>
16450-RL0-G01	<b>0 445 116 006</b>

16450-RL0-G013	<b>0 445 116 006</b>
16450-RL0-G01	<b>0 445 116 006</b>
16450-RL0-G01	<b>0 445 116 056</b>
16450-RL0-G012	<b>0 445 116 006</b>
16450-RL0-G013	<b>0 445 116 056</b>

16450-RMA-E01	<b>0 445 110 236</b>
16450-RMA-E01	<b>0 986 435 145</b>
16450 RMA E011	<b>0 445 110 236</b>
16450 RMA E011	<b>0 986 435 145</b>
16450-RMA-E02	<b>0 445 110 296</b>

16450 RMA E020	<b>0 445 110 296</b>
16450 RMA E020	<b>0 986 435 194</b>
16450 RMAX E000	<b>0 445 110 236</b>
16450 RMAX E000	<b>0 986 435 145</b>
16450-RNY-E01	<b>0 445 110 547</b>

16450-RSR-E01	<b>0 445 110 288</b>
16450-RZ0-G01	<b>0 445 110 532</b>
16450-RZ0-G010	<b>0 445 110 532</b>
16450-RZ0-G011	<b>0 445 110 532</b>
16450 RZ0 G012	<b>0 445 110 532</b>

16450-RZ0-G013	<b>0 445 110 532</b>
16450-RZ0K-G000	<b>0 445 110 532</b>
16450 R06A E003	<b>0 445 110 288</b>
16450-R06-E01	<b>0 445 110 288</b>
16450 R06 E010	<b>0 445 110 288</b>

16450-R3L-G01	<b>0 445 116 056</b>
16450-R3L-G01	<b>0 986 435 443</b>
16450-R3L-G010	<b>0 445 116 056</b>
16450-R3L-G010-M5	<b>0 445 116 056</b>
16450-R3L-G010-M5	<b>0 986 435 443</b>

16450-51WF-E000	<b>0 445 110 547</b>
16540-P5T-G10	<b>0 432 193 819</b>
16790-RBD-E02	<b>0 445 010 141</b>
16790-RBD-E02	<b>0 986 437 356</b>
16790-RBD-E020	<b>0 445 010 141</b>

16790-RBD-E020	<b>0 986 437 356</b>
16790 RBD E021	<b>0 445 010 141</b>
16790 RBD E021	<b>0 986 437 356</b>
16790 RBD E022	<b>0 445 010 141</b>
16790 RBD E022	<b>0 986 437 356</b>

16790 RBD E023	<b>0 445 010 141</b>
16790 RBD E023	<b>0 986 437 356</b>
16790-RBD-E024	<b>0 445 010 141</b>
16790-RBD-E024	<b>0 986 437 356</b>
16790-RL0-G01	<b>0 445 010 612</b>

16790-RL0-G01	<b>0 986 437 465</b>
16790-RL0-G11	<b>0 445 010 635</b>
16790-RL0-G110	<b>0 445 010 635</b>
16790-RL0-G12	<b>0 445 010 635</b>
16790-RL0-G120	<b>0 445 010 635</b>

16790-RL0-G121	<b>0 445 010 635</b>
16790-RL0-G122	<b>0 445 010 635</b>
16790-RL0-G51	<b>0 445 010 612</b>
16790-RL0-G51	<b>0 986 437 465</b>
16790-RL0-G510	<b>0 445 010 612</b>

16790-RL0-G510	<b>0 986 437 465</b>
16790-RL0-G511	<b>0 445 010 612</b>
16790-RL0-G511	<b>0 986 437 465</b>
16790-RL0-G52	<b>0 445 010 612</b>
16790-RL0-G52	<b>0 986 437 465</b>

16790-RL0-G520	<b>0 445 010 612</b>
16790-RL0-G520	<b>0 986 437 465</b>
16790-RL0-G522	<b>0 445 010 612</b>
16790-RL0-G522	<b>0 986 437 465</b>
16790-RNY-E010-M5	<b>0 445 010 584</b>

16790-RZ0-G01	<b>0 445 010 575</b>
16790-RZ0-G01	<b>0 445 010 734</b>
16790-RZ0-G01	<b>0 986 437 451</b>
16790-RZ0-G010	<b>0 445 010 575</b>
16790-RZ0-G010	<b>0 445 010 734</b>

16790-RZ0-G010	<b>0 986 437 451</b>
16790-RZ0-G011	<b>0 445 010 575</b>
16790-RZ0-G011	<b>0 445 010 734</b>
16790-RZ0-G011	<b>0 986 437 451</b>
16790-RZ0-G012	<b>0 445 010 575</b>

16790-RZ0-G012	<b>0 445 010 734</b>
16790-RZ0-G012	<b>0 986 437 451</b>
16790-RZ0-G013	<b>0 445 010 575</b>
16790-RZ0-G013	<b>0 445 010 734</b>
16790-RZ0-G013	<b>0 986 437 451</b>

16790-R3L-G01	<b>0 445 010 635</b>
16790-R3L-G010	<b>0 445 010 635</b>
16790-R5Z-G01	<b>0 445 010 734</b>
16790-R5Z-G01	<b>0 986 437 451</b>
16790-R5Z-G011	<b>0 445 010 734</b>

16790-R5Z-G012	<b>0 445 010 734</b>
----------------	----------------------

**HUECO (HARTING)**

138350	<b>0 281 002 216</b>
138351	<b>0 281 002 757</b>
138351	<b>0 986 284 010</b>

138364	<b>0 281 002 429</b>
138367	<b>0 281 002 309</b>
138950	<b>0 281 002 216</b>
138951	<b>0 281 002 757</b>
138951	<b>0 986 284 010</b>

**HUMMER**

5745881	<b>F 00E 200 431</b>
5745881	<b>0 445 020 105</b>

**HYUNDAI**

OKOAA 13210	<b>0 280 218 092</b>
28100 35400	<b>0 280 218 029</b>
28100 39000	<b>0 280 218 029</b>

28100 39400	<b>0 280 218 090</b>
28100 39450	<b>0 280 218 090</b>
28100 39500	<b>0 280 218 160</b>
28164 22051	<b>0 280 217 102</b>
28164 22060	<b>0 280 217 102</b>

28164 22110	<b>0 280 212 024</b>
28164 22110	<b>0 986 280 123</b>
28164 23010	<b>0 280 217 116</b>
28164 23200	<b>0 280 217 116</b>
28164 27000	<b>0 281 002 447</b>

28164 27050	<b>0 281 002 669</b>
28164 27800	<b>0 281 002 721</b>
28164 27900	<b>0 281 002 600</b>
28164 38080	<b>0 280 218 020</b>
28164 4A000	<b>0 281 002 554</b>

29620-4A800	<b>0 444 040 008</b>
29622-4A800	<b>F 01C 600 249</b>
29630-4A800	<b>0 444 021 041</b>
33100 2A400	<b>0 445 010 289</b>
33100 2A400	<b>0 986 437 030</b>

33100 2A410	<b>0 445 010 289</b>
33100 2A420	<b>0 986 437 042</b>
33100 2A600	<b>0 445 010 595</b>
33100 2A600	<b>0 986 437 447</b>
33100 2F000	<b>0 445 010 544</b>

33100 2F000	<b>0 986 437 431</b>
33100-2F500	<b>0 445 010 556</b>
33100-2F500	<b>0 986 437 444</b>
33100-2F600	<b>0 445 010 597</b>
33100-2F600	<b>0 445 010 740</b>

33100-2F600	<b>0 986 437 444</b>
331002F610	<b>0 445 010 740</b>
331002F610	<b>0 986 437 444</b>
33100 27000	<b>0 445 010 279</b>
33100 27000	<b>0 986 437 020</b>

33100 27400	<b>0 445 010 342</b>
33100 27400	<b>0 986 437 354</b>
33100 27500	<b>0 445 010 280</b>
33100 27500	<b>0 986 437 021</b>
33100 27900	<b>0 445 010 281</b>

33100 27900	<b>0 986 437 022</b>
33100 3A000	<b>0 445 010 347</b>
33100 3A100	<b>0 445 010 385</b>
33100 4A000	<b>0 445 010 354</b>
33100 4A010	<b>0 445 010 355</b>

33100 4A010	<b>0 986 437 369</b>
33100 4A400	<b>0 445 010 399</b>
33100 4A400	<b>0 986 437 029</b>
33105 42710	<b>9 460 615 083</b>
33800 2A100	<b>0 445 110 222</b>

33800 2A100	<b>0 986 435 160</b>
338002A110	<b>0 445 110 222</b>
338002A110	<b>0 986 435 160</b>
33800-2A120	<b>0 445 110 222</b>
33800 2A400	<b>0 445 110 255</b>

33800 2A400	<b>0 986 435 152</b>
33800-2A900	<b>0 445 110 319</b>
33800-2A900	<b>0 986 435 186</b>
33800-2F000	<b>0 445 116 017</b>
33800-2F300	<b>0 445 110 373</b>

33800-2F300	<b>0 986 435 243</b>
33800 21900	<b>0 445 110 290</b>
33800 21900	<b>0 986 435 174</b>
33800 27000	<b>0 445 110 101</b>
33800 27000	<b>0 986 435 147</b>

33800 27010	<b>0 445 110 101</b>
33800 27010	<b>0 986 435 147</b>
33800 27010Y	<b>0 445 110 101</b>
33800 27400	<b>0 445 110 257</b>
33800 27400	<b>0 986 435 156</b>

33800 27750	<b>0 445 110 329</b>
33800 27750	<b>0 986 435 232</b>
33800 27800	<b>0 445 110 253</b>
33800 27800	<b>0 986 435 155</b>
33800 27900	<b>0 445 110 290</b>

33800 27900	<b>0 986 435 174</b>
33800 3A000	<b>0 445 115 045</b>
33800 3A000	<b>0 986 435 391</b>
33800 4A000	<b>0 445 110 091</b>
33800 4A000	<b>0 986 435 154</b>

33800 4A000X	<b>0 986 435 154</b>
33800 4A000Y	<b>0 986 435 154</b>
33800 4A000Z	<b>0 986 435 154</b>
33800 4A100	<b>0 445 110 279</b>
33800 4A100	<b>0 986 435 182</b>

33800 4A150	<b>0 445 110 279</b>
33800 4A150	<b>0 986 435 182</b>
33800-4A160	<b>0 445 110 279</b>
33800-4A160	<b>0 986 435 182</b>
33800-4A170	<b>0 445 110 279</b>

33800 4A170	<b>0 986 435 154</b>
33800-4A170	<b>0 986 435 182</b>
33800 4A300	<b>0 445 110 283</b>
33800 4A300	<b>0 986 435 183</b>
33800 4A350	<b>0 445 110 283</b>

33800-4A350	<b>0 986 435 183</b>
33800-4A360	<b>0 445 110 283</b>
33800-4A370	<b>0 445 110 283</b>
33800 4A400	<b>0 445 110 232</b>
33800 4A400	<b>0 445 110 233</b>

33800 4A410	<b>0 445 110 232</b>
33800 4A410	<b>0 445 110 233</b>
33800 4A420	<b>0 445 110 232</b>
33800 4A420	<b>0 445 110 233</b>
33800-4A500	<b>0 445 110 274</b>

33800-4A500	<b>0 986 435 180</b>
33800-4A600	<b>0 445 110 277</b>
33800-4A600	<b>0 986 435 181</b>
33800 83600	<b>9 430 611 092</b>
50438 01170	<b>0 445 110 248</b>

### HYUNDAI MOTORS MANUFAC. CZECH

33100 2A600	<b>0 445 010 595</b>
33100 2A600	<b>0 986 437 447</b>

33800 2A960	<b>0 445 110 410</b>
33800 2A960	<b>0 986 435 279</b>
33800 2F000	<b>0 445 116 017</b>
33800 2F000	<b>0 986 435 420</b>
33800 3A100	<b>0 445 116 048</b>

### IH (INTERNATIONAL HARV.)

J 908 513	<b>0 432 191 794</b>
J 909 475	<b>0 432 131 881</b>

J 909 476	<b>0 432 131 880</b>
J 909 532	<b>0 432 131 875</b>
J 914 472	<b>0 432 131 869</b>
J 916 946	<b>0 460 426 156</b>
J 916 972	<b>0 460 426 167</b>

J 917 027	<b>0 460 424 059</b>
J 917 526	<b>0 460 424 068</b>
J 917 528	<b>0 460 424 074</b>
J 917 562	<b>0 460 426 167</b>
J 919 300	<b>0 432 131 834</b>

1329 154 C1	<b>0 986 440 015</b>
1329 154 C11	<b>0 986 440 015</b>
1329 155 C1	<b>0 986 440 015</b>
1967 078 C 1	<b>0 460 414 084</b>
1967 078 C 1	<b>0 986 440 032</b>

465 495 C 91	<b>0 432 291 035</b>
610 715 C 91	<b>0 432 291 004</b>
62.10100-6122	<b>0 445 120 180</b>
62.10100-6122	<b>0 986 435 567</b>

### IKARUS

51101017274	<b>0 432 231 778</b>
51101017274	<b>0 986 430 159</b>

### INDUSTRIAL CUSTOMERS

LFBE005505	<b>0 281 002 571</b>
04451200934VT	<b>0 445 120 093</b>

0445120121HCB	<b>0 445 120 121</b>
0445120122	<b>0 445 120 122</b>
0445120122HCB	<b>0 445 120 122</b>
0445120123	<b>0 445 120 123</b>
0445120123HCB	<b>0 445 120 123</b>

94306103584VT	<b>9 430 610 358</b>
94306121244VT	<b>9 430 612 124</b>
94306121254VT	<b>9 430 612 125</b>

### INFINITI

16700 00Q1H	<b>0 445 010 324</b>
16700 00Q1U	<b>0 445 010 324</b>

### INNOCENTI (NUOVA INNOCENTI)

7735577	<b>0 460 484 051</b>
---------	----------------------

### INTERNATIONAL TRUCK

3005063C1	<b>0 986 437 358</b>
-----------	----------------------

### INTERN.TRUCK AND ENGINE CORP.

3002634C1	<b>0 445 020 158</b>
3005275C1	<b>0 445 020 126</b>

3005275C1	<b>0 986 437 506</b>
3005783C92	<b>0 445 124 010</b>
3005783C92	<b>0 445 124 011</b>
3005783C92	<b>0 986 435 577</b>
3005787C92	<b>0 445 124 012</b>

3005787C92	<b>0 445 124 013</b>
3005787C92	<b>0 986 435 578</b>
3013160C91	<b>0 445 124 016</b>
3013160C91	<b>0 986 435 652</b>
5010732R92	<b>0 986 435 577</b>

5010780R1	<b>F 00E 200 549</b>
7096771C91	<b>0 445 020 293</b>

### IRAN KHODRO DIESEL

IK00328180	<b>0 445 010 765</b>
0020104151	<b>0 432 191 256</b>
0040173821	<b>0 432 191 551</b>

0280745902	<b>0 414 799 025</b>
0280745902	<b>0 986 445 102</b>
0280748902	<b>0 414 799 015</b>
0280748902	<b>0 414 799 030</b>
0280748902	<b>0 986 445 020</b>

### IRISBUS

504091504	<b>0 445 120 054</b>
504091504	<b>0 986 435 545</b>
5801382396	<b>0 445 020 175</b>

5801382396	<b>0 986 437 341</b>
------------	----------------------

### ISEKI

62153000020	<b>9 430 612 392</b>
62153000021	<b>9 430 612 393</b>
62153000022	<b>9 430 612 394</b>

62153000040	<b>9 430 612 403</b>
62153000041	<b>9 430 612 404</b>
62153000050B	<b>9 430 610 408</b>
62153000110A	<b>9 430 612 561</b>
62153000180A	<b>9 430 612 712</b>

62153000180C	<b>9 430 612 713</b>
62153000190	<b>9 430 612 562</b>
62153000270B	<b>9 430 610 427</b>
62153000280	<b>9 430 613 049</b>
62153000290	<b>9 430 610 167</b>

621530 00290G	<b>9 430 610 167</b>
62153000310	<b>9 430 610 428</b>
62153000310A	<b>9 430 613 154</b>
62153000340A	<b>9 430 613 428</b>
62153000370A	<b>9 430 610 443</b>



## ◀ ISEKI

62153000370C	<b>9 430 613 148</b>
621530003900	<b>9 430 613 108</b>
6215-300-048-OE	<b>0 445 110 371</b>
6215-600-151-OB	<b>0 445 020 118</b>
65153001100	<b>9 430 610 320</b>

**ISHIKAWAJIMA-  
HARIMA HEAVY IDT**

131406600	<b>H 105 148 805</b>
-----------	----------------------

**ISHIKAWAJIMA-  
SHIBAURA**

13140 6360	<b>9 430 610 172</b>
------------	----------------------

**ISHIKAWAJIMA-  
SHIBAURA MACHIN.**

131406062 0	<b>9 430 610 310</b>
131406251	<b>9 430 610 349</b>

131406261	<b>9 430 610 350</b>
131406320	<b>9 430 610 366</b>
131406360 0	<b>9 430 610 172</b>
131406370	<b>9 430 612 452</b>

**ISUZU**

10PB1	<b>9 430 610 748</b>
10PB1	<b>9 430 610 795</b>
1-15300-003-1	<b>9 430 611 273</b>

1-15300-008-0	<b>9 430 610 164</b>
1-15300-008-1	<b>9 430 613 082</b>
1-15300-008-2	<b>9 430 610 164</b>
1-15300-028-3	<b>9 430 611 275</b>
1-15300-028-4	<b>9 430 611 276</b>

1-15300-033-1	<b>9 430 611 282</b>
1-15300-033-2	<b>9 430 612 954</b>
1-15300-038-0	<b>9 430 611 286</b>
1-15300-038-2	<b>9 430 610 751</b>
1-15300-040-0	<b>9 430 611 304</b>

1-15300-040-1	<b>9 430 611 305</b>
1-15300-041-1	<b>9 430 611 300</b>
1-15300-041-2	<b>9 430 611 301</b>
1-15300-057-2	<b>9 430 610 800</b>
1-15300-057-3	<b>9 430 610 801</b>

1-15300-065-1	<b>9 430 610 890</b>
1-15300-070-1	<b>9 430 610 756</b>
1-15300-070-2	<b>9 430 610 757</b>
1-15300-070-3	<b>9 430 610 758</b>
1-15300-075-1	<b>9 430 610 766</b>

1-15300-083-0	<b>9 430 610 805</b>
1-15300-083-1	<b>9 430 610 806</b>
1-15300-084-0	<b>9 430 610 820</b>
1-15300-085-0	<b>9 430 610 828</b>
1-15300-086-0	<b>9 430 610 813</b>

1-15300-087-2	<b>9 430 610 873</b>
1-15300-087-3	<b>9 430 610 874</b>
1-15300-088-1	<b>9 430 610 829</b>
1-15300-092-0	<b>9 430 610 854</b>
1-15300-095-0	<b>9 430 611 003</b>

1-15300-098-0	<b>9 430 610 884</b>
1-15300-102-1	<b>9 430 610 943</b>
1-15300-103-0	<b>9 430 610 909</b>
1-15300-103-1	<b>9 430 610 910</b>
1-15300-104-0	<b>9 430 610 824</b>

1-15300-104-1	<b>9 430 610 825</b>
1-15300-104-2	<b>9 430 610 826</b>
1-15300-105-1	<b>9 430 610 858</b>
1-15300-106-0	<b>9 430 610 855</b>
1-15300-106-1	<b>9 430 610 856</b>

1-15300-107-0	<b>9 430 610 912</b>
1-15300-107-1	<b>9 430 610 913</b>
1-15300-108-0	<b>9 430 610 930</b>
1-15300-109-0	<b>9 430 610 931</b>
1-15300-111-0	<b>9 430 610 918</b>

1-15300-111-1	<b>9 430 612 969</b>
1-15300-112-1	<b>9 430 610 924</b>
1-15300-114-0	<b>9 430 610 926</b>
1-15300-117-1	<b>9 430 610 937</b>
1-15300-118-1	<b>9 430 610 938</b>

1-15300-119-0	<b>9 430 610 932</b>
1-15300-120-0	<b>9 430 610 944</b>
1-15300-120-1	<b>9 430 610 095</b>
1-15300-128-0	<b>9 430 610 956</b>
1-15300-128-1	<b>9 430 610 957</b>

1-15300-133-1	<b>9 430 612 977</b>
1-15300-134-0	<b>9 430 610 976</b>
1-15300-134-1	<b>9 430 610 977</b>
1-15300-135-0	<b>9 430 610 978</b>
1-15300-138-1	<b>9 430 611 064</b>

1-15300-138-2	<b>9 430 611 065</b>
1-15300-141-0	<b>9 430 611 066</b>
1-15300-142-0	<b>9 430 610 995</b>
1-15300-142-1	<b>9 430 610 996</b>
1-15300-143-0	<b>9 430 612 963</b>

1-15300-143-1	<b>9 430 612 962</b>
1-15300-146-1	<b>9 430 611 001</b>
1-15300-146-2	<b>9 430 611 002</b>
1-15300-149-0	<b>9 430 611 084</b>
1-15300-151-0	<b>9 430 611 014</b>

1-15300-155-0	<b>9 430 611 021</b>
1-15300-155-1	<b>9 430 611 022</b>
1-15300-159-0	<b>9 430 611 062</b>
1-15300-159-1	<b>9 430 611 063</b>
1-15300-160-0	<b>9 430 611 037</b>

1-15300-163-0	<b>9 430 612 978</b>
1-15300-163-1	<b>9 430 611 086</b>
1-15300-164-0	<b>9 430 611 094</b>
1-15300-166-0	<b>9 430 611 057</b>
1-15300-168-0	<b>9 430 611 056</b>

1-15300-170-0	<b>9 430 611 052</b>
1-15300-171-0	<b>9 430 611 054</b>
1-15300-172-0	<b>9 430 611 061</b>
1-15300-179-0	<b>9 430 611 090</b>
1-15300-186-0	<b>9 430 611 325</b>

1-15300-187-1	<b>9 430 611 105</b>
1-15300-191-0	<b>9 430 611 098</b>
1-15300-194-0	<b>9 430 611 102</b>
1-15300-195-0	<b>9 430 611 112</b>
1-15300-196-1	<b>9 430 611 349</b>

1-15300-197-1	<b>9 430 611 410</b>
1-15300-199-1	<b>9 430 611 352</b>
1-15300-201-0	<b>9 430 611 138</b>
1-15300-204-0	<b>9 430 611 161</b>
1-15300-206-0	<b>9 430 611 142</b>

1-15300-207-0	<b>9 430 611 379</b>
1-15300-209-0	<b>9 430 611 397</b>
1-15300-212-0	<b>9 430 611 380</b>
1-15300-213-0	<b>9 430 612 445</b>
1-15300-213-1	<b>9 430 612 446</b>

1-15300-214-0	<b>9 430 612 447</b>
1-15300-217-0	<b>9 430 613 047</b>
1-15300-217-1	<b>9 430 613 043</b>
1-15300-217-2	<b>9 430 611 419</b>
1-15300-218-0	<b>9 430 611 155</b>

1-15300-218-1	<b>9 430 611 156</b>
1-15300-219-0	<b>9 430 611 384</b>
1-15300-220-0	<b>9 430 611 383</b>
1-15300-221-0	<b>9 430 611 431</b>
1-15300-227-0	<b>9 430 612 953</b>

1-15300-231-0	<b>9 430 611 394</b>
1-15300-231-1	<b>9 430 611 395</b>
1-15300-240-0	<b>9 430 611 447</b>
1-15300-241-0	<b>9 430 611 435</b>
1-15300-241-1	<b>9 430 611 436</b>

1-15300-242-0	<b>9 430 611 412</b>
1-15300-244-0	<b>9 430 611 416</b>
1-15300-247-0	<b>9 430 611 421</b>
1-15300-248-0	<b>9 430 612 510</b>
1-15300-249-0	<b>9 430 612 513</b>

1-15300-249-1	<b>9 430 612 514</b>
1-15300-250-1	<b>9 430 611 424</b>
1-15300-251-0	<b>9 430 611 426</b>
1-15300-251-1	<b>9 430 611 427</b>
1-15300-254-0	<b>9 430 611 429</b>

1-15300-259-0	<b>9 430 611 537</b>
1-15300-260-0	<b>9 430 611 539</b>
1-15300-261-0	<b>9 430 611 755</b>
1-15300-266-1	<b>9 430 612 523</b>
1-15300-266-2	<b>9 430 613 319</b>

1-15300-266-3	<b>9 430 613 289</b>
1-15300-269-0	<b>9 430 611 552</b>
1-15300-272-0	<b>9 430 611 472</b>
1-15300-274-0	<b>9 430 613 292</b>
1-15300-274-3	<b>9 430 612 542</b>

1-15300-274-4	<b>9 430 613 293</b>
1-15300-274-5	<b>9 430 612 544</b>
1-15300-274-6	<b>9 430 612 545</b>
1-15300-276-0	<b>9 430 611 441</b>
1-15300-277-0	<b>9 430 611 478</b>

1-15300-279-0	<b>9 430 612 704</b>
1-15300-279-1	<b>9 430 613 059</b>
1-15300-281-0	<b>9 430 612 555</b>
1-15300-281-1	<b>9 430 613 281</b>
1-15300-283-1	<b>9 430 612 511</b>

1-15300-285-0	<b>9 430 613 022</b>
1-15300-285-1	<b>9 430 611 587</b>
1-15300-286-0	<b>9 430 612 769</b>
1-15300-287-0	<b>9 430 611 490</b>
1-15300-288-0	<b>9 430 612 995</b>

1-15300-288-1	<b>9 430 611 494</b>
1-15300-288-2	<b>9 430 612 994</b>
1-15300-289-0	<b>9 430 611 497</b>
1-15300-289-1	<b>9 430 612 993</b>
1-15300-291-0	<b>9 430 611 499</b>

1-15300-291-1	<b>9 430 611 500</b>
1-15300-293-0	<b>9 430 611 501</b>
1-15300-294-0	<b>9 430 611 594</b>
1-15300-294-1	<b>9 430 611 595</b>
1-15300-295-0	<b>9 430 611 596</b>

1-15300-295-1	<b>9 430 611 597</b>
1-15300-296-0	<b>9 430 612 989</b>
1-15300-299-0	<b>9 430 611 508</b>
1-15300-303-0	<b>9 430 611 515</b>
1-15300-303-1	<b>9 430 612 986</b>

1-15300-305-0	<b>9 430 611 800</b>
1-15300-305-1	<b>9 430 611 801</b>
1-15300-306-0	<b>9 430 611 804</b>
1-15300-307-0	<b>9 430 613 005</b>
1-15300-307-1	<b>9 430 613 000</b>

1-15300-307-2	<b>9 430 613 001</b>
1-15300-309-0	<b>9 430 613 477</b>
1-15300-314-0	<b>9 430 611 623</b>
1-15300-315-1	<b>9 430 611 805</b>
1-15300-317-0	<b>9 430 611 615</b>

1-15300-328-0	<b>9 430 611 631</b>
1-15300-331-0	<b>9 430 610 525</b>
1-15300-333-0	<b>9 430 611 810</b>
1-15300-334-0	<b>9 430 611 813</b>
1-15300-335-0	<b>9 430 611 825</b>

1-15300-336-0	<b>9 430 611 939</b>
1-15300-336-1	<b>9 430 611 940</b>
1-15300-337-0	<b>9 430 610 539</b>
1-15300-338-0	<b>9 430 612 760</b>
1-15300-339-0	<b>9 430 611 832</b>

1-15300-339-1	<b>9 430 611 833</b>
1-15300-340-0	<b>9 430 612 759</b>
1-15300-340-1	<b>9 430 611 819</b>
1-15300-341-0	<b>9 430 613 090</b>
1-15300-343-0	<b>9 430 610 554</b>

1-15300-344-0	<b>9 430 612 758</b>	5-15300-103-0	<b>9 430 610 173</b>	8-94375-200-0	<b>9 430 612 505</b>	8-94407-879-3	<b>9 430 612 402</b>
1-15300-352-0	<b>9 430 611 815</b>	5-15300-103-1	<b>9 430 610 173</b>	8-94381-033-1	<b>9 460 610 527</b>	8-94407-879-3	<b>9 430 613 671</b>
1-15300-353-0	<b>9 430 611 802</b>	5-15300-107-0	<b>9 430 610 793</b>	8-94381-033-3	<b>9 460 611 808</b>	8-94407-950-2	<b>9 430 610 126</b>
1-15300-354-0	<b>9 430 611 811</b>	5-15300-109-0	<b>9 430 610 145</b>	8-94385-066-0	<b>9 460 610 654</b>	8-94408-804-2	<b>9 430 610 402</b>
1-15300-355-0	<b>9 430 611 826</b>	5-15300-112-0	<b>9 430 610 823</b>	8-94388-787-0	<b>9 430 612 526</b>	8-94408-804-3	<b>9 430 610 403</b>
1-15300-356-0	<b>9 430 611 820</b>	5-15300-113-0	<b>9 430 610 840</b>	8-94388-787-1	<b>9 430 612 534</b>	8-94409-625-2	<b>9 430 613 249</b>
1-15300-356-1	<b>9 430 611 821</b>	5-15300-115-1	<b>9 430 610 871</b>	8-94388-787-2	<b>9 430 612 548</b>	8-94414-563-2	<b>9 430 610 404</b>
1-15300-356-2	<b>9 430 613 467</b>	5-15300-117-0	<b>9 430 610 341</b>	8-94388-787-3	<b>9 430 613 294</b>	8-94418-161-0	<b>9 430 610 474</b>
1-15300-357-0	<b>9 430 611 823</b>	5-86102-682-0	<b>9 443 611 769</b>	8-94388-960-0	<b>9 460 610 711</b>	8-94418-162-0	<b>9 430 610 475</b>
1-15300-358-0	<b>9 430 611 829</b>	5-86123-666-0	<b>9 443 611 856</b>	8-94390-049-0	<b>9 430 611 644</b>	8-94418-164-0	<b>9 430 610 476</b>
1-15300-360-0	<b>9 430 610 575</b>	5-86123-666-0	<b>9 443 615 728</b>	8-94390-519-0	<b>9 430 611 935</b>	8-94419-110-1	<b>9 430 610 473</b>
1-15300-371-0	<b>9 430 611 968</b>	5-86129-511-0	<b>9 430 613 869</b>	8-94390-795-2	<b>9 430 611 959</b>	8-94419-112-0	<b>0 986 433 004</b>
1-15300-371-1	<b>9 430 611 969</b>	5-86702-647-0	<b>9 430 610 206</b>	8-94390-795-3	<b>9 430 611 960</b>	8-94419-113-0	<b>0 986 433 005</b>
1-15300-371-2	<b>9 430 611 970</b>	87803357	<b>0 470 006 007</b>	8-94390-892-0	<b>9 430 611 680</b>	8-94419-125-0	<b>9 430 610 369</b>
1-15300-371-3	<b>9 430 613 589</b>	8-94114-513-0	<b>9 430 615 019</b>	8-94390-892-1	<b>9 430 612 825</b>	8-94419-150-2	<b>9 430 612 406</b>
1-15300-372-0	<b>9 430 611 971</b>	8-94116-934-3	<b>9 430 610 397</b>	8-94390-892-2	<b>9 430 611 681</b>	8-94422-738-0	<b>9 430 610 372</b>
1-15300-372-1	<b>9 430 611 972</b>	8-94116-990-0	<b>9 430 610 984</b>	8-94391-291-2	<b>9 430 611 957</b>	8-94426-851-1	<b>9 460 610 319</b>
1-15300-372-2	<b>9 430 611 973</b>	8-94117-023-1	<b>9 430 610 986</b>	8-94391-291-3	<b>9 430 611 958</b>	8-94428-001-0	<b>9 430 610 478</b>
1-15300-372-3	<b>9 430 613 583</b>	8-94122-260-0	<b>9 430 612 384</b>	8-94392-058-0	<b>9 430 612 923</b>	8-94428-001-1	<b>9 430 613 199</b>
1-15300-376-0	<b>9 430 611 838</b>	8-94122-260-3	<b>9 430 612 385</b>	8-94392-233-0	<b>9 430 611 961</b>	8-94428-002-0	<b>9 430 610 477</b>
1-15300-379-0	<b>9 430 611 980</b>	8-94122-262-0	<b>9 430 612 381</b>	8-94392-233-1	<b>9 430 611 962</b>	8-94433-626-0	<b>9 430 612 443</b>
1-15300-379-1	<b>9 430 612 907</b>	8-94124-006-1	<b>9 460 610 153</b>	8-94392-579-0	<b>9 430 612 905</b>	8-94437-863-0	<b>9 430 612 444</b>
1-15300-387-0	<b>9 430 612 765</b>	8-94124-857-1	<b>9 460 611 065</b>	8-94393-326-0	<b>9 430 613 061</b>	8-94442-224-0	<b>9 430 612 456</b>
1-15300-387-1	<b>9 430 611 843</b>	8-94126-452-0	<b>9 430 610 353</b>	8-94393-326-1	<b>9 430 613 062</b>	8-94450-050-0	<b>9 430 612 428</b>
1-15300-389-0	<b>9 430 612 736</b>	8-94129-741-0	<b>9 430 613 179</b>	8-94393-335-1	<b>9 430 611 630</b>	8-94450-050-1	<b>9 430 612 429</b>
1-15300-389-1	<b>9 430 613 505</b>	8-94130-074-0	<b>9 430 610 949</b>	8-94393-764-0	<b>9 430 613 063</b>	8-94451-183-1	<b>9 430 612 437</b>
1-15300-390-0	<b>9 430 612 798</b>	8-94139-739-2	<b>9 460 610 409</b>	8-94393-764-1	<b>9 430 612 708</b>	8-94451-183-2	<b>9 430 612 438</b>
1-15300-392-0	<b>9 430 613 361</b>	8-94140-387-3	<b>9 460 610 745</b>	8-94394-213-0	<b>9 430 611 628</b>	8-94452-823-1	<b>9 460 610 518</b>
1-15300-392-1	<b>9 430 613 509</b>	8-94141-135-1	<b>9 430 613 174</b>	8-94394-491-0	<b>9 430 611 629</b>	8-94453-543-0	<b>9 430 612 432</b>
1-15300-393-0	<b>9 430 612 911</b>	8-94144-849-1	<b>9 460 611 066</b>	8-94394-606-0	<b>9 430 613 300</b>	8-94453-543-2	<b>9 430 612 433</b>
1-15300-393-2	<b>9 430 613 508</b>	8-94144-850-1	<b>9 460 611 067</b>	8-94394-606-3	<b>9 430 613 301</b>	8-94459-142-0	<b>0 986 433 004</b>
1-15300-395-0	<b>9 430 613 098</b>	8-94151-615-0	<b>9 430 613 173</b>	8-94394-606-4	<b>9 430 612 611</b>	8-94459-142-1	<b>0 986 433 004</b>
1-15300-402-0	<b>9 430 612 915</b>	8-94151-865-0	<b>9 430 611 009</b>	8-94394-787-0	<b>9 430 613 299</b>	8-94459-142-1	<b>9 430 610 136</b>
1-15300-407-0	<b>9 430 613 104</b>	8-94151-865-1	<b>9 430 612 959</b>	8-94394-787-1	<b>9 430 612 597</b>	8-94460-001-0	<b>9 430 613 200</b>
1-15300-422-0	<b>9 430 613 548</b>	8-94161-947-0	<b>9 430 612 391</b>	8-94394-906-0	<b>9 430 613 066</b>	8-94460-002-0	<b>9 430 613 201</b>
1-15300-432-0	<b>9 430 613 715</b>	8-94169-805-3	<b>9 460 611 260</b>	8-94395-029-0	<b>9 430 613 296</b>	8-94460-004-1	<b>0 986 433 005</b>
1-15300-432-1	<b>9 430 613 759</b>	8-94173-434-0	<b>9 430 613 259</b>	8-94395-498-0	<b>9 430 613 225</b>	8-94460-004-1	<b>9 430 610 137</b>
2-90000-913-0	<b>0 445 120 008</b>	8-94175-422-0	<b>9 430 612 398</b>	8-94395-498-1	<b>9 430 610 535</b>	8-94460-805-0	<b>9 460 620 002</b>
2-90000-913-0	<b>0 986 435 502</b>	8-94176-494-0	<b>9 430 612 396</b>	8-94395-498-2	<b>9 430 610 536</b>	8-94463-885-2	<b>9 460 610 844</b>
2-90000-914-0	<b>0 445 020 005</b>	8-94178-209-0	<b>9 430 613 250</b>	8-94395-511-0	<b>9 430 610 532</b>	8-94468-589-0	<b>9 460 620 001</b>
2-90071-000-0	<b>F 00E 200 431</b>	8-94220-084-3	<b>9 430 610 150</b>	8-94395-696-0	<b>9 430 611 640</b>	8-94470-499-0	<b>9 430 610 089</b>
2-90071-110-0	<b>0 986 437 303</b>	8-94242-958-0	<b>9 460 611 542</b>	8-94395-696-1	<b>9 430 611 641</b>	8-94474-389-1	<b>9 430 611 757</b>
2-90071-300-1	<b>0 986 435 502</b>	8-94317-724-0	<b>9 430 610 483</b>	8-94395-696-2	<b>9 430 611 642</b>	8-94475-161-6	<b>9 460 610 691</b>
2-90071-400-0	<b>0 986 435 504</b>	8-94317-725-0	<b>9 430 610 482</b>	8-94395-697-0	<b>9 430 612 843</b>	8-94475-190-0	<b>9 460 610 678</b>
2-90071-600-0	<b>0 986 435 521</b>	8-94319-317-0	<b>9 430 612 470</b>	8-94395-923-0	<b>9 430 613 131</b>	8-94475-217-3	<b>9 460 611 289</b>
2-90071-700-0	<b>0 986 435 520</b>	8-94328-090-1	<b>9 430 613 142</b>	8-94395-923-1	<b>9 430 612 630</b>	8-94476-375-0	<b>9 430 612 466</b>
4FB1	<b>9 460 610 477</b>	8-94332-974-0	<b>9 460 620 003</b>	8-94396-564-1	<b>9 430 612 533</b>	8-94476-375-1	<b>9 430 612 467</b>
4JB1CDT	<b>9 460 610 367</b>	8-94334-200-1	<b>9 430 612 481</b>	8-94396-564-2	<b>9 430 612 533</b>	8-94479-578-1	<b>9 430 612 475</b>
4JB1-TC	<b>9 460 610 441</b>	8-94334-713-0	<b>9 430 612 482</b>	8-94397-054-0	<b>9 430 612 509</b>	8-94479-578-2	<b>9 430 612 476</b>
5-15300-013-2	<b>9 430 610 077</b>	8-94339-994-0	<b>9 430 611 408</b>	8-94397-372-1	<b>9 430 612 518</b>	8-94479-578-3	<b>9 430 612 478</b>
5-15300-029-0	<b>9 430 611 280</b>	8-94361-590-0	<b>9 430 610 462</b>	8-94397-483-2	<b>9 430 613 328</b>	8-97011-722-0	<b>9 430 610 484</b>
5-15300-039-1	<b>9 430 610 020</b>	8-94361-683-0	<b>9 460 613 423</b>	8-94400-162-0	<b>9 430 612 397</b>	8-97012-663-0	<b>9 430 612 519</b>
5-15300-065-1	<b>9 430 611 307</b>	8-94373-855-0	<b>9 460 610 375</b>	8-94405-255-0	<b>9 430 613 251</b>	8-97013-319-0	<b>9 430 611 480</b>
5-15300-082-0	<b>9 430 610 458</b>	8-94374-491-1	<b>9 430 610 087</b>	8-94405-257-2	<b>9 430 610 472</b>	8-97018-945-0	<b>9 430 612 702</b>
5-15300-089-1	<b>9 430 610 791</b>	8-94375-195-0	<b>9 430 612 501</b>	8-94407-879-2	<b>9 430 610 085</b>	8-97018-945-1	<b>9 430 612 703</b>



## ◀ ISUZU

8-97020-033-0	<b>9 430 611 482</b>
8-97020-390-0	<b>9 460 611 810</b>
8-97020-991-0	<b>9 460 611 540</b>
8-97021-416-0	<b>9 430 612 557</b>
8-97021-416-2	<b>9 430 613 283</b>

8-97021-474-0	<b>9 430 613 193</b>
8-97021-474-1	<b>9 430 610 490</b>
8-97021-474-2	<b>0 986 433 000</b>
8-97022-096-0	<b>9 430 611 469</b>
8-97023-225-0	<b>9 430 610 489</b>

8-97023-226-0	<b>9 430 610 488</b>
8-97023-226-1	<b>9 430 610 148</b>
8-97025-466-0	<b>9 430 610 385</b>
8-97025-994-0	<b>9 460 610 646</b>
8-97026-673-6	<b>9 460 611 685</b>

8-97026-673-7	<b>9 460 611 686</b>
8-97028-321-0	<b>9 460 610 659</b>
8-97030-285-0	<b>9 430 611 476</b>
8-97034-447-0	<b>9 430 610 493</b>
8-97040-843-0	<b>9 460 620 007</b>

8-97042-322-0	<b>9 430 610 389</b>
8-97043-022-5	<b>9 460 610 656</b>
8-97043-023-1	<b>9 460 610 472</b>
8-97043-760-0	<b>9 430 610 485</b>
8-97043-760-1	<b>9 430 610 486</b>

8-97043-760-2	<b>0 986 433 002</b>
8-97043-760-2	<b>9 430 610 128</b>
8-97043-761-0	<b>9 430 610 487</b>
8-97043-761-1	<b>9 430 613 195</b>
8-97043-761-2	<b>9 430 610 129</b>

8-97048-904-0	<b>9 430 610 491</b>
8-97063-662-0	<b>9 430 613 310</b>
8-97063-662-1	<b>9 430 612 591</b>
8-97066-076-0	<b>9 430 613 288</b>
8-97069-342-0	<b>9 430 613 161</b>

8-97069-758-0	<b>9 460 611 532</b>
8-97069-780-0	<b>9 430 610 415</b>
8-97069-780-1	<b>9 430 613 156</b>
8-97072-938-1	<b>9 460 610 596</b>
8-97072-939-1	<b>9 460 610 544</b>

8-97078-638-0	<b>9 460 620 008</b>
8-97078-639-0	<b>9 460 620 009</b>
8-97078-928-0	<b>9 430 612 709</b>
8-97079-976-0	<b>9 430 613 155</b>
8-97079-976-1	<b>9 430 610 416</b>

8-97080-591-0	<b>9 460 610 609</b>
8-97081-157-1	<b>9 430 613 157</b>
8-97081-157-2	<b>9 430 613 817</b>
8-97081-159-0	<b>9 430 610 097</b>
8-97081-789-0	<b>9 430 610 495</b>

8-97085-182-0	<b>9 460 620 010</b>
8-97086-811-1	<b>9 460 610 827</b>
8-97088-673-0	<b>0 986 433 001</b>
8-97092-955-0	<b>9 460 620 011</b>
8-97094-799-0	<b>9 430 613 298</b>

8-97100-840-0	<b>9 430 613 302</b>
8-97105-544-0	<b>9 430 610 501</b>
8-97107-779-0	<b>9 430 613 119</b>
8-97109-103-0	<b>9 430 613 121</b>
8-97114-315-0	<b>9 430 613 064</b>

8-97114-315-1	<b>9 430 612 710</b>
8-97115-503-0	<b>9 430 610 180</b>
8-97115-503-2	<b>9 430 613 634</b>
8-97119-812-0	<b>9 430 610 152</b>
8-97121-225-0	<b>9 460 620 014</b>

8-97121-226-0	<b>9 460 620 015</b>
8-97121-227-0	<b>9 460 620 016</b>
8-97121-228-0	<b>9 460 620 017</b>
8-97122-354-0	<b>9 430 613 130</b>
8-97122-823-0	<b>9 460 620 013</b>

8-97124-700-0	<b>9 430 610 530</b>
8-97125-603-0	<b>9 430 613 191</b>
8-97132-309-1	<b>9 430 613 596</b>
8-97134-251-0	<b>9 460 611 839</b>
8-97134-251-2	<b>9 460 611 449</b>

8-97134-576-1	<b>9 460 613 144</b>
8-97134-577-1	<b>9 460 611 152</b>
8-97136-679-0	<b>9 460 611 710</b>
8-97136-683-1	<b>9 460 614 107</b>
8-97138-526-0	<b>9 460 611 809</b>

8-97138-527-1	<b>9 460 611 358</b>
8-97139-270-0	<b>9 460 620 021</b>
8-97143-328-1	<b>9 460 613 973</b>
8-97144-997-0	<b>9 430 612 656</b>
8-97148-960-0	<b>9 430 612 664</b>

8-97161-455-0	<b>9 430 610 163</b>
8-97161-455-0	<b>9 430 613 689</b>
8-97169-842-0	<b>9 430 613 688</b>
8-97188-521-0	<b>9 430 612 672</b>
8-97189-861-0	<b>9 430 610 195</b>

8-97189-862-0	<b>9 430 610 196</b>
8-97192-333-0	<b>9 430 610 197</b>
8-97192-333-1	<b>9 430 610 183</b>
8-97192-333-2	<b>9 430 613 603</b>
8-97195-258-0	<b>9 430 613 068</b>

8-97200-570-1	<b>9 430 610 216</b>
8-97200-570-3	<b>9 430 613 635</b>
8-97208-073-4	<b>0 445 020 017</b>
8-97208-073-4	<b>0 986 437 303</b>
8-97209-832-0	<b>9 430 610 209</b>

8-97209-832-1	<b>9 430 610 210</b>
8-97209-833-0	<b>9 430 610 211</b>
8-97209-833-3	<b>9 430 610 212</b>
8-97209-861-0	<b>9 430 612 685</b>
8-97209-863-0	<b>9 430 613 106</b>

8-97215-960-0	<b>9 430 612 692</b>
8-97226-680-0	<b>9 430 613 203</b>
8-97227-026-2	<b>0 445 010 039</b>
8-97227-026-2	<b>0 986 437 317</b>
8-97227-026-3	<b>0 445 010 039</b>

8-97227-026-3	<b>0 986 437 317</b>
8-97227-026-4	<b>0 445 010 076</b>
8-97227-026-4	<b>0 986 437 317</b>
8-97229-367-1	<b>9 430 613 143</b>
8-97238-978-0	<b>9 430 613 697</b>

8-97240-057-0	<b>0 281 002 516</b>
8-97241-005-0	<b>9 430 613 139</b>
8-97241-005-1	<b>9 430 613 447</b>
8-97241-083-0	<b>0 280 218 079</b>
8-97253-456-1	<b>0 281 002 537</b>

8-97254-594-0	<b>9 430 613 217</b>
8-97262-559-1	<b>0 445 110 082</b>
8-97262-559-2	<b>0 445 110 082</b>
8-97262-559-3	<b>0 445 110 082</b>
8-97300-091-0	<b>0 445 110 118</b>

8-97300-091-0	<b>0 986 435 082</b>
8-97300-091-1	<b>0 445 110 118</b>
8-97300-091-1	<b>0 986 435 082</b>
8-97300-091-2	<b>0 445 110 118</b>
8-97300-091-2	<b>0 986 435 082</b>

8-97300-091-3	<b>0 445 110 118</b>
8-97300-091-3	<b>0 986 435 082</b>
8-97300-122-0	<b>9 460 613 906</b>
8-97300-942-0	<b>9 430 613 415</b>
8-97300-942-1	<b>9 430 613 904</b>

8-97303 657 C	<b>0 445 120 027</b>
8-97303 657 C	<b>0 986 435 504</b>
8-97303-657-2	<b>0 986 435 504</b>
8-97303-762-0	<b>0 445 020 030</b>
8-97303-762-0	<b>0 986 437 308</b>

8-97306-020-1	<b>9 430 613 890</b>
8-97326-739-0	<b>0 470 504 048</b>
8-97327-244-0	<b>9 430 613 590</b>
8-97329-340-0	<b>9 430 613 910</b>
8-97361-351-2	<b>0 445 020 037</b>

8-97361-351-6	<b>F 00E 200 431</b>
8-97361-355-6	<b>0 445 120 042</b>
8-97361-397-0	<b>0 280 218 146</b>
8-97363-811-0	<b>0 445 110 174</b>
8-97363-811-2	<b>0 445 110 174</b>

8-97363-811-3	<b>0 445 110 174</b>
8-97363-812-0	<b>0 445 110 175</b>
8-97363-812-0	<b>0 986 435 089</b>
8-97363-812-2	<b>0 445 110 175</b>
8-97363-812-2	<b>0 986 435 089</b>

8-97363-812-3	<b>0 445 110 175</b>
8-97363-812-3	<b>0 986 435 089</b>
8-97382-945-0	<b>9 430 613 958</b>
8-97382-947-0	<b>9 430 613 960</b>
8-97382-948-0	<b>9 430 613 961</b>

8-97382-949-0	<b>9 430 613 962</b>
8-97388-738-0	<b>9 430 613 974</b>
8-97600-813-0	<b>9 430 612 919</b>
8-97631-355-6	<b>0 445 120 042</b>
8-98002-368-4	<b>0 445 120 082</b>

8-98087-985-1	<b>0 445 120 216</b>
8-98087-986-1	<b>0 445 010 628</b>
8-98087-986-2	<b>0 445 010 628</b>
8-98087-986-3	<b>0 445 010 835</b>
8-98185-743-4	<b>0 444 043 111</b>

8-98185-743-4	<b>0 986 44D 288</b>
8-98185-744-4	<b>0 444 043 113</b>
8-98185-744-4	<b>0 986 44D 290</b>
8-98231-898-2	<b>0 444 043 107</b>
8-98231-898-2	<b>0 986 44D 286</b>

8-98268-811-0	<b>0 444 042 151</b>
8-98268-811-0	<b>0 986 44D 219</b>
8-98268-812-0	<b>0 444 042 150</b>
8-98268-812-0	<b>0 986 44D 217</b>
8-98332-059-0	<b>0 445 110 720</b>

8-98332-062-0	<b>0 445 010 766</b>
8-98485-498-0	<b>0 444 043 194</b>
9-15300-067-0	<b>9 430 611 190</b>
9-15300-074-0	<b>9 430 610 302</b>
9-15300-122-0	<b>9 430 611 195</b>

9-15300-140-0	<b>9 430 611 263</b>
9-15300-179-0	<b>9 430 611 267</b>
9-15300-191-0	<b>9 430 610 607</b>

## IVECO

P08053015	<b>0 445 120 279</b>
0000069503670	<b>0 281 006 048</b>
0000500332364	<b>0 281 002 184</b>

0000504026069	<b>0 281 002 565</b>
0000504051082	<b>0 281 002 184</b>
0000504055805	<b>0 445 120 028</b>
0000504086469	<b>0 986 435 507</b>
0000504088823	<b>0 445 110 248</b>

0000504088823	<b>0 986 435 163</b>
0000504091504	<b>0 445 120 054</b>
0000504091504	<b>0 986 435 545</b>
0000504136035	<b>0 281 002 764</b>
04150926	<b>0 432 291 669</b>

0445120036	<b>0 445 120 036</b>
0500059696	<b>0 986 44D 232</b>
05043818680	<b>0 986 44D 232</b>
080530150	<b>0 445 120 279</b>
112122	<b>0 432 133 761</b>

181371	<b>0 432 292 869</b>
190 7406	<b>0 986 441 102</b>
2145079	<b>0 432 291 807</b>
2145079	<b>0 986 430 124</b>
2233085	<b>0 432 291 753</b>

2233085	<b>0 986 430 067</b>
2233272	<b>0 432 291 752</b>
2830221	<b>0 986 435 508</b>
2830224	<b>0 986 435 508</b>
2830957	<b>0 986 435 508</b>

299 1150	<b>0 986 441 103</b>	4812995	<b>0 986 440 028</b>	500323359	<b>0 460 424 146</b>	500380884	<b>0 414 700 009</b>
2995462	<b>0 986 435 508</b>	4814197	<b>0 986 440 027</b>	500323359	<b>0 986 440 065</b>	500384284	<b>0 445 120 002</b>
2995464	<b>0 986 435 506</b>	4817954	<b>0 460 414 040</b>	500323362	<b>0 460 424 152</b>	500384284	<b>0 986 435 501</b>
2995466	<b>0 986 435 501</b>	4820872	<b>0 986 440 076</b>	500323363	<b>0 460 424 164</b>	500385287	<b>0 432 133 782</b>
2995468	<b>0 986 435 507</b>	4824170	<b>0 432 291 605</b>	500324435	<b>0 414 700 002</b>	500385952	<b>0 460 424 220</b>
2995470	<b>0 986 435 165</b>	4830159	<b>0 986 440 032</b>	500324435	<b>0 986 441 102</b>	500390440	<b>0 432 131 626</b>
2995472	<b>0 986 435 163</b>	4835952	<b>0 432 291 581</b>	500324574	<b>0 460 404 096</b>	500390441	<b>0 432 133 780</b>
2995474	<b>0 986 435 545</b>	48456693	<b>0 986 430 332</b>	500324954	<b>0 460 413 016</b>	500390441	<b>0 432 133 838</b>
2995476	<b>0 986 435 227</b>	4851446	<b>0 432 291 595</b>	500324955	<b>0 460 413 019</b>	500399366	<b>0 460 424 227</b>
2995478	<b>0 986 441 102</b>	4851446	<b>0 432 291 655</b>	500324956	<b>0 460 413 021</b>	503135250	<b>0 445 120 019</b>
2995480	<b>0 986 441 113</b>	4896444	<b>0 986 435 508</b>	500324959	<b>0 460 414 182</b>	503135250	<b>0 986 435 523</b>
2995482	<b>0 986 441 103</b>	4896958	<b>0 445 020 007</b>	500324961	<b>0 460 414 177</b>	503135269	<b>0 445 120 014</b>
2995484	<b>0 986 441 112</b>	4896958	<b>0 986 437 341</b>	500324962	<b>0 460 414 176</b>	503135269	<b>0 986 435 515</b>
2995486	<b>0 986 441 020</b>	4897040	<b>0 445 020 007</b>	500324964	<b>0 460 416 089</b>	503140183	<b>0 445 020 035</b>
2995486	<b>0 986 441 120</b>	4897040	<b>0 986 437 341</b>	500324967	<b>0 460 414 181</b>	503140728	<b>0 445 120 009</b>
2995488	<b>0 986 441 025</b>	4897271	<b>0 986 435 508</b>	500324968	<b>0 460 414 175</b>	504002523	<b>0 460 494 484</b>
2995490	<b>0 986 441 026</b>	4898821	<b>0 445 020 007</b>	500324969	<b>0 460 424 179</b>	504005534	<b>0 432 291 499</b>
2995492	<b>0 986 437 501</b>	4898821	<b>0 986 437 341</b>	500324970	<b>0 460 424 182</b>	504018748	<b>0 445 010 098</b>
2995494	<b>0 986 437 502</b>	4898921	<b>0 445 020 007</b>	500324972	<b>0 460 426 296</b>	504018748	<b>0 986 437 386</b>
2995496	<b>0 986 437 318</b>	500059692	<b>0 986 440 106</b>	500326169	<b>0 460 426 292</b>	50402200	<b>0 414 700 005</b>
2995500	<b>0 986 437 386</b>	500059694	<b>0 986 440 131</b>	500328286	<b>0 432 193 666</b>	504026069	<b>0 281 002 565</b>
2995504	<b>0 986 437 321</b>	500059696	<b>0 986 440 232</b>	500328971	<b>0 460 424 124</b>	504026190	<b>0 460 423 015</b>
2995510	<b>0 986 437 341</b>	500060378	<b>0 986 435 395</b>	500328971	<b>0 460 424 243</b>	504026195	<b>0 460 424 306</b>
2995512	<b>0 986 437 085</b>	500060418	<b>0 986 435 564</b>	500328971	<b>0 986 440 062</b>	504028507	<b>0 460 424 270</b>
299 8524	<b>0 986 441 112</b>	500060428	<b>0 986 437 437</b>	500328973	<b>0 460 424 125</b>	504029090	<b>0 460 424 308</b>
299 8526	<b>0 986 441 113</b>	500060536	<b>0 986 435 663</b>	500328973	<b>0 460 424 244</b>	504030430	<b>0 460 424 250</b>
299 8528	<b>0 986 441 103</b>	500060538	<b>0 986 435 212</b>	500328973	<b>0 986 440 063</b>	504035897	<b>0 460 424 295</b>
3230159500	<b>0 986 435 508</b>	500060540	<b>0 986 435 255</b>	500329473	<b>0 460 424 136</b>	504036727	<b>0 460 413 028</b>
35022089	<b>0 460 414 220</b>	500060542	<b>0 986 435 530</b>	500329473	<b>0 986 440 064</b>	504041416	<b>0 460 424 300</b>
41271147	<b>0 444 010 003</b>	500060544	<b>0 986 435 552</b>	500329477	<b>0 460 424 177</b>	504041420	<b>0 460 423 007</b>
41271148	<b>0 444 011 003</b>	500060546	<b>0 986 435 551</b>	500331074	<b>0 414 701 083</b>	504042127	<b>0 460 424 282</b>
4143814	<b>0 432 291 699</b>	500060548	<b>0 986 435 662</b>	500332364	<b>0 281 002 184</b>	504042213	<b>0 460 423 006</b>
42522116	<b>0 432 291 644</b>	500060550	<b>0 986 437 437</b>	500334269	<b>0 432 193 641</b>	504042214	<b>0 460 424 299</b>
42562791	<b>0 414 701 052</b>	500060566	<b>0 986 435 674</b>	500338508	<b>0 986 440 066</b>	504042503	<b>0 460 424 249</b>
42562792	<b>0 414 701 053</b>	500060602	<b>0 986 437 389</b>	500338510	<b>0 460 424 146</b>	504042718	<b>0 460 424 280</b>
42562793	<b>0 414 700 007</b>	5000789576	<b>0 432 291 672</b>	500338510	<b>0 986 440 065</b>	504044191	<b>0 460 424 252</b>
42562794	<b>0 414 700 008</b>	5001848034	<b>0 460 424 197</b>	500339059	<b>0 414 701 084</b>	504044193	<b>0 460 424 248</b>
42569159	<b>0 445 120 014</b>	500301121	<b>0 432 193 798</b>	500339059	<b>0 986 441 103</b>	504045835	<b>0 432 133 779</b>
4424186	<b>0 460 484 006</b>	500301632	<b>0 432 291 519</b>	500350964	<b>0 432 193 517</b>	504047343	<b>0 460 414 235</b>
4750104	<b>0 432 281 704</b>	500302483	<b>0 432 193 818</b>	500351182	<b>0 460 426 316</b>	504047351	<b>0 460 426 357</b>
4750504	<b>0 432 281 704</b>	500303485	<b>0 432 117 002</b>	500355722	<b>0 460 426 317</b>	504047895	<b>0 445 120 036</b>
4792442	<b>0 432 291 654</b>	500304921	<b>0 414 701 084</b>	500361332	<b>0 460 424 142</b>	504047895	<b>0 986 435 507</b>
4792992	<b>0 986 440 023</b>	500304921	<b>0 986 441 103</b>	500361706	<b>0 460 424 197</b>	504048467	<b>0 460 424 269</b>
4794586	<b>0 986 440 021</b>	500305724	<b>0 460 494 466</b>	500362397	<b>0 460 416 090</b>	504049834	<b>0 460 424 307</b>
4794588	<b>0 460 414 013</b>	500305724	<b>0 986 440 163</b>	500363382	<b>0 414 700 002</b>	504050703	<b>0 460 424 266</b>
4794588	<b>0 986 440 024</b>	500307410	<b>0 460 424 165</b>	500363382	<b>0 986 441 102</b>	504050944	<b>0 460 424 268</b>
4794589	<b>0 460 414 015</b>	500307714	<b>0 432 291 509</b>	500366314	<b>0 445 020 006</b>	504051082	<b>0 281 002 184</b>
4794834	<b>0 460 416 036</b>	500307714	<b>0 432 291 514</b>	500366314	<b>0 986 437 502</b>	504052007	<b>0 460 424 285</b>
4798834	<b>0 460 416 036</b>	500311188	<b>0 460 426 302</b>	500367520	<b>0 414 700 004</b>	504052677	<b>0 460 424 283</b>
4800029	<b>0 432 291 655</b>	500313105	<b>0 445 120 002</b>	500371101	<b>0 445 120 011</b>	504053466	<b>0 460 426 374</b>
4803490	<b>0 460 414 042</b>	500313105	<b>0 986 435 501</b>	500371101	<b>0 986 435 506</b>	504053467	<b>0 460 424 284</b>
4803490	<b>0 460 416 042</b>	500317389	<b>0 432 291 504</b>	500371931	<b>0 460 494 477</b>	504053470	<b>0 460 426 357</b>
4804869	<b>0 460 414 024</b>	500321797	<b>0 432 193 666</b>	500371947	<b>0 445 020 008</b>	504053471	<b>0 460 424 268</b>
4810522	<b>0 432 291 648</b>	500323357	<b>0 460 424 147</b>	500371947	<b>0 986 437 318</b>	504054020	<b>0 460 424 274</b>
4810552	<b>0 432 291 648</b>	500323357	<b>0 986 440 066</b>	500380884	<b>0 414 700 003</b>	504054021	<b>0 432 291 492</b>

## ◀ IVECO

504054473	<b>0 460 423 011</b>	504079673	<b>0 460 426 389</b>	504124860	<b>0 460 426 458</b>	504200399	<b>0 444 010 008</b>
504054474	<b>0 460 423 012</b>	504080076	<b>0 432 131 623</b>	504125149	<b>0 432 133 764</b>	504200569	<b>0 460 426 451</b>
504054475	<b>0 460 423 008</b>	504080487	<b>0 414 703 008</b>	504125172	<b>0 460 426 381</b>	504201939	<b>0 460 414 268</b>
504054476	<b>0 460 424 296</b>	504080487	<b>0 986 441 026</b>	504125173	<b>0 460 426 384</b>	504205232	<b>0 460 426 465</b>
504054478	<b>0 460 424 298</b>	504081107	<b>0 460 424 315</b>	504125329	<b>0 414 703 008</b>	504208082	<b>0 460 424 403</b>
504054479	<b>0 460 424 297</b>	504082373	<b>0 414 703 004</b>	504125329	<b>0 986 441 026</b>	504208096	<b>0 460 414 265</b>
504055572	<b>0 460 423 024</b>	504082373	<b>0 986 441 025</b>	504126562	<b>0 460 426 410</b>	504213316	<b>0 414 703 013</b>
504055805	<b>0 445 120 028</b>	504085601	<b>0 460 424 327</b>	504128307	<b>0 445 120 075</b>	504214912	<b>0 460 424 388</b>
504055805	<b>0 986 435 512</b>	504086469	<b>0 445 120 036</b>	504128307	<b>0 986 435 530</b>	504218532	<b>0 460 424 275</b>
504057567	<b>0 460 424 371</b>	504086469	<b>0 986 435 507</b>	504128354	<b>0 414 703 009</b>	504218826	<b>0 460 424 430</b>
504057567	<b>0 460 426 371</b>	504086528	<b>0 432 133 771</b>	504128354	<b>0 986 441 027</b>	504219402	<b>0 460 424 425</b>
504057573	<b>0 460 424 286</b>	504087264	<b>0 460 426 415</b>	504128987	<b>0 460 424 295</b>	504222161	<b>0 460 424 275</b>
504060082	<b>0 460 424 284</b>	504088755	<b>0 445 110 273</b>	504128987	<b>0 460 424 402</b>	504222166	<b>0 460 426 476</b>
504060082	<b>0 460 424 309</b>	504088755	<b>0 986 435 165</b>	504129021	<b>0 460 426 447</b>	504226098	<b>0 460 424 349</b>
504060083	<b>0 460 426 370</b>	504088823	<b>0 445 110 248</b>	504129605	<b>0 460 426 457</b>	504226099	<b>0 460 423 013</b>
504060084	<b>0 460 426 374</b>	504088823	<b>0 986 435 163</b>	504129606	<b>0 460 426 459</b>	504242095	<b>0 432 133 763</b>
504062436	<b>0 414 701 021</b>	504091504	<b>0 445 120 054</b>	504129607	<b>0 460 426 453</b>	504245256	<b>0 445 010 181</b>
504062438	<b>0 414 701 022</b>	504091504	<b>0 986 435 545</b>	504129609	<b>0 460 426 455</b>	504245256	<b>0 986 437 085</b>
504063050	<b>0 460 426 380</b>	504091505	<b>0 445 120 057</b>	504130017	<b>0 460 426 370</b>	504246241	<b>0 460 426 477</b>
504063445	<b>0 460 423 003</b>	504091505	<b>0 986 435 552</b>	504132378	<b>0 414 703 004</b>	504246314	<b>0 460 424 417</b>
504063450	<b>0 460 424 282</b>	504091525	<b>0 432 133 771</b>	504132378	<b>0 986 441 025</b>	504246317	<b>0 460 424 409</b>
504063452	<b>0 460 424 306</b>	504093216	<b>0 445 120 079</b>	504134866	<b>0 460 424 413</b>	504246318	<b>0 460 424 410</b>
504063452	<b>0 460 424 343</b>	504095664	<b>0 445 020 046</b>	504135580	<b>0 460 416 105</b>	504246319	<b>0 460 424 408</b>
504063465	<b>0 432 133 775</b>	504095664	<b>0 986 437 321</b>	504135584	<b>0 460 416 103</b>	504246320	<b>0 460 424 414</b>
504063549	<b>0 460 424 302</b>	504096996	<b>0 460 426 412</b>	504136035	<b>0 281 002 764</b>	504246340	<b>0 460 426 481</b>
504063803	<b>0 460 424 275</b>	504096998	<b>0 460 426 411</b>	504145103	<b>0 444 022 001</b>	504247893	<b>0 460 424 398</b>
504065417	<b>0 460 426 381</b>	504097006	<b>0 460 424 351</b>	504145105	<b>0 444 023 001</b>	504251949	<b>0 460 424 424</b>
504066141	<b>0 986 435 506</b>	504097007	<b>0 460 424 349</b>	504154922	<b>0 414 703 009</b>	50425195	<b>0 460 414 267</b>
504066415	<b>0 460 414 232</b>	504097060	<b>0 460 426 410</b>	504154922	<b>0 986 441 027</b>	504251950	<b>0 460 414 267</b>
504066416	<b>0 460 414 233</b>	504097332	<b>0 445 010 137</b>	504164563	<b>0 432 193 447</b>	504255185	<b>0 445 120 157</b>
504066417	<b>0 460 414 234</b>	504097332	<b>0 986 437 085</b>	504166342	<b>0 460 423 013</b>	504255185	<b>0 986 435 564</b>
504067495	<b>0 460 424 316</b>	504098451	<b>0 460 424 333</b>	504171001	<b>0 460 426 499</b>	504255636	<b>0 460 424 423</b>
504068392	<b>0 460 424 328</b>	504098452	<b>0 460 424 346</b>	504173550	<b>0 460 424 386</b>	504255638	<b>0 460 424 416</b>
504068393	<b>0 460 424 314</b>	504099014	<b>0 414 703 009</b>	504174452	<b>0 460 426 461</b>	504256636	<b>0 460 424 423</b>
504068397	<b>0 460 424 345</b>	504099014	<b>0 986 441 027</b>	504177968	<b>0 460 424 275</b>	504275234	<b>0 432 193 433</b>
504068815	<b>0 460 424 304</b>	504099847	<b>0 445 020 040</b>	504180104	<b>0 460 426 470</b>	504277094	<b>0 460 424 441</b>
504071338	<b>0 460 423 013</b>	504100287	<b>0 414 700 006</b>	504181063	<b>0 460 414 270</b>	504281571	<b>0 460 424 442</b>
504071665	<b>0 460 426 384</b>	504100287	<b>0 414 700 010</b>	504181064	<b>0 460 424 404</b>	504286008	<b>0 460 414 277</b>
504072435	<b>0 460 424 307</b>	504100287	<b>0 986 441 020</b>	504181065	<b>0 460 424 445</b>	504287060	<b>0 460 424 436</b>
504073609	<b>0 460 424 333</b>	504100287	<b>0 986 441 120</b>	504181066	<b>0 460 414 269</b>	5042870607	<b>0 460 424 435</b>
504073610	<b>0 460 424 346</b>	504100484	<b>0 460 424 361</b>	504181950	<b>0 460 424 429</b>	504287069	<b>0 414 703 004</b>
504073611	<b>0 460 424 329</b>	504103774	<b>0 460 424 406</b>	504188076	<b>0 445 020 093</b>	504287070	<b>0 414 703 008</b>
504073612	<b>0 460 424 330</b>	504106508	<b>0 414 703 010</b>	504188076	<b>0 986 437 389</b>	504287071	<b>0 414 703 010</b>
504073613	<b>0 460 424 334</b>	504112017	<b>0 460 424 275</b>	504188478	<b>0 460 424 405</b>	504287106	<b>0 414 703 009</b>
504073614	<b>0 460 424 321</b>	504112018	<b>0 460 424 316</b>	504189428	<b>0 460 426 446</b>	504287106R	<b>0 986 441 027</b>
504073703	<b>0 432 131 626</b>	504113228	<b>0 460 424 306</b>	504189447	<b>0 460 424 393</b>	504287108	<b>0 414 703 013</b>
504077429	<b>0 460 426 370</b>	504113253	<b>0 445 120 036</b>	504190005	<b>0 460 424 383</b>	504296671	<b>0 445 010 222</b>
504077429	<b>0 460 426 414</b>	504113253	<b>0 986 435 507</b>	504191707	<b>0 460 424 412</b>	504297560	<b>0 460 426 482</b>
504078132	<b>0 460 426 394</b>	504113991	<b>0 460 424 349</b>	504191709	<b>0 460 424 432</b>	504301164	<b>0 281 006 056</b>
504078499	<b>0 432 133 774</b>	504117032	<b>0 460 424 307</b>	504193263	<b>0 444 022 001</b>	504303916	<b>0 460 424 466</b>
504078911	<b>0 460 426 378</b>	504117098	<b>0 460 423 013</b>	504193263	<b>0 986 44D 106</b>	504307525	<b>0 460 426 480</b>
504079158	<b>0 445 020 041</b>	504117099	<b>0 460 424 283</b>	504193284	<b>0 444 023 001</b>	504308767	<b>0 460 424 449</b>
50407949	<b>0 460 426 395</b>	504117106	<b>0 460 424 315</b>	504194432	<b>0 445 120 092</b>	504330618	<b>0 460 424 460</b>
504079503	<b>0 460 426 419</b>	504117273	<b>0 445 120 079</b>	504194432	<b>0 986 435 551</b>	504330619	<b>0 460 424 464</b>
504079672	<b>0 460 426 388</b>	504124797	<b>0 460 426 452</b>	504197701	<b>0 460 424 389</b>	50433062	<b>0 460 424 459</b>

504341488	<b>0 445 116 019</b>	5096735	<b>0 460 423 029</b>	5801618038	<b>0 445 120 351</b>	98415698	<b>0 986 440 033</b>
504341488	<b>0 445 116 059</b>	5096736	<b>0 460 423 030</b>	5801633945	<b>0 445 020 223</b>	98420738	<b>0 432 191 741</b>
504341488	<b>0 986 435 395</b>	5096737	<b>0 460 424 372</b>	5801644454	<b>0 445 110 564</b>	98423637	<b>0 432 291 533</b>
504342423	<b>0 445 010 545</b>	5096738	<b>0 460 424 373</b>	5801644454	<b>0 986 435 255</b>	98426825	<b>0 460 424 086</b>
504342423	<b>0 445 010 559</b>	5096739	<b>0 460 424 370</b>	5801698918	<b>0 444 043 080</b>	98435368	<b>0 432 291 559</b>
504342423	<b>0 986 437 437</b>	5099371	<b>0 432 191 231</b>	5801703716	<b>0 445 010 593</b>	98439687	<b>0 280 217 503</b>
504361994	<b>0 460 424 379</b>	5236530	<b>0 986 441 103</b>	5801703716	<b>0 986 437 461</b>	98441326	<b>0 460 416 075</b>
504365261	<b>0 444 022 019</b>	5237178	<b>0 986 441 113</b>	5801730656	<b>0 444 023 058</b>	98443145	<b>0 432 291 554</b>
504365261	<b>0 986 44D 106</b>	55220331	<b>0 281 006 056</b>	5801730657	<b>0 444 023 062</b>	98451056	<b>0 432 193 845</b>
504365576	<b>0 444 023 057</b>	5801382396	<b>0 445 020 175</b>	5801769057	<b>0 445 124 030</b>	98451056	<b>0 986 430 256</b>
504368534	<b>0 460 414 279</b>	5801382396	<b>0 986 437 341</b>	5801790338	<b>0 445 110 657</b>	98451597	<b>0 432 191 511</b>
504368534	<b>0 460 424 279</b>	5801386698	<b>0 445 010 320</b>	5801795279	<b>0 445 010 452</b>	98454947	<b>0 432 191 692</b>
504371260	<b>0 445 010 559</b>	5801386698	<b>0 986 437 096</b>	5801800277	<b>0 445 020 257</b>	98458045	<b>0 432 291 549</b>
504371260	<b>0 986 437 437</b>	5801392767	<b>0 444 011 014</b>	5801861266	<b>0 445 010 452</b>	98466049	<b>0 432 297 057</b>
504371264	<b>0 445 117 025</b>	5801439052	<b>0 445 010 181</b>	5801906153	<b>0 445 124 036</b>	98466049	<b>0 986 430 532</b>
504373553	<b>0 460 424 491</b>	5801439052	<b>0 445 010 318</b>	5801906153	<b>0 986 435 674</b>	98475855	<b>0 986 440 524</b>
504374326	<b>0 444 022 021</b>	5801439052	<b>0 986 437 085</b>	5801906154	<b>0 445 124 035</b>	98476031	<b>0 432 193 842</b>
504374326	<b>0 986 44D 131</b>	5801439062	<b>0 445 010 320</b>	5801906155	<b>0 445 124 037</b>	98476031	<b>0 986 430 527</b>
504374327	<b>0 444 023 058</b>	5801439062	<b>0 986 437 096</b>	5801932928	<b>0 445 120 409</b>	98476133	<b>0 460 494 340</b>
504374647	<b>0 460 424 470</b>	5801439067	<b>0 445 010 222</b>	5801940312	<b>0 445 010 465</b>	98486879	<b>0 432 191 680</b>
504374933	<b>0 460 424 474</b>	5801453888	<b>0 445 124 015</b>	61315024	<b>0 432 191 818</b>	98487816	<b>0 432 191 692</b>
504374935	<b>0 460 424 482</b>	5801453888	<b>0 986 435 663</b>	61316336	<b>0 432 191 818</b>	98488688	<b>0 460 424 110</b>
504374936	<b>0 460 424 475</b>	5801467085	<b>0 445 020 185</b>	61317616	<b>0 432 191 818</b>	98488691	<b>0 460 426 252</b>
504374940	<b>0 460 424 478</b>	5801469103	<b>0 445 010 300</b>	61319197	<b>0 432 191 731</b>	98488692	<b>0 460 426 242</b>
504374941	<b>0 460 424 473</b>	5801469103	<b>0 445 010 301</b>	61320138	<b>0 432 191 731</b>	98488693	<b>0 460 426 255</b>
504374942	<b>0 460 424 469</b>	5801470098	<b>0 445 110 457</b>	69503670	<b>0 281 006 048</b>	98492215	<b>0 986 440 041</b>
504374943	<b>0 460 424 481</b>	5801470098	<b>0 986 435 254</b>	71724118	<b>0 986 435 506</b>	98492217	<b>0 986 440 042</b>
504374948	<b>0 460 424 477</b>	5801470100	<b>0 445 020 516</b>	71791186	<b>0 986 430 527</b>	98499901	<b>0 432 191 646</b>
504374949	<b>0 460 424 479</b>	5801471116	<b>0 444 021 040</b>	7555128	<b>0 280 200 051</b>	99434327	<b>0 432 291 516</b>
504374950	<b>0 460 424 472</b>	5801472359	<b>0 445 010 585</b>	7612319	<b>0 280 202 115</b>	99440197	<b>0 460 414 197</b>
504374951	<b>0 460 424 483</b>	5801472359	<b>0 445 010 593</b>	7612320	<b>0 986 280 115</b>	99441584	<b>0 460 413 014</b>
504374952	<b>0 460 424 471</b>	5801472359	<b>0 986 437 461</b>	7648065	<b>0 986 280 114</b>	99441586	<b>0 460 413 013</b>
504374953	<b>0 460 424 476</b>	5801479314	<b>0 445 120 361</b>	7706073	<b>0 280 202 128</b>	99441587	<b>0 460 413 012</b>
504374955	<b>0 460 424 480</b>	5801483286	<b>0 445 110 520</b>	771354	<b>0 432 297 034</b>	99441847	<b>0 460 414 115</b>
504377594	<b>0 460 424 489</b>	5801483286	<b>0 986 435 248</b>	771354	<b>0 986 430 144</b>	99442433	<b>0 460 424 125</b>
504381866	<b>0 444 023 062</b>	5801486599	<b>0 445 020 195</b>	7735577	<b>0 460 484 051</b>	99442433	<b>0 986 440 063</b>
504381868	<b>0 986 44D 232</b>	5801486599	<b>0 986 437 512</b>	7735579	<b>0 460 494 304</b>	99443744	<b>0 432 193 757</b>
504385419	<b>0 460 424 492</b>	5801496001	<b>0 445 120 346</b>	7778146	<b>0 432 217 274</b>	99443744	<b>0 460 424 220</b>
504385557	<b>0 445 116 019</b>	5801496001	<b>0 986 435 662</b>	7778146	<b>0 986 430 525</b>	99443744	<b>0 986 430 522</b>
504385659	<b>0 460 424 489</b>	5801527580	<b>0 445 010 401</b>	8023957	<b>0 460 426 292</b>	99443933	<b>0 460 424 124</b>
504385978	<b>0 432 193 424</b>	5801540211	<b>0 445 116 059</b>	8024221	<b>0 280 217 503</b>	99443933	<b>0 986 440 062</b>
504386427	<b>0 445 110 435</b>	5801540211	<b>0 986 435 395</b>	8025562	<b>0 280 217 817</b>	99444432	<b>0 432 193 730</b>
504386427	<b>0 986 435 227</b>	5801540213	<b>0 445 117 036</b>	8038558	<b>0 280 217 817</b>	99444577	<b>0 460 424 136</b>
504387474	<b>0 460 424 491</b>	5801540213	<b>0 986 435 414</b>	8049061	<b>0 460 426 487</b>	99444577	<b>0 986 440 064</b>
504387476	<b>0 460 424 491</b>	5801544859	<b>0 444 042 114</b>	8052934	<b>0 445 120 269</b>	99445057	<b>0 414 700 002</b>
504387929	<b>0 445 120 282</b>	5801544864	<b>0 444 042 119</b>	80530150	<b>0 445 120 279</b>	99445057	<b>0 986 441 102</b>
5043879929	<b>0 445 120 282</b>	5801569141	<b>0 445 110 540</b>	8096535	<b>0 432 117 002</b>	99450992	<b>0 432 193 798</b>
50438875	<b>0 445 124 014</b>	580157247	<b>0 445 010 585</b>	8110854	<b>0 432 281 704</b>	99453427	<b>0 432 291 514</b>
50438875	<b>0 986 435 655</b>	5801572470	<b>0 445 010 585</b>	8122172	<b>0 432 291 807</b>	99459163	<b>0 460 424 159</b>
504388756	<b>0 445 020 160</b>	5801572470	<b>0 445 010 593</b>	8122175	<b>0 432 291 753</b>	99459179	<b>0 460 424 152</b>
504388756	<b>0 986 437 512</b>	5801572470	<b>0 986 437 461</b>	8122176	<b>0 432 291 752</b>	99459752	<b>0 986 440 066</b>
504389548	<b>0 445 110 418</b>	5801594342	<b>0 445 110 520</b>	84385110	<b>0 445 020 175</b>	99469340	<b>0 432 291 505</b>
504389548	<b>0 986 435 212</b>	5801594342	<b>0 986 435 248</b>	84385110	<b>0 986 437 341</b>	99469340	<b>0 432 291 509</b>
5090725	<b>0 432 291 494</b>	5801606318	<b>0 445 010 593</b>	98413207	<b>0 432 291 580</b>	99469600	<b>0 460 416 083</b>
5095919	<b>0 460 413 031</b>	5801606318	<b>0 986 437 461</b>	98414185	<b>0 432 291 555</b>	994696600	<b>0 460 416 083</b>



## ◀ IVECO

9947099	<b>0 460 413 017</b>
99472099	<b>0 460 413 017</b>
99472100	<b>0 460 413 015</b>
99472101	<b>0 460 414 169</b>
99472101	<b>0 460 414 170</b>

99472102	<b>0 460 414 169</b>
99472103	<b>0 460 414 183</b>
99472104	<b>0 460 414 180</b>
99472948	<b>0 432 291 508</b>
99475604	<b>0 460 414 179</b>

99475605	<b>0 460 414 171</b>
99477844	<b>0 460 424 142</b>
99477846	<b>0 460 424 141</b>
99477859	<b>0 460 424 124</b>
99477859	<b>0 986 440 062</b>

99477860	<b>0 460 424 125</b>
99477860	<b>0 986 440 063</b>
99477862	<b>0 460 424 136</b>
99477862	<b>0 986 440 064</b>
99481736	<b>0 986 440 065</b>

99483254	<b>0 445 020 002</b>
99483254	<b>0 986 437 501</b>
99485235	<b>0 432 291 500</b>
99485539	<b>0 432 291 505</b>
99485546	<b>0 414 700 002</b>

99485546	<b>0 986 441 102</b>
----------	----------------------

**JAC (JIANGHUAI  
AUTOMOBILE)**

0445020532	<b>0 445 020 532</b>
1042300FB	<b>0 445 010 251</b>

1100200FB010	<b>0 445 110 493</b>
1100300FA040	<b>0 445 010 372</b>
28164-V3730	<b>0 280 218 166</b>

**JAGUAR**

AJ8 13375	<b>0 445 110 653</b>
C2C 40577	<b>0 445 116 012</b>
C2C 40577	<b>0 445 116 064</b>

C2P 21658	<b>0 445 010 832</b>
C2P 21658	<b>0 986 437 432</b>
JDE 34418	<b>0 445 010 697</b>
RKC 3634	<b>0 280 202 016</b>
T2H 21001	<b>0 445 010 820</b>

02AJ813375	<b>0 445 110 653</b>
02AJ813376	<b>0 445 110 700</b>
02AJ813377	<b>0 445 110 663</b>
02C2C40577	<b>0 445 116 012</b>
02C2C40577	<b>0 445 116 064</b>

02JDE36716	<b>0 986 435 423</b>
02JDE36716E	<b>0 986 435 423</b>
02JDE37866	<b>0 445 116 064</b>
02JDE38562	<b>0 445 010 832</b>
02JDE38562	<b>0 986 437 432</b>

02T2H18670	<b>F 01C 600 271</b>
02T2H 21001	<b>0 445 010 820</b>

**JCB POWER SYSTEMS**

320/A6566	<b>F 002 C7Z 482</b>
-----------	----------------------

**JEEP**

015062047F	<b>0 986 435 128</b>
03506 2022F	<b>0 445 110 747</b>
05033 320AA	<b>0 281 002 779</b>

05066 820AA	<b>0 445 110 059</b>
05066 820AA	<b>0 986 435 149</b>
05142 811AA	<b>0 445 110 217</b>
05142 811AA	<b>0 445 110 218</b>
05142 811AA	<b>0 986 435 128</b>

05142 811AA	<b>0 986 435 263</b>
05159 970AA	<b>0 986 435 128</b>
15 06 2047F	<b>0 986 435 128</b>
3506 2022F	<b>0 445 110 747</b>
5033320AA	<b>0 281 002 779</b>

5066820AA	<b>0 445 110 059</b>
5066820AA	<b>0 986 435 149</b>
5142 811AA	<b>0 445 110 217</b>
5142811AA	<b>0 445 110 218</b>
5142 811AA	<b>0 986 435 128</b>

5142 811AA	<b>0 986 435 263</b>
5159 970AA	<b>0 986 435 128</b>
53013 009AA	<b>0 281 002 501</b>
53013 673AA	<b>0 281 002 896</b>
64207 00301	<b>0 986 437 363</b>

68018 733AA	<b>0 986 437 365</b>
68028 405AA	<b>0 986 435 355</b>
68042029AA	<b>0 445 115 067</b>
68042029AA	<b>0 986 435 402</b>
68046351AA	<b>0 445 010 152</b>

68211 269AA	<b>0 445 010 684</b>
68211 269AA	<b>0 986 437 468</b>
68211 302AA	<b>0 986 435 251</b>

**JENS & CATTEL**

1100200FA040	<b>0 445 110 335</b>
--------------	----------------------

**JMC (JIANGLING)**

AN3-9K546-AA	<b>0 445 110 461</b>
CN3-9B395-AB	<b>0 445 020 520</b>
OP1-9B395-BA	<b>0 445 025 040</b>

1100200FA171	<b>0 445 110 710</b>
11112100ABA	<b>0 445 110 454</b>
1111300ABYB1	<b>0 445 025 040</b>
1111300CAT	<b>0 445 010 169</b>
1111300JQF CP1	<b>0 445 025 050</b>

1112100CAT	<b>0 445 110 305</b>
1112100CAT	<b>0 986 435 231</b>
1123100RAA	<b>0 445 010 191</b>
6C1Q-9B395-BB	<b>0 445 010 379</b>
9P2-12B579AA	<b>0 281 006 068</b>

9P2-9B395-AA	<b>0 445 010 379</b>
--------------	----------------------

**JOHN DEERE**

AR 10 307 3	<b>9 430 233 003</b>
AR 70 186	<b>0 432 231 857</b>
AR 70 187	<b>0 432 231 860</b>

AR 73 100	<b>0 432 231 855</b>
AR 73 847	<b>0 432 231 857</b>
AR 74 664	<b>0 432 231 860</b>
AR 78 308	<b>0 432 231 848</b>
AR 79 686	<b>0 432 231 848</b>

ER5801790338	<b>0 445 110 657</b>
RE 30 970	<b>0 432 131 867</b>
RE 42 305	<b>0 432 131 806</b>
RE 48 359	<b>0 432 131 822</b>
RE 50 127 5	<b>0 986 444 047</b>

RE 50 127 5	<b>0 986 444 085</b>
RE 50 668 0	<b>0 470 506 031</b>
RE 50 668 0	<b>0 986 444 086</b>
RE 50 668 1	<b>0 470 506 032</b>
RE 50 668 1	<b>0 986 444 087</b>

RE 51 540 9	<b>0 432 131 641</b>
RE 51 588 7	<b>0 470 506 043</b>
RE 51 588 7	<b>0 986 444 088</b>
RE 51 588 8	<b>0 986 444 089</b>
RE 52 282 6	<b>0 470 506 032</b>

RE 52 282 6	<b>0 986 444 087</b>
RE 55 217 5	<b>0 444 042 066</b>
RE553796	<b>0 444 042 067</b>
RE 55 379 6	<b>0 986 444 236</b>
RE 55 562 6	<b>0 444 043 046</b>

RE 56 046 8	<b>0 444 043 045</b>
RE 57 152	<b>0 432 131 766</b>
RE 61 593	<b>0 432 131 765</b>
RE 63 073	<b>0 432 131 735</b>
RE 63 261	<b>0 432 131 737</b>

RE 64 184	<b>0 432 131 752</b>
RE 64 391	<b>0 432 131 736</b>
RE 65 467	<b>0 432 131 723</b>
TR 61 593	<b>0 432 131 765</b>

**KAELBLE**

0000176421	<b>0 432 231 886</b>
0000176421	<b>0 986 430 055</b>
0020171221	<b>0 432 231 775</b>

**KAELBLE-GMEINDER**

002 01700 21	<b>0 986 430 038</b>
002 01733 21	<b>0 986 430 038</b>

**KAMAZ**

004510411110699088	<b>0 445 020 089</b>
004510411120349088	<b>0 445 120 153</b>
201149059	<b>0 445 020 089</b>

201149061	<b>0 445 120 153</b>
-----------	----------------------

**KARSAN**

20018594124	<b>0 281 002 764</b>
-------------	----------------------

**KÄSSBOHRER**

0020170021	<b>0 986 430 038</b>
0020173321	<b>0 986 430 038</b>
0030175421	<b>0 432 231 681</b>

0030175521	<b>0 432 231 680</b>
0030175521	<b>0 986 430 038</b>
0030177121	<b>0 986 430 265</b>
0030177221	<b>0 986 430 264</b>
0030177421	<b>0 432 131 804</b>

0030177521	<b>0 432 131 803</b>
0030179221	<b>0 432 131 781</b>
0030179221	<b>0 986 430 361</b>
0030179321	<b>0 432 131 780</b>
0040172921	<b>0 432 131 726</b>

0040172921	<b>0 986 430 326</b>
0040173021	<b>0 432 131 728</b>
0040173021	<b>0 986 430 327</b>
0040173221	<b>0 432 131 730</b>
0040173321	<b>0 432 131 729</b>

0050175321	<b>0 432 191 384</b>
0280745902	<b>0 414 799 025</b>
0280745902	<b>0 986 445 102</b>
5 110 101 731 0	<b>0 432 131 853</b>
5 110 101 731 0	<b>0 986 430 196</b>

8 312 000 386	<b>0 986 430 053</b>
8 312 000 611	<b>0 986 430 020</b>

**KAUTEX**

102 979 300 1	<b>0 444 040 011</b>
102 979 800 2	<b>0 444 040 011</b>

**KAWASAKI HEAVY INDUSTRIES**

C42171A004R6	<b>9 430 612 350</b>
C42171A004R6	<b>9 430 613 267</b>

**KAYSER AUTOMOTIVE SYSTEMS**

VT 55 55	<b>0 280 218 192</b>
3 002 974 00	<b>0 280 218 192</b>

**KEFICO**

9 210 930 001	<b>0 280 217 102</b>
9 210 930 002	<b>0 280 217 116</b>

**KENWORTH**

TE3130201	<b>9 430 082 715</b>
-----------	----------------------

**KHD**

00771355	<b>0 432 297 034</b>
0155 19 07 80	<b>0 432 227 027</b>
02111696	<b>0 432 191 539</b>

02111697	<b>0 432 191 538</b>
02111987	<b>0 432 191 539</b>
02111988	<b>0 432 191 538</b>
02112351	<b>0 432 191 411</b>
02112380	<b>0 432 191 452</b>

02112489	<b>0 432 191 424</b>
02112598	<b>0 432 193 482</b>
02112624	<b>0 432 191 373</b>
02112625	<b>0 432 191 375</b>
02112626	<b>0 432 191 374</b>

02112627	<b>0 432 191 369</b>
02112633	<b>0 432 191 376</b>
02112634	<b>0 432 191 353</b>
02112635	<b>0 432 191 252</b>
02112636	<b>0 432 191 367</b>

02112640	<b>0 432 191 377</b>
02112644	<b>0 432 191 378</b>
02112645	<b>0 432 191 379</b>
02112681	<b>0 432 191 345</b>
02112706	<b>0 414 750 004</b>

02112707	<b>0 414 750 003</b>
02112862	<b>0 432 191 328</b>
02112949	<b>0 432 191 287</b>
02112955	<b>0 432 191 325</b>
02112957	<b>0 432 191 327</b>

02112960	<b>0 432 191 326</b>
02112967	<b>0 432 191 323</b>
02112994	<b>0 432 193 498</b>
02113000	<b>0 432 191 313</b>
02113007	<b>0 432 191 245</b>

02113090	<b>0 432 191 292</b>
02113133	<b>0 432 193 486</b>
02113547	<b>0 432 193 450</b>
02113645	<b>0 432 193 446</b>
02113688	<b>0 432 193 429</b>

02113690	<b>0 432 193 430</b>
02113775	<b>0 432 193 498</b>
02126992	<b>0 986 430 490</b>
02126993	<b>0 432 191 654</b>
02145079	<b>0 432 291 807</b>

02145079	<b>0 986 430 124</b>
02147859	<b>0 432 291 782</b>
02233085	<b>0 432 291 753</b>
02233085	<b>0 986 430 067</b>
02233272	<b>0 432 291 752</b>

02934455	<b>0 432 237 006</b>
03028857	<b>0 460 414 063</b>
03372161	<b>0 432 227 027</b>
04007565	<b>0 432 237 006</b>
04014333	<b>0 432 191 568</b>

04015876	<b>0 432 237 006</b>
04123830	<b>0 445 110 559</b>
04123831	<b>0 445 110 558</b>
04123872	<b>0 445 110 455</b>
04123874	<b>0 445 110 514</b>

04123891	<b>0 445 020 518</b>
04123934	<b>0 445 020 525</b>
04132001	<b>0 445 110 513</b>
04132002	<b>0 445 110 499</b>
04132013	<b>0 445 110 560</b>

04132014	<b>0 445 110 561</b>
04132054	<b>0 445 110 499</b>
04132055	<b>0 445 110 513</b>
04132090	<b>0 445 020 519</b>
04132378	<b>0 445 020 527</b>

04143814	<b>0 432 291 699</b>
04148899	<b>0 432 291 644</b>
04149713	<b>0 432 291 633</b>
04150926	<b>0 432 291 669</b>
04153605	<b>0 432 191 787</b>

04154134	<b>0 432 191 787</b>
04154143	<b>0 432 191 787</b>
04157216	<b>0 432 291 753</b>
04157645	<b>0 432 191 752</b>
04158138	<b>0 432 191 752</b>

04158546	<b>0 432 191 752</b>
04158546	<b>0 432 291 752</b>
04178021	<b>0 432 191 623</b>
04178022	<b>0 432 191 625</b>
04178023	<b>0 432 191 624</b>

04178024	<b>0 432 191 627</b>
04179470	<b>0 432 193 791</b>
04179983	<b>0 432 191 605</b>
04184965	<b>0 432 291 644</b>
04185578	<b>0 432 291 591</b>

04186695	<b>0 432 291 553</b>
04221425	<b>0 432 131 795</b>
04224446	<b>0 432 131 696</b>
04224523	<b>0 432 131 695</b>
04226621	<b>0 432 131 659</b>

04226624	<b>0 432 131 658</b>
04230141	<b>0 432 191 712</b>
04232066	<b>0 432 191 568</b>
04232373	<b>0 432 291 753</b>
04232434	<b>0 432 191 399</b>

04232434	<b>0 432 227 035</b>
04233015	<b>0 432 191 487</b>
04233067	<b>0 432 191 479</b>
04233892	<b>0 432 191 330</b>
04234349	<b>0 432 191 312</b>

04240720	<b>0 432 291 497</b>
04240725	<b>0 432 291 498</b>
04260140	<b>0 432 131 649</b>
04260142	<b>0 432 131 648</b>
04260506	<b>0 432 131 647</b>

04260889	<b>0 432 131 637</b>
04261447	<b>0 432 131 635</b>
04261448	<b>0 432 131 638</b>
04261449	<b>0 432 131 634</b>
04262056	<b>0 414 755 016</b>

04262581	<b>0 432 131 618</b>
04262582	<b>0 432 131 619</b>
04262583	<b>0 432 131 620</b>
04262585	<b>0 432 131 614</b>
04262606	<b>0 432 131 617</b>

04263302	<b>0 432 131 613</b>
04264634	<b>0 432 131 611</b>
04266347	<b>0 445 124 009</b>
04267012	<b>0 444 042 026</b>
04267118	<b>0 445 020 234</b>

04268478	<b>0 444 043 020</b>
04268479	<b>0 444 043 020</b>
04271760	<b>0 432 193 596</b>
04280367	<b>0 432 191 399</b>
04280368	<b>0 432 193 546</b>

04289311	<b>0 445 120 066</b>
04289311	<b>0 986 435 548</b>
04290986	<b>0 445 120 066</b>
04290986	<b>0 986 435 548</b>
04290987	<b>0 445 120 067</b>

04290987	<b>0 986 435 549</b>
04290988	<b>0 445 120 065</b>
04290988	<b>0 986 435 559</b>
04504488	<b>0 445 120 234</b>
04504664	<b>0 445 120 246</b>

04504666	<b>0 445 124 001</b>
04504666	<b>0 986 435 572</b>
04511504	<b>0 445 120 362</b>
04511509	<b>0 445 124 023</b>
04514650	<b>0 445 120 424</b>

04515158	<b>0 445 124 041</b>
04515158	<b>0 986 435 572</b>
04600619	<b>0 444 043 011</b>
04600620	<b>0 444 042 019</b>
04601049	<b>0 444 042 063</b>

04603859	<b>0 444 042 068</b>
04604141	<b>0 444 043 073</b>
04611049	<b>0 444 042 063</b>
04902255	<b>0 445 120 064</b>
04902255	<b>0 986 435 529</b>

04902525	<b>0 445 120 074</b>
04902525	<b>0 986 435 536</b>
04902825	<b>0 445 120 064</b>
04902825	<b>0 986 435 529</b>
04907283	<b>0 444 023 064</b>

04907957	<b>0 444 023 043</b>
04909357	<b>0 445 124 008</b>
04909358	<b>0 445 124 007</b>
04913657	<b>0 445 124 022</b>
04915316	<b>0 445 124 042</b>

04915376	<b>0 445 124 043</b>
077 1355	<b>0 432 297 034</b>
08122172	<b>0 432 291 807</b>
08122172	<b>0 986 430 124</b>
08122175	<b>0 432 291 753</b>

08122175	<b>0 986 430 067</b>
08122176	<b>0 432 291 752</b>
1181 50 20 00	<b>0 432 207 006</b>
12038849	<b>0 432 291 827</b>
12136792	<b>0 432 390 019</b>

12153035	<b>0 432 287 007</b>
12153044	<b>0 432 291 029</b>
12153047	<b>0 432 291 701</b>
12153048	<b>0 432 291 731</b>
12153052	<b>0 432 291 711</b>

12153055	<b>0 432 291 686</b>
12153057	<b>0 432 291 671</b>
12153059	<b>0 432 291 645</b>
12270158	<b>0 432 291 569</b>
12270162	<b>0 432 291 573</b>

12270525	<b>0 432 291 552</b>
12272007	<b>0 460 423 002</b>
12272011	<b>0 460 424 098</b>
12272019	<b>0 460 426 220</b>
12277366	<b>0 432 131 757</b>



◀ KHD

12279517	<b>0 432 191 438</b>
12314246	<b>0 432 131 670</b>
12314694	<b>0 432 131 666</b>
12316782	<b>0 432 131 642</b>
211 1696	<b>0 432 191 539</b>

211 1697	<b>0 432 191 538</b>
211 1987	<b>0 432 191 539</b>
211 1988	<b>0 432 191 538</b>
211 2351	<b>0 432 191 411</b>
211 2380	<b>0 432 191 452</b>

211 2489	<b>0 432 191 424</b>
211 2598	<b>0 432 193 482</b>
211 2624	<b>0 432 191 373</b>
211 2625	<b>0 432 191 375</b>
211 2626	<b>0 432 191 374</b>

211 2627	<b>0 432 191 369</b>
211 2633	<b>0 432 191 376</b>
211 2634	<b>0 432 191 353</b>
211 2635	<b>0 432 191 252</b>
211 2636	<b>0 432 191 367</b>

211 2640	<b>0 432 191 377</b>
211 2644	<b>0 432 191 378</b>
211 2645	<b>0 432 191 379</b>
211 2681	<b>0 432 191 345</b>
211 2706	<b>0 414 750 004</b>

211 2707	<b>0 414 750 003</b>
211 2862	<b>0 432 191 328</b>
211 2949	<b>0 432 191 287</b>
211 2955	<b>0 432 191 325</b>
211 2957	<b>0 432 191 327</b>

211 2960	<b>0 432 191 326</b>
211 2967	<b>0 432 191 323</b>
211 2994	<b>0 432 193 498</b>
211 3000	<b>0 432 191 313</b>
211 3007	<b>0 432 191 245</b>

211 3090	<b>0 432 191 292</b>
211 3133	<b>0 432 193 486</b>
211 3547	<b>0 432 193 450</b>
211 3645	<b>0 432 193 446</b>
211 3688	<b>0 432 193 429</b>

211 3690	<b>0 432 193 430</b>
211 3775	<b>0 432 193 498</b>
212 6992	<b>0 986 430 490</b>
212 6993	<b>0 432 191 654</b>
214 5079	<b>0 432 291 807</b>

214 5079	<b>0 986 430 124</b>
214 7859	<b>0 432 291 782</b>
223 3085	<b>0 432 291 753</b>
223 3085	<b>0 986 430 067</b>
223 3272	<b>0 432 291 752</b>

293 4455	<b>0 432 237 006</b>
302 8857	<b>0 460 414 063</b>
337 2161	<b>0 432 227 027</b>
400 7565	<b>0 432 237 006</b>
401 4333	<b>0 432 191 568</b>

401 5876	<b>0 432 237 006</b>
412 3830	<b>0 445 110 559</b>
412 3831	<b>0 445 110 558</b>
412 3872	<b>0 445 110 455</b>
412 3874	<b>0 445 110 514</b>

412 3891	<b>0 445 020 518</b>
412 3934	<b>0 445 020 525</b>
413 2001	<b>0 445 110 513</b>
413 2002	<b>0 445 110 499</b>
413 2013	<b>0 445 110 560</b>

413 2014	<b>0 445 110 561</b>
413 2054	<b>0 445 110 499</b>
413 2055	<b>0 445 110 513</b>
413 2090	<b>0 445 020 519</b>
413 2378	<b>0 445 020 527</b>

414 3814	<b>0 432 291 699</b>
414 8899	<b>0 432 291 644</b>
414 9713	<b>0 432 291 633</b>
415 0926	<b>0 432 291 669</b>
415 3605	<b>0 432 191 787</b>

415 4134	<b>0 432 191 787</b>
415 4143	<b>0 432 191 787</b>
415 7216	<b>0 432 291 753</b>
415 7645	<b>0 432 191 752</b>
415 8138	<b>0 432 191 752</b>

415 8546	<b>0 432 191 752</b>
415 8546	<b>0 432 291 752</b>
417 8021	<b>0 432 191 623</b>
417 8022	<b>0 432 191 625</b>
417 8023	<b>0 432 191 624</b>

417 8024	<b>0 432 191 627</b>
417 9470	<b>0 432 193 791</b>
417 9983	<b>0 432 191 605</b>
418 4965	<b>0 432 291 644</b>
418 5578	<b>0 432 291 591</b>

418 6695	<b>0 432 291 553</b>
422 1425	<b>0 432 131 795</b>
422 4446	<b>0 432 131 696</b>
422 4523	<b>0 432 131 695</b>
422 6621	<b>0 432 131 659</b>

422 6624	<b>0 432 131 658</b>
423 0141	<b>0 432 191 712</b>
423 2066	<b>0 432 191 568</b>
423 2373	<b>0 432 291 753</b>
423 2434	<b>0 432 191 399</b>

423 2434	<b>0 432 227 035</b>
423 3015	<b>0 432 191 487</b>
423 3067	<b>0 432 191 479</b>
423 3892	<b>0 432 191 330</b>
423 4349	<b>0 432 191 312</b>

424 0720	<b>0 432 291 497</b>
424 0725	<b>0 432 291 498</b>
426 0140	<b>0 432 131 649</b>
426 0142	<b>0 432 131 648</b>
426 0506	<b>0 432 131 647</b>

426 0889	<b>0 432 131 637</b>
426 1447	<b>0 432 131 635</b>
426 1448	<b>0 432 131 638</b>
426 1449	<b>0 432 131 634</b>
426 2056	<b>0 414 755 016</b>

426 2581	<b>0 432 131 618</b>
426 2582	<b>0 432 131 619</b>
426 2583	<b>0 432 131 620</b>
426 2585	<b>0 432 131 614</b>
426 2606	<b>0 432 131 617</b>

426 3302	<b>0 432 131 613</b>
426 4634	<b>0 432 131 611</b>
426 6347	<b>0 445 124 009</b>
426 7012	<b>0 444 042 026</b>
426 7118	<b>0 445 020 234</b>

426 8478	<b>0 444 043 020</b>
426 8479	<b>0 444 043 020</b>
427 1760	<b>0 432 193 596</b>
428 0367	<b>0 432 191 399</b>
428 0368	<b>0 432 193 546</b>

428 9311	<b>0 445 120 066</b>
428 9311	<b>0 986 435 548</b>
429 0986	<b>0 445 120 066</b>
429 0986	<b>0 986 435 548</b>
429 0987	<b>0 445 120 067</b>

429 0987	<b>0 986 435 549</b>
429 0988	<b>0 445 120 065</b>
429 0988	<b>0 986 435 559</b>
450 4488	<b>0 445 120 234</b>
450 4664	<b>0 445 120 246</b>

450 4666	<b>0 445 124 001</b>
450 4666	<b>0 986 435 572</b>
451 1504	<b>0 445 120 362</b>
451 1509	<b>0 445 124 023</b>
451 4650	<b>0 445 120 424</b>

451 5158	<b>0 445 124 041</b>
451 5158	<b>0 986 435 572</b>
460 0619	<b>0 444 043 011</b>
460 0620	<b>0 444 042 019</b>
460 1049	<b>0 444 042 063</b>

460 3859	<b>0 444 042 068</b>
460 4141	<b>0 444 043 073</b>
461 1049	<b>0 444 042 063</b>
490 2255	<b>0 445 120 064</b>
490 2255	<b>0 986 435 529</b>

490 2525	<b>0 445 120 074</b>
490 2525	<b>0 986 435 536</b>
490 2825	<b>0 445 120 064</b>
490 2825	<b>0 986 435 529</b>
490 7283	<b>0 444 023 064</b>

490 7957	<b>0 444 023 043</b>
490 9357	<b>0 445 124 008</b>
490 9358	<b>0 445 124 007</b>
491 3657	<b>0 445 124 022</b>
491 5316	<b>0 445 124 042</b>

491 5376	<b>0 445 124 043</b>
812 2172	<b>0 432 291 807</b>
812 2172	<b>0 986 430 124</b>
812 2175	<b>0 432 291 753</b>
812 2175	<b>0 986 430 067</b>

812 2176	<b>0 432 291 752</b>
----------	----------------------

<b>KIA</b>	
OK0AA 13210	<b>0 280 218 092</b>
OK011 13210B	<b>0 280 217 105</b>
OK551 13640	<b>0 432 193 655</b>

OK59A 13800	<b>0 460 414 207</b>
OK9A2 13210	<b>0 280 217 116</b>
OK937 13210	<b>0 280 202 125</b>
28100 2Y100	<b>0 280 218 106</b>
28100 39450	<b>0 280 218 090</b>

28164 2A401	<b>0 281 002 723</b>
28164 27000	<b>0 281 002 447</b>
28164 27050	<b>0 281 002 669</b>
28164 27800	<b>0 281 002 721</b>
28164 27900	<b>0 281 002 600</b>

28164 38080	<b>0 280 218 020</b>
28164 38080	<b>0 280 218 106</b>
28164 4A000	<b>0 281 002 554</b>
33100 2A400	<b>0 445 010 289</b>
33100 2A420	<b>0 445 010 290</b>

33100 2A420	<b>0 986 437 042</b>
33100 2F000	<b>0 445 010 544</b>
33100 2F000	<b>0 986 437 431</b>
33100 2F600	<b>0 445 010 597</b>
33100 2F600	<b>0 986 437 444</b>

33100 2F610	<b>0 445 010 740</b>
33100 2F610	<b>0 986 437 444</b>
33100 27000	<b>0 445 010 279</b>
33100 3A000	<b>0 445 010 347</b>
33100 4A000	<b>0 445 010 354</b>

33100 4A410	<b>0 445 010 399</b>
33100 4A410	<b>0 986 437 029</b>
33100 4A420	<b>0 445 010 333</b>
33800 2A100	<b>0 445 110 222</b>
33800 2A800	<b>0 445 110 410</b>

33800 2A800	<b>0 986 435 279</b>
33800 2F000	<b>0 445 116 017</b>
33800 2F000	<b>0 986 435 420</b>
33800 27400	<b>0 445 110 257</b>
33800 27400	<b>0 986 435 156</b>

33800279002Y	<b>0 445 110 290</b>
33800279002Y	<b>0 986 435 174</b>
33800 3A000	<b>0 445 115 045</b>
33800 3A000	<b>0 986 435 391</b>
33800 4A000	<b>0 986 435 154</b>



33800 4A000X	<b>0 986 435 154</b>
33800 4A000Y	<b>0 986 435 154</b>
33800 4A000Z	<b>0 986 435 154</b>
33800 4A170	<b>0 986 435 154</b>
33800 4A500	<b>0 445 110 274</b>

33800 4A500	<b>0 986 435 180</b>
-------------	----------------------

### KIA MOTORS SLOVAKIA

28164 2A401	<b>0 281 002 723</b>
28164 27800	<b>0 281 002 721</b>

33100 2A400	<b>0 445 010 289</b>
33100 2A400	<b>0 986 437 030</b>
33100 2A600	<b>0 986 437 447</b>
33100 27400	<b>0 445 010 342</b>
33100 27400	<b>0 986 437 354</b>

### KNECHT

06513170	<b>0 280 218 141</b>
06617047	<b>0 280 218 169</b>
09637190	<b>0 280 218 009</b>

70309037	<b>0 280 218 198</b>
70309048	<b>0 280 218 192</b>
70363230	<b>0 280 218 234</b>
70363231	<b>0 280 218 230</b>
76513170	<b>0 280 218 141</b>

79637190	<b>0 280 218 009</b>
----------	----------------------

### KOBELCO CONSTRUCTION MACHINERY

0986AM0065	<b>0 445 120 126</b>
------------	----------------------

### KOMATSU

F01GOV4002	<b>9 430 613 758</b>
RM6271-71-1110	<b>0 986 437 082</b>
RM6745-11-3102	<b>0 986 435 522</b>

RM6754-11-3012	<b>0 986 435 597</b>
1G06553004	<b>F 01G 09X 070</b>
3863102	<b>9 430 613 451</b>
4989266	<b>0 445 020 109</b>
4989266	<b>0 986 437 375</b>

5254261	<b>0 445 120 177</b>
5256607	<b>0 445 020 122</b>
5256607	<b>0 986 437 310</b>
5262703	<b>0 445 020 176</b>
5263305	<b>0 445 120 272</b>

5268436	<b>0 445 120 305</b>
5273750	<b>0 445 120 328</b>
6114-11-3200	<b>9 430 610 456</b>
6127-11-3104	<b>9 430 611 278</b>
6127113201	<b>9 430 611 260</b>

6128 11 3100	<b>9 430 610 845</b>
6130113501	<b>9 430 611 306</b>
6131113300	<b>9 430 611 302</b>
6131113500	<b>9 430 610 732</b>
6131123700	<b>9 430 610 781</b>

6136-11-3100	<b>9 430 610 778</b>
6136-12-3200	<b>9 430 610 080</b>
6137-12-3100	<b>9 430 610 097</b>
6138-11-3101	<b>9 430 610 844</b>
6138123100	<b>9 430 610 972</b>

6138123300	<b>9 430 610 990</b>
6142123300	<b>9 430 610 459</b>
6151113100	<b>9 430 612 034</b>
6151-11-3101	<b>9 430 610 110</b>
6152113100	<b>9 430 612 035</b>

6152113101	<b>9 430 612 938</b>
6152113200	<b>9 430 612 056</b>
6152113300	<b>9 430 612 058</b>
6152153900	<b>F 01G 09X 06P</b>
6161113100	<b>9 430 612 059</b>

6162133100	<b>9 430 612 030</b>
6162133101	<b>9 430 612 939</b>
6162133200	<b>9 430 612 036</b>
6162133201	<b>9 430 612 038</b>
6162133300	<b>9 430 612 032</b>

6162133302	<b>9 430 612 033</b>
6162133303	<b>9 430 613 651</b>
6162133400	<b>9 430 612 040</b>
6162133401	<b>9 430 612 049</b>
6162133402	<b>9 430 612 051</b>

6162133500	<b>9 430 612 041</b>
6162133501	<b>9 430 612 048</b>
6162133502	<b>9 430 612 042</b>
6162133700	<b>9 430 612 052</b>
6162133801	<b>9 430 612 067</b>

6162133900	<b>9 430 612 057</b>
6162133901	<b>9 430 612 085</b>
6162133902	<b>9 430 612 087</b>
6162137300	<b>9 430 612 881</b>
6162137302	<b>9 430 612 880</b>

6162137500	<b>9 430 612 092</b>
6162137501	<b>9 430 612 883</b>
6162137502	<b>9 430 612 884</b>
6162137600	<b>9 430 612 080</b>
6162137601	<b>9 430 612 902</b>

6162137700	<b>9 430 612 075</b>
6162137701	<b>9 430 612 083</b>
6162137702	<b>9 430 612 084</b>
6162137900	<b>9 430 612 107</b>
6162138100	<b>9 430 612 867</b>

6162138900	<b>9 430 612 138</b>
6162138901	<b>9 430 612 870</b>
6162143100	<b>9 430 612 118</b>
6162143300	<b>9 430 612 886</b>
6162143301	<b>9 430 613 658</b>

6162143400	<b>9 430 612 132</b>
6162143401	<b>9 430 612 871</b>
6162143700	<b>9 430 612 105</b>
6162147300	<b>9 430 612 129</b>
6162147500	<b>9 430 612 130</b>

6162147600	<b>9 430 612 139</b>
6162-15-3300	<b>9 430 612 128</b>
6162-15-3301	<b>9 430 613 791</b>
6162153500	<b>9 430 612 137</b>
6164113100	<b>9 430 612 063</b>

6164113101	<b>9 430 612 065</b>
6165113200	<b>9 430 612 076</b>
6165113300	<b>9 430 612 089</b>
6165113301	<b>9 430 612 091</b>
6165113400	<b>9 430 612 112</b>

6166113100	<b>9 430 612 111</b>
6166133101	<b>9 430 612 876</b>
6166133102	<b>9 430 613 560</b>
6166153100	<b>9 430 612 872</b>
6167113500	<b>9 430 612 074</b>

6167113600	<b>9 430 612 108</b>
6202-12-3100	<b>9 430 610 358</b>
6202-12-3300	<b>9 430 610 388</b>
6202133300	<b>9 430 612 474</b>
6202721311	<b>9 460 611 109</b>

6205-11-3100	<b>9 430 610 184</b>
6206-11-3100	<b>9 430 610 068</b>
6206711163	<b>9 460 610 767</b>
6206-71-1171	<b>9 460 610 439</b>
6206-71-1191	<b>9 460 610 321</b>

6206731161	<b>9 460 610 768</b>
6207-11-3100	<b>9 430 612 390</b>
6207113101	<b>9 430 613 309</b>
6207711111	<b>9 460 610 766</b>
6207711113	<b>9 460 610 715</b>

6211113500	<b>9 430 612 113</b>
6211-12-3500	<b>9 430 612 124</b>
6212113200	<b>9 430 612 055</b>
6212113701	<b>9 430 612 102</b>
6212123100	<b>9 430 612 125</b>

6212-12-3200	<b>9 430 612 126</b>
6212123400	<b>9 430 613 517</b>
6215113200	<b>9 430 612 082</b>
6215113900	<b>9 430 613 566</b>
6222113300	<b>9 430 612 603</b>

6271 11 3100	<b>0 445 110 307</b>
6271 11 3100	<b>0 986 435 196</b>
6271 71 1110	<b>0 445 020 070</b>
6271 71 1110	<b>0 986 437 082</b>
6274113100	<b>F 01G 09X 06V</b>

6354113300	<b>9 430 612 640</b>
6540711110	<b>0 444 043 049</b>
6540712110	<b>0 444 042 070</b>
6540712510	<b>0 444 042 105</b>
6738113200	<b>9 430 613 733</b>

6745-11-3102	<b>0 986 435 522</b>
6745-12-3100	<b>0 445 120 236</b>
6746113100	<b>0 445 120 305</b>
6754-11-3011	<b>0 445 120 059</b>
6754-11-3011	<b>0 445 120 231</b>

6754-11-3012	<b>0 986 435 597</b>
6754-71-1012	<b>0 445 020 122</b>
6754-72-1012	<b>0 445 020 109</b>
6754-72-1012	<b>0 986 437 310</b>

### KUBOTA

1G06553001	<b>9 430 613 542</b>
1G12153001	<b>9 430 610 331</b>
1G41453001	<b>9 430 613 756</b>

1G67753004	<b>F 01G 09X 071</b>
1G72053001	<b>9 430 613 741</b>
1G73053001	<b>9 430 613 740</b>
1G79053001	<b>9 430 613 748</b>
1G79053002	<b>9 430 613 747</b>

1G79653001	<b>9 430 613 805</b>
1G79653003	<b>9 430 613 969</b>
1G86153001	<b>9 430 613 804</b>
1G91153001	<b>9 430 613 069</b>
1G91153002	<b>9 430 613 070</b>

1G91153003	<b>9 430 613 742</b>
1G91853002	<b>9 430 613 968</b>
1G92453002	<b>9 430 613 893</b>
1J73053002	<b>F 01G 09X 05G</b>
1J80050502	<b>0 445 020 187</b>

1J80053051	<b>0 445 110 428</b>
1J800 53052	<b>0 445 110 781</b>
1J80150501	<b>0 445 020 200</b>
1J80153051	<b>0 445 110 505</b>
1J801 53052	<b>0 445 110 777</b>

1J808 53052	<b>0 445 110 775</b>
1T15653001	<b>F 01G 09X 06X</b>
10B-28/29	<b>9 430 082 227</b>
1212703200	<b>9 430 610 883</b>
1212704200	<b>9 430 610 881</b>

1212705200	<b>9 430 612 961</b>
1212707200	<b>9 430 611 351</b>
1407053001	<b>9 430 612 981</b>
1418153001	<b>9 430 610 899</b>
1418153002	<b>9 430 610 901</b>

1432704200	<b>9 430 612 025</b>
1432718200	<b>9 430 612 940</b>
1437153001	<b>9 430 610 933</b>
1439153001	<b>9 430 610 935</b>
1452705200	<b>9 430 611 784</b>



◀ KUBOTA

1452706200	<b>9 430 611 786</b>
1494153001	<b>9 430 611 996</b>
1494153004	<b>9 430 612 944</b>
1532701200	<b>9 430 612 026</b>
16032 5300 1	<b>9 430 610 426</b>

1603253002	<b>F 01G 09X 06Z</b>
1912953001	<b>9 430 610 862</b>
1951753001	<b>9 430 611 045</b>
2012707200	<b>9 430 612 159</b>
22B-136	<b>9 430 082 302</b>

60B-32	<b>9 430 082 331</b>
7B-32B/33	<b>9 430 082 211</b>
7B-32B/33	<b>9 430 082 330</b>

**KUNMING YUNNEI POWER**

HA11003	<b>0 445 025 033</b>
HA1207 JS24	<b>0 445 025 017</b>

X0 445 010 186	<b>0 445 010 186</b>
----------------	----------------------

**LANCIA**

K68157223AA	<b>0 445 010 689</b>
0000046441787	<b>0 281 002 160</b>
46407008	<b>0 280 217 111</b>

46416748	<b>0 280 217 514</b>
464302102	<b>0 986 435 001</b>
46441787	<b>0 281 002 160</b>
46444287	<b>0 280 217 531</b>
46444287	<b>0 986 280 233</b>

46447503	<b>0 986 280 236</b>
46461616	<b>0 432 217 296</b>
46461617	<b>0 432 217 297</b>
464629710	<b>0 986 435 001</b>
464649280	<b>0 280 217 102</b>

46469917	<b>0 986 280 234</b>
46472233	<b>0 986 435 001</b>
46472711	<b>0 460 484 126</b>
46522786	<b>0 986 437 001</b>
46522787	<b>0 445 010 007</b>

46522787	<b>0 986 437 002</b>
46533308	<b>0 986 280 235</b>
46541253	<b>0 986 280 236</b>
46547897	<b>0 986 435 006</b>
46552161	<b>0 460 484 154</b>

46554997	<b>0 460 484 083</b>
46559804	<b>0 281 002 309</b>
46749246	<b>0 280 218 054</b>
46749246	<b>0 986 280 238</b>
46779630	<b>0 986 437 023</b>

46784582	<b>0 281 002 613</b>
46787376	<b>0 445 110 068</b>
46811229	<b>0 445 010 006</b>
46811230	<b>0 445 010 007</b>
46811230	<b>0 986 437 002</b>

46824377	<b>0 281 002 598</b>
4750504	<b>0 432 281 704</b>
4792992	<b>0 986 440 023</b>
4794588	<b>0 986 440 024</b>
4800029	<b>0 432 291 655</b>

4803490	<b>0 460 416 042</b>
4810522	<b>0 432 291 648</b>
4810552	<b>0 432 291 648</b>
4812995	<b>0 986 440 028</b>
4814197	<b>0 986 440 027</b>

4820872	<b>0 986 440 076</b>
4830159	<b>0 986 440 032</b>
500305724	<b>0 986 440 163</b>
504095664	<b>0 445 020 046</b>
504095664	<b>0 986 437 321</b>

504377671	<b>0 445 110 273</b>
51774531	<b>0 281 002 613</b>
51782034	<b>0 281 002 980</b>
51782035	<b>0 281 002 860</b>
51782035	<b>0 281 002 917</b>

51792729	<b>0 280 218 237</b>
51827033	<b>0 281 006 048</b>
51830368	<b>0 280 218 242</b>
51831050	<b>0 281 006 054</b>
55183650	<b>0 281 002 792</b>

55184536	<b>0 445 110 083</b>
55184536	<b>0 986 435 078</b>
55187290	<b>0 445 110 119</b>
55187290	<b>0 986 435 083</b>
55187291	<b>0 445 110 119</b>

55187291	<b>0 986 435 083</b>
55192096	<b>0 445 110 083</b>
55192096	<b>0 986 435 078</b>
55192534	<b>0 445 110 111</b>
55192534	<b>0 986 435 081</b>

55192579	<b>0 445 110 187</b>
55192579	<b>0 986 435 099</b>
55192948	<b>0 445 110 119</b>
55192948	<b>0 986 435 083</b>
55193049	<b>0 280 218 054</b>

55193049	<b>0 986 280 238</b>
55193808	<b>0 445 110 111</b>
55193808	<b>0 986 435 081</b>
55197124	<b>0 445 110 183</b>
55197124	<b>0 986 435 102</b>

55198219	<b>0 445 110 213</b>
55198219	<b>0 986 435 162</b>
55198519	<b>0 445 010 123</b>
55198519	<b>0 445 010 285</b>
55198519	<b>0 445 010 349</b>

55204429	<b>0 445 010 123</b>
55204429	<b>0 445 010 285</b>
55204429	<b>0 445 010 349</b>
55206489	<b>0 445 010 293</b>
55206489	<b>0 986 437 036</b>

55206704	<b>0 445 110 300</b>
55206704	<b>0 986 435 171</b>
55209062	<b>0 445 010 185</b>
55209382	<b>0 445 110 299</b>
55209382	<b>0 986 435 230</b>

55214192	<b>0 445 110 322</b>
55217235	<b>0 445 110 213</b>
55217235	<b>0 986 435 162</b>
55219886	<b>0 445 110 351</b>
55219886	<b>0 986 435 204</b>

55221018	<b>0 445 110 187</b>
55221018	<b>0 986 435 099</b>
55221023	<b>0 445 110 300</b>
55221023	<b>0 986 435 171</b>
55221024	<b>0 445 110 299</b>

55221024	<b>0 986 435 230</b>
55222114	<b>0 445 010 071</b>
55230348	<b>0 445 010 292</b>
55234362	<b>0 445 010 302</b>
55234362	<b>0 445 010 305</b>

55234362	<b>0 986 437 094</b>
55234364	<b>0 445 010 308</b>
55234364	<b>0 445 010 309</b>
55236707	<b>0 445 010 265</b>
55236707	<b>0 445 010 425</b>

55236707	<b>0 986 437 097</b>
55237687	<b>0 445 010 308</b>
55237687	<b>0 445 010 309</b>
55237690	<b>0 445 010 310</b>
55237690	<b>0 986 437 038</b>

55246223	<b>0 445 110 524</b>
55246223	<b>0 986 435 280</b>
55255406	<b>0 445 110 614</b>
55255406	<b>0 986 435 249</b>
55255416	<b>0 445 010 425</b>

55255416	<b>0 986 437 097</b>
55263525	<b>0 445 010 463</b>
55350048	<b>0 281 002 683</b>
5801540211	<b>0 445 116 059</b>
5801594342	<b>0 445 110 520</b>

60534838	<b>0 280 202 105</b>
60579400	<b>0 280 202 212</b>
60588419	<b>0 280 217 106</b>
60589472	<b>0 280 217 503</b>
60663029	<b>0 280 218 036</b>

60663029	<b>0 986 280 237</b>
60802028	<b>0 280 218 113</b>
60802028	<b>0 986 280 239</b>
6080915	<b>0 280 202 212</b>
60810813	<b>0 280 217 111</b>

6081145	<b>0 280 217 514</b>
60814750	<b>0 445 010 007</b>
60814750	<b>0 986 437 002</b>
60814852	<b>0 986 280 236</b>
60814977	<b>0 445 010 006</b>

60815616	<b>0 280 217 531</b>
60815616	<b>0 986 280 233</b>
60816693	<b>0 280 218 054</b>
60816693	<b>0 986 280 238</b>
68211302AA	<b>0 445 110 522</b>

71788020	<b>0 986 280 234</b>
73501003	<b>0 445 010 072</b>
73501013	<b>0 445 010 071</b>
73501139	<b>0 445 110 119</b>
73501139	<b>0 986 435 083</b>

73503097	<b>0 445 110 111</b>
73503097	<b>0 986 435 081</b>
7553412	<b>0 280 202 081</b>
7555128	<b>0 280 200 051</b>
7612319	<b>0 280 202 115</b>

7612320	<b>0 986 280 115</b>
76450720	<b>0 432 217 202</b>
7648065	<b>0 986 280 114</b>
7662850	<b>0 432 217 273</b>
76628500	<b>0 432 217 211</b>

7706073	<b>0 280 202 128</b>
7711878	<b>0 280 212 024</b>
77118780	<b>0 986 280 123</b>
771354	<b>0 432 297 034</b>
7735577	<b>0 460 484 051</b>

7763718	<b>0 280 217 106</b>
7767750	<b>0 281 002 185</b>
7778146	<b>0 432 217 274</b>
7778146	<b>0 986 430 525</b>
7778147	<b>0 432 217 273</b>

7778470	<b>0 432 217 273</b>
8122175	<b>0 986 430 067</b>
8122176	<b>0 432 291 752</b>
9456182380	<b>0 986 435 003</b>
95400103	<b>0 445 110 002</b>

95400103	<b>0 986 435 001</b>
9627663980	<b>0 445 010 021</b>
9627663980	<b>0 986 437 012</b>
9632887980	<b>0 460 494 455</b>
9638444780	<b>0 445 110 036</b>

9638444780	<b>0 986 435 014</b>
9638444880	<b>0 445 110 036</b>
9638444880	<b>0 986 435 014</b>
9638444980	<b>0 445 110 036</b>
9638444980	<b>0 986 435 014</b>

9642166980	<b>0 986 437 017</b>
9653345780	<b>0 445 110 036</b>
9653345780	<b>0 986 435 014</b>
9653345880	<b>0 445 110 036</b>
9653345880	<b>0 986 435 014</b>



9653345980	<b>0 445 110 036</b>
9653345980	<b>0 986 435 014</b>
9659228880	<b>0 445 115 025</b>
9659228880	<b>0 445 115 092</b>
9659228880	<b>0 986 435 450</b>

9683268980	<b>0 986 437 034</b>
98420738	<b>0 432 191 741</b>

**LAND ROVER GROUP**

AH4Q9K546BA	<b>0 986 435 429</b>
CH2Q 9K546 AA	<b>0 445 116 050</b>
ERR 3339	<b>0 432 193 835</b>

ERR 4419	<b>0 460 414 098</b>
ERR 4419	<b>0 986 440 038</b>
ERR 5634	<b>0 460 404 973</b>
ERR 5634	<b>0 986 440 507</b>
ETC 8412	<b>0 432 193 879</b>

LR 001325	<b>0 445 115 042</b>
LR 001325	<b>0 445 115 091</b>
LR 001325	<b>0 986 435 362</b>
LR006864	<b>0 986 435 362</b>
LR 013180	<b>0 986 437 432</b>

LR014205	<b>0 986 435 403</b>
LR 017923	<b>0 445 116 012</b>
LR 017923	<b>0 445 116 064</b>
LR019605	<b>0 986 437 432</b>
LR022335	<b>0 986 435 423</b>

LR022971	<b>0 445 010 666</b>
LR023597	<b>0 986 437 432</b>
LR027564	<b>0 986 437 432</b>
LR030432	<b>0 445 010 298</b>
LR031849	<b>0 445 116 070</b>

LR041034	<b>0 986 437 432</b>
LR047217	<b>0 445 010 298</b>
LR056366	<b>0 986 435 423</b>
LR056367	<b>0 445 116 070</b>
LR058160	<b>0 986 437 432</b>

LR061984	<b>0 445 010 697</b>
LR063300	<b>0 445 116 060</b>
LR065508	<b>0 986 XJ4 423</b>
LR073700	<b>0 445 010 705</b>
LR073700	<b>0 445 010 771</b>

LR073700	<b>0 986 437 462</b>
LR073710	<b>0 445 110 653</b>
LR078606	<b>0 445 117 052</b>
LR078840	<b>0 445 010 832</b>
LR078840	<b>0 986 437 432</b>

LR079958	<b>0 445 010 820</b>
LR082271	<b>0 445 010 753</b>
LR082276	<b>0 445 110 700</b>
LR084743	<b>F 01C 600 271</b>
LR095361	<b>0 445 116 064</b>

LR117056	<b>0 445 110 663</b>
MHK100800	<b>0 280 218 010</b>
MHK 1008 50	<b>0 281 002 182</b>
MHK101130L	<b>0 928 400 520</b>
MSC 1006 10	<b>0 432 193 700</b>

MSC 1006 20	<b>0 432 193 701</b>
MSR 0000 10	<b>0 445 010 009</b>
MSR 0000 10	<b>0 986 437 004</b>
MSR 1003 20	<b>0 445 010 011</b>
MSR 1003 20	<b>0 986 437 006</b>

02AJ811887	<b>0 986 437 034</b>
------------	----------------------

**LDV GROUP LIMITED**

510990024	<b>0 445 110 059</b>
-----------	----------------------

**LEX LOGISTICS**

524990003	<b>0 281 002 918</b>
-----------	----------------------

**LEYLAND**

ETC 8412	<b>0 432 193 879</b>
----------	----------------------

**LIEBHERR**

101 162 57	<b>0 414 755 018</b>
101 162 57	<b>0 414 755 118</b>
101 165 87	<b>0 432 191 247</b>

101 171 68	<b>0 445 120 128</b>
101 178 14	<b>0 445 020 081</b>
104 900 18	<b>0 445 120 196</b>
500 49 03	<b>0 432 191 577</b>
550 730 608	<b>0 432 231 658</b>

560 427 608	<b>0 432 231 659</b>
570 865 408	<b>0 432 231 663</b>
907 46 27	<b>0 414 755 017</b>
907 66 83	<b>0 460 424 294</b>
908 07 11	<b>0 432 191 233</b>

926 87 68	<b>0 432 291 606</b>
927 02 80	<b>0 432 291 585</b>
927 13 19	<b>0 432 291 568</b>
927 39 37	<b>0 432 291 540</b>
927 55 38	<b>0 432 191 541</b>

927 79 35	<b>0 432 191 542</b>
927 79 35	<b>0 432 191 618</b>
927 96 09	<b>0 432 191 591</b>
927 98 32	<b>0 432 191 577</b>
930 101 911	<b>0 432 191 502</b>

988 16 17	<b>0 460 424 158</b>
988 34 29	<b>0 432 191 502</b>
988 73 49	<b>0 432 191 358</b>
988 81 83	<b>0 432 191 403</b>

**LOMBARDINI**

5010 090 0	<b>0 445 110 309</b>
5010 094 0	<b>0 445 110 309</b>
644R 030 0	<b>0 432 193 887</b>

644R 040 0	<b>0 432 291 657</b>
644R 056 0	<b>0 432 193 883</b>
644R 065 0	<b>0 432 193 870</b>
6615 031 0	<b>0 432 291 624</b>
6615 045 0	<b>0 432 291 642</b>

**LOTUS**

A116E6059F	<b>0 280 218 051</b>
A116E6059F	<b>0 986 280 231</b>

**LOVOL**

T832360008	<b>0 445 120 264</b>
------------	----------------------

**LUCAS**

73173B	<b>0 280 202 008</b>
--------	----------------------

**MACK (TRUCKS)**

114 GC 322	<b>0 432 191 757</b>
21332701	<b>0 444 042 009</b>
21332711	<b>0 444 043 004</b>

21577030	<b>0 444 043 004</b>
21577511	<b>0 986 44D 124</b>
21577511	<b>0 986 44D 200</b>
21647139	<b>0 444 042 032</b>
21647139	<b>0 986 44D 200</b>

21687111	<b>0 444 022 042</b>
21738138	<b>0 444 023 053</b>
21832485	<b>0 444 042 048</b>
21832485	<b>0 444 042 058</b>
21832553	<b>0 444 042 052</b>

21911396	<b>0 444 022 047</b>
21966586	<b>0 444 022 052</b>
22169012	<b>0 444 022 059</b>
313 GC 5222 M	<b>0 414 755 003</b>
313 GC 5222 M	<b>0 986 445 001</b>

313 GC 5227 M	<b>0 414 755 003</b>
313 GC 5227 M	<b>0 986 445 001</b>
313 GC 5230 M	<b>0 986 445 008</b>
313 GC 5230 MX	<b>0 414 755 006</b>
313 GC 5230 MX	<b>0 986 445 008</b>

313 GC 5233 MX	<b>0 414 755 014</b>
5000592825	<b>0 432 281 695</b>
5000592825	<b>0 986 430 342</b>
5000676305	<b>0 432 231 741</b>
5000676305	<b>0 986 430 344</b>

5000684559	<b>0 432 133 880</b>
5000691504	<b>0 432 133 870</b>
5000785794	<b>0 432 291 710</b>
5000785794	<b>0 986 430 141</b>
5000785794	<b>0 986 430 333</b>

5000789576	<b>0 432 291 672</b>
5000789576	<b>0 986 430 336</b>
736 GB 337 P 7	<b>0 432 191 757</b>
736 GB 338 P 2	<b>0 432 191 757</b>
736 GB 343 P12	<b>0 432 193 796</b>

736 GB 343 P13	<b>0 432 193 770</b>
736 GB 343 P 7	<b>0 432 193 833</b>
736 GB 346	<b>0 432 191 649</b>
736 GB 410 M	<b>0 432 193 539</b>
736 GB 410 M 3	<b>0 432 193 540</b>

736 GB 411 M 2	<b>0 432 193 516</b>
736 GB 412 M	<b>0 432 193 505</b>
736 GB 412 M 2	<b>0 432 193 506</b>
736 GB 412 M 3	<b>0 432 193 507</b>
736 GB 414 M	<b>0 432 193 502</b>

736 GB 414 M 2	<b>0 432 193 503</b>
736 GB 414 M 3	<b>0 432 193 504</b>
736 GB 415 M	<b>0 432 191 320</b>
736 GB 415 M 2	<b>0 432 191 319</b>
736 GB 418 M	<b>0 432 193 492</b>

736 GB 418 M 2	<b>0 432 193 493</b>
736 GB 419 M	<b>0 432 191 289</b>
736 GB 419 M 2	<b>0 432 191 290</b>
736 GB 419 M 3	<b>0 432 191 291</b>
736 GB 420 M	<b>0 432 191 283</b>

736 GB 420 M 3	<b>0 432 191 284</b>
736 GB 421 M	<b>0 432 191 274</b>
736 GB 421 M 2	<b>0 432 191 273</b>
736 GB 421 M 3	<b>0 432 191 272</b>
736 GB 48M3	<b>0 432 193 671</b>

736 GB 48M4	<b>0 432 193 672</b>
736 GB 49B M 3	<b>0 432 193 528</b>
736 GB 49B M 4	<b>0 432 193 529</b>
736 GC 49M3	<b>0 432 193 671</b>
85003864	<b>0 986 44D 200</b>

**MAGIRUS-DEUTZ**

0426 8478	<b>0 444 043 020</b>
04290988	<b>0 986 435 559</b>
0450 3240	<b>0 445 120 234</b>

0450 4664	<b>0 445 120 246</b>
0460 0619	<b>0 444 043 011</b>
0460 0620	<b>0 444 042 019</b>
0460 4141	<b>0 444 043 073</b>
0461 1049	<b>0 444 042 063</b>



◀ MAGIRUS-DEUTZ

211 3007	<b>0 432 191 245</b>
423 4349	<b>0 432 191 312</b>
426 2056	<b>0 414 755 016</b>
426 2582	<b>0 432 131 619</b>
426 2583	<b>0 432 131 620</b>
429 0988	<b>0 445 120 065</b>
490 2825	<b>0 445 120 064</b>
490 2825	<b>0 986 435 529</b>
6131 6337	<b>0 432 191 818</b>
812 2176	<b>0 432 291 752</b>

**MAHINDRA**

006005524F1	<b>0 460 423 040</b>
006005526F1	<b>0 460 423 038</b>
006025718D91	<b>0 444 021 065</b>

0305BAV00180N	<b>0 445 120 167</b>
0305BB0671N	<b>0 460 414 251</b>
0305BB0721N	<b>0 460 414 254</b>
0305BB1031N	<b>0 445 110 342</b>
0305BC0371N	<b>0 445 010 420</b>

0305BC0401N	<b>0 445 110 260</b>
0305BM0071N	<b>0 445 110 310</b>
0305BM0071N	<b>0 986 435 296</b>
0305BM0220N	<b>0 445 010 240</b>
0305CAV00070N	<b>0 445 120 421</b>

0305CAV00130N	<b>0 445 120 421</b>
0305HAV01400N	<b>0 445 025 616</b>
0315CAB00061N	<b>0 281 006 110</b>
0315CC0031N	<b>0 281 002 756</b>
16735	<b>0 445 020 513</b>

32G61-00300	<b>0 445 020 083</b>
-------------	----------------------

**MALAGUTI**

313GC5227MX	<b>0 986 445 004</b>
-------------	----------------------

**MAN**

R1588-1416	<b>0 986 435 562</b>
07W130105	<b>0 445 020 075</b>
07W130105A	<b>0 445 020 208</b>

11 22103 0106	<b>F 00B LOJ 043</b>
2V5 131113 A	<b>0 444 011 025</b>
3005063C1	<b>0 445 020 080</b>
3005063C1	<b>0 986 437 358</b>
51 09413 7001	<b>0 281 002 421</b>

51 09413 7002	<b>0 281 002 421</b>
51 10100 4043	<b>0 986 435 527</b>
51 10100 6016	<b>0 986 435 527</b>
51 10100 6022	<b>0 432 131 639</b>
51 10100 6026	<b>0 445 120 031</b>

51 10100 6026	<b>0 986 435 617</b>
51 10100 6027	<b>0 986 435 527</b>
51 10100 6028	<b>0 432 131 631</b>
51 10100 6028	<b>0 432 131 721</b>
51 10100 6029	<b>0 432 131 633</b>

51 10100 6030	<b>0 432 131 629</b>
51 10100 6031	<b>0 432 131 628</b>
51 10100 6032	<b>0 445 120 030</b>
51 10100 6033	<b>0 432 191 309</b>
51 10100 6035	<b>0 445 120 030</b>

51 10100 6036	<b>0 432 191 414</b>
51 10100 6037	<b>0 432 191 417</b>
51 10100 6038	<b>0 432 191 415</b>
51 10100 6039	<b>0 432 191 418</b>
51 10100 6040	<b>0 432 191 420</b>

51 10100 6041	<b>0 432 191 309</b>
51 10100 6043	<b>0 986 435 527</b>
51 10100 6046	<b>0 432 131 622</b>
51 10100 6047	<b>0 445 120 053</b>
51 10100 6047	<b>0 986 435 670</b>

51 10100 6048	<b>0 445 120 030</b>
51 10100 6048	<b>0 986 435 517</b>
51 10100 6049	<b>0 445 120 044</b>
51 10100 6049	<b>0 986 435 527</b>
51 10100 6050	<b>0 445 120 045</b>

51 10100 6050	<b>0 986 435 558</b>
51 10100 6051	<b>0 445 120 055</b>
51 10100 6051	<b>0 986 435 671</b>
51 10100 6056	<b>0 445 120 056</b>
51 10100 6056	<b>0 986 435 672</b>

51 10100 6058	<b>0 445 120 068</b>
51 10100 6058	<b>0 986 435 640</b>
51 10100 6060	<b>0 432 191 249</b>
51 10100 6061	<b>0 432 191 250</b>
51 10100 6063	<b>0 445 120 105</b>

51 10100 6064	<b>0 445 120 061</b>
51 10100 6064	<b>0 986 435 526</b>
51 10100 6065	<b>0 445 120 098</b>
51 10100 6065	<b>0 986 435 562</b>
51 10100 6066	<b>0 445 120 045</b>

51 10100 6066	<b>0 986 435 558</b>
51 10100 6070	<b>0 445 120 099</b>
51 10100 6071	<b>0 432 133 766</b>
51 10100 6079	<b>0 445 120 100</b>
51 10100 6079	<b>0 986 435 528</b>

51 10100 6082	<b>0 432 133 765</b>
51 10100 6083	<b>0 445 120 162</b>
51 10100 6083	<b>0 986 435 565</b>
51 10100 6085	<b>0 445 120 147</b>
51 10100 6085	<b>0 986 435 562</b>

51 10100 6086	<b>0 445 120 148</b>
51 10100 6086	<b>0 986 435 563</b>
51 10100 6090	<b>0 445 120 203</b>
51 10100 6090	<b>0 986 435 658</b>
51 10100 6091	<b>0 445 120 131</b>

51 10100 6102	<b>0 445 120 154</b>
51 10100 6114	<b>0 445 120 131</b>
51 10100 6114	<b>0 986 435 561</b>
51 10100 6115	<b>0 445 120 186</b>
51 10100 6115	<b>0 986 435 568</b>

51 10100 6121	<b>0 445 120 202</b>
51 10100 6121	<b>0 986 435 570</b>
51 10100 6123	<b>0 445 120 197</b>
51 10100 6123	<b>0 986 435 569</b>
51 10100 6124	<b>0 445 120 220</b>

51 10100 6125	<b>0 445 120 218</b>
51 10100 6125	<b>0 986 435 517</b>
51 10100 6126	<b>0 445 120 061</b>
51 10100 6126	<b>0 445 120 217</b>
51 10100 6126	<b>0 986 435 526</b>

51 10100 6127	<b>0 445 120 100</b>
51 10100 6127	<b>0 445 120 219</b>
51 10100 6127	<b>0 986 435 528</b>
51 10100 6128	<b>0 445 120 201</b>
51 10100 6128	<b>0 986 435 656</b>

51 10100 6131	<b>0 445 120 203</b>
51 10100 6131	<b>0 986 435 658</b>
51 10100 6140	<b>0 445 120 276</b>
51 10100 6154	<b>0 445 120 313</b>
51 10100 6155	<b>0 445 120 311</b>

51 10100 6169	<b>0 986 435 592</b>
51 10100 6180	<b>0 445 120 354</b>
51 10100 6180	<b>0 986 435 650</b>
51 10100 6181	<b>0 445 120 353</b>
51 10100 6181	<b>0 986 435 593</b>

51 10100 6184	<b>0 445 120 355</b>
51 10100 6189	<b>0 445 124 024</b>
51.10100-6191	<b>0 445 120 420</b>
51 10100 6191	<b>0 986 435 660</b>
51 10100 6195	<b>0 445 124 052</b>

51 10100 7274	<b>0 432 231 778</b>
51 10100 7290	<b>0 432 231 765</b>
51 10100 7363	<b>0 432 131 788</b>
51 10100 7363	<b>0 986 430 312</b>
51 10100 7364	<b>0 432 133 855</b>

51 10100 7364	<b>0 986 430 313</b>
51 10100 7365	<b>0 432 131 784</b>
51 10100 7366	<b>0 432 131 772</b>
51 10100 7374	<b>0 432 131 760</b>
51 10100 7374	<b>0 986 430 451</b>

51 10100 7377	<b>0 432 131 820</b>
51 10100 7379	<b>0 432 131 746</b>
51 10100 7382	<b>0 432 131 755</b>
51 10100 7383	<b>0 432 131 747</b>
51 10100 7386	<b>0 432 133 841</b>

51 10100 7387	<b>0 432 133 840</b>
51 10100 7388	<b>0 432 131 723</b>
51 10100 7389	<b>0 432 131 734</b>
51 10100 7390	<b>0 432 131 733</b>
51 10100 7391	<b>0 432 133 842</b>

51 10100 7392	<b>0 432 131 721</b>
51 10100 7393	<b>0 432 131 720</b>
51 10100 7397	<b>0 432 131 702</b>
51 10100 7398	<b>0 432 131 701</b>
51 10100 7400	<b>0 432 131 700</b>

51 10100 7407	<b>0 432 131 779</b>
51 10100 7421	<b>0 432 191 483</b>
51 10100 7422	<b>0 432 191 482</b>
51 10100 7436	<b>0 432 133 766</b>
51 10100 7436	<b>0 432 133 796</b>

51 10100 7437	<b>0 432 133 796</b>
51 10100 7437	<b>0 432 133 797</b>
51 10100 7441	<b>0 432 133 799</b>
51 10100 7442	<b>0 432 133 798</b>
51 10100 7448	<b>0 432 191 415</b>

51 10100 7449	<b>0 432 191 414</b>
51 10100 7450	<b>0 432 191 416</b>
51 10100 7451	<b>0 432 191 418</b>
51 10100 7452	<b>0 432 191 417</b>
51 10100 7453	<b>0 432 191 419</b>

51 10100 7455	<b>0 432 191 420</b>
51 10100 9028	<b>0 432 131 631</b>
51 10100 9029	<b>0 432 131 633</b>
51 10100 9049	<b>0 986 435 527</b>
51 10100 9066	<b>0 986 435 558</b>

51 10100 9083	<b>0 986 435 565</b>
51 10100 9085	<b>0 986 435 562</b>
51 10100 9086	<b>0 986 435 563</b>
51 10100 9114	<b>0 986 435 561</b>
51 10100 9115	<b>0 986 435 568</b>

51 10100 9121	<b>0 986 435 570</b>
51 10100 9123	<b>0 986 435 569</b>
51 10100 9125	<b>0 986 435 517</b>
51 10100 9126	<b>0 986 435 526</b>
51 10100 9127	<b>0 986 435 528</b>

51 10100 9180	<b>0 986 435 650</b>
51 10100 9363	<b>0 986 430 312</b>
51 10100 9364	<b>0 986 430 313</b>
51 10100 9374	<b>0 432 131 760</b>
51 10100 9387	<b>0 432 133 840</b>

51 10100 9389	<b>0 432 131 734</b>
51 10100 9390	<b>0 432 131 733</b>
51 10101 7264	<b>0 432 231 795</b>
51 10101 7274	<b>0 432 231 778</b>
51 10101 7274	<b>0 986 430 159</b>

51 10101 7288	<b>0 432 231 768</b>
51 10101 7290	<b>0 432 231 765</b>
51 10101 7310	<b>0 432 131 853</b>
51 10101 7310	<b>0 986 430 196</b>
51 10101 7310X	<b>0 986 430 196</b>

51 10101 7312	<b>0 432 131 885</b>
51 10101 7315	<b>0 432 131 857</b>
51 10101 7315	<b>0 986 430 321</b>
51 10101 7321	<b>0 432 131 866</b>
51 10101 7321	<b>0 986 430 228</b>

51 10101 7338	<b>0 432 131 831</b>
51 10101 7339	<b>0 432 133 872</b>
51 10101 7349	<b>0 432 131 820</b>
51 10101 7349	<b>0 986 430 257</b>
51 10101 7383	<b>0 432 131 747</b>

51 10101 9315	<b>0 986 430 321</b>
51 11100 6018	<b>0 986 444 090</b>
51 11100 6024	<b>0 986 444 091</b>
51 11100 6029	<b>0 986 444 039</b>
51 11100 6034	<b>0 986 444 010</b>

51 11100 6034	<b>0 986 444 092</b>
51 11100 7436	<b>0 432 133 797</b>
51 11100 9024	<b>0 986 444 091</b>
51 11100 9029	<b>0 986 444 077</b>
51 11100 9034	<b>0 986 444 010</b>

51 11101 9029	<b>0 986 444 039</b>
51 11102 7531	<b>0 460 416 037</b>
51 11102 7874	<b>0 460 424 040</b>
51 11103 7032	<b>0 460 416 069</b>
51 11103 7033	<b>0 460 416 068</b>

51 11103 7046	<b>0 432 131 866</b>
51 11103 7157	<b>0 460 416 071</b>
51 11103 7159	<b>0 460 416 070</b>
51 11103 7161	<b>0 460 416 072</b>
51 11103 7291	<b>0 460 426 231</b>

51 11103 7319	<b>0 460 424 107</b>
51 11103 7535	<b>0 460 426 273</b>
51 11103 7536	<b>0 460 424 150</b>
51 11103 7590	<b>0 986 444 010</b>
51 11103 7590	<b>0 986 444 092</b>

51 11103 7610	<b>0 986 444 090</b>
51 11103 7611	<b>0 986 444 039</b>
51 11103 7611	<b>0 986 444 077</b>
51 11103 7645	<b>0 986 444 010</b>
51 11103 7645	<b>0 986 444 092</b>

51 11103 7646	<b>0 986 444 039</b>
51 11103 7646	<b>0 986 444 077</b>
51 11103 7647	<b>0 986 444 090</b>
51 11103 7650	<b>0 986 444 010</b>
51 11103 7650	<b>0 986 444 092</b>

51 11103 7655	<b>0 445 020 014</b>
51 11103 7678	<b>0 445 020 023</b>
51 11103 7691	<b>0 445 020 018</b>
51 11103 7691	<b>0 986 437 353</b>
51 11103 7693	<b>0 445 020 014</b>

51 11103 7699	<b>0 986 444 091</b>
51 11103 7716	<b>0 445 020 034</b>
51 11103 7716	<b>0 986 437 352</b>
51 11103 7726	<b>0 986 444 010</b>
51 11103 7726	<b>0 986 444 092</b>

51 11103 7727	<b>0 986 444 090</b>
51 11103 7729	<b>0 986 444 039</b>
51 11103 7729	<b>0 986 444 077</b>
51 11103 7731	<b>0 986 444 090</b>
51 11103 7732	<b>0 986 444 010</b>

51 11103 7732	<b>0 986 444 092</b>
51 11103 7733	<b>0 986 444 039</b>
51 11103 7733	<b>0 986 444 077</b>
51 11103 7735	<b>0 986 444 091</b>
51 11103 7738	<b>0 445 020 023</b>

51 11103 7738	<b>0 986 437 351</b>
51 11103 7739	<b>0 445 020 051</b>
51 11103 7739	<b>0 986 437 350</b>
51 11103 7740	<b>0 445 020 018</b>
51 11103 7740	<b>0 986 437 353</b>

51 11103 7741	<b>0 445 020 014</b>
51 11103 7741	<b>0 445 020 053</b>
51 11103 7760	<b>F 00B C00 006</b>
51 11103 7761	<b>F 00B C00 008</b>
51 11103 7761	<b>0 986 437 911</b>

51 11103 7762	<b>F 00B C00 010</b>
51 11103 7762	<b>0 986 437 912</b>
51 11103 7763	<b>0 445 020 034</b>
51 11103 7763	<b>0 445 020 060</b>
51 11103 7763	<b>0 986 437 352</b>

51 11103 7782	<b>0 445 020 052</b>
51 11103 7783	<b>0 445 020 073</b>
51 11103 7786	<b>0 986 444 039</b>
51 11103 7786	<b>0 986 444 077</b>
51 11103 7787	<b>0 445 020 034</b>

51 11103 7787	<b>0 986 437 352</b>
51 11103 7792	<b>0 445 020 075</b>
51 11103 7792	<b>0 986 437 350</b>
51 11103 7794	<b>0 445 020 103</b>
51 11103 7797	<b>0 986 437 359</b>

51 11103 7799	<b>0 445 020 090</b>
51 11103 7799	<b>0 986 437 383</b>
51 11103 7803	<b>0 986 444 010</b>
51 11103 7803	<b>0 986 444 092</b>
51 11103 7807	<b>0 445 020 082</b>

51 11103 7808	<b>0 445 020 103</b>
51 11103 7810	<b>0 445 020 124</b>
51 11103 7810	<b>0 986 437 383</b>
51 11103 7812	<b>0 986 437 350</b>
51 11103 7813	<b>0 986 437 359</b>

51 11103 7814	<b>0 445 020 130</b>
51 11103 7814	<b>0 986 437 352</b>
51 11103 7817	<b>0 986 437 359</b>
51 11103 7824	<b>0 445 020 155</b>
51 11103 7824	<b>0 986 437 350</b>

51 11103 7825	<b>0 445 020 156</b>
51 11103 7825	<b>0 986 437 359</b>
51 11103 7826	<b>0 445 020 167</b>
51 11103 7828	<b>0 445 020 170</b>
51 11103 7828	<b>0 986 437 383</b>

51 11103 7829	<b>0 445 020 183</b>
51 11103 7832	<b>0 445 020 169</b>
51 11103 7844	<b>0 445 020 207</b>
51 11103 7845	<b>0 445 020 202</b>
51 11103 7845	<b>0 986 437 383</b>

51 11103 7846	<b>0 445 020 208</b>
51 11103 7846	<b>0 986 437 350</b>
51 11103 7847	<b>0 445 020 206</b>
51 11103 7847	<b>0 986 437 359</b>
51 11103 7848	<b>0 445 020 203</b>

51 11103 7848	<b>0 986 437 352</b>
51 11103 7849	<b>0 445 020 204</b>
51 11103 7850	<b>0 445 020 205</b>
51 11103 7856	<b>0 445 020 264</b>
51 11103 7857	<b>0 445 020 264</b>

51 11103 7858	<b>0 445 020 277</b>
51 11103 7858	<b>0 986 437 383</b>
51 11103 7859	<b>0 445 020 303</b>
51 11103 9738	<b>0 986 437 351</b>
51 11103 9740	<b>0 986 437 353</b>

51 11103 9845	<b>0 986 437 383</b>
51 11103 9846	<b>0 986 437 350</b>
51 11103 9847	<b>0 986 437 359</b>
51 11103 9848	<b>0 986 437 352</b>
51 11103 9858	<b>0 986 437 383</b>

51 15403 6000	<b>0 444 011 006</b>
51 15403 6001	<b>0 444 011 025</b>
61 10100 6083	<b>0 445 120 162</b>
61 10100 6115	<b>0 445 120 186</b>
62 11103 7799	<b>0 445 020 080</b>

62 11103 7799	<b>0 986 437 358</b>
65 10101 7051	<b>0 432 131 667</b>
65 10101 7053	<b>0 432 131 669</b>
81 10101 0011	<b>0 432 291 782</b>
81 15403 6001	<b>0 444 010 006</b>

81 15403 6005	<b>0 444 010 006</b>
81 15403 6016	<b>0 444 010 011</b>
81 15403 6021	<b>0 444 010 006</b>
81 15403 6028	<b>0 444 010 013</b>
81 15403 6088	<b>0 444 010 015</b>

81 15403 6090	<b>0 444 010 026</b>
81 15403 6092	<b>0 444 010 022</b>
81 15403 6098	<b>0 444 010 037</b>
81 15403 6099	<b>0 444 010 026</b>
81 15403 6102	<b>0 444 010 027</b>

81 15405 6010	<b>0 444 063 001</b>
81 15405 6011	<b>0 444 063 006</b>

### MANN (MANN & HUMMEL)

1004453S01	<b>0 281 006 056</b>
1023102S01	<b>0 280 218 075</b>

1023103S01	<b>0 280 218 159</b>
1026799S01	<b>0 280 218 055</b>

### MAPCO

42001	<b>0 281 002 309</b>
42002	<b>0 281 002 308</b>
42004	<b>0 281 002 613</b>

42007	<b>0 281 002 199</b>
42301	<b>0 281 002 184</b>
42520	<b>0 281 002 207</b>
42560	<b>0 281 002 619</b>
42575	<b>0 281 002 554</b>

42576	<b>0 281 002 447</b>
42579	<b>0 281 002 600</b>
42700	<b>0 281 002 180</b>
42701	<b>0 281 002 428</b>
42706	<b>0 281 002 139</b>

42707	<b>0 281 002 478</b>
42708	<b>0 281 002 144</b>
42714	<b>0 281 002 479</b>
42717	<b>0 281 002 549</b>
42722	<b>0 281 002 620</b>

42800	<b>0 281 002 757</b>
42800	<b>0 986 284 010</b>
42801	<b>0 281 002 216</b>
42808	<b>0 281 002 429</b>
42814	<b>0 281 002 461</b>

42818	<b>0 281 002 463</b>
42826	<b>0 281 002 403</b>
42836	<b>0 281 002 610</b>
42863	<b>0 281 002 281</b>
42864	<b>0 281 002 489</b>

42865	<b>0 281 002 384</b>
42866	<b>0 281 002 152</b>
42902	<b>0 281 002 182</b>
42903	<b>0 281 002 120</b>
42910	<b>0 281 002 195</b>

42980	<b>0 281 002 132</b>
70778	<b>0 281 002 478</b>

### MARUTI

13800M55KDO	<b>0 281 002 980</b>
15200M68L50	<b>0 445 010 310</b>
15200M68L50	<b>0 986 437 038</b>

15200M68L60	<b>0 445 010 310</b>
-------------	----------------------

### MASERATI

208444	<b>0 280 218 217</b>
--------	----------------------







A002 017 26 21 80	<b>0 986 430 025</b>
A002 017 28 21	<b>0 432 217 147</b>
A002 017 28 21	<b>0 986 430 184</b>
A002 017 28 21 80	<b>0 432 217 147</b>
A002 017 28 21 80	<b>0 986 430 184</b>
A002 017 29 21	<b>0 986 430 133</b>
A002 017 29 21 80	<b>0 986 430 133</b>
A002 017 31 21	<b>9 430 082 291</b>
A002 017 33 21	<b>0 986 430 038</b>
A002 017 33 21 80	<b>0 986 430 038</b>
A002 017 34 21	<b>0 432 217 157</b>
A002 017 34 21	<b>0 986 430 197</b>
A002 017 34 21 80	<b>0 986 430 197</b>
A002 017 36 21	<b>0 432 217 131</b>
A002 017 37 21	<b>0 432 217 161</b>
A002 017 37 21	<b>0 986 430 172</b>
A002 017 37 21 80	<b>0 432 217 161</b>
A002 017 37 21 80	<b>0 986 430 172</b>
A002 017 40 21	<b>0 986 430 173</b>
A002 017 40 21 80	<b>0 986 430 173</b>
A002 017 41 21	<b>0 432 206 013</b>
A002 017 42 21	<b>0 432 231 760</b>
A002 017 42 21	<b>0 986 430 168</b>
A002 017 42 21 80	<b>0 986 430 168</b>
A002 017 48 21	<b>0 432 231 760</b>
A002 017 53 21	<b>9 430 082 297</b>
A002 017 58 21	<b>0 432 231 736</b>
A002 017 58 21	<b>0 986 430 178</b>
A002 017 58 21 80	<b>0 986 430 178</b>
A002 017 65 21	<b>0 986 430 038</b>
A002 017 72 21	<b>0 432 131 803</b>
A002 017 83 21	<b>0 986 430 221</b>
A002 017 83 21 80	<b>0 986 430 221</b>
A002 017 89 21	<b>0 432 231 722</b>
A002 017 89 21	<b>0 986 430 214</b>
A002 017 89 21 80	<b>0 986 430 214</b>
A002 017 97 21	<b>0 986 430 205</b>
A002 017 97 21 80	<b>0 986 430 205</b>
A002 070 83 01	<b>0 460 415 992</b>
A002 070 83 01	<b>0 986 440 579</b>
A002 470 54 94	<b>F 01C 600 155</b>
A002 470 54 94	<b>F 01C 600 194</b>
A002 470 57 94	<b>F 01C 600 155</b>
A002 470 57 94	<b>F 01C 600 194</b>
A002 470 68 94	<b>F 01C 600 194</b>
A002 470 77 94	<b>F 01C 600 265</b>
A003 010 04 51	<b>0 432 193 421</b>
A003 010 05 51	<b>0 432 193 419</b>
A003 010 09 51	<b>0 432 191 220</b>
A003 017 00 21	<b>0 432 231 677</b>
A003 017 00 21	<b>0 986 430 211</b>
A003 017 00 21 80	<b>0 986 430 211</b>
A003 017 01 21	<b>0 986 430 210</b>
A003 017 01 21 80	<b>0 986 430 210</b>
A003 017 13 21	<b>0 432 231 703</b>

A003 017 13 21	<b>0 986 430 168</b>
A003 017 13 21 80	<b>0 986 430 168</b>
A003 017 14 21	<b>0 432 231 704</b>
A003 017 14 21	<b>0 986 430 133</b>
A003 017 14 21 80	<b>0 986 430 133</b>
A003 017 21 21	<b>0 986 430 246</b>
A003 017 21 21 80	<b>0 986 430 246</b>
A003 017 26 21	<b>9 430 082 311</b>
A003 017 27 21	<b>0 432 131 680</b>
A003 017 27 21	<b>9 430 082 319</b>
A003 017 29 01	<b>0 432 217 266</b>
A003 017 29 21	<b>0 432 217 266</b>
A003 017 29 21	<b>0 986 430 247</b>
A003 017 29 21 80	<b>0 432 217 266</b>
A003 017 29 21 80	<b>0 986 430 247</b>
A003 017 30 21	<b>0 432 131 816</b>
A003 017 36 21	<b>0 432 231 693</b>
A003 017 38 21	<b>9 430 082 316</b>
A003 017 44 21	<b>0 432 231 688</b>
A003 017 44 21	<b>0 986 430 221</b>
A003 017 44 21 80	<b>0 986 430 221</b>
A003 017 46 21	<b>0 432 231 687</b>
A003 017 46 21	<b>0 986 430 053</b>
A003 017 46 21 80	<b>0 986 430 053</b>
A003 017 47 21	<b>0 432 231 686</b>
A003 017 49 21	<b>0 432 231 684</b>
A003 017 49 21	<b>0 986 430 042</b>
A003 017 49 21 80	<b>0 986 430 042</b>
A003 017 52 21	<b>0 432 231 683</b>
A003 017 54 21	<b>0 432 231 681</b>
A003 017 55 21	<b>0 432 231 680</b>
A003 017 55 21	<b>0 986 430 038</b>
A003 017 55 21 80	<b>0 986 430 038</b>
A003 017 56 21	<b>0 432 231 679</b>
A003 017 57 21	<b>0 432 231 678</b>
A003 017 57 21	<b>0 986 430 205</b>
A003 017 57 21 80	<b>0 986 430 205</b>
A003 017 58 21	<b>0 432 231 677</b>
A003 017 58 21	<b>0 986 430 211</b>
A003 017 58 21 80	<b>0 986 430 211</b>
A003 017 59 21	<b>0 432 231 675</b>
A003 017 60 21	<b>0 432 231 676</b>
A003 017 60 21	<b>0 986 430 360</b>
A003 017 60 21 80	<b>0 986 430 360</b>
A003 017 61 21	<b>9 430 082 318</b>
A003 017 62 12	<b>0 432 131 645</b>
A003 017 64 21	<b>0 432 231 674</b>
A003 017 64 21	<b>0 986 430 508</b>
A003 017 64 21 80	<b>0 986 430 508</b>
A003 017 65 21	<b>0 986 430 507</b>
A003 017 65 21 80	<b>0 986 430 507</b>
A003 017 70 21	<b>0 432 131 802</b>
A003 017 70 21	<b>0 986 430 378</b>
A003 017 70 21 80	<b>0 986 430 378</b>
A003 017 71 21	<b>0 986 430 265</b>

A003 017 71 21 80	<b>0 986 430 265</b>
A003 017 72 21	<b>0 986 430 264</b>
A003 017 72 21 80	<b>0 986 430 264</b>
A003 017 73 21	<b>0 432 131 805</b>
A003 017 74 21	<b>0 432 131 804</b>
A003 017 75 21	<b>0 432 131 803</b>
A003 017 78 21	<b>0 986 430 261</b>
A003 017 78 21 80	<b>0 986 430 261</b>
A003 017 80 21	<b>0 432 131 797</b>
A003 017 85 21	<b>0 432 131 793</b>
A003 017 85 21	<b>0 986 430 362</b>
A003 017 85 21 80	<b>0 986 430 362</b>
A003 017 86 21	<b>0 432 131 794</b>
A003 017 86 21	<b>0 986 430 252</b>
A003 017 86 21 80	<b>0 986 430 252</b>
A003 017 92 21	<b>0 432 131 781</b>
A003 017 92 21	<b>0 986 430 361</b>
A003 017 92 21 80	<b>0 986 430 361</b>
A003 017 93 21	<b>0 432 131 780</b>
A003 017 95 21	<b>0 432 217 290</b>
A003 017 95 21 80	<b>0 986 430 505</b>
A004 017 05 21	<b>0 432 131 768</b>
A004 017 11 21	<b>0 432 191 501</b>
A004 017 12 21	<b>0 432 231 659</b>
A004 017 12 21	<b>0 986 430 095</b>
A004 017 12 21 80	<b>0 986 430 095</b>
A004 017 13 21	<b>0 432 231 660</b>
A004 017 14 21	<b>0 432 231 663</b>
A004 017 14 21	<b>0 986 430 093</b>
A004 017 14 21 80	<b>0 986 430 093</b>
A004 017 15 21	<b>0 432 231 661</b>
A004 017 15 21	<b>0 986 430 092</b>
A004 017 15 21 80	<b>0 986 430 092</b>
A004 017 16 21	<b>0 432 231 665</b>
A004 017 17 21	<b>0 432 231 664</b>
A004 017 17 21	<b>0 986 430 094</b>
A004 017 17 21 80	<b>0 986 430 094</b>
A004 017 18 21	<b>0 432 231 658</b>
A004 017 19 21	<b>0 432 231 662</b>
A004 017 25 21	<b>9 430 082 768</b>
A004 017 27 21	<b>0 432 191 587</b>
A004 017 28 21	<b>0 432 131 727</b>
A004 017 28 21	<b>0 986 430 325</b>
A004 017 28 21 80	<b>0 986 430 325</b>
A004 017 29 21	<b>0 432 131 726</b>
A004 017 29 21	<b>0 986 430 326</b>
A004 017 29 21 80	<b>0 986 430 326</b>
A004 017 30 21	<b>0 432 131 728</b>
A004 017 30 21	<b>0 986 430 327</b>
A004 017 30 21 80	<b>0 986 430 327</b>
A004 017 31 21	<b>0 432 131 731</b>
A004 017 32 21	<b>0 432 131 730</b>
A004 017 33 21	<b>0 432 131 729</b>
A004 017 37 21	<b>0 432 191 589</b>
A004 017 38 21	<b>0 432 191 551</b>

A004 017 47 21	<b>0 432 191 587</b>
A004 017 48 21	<b>0 432 193 766</b>
A004 017 50 21	<b>0 432 131 707</b>
A004 017 50 21	<b>0 986 430 091</b>
A004 017 50 21 80	<b>0 986 430 091</b>
A004 017 51 21	<b>0 432 131 706</b>
A004 017 52 21	<b>0 432 191 554</b>
A004 017 54 21	<b>0 432 131 677</b>
A004 017 61 21	<b>F 000 439 000</b>
A004 017 65 21	<b>0 432 191 278</b>
A004 017 65 21	<b>0 432 191 526</b>
A004 017 80 21	<b>0 432 131 680</b>
A004 017 81 21	<b>0 432 191 489</b>
A004 017 82 21	<b>0 432 191 488</b>
A004 017 83 21	<b>0 432 191 485</b>
A004 017 86 21	<b>0 432 231 599</b>
A004 017 86 21	<b>0 986 430 563</b>
A004 017 86 21 80	<b>0 986 430 563</b>
A004 017 91 21	<b>0 432 191 468</b>
A004 017 93 21	<b>0 432 191 463</b>
A004 017 94 21	<b>0 432 191 462</b>
A004 017 98 21	<b>0 432 191 459</b>
A004 074 05 21	<b>0 432 131 768</b>
A004 094 34 48	<b>0 281 002 978</b>
A004 153 06 28	<b>0 281 002 281</b>
A004 153 06 28	<b>0 281 002 282</b>
A004 153 73 28	<b>0 281 002 489</b>
A005 017 02 21	<b>0 432 191 434</b>
A005 017 04 21	<b>0 432 191 442</b>
A005 017 06 21	<b>0 432 191 441</b>
A005 017 07 21	<b>0 432 191 444</b>
A005 017 10 21	<b>0 432 193 583</b>
A005 017 11 21	<b>0 432 193 582</b>
A005 017 13 21	<b>0 432 191 446</b>
A005 017 14 21	<b>0 432 191 437</b>
A005 017 22 21	<b>0 432 191 400</b>
A005 017 23 21	<b>0 432 191 394</b>
A005 017 24 21	<b>0 432 191 396</b>
A005 017 25 21	<b>0 432 191 395</b>
A005 017 25 21	<b>0 432 191 442</b>
A005 017 26 21	<b>0 432 191 393</b>
A005 017 26 21	<b>0 432 191 444</b>
A005 017 32 21	<b>0 432 191 385</b>
A005 017 34 21	<b>0 432 131 645</b>
A005 017 37 21	<b>0 432 131 646</b>
A005 017 39 21	<b>0 432 191 363</b>
A005 017 40 21	<b>0 432 191 360</b>
A005 017 41 21	<b>0 432 191 359</b>
A005 017 44 21	<b>0 432 193 522</b>
A005 017 45 21	<b>0 432 191 348</b>
A005 017 46 21	<b>0 432 191 347</b>
A005 017 47 21	<b>0 432 193 521</b>
A005 017 52 21	<b>0 432 131 632</b>
A005 017 52 21	<b>0 432 131 645</b>
A005 017 52 21	<b>0 986 430 090</b>



◀ MERCEDES-BENZ

A 005 017 52 21 80	<b>0 986 430 090</b>
A 005 017 53 21	<b>0 432 191 384</b>
A 005 017 57 21	<b>0 432 191 263</b>
A 005 017 57 21	<b>0 432 191 372</b>
A 005 017 59 21	<b>0 432 191 370</b>

A 005 017 60 21	<b>0 432 191 344</b>
A 005 017 65 21	<b>0 432 193 500</b>
A 005 017 70 21	<b>0 432 191 321</b>
A 005 017 72 21	<b>0 432 191 316</b>
A 005 017 74 21	<b>F 000 439 024</b>

A 005 017 77 21	<b>0 432 191 278</b>
A 005 017 77 21	<b>0 432 191 304</b>
A 005 017 78 21	<b>0 432 191 305</b>
A 005 017 79 21	<b>0 432 191 307</b>
A 005 017 80 21	<b>0 432 191 306</b>

A 005 017 81 21	<b>0 432 191 308</b>
A 005 017 82 21	<b>0 432 191 302</b>
A 005 017 83 21	<b>0 432 191 301</b>
A 005 017 85 21	<b>0 432 191 303</b>
A 005 017 86 21	<b>0 432 193 490</b>

A 005 017 87 21	<b>0 432 193 491</b>
A 006 017 01 21	<b>0 432 193 484</b>
A 006 017 02 21	<b>0 432 193 483</b>
A 006 017 03 21	<b>0 432 191 285</b>
A 006 017 14 21	<b>0 432 193 480</b>

A 006 017 15 21	<b>0 432 193 481</b>
A 006 017 16 21	<b>0 432 193 479</b>
A 006 017 20 21	<b>0 432 191 276</b>
A 006 017 21 21	<b>0 432 191 277</b>
A 006 017 22 21	<b>0 432 191 278</b>

A 006 017 23 21	<b>0 432 193 473</b>
A 006 017 24 21	<b>0 432 193 474</b>
A 006 017 25 21	<b>0 432 191 279</b>
A 006 017 26 21	<b>0 432 191 280</b>
A 006 017 28 21	<b>0 432 191 282</b>

A 006 017 29 21	<b>0 432 193 475</b>
A 006 017 30 21	<b>0 432 193 476</b>
A 006 017 37 21	<b>0 432 193 466</b>
A 006 017 39 21	<b>0 432 193 467</b>
A 006 017 42 21	<b>0 432 191 256</b>

A 006 017 42 21	<b>0 432 191 260</b>
A 006 017 43 21	<b>0 432 191 261</b>
A 006 017 44 21	<b>0 432 191 262</b>
A 006 017 45 21	<b>0 432 191 263</b>
A 006 017 47 21	<b>0 432 191 265</b>

A 006 017 48 21	<b>0 432 191 266</b>
A 006 017 49 21	<b>0 432 191 267</b>
A 006 017 50 21	<b>0 432 191 268</b>
A 006 017 51 21	<b>0 432 191 258</b>
A 006 017 51 21	<b>0 432 191 269</b>

A 006 017 52 21	<b>0 432 191 259</b>
A 006 017 52 21	<b>0 432 191 270</b>
A 006 017 56 21	<b>0 432 191 248</b>
A 006 017 57 21	<b>0 432 191 242</b>
A 006 017 58 21	<b>0 432 191 240</b>

A 006 017 65 21	<b>0 432 133 767</b>
A 006 017 68 21	<b>0 432 193 459</b>
A 006 017 69 21	<b>0 432 191 238</b>
A 006 017 71 21	<b>0 432 191 237</b>
A 006 017 75 21	<b>0 432 193 448</b>

A 006 017 76 21	<b>F 000 439 030</b>
A 006 017 82 21	<b>0 432 191 222</b>
A 006 017 83 21	<b>0 432 193 437</b>
A 006 017 84 21	<b>0 432 193 436</b>
A 006 017 85 21	<b>0 432 193 438</b>

A 006 017 86 21	<b>0 432 193 442</b>
A 006 017 88 21	<b>0 432 193 444</b>
A 006 017 89 21	<b>0 432 193 439</b>
A 006 017 90 21	<b>0 432 193 441</b>
A 006 017 92 21	<b>0 432 193 445</b>

A 006 017 96 21	<b>0 432 193 423</b>
A 006 017 97 21	<b>0 432 193 420</b>
A 007 017 00 21	<b>0 432 191 216</b>
A 007 017 01 21	<b>0 432 193 416</b>
A 026 074 73 02	<b>0 986 445 103</b>

A 027 074 92 02	<b>0 986 445 103</b>
A 028 074 23 02	<b>0 460 414 160</b>
A 028 074 32 02	<b>0 986 445 103</b>
A 028 074 34 02	<b>0 986 445 102</b>
A 028 074 48 02	<b>0 986 445 103</b>

A 028 074 49 02	<b>0 460 414 160</b>
A 028 074 53 02	<b>0 460 414 160</b>
A 028 074 59 02	<b>0 414 799 025</b>
A 028 074 59 02	<b>0 986 445 102</b>
A 028 074 59 02 0080	<b>0 986 445 102</b>

A 028 074 59 02 80	<b>0 986 445 102</b>
A 028 074 60 02	<b>0 986 445 103</b>
A 028 074 61 02	<b>0 414 799 026</b>
A 028 074 61 02	<b>0 986 445 016</b>
A 028 074 61 02 0080	<b>0 986 445 016</b>

A 028 074 62 02	<b>0 460 414 202</b>
A 028 074 63 02	<b>0 986 445 103</b>
A 028 074 69 02	<b>0 986 445 103</b>
A 028 074 69 02 0080	<b>0 986 445 103</b>
A 028 074 69 02 80	<b>0 986 445 103</b>

A 028 074 86 02	<b>0 414 799 012</b>
A 028 074 88 02	<b>0 414 799 024</b>
A 028 074 88 02	<b>0 986 445 022</b>
A 028 074 88 02 0080	<b>0 986 445 022</b>
A 028 074 89 02	<b>0 414 799 015</b>

A 028 074 89 02	<b>0 414 799 030</b>
A 028 074 89 02	<b>0 986 445 020</b>
A 028 074 89 02 0080	<b>0 986 445 020</b>
A 028 074 90 02	<b>0 414 799 029</b>
A 028 074 90 02	<b>0 986 445 019</b>

A 028 074 90 02 0080	<b>0 986 445 019</b>
A 028 074 91 02	<b>0 414 799 017</b>
A 028 074 91 02	<b>0 414 799 032</b>
A 028 074 91 02	<b>0 986 445 021</b>
A 028 074 91 02 0080	<b>0 986 445 021</b>

A 028 074 92 02	<b>0 414 799 028</b>
A 028 074 92 02	<b>0 986 445 018</b>
A 028 074 92 02 0080	<b>0 986 445 018</b>
A 028 074 94 02	<b>0 414 799 035</b>
A 028 074 94 02	<b>0 986 445 025</b>

A 028 074 94 02 0080	<b>0 986 445 025</b>
A 028 074 95 02	<b>0 986 441 024</b>
A 028 074 96 02	<b>0 414 799 033</b>
A 028 074 96 02	<b>0 986 445 023</b>
A 028 074 96 02 0080	<b>0 986 445 023</b>

A 029 074 16 02	<b>0 414 799 038</b>
A 113 094 01 48	<b>0 280 218 083</b>
A 164 490 05 13	<b>0 444 021 024</b>
A 273 094 05 48	<b>0 280 218 190</b>
A 273 094 06 48	<b>0 280 218 190</b>

A 273 094 09 48	<b>0 280 218 190</b>
A 276 094 01 48	<b>0 280 218 246</b>
A 374 074 05 02	<b>0 460 424 366</b>
A 374 074 06 02	<b>0 460 424 381</b>
A 376 017 00 21	<b>0 432 133 762</b>

A 376 017 78 21	<b>9 430 082 771</b>
A 400 070 01 01	<b>0 445 020 515</b>
A 400 070 01 87	<b>0 445 110 519</b>
A 470 070 00 87	<b>0 445 120 298</b>
A 470 070 00 87	<b>0 986 435 622</b>

A 470 070 00 87 0080	<b>0 445 120 298</b>
A 470 070 00 87 0080	<b>0 986 435 622</b>
A 470 070 00 87 80	<b>0 986 435 622</b>
A 470 090 00 50	<b>0 445 020 198</b>
A 470 090 00 50	<b>0 986 437 507</b>

A 470 090 07 50	<b>0 445 020 198</b>
A 470 090 07 50	<b>0 986 437 504</b>
A 470 090 08 50	<b>0 445 020 189</b>
A 470 090 08 50	<b>0 986 437 507</b>
A 470 090 15 50	<b>0 445 020 249</b>

A 470 090 15 50	<b>0 986 437 504</b>
A 470 090 21 50	<b>0 445 020 235</b>
A 470 090 21 50	<b>0 986 437 507</b>
A 471 070 01 87	<b>0 445 120 194</b>
A 471 070 01 87	<b>0 986 435 537</b>

A 471 070 01 87	<b>0 986 435 642</b>
A 471 070 02 87	<b>0 445 120 194</b>
A 471 070 02 87	<b>0 986 435 537</b>
A 471 070 02 87	<b>0 986 435 642</b>
A 471 070 03 87	<b>0 445 120 194</b>

A 471 070 03 87	<b>0 986 435 537</b>
A 471 070 03 87	<b>0 986 435 642</b>
A 471 070 04 87	<b>0 445 120 270</b>
A 471 070 04 87	<b>0 986 435 598</b>
A 471 070 04 87 0080	<b>0 445 120 270</b>

A 471 070 04 87 0080	<b>0 986 435 598</b>
A 471 070 04 87 80	<b>0 986 435 598</b>
A 471 070 05 87	<b>0 445 120 287</b>
A 471 070 05 87	<b>0 986 435 624</b>
A 471 070 05 87 80	<b>0 986 435 624</b>

A 471 070 08 87	<b>0 445 120 385</b>
A 471 070 08 87	<b>0 986 435 647</b>
A 471 070 08 87 80	<b>0 986 435 647</b>
A 471 090 08 50	<b>0 445 020 260</b>
A 472 070 00 87	<b>0 445 120 207</b>

A 472 070 00 87	<b>0 986 435 539</b>
A 472 070 03 87	<b>0 445 120 207</b>
A 472 070 03 87	<b>0 986 435 539</b>
A 472 070 05 87	<b>0 445 120 207</b>
A 472 070 05 87	<b>0 986 435 539</b>

A 472 070 07 87	<b>0 445 120 207</b>
A 472 070 07 87	<b>0 986 435 539</b>
A 472 070 08 87	<b>0 445 120 207</b>
A 472 070 08 87	<b>0 986 435 539</b>
A 472 070 08 87	<b>0 986 435 540</b>

A 472 070 10 87	<b>0 445 120 302</b>
A 472 070 10 87	<b>0 986 435 646</b>
A 472 070 12 87	<b>0 445 120 302</b>
A 472 070 12 87	<b>0 986 435 646</b>
A 472 070 12 87 80	<b>0 986 435 646</b>

A 472 090 08 50	<b>0 445 020 191</b>
A 472 090 08 50	<b>0 986 437 503</b>
A 472 090 10 50	<b>0 445 020 237</b>
A 472 090 15 50	<b>0 445 020 237</b>
A 472 090 15 50	<b>0 986 437 508</b>

A 472 090 21 50	<b>0 986 437 507</b>
A 473 070 02 87	<b>0 445 120 300</b>
A 555 010 06 51	<b>0 432 231 046</b>
A 555 010 07 51	<b>0 432 231 762</b>
A 602 070 77 01	<b>0 986 440 533</b>

A 602 070 77 01	<b>0 986 440 580</b>
A 602 070 77 01 80	<b>0 986 440 533</b>
A 602 070 77 01 80	<b>0 986 440 580</b>
A 602 070 79 01	<b>0 986 440 530</b>
A 602 070 79 01	<b>0 986 440 578</b>

A 602 070 79 01 80	<b>0 986 440 530</b>
A 602 070 83 01	<b>0 460 415 992</b>
A 602 070 83 01	<b>0 986 440 531</b>
A 602 070 83 01	<b>0 986 440 579</b>
A 602 070 83 01 80	<b>0 986 440 531</b>

A 602 070 83 01 80	<b>0 986 440 579</b>
A 602 070 85 01	<b>0 986 440 527</b>
A 602 070 85 01	<b>0 986 440 577</b>
A 602 070 85 01 80	<b>0 986 440 527</b>
A 602 070 87 01	<b>0 986 440 525</b>

A 602 070 87 01	<b>0 986 440 576</b>
A 602 070 87 01 80	<b>0 986 440 525</b>
A 602 070 87 01 80	<b>0 986 440 576</b>
A 611 070 00 01	<b>0 445 010 268</b>
A 611 070 00 87	<b>0 445 110 004</b>

A 611 070 03 01	<b>0 445 010 268</b>
A 611 070 03 87	<b>0 445 110 004</b>
A 611 070 03 87	<b>0 445 110 011</b>
A 611 070 04 01	<b>0 445 010 268</b>
A 611 070 04 87	<b>0 445 110 011</b>



A611 070 04 87	<b>0 986 435 004</b>
A611 070 04 87 0080	<b>0 986 435 004</b>
A611 070 05 01	<b>0 445 010 268</b>
A611 070 05 01	<b>0 986 437 100</b>
A611 070 05 01 0080	<b>0 986 437 100</b>
A611 070 05 87	<b>0 445 110 011</b>
A611 070 05 87	<b>0 986 435 004</b>
A611 070 05 87 0080	<b>0 986 435 004</b>
A611 070 05 87 38	<b>0 445 110 011</b>
A611 070 05 87 38	<b>0 986 435 004</b>
A611 070 05 87 80	<b>0 986 435 004</b>
A611 070 06 01	<b>0 445 010 269</b>
A611 070 06 01	<b>0 986 437 101</b>
A611 070 06 01 0080	<b>0 986 437 101</b>
A611 070 06 87	<b>0 445 110 024</b>
A611 070 06 87	<b>0 986 435 020</b>
A611 070 06 87 0080	<b>0 986 435 020</b>
A611 070 06 87 38	<b>0 445 110 024</b>
A611 070 06 87 38	<b>0 986 435 020</b>
A611 070 06 87 80	<b>0 986 435 020</b>
A611 070 07 01	<b>0 445 010 272</b>
A611 070 07 01	<b>0 986 437 103</b>
A611 070 07 01 0080	<b>0 986 437 103</b>
A611 070 08 87	<b>0 445 110 069</b>
A611 070 08 87	<b>0 445 110 105</b>
A611 070 08 87	<b>0 986 435 045</b>
A611 070 08 87	<b>0 986 435 158</b>
A611 070 08 87 80	<b>0 986 435 045</b>
A611 070 09 01	<b>0 445 010 274</b>
A611 070 09 01	<b>0 986 437 100</b>
A611 070 09 01 0080	<b>0 986 437 100</b>
A611 070 09 87	<b>0 445 110 071</b>
A611 070 09 87	<b>0 445 110 099</b>
A611 070 09 87	<b>0 986 435 041</b>
A611 070 09 87	<b>0 986 435 071</b>
A611 070 09 87 0080	<b>0 986 435 071</b>
A611 070 09 87 80	<b>0 986 435 041</b>
A611 070 11 87	<b>0 445 110 054</b>
A611 070 11 87	<b>0 986 435 133</b>
A611 070 11 87 80	<b>0 986 435 133</b>
A611 070 12 87	<b>0 445 110 105</b>
A611 070 12 87	<b>0 445 110 170</b>
A611 070 12 87	<b>0 986 435 045</b>
A611 070 12 87	<b>0 986 435 164</b>
A611 070 12 87 0080	<b>0 986 435 045</b>
A611 070 12 87 80	<b>0 986 435 045</b>
A611 070 12 87 80	<b>0 986 435 164</b>
A611 070 13 87	<b>0 445 110 099</b>
A611 070 13 87	<b>0 445 110 199</b>
A611 070 13 87	<b>0 986 435 041</b>
A611 070 13 87 0080	<b>0 986 435 041</b>
A611 070 13 87 80	<b>0 986 435 041</b>
A611 070 14 01	<b>0 986 437 364</b>
A611 070 14 87	<b>0 445 110 107</b>
A611 070 14 87	<b>0 445 110 189</b>

A611 070 14 87	<b>0 986 435 047</b>
A611 070 14 87	<b>0 986 435 055</b>
A611 070 14 87 0080	<b>0 986 435 047</b>
A611 070 14 87 80	<b>0 986 435 055</b>
A611 070 16 87	<b>0 445 110 189</b>
A611 070 16 87	<b>0 986 435 055</b>
A611 070 16 87 0080	<b>0 986 435 055</b>
A611 070 16 87 06	<b>0 445 110 189</b>
A611 070 16 87 06	<b>0 986 435 055</b>
A611 070 16 87 80	<b>0 986 435 055</b>
A611 070 17 87	<b>0 445 110 199</b>
A611 070 17 87	<b>0 986 435 061</b>
A611 070 17 87 0080	<b>0 986 435 061</b>
A611 070 17 87 80	<b>0 986 435 061</b>
A611 070 17 87 80	<b>0 986 435 071</b>
A612 070 00 01	<b>0 445 010 271</b>
A612 070 00 01	<b>0 986 437 104</b>
A612 070 00 01 0080	<b>0 986 437 104</b>
A612 070 00 87	<b>0 445 110 097</b>
A612 070 00 87	<b>0 445 110 203</b>
A612 070 00 87	<b>0 986 435 039</b>
A612 070 00 87 0080	<b>0 986 435 039</b>
A612 070 01 01	<b>0 445 010 275</b>
A612 070 01 01	<b>0 986 437 106</b>
A612 070 01 01 0080	<b>0 986 437 106</b>
A612 070 02 87	<b>0 445 110 151</b>
A612 070 03 87	<b>0 445 110 170</b>
A612 070 03 87	<b>0 445 110 181</b>
A612 070 03 87	<b>0 986 435 053</b>
A612 070 03 87	<b>0 986 435 164</b>
A612 070 03 87 80	<b>0 986 435 053</b>
A612 070 03 87 80	<b>0 986 435 164</b>
A612 070 04 87	<b>0 445 110 181</b>
A612 070 04 87	<b>0 986 435 053</b>
A612 070 04 87 0080	<b>0 986 435 053</b>
A612 070 04 87 80	<b>0 986 435 053</b>
A612 070 05 87	<b>0 445 110 203</b>
A612 070 05 87	<b>0 986 435 065</b>
A612 070 05 87 0080	<b>0 986 435 065</b>
A612 070 05 87 06	<b>0 445 110 203</b>
A612 070 05 87 06	<b>0 986 435 065</b>
A612 070 05 87 80	<b>0 986 435 065</b>
A613 070 00 01	<b>0 445 010 270</b>
A613 070 00 01	<b>0 986 437 102</b>
A613 070 00 01 0080	<b>0 986 437 102</b>
A613 070 01 87	<b>0 445 110 034</b>
A613 070 01 87	<b>0 445 110 095</b>
A613 070 01 87	<b>0 986 435 012</b>
A613 070 01 87	<b>0 986 435 037</b>
A613 070 01 87 0080	<b>0 986 435 012</b>
A613 070 05 87	<b>0 445 110 095</b>
A613 070 05 87	<b>0 445 110 201</b>
A613 070 05 87	<b>0 986 435 037</b>
A613 070 05 87	<b>0 986 435 063</b>
A613 070 05 87 80	<b>0 986 435 063</b>

A613 070 06 87	<b>0 445 110 120</b>
A613 070 06 87	<b>0 445 110 121</b>
A613 070 06 87	<b>0 986 435 051</b>
A613 070 06 87 0080	<b>0 986 435 051</b>
A613 070 08 87	<b>0 445 110 201</b>
A613 070 08 87	<b>0 986 435 063</b>
A613 070 08 87 0080	<b>0 986 435 063</b>
A613 070 08 87 80	<b>0 986 435 063</b>
A613 070 09 87	<b>0 445 110 205</b>
A613 070 09 87	<b>0 986 435 067</b>
A613 070 09 87 0080	<b>0 986 435 067</b>
A613 070 09 87 80	<b>0 986 435 067</b>
A628 070 01 01	<b>0 445 010 334</b>
A628 070 01 01	<b>0 986 437 360</b>
A628 070 01 01 0080	<b>0 986 437 360</b>
A628 070 01 87	<b>0 445 110 045</b>
A628 070 01 87	<b>0 445 110 073</b>
A628 070 02 87	<b>0 445 110 073</b>
A628 070 02 87	<b>0 986 435 031</b>
A628 070 02 87 0080	<b>0 986 435 031</b>
A628 070 02 87 80	<b>0 986 435 031</b>
A628 070 03 87	<b>0 445 110 093</b>
A628 070 03 87	<b>0 986 435 035</b>
A628 070 03 87 0080	<b>0 986 435 035</b>
A628 070 03 87 80	<b>0 986 435 035</b>
A628 070 04 87	<b>0 445 110 103</b>
A628 070 04 87	<b>0 986 435 043</b>
A628 070 04 87 0080	<b>0 986 435 043</b>
A628 070 04 87 80	<b>0 986 435 043</b>
A628 070 04 87 80	<b>0 986 435 069</b>
A628 070 05 87	<b>0 445 110 207</b>
A628 070 05 87	<b>0 986 435 069</b>
A628 979 95 87 0080	<b>0 986 435 069</b>
A629 070 00 01	<b>0 986 437 367</b>
A629 070 00 01 0080	<b>0 986 437 367</b>
A629 070 00 87	<b>0 445 115 014</b>
A629 070 02 87	<b>0 445 115 065</b>
A629 070 02 87	<b>0 986 435 400</b>
A629 070 02 87 80	<b>0 986 435 400</b>
A639 070 02 87	<b>0 445 110 267</b>
A640 070 06 01	<b>0 986 437 368</b>
A640 070 06 87	<b>0 445 110 166</b>
A640 070 06 87	<b>0 986 435 117</b>
A640 070 07 01	<b>0 986 437 368</b>
A640 070 07 01 0080	<b>0 986 437 368</b>
A640 070 07 87	<b>0 445 110 166</b>
A640 070 07 87	<b>0 986 435 117</b>
A640 070 07 87 80	<b>0 986 435 117</b>
A640 070 11 87	<b>0 445 110 323</b>
A640 070 11 87	<b>0 986 435 187</b>
A640 070 11 87 80	<b>0 986 435 187</b>
A640 070 12 87	<b>0 445 110 377</b>
A640 070 12 87	<b>0 986 435 189</b>
A640 070 12 87 80	<b>0 986 435 189</b>
A642 070 00 01	<b>0 986 437 363</b>

A642 070 03 01	<b>0 986 437 363</b>
A642 070 03 01 0080	<b>0 986 437 363</b>
A642 070 04 87	<b>0 445 115 016</b>
A642 070 05 01	<b>0 986 437 365</b>
A642 070 05 01 0080	<b>0 986 437 365</b>
A642 070 05 87	<b>0 445 115 026</b>
A642 070 05 87	<b>0 986 435 355</b>
A642 070 08 01	<b>0 986 437 340</b>
A642 070 09 01	<b>0 445 010 322</b>
A642 070 09 01	<b>0 986 437 374</b>
A642 070 10 01	<b>0 986 437 340</b>
A642 070 10 87	<b>0 445 115 055</b>
A642 070 11 01	<b>0 445 010 322</b>
A642 070 11 01	<b>0 986 437 374</b>
A642 070 11 87	<b>0 445 116 025</b>
A642 070 11 87	<b>0 986 435 404</b>
A642 070 11 87 80	<b>0 986 435 404</b>
A642 070 12 01	<b>0 986 437 340</b>
A642 070 12 87	<b>0 445 116 027</b>
A642 070 12 87	<b>0 986 435 406</b>
A642 070 12 87 80	<b>0 986 435 406</b>
A642 070 13 01	<b>0 445 010 322</b>
A642 070 13 01	<b>0 986 437 374</b>
A642 070 13 87	<b>0 445 115 063</b>
A642 070 13 87	<b>0 986 435 355</b>
A642 070 13 87 80	<b>0 986 435 355</b>
A642 070 14 87	<b>0 445 115 059</b>
A642 070 14 87	<b>0 986 435 396</b>
A642 070 14 87 80	<b>0 986 435 396</b>
A642 070 15 87	<b>0 445 115 061</b>
A642 070 15 87	<b>0 986 435 398</b>
A642 070 15 87 80	<b>0 986 435 398</b>
A642 070 18 87	<b>0 986 435 355</b>
A642 090 00 48	<b>0 281 002 954</b>
A642 094 01 48	<b>0 281 002 695</b>
A646 070 01 01	<b>0 986 437 364</b>
A646 070 01 01 0080	<b>0 986 437 364</b>
A646 070 01 87	<b>0 445 110 137</b>
A646 070 01 87	<b>0 445 110 138</b>
A646 070 02 87	<b>0 445 110 139</b>
A646 070 02 87	<b>0 986 435 107</b>
A646 070 02 87 0080	<b>0 986 435 107</b>
A646 070 02 87 80	<b>0 986 435 107</b>
A646 070 03 00	<b>0 445 115 089</b>
A646 070 03 01	<b>0 986 437 364</b>
A646 070 04 01	<b>0 986 437 364</b>
A646 070 04 01 0080	<b>0 986 437 364</b>
A646 070 04 87	<b>0 445 110 263</b>
A646 070 04 87	<b>0 986 435 115</b>
A646 070 04 87 0080	<b>0 986 435 115</b>
A646 070 04 87 80	<b>0 986 435 115</b>
A646 070 07 87	<b>0 445 110 237</b>
A646 070 07 87	<b>0 986 435 139</b>
A646 070 07 87 80	<b>0 986 435 139</b>
A646 070 11 87	<b>0 445 115 032</b>





◀ MERCEDES-BENZ

A 646 070 11 87	<b>0 986 435 356</b>
A 646 070 12 87	<b>0 445 110 294</b>
A 646 070 12 87	<b>0 986 435 159</b>
A 646 070 12 87 80	<b>0 986 435 158</b>
A 646 070 12 87 80	<b>0 986 435 159</b>

A 646 070 14 87	<b>0 445 115 068</b>
A 646 070 14 87	<b>0 986 435 356</b>
A 646 070 14 87 80	<b>0 986 435 356</b>
A 646 070 15 87	<b>0 986 435 356</b>
A 646 094 00 48	<b>0 281 002 535</b>

A 647 070 00 87	<b>0 445 110 191</b>
A 647 070 00 87	<b>0 986 435 113</b>
A 647 070 00 87 80	<b>0 986 435 113</b>
A 647 070 01 87	<b>0 445 110 162</b>
A 647 070 01 87 80	<b>0 986 435 109</b>

A 648 070 00 01	<b>0 986 437 364</b>
A 648 070 00 87	<b>0 445 110 128</b>
A 648 070 00 87	<b>0 445 110 155</b>
A 648 070 01 87	<b>0 445 110 155</b>
A 648 070 01 87	<b>0 986 435 135</b>

A 648 070 01 87 0080	<b>0 986 435 135</b>
A 648 070 01 87 80	<b>0 986 435 135</b>
A 648 070 02 01	<b>0 986 437 366</b>
A 648 070 02 01 0080	<b>0 986 437 366</b>
A 648 070 02 87	<b>0 445 110 176</b>

A 648 070 02 87	<b>0 986 435 111</b>
A 648 070 02 87 0080	<b>0 986 435 111</b>
A 648 070 02 87 80	<b>0 986 435 111</b>
A 648 070 03 87	<b>0 445 110 193</b>
A 648 070 03 87	<b>0 986 435 127</b>

A 648 070 03 87 80	<b>0 445 110 193</b>
A 648 070 03 87 80	<b>0 986 435 127</b>
A 651 070 29 87	<b>0 445 117 034</b>
A 651 070 29 87	<b>0 986 435 428</b>
A 651 070 29 87 0080	<b>0 986 435 428</b>

A 651 070 29 87 80	<b>0 986 435 428</b>
A 651 070 31 87	<b>0 445 110 573</b>
A 651 070 31 87	<b>0 986 435 286</b>
A 651 070 31 87 80	<b>0 986 435 286</b>
A 651 070 36 87	<b>0 445 110 571</b>

A 654 070 00 01	<b>0 445 010 735</b>
A 654 070 00 87	<b>0 445 118 008</b>
A 654 070 01 87	<b>0 445 117 047</b>
A 654 070 02 01	<b>0 445 010 778</b>
A 654 070 03 01	<b>0 445 010 757</b>

A 654 070 05 00	<b>0 445 010 795</b>
A 654 070 07 00	<b>0 445 011 515</b>
A 654 070 43 01	<b>0 445 010 735</b>
A 654 070 44 01	<b>0 445 010 778</b>
A 654 070 45 01	<b>0 445 010 757</b>

A 654 070 46 01	<b>0 445 010 795</b>
A 654 070 84 01	<b>0 445 011 515</b>
A 656 070 00 01	<b>0 445 010 836</b>
A 656 070 51 00	<b>0 445 010 836</b>
A 660 070 00 01	<b>0 445 010 273</b>

A 660 070 00 01	<b>0 986 437 019</b>
A 660 070 00 01 0080	<b>0 986 437 019</b>
A 660 070 01 87	<b>0 445 110 022</b>
A 660 070 01 87	<b>0 986 435 008</b>
A 660 070 01 87 0080	<b>0 986 435 008</b>

A 660 070 01 87 80	<b>0 986 435 008</b>
A 660 070 03 87	<b>0 445 110 302</b>
A 660 070 03 87	<b>0 986 435 184</b>
A 664 070 00 01	<b>0 445 010 344</b>
A 664 070 00 01	<b>0 986 437 362</b>

A 664 070 02 01	<b>0 445 010 344</b>
A 664 070 02 01	<b>0 986 437 362</b>
A 664 070 02 01 0080	<b>0 986 437 362</b>
A 668 070 01 87	<b>0 445 110 004</b>
A 668 070 01 87	<b>0 445 110 014</b>

A 668 070 02 87	<b>0 445 110 014</b>
A 668 070 02 87	<b>0 986 435 005</b>
A 668 070 03 01	<b>0 445 010 268</b>
A 668 070 03 01	<b>0 986 437 009</b>
A 668 070 03 01 0080	<b>0 986 437 009</b>

A 668 070 06 87	<b>0 445 110 014</b>
A 668 070 06 87	<b>0 986 435 005</b>
A 668 070 06 87 80	<b>0 986 435 005</b>
A 668 070 08 87	<b>0 445 110 089</b>
A 668 070 08 87	<b>0 445 110 197</b>

A 668 070 08 87	<b>0 986 435 033</b>
A 668 070 08 87	<b>0 986 435 059</b>
A 668 070 08 87 0080	<b>0 986 435 033</b>
A 668 070 08 87 80	<b>0 986 435 059</b>
A 668 070 09 87	<b>0 445 110 115</b>

A 668 070 09 87	<b>0 445 110 195</b>
A 668 070 09 87	<b>0 986 435 057</b>
A 668 070 09 87 0080	<b>0 986 435 057</b>
A 668 070 11 87	<b>0 445 110 197</b>
A 668 070 11 87	<b>0 986 435 059</b>

A 668 070 11 87 0080	<b>0 986 435 059</b>
A 668 070 11 87 80	<b>0 986 435 059</b>
A 668 070 12 87	<b>0 445 110 195</b>
A 668 070 12 87	<b>0 986 435 057</b>
A 668 070 12 87 0080	<b>0 986 435 057</b>

A 668 070 12 87 80	<b>0 986 435 057</b>
A 820 010 31 51	<b>0 432 206 011</b>
HVW 906 490 08 13	<b>0 444 021 022</b>
ME 193334	<b>0 445 020 027</b>
ME 193960	<b>0 445 020 049</b>

ME 193983	<b>0 445 120 091</b>
ME 193983	<b>0 986 435 635</b>
ME 194299	<b>0 445 120 073</b>
ME 223576	<b>0 445 020 029</b>
ME 223750	<b>0 445 120 049</b>

ME 223954	<b>0 445 020 028</b>
ME 225083	<b>0 445 020 050</b>
ME 225416	<b>0 445 120 072</b>
ME 226718	<b>0 445 120 048</b>
ME 227600	<b>0 445 120 090</b>

ME 227600	<b>0 986 435 634</b>
ME 355278	<b>0 445 120 006</b>
ME 355278	<b>0 986 435 632</b>
ME 355505	<b>F 01G 000 00V</b>
ME 356178	<b>0 445 120 058</b>

ME 356178	<b>0 986 435 633</b>
ME 357170	<b>0 445 020 042</b>
ME 358546	<b>0 445 120 109</b>
ME 358546	<b>0 986 435 637</b>
ME 359633	<b>0 444 010 010</b>

ME 556056	<b>0 444 021 014</b>
ME 556056	<b>0 986 44D 320</b>
RA4600700587	<b>0 986 435 540</b>
RA4600701087	<b>0 986 435 540</b>
RA4600701187	<b>0 986 435 537</b>

R5135154AB	<b>0 445 110 181</b>
R5135154AB	<b>0 986 435 053</b>
000 010 05 51	<b>0 432 217 253</b>
000 010 05 51	<b>0 986 430 245</b>
000 010 05 51 80	<b>0 432 217 253</b>

000 010 05 51 80	<b>0 986 430 245</b>
000 010 06 51	<b>0 432 217 280</b>
000 010 06 51	<b>0 986 430 388</b>
000 010 06 51 80	<b>0 986 430 388</b>
000 010 10 51	<b>0 432 217 287</b>

000 010 14 51	<b>0 432 193 558</b>
000 010 15 51	<b>0 432 193 758</b>
000 010 16 51	<b>0 432 193 768</b>
000 010 17 51	<b>0 432 217 287</b>
000 010 17 51	<b>0 986 430 307</b>

000 010 17 51 80	<b>0 986 430 307</b>
000 010 20 51	<b>0 432 193 768</b>
000 010 21 51	<b>0 432 193 758</b>
000 010 47 51	<b>0 432 193 639</b>
000 010 48 51	<b>0 432 193 637</b>

000 010 66 51	<b>0 432 193 625</b>
000 010 67 51	<b>0 432 193 623</b>
000 017 07 12	<b>0 432 231 031</b>
000 017 64 21	<b>0 432 231 886</b>
000 017 64 21	<b>0 986 430 055</b>

000 017 64 21 80	<b>0 986 430 055</b>
000 017 84 21	<b>0 432 207 006</b>
000 017 86 21	<b>0 432 231 887</b>
000 017 86 21	<b>0 986 430 056</b>
000 017 86 21 80	<b>0 986 430 056</b>

000 017 97 21	<b>0 432 231 880</b>
000 094 01 48	<b>0 986 280 121</b>
000 094 01 48 0080	<b>0 986 280 121</b>
000 094 02 48	<b>0 986 280 126</b>
000 094 02 48 0080	<b>0 986 280 126</b>

000 094 04 48	<b>0 986 280 125</b>
000 094 06 48	<b>0 986 280 125</b>
000 094 06 48 0080	<b>0 986 280 125</b>
000 094 10 48	<b>0 280 217 517</b>
000 094 12 48	<b>0 281 002 152</b>

000 094 13 48	<b>0 280 217 523</b>
000 094 14 48	<b>0 281 002 384</b>
000 094 18 48	<b>0 280 218 080</b>
000 094 19 48	<b>0 280 218 081</b>
000 094 20 48	<b>0 281 002 585</b>

000 094 20 48	<b>0 281 002 586</b>
000 094 22 48	<b>0 281 002 656</b>
000 094 32 48	<b>0 281 002 896</b>
000 094 34 48	<b>0 281 002 978</b>
000 470 04 00	<b>F 01C 600 268</b>

000 490 07 13	<b>0 444 021 033</b>
000 490 10 13	<b>0 444 021 031</b>
000 490 11 13	<b>0 444 025 017</b>
000 490 13 13	<b>0 444 025 005</b>
000 490 14 13	<b>0 444 025 008</b>

000 542 96 14	<b>0 281 002 077</b>
000 542 96 14 80	<b>0 281 002 077</b>
001 010 70 51	<b>0 432 191 387</b>
001 017 17 21	<b>0 986 430 053</b>
001 017 17 21 80	<b>0 986 430 053</b>

001 017 21 21 80	<b>0 986 430 020</b>
001 017 27 21	<b>0 432 231 870</b>
001 017 39 21	<b>0 432 390 001</b>
001 017 49 12	<b>0 432 217 157</b>
001 017 52 21	<b>0 432 226 004</b>

001 017 53 21	<b>0 432 231 827</b>
001 017 77 21	<b>0 986 430 171</b>
001 017 77 21 80	<b>0 986 430 171</b>
001 017 81 21	<b>0 986 430 042</b>
001 017 81 21 80	<b>0 986 430 042</b>

001 017 82 21	<b>0 432 231 822</b>
001 017 86 21	<b>0 432 231 824</b>
001 017 86 21	<b>0 986 430 046</b>
001 017 86 21 80	<b>0 986 430 046</b>
001 017 87 21	<b>0 432 231 823</b>

001 017 87 21	<b>0 986 430 045</b>
001 017 87 21 80	<b>0 986 430 045</b>
001 017 98 21	<b>0 986 430 038</b>
001 017 98 21 80	<b>0 986 430 038</b>
001 991 36 71	<b>0 280 218 246</b>

002 010 25 51	<b>0 432 191 278</b>
002 010 31 51	<b>0 432 193 438</b>
002 010 41 51	<b>0 432 191 256</b>
002 010 50 51	<b>0 432 191 258</b>
002 010 51 51	<b>0 432 191 259</b>

002 010 55 21	<b>0 432 191 271</b>
002 010 84 51	<b>0 432 193 459</b>
002 010 85 51	<b>0 432 191 219</b>
002 010 92 51	<b>0 432 193 449</b>
002 017 00 21	<b>0 986 430 038</b>

002 017 00 21 80	<b>0 986 430 038</b>
002 017 12 21	<b>0 432 231 775</b>
002 017 15 21	<b>0 986 430 151</b>
002 017 15 21 80	<b>0 986 430 151</b>
002 017 16 21	<b>0 432 217 131</b>



002 017 18 02	<b>0 432 231 722</b>
002 017 18 12	<b>0 432 217 290</b>
002 017 18 12	<b>0 986 430 505</b>
002 017 18 12 80	<b>0 986 430 505</b>
002 017 20 21	<b>0 986 430 171</b>
002 017 20 21 80	<b>0 986 430 171</b>
002 017 21 21	<b>0 432 231 770</b>
002 017 22 21	<b>0 432 217 131</b>
002 017 22 21	<b>0 986 430 022</b>
002 017 22 21 80	<b>0 986 430 022</b>
002 017 23 21	<b>0 432 217 142</b>
002 017 23 21	<b>0 986 430 020</b>
002 017 23 21 80	<b>0 986 430 020</b>
002 017 26 21	<b>0 432 217 141</b>
002 017 26 21	<b>0 986 430 025</b>
002 017 26 21 80	<b>0 986 430 025</b>
002 017 28 21	<b>0 432 217 147</b>
002 017 28 21	<b>0 986 430 184</b>
002 017 28 21 80	<b>0 432 217 147</b>
002 017 28 21 80	<b>0 986 430 184</b>
002 017 29 21	<b>0 986 430 133</b>
002 017 29 21 80	<b>0 986 430 133</b>
002 017 31 21	<b>9 430 082 291</b>
002 017 33 21	<b>0 986 430 038</b>
002 017 33 21 80	<b>0 986 430 038</b>
002 017 34 21	<b>0 432 217 157</b>
002 017 34 21	<b>0 986 430 197</b>
002 017 34 21 80	<b>0 986 430 197</b>
002 017 36 21	<b>0 432 217 131</b>
002 017 37 21	<b>0 432 217 161</b>
002 017 37 21	<b>0 986 430 172</b>
002 017 37 21 80	<b>0 432 217 161</b>
002 017 37 21 80	<b>0 986 430 172</b>
002 017 40 21	<b>0 986 430 173</b>
002 017 40 21 80	<b>0 986 430 173</b>
002 017 41 21	<b>0 432 206 013</b>
002 017 42 21	<b>0 432 231 760</b>
002 017 42 21	<b>0 986 430 168</b>
002 017 42 21 80	<b>0 986 430 168</b>
002 017 48 21	<b>0 432 231 760</b>
002 017 53 21	<b>9 430 082 297</b>
002 017 58 21	<b>0 432 231 736</b>
002 017 58 21	<b>0 986 430 178</b>
002 017 58 21 80	<b>0 986 430 178</b>
002 017 65 21	<b>0 986 430 038</b>
002 017 72 21	<b>0 432 131 803</b>
002 017 83 21	<b>0 986 430 221</b>
002 017 83 21 80	<b>0 986 430 221</b>
002 017 89 21	<b>0 432 231 722</b>
002 017 89 21	<b>0 986 430 214</b>
002 017 89 21 80	<b>0 986 430 214</b>
002 017 97 21	<b>0 986 430 205</b>
002 017 97 21 80	<b>0 986 430 205</b>
002 070 83 01	<b>0 460 415 992</b>
002 070 83 01	<b>0 986 440 579</b>

002 470 54 94	<b>F 01C 600 155</b>
002 470 54 94	<b>F 01C 600 194</b>
002 470 57 94	<b>F 01C 600 155</b>
002 470 57 94	<b>F 01C 600 194</b>
002 470 68 94	<b>F 01C 600 194</b>
002 470 77 94	<b>F 01C 600 265</b>
003 010 04 51	<b>0 432 193 421</b>
003 010 05 51	<b>0 432 193 419</b>
003 010 09 51	<b>0 432 191 220</b>
003 017 00 21	<b>0 432 231 677</b>
003 017 00 21	<b>0 986 430 211</b>
003 017 00 21 80	<b>0 986 430 211</b>
003 017 01 21	<b>0 986 430 210</b>
003 017 01 21 80	<b>0 986 430 210</b>
003 017 13 21	<b>0 432 231 703</b>
003 017 13 21	<b>0 986 430 168</b>
003 017 13 21 80	<b>0 986 430 168</b>
003 017 14 21	<b>0 432 231 704</b>
003 017 14 21	<b>0 986 430 133</b>
003 017 14 21 80	<b>0 986 430 133</b>
003 017 21 21	<b>0 986 430 246</b>
003 017 21 21 80	<b>0 986 430 246</b>
003 017 26 21	<b>9 430 082 311</b>
003 017 27 21	<b>0 432 131 680</b>
003 017 27 21	<b>9 430 082 319</b>
003 017 29 01	<b>0 432 217 266</b>
003 017 29 21	<b>0 432 217 266</b>
003 017 29 21	<b>0 986 430 247</b>
003 017 29 21 80	<b>0 432 217 266</b>
003 017 29 21 80	<b>0 986 430 247</b>
003 017 30 21	<b>0 432 131 816</b>
003 017 36 21	<b>0 432 231 693</b>
003 017 38 21	<b>9 430 082 316</b>
003 017 44 21	<b>0 432 231 688</b>
003 017 44 21	<b>0 986 430 221</b>
003 017 44 21 80	<b>0 986 430 221</b>
003 017 46 21	<b>0 432 231 687</b>
003 017 46 21	<b>0 986 430 053</b>
003 017 46 21 80	<b>0 986 430 053</b>
003 017 47 21	<b>0 432 231 686</b>
003 017 49 21	<b>0 432 231 684</b>
003 017 49 21	<b>0 986 430 042</b>
003 017 49 21 80	<b>0 986 430 042</b>
003 017 52 21	<b>0 432 231 683</b>
003 017 54 21	<b>0 432 231 681</b>
003 017 55 21	<b>0 432 231 680</b>
003 017 55 21	<b>0 986 430 038</b>
003 017 55 21 80	<b>0 986 430 038</b>
003 017 56 21	<b>0 432 231 679</b>
003 017 57 21	<b>0 432 231 678</b>
003 017 57 21	<b>0 986 430 205</b>
003 017 57 21 80	<b>0 986 430 205</b>
003 017 58 21	<b>0 432 231 677</b>
003 017 58 21	<b>0 986 430 211</b>
003 017 58 21 80	<b>0 986 430 211</b>

003 017 59 21	<b>0 432 231 675</b>
003 017 60 21	<b>0 432 231 676</b>
003 017 60 21	<b>0 986 430 360</b>
003 017 60 21 80	<b>0 986 430 360</b>
003 017 61 21	<b>9 430 082 318</b>
003 017 62 12	<b>0 432 131 645</b>
003 017 64 21	<b>0 432 231 674</b>
003 017 64 21	<b>0 986 430 508</b>
003 017 64 21 80	<b>0 986 430 508</b>
003 017 65 21	<b>0 986 430 507</b>
003 017 65 21 80	<b>0 986 430 507</b>
003 017 70 21	<b>0 432 131 802</b>
003 017 70 21	<b>0 986 430 378</b>
003 017 70 21 80	<b>0 986 430 378</b>
003 017 71 21	<b>0 986 430 265</b>
003 017 71 21 80	<b>0 986 430 265</b>
003 017 72 21	<b>0 986 430 264</b>
003 017 72 21 80	<b>0 986 430 264</b>
003 017 73 21	<b>0 432 131 805</b>
003 017 74 21	<b>0 432 131 804</b>
003 017 75 21	<b>0 432 131 803</b>
003 017 78 21	<b>0 986 430 261</b>
003 017 78 21 80	<b>0 986 430 261</b>
003 017 80 21	<b>0 432 131 797</b>
003 017 85 21	<b>0 432 131 793</b>
003 017 85 21	<b>0 986 430 362</b>
003 017 85 21 80	<b>0 986 430 362</b>
003 017 86 21	<b>0 432 131 794</b>
003 017 86 21	<b>0 986 430 252</b>
003 017 86 21 80	<b>0 986 430 252</b>
003 017 92 21	<b>0 432 131 781</b>
003 017 92 21	<b>0 986 430 361</b>
003 017 92 21 80	<b>0 986 430 361</b>
003 017 93 21	<b>0 432 131 780</b>
003 017 95 21	<b>0 432 217 290</b>
003 017 95 21	<b>0 986 430 505</b>
003 017 95 21 80	<b>0 986 430 505</b>
004 017 05 21	<b>0 432 131 768</b>
004 017 11 21	<b>0 432 191 501</b>
004 017 12 21	<b>0 432 231 659</b>
004 017 12 21	<b>0 986 430 095</b>
004 017 12 21 80	<b>0 986 430 095</b>
004 017 13 21	<b>0 432 231 660</b>
004 017 14 21	<b>0 432 231 663</b>
004 017 14 21	<b>0 986 430 093</b>
004 017 14 21 80	<b>0 986 430 093</b>
004 017 15 21	<b>0 432 231 661</b>
004 017 15 21	<b>0 986 430 092</b>
004 017 15 21 80	<b>0 986 430 092</b>
004 017 16 21	<b>0 432 231 665</b>
004 017 17 21	<b>0 432 231 664</b>
004 017 17 21	<b>0 986 430 094</b>
004 017 17 21 80	<b>0 986 430 094</b>
004 017 18 21	<b>0 432 231 658</b>
004 017 19 21	<b>0 432 231 662</b>

004 017 25 21	<b>9 430 082 768</b>
004 017 27 21	<b>0 432 191 587</b>
004 017 28 21	<b>0 432 131 727</b>
004 017 28 21	<b>0 986 430 325</b>
004 017 28 21 80	<b>0 986 430 325</b>
004 017 29 21	<b>0 432 131 726</b>
004 017 29 21	<b>0 986 430 326</b>
004 017 29 21 80	<b>0 986 430 326</b>
004 017 30 21	<b>0 432 131 728</b>
004 017 30 21	<b>0 986 430 327</b>
004 017 30 21 80	<b>0 986 430 327</b>
004 017 31 21	<b>0 432 131 731</b>
004 017 32 21	<b>0 432 131 730</b>
004 017 33 21	<b>0 432 131 729</b>
004 017 37 21	<b>0 432 191 589</b>
004 017 38 21	<b>0 432 191 551</b>
004 017 47 21	<b>0 432 191 587</b>
004 017 48 21	<b>0 432 193 766</b>
004 017 50 21	<b>0 432 131 707</b>
004 017 50 21	<b>0 986 430 091</b>
004 017 50 21 80	<b>0 986 430 091</b>
004 017 51 21	<b>0 432 131 706</b>
004 017 52 21	<b>0 432 191 554</b>
004 017 54 21	<b>0 432 131 677</b>
004 017 61 21	<b>F 000 439 000</b>
004 017 65 21	<b>0 432 191 278</b>
004 017 65 21	<b>0 432 191 526</b>
004 017 80 21	<b>0 432 131 680</b>
004 017 81 21	<b>0 432 191 489</b>
004 017 82 21	<b>0 432 191 488</b>
004 017 83 21	<b>0 432 191 485</b>
004 017 86 21	<b>0 432 231 599</b>
004 017 86 21	<b>0 986 430 563</b>
004 017 86 21 80	<b>0 986 430 563</b>
004 017 91 21	<b>0 432 191 468</b>
004 017 93 21	<b>0 432 191 463</b>
004 017 94 21	<b>0 432 191 462</b>
004 017 98 21	<b>0 432 191 459</b>
004 074 05 21	<b>0 432 131 768</b>
004 094 34 48	<b>0 281 002 978</b>
004 153 06 28	<b>0 281 002 281</b>
004 153 06 28	<b>0 281 002 282</b>
004 153 73 28	<b>0 281 002 489</b>
005 017 02 21	<b>0 432 191 434</b>
005 017 04 21	<b>0 432 191 442</b>
005 017 06 21	<b>0 432 191 441</b>
005 017 07 21	<b>0 432 191 444</b>
005 017 10 21	<b>0 432 193 583</b>
005 017 11 21	<b>0 432 193 582</b>
005 017 13 21	<b>0 432 191 446</b>
005 017 14 21	<b>0 432 191 437</b>
005 017 22 21	<b>0 432 191 400</b>
005 017 23 21	<b>0 432 191 394</b>
005 017 24 21	<b>0 432 191 396</b>
005 017 25 21	<b>0 432 191 395</b>





◀ MERCEDES-BENZ

005 017 25 21	<b>0 432 191 442</b>	006 017 42 21	<b>0 432 191 256</b>	028 074 69 02 80	<b>0 986 445 103</b>	470 090 21 50	<b>0 445 020 235</b>
005 017 26 21	<b>0 432 191 393</b>	006 017 42 21	<b>0 432 191 260</b>	028 074 86 02	<b>0 414 799 012</b>	470 090 21 50	<b>0 986 437 507</b>
005 017 26 21	<b>0 432 191 444</b>	006 017 43 21	<b>0 432 191 261</b>	028 074 88 02	<b>0 414 799 024</b>	471 070 01 87	<b>0 445 120 194</b>
005 017 32 21	<b>0 432 191 385</b>	006 017 44 21	<b>0 432 191 262</b>	028 074 88 02	<b>0 986 445 022</b>	471 070 01 87	<b>0 986 435 537</b>
005 017 34 21	<b>0 432 131 645</b>	006 017 45 21	<b>0 432 191 263</b>	028 074 88 02 0080	<b>0 986 445 022</b>	471 070 01 87	<b>0 986 435 642</b>
005 017 37 21	<b>0 432 131 646</b>	006 017 47 21	<b>0 432 191 265</b>	028 074 89 02	<b>0 414 799 015</b>	471 070 02 87	<b>0 445 120 194</b>
005 017 39 21	<b>0 432 191 363</b>	006 017 48 21	<b>0 432 191 266</b>	028 074 89 02	<b>0 414 799 030</b>	471 070 02 87	<b>0 986 435 537</b>
005 017 40 21	<b>0 432 191 360</b>	006 017 49 21	<b>0 432 191 267</b>	028 074 89 02	<b>0 986 445 020</b>	471 070 02 87	<b>0 986 435 642</b>
005 017 41 21	<b>0 432 191 359</b>	006 017 50 21	<b>0 432 191 268</b>	028 074 89 02 0080	<b>0 986 445 020</b>	471 070 03 87	<b>0 445 120 194</b>
005 017 44 21	<b>0 432 193 522</b>	006 017 51 21	<b>0 432 191 258</b>	028 074 90 02	<b>0 414 799 029</b>	471 070 03 87	<b>0 986 435 537</b>
005 017 45 21	<b>0 432 191 348</b>	006 017 51 21	<b>0 432 191 269</b>	028 074 90 02	<b>0 986 445 019</b>	471 070 03 87	<b>0 986 435 642</b>
005 017 46 21	<b>0 432 191 347</b>	006 017 52 21	<b>0 432 191 259</b>	028 074 90 02 0080	<b>0 986 445 019</b>	471 070 04 87	<b>0 445 120 270</b>
005 017 47 21	<b>0 432 193 521</b>	006 017 52 21	<b>0 432 191 270</b>	028 074 91 02	<b>0 414 799 017</b>	471 070 04 87	<b>0 986 435 598</b>
005 017 52 21	<b>0 432 131 632</b>	006 017 56 21	<b>0 432 191 248</b>	028 074 91 02	<b>0 414 799 032</b>	471 070 04 87 0080	<b>0 445 120 270</b>
005 017 52 21	<b>0 432 131 645</b>	006 017 57 21	<b>0 432 191 242</b>	028 074 91 02	<b>0 986 445 021</b>	471 070 04 87 0080	<b>0 986 435 598</b>
005 017 52 21	<b>0 986 430 090</b>	006 017 58 21	<b>0 432 191 240</b>	028 074 91 02 0080	<b>0 986 445 021</b>	471 070 04 87 80	<b>0 986 435 598</b>
005 017 52 21 80	<b>0 986 430 090</b>	006 017 65 21	<b>0 432 133 767</b>	028 074 92 02	<b>0 414 799 028</b>	471 070 05 87	<b>0 445 120 287</b>
005 017 53 21	<b>0 432 191 384</b>	006 017 68 21	<b>0 432 193 459</b>	028 074 92 02	<b>0 986 445 018</b>	471 070 05 87	<b>0 986 435 624</b>
005 017 57 21	<b>0 432 191 263</b>	006 017 69 21	<b>0 432 191 238</b>	028 074 92 02 0080	<b>0 986 445 018</b>	471 070 05 87 80	<b>0 986 435 624</b>
005 017 57 21	<b>0 432 191 372</b>	006 017 71 21	<b>0 432 191 237</b>	028 074 94 02	<b>0 414 799 035</b>	471 070 08 87	<b>0 445 120 385</b>
005 017 59 21	<b>0 432 191 370</b>	006 017 75 21	<b>0 432 193 448</b>	028 074 94 02	<b>0 986 445 025</b>	471 070 08 87	<b>0 986 435 647</b>
005 017 60 21	<b>0 432 191 344</b>	006 017 76 21	<b>F 000 439 030</b>	028 074 94 02 0080	<b>0 986 445 025</b>	471 070 08 87 80	<b>0 986 435 647</b>
005 017 65 21	<b>0 432 193 500</b>	006 017 82 21	<b>0 432 191 222</b>	028 074 95 02	<b>0 986 441 024</b>	471 090 08 50	<b>0 445 020 260</b>
005 017 70 21	<b>0 432 191 321</b>	006 017 83 21	<b>0 432 193 437</b>	028 074 96 02	<b>0 414 799 033</b>	472 070 00 87	<b>0 445 120 207</b>
005 017 72 21	<b>0 432 191 316</b>	006 017 84 21	<b>0 432 193 436</b>	028 074 96 02	<b>0 986 445 023</b>	472 070 00 87	<b>0 986 435 539</b>
005 017 74 21	<b>F 000 439 024</b>	006 017 85 21	<b>0 432 193 438</b>	028 074 96 02 0080	<b>0 986 445 023</b>	472 070 03 87	<b>0 445 120 207</b>
005 017 77 21	<b>0 432 191 278</b>	006 017 86 21	<b>0 432 193 442</b>	029 074 16 02	<b>0 414 799 038</b>	472 070 03 87	<b>0 986 435 539</b>
005 017 77 21	<b>0 432 191 304</b>	006 017 88 21	<b>0 432 193 444</b>	046 130 108 C	<b>0 986 440 535</b>	472 070 05 87	<b>0 445 120 207</b>
005 017 78 21	<b>0 432 191 305</b>	006 017 89 21	<b>0 432 193 439</b>	046 130 108 CX	<b>0 986 440 535</b>	472 070 05 87	<b>0 986 435 539</b>
005 017 79 21	<b>0 432 191 307</b>	006 017 90 21	<b>0 432 193 441</b>	050 333 20 AA	<b>0 281 002 779</b>	472 070 07 87	<b>0 445 120 207</b>
005 017 80 21	<b>0 432 191 306</b>	006 017 92 21	<b>0 432 193 445</b>	113 094 01 48	<b>0 280 218 083</b>	472 070 07 87	<b>0 986 435 539</b>
005 017 81 21	<b>0 432 191 308</b>	006 017 96 21	<b>0 432 193 423</b>	164 490 05 13	<b>0 444 021 024</b>	472 070 08 87	<b>0 445 120 207</b>
005 017 82 21	<b>0 432 191 302</b>	006 017 97 21	<b>0 432 193 420</b>	273 094 05 48	<b>0 280 218 190</b>	472 070 08 87	<b>0 986 435 539</b>
005 017 83 21	<b>0 432 191 301</b>	007 017 00 21	<b>0 432 191 216</b>	273 094 06 48	<b>0 280 218 190</b>	472 070 08 87	<b>0 986 435 540</b>
005 017 85 21	<b>0 432 191 303</b>	007 017 01 21	<b>0 432 193 416</b>	273 094 09 48	<b>0 280 218 190</b>	472 070 10 87	<b>0 445 120 302</b>
005 017 86 21	<b>0 432 193 490</b>	026 074 73 02	<b>0 986 445 103</b>	276 094 01 48	<b>0 280 218 246</b>	472 070 10 87	<b>0 986 435 646</b>
005 017 87 21	<b>0 432 193 491</b>	027 074 92 02	<b>0 986 445 103</b>	374 074 05 02	<b>0 460 424 366</b>	472 070 12 87	<b>0 445 120 302</b>
006 017 01 21	<b>0 432 193 484</b>	028 074 23 02	<b>0 460 414 160</b>	374 074 06 02	<b>0 460 424 381</b>	472 070 12 87	<b>0 986 435 646</b>
006 017 02 21	<b>0 432 193 483</b>	028 074 32 02	<b>0 986 445 103</b>	376 017 00 21	<b>0 432 133 762</b>	472 070 12 87 80	<b>0 986 435 646</b>
006 017 03 21	<b>0 432 191 285</b>	028 074 34 02	<b>0 986 445 102</b>	376 017 78 21	<b>9 430 082 771</b>	472 090 08 50	<b>0 445 020 191</b>
006 017 14 21	<b>0 432 193 480</b>	028 074 48 02	<b>0 986 445 103</b>	400 070 01 01	<b>0 445 020 515</b>	472 090 08 50	<b>0 986 437 503</b>
006 017 15 21	<b>0 432 193 481</b>	028 074 49 02	<b>0 460 414 160</b>	400 070 01 87	<b>0 445 110 519</b>	472 090 10 50	<b>0 445 020 237</b>
006 017 16 21	<b>0 432 193 479</b>	028 074 53 02	<b>0 460 414 160</b>	470 070 00 87	<b>0 445 120 298</b>	472 090 15 50	<b>0 445 020 237</b>
006 017 20 21	<b>0 432 191 276</b>	028 074 59 02	<b>0 414 799 025</b>	470 070 00 87	<b>0 986 435 622</b>	472 090 15 50	<b>0 986 437 508</b>
006 017 21 21	<b>0 432 191 277</b>	028 074 59 02	<b>0 986 445 102</b>	470 070 00 87 0080	<b>0 445 120 298</b>	472 090 21 50	<b>0 986 437 507</b>
006 017 22 21	<b>0 432 191 278</b>	028 074 59 02 0080	<b>0 986 445 102</b>	470 070 00 87 0080	<b>0 986 435 622</b>	473 070 02 87	<b>0 445 120 300</b>
006 017 23 21	<b>0 432 193 473</b>	028 074 59 02 80	<b>0 986 445 102</b>	470 070 00 87 80	<b>0 986 435 622</b>	5236 338	<b>0 986 445 102</b>
006 017 24 21	<b>0 432 193 474</b>	028 074 60 02	<b>0 986 445 103</b>	470 090 00 50	<b>0 445 020 198</b>	5236 655	<b>0 986 445 110</b>
006 017 25 21	<b>0 432 191 279</b>	028 074 61 02	<b>0 414 799 026</b>	470 090 00 50	<b>0 986 437 507</b>	5236 658	<b>0 986 445 102</b>
006 017 26 21	<b>0 432 191 280</b>	028 074 61 02	<b>0 986 445 016</b>	470 090 07 50	<b>0 445 020 198</b>	530 130 09 AA	<b>0 281 002 501</b>
006 017 28 21	<b>0 432 191 282</b>	028 074 61 02 0080	<b>0 986 445 016</b>	470 090 07 50	<b>0 986 437 504</b>	555 010 06 51	<b>0 432 231 046</b>
006 017 29 21	<b>0 432 193 475</b>	028 074 62 02	<b>0 460 414 202</b>	470 090 08 50	<b>0 445 020 189</b>	555 010 07 51	<b>0 432 231 762</b>
006 017 30 21	<b>0 432 193 476</b>	028 074 63 02	<b>0 986 445 103</b>	470 090 08 50	<b>0 986 437 507</b>	602 070 77 01	<b>0 986 440 533</b>
006 017 37 21	<b>0 432 193 466</b>	028 074 69 02	<b>0 986 445 103</b>	470 090 15 50	<b>0 445 020 249</b>	602 070 77 01	<b>0 986 440 580</b>
006 017 39 21	<b>0 432 193 467</b>	028 074 69 02 0080	<b>0 986 445 103</b>	470 090 15 50	<b>0 986 437 504</b>	602 070 77 01 80	<b>0 986 440 533</b>



602 070 77 01 80	<b>0 986 440 580</b>
602 070 79 01	<b>0 986 440 530</b>
602 070 79 01	<b>0 986 440 578</b>
602 070 79 01 80	<b>0 986 440 530</b>
602 070 83 01	<b>0 460 415 992</b>
602 070 83 01	<b>0 986 440 531</b>
602 070 83 01	<b>0 986 440 579</b>
602 070 83 01 80	<b>0 986 440 531</b>
602 070 83 01 80	<b>0 986 440 579</b>
602 070 85 01	<b>0 986 440 527</b>
602 070 85 01	<b>0 986 440 577</b>
602 070 85 01 80	<b>0 986 440 527</b>
602 070 87 01	<b>0 986 440 525</b>
602 070 87 01	<b>0 986 440 576</b>
602 070 87 01 80	<b>0 986 440 525</b>
602 070 87 01 80	<b>0 986 440 576</b>
611 070 00 01	<b>0 445 010 268</b>
611 070 00 87	<b>0 445 110 004</b>
611 070 03 01	<b>0 445 010 268</b>
611 070 03 87	<b>0 445 110 004</b>
611 070 03 87	<b>0 445 110 011</b>
611 070 04 01	<b>0 445 010 268</b>
611 070 04 87	<b>0 445 110 011</b>
611 070 04 87	<b>0 986 435 004</b>
611 070 04 87 0080	<b>0 986 435 004</b>
611 070 05 01	<b>0 445 010 268</b>
611 070 05 01	<b>0 986 437 100</b>
611 070 05 01 0080	<b>0 986 437 100</b>
611 070 05 87	<b>0 445 110 011</b>
611 070 05 87	<b>0 986 435 004</b>
611 070 05 87 0080	<b>0 986 435 004</b>
611 070 05 87 38	<b>0 445 110 011</b>
611 070 05 87 38	<b>0 986 435 004</b>
611 070 05 87 80	<b>0 986 435 004</b>
611 070 06 01	<b>0 445 010 269</b>
611 070 06 01	<b>0 986 437 101</b>
611 070 06 01 0080	<b>0 986 437 101</b>
611 070 06 87	<b>0 445 110 024</b>
611 070 06 87	<b>0 986 435 020</b>
611 070 06 87 0080	<b>0 986 435 020</b>
611 070 06 87 38	<b>0 445 110 024</b>
611 070 06 87 38	<b>0 986 435 020</b>
611 070 06 87 80	<b>0 986 435 020</b>
611 070 07 01	<b>0 445 010 272</b>
611 070 07 01	<b>0 986 437 103</b>
611 070 07 01 0080	<b>0 986 437 103</b>
611 070 08 87	<b>0 445 110 069</b>
611 070 08 87	<b>0 445 110 105</b>
611 070 08 87	<b>0 986 435 045</b>
611 070 08 87	<b>0 986 435 158</b>
611 070 08 87 80	<b>0 986 435 045</b>
611 070 09 01	<b>0 445 010 274</b>
611 070 09 01	<b>0 986 437 100</b>
611 070 09 01 0080	<b>0 986 437 100</b>
611 070 09 87	<b>0 445 110 071</b>

611 070 09 87	<b>0 445 110 099</b>
611 070 09 87	<b>0 986 435 041</b>
611 070 09 87	<b>0 986 435 071</b>
611 070 09 87 0080	<b>0 986 435 071</b>
611 070 09 87 80	<b>0 986 435 041</b>
611 070 11 87	<b>0 445 110 054</b>
611 070 11 87	<b>0 986 435 133</b>
611 070 11 87 80	<b>0 986 435 133</b>
611 070 12 87	<b>0 445 110 105</b>
611 070 12 87	<b>0 445 110 170</b>
611 070 12 87	<b>0 986 435 045</b>
611 070 12 87	<b>0 986 435 164</b>
611 070 12 87 0080	<b>0 986 435 045</b>
611 070 12 87 80	<b>0 986 435 045</b>
611 070 12 87 80	<b>0 986 435 164</b>
611 070 13 87	<b>0 445 110 099</b>
611 070 13 87	<b>0 445 110 199</b>
611 070 13 87	<b>0 986 435 041</b>
611 070 13 87 0080	<b>0 986 435 041</b>
611 070 13 87 80	<b>0 986 435 041</b>
611 070 14 01	<b>0 986 437 364</b>
611 070 14 87	<b>0 445 110 107</b>
611 070 14 87	<b>0 445 110 189</b>
611 070 14 87	<b>0 986 435 047</b>
611 070 14 87	<b>0 986 435 055</b>
611 070 14 87 0080	<b>0 986 435 047</b>
611 070 14 87 80	<b>0 986 435 055</b>
611 070 16 87	<b>0 445 110 189</b>
611 070 16 87	<b>0 986 435 055</b>
611 070 16 87 0080	<b>0 986 435 055</b>
611 070 16 87 06	<b>0 445 110 189</b>
611 070 16 87 06	<b>0 986 435 055</b>
611 070 16 87 80	<b>0 986 435 055</b>
611 070 17 87	<b>0 445 110 199</b>
611 070 17 87	<b>0 986 435 061</b>
611 070 17 87 0080	<b>0 986 435 061</b>
611 070 17 87 80	<b>0 986 435 061</b>
611 070 17 87 80	<b>0 986 435 071</b>
612 070 00 01	<b>0 445 010 271</b>
612 070 00 01	<b>0 986 437 104</b>
612 070 00 01 0080	<b>0 986 437 104</b>
612 070 00 87	<b>0 445 110 097</b>
612 070 00 87	<b>0 445 110 203</b>
612 070 00 87	<b>0 986 435 039</b>
612 070 00 87 0080	<b>0 986 435 039</b>
612 070 01 01	<b>0 445 010 275</b>
612 070 01 01	<b>0 986 437 106</b>
612 070 01 01 0080	<b>0 986 437 106</b>
612 070 02 87	<b>0 445 110 151</b>
612 070 03 87	<b>0 445 110 170</b>
612 070 03 87	<b>0 445 110 181</b>
612 070 03 87	<b>0 986 435 053</b>
612 070 03 87	<b>0 986 435 164</b>
612 070 03 87 80	<b>0 986 435 053</b>
612 070 03 87 80	<b>0 986 435 164</b>

612 070 04 87	<b>0 445 110 181</b>
612 070 04 87	<b>0 986 435 053</b>
612 070 04 87 0080	<b>0 986 435 053</b>
612 070 04 87 80	<b>0 986 435 053</b>
612 070 05 87	<b>0 445 110 203</b>
612 070 05 87	<b>0 986 435 065</b>
612 070 05 87 0080	<b>0 986 435 065</b>
612 070 05 87 06	<b>0 445 110 203</b>
612 070 05 87 06	<b>0 986 435 065</b>
612 070 05 87 80	<b>0 986 435 065</b>
613 070 00 01	<b>0 445 010 270</b>
613 070 00 01	<b>0 986 437 102</b>
613 070 00 01 0080	<b>0 986 437 102</b>
613 070 01 87	<b>0 445 110 034</b>
613 070 01 87	<b>0 445 110 095</b>
613 070 01 87	<b>0 986 435 012</b>
613 070 01 87	<b>0 986 435 037</b>
613 070 01 87 0080	<b>0 986 435 012</b>
613 070 05 87	<b>0 445 110 095</b>
613 070 05 87	<b>0 445 110 201</b>
613 070 05 87	<b>0 986 435 037</b>
613 070 05 87	<b>0 986 435 063</b>
613 070 05 87 80	<b>0 986 435 063</b>
613 070 06 87	<b>0 445 110 120</b>
613 070 06 87	<b>0 445 110 121</b>
613 070 06 87	<b>0 986 435 051</b>
613 070 06 87 0080	<b>0 986 435 051</b>
613 070 08 87	<b>0 445 110 201</b>
613 070 08 87	<b>0 986 435 063</b>
613 070 08 87 0080	<b>0 986 435 063</b>
613 070 08 87 80	<b>0 986 435 063</b>
613 070 09 87	<b>0 445 110 205</b>
613 070 09 87	<b>0 986 435 067</b>
613 070 09 87 0080	<b>0 986 435 067</b>
613 070 09 87 80	<b>0 986 435 067</b>
628 070 01 01	<b>0 445 010 334</b>
628 070 01 01	<b>0 986 437 360</b>
628 070 01 01 0080	<b>0 986 437 360</b>
628 070 01 87	<b>0 445 110 045</b>
628 070 01 87	<b>0 445 110 073</b>
628 070 02 87	<b>0 445 110 073</b>
628 070 02 87	<b>0 986 435 031</b>
628 070 02 87 0080	<b>0 986 435 031</b>
628 070 02 87 80	<b>0 986 435 031</b>
628 070 03 87	<b>0 445 110 093</b>
628 070 03 87	<b>0 986 435 035</b>
628 070 03 87 0080	<b>0 986 435 035</b>
628 070 03 87 80	<b>0 986 435 035</b>
628 070 04 87	<b>0 445 110 103</b>
628 070 04 87	<b>0 986 435 043</b>
628 070 04 87 0080	<b>0 986 435 043</b>
628 070 04 87 80	<b>0 986 435 043</b>
628 070 04 87 80	<b>0 986 435 069</b>
628 070 05 87	<b>0 445 110 207</b>
628 070 05 87	<b>0 986 435 069</b>

628 979 95 87 0080	<b>0 986 435 069</b>
629 070 00 01	<b>0 986 437 367</b>
629 070 00 01 0080	<b>0 986 437 367</b>
629 070 00 87	<b>0 445 115 014</b>
629 070 02 87	<b>0 445 115 065</b>
629 070 02 87	<b>0 986 435 400</b>
629 070 02 87 80	<b>0 986 435 400</b>
639 070 02 87	<b>0 445 110 267</b>
640 070 06 01	<b>0 986 437 368</b>
640 070 06 87	<b>0 445 110 166</b>
640 070 06 87	<b>0 986 435 117</b>
640 070 07 01	<b>0 986 437 368</b>
640 070 07 01 0080	<b>0 986 437 368</b>
640 070 07 87	<b>0 445 110 166</b>
640 070 07 87	<b>0 986 435 117</b>
640 070 07 87 80	<b>0 986 435 117</b>
640 070 11 87	<b>0 445 110 323</b>
640 070 11 87	<b>0 986 435 187</b>
640 070 11 87 80	<b>0 986 435 187</b>
640 070 12 87	<b>0 445 110 377</b>
640 070 12 87	<b>0 986 435 189</b>
640 070 12 87 80	<b>0 986 435 189</b>
642 070 00 01	<b>0 986 437 363</b>
642 070 03 01	<b>0 986 437 363</b>
642 070 03 01 0080	<b>0 986 437 363</b>
642 070 04 87	<b>0 445 115 016</b>
642 070 05 01	<b>0 986 437 365</b>
642 070 05 01 0080	<b>0 986 437 365</b>
642 070 05 87	<b>0 445 115 026</b>
642 070 05 87	<b>0 986 435 355</b>
642 070 08 01	<b>0 986 437 340</b>
642 070 09 01	<b>0 445 010 322</b>
642 070 09 01	<b>0 986 437 374</b>
642 070 10 01	<b>0 986 437 340</b>
642 070 10 87	<b>0 445 115 055</b>
642 070 11 01	<b>0 445 010 322</b>
642 070 11 01	<b>0 986 437 374</b>
642 070 11 87	<b>0 445 116 025</b>
642 070 11 87	<b>0 986 435 404</b>
642 070 11 87 80	<b>0 986 435 404</b>
642 070 12 01	<b>0 986 437 340</b>
642 070 12 87	<b>0 445 116 027</b>
642 070 12 87	<b>0 986 435 406</b>
642 070 12 87 80	<b>0 986 435 406</b>
642 070 13 01	<b>0 445 010 322</b>
642 070 13 01	<b>0 986 437 374</b>
642 070 13 87	<b>0 445 115 063</b>
642 070 13 87	<b>0 986 435 355</b>
642 070 13 87 80	<b>0 986 435 355</b>
642 070 14 87	<b>0 445 115 059</b>
642 070 14 87	<b>0 986 435 396</b>
642 070 14 87 80	<b>0 986 435 396</b>
642 070 15 87	<b>0 445 115 061</b>
642 070 15 87	<b>0 986 435 398</b>
642 070 15 87 80	<b>0 986 435 398</b>



◀ MERCEDES-BENZ

642 070 18 87	<b>0 986 435 355</b>
642 090 00 48	<b>0 281 002 954</b>
642 094 01 48	<b>0 281 002 695</b>
646 070 01 01	<b>0 986 437 364</b>
646 070 01 01 0080	<b>0 986 437 364</b>

646 070 01 87	<b>0 445 110 137</b>
646 070 01 87	<b>0 445 110 138</b>
646 070 02 87	<b>0 445 110 139</b>
646 070 02 87	<b>0 986 435 107</b>
646 070 02 87 0080	<b>0 986 435 107</b>

646 070 02 87 80	<b>0 986 435 107</b>
646 070 03 00	<b>0 445 115 089</b>
646 070 03 01	<b>0 986 437 364</b>
646 070 04 01	<b>0 986 437 364</b>
646 070 04 01 0080	<b>0 986 437 364</b>

646 070 04 87	<b>0 445 110 263</b>
646 070 04 87	<b>0 986 435 115</b>
646 070 04 87 0080	<b>0 986 435 115</b>
646 070 04 87 80	<b>0 986 435 115</b>
646 070 07 87	<b>0 445 110 237</b>

646 070 07 87	<b>0 986 435 139</b>
646 070 07 87 80	<b>0 986 435 139</b>
646 070 11 87	<b>0 445 115 032</b>
646 070 11 87	<b>0 986 435 356</b>
646 070 12 87	<b>0 445 110 294</b>

646 070 12 87	<b>0 986 435 159</b>
646 070 12 87 80	<b>0 986 435 158</b>
646 070 12 87 80	<b>0 986 435 159</b>
646 070 14 87	<b>0 445 115 068</b>
646 070 14 87	<b>0 986 435 356</b>

646 070 14 87 80	<b>0 986 435 356</b>
646 070 15 87	<b>0 986 435 356</b>
646 094 00 48	<b>0 281 002 535</b>
647 070 00 87	<b>0 445 110 191</b>
647 070 00 87	<b>0 986 435 113</b>

647 070 00 87 80	<b>0 986 435 113</b>
647 070 01 87	<b>0 445 110 162</b>
647 070 01 87 80	<b>0 986 435 109</b>
648 070 00 01	<b>0 986 437 364</b>
648 070 00 87	<b>0 445 110 128</b>

648 070 00 87	<b>0 445 110 155</b>
648 070 01 87	<b>0 445 110 155</b>
648 070 01 87	<b>0 986 435 135</b>
648 070 01 87 0080	<b>0 986 435 135</b>
648 070 01 87 80	<b>0 986 435 135</b>

648 070 02 01	<b>0 986 437 366</b>
648 070 02 01 0080	<b>0 986 437 366</b>
648 070 02 87	<b>0 445 110 176</b>
648 070 02 87	<b>0 986 435 111</b>
648 070 02 87 0080	<b>0 986 435 111</b>

648 070 02 87 80	<b>0 986 435 111</b>
648 070 03 87	<b>0 445 110 193</b>
648 070 03 87	<b>0 986 435 127</b>
648 070 03 87 80	<b>0 445 110 193</b>
648 070 03 87 80	<b>0 986 435 127</b>

651 070 29 87	<b>0 445 117 034</b>
651 070 29 87	<b>0 986 435 428</b>
651 070 29 87 0080	<b>0 986 435 428</b>
651 070 29 87 80	<b>0 986 435 428</b>
651 070 31 87	<b>0 445 110 573</b>

651 070 31 87	<b>0 986 435 286</b>
651 070 31 87 80	<b>0 986 435 286</b>
651 070 36 87	<b>0 445 110 571</b>
654 070 00 01	<b>0 445 010 735</b>
654 070 00 87	<b>0 445 118 008</b>

654 070 01 87	<b>0 445 117 047</b>
654 070 02 01	<b>0 445 010 778</b>
654 070 03 01	<b>0 445 010 757</b>
654 070 05 00	<b>0 445 010 795</b>
654 070 07 00	<b>0 445 011 515</b>

654 070 43 01	<b>0 445 010 735</b>
654 070 44 01	<b>0 445 010 778</b>
654 070 45 01	<b>0 445 010 757</b>
654 070 46 01	<b>0 445 010 795</b>
654 070 84 01	<b>0 445 011 515</b>

656 070 00 01	<b>0 445 010 836</b>
656 070 51 00	<b>0 445 010 836</b>
660 070 00 01	<b>0 445 010 273</b>
660 070 00 01	<b>0 986 437 019</b>
660 070 00 01 0080	<b>0 986 437 019</b>

660 070 01 87	<b>0 445 110 022</b>
660 070 01 87	<b>0 986 435 008</b>
660 070 01 87 0080	<b>0 986 435 008</b>
660 070 01 87 80	<b>0 986 435 008</b>
660 070 03 87	<b>0 445 110 302</b>

660 070 03 87	<b>0 986 435 184</b>
664 070 00 01	<b>0 445 010 344</b>
664 070 00 01	<b>0 986 437 362</b>
664 070 02 01	<b>0 445 010 344</b>
664 070 02 01	<b>0 986 437 362</b>

664 070 02 01 0080	<b>0 986 437 362</b>
668 070 01 87	<b>0 445 110 004</b>
668 070 01 87	<b>0 445 110 014</b>
668 070 02 87	<b>0 445 110 014</b>
668 070 02 87	<b>0 986 435 005</b>

668 070 03 01	<b>0 445 010 268</b>
668 070 03 01	<b>0 986 437 009</b>
668 070 03 01 0080	<b>0 986 437 009</b>
668 070 06 87	<b>0 445 110 014</b>
668 070 06 87	<b>0 986 435 005</b>

668 070 06 87 80	<b>0 986 435 005</b>
668 070 08 87	<b>0 445 110 089</b>
668 070 08 87	<b>0 445 110 197</b>
668 070 08 87	<b>0 986 435 033</b>
668 070 08 87	<b>0 986 435 059</b>

668 070 08 87 0080	<b>0 986 435 033</b>
668 070 08 87 80	<b>0 986 435 059</b>
668 070 09 87	<b>0 445 110 115</b>
668 070 09 87	<b>0 445 110 195</b>
668 070 09 87	<b>0 986 435 057</b>

668 070 09 87 0080	<b>0 986 435 057</b>
668 070 11 87	<b>0 445 110 197</b>
668 070 11 87	<b>0 986 435 059</b>
668 070 11 87 0080	<b>0 986 435 059</b>
668 070 11 87 80	<b>0 986 435 059</b>

668 070 12 87	<b>0 445 110 195</b>
668 070 12 87	<b>0 986 435 057</b>
668 070 12 87 0080	<b>0 986 435 057</b>
668 070 12 87 80	<b>0 986 435 057</b>
820 010 31 51	<b>0 432 206 011</b>

<b>METZGER</b>	
0890188	<b>0 281 002 549</b>
0890190	<b>0 281 002 896</b>
0890191	<b>0 281 002 403</b>

0890193	<b>0 281 002 184</b>
0890194	<b>0 281 002 792</b>
0890200	<b>0 281 002 195</b>
0890206	<b>0 281 002 478</b>
0890208	<b>0 281 002 620</b>

0890215	<b>0 281 002 318</b>
0890216	<b>0 281 006 248</b>
0890221	<b>0 281 002 281</b>
0890223	<b>0 281 002 585</b>
0890224	<b>0 281 002 152</b>

0890227	<b>0 281 002 489</b>
0890234	<b>0 281 002 384</b>
0890241	<b>0 281 002 447</b>
0890243	<b>0 281 002 721</b>
0890244	<b>0 281 002 980</b>

0890245	<b>0 281 002 861</b>
0890249	<b>0 281 002 600</b>
0890251	<b>0 281 006 048</b>
0890253	<b>0 281 002 849</b>
0890253	<b>0 281 002 936</b>

0890254	<b>0 281 002 956</b>
0890256	<b>0 281 002 917</b>
0890257	<b>0 281 002 936</b>
0890261	<b>0 281 002 723</b>
0890262	<b>0 281 006 054</b>

0890264	<b>0 281 002 849</b>
0890264	<b>0 281 002 936</b>
0890265	<b>0 281 002 764</b>
0890268	<b>0 281 002 216</b>
0890269	<b>0 281 002 757</b>

0890269	<b>0 986 284 010</b>
0890270	<b>0 281 002 463</b>
0890278	<b>0 281 002 403</b>
0890284	<b>0 281 002 318</b>
0891001	<b>0 281 002 479</b>

0891012	<b>0 281 002 683</b>
0891014	<b>0 281 002 428</b>
0891039	<b>0 281 002 447</b>
0891040	<b>0 281 002 554</b>
0891050	<b>0 281 002 309</b>

0891053	<b>0 281 002 180</b>
0891054	<b>0 281 002 613</b>
0891055	<b>0 281 002 461</b>
0891057	<b>0 281 002 308</b>
0891064	<b>0 281 002 429</b>

0891071	<b>0 281 002 757</b>
0891071	<b>0 986 284 010</b>
0891072	<b>0 281 002 461</b>
0891073	<b>0 281 002 216</b>
0891074	<b>0 281 002 535</b>

0891077	<b>0 281 002 463</b>
0891085	<b>0 281 002 610</b>
0891089	<b>0 281 002 571</b>
0891090	<b>0 281 002 139</b>
0891094	<b>0 281 002 963</b>

2240463	<b>0 281 002 478</b>

<b>MEYLE</b>	
614 639 0009	<b>0 281 002 478</b>

<b>MG</b>	
MHK 1011 30	<b>0 928 400 520</b>
MKG 1002 70	<b>0 445 110 030</b>
MKG 1002 70	<b>0 986 435 011</b>

MSC 1007 60	<b>0 432 193 571</b>
MSC 1007 70	<b>0 432 193 601</b>
MSR 1003 10	<b>0 470 004 005</b>
MSR 1003 10	<b>0 986 444 503</b>
MSR 1003 20	<b>0 445 010 011</b>

MSR 1003 20	<b>0 986 437 006</b>

<b>MINI (BMW)</b>	
1351 8472 282	<b>0 445 010 767</b>
1351 8573 249	<b>0 445 010 554</b>
1351 8573 249	<b>0 986 437 425</b>

1351 8577 648	<b>0 445 010 554</b>
1351 8577 648	<b>0 986 437 425</b>
1353 7798 446	<b>0 445 110 289</b>
1353 7798 446	<b>0 445 110 600</b>
1353 7798 446	<b>0 445 110 601</b>

1353 7798 446	<b>0 986 435 179</b>
1353 7798 446	<b>0 986 435 245</b>
1353 7804 978	<b>0 445 110 259</b>
1353 7812 881	<b>0 445 110 289</b>
1353 7812 881	<b>0 445 110 600</b>



13 53 7 812 881	<b>0 445 110 601</b>
13 53 7 812 881	<b>0 986 435 179</b>
13 53 7 812 881	<b>0 986 435 245</b>
13 53 8 506 902	<b>0 445 110 401</b>
13 53 8 506 902	<b>0 445 110 600</b>

13 53 8 506 902	<b>0 986 435 210</b>
13 53 8 506 902	<b>0 986 435 245</b>
13 53 8 506 903	<b>0 445 110 401</b>
13 53 8 506 903	<b>0 445 110 600</b>
13 53 8 506 903	<b>0 986 435 210</b>

13 53 8 506 903	<b>0 986 435 245</b>
13 53 8 511 630	<b>0 445 110 598</b>
13 53 8 514 146	<b>0 445 110 613</b>
13 53 8 514 148	<b>0 445 110 570</b>
13 53 8 514 148	<b>0 445 110 712</b>

13 53 8 514 148	<b>0 986 435 261</b>
13 53 8 515 060	<b>0 445 110 503</b>
13627542418	<b>0 280 218 205</b>
13627582553	<b>0 280 218 228</b>
13 62 7 790 657	<b>0 281 002 621</b>

**MITSUBISHI**

MD050590	<b>9 430 610 005</b>
MD074540	<b>9 430 610 399</b>
MD076156	<b>9 460 610 168</b>

MD103301	<b>9 430 610 154</b>
MD103301	<b>9 430 610 407</b>
MD103301CKD	<b>9 430 610 154</b>
MD155249	<b>9 460 611 395</b>
MD155257	<b>9 460 610 625</b>

MD155261	<b>9 460 611 276</b>
MD171997	<b>9 460 610 508</b>
MD196607	<b>9 430 610 179</b>
MD196607KD	<b>9 430 610 424</b>
MD301928	<b>9 460 610 779</b>

MD304869	<b>9 460 610 871</b>
MD306838	<b>9 460 610 692</b>
MD306845	<b>9 460 610 694</b>
MD311775	<b>9 460 611 605</b>
MD311784	<b>9 460 610 671</b>

MD313057	<b>9 460 610 724</b>
MD323061	<b>9 460 610 924</b>
MD323852	<b>9 460 610 926</b>
MD342303	<b>9 460 611 401</b>
MD347795	<b>9 460 614 159</b>

MD354508	<b>9 460 613 234</b>
MD362557	<b>9 460 613 248</b>
ME015190	<b>9 430 612 551</b>
ME016303	<b>9 430 612 410</b>
ME016305	<b>9 430 613 291</b>

ME016317	<b>9 430 613 315</b>
ME016655	<b>9 430 612 516</b>
ME016983	<b>9 430 612 507</b>
ME016986	<b>9 430 612 540</b>
ME016987	<b>9 430 613 057</b>

ME017739	<b>9 430 612 389</b>
ME017801	<b>9 430 610 046</b>
ME019714	<b>9 430 612 387</b>
ME035748	<b>9 430 610 971</b>
ME035966	<b>9 430 612 971</b>

ME036290	<b>9 430 611 295</b>
ME046101	<b>9 430 611 013</b>
ME047880	<b>9 430 611 464</b>
ME056265	<b>9 430 610 939</b>
ME056275	<b>9 430 613 826</b>

ME056542	<b>9 430 611 092</b>
ME059532	<b>9 430 610 882</b>
ME059621	<b>9 430 610 106</b>
ME066499	<b>9 430 613 770</b>
ME066931	<b>9 430 613 777</b>

ME070762	<b>9 430 611 396</b>
ME072662	<b>9 430 612 936</b>
ME075405	<b>9 430 611 898</b>
ME075406	<b>9 430 612 791</b>
ME075408	<b>9 430 611 904</b>

ME075409	<b>9 430 611 893</b>
ME075518	<b>9 430 610 513</b>
ME075530	<b>9 430 611 913</b>
ME075761	<b>9 430 612 792</b>
ME076087	<b>9 430 611 126</b>

ME076205	<b>9 430 611 130</b>
ME076742	<b>9 430 613 029</b>
ME076952	<b>9 430 612 785</b>
ME076953	<b>9 430 612 776</b>
ME080082	<b>9 430 612 412</b>

ME080329	<b>9 430 613 317</b>
ME080501	<b>9 430 612 531</b>
ME086541	<b>9 430 612 436</b>
ME091275	<b>9 430 613 773</b>
ME093171	<b>9 430 611 894</b>

ME093732	<b>9 430 611 922</b>
ME094539	<b>9 430 613 612</b>
ME121204	<b>9 430 611 905</b>
ME121216	<b>9 430 611 906</b>
ME121324	<b>9 430 611 917</b>

ME131608	<b>9 430 611 965</b>
ME150595	<b>9 430 611 892</b>
ME150796	<b>9 430 611 910</b>
ME150862	<b>9 430 613 899</b>
ME153101	<b>9 430 613 993</b>

ME161080	<b>9 430 611 621</b>
ME161177	<b>9 430 611 902</b>
ME161389	<b>9 430 611 909</b>
ME190513	<b>9 460 614 418</b>
ME190514	<b>9 460 614 419</b>

ME190515	<b>9 460 614 420</b>
ME190694	<b>9 430 613 413</b>
ME190861	<b>9 430 613 409</b>
ME191198	<b>9 430 613 543</b>
ME191379	<b>9 430 613 739</b>

ME192242	<b>0 445 020 027</b>
ME192736	<b>0 445 120 047</b>
ME193960	<b>0 445 020 049</b>
ME193983	<b>0 445 120 091</b>
ME193983	<b>0 986 435 635</b>

ME200204	<b>9 430 610 420</b>
ME200527	<b>9 430 610 422</b>
ME201115	<b>9 460 614 156</b>
ME201683	<b>9 460 610 755</b>
ME202093	<b>9 460 611 722</b>

ME202411	<b>9 460 611 852</b>
ME202614	<b>9 460 613 827</b>
ME202631	<b>9 460 611 404</b>
ME202651	<b>9 460 613 861</b>
ME203712	<b>9 430 610 242</b>

ME203961	<b>9 430 613 989</b>
ME204431	<b>9 460 614 417</b>
ME219131	<b>9 430 613 524</b>
ME221816	<b>0 445 020 028</b>
ME221915	<b>0 445 020 029</b>

ME222914	<b>0 445 120 048</b>
ME223002	<b>0 445 120 049</b>
ME225083	<b>0 445 020 050</b>
ME225190	<b>0 445 120 090</b>
ME225190	<b>0 986 435 634</b>

ME351393	<b>F 01G 000 000</b>
ME355278	<b>0 445 120 006</b>
ME355278	<b>0 986 435 632</b>
ME355360	<b>0 445 020 042</b>
ME357507	<b>0 444 012 007</b>

ME357729	<b>0 444 012 006</b>
ME440089	<b>9 430 613 825</b>
ME440837	<b>9 430 613 530</b>
ME556056	<b>0 444 021 014</b>
ME556056	<b>0 986 44D 320</b>

ME705431	<b>9 430 615 061</b>
ME705443	<b>9 430 615 063</b>
MN128542	<b>9 430 613 643</b>
MN980235	<b>0 414 720 454</b>
MX909965	<b>0 445 110 519</b>

QC000178	<b>0 445 110 248</b>
0423400060	<b>9 430 611 771</b>
0423410060	<b>9 430 611 772</b>
1525A005	<b>0 280 218 162</b>
3096131010	<b>9 430 610 764</b>

3096199090	<b>9 430 610 745</b>
3126130020	<b>9 430 613 767</b>
3126169053	<b>9 430 610 761</b>
3129642102	<b>9 430 610 768</b>
3129653401	<b>9 430 610 777</b>

4D55	<b>9 460 610 004</b>
4D56	<b>9 460 610 205</b>
4D56	<b>9 460 610 207</b>
4D56	<b>9 460 610 234</b>
4D56	<b>9 460 610 235</b>

4D56	<b>9 460 610 236</b>
4D56	<b>9 460 610 237</b>
4D56	<b>9 460 610 238</b>
4D56	<b>9 460 610 239</b>
4D56	<b>9 460 610 296</b>

4D56	<b>9 460 610 300</b>
4D56	<b>9 460 610 301</b>
4D56	<b>9 460 610 303</b>
4D56	<b>9 460 610 318</b>
4D65	<b>9 430 610 050</b>

6D15	<b>9 430 610 842</b>
6D22T	<b>9 430 611 092</b>

**MITSUBISHI FUSO TRUCK & BUS CO**

A4301400039	<b>0 444 043 195</b>
ME194299	<b>0 445 120 073</b>

ME194299	<b>0 986 435 550</b>
ME225083	<b>0 445 020 050</b>
ME225416	<b>0 445 120 072</b>
ME230534	<b>0 445 020 531</b>
ME355793	<b>0 445 120 058</b>

ME355793	<b>0 986 435 633</b>
ME357506	<b>0 444 011 008</b>
ME357728	<b>0 445 120 109</b>
ME357728	<b>0 986 435 637</b>
ME358150	<b>0 444 010 010</b>

ME359633	<b>0 444 010 010</b>
ME360240	<b>0 444 011 017</b>
ME360241	<b>0 444 011 018</b>
ME360242	<b>0 444 011 019</b>
ME360243	<b>0 444 011 020</b>

ME994980	<b>9 430 610 154</b>
ML239174V	<b>F 01C 600 211</b>
MX909965	<b>0 445 110 519</b>
QC000178	<b>0 445 110 248</b>
239174	<b>F 01C 600 211</b>

**MITSUBISHI HEAVY**

EZ41062	<b>9 430 610 893</b>
EZ41064	<b>9 430 610 895</b>
EZ41065	<b>9 430 610 904</b>

H7261A010A	<b>9 430 610 959</b>
H8361A010A	<b>9 430 612 965</b>
ME047880	<b>9 430 611 464</b>
0423400080	<b>9 430 611 773</b>
0423401012	<b>9 430 615 047</b>

31F6100010	<b>0 445 110 453</b>
31F6100011	<b>0 445 110 606</b>
31F6100020	<b>0 445 110 452</b>
31F6100021	<b>0 445 110 607</b>
32A6500460	<b>F 01G 09W 0EL</b>





◀ MITSUBISHI HEAVY

32A6510440	<b>F 01G 09W OGE</b>
32G6100010	<b>0 445 120 126</b>
32G6100300	<b>0 445 020 083</b>
32K6100010	<b>0 445 110 451</b>
32K6100011	<b>0 445 110 610</b>

32K6500010	<b>0 445 020 506</b>
32R6100010	<b>0 445 110 536</b>
32R61-10010	<b>0 445 110 603</b>
32R6500100	<b>0 445 020 608</b>
3256155010	<b>9 430 611 329</b>

3256156050	<b>9 430 611 345</b>
3256159010	<b>9 430 611 027</b>
3256165010	<b>9 430 611 330</b>
3266101060	<b>9 430 613 831</b>
3266101070	<b>9 430 613 717</b>

33A6103090	<b>H 105 160 558</b>
33F6101020	<b>9 430 613 787</b>
34A6006040	<b>9 430 613 574</b>
34A6108060	<b>9 430 613 551</b>
34A6108070	<b>9 430 613 474</b>

3436102010	<b>9 430 612 553</b>
3436103010	<b>9 430 613 126</b>
3436106070	<b>9 430 613 575</b>
3436111010	<b>9 430 612 541</b>
3436111020	<b>9 430 612 541</b>

35A6100030	<b>9 430 613 194</b>
35A6100040	<b>9 430 611 828</b>
35A6100050	<b>9 430 611 818</b>
35A6100060	<b>9 430 611 817</b>
35A6100080	<b>9 430 610 518</b>

35A6101030	<b>9 430 613 550</b>
35A6101050	<b>9 430 613 719</b>
35A6110050	<b>9 430 611 822</b>
35A6150040	<b>9 430 613 347</b>
35A6160030	<b>9 430 611 850</b>

3626101080	<b>9 430 612 958</b>
3626111080	<b>9 430 611 024</b>
3626131080	<b>9 430 611 357</b>
3626215070	<b>9 430 613 604</b>
3626225070	<b>9 430 613 830</b>

3629823080	<b>9 430 610 941</b>
3636100060	<b>9 430 613 626</b>
3676105080	<b>9 430 612 499</b>
4106104000	<b>9 430 612 211</b>
4106104001	<b>9 430 613 792</b>

4106108000	<b>9 430 612 220</b>
4106108001	<b>9 430 613 793</b>
4106901000	<b>9 430 612 221</b>
4106901001	<b>9 430 613 794</b>
4106902000	<b>9 430 612 222</b>

4106902001	<b>9 430 613 795</b>
4262400600	<b>9 430 611 019</b>

<b>MOPAR</b>	
RL028404AA	<b>0 986 435 398</b>
R5135790AF	<b>0 986 435 505</b>

<b>MOTEURS BAUDOIN</b>	
X6260.068	<b>0 445 020 281</b>
X6260.244	<b>0 445 020 283</b>
14 55 1050J	<b>0 432 231 815</b>

14 55 2270K	<b>0 432 231 726</b>
15 55 0661S	<b>0 432 231 655</b>
15 55 1510Q	<b>0 432 231 739</b>

<b>MTE-THOMSON</b>	
7154	<b>0 280 217 111</b>
7156	<b>0 281 002 184</b>
7157	<b>0 281 002 144</b>

7159	<b>0 281 002 309</b>
7163	<b>0 280 218 020</b>
7164	<b>0 280 217 111</b>
7166	<b>0 280 218 090</b>
7169	<b>0 281 002 182</b>

7173	<b>0 280 217 103</b>
7174	<b>0 280 217 002</b>
7177	<b>0 280 217 124</b>
7179	<b>0 280 217 105</b>
7181	<b>0 280 217 112</b>

<b>MTU</b>	
RX53507300001	<b>0 986 445 115</b>
R0050706201	<b>0 986 445 056</b>
R 005 070 96 01	<b>0 986 445 110</b>

R0060704101	<b>0 986 445 114</b>
X53 507 500 006	<b>0 432 191 232</b>
X53 507 500 010	<b>0 432 191 228</b>
X53 507 500 012	<b>0 432 191 229</b>
X54 407 500 010	<b>0 445 124 017</b>

X54 407 500 022	<b>0 445 124 028</b>
X54 407 500 025	<b>0 445 124 038</b>
X57 507 300 005	<b>0 445 020 139</b>
X57 507 300 015	<b>0 445 020 179</b>
X57 507 300 020	<b>0 445 020 178</b>

X57 507 300 030	<b>0 445 020 243</b>
X57 507 300 031	<b>0 445 020 242</b>
X57 507 300 043	<b>0 445 020 275</b>
X57 507 300 044	<b>0 445 020 276</b>
X57507300065	<b>0 445 020 325</b>

X57507300066	<b>0 445 020 324</b>
X57 507 500 024	<b>0 445 120 229</b>
X58707500001	<b>F 00B L0J 052</b>
000 010 27 51	<b>0 432 191 584</b>
000 010 33 51	<b>0 432 191 553</b>

0000104151	<b>0 432 191 543</b>
000 010 43 51	<b>0 432 191 503</b>
000 010 58 51	<b>0 432 291 510</b>
000 010 60 51	<b>0 432 191 514</b>
0000106151	<b>0 431 YK2 321</b>

000 017 84 21	<b>0 432 207 006</b>
001 010 08 51	<b>0 432 191 467</b>
001 010 21 51	<b>0 432 191 469</b>
001 010 48 51	<b>0 432 191 427</b>
001 010 55 51	<b>0 432 191 366</b>

001 010 70 51	<b>0 432 191 387</b>
001 010 78 51	<b>0 432 191 251</b>
001 010 86 51	<b>0 432 191 362</b>
001 017 39 21	<b>0 432 390 001</b>
001 017 44 21	<b>0 432 206 010</b>

001 017 52 21	<b>0 432 226 004</b>
002 017 41 21	<b>0 432 206 013</b>
002 017 51 21	<b>0 432 291 524</b>
002 017 71 21	<b>0 432 231 674</b>
004 017 50 21	<b>0 432 131 707</b>

004 017 50 21	<b>0 986 430 091</b>
004 017 51 21	<b>0 432 131 706</b>
005 017 34 21	<b>0 432 131 645</b>
005 070 62 01	<b>0 414 799 010</b>
0050706201	<b>0 986 445 056</b>

005 070 96 01	<b>0 414 799 009</b>
005 070 96 01	<b>0 986 445 110</b>
006 070 41 01	<b>0 414 799 031</b>
05235920	<b>0 414 799 011</b>
111 D12 701/2	<b>0 432 248 001</b>

111 012 701/2	<b>0 432 248 001</b>
535 073 00 00/1	<b>0 414 799 037</b>
550 010 00 51	<b>0 432 231 034</b>
550 010 11 51	<b>0 432 231 030</b>
550 010 12 51	<b>0 432 231 030</b>

550 010 16 51	<b>0 432 231 031</b>
555 010 00 51	<b>0 432 231 034</b>
555 010 02 51	<b>0 432 231 046</b>
555 010 06 51	<b>0 432 231 046</b>
555 010 07 51	<b>0 432 231 762</b>

555 010 10 51	<b>0 432 231 745</b>
555 010 21 51	<b>0 432 231 052</b>
5550102251	<b>0 432 231 711</b>
555 010 24 51	<b>0 432 231 696</b>
555 010 26 51	<b>0 432 231 694</b>

555 010 28 51	<b>0 432 231 692</b>
555 017 04 21	<b>0 432 231 734</b>
555 101 18 51	<b>0 432 231 734</b>
580 010 09 51	<b>0 432 390 012</b>
580 010 10 51	<b>0 432 390 011</b>

580 010 11 51	<b>0 432 390 014</b>
580 010 13 51	<b>0 432 390 018</b>
5830100051	<b>0 432 490 006</b>
583 010 01 51	<b>0 432 490 008</b>
584 010 04 51	<b>0 432 490 002</b>

587 010 02 51	<b>0 432 490 007</b>
5900102851	<b>0 432 390 024</b>
820 010 31 51	<b>0 432 206 011</b>

<b>MULTICAR</b>	
000 010 15 51	<b>0 432 193 758</b>
0000104751	<b>0 432 193 639</b>
0000104851	<b>0 432 193 637</b>

0000106651	<b>0 432 193 625</b>
0000106751	<b>0 432 193 623</b>
028130107M	<b>0 460 484 139</b>
068130202A	<b>0 432 217 210</b>
068130202A	<b>0 986 430 234</b>

<b>MWM-DIESEL</b>	
ERR3339A	<b>0 432 193 835</b>
0 0837 90 4 0049	<b>0 432 291 827</b>
0 1173 41 3 0001	<b>0 432 191 552</b>

0 1173 41 3 0001	<b>0 432 291 552</b>
12038849	<b>0 432 291 827</b>
12136792	<b>0 432 390 019</b>
12153047	<b>0 432 291 701</b>
12153055	<b>0 432 291 686</b>

12270158	<b>0 432 291 569</b>
12270162	<b>0 432 291 573</b>
12270525	<b>0 432 291 552</b>
12272007	<b>0 460 423 002</b>
12272011	<b>0 460 424 098</b>

12272017	<b>0 460 426 220</b>
12272019	<b>0 460 426 220</b>
12277057	<b>0 432 131 757</b>
12277366	<b>0 432 131 757</b>
12314246	<b>0 432 131 670</b>

12314259	<b>0 432 131 670</b>
12314694	<b>0 432 131 666</b>
12316782	<b>0 432 131 642</b>
14619415	<b>0 460 424 103</b>
3 0530 01 0 0007	<b>0 432 291 827</b>

6 0530 20 0 0017	<b>0 432 287 007</b>
6 0530 20 0 0049	<b>0 432 291 029</b>
6 0530 20 0 0053	<b>0 432 291 756</b>
6 0530 20 0 0055	<b>0 432 291 701</b>
6 0530 20 0 0060	<b>0 432 291 711</b>

6 0530 20 0 0066	<b>0 432 291 686</b>
6 0530 20 0 0068	<b>0 432 291 671</b>
6 0530 20 0 0070	<b>0 432 291 671</b>
6 0530 20 0 0073	<b>0 432 291 645</b>
7002581C1	<b>0 445 120 327</b>

77424	<b>0 432 193 766</b>
77503	<b>0 432 193 583</b>
77530	<b>0 432 193 532</b>
9 0520 07 4 9004	<b>0 460 424 088</b>
9 0520 07 4 9007	<b>0 460 424 102</b>



9 0520 07 4 9007	<b>0 460 424 113</b>
9 0520 07 4 9007	<b>0 460 424 114</b>
9 0520 07 4 9008	<b>0 460 424 103</b>
9 0520 07 4 9015	<b>0 460 424 109</b>
9 0520 07 4 9015	<b>0 460 424 245</b>

9 0520 07 4 9016	<b>0 460 424 113</b>
9 0520 07 4 9017	<b>0 460 424 116</b>
9 0520 07 4 9018	<b>0 460 424 115</b>
9 0520 07 4 9020	<b>0 460 424 138</b>
9 0520 07 4 9020	<b>0 986 440 228</b>

9 0520 07 4 9021	<b>0 460 424 128</b>
9 0520 07 4 9022	<b>0 460 424 129</b>
9 0520 07 4 9023	<b>0 460 424 131</b>
9 0520 07 4 9024	<b>0 460 424 130</b>
9 0520 07 4 9025	<b>0 460 424 149</b>

9 0520 07 4 9029	<b>0 460 424 181</b>
9 052 007 4903	<b>0 460 424 198</b>
9 0520 07 4 9030	<b>0 460 424 222</b>
9 0520 07 4 9031	<b>0 460 424 115</b>
9 0520 07 4 9031	<b>0 460 424 194</b>

9 0520 07 4 9031	<b>0 460 424 211</b>
9 0520 07 4 9033	<b>0 460 424 194</b>
9 0520 07 4 9033	<b>0 460 424 211</b>
9 0520 07 4 9034	<b>0 460 424 210</b>
9 0520 07 4 9035	<b>0 460 424 216</b>

9 0520 07 4 9035	<b>0 460 424 245</b>
9 0520 07 4 9036	<b>0 460 424 222</b>
9 0520 07 4 9036	<b>0 460 424 223</b>
9 0520 07 4 9037	<b>0 460 424 228</b>
9 0520 07 4 9042	<b>0 460 424 216</b>

9 0520 07 4 9046	<b>0 460 424 360</b>
9 0520 07 4 9055	<b>0 460 424 369</b>
9 0520 07 6 9007	<b>0 460 426 250</b>
9 0520 07 6 9008	<b>0 460 426 259</b>
9 0520 07 6 9008	<b>0 460 426 331</b>

9 0520 07 6 9010	<b>0 460 426 279</b>
9 0520 07 6 9010	<b>0 460 426 329</b>
9 0520 07 6 9011	<b>0 460 426 279</b>
9 0520 07 6 9011	<b>0 460 426 329</b>
9 0520 07 6 9012	<b>0 460 424 319</b>

9 0520 07 6 9012	<b>0 460 426 319</b>
9 0520 07 6 9013	<b>0 460 426 328</b>
9 0520 07 6 9014	<b>0 460 426 279</b>
9 0520 07 6 9014	<b>0 460 426 329</b>
9 0520 07 6 9014	<b>0 460 426 331</b>

9 0520 07 6 9015	<b>0 460 426 336</b>
9 0520 07 6 9018	<b>0 460 426 436</b>
9 0530 20 0 0009	<b>0 432 291 756</b>
9 0530 20 0 9013	<b>9 430 082 289</b>
9 0530 20 0 9020	<b>9 430 082 289</b>

9 0530 20 0 9024	<b>9 430 082 296</b>
9 0530 20 0 9025	<b>9 430 082 721</b>
9 0530 20 0 9026	<b>9 430 082 745</b>
9 0530 20 0 9027	<b>9 430 082 746</b>
9 0530 20 0 9029	<b>9 430 082 752</b>

9 0530 20 0 9031	<b>9 430 082 756</b>
9 0530 20 0 9032	<b>9 430 082 759</b>
9 0530 20 0 9034	<b>9 430 082 767</b>
9 0530 20 0 9035	<b>9 430 082 769</b>
9 0530 20 0 9040	<b>0 432 193 731</b>

9 0530 20 0 9041	<b>0 432 193 691</b>
9 0530 20 0 9043	<b>F 000 439 001</b>
9 0530 20 0 9043	<b>F 000 439 002</b>
9 0530 20 0 9045	<b>F 000 439 006</b>
9 0530 20 0 9046	<b>F 000 439 005</b>

9 0530 20 0 9049	<b>F 000 439 013</b>
9 0530 20 0 9050	<b>F 000 439 014</b>
9 0530 20 0 9051	<b>0 432 193 565</b>
9 4070 46 4 0014	<b>0 445 110 081</b>
9 4070 46 4 0014	<b>0 986 435 252</b>

9 4070 46 4 0024	<b>0 445 110 125</b>
9 4070 46 4 0034	<b>0 445 110 231</b>
9 4070 46 4 0044	<b>0 445 110 336</b>
9 4070 72 7 0014	<b>0 445 010 044</b>
9 4070 72 7 0024	<b>0 445 010 115</b>

9 4080 72 7 0014	<b>0 445 010 294</b>
9 6120 46 4 0014	<b>0 445 120 043</b>
9 6120 46 4 0014	<b>0 445 120 326</b>
9 6120 46 4 0024	<b>0 445 120 077</b>
9 6120 46 4 0034	<b>0 445 120 089</b>

9 6120 46 4 0034	<b>0 445 120 330</b>
9 6120 46 4 0034	<b>0 986 435 542</b>
9 6120 46 4 0054	<b>0 445 120 167</b>
9 6120 72 7 0014	<b>0 445 020 033</b>
9 6120 72 7 0024	<b>0 445 020 059</b>

9 6120 72 7 0034	<b>0 445 020 101</b>
------------------	----------------------

### NAVECO (NANJING IVECO AUTOMO.)

5801379114	<b>0 445 010 375</b>
5801732826	<b>0 445 010 433</b>

97301874	<b>0 445 025 014</b>
----------	----------------------

### NAVISTAR

3002634C1	<b>0 445 020 158</b>
3005275C1	<b>0 445 020 126</b>
3005275C1	<b>0 986 437 506</b>

3005 555 C91	<b>0 445 120 179</b>
3005 555 C91	<b>0 986 435 566</b>
3007 640 C93	<b>F 00E 200 469</b>
3013 160 C91	<b>0 445 124 016</b>
3013 160 C91	<b>0 986 435 652</b>

5010780R1	<b>F 00E 200 549</b>
5010780R1	<b>0 986 437 506</b>
5010780R2	<b>0 986 437 506</b>
961207270034	<b>0 445 020 101</b>

### NEFAZ NEFTEKAMSK

1397832	<b>0 432 191 381</b>
---------	----------------------

### NEOPLAN

51101006036	<b>0 432 191 414</b>
51101006037	<b>0 432 191 417</b>
51101006126	<b>0 445 120 061</b>

51101006126	<b>0 445 120 217</b>
51101006126	<b>0 986 435 526</b>
51101007450	<b>0 432 191 416</b>
51101007453	<b>0 432 191 419</b>

### NEW HOLLAND

ER5801790338	<b>0 445 110 657</b>
E4HN 9F593 BB	<b>9 430 082 708</b>
E8HN 9F 593 AA	<b>9 430 082 722</b>

F2NN 9F593 AB	<b>0 432 191 688</b>
F2NN 9F593 BB	<b>0 432 191 687</b>
F3NN 9F593 AA	<b>0 432 191 667</b>
J931735	<b>0 432 191 531</b>
J931736	<b>0 432 191 531</b>

2852056	<b>0 432 133 780</b>
2852273	<b>0 432 133 775</b>
2853346	<b>0 432 133 771</b>
2854608	<b>0 445 120 057</b>
2854608	<b>0 986 435 552</b>

2855135	<b>0 445 120 075</b>
2855135	<b>0 986 435 530</b>
2855392	<b>0 460 426 453</b>
2855396	<b>0 460 426 455</b>
2855399	<b>0 432 133 764</b>

2855491	<b>0 445 120 054</b>
2855718	<b>0 460 426 447</b>
2855730	<b>0 460 426 470</b>
2856014	<b>0 460 424 402</b>
2856207	<b>0 460 424 424</b>

2856255	<b>0 432 133 761</b>
2856334	<b>0 460 414 265</b>
2856534	<b>0 460 424 422</b>
2856537	<b>0 460 424 418</b>
2856584	<b>0 460 424 404</b>

2856623	<b>0 460 424 421</b>
2856745	<b>0 460 424 398</b>
2856901	<b>0 460 424 274</b>
2856924	<b>0 460 424 306</b>
2856936	<b>0 460 424 386</b>

2856995	<b>0 460 424 430</b>
2859414	<b>0 460 424 432</b>
47506932	<b>0 444 043 080</b>
47511724	<b>0 444 023 058</b>
475 117 25	<b>0 444 023 062</b>

47582622	<b>0 445 020 223</b>
47669601	<b>0 445 020 223</b>
47715717	<b>0 444 043 133</b>
4792442	<b>0 432 291 654</b>
4800029	<b>0 432 291 655</b>

4898821	<b>0 445 020 007</b>
4898921	<b>0 445 020 007</b>
500301632	<b>0 432 291 519</b>
500307714	<b>0 432 291 509</b>
500317389	<b>0 432 291 504</b>

500324962	<b>0 460 414 176</b>
500324970	<b>0 460 424 182</b>
504036727	<b>0 460 413 028</b>
504041416	<b>0 460 424 300</b>
504041420	<b>0 460 423 007</b>

504042213	<b>0 460 423 006</b>
504042214	<b>0 460 424 299</b>
504042718	<b>0 460 424 280</b>
504047343	<b>0 460 414 235</b>
504053824	<b>0 460 424 243</b>

504053825	<b>0 460 424 244</b>
504054021	<b>0 432 291 492</b>
504054473	<b>0 460 423 011</b>
504054474	<b>0 460 423 012</b>
504054475	<b>0 460 423 008</b>

504054478	<b>0 460 424 298</b>
504054479	<b>0 460 424 297</b>
504078911	<b>0 460 426 378</b>
504113228	<b>0 460 424 306</b>
504113991	<b>0 460 424 349</b>

504125329	<b>0 414 703 008</b>
504128307	<b>0 445 120 075</b>
504128354	<b>0 414 703 009</b>
504154922	<b>0 414 703 009</b>
504164563	<b>0 432 193 447</b>

504173549	<b>0 460 424 392</b>
504173550	<b>0 460 424 386</b>
504188076	<b>0 445 020 093</b>
5041880760	<b>0 445 020 093</b>
504189428	<b>0 460 426 446</b>

504189447	<b>0 460 424 393</b>
504194432	<b>0 445 120 092</b>
504194432	<b>0 986 435 551</b>
504198218	<b>0 460 426 471</b>
504215213	<b>0 460 424 349</b>

504215214	<b>0 460 424 306</b>
504215215	<b>0 460 424 274</b>
504215217	<b>0 460 426 380</b>
504215217	<b>0 460 426 494</b>
504216239	<b>0 460 426 474</b>



◀ NEW HOLLAND

504216279	<b>0 460 426 473</b>
504218824	<b>0 460 424 422</b>
504219550	<b>0 460 426 475</b>
504222162	<b>0 460 424 302</b>
504222163	<b>0 460 424 304</b>

504222164	<b>0 460 424 286</b>
504222165	<b>0 460 426 371</b>
504251949	<b>0 460 424 424</b>
504254390	<b>0 432 133 761</b>
504255185	<b>0 445 120 157</b>

504267147	<b>0 460 426 378</b>
504267147	<b>0 460 426 493</b>
504275234	<b>0 432 193 433</b>
504287070	<b>0 414 703 008</b>
504287106	<b>0 414 703 009</b>

504307525	<b>0 460 426 480</b>
504351274	<b>0 460 424 485</b>
504351276	<b>0 460 424 486</b>
504351279	<b>0 460 424 465</b>
504374940	<b>0 460 424 478</b>

504374947	<b>0 460 424 470</b>
504374949	<b>0 460 424 479</b>
504374950	<b>0 460 424 472</b>
504374952	<b>0 460 424 471</b>
504377671	<b>0 445 110 273</b>

504380117	<b>0 445 110 248</b>
504385419	<b>0 460 424 492</b>
504385659	<b>0 460 424 489</b>
504387476	<b>0 460 424 491</b>
504388750	<b>0 445 124 014</b>

504388756	<b>0 445 020 195</b>
5090725	<b>0 432 291 494</b>
5090726	<b>0 432 291 495</b>
5096735	<b>0 460 423 029</b>
5096736	<b>0 460 423 030</b>

5096738	<b>0 460 424 373</b>
5096739	<b>0 460 424 370</b>
5099371	<b>0 432 191 231</b>
5801382396	<b>0 445 020 175</b>
5801453888	<b>0 445 124 015</b>

5801470098	<b>0 445 110 457</b>
5801470100	<b>0 445 020 516</b>
5801486599	<b>0 445 020 195</b>
5801496001	<b>0 445 120 346</b>
5801569141	<b>0 445 110 540</b>

5801618038	<b>0 445 120 351</b>
5801633945	<b>0 445 020 223</b>
5801692383	<b>0 445 124 027</b>
5801790338	<b>0 445 110 657</b>
5801906153	<b>0 445 124 036</b>

75202896	<b>9 430 082 276</b>
75208927	<b>0 432 191 812</b>
75285539	<b>9 430 082 289</b>
8110854	<b>0 432 281 704</b>
84246892	<b>0 444 022 021</b>

84247021	<b>0 444 023 058</b>
84248058	<b>0 444 023 062</b>
84300595	<b>0 460 423 055</b>
84300598	<b>0 460 423 054</b>
84385110	<b>0 445 020 175</b>

84534252	<b>F 002 C7Z 397</b>
86553327	<b>9 430 082 711</b>
87801137	<b>0 460 426 262</b>
87801139	<b>0 460 426 266</b>
87801789	<b>0 460 426 303</b>

87801835	<b>0 460 426 307</b>
87801836	<b>0 460 426 312</b>
87801837	<b>0 460 426 313</b>
87802532	<b>0 460 426 344</b>
87802533	<b>0 460 426 340</b>

87802534	<b>0 460 426 345</b>
87802535	<b>0 460 426 343</b>
87802537	<b>0 432 193 524</b>
87803357	<b>0 470 006 007</b>
87 840 066	<b>0 432 191 641</b>

87 840 068	<b>0 432 191 641</b>
87840068	<b>0 432 191 650</b>
87840069	<b>0 432 191 650</b>
87840446	<b>0 432 191 621</b>
87 841 116	<b>0 432 191 617</b>

98435368	<b>0 432 291 559</b>
99434327	<b>0 432 291 516</b>
99469600	<b>0 460 416 083</b>
99472102	<b>0 460 414 169</b>
99475605	<b>0 460 414 171</b>

<b>NIIGATA</b>	
50132250A	<b>9 430 611 191</b>
62332250A	<b>9 430 611 851</b>

<b>NISSAN</b>	
A6600 VG226	<b>F 01G 09X 03R</b>
A6600 0Y000	<b>9 430 613 243</b>
A6600 9S025	<b>F 01G 09X 03S</b>

A6700MA70C	<b>0 445 010 136</b>
A6700MA70D	<b>0 445 010 136</b>
A6700VZ20D	<b>0 445 010 195</b>
CD17	<b>9 430 610 008</b>
CD17	<b>9 460 610 062</b>

CD17	<b>9 460 610 063</b>
CD17	<b>9 460 610 064</b>
CD17	<b>9 460 610 065</b>
CD17	<b>9 460 610 066</b>
CD17	<b>9 460 610 067</b>

CD17	<b>9 460 610 068</b>
CD17	<b>9 460 610 069</b>
CD17	<b>9 460 610 149</b>
CD17	<b>9 460 610 150</b>
CD17	<b>9 460 610 151</b>

CD17	<b>9 460 610 152</b>
CD17	<b>9 460 610 194</b>
CD17	<b>9 460 610 244</b>
CD17	<b>9 460 610 257</b>
CD17	<b>9 460 610 258</b>

GY1	<b>9 430 610 071</b>
16072 LC40A	<b>0 444 043 047</b>
16072 LC40A	<b>0 444 043 149</b>
1660DB002	<b>0 445 110 168</b>
1660DB002	<b>0 986 435 175</b>

1660DB002	<b>0 986 435 293</b>
16600 AD200	<b>9 430 610 190</b>
16600 AD203	<b>9 430 610 191</b>
16600 AD204	<b>9 430 610 191</b>
16600 AD225	<b>9 430 610 205</b>

16600DB00A	<b>0 445 110 880</b>
16600DB00A	<b>0 986 435 293</b>
16600 DB000	<b>0 445 110 168</b>
16600 DB000	<b>0 986 435 175</b>
16600 DB000	<b>0 986 435 293</b>

16600DC00A	<b>0 445 110 881</b>
16600DC00A	<b>0 986 435 294</b>
16600 DC000	<b>0 445 110 169</b>
16600 DC000	<b>0 986 435 176</b>
16600 D2725	<b>9 430 610 357</b>

16600 D8700	<b>0 432 191 674</b>
16600 D8701	<b>0 432 193 765</b>
16600 D8702	<b>0 432 191 674</b>
16600 D8703	<b>0 432 191 675</b>
16600 D8703	<b>0 432 193 765</b>

16600 D8800	<b>0 432 191 675</b>
16600 D8801	<b>0 432 191 675</b>
16600-EZ49A	<b>0 445 117 031</b>
16600-EZ49A-RE	<b>0 445 117 031</b>
16600 J2000	<b>9 430 610 308</b>

16600 J6500	<b>9 430 610 323</b>
16600LC30B	<b>0 445 110 797</b>
16600LC30B	<b>0 986 435 295</b>
16600 LC30C	<b>0 445 110 856</b>
16600 LC30C	<b>0 986 435 295</b>

16600 L9200	<b>9 430 610 052</b>
16600MA70A	<b>0 445 110 284</b>
16600MA70A	<b>0 986 435 290</b>
16600MA70B	<b>0 445 110 883</b>
16600MA70B	<b>0 986 435 290</b>

16600MD20B	<b>0 445 110 795</b>
16600 MD20C	<b>0 445 110 857</b>
16600 MD20C	<b>0 986 435 292</b>
16600 T7225	<b>9 430 610 054</b>
16600 T9000	<b>9 430 610 004</b>

16600 T9300	<b>9 430 610 915</b>
16600 T9303	<b>9 430 611 044</b>
16600 VB300	<b>9 430 610 165</b>
16600 VB325	<b>9 443 610 422</b>
16600 VB326	<b>9 430 610 297</b>

16600 VB327	<b>9 443 610 422</b>
16600 VB328	<b>9 430 610 297</b>
16600 VB385	<b>9 430 613 246</b>
16600 VG100	<b>9 430 612 757</b>
16600 VG101	<b>F 01G 09X 003</b>

16600 VG101	<b>9 430 613 608</b>
16600 VG225	<b>9 430 613 211</b>
16600 VG226	<b>F 01G 09X 03R</b>
16600 VG226	<b>9 430 613 871</b>
16600 VK500	<b>9 430 613 724</b>

16600 VK525	<b>9 430 613 778</b>
16600 VZ20A	<b>0 445 110 315</b>
16600 VZ20A	<b>0 986 435 198</b>
16600 VZ20A	<b>0 986 435 291</b>
16600VZ20B	<b>0 445 110 877</b>

16600VZ20B	<b>0 986 435 291</b>
16600 V0710	<b>9 430 612 003</b>
16600 WD003	<b>9 430 613 411</b>
16600 W2500	<b>9 430 612 005</b>
16600 W4925	<b>9 430 612 008</b>

16600 Z5519	<b>9 430 610 044</b>
16600 0F000	<b>9 430 610 125</b>
16600 0F020	<b>9 430 610 170</b>
16600 0Y025	<b>9 430 613 234</b>
16600 0Y026	<b>9 430 613 235</b>

16600 00Q0A	<b>0 445 115 022</b>
16600 00Q0A	<b>0 986 435 390</b>
16600 00Q0D	<b>0 445 110 265</b>
16600 00Q0D	<b>0 986 435 170</b>
16600 00Q0D	<b>0 986 435 236</b>

16600 00Q0D	<b>0 986 435 275</b>
16600 01T02	<b>9 430 611 367</b>
16600 05E11	<b>9 430 610 059</b>
16600 05E26	<b>0 986 433 006</b>
16600 05E26	<b>9 430 610 033</b>

16600 05E86	<b>0 986 433 011</b>
16600 1C300	<b>9 430 610 386</b>
16600 1C310	<b>9 430 612 748</b>
16600 1C325	<b>9 430 613 236</b>
16600 1C326	<b>9 430 613 237</b>

16600 1C327	<b>9 430 610 294</b>
16600 16A25	<b>0 986 433 012</b>
166002DB4A	<b>0 445 110 467</b>
166002DB4B	<b>0 445 110 878</b>
16600 2J600	<b>0 432 217 309</b>

16600 2J610	<b>0 432 217 308</b>
16600 2W200	<b>9 430 610 193</b>
16600 2W225	<b>9 430 610 236</b>
16600 36W00	<b>0 986 433 010</b>
16600 36W00	<b>9 430 610 006</b>

16600 43G02	<b>9 430 610 048</b>
16600 43G21	<b>9 430 610 065</b>
16600 43G22	<b>0 986 433 009</b>
16600 43G22	<b>9 430 610 065</b>
16600 5C900	<b>9 443 611 765</b>



16600 5C925	<b>9 443 611 288</b>
16600 5M311	<b>9 430 613 206</b>
16600 5M326	<b>9 430 613 450</b>
16600 50L30	<b>9 430 612 010</b>
16600 50L85	<b>9 430 612 011</b>

16600 59Y00	<b>0 986 433 013</b>
16600 59Y01	<b>0 986 433 008</b>
16600 59Y01	<b>9 430 610 105</b>
16600 59Y11	<b>0 986 433 007</b>
16600 59Y11	<b>9 430 610 132</b>

16600 63G00	<b>9 430 610 135</b>
16600 65N00	<b>9 443 611 769</b>
16600 69T10	<b>0 432 193 727</b>
16600 69T61	<b>0 432 193 533</b>
16600 69T62	<b>0 432 193 533</b>

16600 69T63	<b>0 986 444 058</b>
16600 69T64	<b>0 432 193 487</b>
16600 7F405	<b>0 432 217 305</b>
16600 7F406	<b>0 432 217 306</b>
16600 7F406	<b>0 460 404 974</b>

16600 7F407	<b>0 432 217 306</b>
16600 7T100	<b>9 430 613 869</b>
16600 7T125	<b>9 430 613 873</b>
16600 81T00	<b>9 430 610 392</b>
16600 81T01	<b>9 430 610 392</b>

16600 81T25	<b>9 430 610 285</b>
16600 81T26	<b>9 430 610 285</b>
16600 89TA0	<b>9 430 610 494</b>
16600 89TA1	<b>9 430 610 180</b>
16600 89TA3	<b>9 430 610 152</b>

16600 89TA4	<b>9 430 610 504</b>
16600 89TA5	<b>9 430 612 656</b>
16600 9C600	<b>0 432 117 001</b>
16600 9S000	<b>9 430 613 876</b>
16600 9S025	<b>F 01G 09X 03S</b>

16600 9S025	<b>9 430 613 801</b>
16600 90019	<b>9 430 610 053</b>
16600 90060	<b>9 430 610 058</b>
16600 95015	<b>9 430 611 370</b>
16610 L9200	<b>9 430 615 046</b>

16610 90016	<b>9 430 615 048</b>
16650 00Z11	<b>0 414 701 033</b>
16700 C9601	<b>9 460 610 573</b>
16700 DB000	<b>0 445 010 094</b>
16700 D9708	<b>0 432 117 001</b>

16700-EX49A-RE	<b>0 445 010 834</b>
16700-EZ49A-RE	<b>0 445 010 834</b>
16700 G3610	<b>9 460 610 707</b>
16700 K6700	<b>9 460 610 763</b>
16700 K6701	<b>9 460 610 764</b>

16700 K6702	<b>9 460 610 765</b>
16700LC30A	<b>0 445 010 257</b>
16700 LC30B	<b>0 445 010 418</b>
16700 LC30C	<b>0 445 010 418</b>
16700MA70A	<b>0 445 010 136</b>

16700MA70B	<b>0 445 010 136</b>
16700MA70B	<b>0 986 437 031</b>
16700MA70C	<b>0 445 010 136</b>
16700MA70C	<b>0 986 437 031</b>
16700MA70D	<b>0 445 010 136</b>

16700 R8801	<b>9 460 610 280</b>
16700 VB300	<b>9 460 611 586</b>
16700 VG100	<b>9 443 615 728</b>
16700 VZ20A	<b>0 445 010 194</b>
16700 VZ20A	<b>0 445 010 195</b>

16700 VZ20E	<b>0 445 010 195</b>
16700 OF200	<b>9 460 612 075</b>
16700 OW800	<b>9 460 611 581</b>
1670000Q0D	<b>0 986 437 302</b>
1670000Q0F	<b>0 986 437 302</b>

16700 00Q0K	<b>0 445 010 099</b>
16700 00Q0K	<b>0 986 437 355</b>
16700 00Q0L	<b>0 445 010 170</b>
16700 00Q0L	<b>0 986 437 044</b>
16700 00Q1A	<b>0 445 010 099</b>

16700 00Q1A	<b>0 986 437 355</b>
16700 00Q1B	<b>0 445 010 196</b>
16700 00Q1B	<b>0 445 010 295</b>
16700 00Q1B	<b>0 986 437 039</b>
16700 00Q1D	<b>0 445 010 170</b>

16700 00Q1D	<b>0 986 437 044</b>
16700 00Q1E	<b>0 445 010 223</b>
16700 00Q1E	<b>0 986 437 044</b>
1670000Q1H	<b>0 445 010 324</b>
1670000Q1U	<b>0 445 010 324</b>

16700 05E20	<b>9 460 610 567</b>
16700 09W05	<b>9 460 610 251</b>
16700 10H05	<b>9 460 610 412</b>
16700 14CE1	<b>9 460 610 426</b>
16700 14C00	<b>9 460 610 393</b>

16700 2S614	<b>9 460 611 356</b>
16700 24N01	<b>9 460 614 311</b>
16700 5M320	<b>0 986 444 013</b>
16700 5M321	<b>0 986 444 013</b>
16700 5M322	<b>0 986 444 057</b>

16700 5M384	<b>0 986 444 057</b>
16700 51H12	<b>9 460 612 000</b>
16700 51N20	<b>9 460 610 846</b>
16700 59Y01	<b>9 460 610 701</b>
16700 69T60	<b>0 986 444 056</b>

16700 69T61	<b>0 986 444 056</b>
16700 69T62	<b>0 986 444 056</b>
16700 69T63	<b>0 986 444 058</b>
16700 7F405	<b>0 460 404 974</b>
16700 7F405	<b>0 986 440 508</b>

16700 7F406	<b>0 460 404 974</b>
16700 7F406	<b>0 986 440 508</b>
16700 7F410	<b>9 460 613 261</b>
16700 9X700	<b>0 986 444 081</b>
16700 9X701	<b>0 986 444 081</b>

16700 9X702	<b>0 986 444 081</b>
16700 9X800	<b>0 470 506 025</b>
16700 9X800	<b>0 986 444 080</b>
16700 9X801	<b>0 470 506 025</b>
16700 9X801	<b>0 986 444 080</b>

16700 9X802	<b>0 470 506 025</b>
16700 9X802	<b>0 986 444 080</b>
16700 95N20	<b>9 460 610 956</b>
16700 96550 1	<b>0 986 444 057</b>
16700 98702	<b>0 470 506 025</b>

16700 98702	<b>0 986 444 080</b>
16701 00Q0A	<b>0 445 010 140</b>
16701 00Q0A	<b>0 986 437 033</b>
2041700Z0B	<b>0 444 010 007</b>
20417 00Z0D	<b>0 444 010 016</b>

20418 00Z00	<b>0 444 011 002</b>
20419 00Z00	<b>0 444 012 001</b>
20440 LC40A	<b>0 444 042 068</b>
20462 4HK0A	<b>F 01C 600 249</b>
21215101	<b>0 444 023 061</b>

21582907	<b>0 444 022 037</b>
22680 AU300	<b>0 280 218 117</b>
22680 J7000	<b>0 986 280 128</b>
22680 J7100	<b>0 280 202 111</b>
22680 V5002	<b>0 986 280 128</b>

22680 07F00	<b>0 280 202 111</b>
22680 24P00	<b>0 986 JG0 304</b>
22680 36550	<b>0 280 218 005</b>
22680 36550	<b>0 986 280 232</b>
22680 4W000	<b>0 986 JG0 316</b>

22680 5M000	<b>0 280 218 152</b>
22680 5U400	<b>0 280 218 094</b>
22680-6N20A	<b>0 986 JG1 207</b>
22680 6N210	<b>0 280 218 096</b>
22680 61U00	<b>0 986 JG0 311</b>

22680 69T60	<b>0 281 002 466</b>
22680 69T61	<b>0 281 002 663</b>
22680 7F400	<b>0 281 002 207</b>
22680 7F400	<b>0 986 284 012</b>
22680 7F405	<b>0 281 002 594</b>

22680 7F406	<b>0 281 002 596</b>
22680 7F406	<b>0 281 002 597</b>
22680 7F411	<b>0 281 002 440</b>
22680 7F425	<b>0 281 002 207</b>
22680 7J500	<b>0 280 218 096</b>

22680 7J600	<b>0 280 218 005</b>
22680 7J600	<b>0 986 280 232</b>
22680 8J000	<b>0 280 218 154</b>
22680 8U301	<b>0 280 218 150</b>

<b>NISSAN MOTOR IBERICA</b>	
167005M3207	<b>0 986 444 013</b>

<b>OPEL</b>	
R1 590 056	<b>0 470 504 218</b>
R1 590 057	<b>0 445 010 009</b>
0821438	<b>0 445 110 327</b>

0821438	<b>0 986 435 201</b>
0836177	<b>0 280 218 244</b>
08 36 455	<b>0 280 218 226</b>
08 36 456	<b>0 280 218 207</b>
0836566	<b>0 986 280 140</b>

0836574	<b>0 986 280 140</b>
0836623	<b>0 986 280 113</b>
0836642	<b>0 986 280 113</b>
0836643	<b>0 986 280 140</b>
0836655	<b>0 281 002 940</b>

09109203	<b>0 445 010 033</b>
09117081	<b>0 986 444 500</b>
09118473	<b>9 460 620 010</b>
09118474	<b>0 986 440 150</b>
09118477	<b>9 460 620 002</b>

09118478	<b>9 460 620 001</b>
09118479	<b>9 460 620 003</b>
09118483	<b>9 460 610 656</b>
09118484	<b>0 986 440 002</b>
09118485	<b>0 986 440 143</b>

09118487	<b>9 460 620 009</b>
09118488	<b>9 460 610 596</b>
09118489	<b>9 460 610 609</b>
09118490	<b>9 460 620 015</b>
09118491	<b>9 460 620 014</b>

09118492	<b>9 460 620 017</b>
09118494	<b>0 986 440 152</b>
09118497	<b>9 460 620 021</b>
09119165	<b>0 986 440 516</b>
09119221	<b>0 986 444 005</b>

09129340	<b>0 986 444 005</b>
09158202	<b>0 986 444 012</b>
09158926	<b>0 986 444 001</b>
09192376	<b>0 986 430 302</b>
09192986	<b>0 986 444 005</b>

09192987	<b>0 986 444 001</b>
09192988	<b>0 986 444 002</b>
09192989	<b>0 986 444 003</b>
09192991	<b>0 986 444 005</b>
09192992	<b>0 986 444 001</b>

09192993	<b>0 986 444 002</b>
09192994	<b>0 986 444 003</b>
09193454	<b>0 986 444 012</b>
09193533	<b>0 281 002 184</b>
09195729	<b>0 281 002 428</b>

09196713	<b>0 986 444 014</b>
09196993	<b>0 986 444 012</b>
09196994	<b>0 986 444 500</b>
09196995	<b>0 986 444 012</b>
09196996	<b>0 986 444 500</b>



◀ OPEL

09199204	<b>0 986 444 021</b>
09199205	<b>0 986 444 021</b>
09201510	<b>0 986 444 014</b>
09202063	<b>0 470 504 218</b>
09202063	<b>0 986 444 036</b>

09208679	<b>0 280 218 051</b>
09208679	<b>0 986 280 231</b>
09704361	<b>9 430 610 129</b>
12580977	<b>0 280 218 136</b>
12620534	<b>0 445 117 010</b>

12620534	<b>0 986 435 410</b>
12625220	<b>0 445 110 354</b>
12625220	<b>0 445 110 424</b>
12625221	<b>0 445 010 259</b>
12640359	<b>0 444 021 025</b>

12650509	<b>0 445 110 354</b>
12650509	<b>0 445 110 424</b>
13241771	<b>0 280 218 209</b>
13261544	<b>0 280 218 226</b>
13262124	<b>0 280 218 207</b>

13280277	<b>0 280 218 244</b>
13301682	<b>0 280 218 254</b>
14094712	<b>0 986 280 103</b>
1590043	<b>0 470 504 015</b>
1590050	<b>0 470 504 016</b>

1590055	<b>0 470 504 219</b>
1590056	<b>0 470 504 218</b>
1590056	<b>0 986 444 036</b>
1882019	<b>0 280 218 055</b>
1942702	<b>0 414 701 068</b>

1943972	<b>0 414 701 076</b>
1943974	<b>0 414 701 072</b>
2098522	<b>0 414 701 070</b>
24413103	<b>0 470 504 015</b>
24413103	<b>0 986 444 014</b>

24413104	<b>0 470 504 016</b>
24413104	<b>0 986 444 021</b>
24414665	<b>0 281 002 428</b>
24420614	<b>0 280 218 119</b>
24437502	<b>0 281 002 478</b>

24437503	<b>0 281 002 479</b>
24439252	<b>0 281 002 549</b>
24443598	<b>0 432 193 634</b>
24451341	<b>0 470 504 206</b>
24451343	<b>0 986 444 028</b>

24451344	<b>0 986 444 028</b>
24451346	<b>0 986 444 029</b>
24451347	<b>0 470 504 206</b>
24451347	<b>0 986 444 030</b>
24456764	<b>0 281 002 605</b>

24462266	<b>0 281 002 564</b>
4402535	<b>0 445 110 063</b>
4402535	<b>0 986 435 075</b>
4417118	<b>0 986 437 302</b>
4417119	<b>0 986 437 301</b>

4417362	<b>0 445 110 102</b>
4417362	<b>0 986 435 106</b>
4417364	<b>0 445 110 141</b>
4417364	<b>0 986 435 086</b>
4417364	<b>0 986 435 239</b>

4420512	<b>0 445 010 234</b>
4420512	<b>0 986 437 086</b>
4420513	<b>0 445 010 205</b>
4420513	<b>0 445 010 351</b>
4420513	<b>0 986 437 041</b>

4420518	<b>0 445 110 375</b>
4420518	<b>0 986 435 205</b>
4420518	<b>0 986 435 234</b>
44 23 179	<b>0 445 010 406</b>
44 23 179	<b>0 986 437 071</b>

4431258	<b>0 445 115 007</b>
4431258	<b>0 986 435 350</b>
55190587	<b>0 281 002 764</b>
55192739	<b>0 445 110 159</b>
55192739	<b>0 986 435 088</b>

55192741	<b>0 445 110 165</b>
55193731	<b>0 445 010 097</b>
55193731	<b>0 986 437 025</b>
55198218	<b>0 445 110 243</b>
55198218	<b>0 986 435 104</b>

55198933	<b>0 445 010 278</b>
55198933	<b>0 986 437 024</b>
55198933	<b>0 986 437 201</b>
55200259	<b>0 445 110 276</b>
55200259	<b>0 986 435 148</b>

55204599	<b>0 445 010 097</b>
55204599	<b>0 986 437 025</b>
55206489	<b>0 445 010 293</b>
55206489	<b>0 986 437 036</b>
55206679	<b>0 445 010 156</b>

55206679	<b>0 445 010 288</b>
55206680	<b>0 445 010 155</b>
55206680	<b>0 445 010 287</b>
55206680	<b>0 986 437 026</b>
55209063	<b>0 445 010 184</b>

55209063	<b>0 445 010 365</b>
55209064	<b>0 445 010 183</b>
55209064	<b>0 986 437 048</b>
552141590	<b>0 445 110 326</b>
55219886	<b>0 445 110 351</b>

55221017	<b>0 445 110 276</b>
55221017	<b>0 986 435 148</b>
55221023	<b>0 445 110 300</b>
55221024	<b>0 445 110 299</b>
55221024	<b>0 986 435 230</b>

55233955	<b>0 445 110 419</b>
55234362	<b>0 445 010 305</b>
55236707	<b>0 445 010 265</b>
55236707	<b>0 445 010 425</b>
55236707	<b>0 986 437 097</b>

55237688	<b>0 445 010 305</b>
55237688	<b>0 986 437 094</b>
55237689	<b>0 445 010 466</b>
55237689	<b>0 986 437 095</b>
55237690	<b>0 445 010 310</b>

55246223	<b>0 445 110 524</b>
55246223	<b>0 986 435 280</b>
55246508	<b>0 445 010 466</b>
55246508	<b>0 986 437 095</b>
55254750	<b>0 445 010 466</b>

55255408	<b>0 445 110 618</b>
55255416	<b>0 445 010 425</b>
55255416	<b>0 986 437 097</b>
55267246	<b>0 445 010 466</b>
55350002	<b>0 986 444 030</b>

55350045	<b>0 281 002 619</b>
55350047	<b>0 281 002 620</b>
55350048	<b>0 281 002 683</b>
55351299	<b>0 432 193 512</b>
55351512	<b>0 432 193 512</b>

55351527	<b>0 986 444 037</b>
55351528	<b>0 986 444 030</b>
55351757	<b>0 986 444 028</b>
55351974	<b>0 280 218 142</b>
55352155	<b>0 986 444 028</b>

55352156	<b>0 986 444 030</b>
55352157	<b>0 986 444 029</b>
55352860	<b>0 986 444 037</b>
55352861	<b>0 986 444 030</b>
55352862	<b>0 986 444 037</b>

55352863	<b>0 986 444 037</b>
55352864	<b>0 470 504 218</b>
55352864	<b>0 986 444 036</b>
55352865	<b>0 470 504 218</b>
55352865	<b>0 986 444 036</b>

55352883	<b>0 470 504 219</b>
55352883	<b>0 986 444 037</b>
55352884	<b>0 470 504 218</b>
55352884	<b>0 986 444 036</b>
55485045	<b>0 445 010 703</b>

55488616	<b>0 445 110 713</b>
55491093	<b>0 445 110 809</b>
55494494	<b>0 445 010 759</b>
55496735	<b>0 445 010 773</b>
55496735	<b>0 445 110 327</b>

55556383	<b>0 470 504 218</b>
55556383	<b>0 986 444 036</b>
55557064	<b>0 281 002 773</b>
55557619	<b>0 986 280 241</b>
55558417	<b>0 281 002 802</b>

55561301	<b>0 281 002 832</b>
55561304	<b>0 281 002 830</b>
55561912	<b>0 281 002 940</b>
55562389	<b>0 280 218 211</b>
55562426	<b>0 281 002 912</b>

55564218	<b>0 445 110 326</b>
55564218	<b>0 986 435 200</b>
55564969	<b>0 445 110 393</b>
55565209	<b>0 445 117 018</b>
55565209	<b>0 986 435 427</b>

55565210	<b>0 445 010 550</b>
55565345	<b>0 445 010 371</b>
55565345	<b>0 986 437 047</b>
55566050	<b>0 445 110 327</b>
55566050	<b>0 986 435 201</b>

55566498	<b>0 445 110 325</b>
55566498	<b>0 986 435 199</b>
55566498	<b>0 986 435 200</b>
55567369	<b>0 445 010 293</b>
55567369	<b>0 986 437 036</b>

55567370	<b>0 445 010 278</b>
55567370	<b>0 986 437 024</b>
55567370	<b>0 986 437 201</b>
55571005	<b>0 445 010 371</b>
55571005	<b>0 986 437 047</b>

55572537	<b>0 445 010 293</b>
55572537	<b>0 986 437 036</b>
55573939	<b>0 444 021 026</b>
55574632	<b>0 445 010 382</b>
55574632	<b>0 986 437 027</b>

55575157	<b>0 445 010 381</b>
55575157	<b>0 986 437 072</b>
55575968	<b>0 445 010 387</b>
55577044	<b>0 445 110 425</b>
55577668	<b>0 445 110 423</b>

55577668	<b>0 986 435 237</b>
55578341	<b>0 445 010 703</b>
55582064	<b>0 445 010 393</b>
55585712	<b>0 445 117 037</b>
55585712	<b>0 986 435 439</b>

55588768	<b>0 445 010 550</b>
55590753	<b>0 445 110 620</b>
55594059	<b>0 444 021 038</b>
55597787	<b>0 445 010 441</b>
55597787	<b>0 986 437 047</b>

55597788	<b>0 445 010 443</b>
55597788	<b>0 986 437 027</b>
55597789	<b>0 445 010 445</b>
5819035	<b>0 986 444 012</b>
58 19 073	<b>0 986 437 036</b>

5821086	<b>0 445 110 118</b>
5821086	<b>0 986 435 082</b>
5821100	<b>0 445 110 159</b>
5821100	<b>0 986 435 088</b>
5821110	<b>0 445 110 165</b>

5821525	<b>0 986 435 082</b>
8 15 615	<b>0 280 202 084</b>
8 15 651	<b>0 280 202 084</b>
8 19 001	<b>9 460 620 011</b>
8 19 039	<b>9 460 620 002</b>



8 19 044	<b>9 460 620 001</b>
8 19 045	<b>9 460 620 003</b>
8 19 059	<b>9 460 620 007</b>
8 19 093	<b>0 460 404 991</b>
819168	<b>0 445 010 278</b>

819168	<b>0 986 437 024</b>
8 19 168	<b>0 986 437 201</b>
819242	<b>0 445 010 305</b>
8 19 243	<b>0 445 010 305</b>
8 19 245	<b>0 445 010 265</b>

8 19 245	<b>0 986 437 097</b>
819246	<b>0 445 010 310</b>
8 19 269	<b>0 445 010 466</b>
8 19 270	<b>0 986 437 095</b>
8201043625	<b>0 986 435 106</b>

8 21 165	<b>0 432 217 196</b>
8 21 165	<b>0 986 430 448</b>
8 21 170	<b>0 986 430 243</b>
8 21 171	<b>0 986 433 000</b>
8 36 565	<b>0 280 217 003</b>

8 36 567	<b>0 280 217 106</b>
836584	<b>0 280 218 031</b>
8 36 588	<b>0 280 218 051</b>
836588	<b>0 986 280 231</b>
8 36 592	<b>0 281 002 180</b>

8 36 593	<b>0 281 002 184</b>
8 36 603	<b>0 280 202 006</b>
8 36 604	<b>0 280 202 007</b>
8 36 610	<b>0 280 202 054</b>
8 36 611	<b>0 280 202 068</b>

8 36 612	<b>0 280 202 076</b>
8 36 613	<b>0 280 202 053</b>
8 36 614	<b>0 280 202 086</b>
8 36 616	<b>0 280 202 084</b>
8 36 622	<b>0 280 200 603</b>

8 36 630	<b>0 281 002 479</b>
87803276	<b>0 432 191 351</b>
90006052	<b>0 280 202 054</b>
90008806	<b>0 280 202 076</b>
90016570	<b>0 280 202 007</b>

90019927	<b>0 280 202 006</b>
90094357	<b>0 280 202 053</b>
90194931	<b>0 280 202 068</b>
90271067	<b>0 280 202 084</b>
90296998	<b>0 280 200 603</b>

90349026	<b>0 432 217 196</b>
90349026	<b>0 986 430 448</b>
90369648	<b>0 460 406 994</b>
90399392	<b>0 280 202 212</b>
90409526	<b>0 280 202 212</b>

90411537	<b>0 280 217 503</b>
90412095	<b>0 986 430 243</b>
90423761	<b>0 280 218 051</b>
90423761	<b>0 986 280 231</b>
90442374	<b>0 986 430 243</b>

90444313	<b>0 460 404 074</b>
90444313	<b>0 986 440 002</b>
90444993	<b>0 986 440 143</b>
90448920	<b>0 986 440 143</b>
90448964	<b>0 280 217 106</b>

90466438	<b>0 460 404 074</b>
90466438	<b>0 986 440 002</b>
90467741	<b>0 986 440 150</b>
90487306	<b>0 986 280 113</b>
90501098	<b>0 986 444 001</b>

90501099	<b>0 986 444 002</b>
90501100	<b>0 470 504 004</b>
90501100	<b>0 986 444 003</b>
90501468	<b>0 432 193 688</b>
90501560	<b>0 432 193 687</b>

90509260	<b>0 986 430 241</b>
90510152	<b>0 986 280 140</b>
90510153	<b>0 280 217 003</b>
90510154	<b>0 280 217 106</b>
90510156	<b>0 280 217 503</b>

90510940	<b>0 986 440 150</b>
90512990	<b>0 986 440 152</b>
90528254	<b>0 281 002 139</b>
90528435	<b>0 281 002 184</b>
90529084	<b>0 986 440 152</b>

90529673	<b>0 280 217 123</b>
90529844	<b>0 986 440 152</b>
90530442	<b>0 280 217 519</b>
90530752	<b>0 470 504 004</b>
90530752	<b>0 986 444 003</b>

90530767	<b>0 281 002 180</b>
90531841	<b>0 986 440 152</b>
90531842	<b>0 986 440 150</b>
90540931	<b>0 281 002 139</b>
90541239	<b>0 986 440 150</b>

90541240	<b>0 986 440 152</b>
90541591	<b>0 280 217 519</b>
90541723	<b>0 986 430 302</b>
90541915	<b>0 432 217 299</b>
90541915	<b>0 986 430 449</b>

90542288	<b>0 986 444 002</b>
90543282	<b>0 280 217 123</b>
90543463	<b>0 281 002 180</b>
90543761	<b>0 432 193 686</b>
90543882	<b>0 470 504 004</b>

90543882	<b>0 986 444 003</b>
90571722	<b>0 986 444 002</b>
90571813	<b>0 432 217 299</b>
90571813	<b>0 986 430 449</b>
90572504	<b>0 986 444 500</b>

90573867	<b>0 432 193 686</b>
9109268	<b>0 445 010 075</b>
9109268	<b>0 986 437 301</b>
9109795	<b>0 445 110 141</b>
9109795	<b>0 986 435 086</b>

9109795	<b>0 986 435 239</b>
9110535	<b>0 445 110 063</b>
9110535	<b>0 986 435 075</b>
91117808	<b>0 432 193 688</b>
9112247	<b>0 445 110 087</b>

9112247	<b>0 986 435 079</b>
9112247	<b>0 986 435 235</b>
91 12 247	<b>0 986 435 274</b>
91153667	<b>0 460 404 991</b>
91153783	<b>0 281 002 144</b>

9117868	<b>0 432 193 687</b>
9118472	<b>9 460 620 011</b>
9118482	<b>9 460 620 007</b>
9118484	<b>0 460 404 074</b>
9118486	<b>9 460 620 008</b>

9118493	<b>9 460 620 016</b>
9118497	<b>9 460 620 021</b>
9119165	<b>0 460 406 994</b>
9119514	<b>0 432 193 650</b>
9129719	<b>0 432 193 650</b>

9158202	<b>0 470 504 011</b>
9158400	<b>0 432 193 634</b>
9158401	<b>0 432 193 633</b>
9192374	<b>0 432 217 236</b>
9192377	<b>0 432 217 279</b>

9192712	<b>0 432 193 633</b>
9192713	<b>0 432 193 634</b>
9192988	<b>0 470 504 003</b>
9192989	<b>0 470 504 004</b>
9193149	<b>0 280 218 031</b>

9193149	<b>0 986 280 230</b>
9193454	<b>0 470 504 011</b>
9193533	<b>0 281 002 184</b>
9195729	<b>0 281 002 428</b>
9196701	<b>0 432 193 569</b>

9196933	<b>0 470 504 011</b>
9198651	<b>0 432 193 634</b>
9199204	<b>0 470 504 016</b>
9200844	<b>0 432 193 570</b>
9201425	<b>0 280 218 051</b>

9201425	<b>0 986 280 231</b>
9201510	<b>0 470 504 015</b>
92017809	<b>0 280 202 052</b>
9202065	<b>0 470 504 208</b>
9202472	<b>0 432 193 525</b>

9202473	<b>0 432 193 570</b>
9202474	<b>0 432 193 569</b>
9204425	<b>0 280 218 051</b>
9204425	<b>0 986 280 231</b>
9227760	<b>0 280 218 031</b>

9227760	<b>0 986 280 230</b>
93161630	<b>0 445 010 099</b>
93161630	<b>0 986 437 355</b>
93161695	<b>0 445 115 007</b>
93161695	<b>0 986 435 350</b>

93167530	<b>0 445 110 102</b>
93167533	<b>0 445 110 087</b>
93167533	<b>0 986 435 079</b>
93167533	<b>0 986 435 235</b>
93168205	<b>0 445 010 234</b>

93168205	<b>0 986 437 086</b>
93168206	<b>0 445 010 205</b>
93168206	<b>0 445 010 351</b>
93168206	<b>0 986 437 041</b>
93168212	<b>0 445 110 375</b>

93168212	<b>0 986 435 205</b>
93168212	<b>0 986 435 234</b>
93169113	<b>0 986 435 078</b>
93169115	<b>0 986 435 102</b>
93169117	<b>0 986 435 082</b>

93169119	<b>0 986 435 103</b>
93169121	<b>0 986 435 088</b>
93169123	<b>0 986 435 104</b>
93169125	<b>0 986 435 105</b>
93169127	<b>0 986 435 089</b>

93169129	<b>0 986 435 079</b>
93169133	<b>0 986 435 075</b>
93169135	<b>0 986 435 106</b>
93169137	<b>0 986 435 086</b>
93169139	<b>0 445 110 146</b>

93169139	<b>0 986 435 007</b>
93169141	<b>0 986 435 095</b>
93171107	<b>0 445 110 049</b>
93171119	<b>0 470 504 206</b>
93171355	<b>0 281 002 428</b>

93171356	<b>0 281 002 180</b>
93171527	<b>0 281 002 478</b>
93171627	<b>0 281 002 478</b>
93171683	<b>0 445 010 009</b>
93171683	<b>0 986 437 004</b>

93171707	<b>0 986 435 095</b>
93171760	<b>0 281 002 184</b>
93171940	<b>0 432 193 525</b>
93172230	<b>0 470 504 209</b>
93172230	<b>0 986 444 028</b>

93172231	<b>0 470 504 210</b>
93172231	<b>0 986 444 029</b>
93172233	<b>0 986 444 028</b>
93172234	<b>0 986 444 029</b>
93173725	<b>0 470 504 208</b>

93173727	<b>0 281 002 479</b>
93174129	<b>0 281 002 579</b>
93174504	<b>0 470 504 217</b>
93174504	<b>0 986 444 030</b>
93174628	<b>0 281 002 564</b>

93175025	<b>0 470 504 217</b>
93175025	<b>0 986 444 030</b>
93175730	<b>0 470 504 219</b>
93175730	<b>0 986 444 037</b>
93175731	<b>0 470 504 218</b>





## ◀ OPEL

93175731	<b>0 986 444 036</b>
93175914	<b>0 432 193 512</b>
93176086	<b>0 281 002 605</b>
93177319	<b>0 445 010 277</b>
93177319	<b>0 986 437 024</b>

93177319	<b>0 986 437 201</b>
93177373	<b>0 445 110 083</b>
93177373	<b>0 986 435 078</b>
93177718	<b>0 281 002 549</b>
93178050	<b>0 281 002 620</b>

93178243	<b>0 281 002 683</b>
93178244	<b>0 281 002 619</b>
93178598	<b>0 986 280 113</b>
93178599	<b>0 986 280 113</b>
93178600	<b>0 986 280 140</b>

93178601	<b>0 986 280 140</b>
93178684	<b>0 445 110 165</b>
93179047	<b>0 445 110 159</b>
93179047	<b>0 986 435 088</b>
93179927	<b>0 280 218 119</b>

93180922	<b>0 280 218 142</b>
93180992	<b>0 280 218 142</b>
93181894	<b>0 280 218 211</b>
93182410	<b>0 445 010 097</b>
93182410	<b>0 986 437 025</b>

93183595	<b>0 445 110 021</b>
93183897	<b>0 280 218 142</b>
93183910	<b>0 445 110 083</b>
93183910	<b>0 445 110 183</b>
93183910	<b>0 986 435 078</b>

93184174	<b>0 986 437 036</b>
93184178	<b>0 986 435 102</b>
93184794	<b>0 445 110 159</b>
93184794	<b>0 986 435 088</b>
93185444	<b>0 281 002 773</b>

93185455	<b>0 280 218 136</b>
93185536	<b>0 445 010 009</b>
93185536	<b>0 986 437 004</b>
93186084	<b>0 986 280 241</b>
93186428	<b>0 445 110 165</b>

93186428	<b>0 986 435 103</b>
93186431	<b>0 986 437 036</b>
93187882	<b>0 445 010 278</b>
93187882	<b>0 986 437 024</b>
93187882	<b>0 986 437 201</b>

93188709	<b>0 445 010 097</b>
93188709	<b>0 986 437 025</b>
93188710	<b>0 986 437 026</b>
93188724	<b>0 281 002 832</b>
93188745	<b>0 986 437 301</b>

93189903	<b>0 986 437 302</b>
93189904	<b>0 986 437 301</b>
93189905	<b>0 986 437 317</b>
93189943	<b>0 445 010 140</b>
93189943	<b>0 986 437 033</b>

93189952	<b>0 445 110 265</b>
93189952	<b>0 986 435 170</b>
93190244	<b>0 445 010 156</b>
93190244	<b>0 445 010 288</b>
93190244	<b>0 986 437 025</b>

93190245	<b>0 445 010 155</b>
93190245	<b>0 445 010 287</b>
93190245	<b>0 986 437 026</b>
93190330	<b>0 445 110 102</b>
93190330	<b>0 986 435 106</b>

93190336	<b>0 445 110 087</b>
93190336	<b>0 986 435 235</b>
93190336	<b>0 986 435 274</b>
93190346	<b>0 445 110 141</b>
93190346	<b>0 986 435 239</b>

93190429	<b>0 445 110 276</b>
93190429	<b>0 986 435 148</b>
93190435	<b>0 445 110 183</b>
93190486	<b>0 986 437 025</b>
93190491	<b>0 281 002 478</b>

93190668	<b>0 445 010 293</b>
93190668	<b>0 986 437 036</b>
93191383	<b>0 445 010 173</b>
93191709	<b>0 445 010 184</b>
93191709	<b>0 445 010 365</b>

93191710	<b>0 445 010 183</b>
93191710	<b>0 986 437 048</b>
93193470	<b>0 281 002 862</b>
93195389	<b>0 445 110 325</b>
93195389	<b>0 986 435 199</b>

93195389	<b>0 986 435 200</b>
93195390	<b>0 445 110 326</b>
93195390	<b>0 986 435 200</b>
93196362	<b>0 445 010 170</b>
93196362	<b>0 986 437 044</b>

93197091	<b>0 445 010 170</b>
93197091	<b>0 986 437 044</b>
93198624	<b>0 445 010 223</b>
93198624	<b>0 986 437 044</b>
93198683	<b>0 445 110 338</b>

93198683	<b>0 986 435 202</b>
93245824	<b>0 280 217 525</b>
93328218	<b>0 281 002 579</b>
93342272	<b>0 445 110 231</b>
94459142	<b>0 986 433 004</b>

94459142	<b>9 430 610 136</b>
94460004	<b>0 986 433 005</b>
94460004	<b>9 430 610 137</b>
95507631	<b>0 445 010 196</b>
95507631	<b>0 986 437 039</b>

95510006	<b>0 281 002 980</b>
95510015	<b>0 281 002 917</b>
95513367	<b>0 281 002 792</b>
95516147	<b>0 445 010 250</b>
95516147	<b>0 986 437 045</b>

95517504	<b>0 986 435 200</b>
95517505	<b>0 986 435 237</b>
95517507	<b>0 986 435 079</b>
95517510	<b>0 986 435 153</b>
95517514	<b>0 986 435 350</b>

95517996	<b>0 445 010 404</b>
95517996	<b>0 986 437 070</b>
95517997	<b>0 445 010 406</b>
95517997	<b>0 986 437 071</b>
95518000	<b>0 445 110 414</b>

95518001	<b>0 445 110 569</b>
95518865	<b>0 986 435 234</b>
95521529	<b>0 986 435 202</b>
95521572	<b>0 986 437 041</b>
95521573	<b>0 986 437 086</b>

95521575	<b>0 986 437 072</b>
95521579	<b>0 986 437 036</b>
95521580	<b>0 986 437 045</b>
95521581	<b>0 986 437 039</b>
95521586	<b>0 986 437 033</b>

95521589	<b>0 986 437 032</b>
95521590	<b>0 986 437 044</b>
95521597	<b>0 986 437 094</b>
95521603	<b>0 986 437 070</b>
95521607	<b>0 986 437 047</b>

95521608	<b>0 986 437 027</b>
95521614	<b>0 986 437 355</b>
95521652	<b>0 986 437 071</b>
95523386	<b>0 986 437 095</b>
96440341	<b>0 445 010 142</b>

96440341	<b>0 986 437 032</b>
96440397	<b>0 445 110 269</b>
96859151	<b>0 445 010 332</b>
96859151	<b>0 986 437 032</b>
97040843	<b>9 460 620 007</b>

9704360	<b>9 430 610 128</b>
97043760	<b>0 986 433 002</b>
97043760	<b>9 430 610 128</b>
97043761	<b>9 430 610 129</b>
97078638	<b>9 460 620 008</b>

97078639	<b>9 460 620 009</b>
97085182	<b>9 460 620 010</b>
97088673	<b>0 986 433 001</b>
97092955	<b>9 460 620 011</b>
97121228	<b>9 460 620 011</b>

97121228	<b>9 460 620 017</b>
97121228	<b>9 460 620 021</b>
97122823	<b>9 460 620 013</b>
97139269	<b>9 460 620 021</b>
97139270	<b>9 460 620 021</b>

97161455	<b>9 430 610 163</b>
97300091	<b>0 445 110 118</b>
97300091	<b>0 986 435 082</b>
97327924	<b>0 445 010 086</b>
97327924	<b>0 986 437 317</b>

97363811	<b>0 986 435 105</b>
97363812	<b>0 986 435 089</b>
98433633	<b>0 986 435 082</b>
98433634	<b>0 445 110 118</b>
98433635	<b>0 445 110 174</b>

98433635	<b>0 986 435 105</b>
98433636	<b>0 445 110 175</b>
98433636	<b>0 986 435 089</b>

## OTOSAN

GC46 9D376 BA	<b>0 445 020 266</b>
GC46 9F593 CA	<b>0 445 124 049</b>
JC469F593AA	<b>0 445 124 053</b>

6C465H297BD	<b>0 444 022 027</b>
-------------	----------------------

## PACCAR

1735780	<b>0 444 012 003</b>
1791538	<b>0 444 011 011</b>

## PERKINS

CV 17009	<b>0 432 291 044</b>
KBAL90P37	<b>0 432 193 835</b>
OD 20361	<b>0 432 191 790</b>

OD 20362	<b>0 432 191 789</b>
OD 20743	<b>0 432 191 764</b>
OD 21868	<b>0 432 191 691</b>
T4 10631	<b>0 445 120 347</b>
T4 10930	<b>0 445 025 601</b>

T4 13609	<b>0 445 120 382</b>
T417829	<b>0 445 120 399</b>
2463 J 627	<b>0 460 426 247</b>
2643 F 024	<b>0 432 133 829</b>
2643 H 051	<b>0 460 414 041</b>

2643 H 052	<b>0 460 414 042</b>
2643 H 057	<b>0 460 414 046</b>
2643 H 065	<b>0 460 424 052</b>
2643 H 070	<b>0 460 414 090</b>
2643 H 075	<b>0 460 424 097</b>

2643 H 076	<b>0 460 426 228</b>
2643 H 077	<b>0 460 424 097</b>
2643 H 080	<b>0 460 414 124</b>
2643 H 082	<b>0 460 424 052</b>
2643 J 601	<b>0 460 426 085</b>

2643 J 610	<b>0 460 426 162</b>
2643 J 611	<b>0 460 426 085</b>
2643 J 612	<b>0 460 426 179</b>
2643 J 620	<b>0 460 426 179</b>
2643 J 623	<b>0 460 426 228</b>

2643 J 625	<b>0 460 426 228</b>
2643 J 627	<b>0 460 426 247</b>
2643 J 630	<b>0 460 426 267</b>
2643 J 631	<b>0 460 426 268</b>
2643 J 632	<b>0 460 426 162</b>

2643 J 633	<b>0 460 426 268</b>
2643 J 633	<b>0 460 426 275</b>
2643 J 635	<b>0 460 426 276</b>
2643 J 640	<b>0 460 426 349</b>
2643 J 641	<b>0 460 426 349</b>

2644 N 202	<b>0 460 424 303</b>
2644 N 203	<b>0 460 424 255</b>
2644 N 204	<b>0 986 444 516</b>
2644 N 208	<b>0 460 424 303</b>
2644 N 209	<b>0 460 424 255</b>

2644 N 401	<b>0 470 004 015</b>
2644 N 405	<b>0 460 424 323</b>
2644 N 408	<b>0 460 424 323</b>
2644 P 101	<b>0 460 426 268</b>
2644 P 205	<b>0 460 426 275</b>

2644 P 208	<b>0 460 426 275</b>
2644 P 301	<b>0 460 426 288</b>
2644 P 309	<b>0 460 426 288</b>
2644 P 401	<b>0 460 426 287</b>
2644 P 501	<b>0 986 444 518</b>

2644 P 502	<b>0 470 006 009</b>
2644 P 502	<b>0 986 444 517</b>
2645 F 005	<b>0 432 291 638</b>
2645 F 008	<b>0 432 191 779</b>
2645 F 011	<b>0 432 291 577</b>

2645 F 013	<b>0 432 193 828</b>
2645 F 016	<b>0 432 193 816</b>
2645 F 019	<b>0 432 291 518</b>
2645 F 022	<b>0 432 193 755</b>
2645 F 023	<b>0 432 133 830</b>

2645 F 024	<b>0 432 133 829</b>
2645 F 025	<b>0 432 133 821</b>
2645 F 026	<b>0 432 133 820</b>
2645 F 027	<b>0 432 133 788</b>
2645 M 001	<b>9 430 610 167</b>

2645 M 002	<b>9 430 610 442</b>
2645 M 004	<b>9 430 613 108</b>

<b>PEUGEOT</b>	
1192 W5	<b>0 281 002 184</b>
16 098 507 80	<b>0 445 110 297</b>
16 098 507 80	<b>0 986 435 150</b>

16 237 906 80	<b>0 445 010 559</b>
16 237 906 80	<b>0 986 437 437</b>
1636 75	<b>0 281 002 917</b>
1920 AL	<b>0 445 010 021</b>
1920 AL	<b>0 986 437 012</b>

1920 AZ	<b>0 445 020 002</b>
1920 AZ	<b>0 986 437 501</b>
1920 CY	<b>0 445 010 010</b>
1920 CY	<b>0 445 010 162</b>
1920 CY	<b>0 986 437 005</b>

1920 EA	<b>0 445 010 046</b>
1920 EA	<b>0 445 010 163</b>
1920 EA	<b>0 986 437 017</b>
1920 EC	<b>0 445 010 042</b>
1920 EC	<b>0 986 437 309</b>

1920 FZ	<b>0 445 010 089</b>
1920 FZ	<b>0 986 437 322</b>
1920 HT	<b>0 445 010 296</b>
1920 HT	<b>0 986 437 028</b>
1920 JE	<b>0 445 010 132</b>

1920 JE	<b>0 445 010 164</b>
1920 JE	<b>0 445 010 284</b>
1920 JE	<b>0 986 437 018</b>
1920 KY	<b>0 445 010 367</b>
1920 KY	<b>0 986 437 034</b>

1920 NA	<b>0 445 020 046</b>
1920 NA	<b>0 986 437 321</b>
1920 NC	<b>0 445 010 162</b>
1920 NC	<b>0 445 010 282</b>
1920 NC	<b>0 986 437 005</b>

1920 NE	<b>0 445 010 163</b>
1920 NE	<b>0 445 010 283</b>
1920 NE	<b>0 986 437 017</b>
1920 NF	<b>0 445 010 164</b>
1920 NF	<b>0 445 010 284</b>

1920 NF	<b>0 986 437 018</b>
1920 N2	<b>0 460 494 310</b>
1920 N6	<b>0 460 494 278</b>
1920 PH	<b>0 445 010 367</b>
1920 PH	<b>0 986 437 034</b>

1920 P7	<b>0 460 484 056</b>
1920 Q0	<b>0 460 494 278</b>
1920 RF	<b>0 445 010 552</b>
1920 RF	<b>0 986 437 430</b>
1920 RG	<b>0 445 010 614</b>

1920 RG	<b>0 986 437 432</b>
1920 R8	<b>0 986 440 094</b>
1920 SC	<b>0 445 010 559</b>
1920 SC	<b>0 986 437 437</b>
1920 S4	<b>0 986 440 146</b>

1920 V5	<b>0 986 440 512</b>
1920 W0	<b>0 460 494 278</b>
1920 Z1	<b>0 281 002 128</b>
1920 2N	<b>0 986 440 156</b>
1920 2X	<b>0 460 484 099</b>

1920 3T	<b>0 460 414 140</b>
1920 3T	<b>0 986 440 051</b>
1920 4F	<b>0 460 484 099</b>
1920 6F	<b>0 460 494 459</b>
1920 6X	<b>0 445 010 010</b>

1920 6X	<b>0 445 010 162</b>
1920 6X	<b>0 986 437 005</b>
1920 7H	<b>0 986 440 161</b>
1920 70	<b>0 280 202 097</b>
1920 76	<b>0 986 280 115</b>

1920 8A	<b>0 460 484 131</b>
1920 8P	<b>0 460 494 483</b>
1921 J9	<b>0 445 010 552</b>
1921 J9	<b>0 986 437 430</b>
1979 45	<b>0 986 430 010</b>

1979 46	<b>0 986 430 015</b>
1979 46	<b>0 986 430 028</b>
1979 47	<b>0 986 430 015</b>
1979 47	<b>0 986 430 028</b>
1980 AE	<b>0 986 435 014</b>

1980 AG	<b>0 986 435 014</b>
1980 AJ	<b>0 986 435 014</b>
1980 AL	<b>0 986 435 014</b>
1980 AN	<b>0 986 435 014</b>
1980 AP	<b>0 986 435 014</b>

1980 AV	<b>0 986 435 077</b>
1980 AW	<b>0 986 435 077</b>
1980 AX	<b>0 986 435 077</b>
1980 A9	<b>0 445 110 135</b>
1980 A9	<b>0 986 435 085</b>

1980 CC	<b>0 986 435 077</b>
1980 CE	<b>0 986 435 077</b>
1980 CF	<b>0 986 435 077</b>
1980 CK	<b>0 986 435 003</b>
1980 CL	<b>0 986 435 093</b>

1980 CN	<b>0 986 435 093</b>
1980 CP	<b>0 986 435 093</b>
1980 CQ	<b>0 986 435 146</b>
1980 CS	<b>0 986 435 090</b>
1980 CT	<b>0 986 435 126</b>

1980 CV	<b>0 986 435 150</b>
1980 CY	<b>0 986 435 085</b>
1980 CZ	<b>0 986 435 076</b>
1980 EA	<b>0 986 435 143</b>
1980 EC	<b>0 986 435 501</b>

1980 EE	<b>0 986 435 501</b>
1980 EJ	<b>0 445 110 339</b>
1980 EJ	<b>0 986 435 172</b>
1980 EL	<b>0 986 435 392</b>
1980 EL	<b>0 986 435 434</b>

1980 E5	<b>0 445 110 136</b>
1980 E5	<b>0 445 110 188</b>
1980 E5	<b>0 986 435 090</b>
1980 H2	<b>0 445 110 239</b>
1980 H2	<b>0 986 435 122</b>

1980 H3	<b>0 445 110 188</b>
1980 H3	<b>0 986 435 090</b>
1980 H4	<b>0 445 110 036</b>
1980 H4	<b>0 986 435 014</b>
1980 H5	<b>0 445 110 036</b>

1980 H5	<b>0 986 435 014</b>
1980 H6	<b>0 445 110 036</b>
1980 H6	<b>0 986 435 014</b>
1980 H7	<b>0 445 110 076</b>
1980 H7	<b>0 986 435 077</b>

1980 H8	<b>0 445 110 076</b>
1980 H8	<b>0 986 435 077</b>
1980 H9	<b>0 445 110 076</b>
1980 H9	<b>0 986 435 077</b>
1980 J3	<b>0 445 110 259</b>

1980 J3	<b>0 986 435 126</b>
1980 J8	<b>0 445 115 025</b>
1980 J8	<b>0 445 115 092</b>
1980 J8	<b>0 986 435 450</b>
1980 K2	<b>0 445 110 252</b>

1980 K2	<b>0 986 435 143</b>
1980 K7	<b>0 445 110 281</b>
1980 K7	<b>0 986 435 150</b>
1980 K7	<b>0 986 435 193</b>
1980 K9	<b>0 445 110 297</b>

1980 K9	<b>0 986 435 150</b>
1980 L1	<b>0 445 110 311</b>
1980 L1	<b>0 986 435 146</b>
1980 S5	<b>0 445 110 340</b>
1980 S5	<b>0 986 435 203</b>

1980 W5	<b>0 445 116 012</b>
1980 W5	<b>0 445 116 064</b>
1980 18	<b>0 432 217 270</b>
1980 23	<b>0 432 217 286</b>
1980 27	<b>0 432 193 728</b>

1980 58	<b>0 986 435 003</b>
1980 60	<b>0 432 217 301</b>
1980 68	<b>0 432 117 002</b>
1980 71	<b>0 445 110 008</b>
1980 71	<b>0 445 110 044</b>

1980 71	<b>0 986 435 003</b>
1980 72	<b>0 445 110 044</b>
1980 72	<b>0 986 435 003</b>
1980 73	<b>0 445 110 036</b>
1980 73	<b>0 986 435 014</b>

1980 74	<b>0 445 110 036</b>
1980 74	<b>0 986 435 014</b>
1980 75	<b>0 445 110 036</b>
1980 75	<b>0 986 435 014</b>
1980 77	<b>0 445 110 062</b>

1980 77	<b>0 986 435 077</b>
1980 78	<b>0 445 110 057</b>
1980 78	<b>0 986 435 093</b>
1980 79	<b>0 445 110 057</b>
1980 79	<b>0 986 435 093</b>

1980 80	<b>0 445 110 057</b>
1980 80	<b>0 986 435 093</b>
1980 81	<b>0 445 120 002</b>
1980 81	<b>0 986 435 501</b>
1980 82	<b>0 445 110 062</b>





◀ PEUGEOT

198082	<b>0 986 435 077</b>
198083	<b>0 445 120 002</b>
198083	<b>0 986 435 501</b>
198084	<b>0 445 110 076</b>
198084	<b>0 986 435 077</b>

198085	<b>0 445 110 076</b>
198085	<b>0 986 435 077</b>
198086	<b>0 445 110 076</b>
198086	<b>0 986 435 077</b>
198089	<b>0 445 110 075</b>

198089	<b>0 986 435 076</b>
198093	<b>0 445 110 044</b>
198093	<b>0 986 435 003</b>
198440	<b>0 986 430 028</b>
5489066	<b>0 280 202 005</b>

91538877	<b>0 280 202 097</b>
9350109180	<b>0 986 430 015</b>
9350109180	<b>0 986 430 028</b>
9350138080	<b>0 986 430 010</b>
9351045480	<b>0 986 430 028</b>

94420047	<b>0 460 484 099</b>
95496375	<b>0 280 202 021</b>
95635040	<b>0 280 202 100</b>
96004017	<b>0 986 430 028</b>
96011913	<b>0 986 430 028</b>

96036729	<b>0 432 217 152</b>
96036735	<b>0 432 217 193</b>
96069910	<b>0 432 217 218</b>
96069910	<b>0 432 217 248</b>
96069910	<b>0 986 430 240</b>

96069910	<b>0 986 430 244</b>
96076130	<b>0 460 494 278</b>
96122780	<b>0 432 217 248</b>
96122780	<b>0 986 430 244</b>
96129622	<b>0 460 494 310</b>

96134556	<b>0 460 484 056</b>
96151697	<b>0 432 217 268</b>
96151697	<b>0 986 430 381</b>
96154507	<b>0 986 440 512</b>
96154509	<b>0 986 440 146</b>

96154523	<b>0 986 430 371</b>
96154524	<b>0 432 217 270</b>
96154526	<b>0 432 217 268</b>
96154526	<b>0 986 430 381</b>
96173516	<b>0 460 494 278</b>

96180183	<b>0 460 484 064</b>
96183769	<b>0 432 193 728</b>
96211621	<b>0 281 002 128</b>
96219885	<b>0 460 484 091</b>
96222802	<b>0 460 494 278</b>

96225068	<b>0 460 484 099</b>
96227298	<b>0 432 217 286</b>
96227365	<b>0 986 430 375</b>
96227367	<b>0 986 430 375</b>
96227398	<b>0 432 217 286</b>

96246852	<b>0 460 414 140</b>
96246852	<b>0 986 440 051</b>
96254186	<b>0 460 494 412</b>
96254187	<b>0 986 440 156</b>
96255425	<b>0 986 435 003</b>

96256277	<b>0 460 484 131</b>
96264661	<b>0 432 217 301</b>
96276639	<b>0 445 010 021</b>
96276639	<b>0 986 437 012</b>
96282404	<b>0 445 110 036</b>

96282404	<b>0 986 435 014</b>
96285564	<b>0 460 484 099</b>
96285749	<b>0 460 484 099</b>
96288220	<b>0 432 217 310</b>
96320137	<b>0 445 010 010</b>

96320137	<b>0 445 010 162</b>
96320137	<b>0 986 437 005</b>
96321644	<b>0 460 494 459</b>
96328436	<b>0 432 217 310</b>
96328879	<b>0 460 494 455</b>

96328879	<b>0 986 440 161</b>
96331365	<b>0 460 494 459</b>
96352463	<b>0 445 110 057</b>
96352463	<b>0 986 435 093</b>
96364040	<b>0 445 110 036</b>

96364040	<b>0 986 435 014</b>
96372779	<b>0 445 110 036</b>
96372779	<b>0 986 435 014</b>
96373173	<b>0 445 010 042</b>
96373173	<b>0 986 437 309</b>

96375360	<b>0 445 110 044</b>
96375360	<b>0 986 435 003</b>
96376359	<b>0 445 010 042</b>
96376359	<b>0 986 437 309</b>
96384447	<b>0 445 110 036</b>

96384447	<b>0 986 435 014</b>
9638444780	<b>0 986 435 013</b>
96384448	<b>0 445 110 036</b>
96384448	<b>0 986 435 014</b>
9638444880	<b>0 986 435 014</b>

96384449	<b>0 445 110 036</b>
96384449	<b>0 986 435 014</b>
9638444980	<b>0 986 435 015</b>
96384889	<b>0 445 110 057</b>
96384889	<b>0 986 435 093</b>

96386523	<b>0 445 110 075</b>
96386523	<b>0 986 435 076</b>
96400887	<b>0 445 110 062</b>
96400887	<b>0 986 435 077</b>
96408953	<b>0 445 110 044</b>

96408953	<b>0 986 435 003</b>
96414961	<b>0 445 110 075</b>
96414961	<b>0 986 435 076</b>
96416540	<b>0 445 110 057</b>
96416540	<b>0 986 435 093</b>

96416541	<b>0 445 110 057</b>
96416541	<b>0 986 435 093</b>
96416542	<b>0 445 110 057</b>
96416542	<b>0 986 435 093</b>
96419449	<b>0 445 110 076</b>

96419449	<b>0 986 435 077</b>
96419450	<b>0 445 110 076</b>
96419450	<b>0 986 435 077</b>
96419451	<b>0 445 110 076</b>
96419451	<b>0 986 435 077</b>

96421669	<b>0 445 010 046</b>
96421669	<b>0 986 437 017</b>
9642166980	<b>0 986 437 017</b>
96466862	<b>0 445 110 136</b>
96466862	<b>0 986 435 090</b>

96481471	<b>0 445 010 089</b>
96481471	<b>0 986 437 322</b>
96485754	<b>0 445 110 136</b>
96485754	<b>0 986 435 090</b>
96487862	<b>0 445 110 135</b>

96487862	<b>0 986 435 085</b>
96492841	<b>0 445 010 089</b>
96492841	<b>0 986 437 322</b>
96507606	<b>0 445 110 136</b>
96507606	<b>0 986 435 090</b>

96518443	<b>0 445 010 089</b>
96518443	<b>0 986 437 322</b>
96528920	<b>0 445 110 188</b>
96528920	<b>0 986 435 090</b>
96533448	<b>0 445 110 036</b>

96533448	<b>0 986 435 014</b>
96533457	<b>0 445 110 036</b>
96533457	<b>0 986 435 014</b>
96533458	<b>0 445 110 036</b>
96533458	<b>0 986 435 014</b>

96533459	<b>0 445 110 036</b>
96533459	<b>0 986 435 014</b>
96535942	<b>0 445 110 076</b>
96535942	<b>0 986 435 077</b>
96550450	<b>0 445 110 188</b>

96550450	<b>0 986 435 090</b>
96561543	<b>0 445 010 132</b>
96561543	<b>0 986 437 018</b>
96565889	<b>0 445 110 252</b>
96565889	<b>0 986 435 143</b>

96589498	<b>0 445 110 285</b>
96592288	<b>0 445 115 025</b>
96592288	<b>0 445 115 092</b>
96592288	<b>0 986 435 450</b>
96592291	<b>0 445 115 042</b>

96592291	<b>0 445 115 091</b>
96592291	<b>0 986 435 362</b>
96592405	<b>0 445 110 281</b>
96592405	<b>0 986 435 150</b>
96592405	<b>0 986 435 193</b>

96596666	<b>0 445 110 239</b>
96596666	<b>0 445 110 282</b>
96596666	<b>0 986 435 122</b>
96640424	<b>0 445 110 062</b>
96640424	<b>0 986 435 077</b>

9678393480	<b>0 445 010 832</b>
9678393480	<b>0 986 437 432</b>
9688499680	<b>0 445 010 552</b>
9688499680	<b>0 986 437 430</b>

**PIERBURG**

718221040	<b>0 928 400 529</b>
7.18222.04.0	<b>0 281 002 160</b>
7226840080	<b>0 986 280 202</b>

7.22684.07.0	<b>0 281 002 152</b>
7.22684.07.0	<b>0 281 002 281</b>
722684080	<b>0 280 218 100</b>
7.22684.08.0	<b>0 281 002 216</b>
7.22684.08.0	<b>0 281 002 461</b>

7.22684.08.0	<b>0 281 002 757</b>
722684080	<b>0 281 002 768</b>
7.22684.08.0	<b>0 986 284 010</b>
722684090	<b>0 280 218 075</b>
7.22684.09.0	<b>0 281 002 281</b>

7.22684.09.0	<b>0 281 002 384</b>
7.22684.09.0	<b>0 281 002 489</b>
7.22684.09.0	<b>0 281 002 535</b>
722684090	<b>0 928 400 527</b>
7.22684.10.0	<b>0 281 002 403</b>

722684110	<b>0 280 217 124</b>
722684110	<b>0 280 217 517</b>
722684110	<b>0 280 218 010</b>
722684110	<b>0 280 218 080</b>
722684110	<b>0 928 400 520</b>

722684120	<b>0 280 218 159</b>
722684140	<b>0 280 217 523</b>
722684140	<b>0 280 217 529</b>
722684140	<b>0 280 218 023</b>
722684140	<b>0 281 002 318</b>

722684140	<b>0 281 002 429</b>
722684150	<b>0 281 002 610</b>
7.22701.04.0	<b>0 281 002 180</b>
722701050	<b>0 280 218 007</b>
722701050	<b>0 280 218 008</b>

722701050	<b>0 280 218 019</b>
722701050	<b>0 280 218 020</b>
722701050	<b>0 280 218 045</b>
722701050	<b>0 280 218 051</b>
722701050	<b>0 280 218 088</b>

7.22701.05.0	<b>0 281 002 180</b>
7.22701.05.0	<b>0 281 002 199</b>
722701050	<b>0 281 002 308</b>
7.22701.05.0	<b>0 281 002 309</b>
7.22701.05.0	<b>0 281 002 428</b>



7.22701.05.0	<b>0 281 002 554</b>
7.22701.05.0	<b>0 281 002 579</b>
722701080	<b>0 280 218 004</b>
722701080	<b>0 280 218 089</b>
722701080	<b>0 280 218 104</b>

722701080	<b>0 280 218 106</b>
722701080	<b>0 280 218 113</b>
722701080	<b>0 280 218 120</b>
7.22701.08.0	<b>0 281 002 479</b>
722701080	<b>0 281 002 598</b>

722701090	<b>0 280 218 001</b>
722701090	<b>0 280 218 029</b>
7.22701.09.0	<b>0 281 002 182</b>
7.22701.09.0	<b>0 281 002 184</b>
7.22701.09.0	<b>0 281 002 212</b>

722701090	<b>0 281 002 443</b>
722701100	<b>0 280 217 123</b>
722701100	<b>0 280 218 031</b>
722701110	<b>0 280 218 090</b>
722701110	<b>0 280 218 119</b>

7.22701.11.0	<b>0 281 002 447</b>
7.22701.11.0	<b>0 281 002 478</b>
7.22701.11.0	<b>0 281 002 549</b>
7.22701.11.0	<b>0 281 002 613</b>
728342100	<b>0 280 218 005</b>

## PININFARINA

465598040	<b>0 281 002 309</b>
551905870	<b>0 281 002 764</b>
9395 1792 729	<b>0 280 218 237</b>

93955187722	<b>0 986 280 241</b>
93955190587	<b>0 281 002 764</b>
93955196385	<b>0 280 218 182</b>

## POCLAIN

F 1243293	<b>0 432 291 753</b>
F 1243293	<b>0 986 430 067</b>
F 1843271	<b>0 432 291 782</b>

V 1343265	<b>0 432 291 752</b>
-----------	----------------------

## PONTIAC

14094712	<b>0 986 280 103</b>
----------	----------------------

## PORSCHE

022 906 301	<b>0 280 200 001</b>
3C0 131 113 C	<b>0 444 021 021</b>
4H0 131 113 D	<b>0 444 025 022</b>

930 606 123 X	<b>0 280 203 023</b>
930 606 123 00	<b>0 280 203 023</b>
951 606 125 01	<b>0 986 280 139</b>
951 606 125 02	<b>0 986 280 139</b>
955 606 123 00	<b>0 280 218 071</b>

955 606 123 00	<b>0 986 280 221</b>
955 606 123 31	<b>0 281 002 435</b>
955 606 123 31	<b>0 986 284 006</b>
955 606 123 35	<b>0 280 218 141</b>
955 606 123 36	<b>0 280 218 141</b>

955 606 123 40	<b>0 280 218 198</b>
958 110 315 01	<b>0 445 010 676</b>
958 110 315 10	<b>0 445 010 692</b>
958 110 315 10	<b>0 986 437 435</b>
958 110 315 11	<b>0 445 010 692</b>

958 110 315 11	<b>0 986 437 435</b>
958 110 315 20	<b>0 445 010 690</b>
958 110 315 20	<b>0 986 437 463</b>
958 110 315 30	<b>0 445 010 682</b>
958 110 315 30	<b>0 986 437 454</b>

958 110 316 21	<b>0 445 010 669</b>
958 110 316 21	<b>0 445 010 685</b>
958 110 316 21	<b>0 986 437 404</b>
958 110 316 22	<b>0 445 010 685</b>
958 110 316 22	<b>0 986 437 404</b>

958 110 316 30	<b>0 445 010 675</b>
958 110 316 30	<b>0 986 437 418</b>
958 111 413 35	<b>0 444 021 034</b>
958 606 125 00	<b>0 280 218 260</b>
986 606 125 00	<b>0 280 218 055</b>

986 606 125 01	<b>0 280 218 055</b>
987 606 125 00	<b>0 280 218 145</b>
987 606 165 00	<b>0 280 218 218</b>
987 606 165 01	<b>0 280 218 218</b>
987 606 165 02	<b>0 280 218 218</b>

993 606 123 AX	<b>0 280 217 803</b>
993 606 123 00	<b>0 280 217 803</b>
993 606 123 01	<b>0 280 217 803</b>
993 606 124 AX	<b>0 280 217 809</b>
993 606 124 00	<b>0 280 217 809</b>

993 606 124 01	<b>0 280 217 809</b>
996 606 123 00	<b>0 280 217 007</b>
996 606 124 00	<b>0 280 218 009</b>
997 606 125 00	<b>0 280 218 192</b>

## POWERTRAIN

55214132	<b>0 445 110 325</b>
55214132	<b>0 986 435 199</b>
55214159	<b>0 986 435 200</b>

55216287	<b>0 445 010 293</b>
55227408	<b>0 445 010 293</b>

## PSA (PEUGEOT S.A.)

16 098 48980	<b>0 445 116 059</b>
16 098 49180	<b>0 445 110 239</b>
16 098 49280	<b>0 986 435 122</b>

16 098 49380	<b>0 445 110 188</b>
16 098 49480	<b>0 986 435 090</b>
16 098 49580	<b>0 445 110 259</b>
16 098 49580	<b>0 445 110 297</b>
16 098 49680	<b>0 986 435 126</b>

16 098 49780	<b>0 445 110 297</b>
16 098 49880	<b>0 986 435 150</b>
16 098 49980	<b>0 445 110 311</b>
16 098 50080	<b>0 986 435 146</b>
16 127 75880	<b>0 986 437 445</b>

16 163 17280	<b>0 445 010 425</b>
16 163 20580	<b>0 445 110 614</b>
16 237 90780	<b>0 445 010 832</b>
16 237 90780	<b>0 986 437 432</b>
1920CY	<b>0 445 010 162</b>

1920EA	<b>0 445 010 163</b>
1920JE	<b>0 445 010 164</b>
1920JK	<b>0 445 020 006</b>
1920JK	<b>0 986 437 502</b>
1920SH	<b>0 445 010 222</b>

1921L4	<b>0 986 437 502</b>
1921L5	<b>0 986 437 321</b>
1980 AN	<b>0 986 435 014</b>
1980 A9	<b>0 445 110 135</b>
1980 CE	<b>0 986 435 077</b>

1980 CK	<b>0 986 435 003</b>
1980 CN	<b>0 986 435 093</b>
1980 CY	<b>0 986 435 085</b>
1980 CZ	<b>0 986 435 076</b>
1980 EF	<b>0 445 115 025</b>

1980 EF	<b>0 445 115 092</b>
1980 EF	<b>0 986 435 450</b>
1980EQ	<b>0 445 110 351</b>
1980 H5	<b>0 445 110 036</b>
1980 H8	<b>0 445 110 076</b>

1980 79	<b>0 445 110 057</b>
1980 89	<b>0 445 110 075</b>
1980 93	<b>0 445 110 044</b>
1984G8	<b>0 445 110 248</b>
96 373 17380	<b>0 445 010 042</b>

96 373 17380	<b>0 986 437 309</b>
96 384 88980	<b>0 445 110 057</b>
96 384 88980	<b>0 986 435 093</b>
96 417 42880	<b>0 445 110 076</b>
96 417 42880	<b>0 986 435 077</b>

96 487 86280	<b>0 445 110 135</b>
96 487 86280	<b>0 986 435 085</b>
96.528920.80A	<b>0 445 110 188</b>
96.528920.80A	<b>0 986 435 090</b>
96 533 44880	<b>0 445 110 036</b>

96 533 44880	<b>0 986 435 014</b>
96 535 94280	<b>0 445 110 076</b>
96 535 94280	<b>0 986 435 077</b>
96 547 94380	<b>0 445 010 296</b>
96 547 94380	<b>0 986 437 028</b>

96 550 45080	<b>0 445 110 188</b>
96 550 45080	<b>0 986 435 090</b>
96 553 28480	<b>0 445 110 259</b>
96 553 28480	<b>0 986 435 126</b>
96 556 06680	<b>0 445 110 239</b>

96 556 06680	<b>0 986 435 122</b>
96 561 54380	<b>0 445 010 132</b>
96 561 54380	<b>0 986 437 018</b>
96 563 00380	<b>0 445 010 296</b>
96 565 88980	<b>0 445 110 252</b>

96 565 88980	<b>0 986 435 143</b>
96 569 18380	<b>0 445 010 367</b>
96 569 18380	<b>0 986 437 034</b>
96 589 49880	<b>0 445 110 285</b>
96 592 28880	<b>0 445 115 025</b>

96 592 28880	<b>0 445 115 092</b>
96 592 28880	<b>0 986 435 450</b>
96 592 29180	<b>0 445 115 042</b>
96 592 29180	<b>0 445 115 091</b>
96 592 29180	<b>0 986 435 362</b>

96 592 40580	<b>0 445 110 281</b>
96 592 40580	<b>0 986 435 150</b>
96 592 40580	<b>0 986 435 193</b>
96 596 66680	<b>0 445 110 282</b>
96 603 52980	<b>0 445 010 367</b>

96 603 52980	<b>0 986 437 034</b>
96 620 02680	<b>0 445 110 297</b>
96 620 02680	<b>0 986 435 150</b>
96 620 03380	<b>0 986 435 146</b>
96 780 68280	<b>0 445 116 070</b>

96 783 93480	<b>0 445 010 662</b>
96 783 93480	<b>0 445 010 832</b>
96 783 93480	<b>0 986 437 432</b>
96 832 68980	<b>0 445 010 367</b>
96 832 68980	<b>0 986 437 034</b>

96 837 03780	<b>0 445 010 296</b>
96 837 03780	<b>0 986 437 028</b>
96 870 68980	<b>0 445 110 339</b>
96 870 68980	<b>0 986 435 172</b>
96 870 69280	<b>0 445 110 340</b>

96 870 69280	<b>0 986 435 203</b>
96 874 54380	<b>0 445 116 042</b>
96 874 54380	<b>0 986 435 392</b>
96 874 54380	<b>0 986 435 434</b>
96 874 54480	<b>0 986 435 423</b>

98 027 76680	<b>0 445 110 565</b>
98 096 31480	<b>0 445 010 578</b>
98 096 31480	<b>0 445 010 738</b>
98 096 31480	<b>0 986 437 445</b>
98 113 47380	<b>0 445 010 738</b>

◀ PSA

98 113 47380	<b>0 986 437 445</b>
98 179 03080	<b>0 445 010 760</b>
98 204 03480	<b>0 445 110 749</b>

**QINGLING**

QL16CRIP	<b>0 445 110 767</b>
QL16CRPO	<b>0 445 025 028</b>

**QUANCHAI (ANHUI QUANCH. POWER)**

4D22E41000	<b>0 445 110 346</b>
------------	----------------------

**QUICK**

3408522510001	<b>0 445 110 448</b>
---------------	----------------------

**QUINTON HAZELL**

QM636	<b>0 281 002 757</b>
QM636	<b>0 986 284 010</b>
QM637	<b>0 281 002 216</b>

QM641	<b>0 281 002 216</b>
QM641	<b>0 281 002 757</b>
QM641	<b>0 986 284 010</b>
QM651	<b>0 281 002 144</b>
QM652	<b>0 281 002 180</b>

QM653	<b>0 281 002 309</b>
QM654	<b>0 281 002 403</b>
QM655	<b>0 281 002 429</b>
QM715	<b>0 281 002 461</b>
QM716	<b>0 281 002 429</b>

QM725	<b>0 281 002 184</b>
QM726	<b>0 281 002 683</b>
QM731	<b>0 281 002 478</b>
QM733	<b>0 281 002 428</b>
QM739	<b>0 281 002 463</b>

QM741	<b>0 281 002 281</b>
QM742	<b>0 281 002 139</b>
QM745	<b>0 281 002 318</b>
QM746	<b>0 281 002 182</b>
QM748	<b>0 281 002 613</b>

QM760	<b>0 281 002 195</b>
QM761	<b>0 281 002 549</b>
QM764	<b>0 281 002 120</b>
QM765	<b>0 281 002 207</b>
QM793	<b>0 281 002 620</b>

QM797	<b>0 281 002 132</b>
QM801	<b>0 281 002 792</b>
QM802	<b>0 281 002 980</b>
QM805	<b>0 281 002 554</b>
QM808	<b>0 281 002 610</b>

QM824	<b>0 281 002 152</b>
QSS2415	<b>0 281 002 478</b>

**RABA**

127 218	<b>0 432 191 522</b>
660762	<b>0 432 191 521</b>
660763	<b>0 432 191 520</b>

**RAM**

4 994 925	<b>0 445 120 342</b>
5 253 220	<b>0 986 435 518</b>
5264247	<b>F 00E 200 392</b>

5264247	<b>0 986 437 334</b>
68086182AA	<b>0 445 120 188</b>
68210105AA	<b>0 445 120 342</b>
68210512AA	<b>0 445 120 187</b>
68210512AA	<b>0 986 435 574</b>

68211302AA	<b>0 986 435 251</b>
------------	----------------------

**RENAULT**

H8 200 727 635	<b>0 445 010 324</b>
H8201045496	<b>0 445 010 250</b>
H8201045496	<b>0 986 437 045</b>

00 25 851 058	<b>0 432 291 819</b>
00 48 100 065	<b>0 432 297 034</b>
09 08 200 079	<b>0 432 297 024</b>
16 60 0LC 30C	<b>0 445 110 856</b>
16 60 0LC 30C	<b>0 986 435 295</b>

16 60 0MD 20C	<b>0 445 110 857</b>
16 60 0MD 20C	<b>0 986 435 292</b>
16 60 001 21R	<b>0 445 110 652</b>
16 60 008 04R	<b>0 445 110 569</b>
16 60 013 87R	<b>0 986 435 086</b>

16 60 032 81R	<b>0 445 110 895</b>
16 60 033 55R	<b>0 445 110 728</b>
16 60 034 29R	<b>0 445 115 007</b>
16 60 050 70R	<b>0 445 110 634</b>
16 60 073 83R	<b>0 445 110 939</b>

16 60 074 27R	<b>0 445 110 800</b>
16 60 078 85R	<b>0 445 110 546</b>
16 60 078 85R	<b>0 986 435 273</b>
16 60 083 99R	<b>0 445 110 485</b>
16 60 083 99R	<b>0 986 435 240</b>

16608399R	<b>0 445 110 485</b>
16608399R	<b>0 986 435 240</b>
16 60 939 15R	<b>0 445 110 338</b>
16 60 939 15R	<b>0 986 435 202</b>
16610 5302R	<b>0 445 110 414</b>

16 61 053 02R	<b>0 986 435 211</b>
16 70 0LC 30C	<b>0 445 010 418</b>
16 70 0VZ 20E	<b>0 445 010 195</b>
16 70 010 56R	<b>0 445 010 530</b>
16 70 010 56R	<b>0 986 437 439</b>

16 70 018 10R	<b>0 445 010 324</b>
16 70 021 33R	<b>0 445 010 439</b>
16 70 029 72R	<b>0 445 010 250</b>
16 70 029 72R	<b>0 986 437 045</b>
16 70 029 725	<b>0 445 010 250</b>

16 70 029 725	<b>0 986 437 045</b>
16 70 031 51R	<b>0 445 010 314</b>
16 70 036 06R	<b>0 445 010 763</b>
16 70 051 14R	<b>0 445 010 406</b>
16 70 051 14R	<b>0 986 437 071</b>

16 70 073 58R	<b>0 445 010 704</b>
16 70 073 58R	<b>0 986 437 442</b>
16 70 089 60R	<b>0 445 010 404</b>
16 70 089 60R	<b>0 986 437 070</b>
170428098R	<b>F 01C 600 249</b>

17 04 280 98R	<b>F 01C 600 343</b>
50 00 289 356	<b>0 986 440 027</b>
50 00 289 516	<b>0 986 440 028</b>
50 00 289 860	<b>0 460 424 052</b>
50 00 592 825	<b>0 432 281 695</b>

50 00 592 825	<b>0 986 430 342</b>
50 00 659 162	<b>0 432 281 708</b>
50 00 667 707	<b>0 986 430 334</b>
50 00 670 712	<b>0 432 291 621</b>
50 00 670 712	<b>0 986 430 338</b>

50 00 676 305	<b>0 432 231 741</b>
50 00 676 305	<b>0 986 430 344</b>
50 00 678 956	<b>0 432 231 702</b>
50 00 678 956	<b>0 986 430 341</b>
50 00 684 559	<b>0 432 133 880</b>

50 00 686 053	<b>0 432 291 558</b>
50 00 686 053	<b>0 986 430 337</b>
50 00 691 255	<b>0 986 430 450</b>
50 00 691 343	<b>0 986 430 445</b>
50 00 691 451	<b>0 432 231 700</b>

50 00 691 504	<b>0 432 133 870</b>
50 00 691 834	<b>0 432 133 862</b>
50 00 693 243	<b>0 432 191 683</b>
50 00 694 275	<b>0 432 191 694</b>
50 00 694 275	<b>0 986 430 447</b>

50 00 694 846	<b>0 432 191 633</b>
50 00 694 846	<b>0 986 430 352</b>
50 00 694 851	<b>0 432 191 622</b>
50 00 694 854	<b>0 432 191 630</b>
50 00 694 854	<b>0 986 430 349</b>

50 00 785 794	<b>0 432 291 710</b>
50 00 785 794	<b>0 986 430 141</b>
50 00 785 794	<b>0 986 430 333</b>
50 00 785 857	<b>0 986 430 141</b>
50 00 789 576	<b>0 432 291 672</b>

50 00 789 576	<b>0 986 430 336</b>
50 00 790 173	<b>0 986 430 203</b>
50 00 815 460	<b>0 986 440 023</b>
50 00 823 060	<b>0 432 191 757</b>
50 01 013 882	<b>0 986 440 032</b>

50 01 824 595	<b>0 432 193 845</b>
50 01 824 595	<b>0 986 430 256</b>
50 01 824 761	<b>0 460 424 097</b>
50 01 831 440	<b>0 986 440 041</b>
50 01 832 099	<b>0 986 440 524</b>

50 01 833 363	<b>0 432 193 842</b>
50 01 836 654	<b>0 460 424 136</b>
50 01 836 654	<b>0 986 440 064</b>
50 01 838 468	<b>0 986 430 329</b>
50 01 838 482	<b>0 986 430 333</b>

50 01 838 485	<b>0 986 430 336</b>
50 01 838 496	<b>0 432 231 667</b>
50 01 838 496	<b>0 986 430 330</b>
50 01 838 499	<b>0 986 430 203</b>
50 01 838 502	<b>0 986 430 337</b>

50 01 838 506	<b>0 986 430 338</b>
50 01 838 515	<b>0 986 430 341</b>
50 01 838 518	<b>0 986 430 342</b>
50 01 838 535	<b>0 986 430 334</b>
50 01 838 541	<b>0 986 430 344</b>

50 01 838 551	<b>0 986 430 347</b>
50 01 838 555	<b>0 986 430 348</b>
50 01 838 558	<b>0 432 191 757</b>
50 01 838 561	<b>0 986 430 332</b>
50 01 838 564	<b>0 986 430 256</b>

50 01 838 576	<b>0 986 430 352</b>
50 01 838 613	<b>0 986 430 144</b>
50 01 838 673	<b>0 986 430 141</b>
50 01 838 684	<b>0 986 430 349</b>
50 01 842 340	<b>0 432 193 796</b>

50 01 842 340	<b>0 432 193 833</b>
50 01 842 343	<b>0 432 193 796</b>
50 01 848 043	<b>0 432 117 002</b>
50 01 848 538	<b>0 445 020 002</b>
50 01 848 538	<b>0 986 437 501</b>

50 01 849 912	<b>0 445 120 002</b>
50 01 849 912	<b>0 986 435 501</b>
50 01 855 036	<b>0 445 020 006</b>
50 01 855 036	<b>0 986 437 502</b>
50 01 863 208	<b>0 432 193 816</b>

50 01 866 647	<b>0 986 435 523</b>
50 01 872 992	<b>0 986 437 031</b>
50 10 248 561	<b>0 986 430 329</b>
50 10 248 698	<b>0 432 231 667</b>
50 10 248 698	<b>0 986 430 330</b>

50 10 258 083	<b>0 432 131 771</b>
50 10 258 090	<b>0 986 430 347</b>
50 10 258 560	<b>0 432 131 761</b>
50 10 258 876	<b>0 986 430 511</b>
50 10 284 085	<b>0 432 193 833</b>

50 10 284 086	<b>0 432 193 796</b>	77 00 110 397	<b>0 432 193 644</b>	77 01 479 245	<b>0 986 435 435</b>	82 00 283 583	<b>0 445 110 160</b>
50 10 284 955	<b>0 432 193 528</b>	77 00 111 010	<b>0 445 010 018</b>	82 00 010 074	<b>0 445 110 038</b>	82 00 283 583	<b>0 986 435 098</b>
50 10 284 955	<b>0 432 193 671</b>	77 00 111 010	<b>0 986 437 010</b>	82 00 010 074	<b>0 986 435 016</b>	82 00 296 279	<b>0 445 110 178</b>
50 10 295 113	<b>0 432 191 616</b>	77 00 111 014	<b>0 445 110 021</b>	82 00 010 075	<b>0 445 110 063</b>	82 00 340 063	<b>0 445 010 099</b>
50 10 295 113	<b>0 986 430 348</b>	77 00 112 880	<b>0 432 193 610</b>	82 00 010 075	<b>0 986 435 075</b>	82 00 340 063	<b>0 986 437 355</b>
50 10 323 342	<b>0 432 191 560</b>	77 00 112 883	<b>0 432 193 611</b>	82 00 010 076	<b>0 445 010 028</b>	82 00 340 068	<b>0 445 115 007</b>
50 10 323 837	<b>0 432 193 770</b>	77 00 582 696	<b>0 280 201 001</b>	82 00 010 076	<b>0 986 437 015</b>	82 00 340 068	<b>0 986 435 350</b>
50 10 330 262	<b>0 432 191 586</b>	77 00 743 107	<b>0 986 430 198</b>	82 00 017 377	<b>0 986 437 302</b>	82 00 342 594	<b>0 445 010 087</b>
50 10 339 605	<b>0 432 131 683</b>	77 00 854 303	<b>0 432 217 227</b>	82 00 037 472	<b>0 445 010 031</b>	82 00 367 121	<b>0 445 010 075</b>
50 10 412 093	<b>0 445 120 003</b>	77 00 854 359	<b>0 986 430 268</b>	82 00 037 472	<b>0 986 437 301</b>	82 00 372 388	<b>0 445 010 087</b>
50 10 412 093	<b>0 986 435 509</b>	77 00 855 240	<b>0 986 430 270</b>	82 00 041 766	<b>0 445 010 033</b>	82 00 381 629	<b>0 445 110 229</b>
50 10 412 093	<b>0 986 435 524</b>	77 00 857 674	<b>0 986 430 270</b>	82 00 041 766	<b>0 986 437 302</b>	82 00 389 369	<b>0 445 110 230</b>
50 10 437 223	<b>0 432 193 534</b>	77 00 858 845	<b>0 986 440 205</b>	82 00 047 506	<b>0 432 193 563</b>	82 00 389 369	<b>0 986 435 124</b>
50 10 450 233	<b>0 432 131 668</b>	77 00 858 895	<b>0 432 217 285</b>	82 00 047 509	<b>0 432 193 564</b>	82 00 409 390	<b>0 445 010 099</b>
50 10 450 433	<b>0 986 435 531</b>	77 00 861 872	<b>0 986 440 205</b>	82 00 048 193	<b>0 460 414 983</b>	82 00 409 390	<b>0 986 437 355</b>
50 10 450 532	<b>0 445 120 012</b>	77 00 862 182	<b>0 986 430 267</b>	82 00 055 072	<b>0 445 010 031</b>	82 00 409 395	<b>0 445 115 022</b>
50 10 450 532	<b>0 986 435 525</b>	77 00 862 258	<b>0 432 217 258</b>	82 00 055 072	<b>0 445 010 075</b>	82 00 409 395	<b>0 986 435 390</b>
50 10 450 533	<b>0 445 120 016</b>	77 00 862 258	<b>0 986 430 269</b>	82 00 055 072	<b>0 986 437 301</b>	82 00 409 398	<b>0 445 115 007</b>
50 10 450 533	<b>0 986 435 531</b>	77 00 862 806	<b>0 432 217 258</b>	82 00 061 475	<b>0 460 414 982</b>	82 00 409 398	<b>0 986 435 350</b>
50 10 450 726	<b>0 445 020 009</b>	77 00 862 806	<b>0 986 430 269</b>	82 00 084 534	<b>0 445 110 084</b>	82 00 444 808	<b>0 445 110 261</b>
50 10 450 726	<b>0 445 020 010</b>	77 00 862 816	<b>0 432 217 258</b>	82 00 084 534	<b>0 986 435 173</b>	82 00 456 693	<b>0 445 010 075</b>
50 10 450 952	<b>0 445 020 012</b>	77 00 862 816	<b>0 986 430 269</b>	82 00 100 272	<b>0 445 110 110</b>	82 00 457 039	<b>0 445 010 033</b>
50 10 477 370	<b>0 445 120 009</b>	77 00 863 356	<b>0 460 484 059</b>	82 00 100 272	<b>0 986 435 080</b>	82 00 461 506	<b>0 445 010 075</b>
50 10 477 499	<b>0 445 120 014</b>	77 00 868 831	<b>0 432 217 285</b>	82 00 100 696	<b>0 445 110 109</b>	82 00 461 506	<b>0 445 010 081</b>
50 10 477 499	<b>0 986 435 515</b>	77 00 870 130	<b>0 986 440 523</b>	82 00 100 696	<b>0 986 435 100</b>	82 00 484 403	<b>0 445 110 265</b>
50 10 477 874	<b>0 445 120 019</b>	77 00 870 309	<b>0 986 440 523</b>	82 00 101 135	<b>0 445 110 087</b>	82 00 484 403	<b>0 986 435 170</b>
50 10 477 874	<b>0 986 435 523</b>	77 00 874 094	<b>0 986 440 238</b>	82 00 101 135	<b>0 986 435 079</b>	82 00 484 403	<b>0 986 435 236</b>
50 10 550 956	<b>0 445 120 019</b>	77 00 874 816	<b>0 986 440 205</b>	82 00 101 135	<b>0 986 435 235</b>	82 00 484 403	<b>0 986 435 275</b>
50 10 550 956	<b>0 986 435 523</b>	77 00 875 035	<b>0 432 193 754</b>	82 00 101 135	<b>0 986 435 274</b>	82 00 484 408	<b>0 445 110 261</b>
50 10 553 638	<b>0 445 020 024</b>	77 00 875 036	<b>0 432 193 753</b>	82 00 108 225	<b>0 445 010 075</b>	82 00 503 229	<b>0 445 010 140</b>
50 10 553 948	<b>0 445 020 035</b>	77 00 875 627	<b>0 432 217 292</b>	82 00 112 289	<b>0 445 110 102</b>	82 00 503 229	<b>0 986 437 033</b>
501550955	<b>0 986 435 515</b>	77 01 058 123	<b>0 445 010 094</b>	82 00 121 637	<b>0 445 110 134</b>	82 00 505 056	<b>0 445 115 007</b>
501550956	<b>0 986 435 523</b>	77 01 352 925	<b>0 460 494 438</b>	82 00 124 508	<b>0 280 218 079</b>	82 00 505 056	<b>0 986 435 350</b>
60 01 040 565	<b>0 986 440 149</b>	77 01 352 927	<b>0 986 440 042</b>	82 00 146 357	<b>0 445 110 141</b>	82 00 506 550	<b>0 445 115 022</b>
74 20 798 683	<b>0 445 120 067</b>	77 01 352 933	<b>0 986 440 524</b>	82 00 146 357	<b>0 986 435 086</b>	82 00 506 550	<b>0 986 435 390</b>
74 21 161 863	<b>0 444 023 027</b>	77 01 352 940	<b>0 986 440 149</b>	82 00 146 357	<b>0 986 435 239</b>	82 00 524 701	<b>0 445 010 148</b>
74 21 350 673	<b>0 444 022 024</b>	77 01 352 951	<b>0 986 440 523</b>	82 00 170 377	<b>0 445 010 033</b>	82 00 535 108	<b>0 445 110 280</b>
74 85 121 807	<b>0 445 110 375</b>	77 01 366 930	<b>0 986 440 033</b>	82 00 171 173	<b>0 445 110 144</b>	82 00 535 108	<b>0 986 435 192</b>
74 85 129 393	<b>0 986 437 031</b>	77 01 468 915	<b>0 986 440 524</b>	82 00 171 173	<b>0 986 435 097</b>	82 00 546 112	<b>0 445 010 099</b>
77 00 100 572	<b>0 281 002 195</b>	77 01 472 093	<b>0 986 440 066</b>	82 00 186 534	<b>0 445 010 087</b>	82 00 546 112	<b>0 986 437 355</b>
77 00 100 959	<b>0 432 217 307</b>	77 01 472 094	<b>0 986 440 065</b>	82 00 198 733	<b>0 445 110 127</b>	82 00 549 058	<b>0 445 110 102</b>
77 00 101 016	<b>0 445 010 018</b>	77 01 474 032	<b>0 445 110 063</b>	82 00 211 430	<b>0 445 010 081</b>	82 00 549 063	<b>0 445 110 141</b>
77 00 101 016	<b>0 986 437 010</b>	77 01 474 032	<b>0 986 435 075</b>	82 00 212 715	<b>0 445 110 021</b>	82 00 549 063	<b>0 986 435 239</b>
77 00 103 411	<b>0 460 494 438</b>	77 01 474 042	<b>0 460 424 250</b>	82 00 216 412	<b>0 445 110 150</b>	82 00 549 067	<b>0 445 110 087</b>
77 00 103 412	<b>0 460 494 439</b>	77 01 474 043	<b>0 460 494 484</b>	82 00 228 225	<b>0 445 110 150</b>	82 00 549 067	<b>0 986 435 079</b>
77 00 104 016	<b>0 445 010 018</b>	77 01 476 567	<b>0 445 115 007</b>	82 00 228 225	<b>0 986 435 124</b>	82 00 564 112	<b>0 445 010 099</b>
77 00 104 016	<b>0 986 437 010</b>	77 01 476 567	<b>0 986 435 350</b>	82 00 229 004	<b>0 445 010 087</b>	82 00 564 112	<b>0 986 437 355</b>
77 00 104 423	<b>0 460 494 438</b>	77 01 477 040	<b>0 445 110 261</b>	82 00 238 528	<b>0 445 110 146</b>	82 00 565 450	<b>0 445 115 047</b>
77 00 104 424	<b>0 460 494 439</b>	77 01 477 158	<b>0 445 115 007</b>	82 00 238 528	<b>0 986 435 007</b>	82 00 586 851	<b>0 445 010 033</b>
77 00 107 165	<b>0 445 110 021</b>	77 01 477 158	<b>0 986 435 350</b>	82 00 239 421	<b>0 445 110 134</b>	82 00 586 856	<b>0 445 010 081</b>
77 00 107 165	<b>0 986 435 007</b>	77 01 477 325	<b>0 445 110 265</b>	82 00 246 722	<b>0 445 010 081</b>	82 00 606 383	<b>0 445 110 280</b>
77 00 110 395	<b>0 986 440 520</b>	77 01 477 325	<b>0 986 435 170</b>	82 00 273 891	<b>0 445 110 230</b>	82 00 606 383	<b>0 986 435 192</b>
77 00 110 396	<b>0 432 193 643</b>	77 01 477 325	<b>0 986 435 236</b>	82 00 273 891	<b>0 986 435 124</b>	82 00 613 055	<b>0 445 010 033</b>
77 00 110 396	<b>0 432 193 644</b>	77 01 477 325	<b>0 986 435 275</b>	82 00 279 059	<b>0 445 110 160</b>	82 00 613 056	<b>0 445 010 081</b>
77 00 110 397	<b>0 432 193 643</b>	77 01 479 245	<b>0 445 115 084</b>	82 00 279 059	<b>0 986 435 098</b>	82 00 659 759	<b>0 445 010 075</b>





◀ RENAULT

82 00 659 759	<b>0 986 437 301</b>
82 00 659 766	<b>0 445 010 087</b>
82 00 679 828	<b>0 445 010 170</b>
82 00 679 828	<b>0 986 437 044</b>
82 00 680 077	<b>0 445 010 099</b>

82 00 680 077	<b>0 986 437 355</b>
82 00 754 783	<b>0 445 010 196</b>
82 00 754 783	<b>0 445 010 295</b>
82 00 754 783	<b>0 986 437 039</b>
82 00 779 458	<b>0 445 010 216</b>

82 00 784 019	<b>0 445 110 328</b>
82 00 784 019	<b>0 986 435 188</b>
82 00 801 679	<b>0 445 010 148</b>
82 00 801 679	<b>0 986 437 043</b>
82 00 803 375	<b>0 445 010 099</b>

82 00 803 375	<b>0 986 437 355</b>
82 00 804 288	<b>0 445 010 170</b>
82 00 804 288	<b>0 986 437 044</b>
82 00 804 536	<b>0 445 115 007</b>
82 00 804 536	<b>0 986 435 350</b>

82 00 804 554	<b>0 445 115 022</b>
82 00 804 554	<b>0 986 435 390</b>
82 00 825 969	<b>0 445 010 208</b>
82 00 828 913	<b>0 445 115 084</b>
82 00 828 913	<b>0 986 435 435</b>

82 00 839 859	<b>0 445 110 338</b>
82 00 839 859	<b>0 986 435 202</b>
82 00 839 866	<b>0 445 010 205</b>
82 00 839 866	<b>0 445 010 351</b>
82 00 839 866	<b>0 986 437 041</b>

82 00 889 945	<b>0 445 116 033</b>
82 00 889 945	<b>0 986 435 430</b>
82 00 912 052	<b>0 445 110 375</b>
82 00 912 052	<b>0 986 435 205</b>
82 00 912 052	<b>0 986 435 234</b>

82 00 928 978	<b>0 445 110 141</b>
82 00 928 978	<b>0 986 435 239</b>
82 00 928 996	<b>0 445 110 087</b>
82 00 928 996	<b>0 986 435 235</b>
82 00 934 657	<b>0 445 010 223</b>

82 00 934 657	<b>0 986 437 044</b>
82 00 936 736	<b>0 445 110 084</b>
82 00 936 736	<b>0 986 435 173</b>
82 00 936 740	<b>0 445 110 102</b>
82 00 945 033	<b>0 445 010 218</b>

82 00 945 033	<b>0 986 437 043</b>
82 00 950 477	<b>0 445 010 208</b>
82 00 950 482	<b>0 445 010 234</b>
82 00 950 482	<b>0 986 437 086</b>
82 00 950 483	<b>0 445 010 205</b>

82 00 950 483	<b>0 445 010 351</b>
82 00 950 483	<b>0 986 437 041</b>
82 00 954 766	<b>0 445 115 084</b>
82 00 954 766	<b>0 986 435 435</b>
82 01 023 992	<b>0 445 010 208</b>

82 01 024 002	<b>0 445 010 205</b>
82 01 024 002	<b>0 445 010 351</b>
82 01 024 002	<b>0 986 437 041</b>
82 01 024 003	<b>0 445 010 234</b>
82 01 024 003	<b>0 986 437 086</b>

82 01 043 564	<b>0 445 110 038</b>
82 01 043 564	<b>0 986 435 016</b>
82 01 043 626	<b>0 445 110 084</b>
82 01 043 626	<b>0 986 435 173</b>
82 01 089 213	<b>0 445 010 196</b>

82 01 089 213	<b>0 445 010 295</b>
82 01 089 213	<b>0 986 437 039</b>
82 01 408 742	<b>0 986 435 080</b>
82 01 408 747	<b>0 986 435 173</b>
82 01 408 754	<b>0 986 435 007</b>

82 01 408 757	<b>0 986 435 016</b>
82 01 408 758	<b>0 986 435 106</b>
82 01 408 759	<b>0 986 435 350</b>
82 01 408 763	<b>0 986 435 075</b>
82 01 408 765	<b>0 986 435 100</b>

82 01 534 858	<b>0 986 435 170</b>
82 01 534 861	<b>0 986 435 239</b>
82 01 573 694	<b>0 986 435 079</b>
82 01 891 506	<b>0 445 010 225</b>
93189952	<b>0 986 435 236</b>

REVA ELECTRIC CAR COMPANY	
82 00 549 067	<b>0 986 435 235</b>
82 00 549 067	<b>0 986 435 274</b>

ROEWE	
30000046	<b>0 280 218 166</b>

ROLLS-ROYCE	
13 62 7 566 987	<b>0 280 218 076</b>
13 62 7 582 337	<b>0 280 218 230</b>
13 62 7 582 338	<b>0 280 218 234</b>

ROVER	
AMR 5707	<b>0 281 002 182</b>
ERR 3339	<b>0 432 193 835</b>
ERR 3339 E	<b>0 432 193 835</b>

ERR 4419	<b>0 460 414 098</b>
ERR 4419	<b>0 986 440 038</b>
ERR 5056	<b>0 460 414 111</b>
ERR 5634	<b>0 460 404 973</b>
ERR 5634	<b>0 986 440 507</b>

ERR 5635	<b>0 432 193 701</b>
ERR 6217	<b>0 432 193 700</b>
ERR 6381	<b>0 460 414 992</b>
ERR 6381	<b>0 986 440 522</b>
ETC 8412	<b>0 432 193 879</b>

ETC 8412 E	<b>0 432 193 879</b>
G4D3 9B395 AA	<b>0 445 010 705</b>
G4D3 9B395 AA	<b>0 986 437 462</b>
G4D3 9B395 AB	<b>0 986 437 462</b>
G4D3 9K546 AA	<b>0 445 110 653</b>

G4D3 9K546 CA	<b>0 445 110 663</b>
LR 0013 20	<b>0 445 010 367</b>
LR 0013 20	<b>0 986 437 034</b>
LR 0013 25	<b>0 445 115 042</b>
LR 0013 25	<b>0 445 115 091</b>

LR 0013 25	<b>0 986 435 362</b>
LR 0066 63	<b>0 445 010 367</b>
LR 0066 63	<b>0 986 437 034</b>
LR 013180	<b>0 445 010 614</b>
LR014205	<b>0 986 435 403</b>

LR017923	<b>0 445 116 012</b>
LR017923	<b>0 445 116 064</b>
LR 019605	<b>0 445 010 662</b>
LR 019605	<b>0 445 010 832</b>
LR 022335	<b>0 986 435 423</b>

LR 023597	<b>0 445 010 662</b>
LR 023597	<b>0 445 010 832</b>
LR 027564	<b>0 445 010 662</b>
LR 027564	<b>0 445 010 832</b>
LR 027564	<b>0 986 437 432</b>

LR031849	<b>0 445 116 070</b>
LR045642	<b>0 445 010 666</b>
LR069236	<b>0 445 116 066</b>
MHK 1003 60	<b>0 281 002 120</b>
MHK 1008 00	<b>0 280 218 010</b>

MHK 1008 50	<b>0 281 002 182</b>
MHK 1011 30	<b>0 928 400 520</b>
MKG 1002 70	<b>0 445 110 030</b>
MKG 1002 70	<b>0 986 435 011</b>
MSC 1003 70	<b>0 432 193 819</b>

MSC 1003 70	<b>0 432 193 820</b>
MSC 1003 80	<b>0 432 193 819</b>
MSC 1003 80	<b>0 432 193 820</b>
MSC 1005 00	<b>0 432 193 819</b>
MSC 1005 10	<b>0 432 193 820</b>

MSC 1006 10	<b>0 432 193 700</b>
MSC 1006 20	<b>0 432 193 701</b>
MSC 1007 60	<b>0 432 193 571</b>
MSC 1007 70	<b>0 432 193 601</b>
MSR 0000 10	<b>0 445 010 009</b>

MSR 0000 10	<b>0 986 437 004</b>
MSR 1003 10	<b>0 470 004 005</b>
MSR 1003 10	<b>0 986 444 503</b>
MSR 1003 20	<b>0 445 010 011</b>
MSR 1003 20	<b>0 986 437 006</b>

1353 778598 3	<b>0 445 110 049</b>
1353 788573	<b>0 445 110 266</b>

RUGGERINI	
644 30	<b>0 432 193 887</b>
644 40	<b>0 432 291 657</b>
644 56	<b>0 432 193 883</b>

644 65	<b>0 432 193 870</b>
--------	----------------------

RUVILLE	
895354	<b>0 281 002 478</b>

RVI (RENAULT VEHICULES IND.)	
00 08 670 113	<b>0 280 218 109</b>
21574975	<b>0 444 042 027</b>

21575008	<b>0 444 023 065</b>
50 00 592 825	<b>0 432 281 695</b>
50 00 659 162	<b>0 432 281 708</b>
50 01 838 518	<b>0 432 281 695</b>
50 01 838 541	<b>0 432 231 741</b>

50 01 860 115	<b>0 414 755 006</b>
50 10 284 908	<b>0 414 755 003</b>
50 10 284 955	<b>0 432 191 319</b>
50 10 295 113	<b>0 432 191 616</b>
50 10 412 093	<b>0 986 435 509</b>

50 10 412 093	<b>0 986 435 524</b>
50 10 437 223	<b>0 432 193 534</b>
50 104 509 52HA	<b>0 445 020 012</b>
50 10 477 499	<b>0 986 435 515</b>
50 10 477 874	<b>0 445 120 084</b>

50 10 550 955	<b>0 986 435 515</b>
50 10 550 956	<b>0 445 120 019</b>
50 10 550 956	<b>0 986 435 523</b>
50 10 553 948	<b>0 445 020 062</b>
74 20 766 847	<b>0 444 022 039</b>

74 20 766 863	<b>0 444 023 016</b>
74 20 766 866	<b>0 444 023 017</b>
74 20 766 868	<b>0 444 023 018</b>
74 20 774 745	<b>0 280 218 089</b>
74 20 774 533	<b>0 280 218 089</b>

74 20 798 114	<b>0 445 120 066</b>
74 20 806 011	<b>0 445 120 064</b>
74 20 806 011	<b>0 986 435 529</b>
74 20 908 735	<b>0 444 022 039</b>
74 20 908 943	<b>0 444 023 018</b>

74 20 908 956	<b>0 444 023 017</b>
74 20 908 958	<b>0 444 023 016</b>
74 20 975 638	<b>0 444 022 039</b>
74 20 975 695	<b>0 444 022 039</b>
74 20 975 695	<b>0 986 440 103</b>



74 20 975 695	<b>0 986 44D 119</b>
74 20 993 010	<b>F 00B H40 098</b>
74 20 993 011	<b>F 00B H40 097</b>
74 21 002 997	<b>0 444 022 039</b>
74 21 006 073	<b>0 445 120 074</b>

74 21 006 073	<b>0 986 435 536</b>
74 21 006 084 HA	<b>0 445 120 074</b>
74 21 006 084 HA	<b>0 986 435 536</b>
74 21 006 085	<b>0 445 120 064</b>
74 21 006 086	<b>0 445 120 064</b>

74 21 006 086	<b>0 986 435 529</b>
74 21 049 696	<b>0 445 010 136</b>
74 21 049 696	<b>0 986 437 031</b>
74 21 077 236	<b>0 444 023 024</b>
74 21 161 862	<b>0 444 022 039</b>

74 21 161 862	<b>0 986 44D 103</b>
74 21 161 862	<b>0 986 44D 119</b>
74 21 161 865	<b>0 444 023 037</b>
74 21 200 985	<b>0 444 022 016</b>
74 21 200 985	<b>0 986 44D 113</b>

74 21 201 002	<b>0 444 023 040</b>
74 21 210 644	<b>0 444 022 020</b>
74 21 210 644	<b>0 986 44D 113</b>
74 21 234 246	<b>0 444 023 049</b>
74 21 234 248	<b>0 444 023 053</b>

74 21 318 199	<b>F 00B H40 219</b>
74 21 350 673	<b>0 986 44D 110</b>
74 21 390 069	<b>F 00B H40 098</b>
74 21 390 070	<b>F 00B H40 097</b>
74 21 582 905	<b>0 444 022 034</b>

74 21 582 905	<b>0 986 44D 110</b>
74 21 644 759	<b>F 00B H40 418</b>
74 21 644 761	<b>F 00B H40 419</b>
74 21 644 763	<b>F 00B H40 420</b>
74 21 687 109	<b>0 444 022 042</b>

74 21 687 109	<b>0 986 44D 110</b>
74 21 738 122	<b>0 444 023 043</b>
74 21 738 134	<b>0 444 023 053</b>
74 21 832 467	<b>0 444 042 047</b>
74 21 832 467	<b>0 444 042 057</b>

74 21 911 394	<b>0 444 022 047</b>
74 21 911 394	<b>0 986 44D 110</b>
74 21 966 584	<b>0 444 022 052</b>
74 22 169 013	<b>0 444 022 059</b>
74 22 169 013	<b>0 986 44D 110</b>

74 22 668 889	<b>0 986 44D 110</b>
74 850 016 59BX	<b>0 445 110 169</b>
74 850 016 59BX	<b>0 986 435 176</b>
74 85 001 660	<b>0 445 110 168</b>
74 85 001 660	<b>0 986 435 175</b>

74 85 001 660	<b>0 986 435 293</b>
74 85 001 661	<b>0 445 010 094</b>
74 850 016 61BX	<b>0 445 010 094</b>
74 85 003 175	<b>0 986 445 008</b>
74 85 003 176	<b>0 986 445 001</b>

74 85 020 842	<b>0 986 44D 110</b>
74 85 124 827	<b>0 445 010 136</b>
74 85 124 827	<b>0 986 437 031</b>
74 85 128 252	<b>0 445 110 141</b>
74 85 128 252	<b>0 986 435 239</b>

74 85 129 393	<b>0 445 010 136</b>
74 85 129 393	<b>0 986 437 031</b>
77 01 058 110	<b>0 445 110 169</b>
77 01 058 110	<b>0 986 435 176</b>
77 01 061 083	<b>0 445 110 168</b>

77 01 061 083	<b>0 986 435 175</b>
77 01 061 083	<b>0 986 435 293</b>
77 01 061 090	<b>0 445 110 169</b>
77 01 061 090	<b>0 986 435 176</b>
77 01 473 630	<b>0 445 110 102</b>

77 01 473 631	<b>0 445 110 087</b>
77 01 473 631	<b>0 986 435 079</b>
77 01 473 631	<b>0 986 435 235</b>
77 01 473 631	<b>0 986 435 274</b>
77 01 474 813	<b>0 445 110 141</b>

77 01 474 813	<b>0 986 435 086</b>
77 01 474 813	<b>0 986 435 239</b>

**SAAB (SAAB  
AUTOMOBILE AB)**

04662888	<b>0 281 002 212</b>
09202067	<b>0 986 444 045</b>

13261544	<b>0 280 218 226</b>
24451341	<b>0 986 444 045</b>
42 39 034	<b>0 280 217 503</b>
46 60 809	<b>0 280 217 119</b>
46 60 817	<b>0 280 217 520</b>

46 61 070	<b>0 280 217 521</b>
46 62 888	<b>0 281 002 212</b>
47 73 206	<b>0 470 504 004</b>
47 80 177	<b>0 280 217 519</b>
47 80 185	<b>0 280 217 120</b>

51 66 541	<b>0 281 002 443</b>
51 67 879	<b>0 281 002 443</b>
55562426	<b>0 281 002 912</b>
75 38 655	<b>0 280 212 013</b>
75 38 655	<b>0 986 280 109</b>

75 38 663	<b>0 280 212 011</b>
75 38 663	<b>0 986 280 131</b>
75 68 655	<b>0 280 212 013</b>
75 68 655	<b>0 986 280 109</b>
75 91 183	<b>0 986 280 108</b>

78 72 385	<b>0 986 280 133</b>
847 559	<b>0 432 191 834</b>
88 17 967	<b>0 986 280 119</b>
88 17 975	<b>0 280 212 011</b>
88 17 975	<b>0 986 280 131</b>

88 18 296	<b>0 986 280 112</b>
88 18 304	<b>0 986 280 135</b>
88 23 221	<b>0 280 212 013</b>
88 23 221	<b>0 986 280 109</b>
88 23 239	<b>0 986 280 108</b>

88 26 778	<b>0 986 280 117</b>
88 27 429	<b>0 986 280 110</b>
88 27 461	<b>0 986 280 133</b>
88 27 479	<b>0 986 280 110</b>
89 78 280	<b>0 986 280 119</b>

90202252	<b>0 281 002 605</b>
90543282	<b>0 280 217 123</b>
91 13 838	<b>0 986 280 117</b>
91 13 846	<b>0 986 280 110</b>
91 17 808	<b>0 432 193 688</b>

91 28 919	<b>0 280 217 105</b>
92 00 844	<b>0 432 193 570</b>
92 02 474	<b>0 432 193 569</b>
93166812	<b>0 986 444 045</b>
93171119	<b>0 470 504 206</b>

93171119	<b>0 986 444 045</b>
93171356	<b>0 281 002 180</b>
93185455	<b>0 280 218 136</b>
93188709	<b>0 445 010 097</b>
93188709	<b>0 986 437 025</b>

93190429	<b>0 445 110 276</b>
93190429	<b>0 986 435 148</b>
93193470	<b>0 281 002 862</b>
93 75 643	<b>0 986 280 112</b>
93 90 428	<b>0 986 280 135</b>

95 42 887	<b>0 432 193 569</b>
-----------	----------------------

**SAEM**

09 202 065	<b>0 986 444 046</b>
12 992 707	<b>0 986 444 046</b>
12 992 763	<b>0 986 444 037</b>

4239034	<b>0 280 217 503</b>
46 60 809	<b>0 280 217 119</b>
55 352 661	<b>0 986 444 030</b>
91 28 919	<b>0 280 217 105</b>
93 166 813	<b>0 986 444 046</b>

93 173 725	<b>0 986 444 046</b>
93185455	<b>0 280 218 136</b>

**SAIC**

10048147	<b>0 445 010 377</b>
----------	----------------------

**SAME DEUTZ FAHR  
PVT.**

24619295.0	<b>0 445 020 533</b>
------------	----------------------

**SATURN**

90528435	<b>0 281 002 184</b>
----------	----------------------

**SAVIEM**

00 25 851 058	<b>0 432 291 819</b>
50 00 785 794	<b>0 432 291 710</b>

**SAW SHIYAN  
(DONGFENG CUM. ENG)**

1112BF11 010	<b>0 445 120 242</b>
--------------	----------------------

**SCANIA**

0574364	<b>0 986 441 101</b>
0574368	<b>0 986 441 107</b>
0574369	<b>0 986 441 108</b>

0574380	<b>0 986 441 101</b>
0574381	<b>0 986 441 107</b>
0574382	<b>0 986 441 108</b>
0574392	<b>0 986 441 114</b>
0574393	<b>0 986 441 115</b>

0574394	<b>0 986 441 116</b>
1107959	<b>0 432 131 871</b>
12580977	<b>0 280 218 136</b>
1302561	<b>0 432 131 846</b>
1302738	<b>0 432 131 848</b>

1303806	<b>0 432 131 824</b>
1303806	<b>0 432 131 846</b>
1304238	<b>0 432 131 850</b>
1304238	<b>0 986 430 031</b>
1318812	<b>0 432 131 850</b>

1318812	<b>0 986 430 031</b>
1327374	<b>0 432 131 824</b>
1327376	<b>0 432 131 825</b>
1338083	<b>0 432 231 691</b>
1340592	<b>0 432 131 812</b>

1340655	<b>0 432 131 807</b>
1341480	<b>0 432 131 813</b>
1342165	<b>0 432 131 814</b>
1351806	<b>0 432 131 783</b>
1358965	<b>0 986 430 385</b>

1358966	<b>0 986 430 385</b>
1364499	<b>0 986 430 382</b>
1365391	<b>0 986 430 385</b>
1369708	<b>9 430 082 757</b>
1372541	<b>0 432 131 756</b>





◀ SCANIA

1373002	<b>0 986 430 382</b>
1375913	<b>0 432 131 751</b>
1375913	<b>0 986 430 387</b>
1375914	<b>0 432 131 750</b>
1377573	<b>0 432 131 764</b>
1381219	<b>0 432 131 744</b>
1382121	<b>0 414 701 105</b>
1383222	<b>0 432 131 724</b>
1384169	<b>0 432 131 750</b>
1384170	<b>0 432 131 751</b>
1384170	<b>0 986 430 387</b>
1386852	<b>0 432 131 711</b>
1387056	<b>0 432 131 703</b>
1387056	<b>0 986 430 390</b>
1391028	<b>0 432 131 713</b>
1391030	<b>0 432 131 712</b>
1394528	<b>0 432 131 709</b>
1394538	<b>0 432 131 709</b>
1397338	<b>0 432 191 494</b>
1397340	<b>0 432 191 495</b>
1404009	<b>0 432 131 686</b>
1404013	<b>0 432 131 674</b>
1404591	<b>0 432 131 692</b>
1404592	<b>0 432 131 691</b>
1408335	<b>0 414 701 105</b>
1408335	<b>0 986 441 101</b>
1409193	<b>0 414 701 057</b>
1409193	<b>0 986 441 108</b>
1412614	<b>0 432 131 687</b>
1420276	<b>0 432 131 684</b>
1420379	<b>0 414 701 056</b>
1420379	<b>0 986 441 107</b>
1421380	<b>0 414 701 016</b>
1422540	<b>0 432 131 675</b>
1424462	<b>0 414 701 105</b>
1424462	<b>0 986 441 101</b>
1425077	<b>0 414 701 105</b>
1425077	<b>0 986 441 101</b>
1428273	<b>0 414 701 105</b>
1428273	<b>0 986 441 101</b>
1433445	<b>0 432 131 664</b>
1434121	<b>0 432 191 464</b>
1434122	<b>0 432 191 465</b>
1434235	<b>F 000 439 012</b>
1440577	<b>0 414 701 017</b>
1440577	<b>0 414 701 025</b>
1440577	<b>0 986 441 114</b>
1440578	<b>0 414 701 018</b>
1440578	<b>0 414 701 026</b>
1440579	<b>0 414 701 027</b>
1440579	<b>0 414 701 082</b>
1440579	<b>0 986 441 115</b>
1440580	<b>0 414 701 028</b>
1440580	<b>0 414 701 080</b>
1440580	<b>0 986 441 116</b>

1454161	<b>0 414 701 105</b>
1454161	<b>0 986 441 101</b>
1455860	<b>0 414 701 056</b>
1455860	<b>0 986 441 107</b>
1455861	<b>0 414 701 057</b>
1455861	<b>0 986 441 108</b>
1455862	<b>0 414 701 016</b>
1478643	<b>0 414 701 058</b>
1487472	<b>0 414 701 068</b>
1497364	<b>0 414 701 105</b>
1497364	<b>0 986 441 101</b>
1497385	<b>0 414 701 056</b>
1497385	<b>0 986 441 107</b>
1497386	<b>0 414 701 057</b>
1497386	<b>0 986 441 108</b>
1497387	<b>0 414 701 016</b>
1505199	<b>0 414 701 059</b>
1505199	<b>0 986 441 118</b>
1522430	<b>0 432 131 624</b>
1529749	<b>0 414 701 105</b>
1529749	<b>0 986 441 101</b>
1529750	<b>0 414 701 056</b>
1529750	<b>0 986 441 107</b>
1529751	<b>0 414 701 057</b>
1529751	<b>0 986 441 108</b>
1529752	<b>0 414 701 016</b>
1539350	<b>0 414 701 039</b>
1548472	<b>0 414 701 063</b>
1548475	<b>0 414 701 064</b>
1730800	<b>0 414 701 061</b>
1730888	<b>0 414 701 061</b>
1732454	<b>0 432 131 616</b>
1734493	<b>0 414 701 043</b>
1749104	<b>0 414 701 065</b>
1753208	<b>0 444 011 021</b>
1766547	<b>0 414 701 065</b>
1766549	<b>0 414 701 062</b>
1766551	<b>0 414 701 064</b>
1766552	<b>0 414 701 039</b>
1766553	<b>0 414 701 063</b>
1772499	<b>0 444 010 032</b>
1789353	<b>0 281 002 421</b>
1794992	<b>0 444 010 032</b>
1805344	<b>0 414 701 066</b>
1855402	<b>0 444 010 032</b>
1855403	<b>0 444 010 032</b>
1884220	<b>0 444 010 034</b>
1884225	<b>0 444 010 038</b>
1942702	<b>0 414 701 068</b>
1943972	<b>0 414 701 076</b>
1943974	<b>0 414 701 072</b>
2001791	<b>0 444 011 016</b>
2098522	<b>0 414 701 070</b>
2123834	<b>0 444 011 026</b>
24437503	<b>0 281 002 479</b>

24456764	<b>0 281 002 605</b>
313508	<b>0 432 292 881</b>
313508	<b>0 986 430 074</b>
325707	<b>0 986 430 039</b>
349170	<b>0 986 430 031</b>
369288	<b>0 432 192 881</b>
369288	<b>0 986 430 034</b>
380807	<b>0 432 131 873</b>
380807	<b>0 986 430 030</b>
380812	<b>0 432 131 871</b>
397246	<b>0 432 192 876</b>
4239034	<b>0 280 217 503</b>
4300562	<b>0 280 217 506</b>
4300562	<b>0 280 217 525</b>
4660809	<b>0 280 217 119</b>
4660817	<b>0 280 217 520</b>
4661070	<b>0 280 217 521</b>
4662888	<b>0 281 002 212</b>
4772323	<b>0 432 193 688</b>
4773206	<b>0 986 444 003</b>
4780177	<b>0 280 217 519</b>
5166541	<b>0 281 002 443</b>
5167879	<b>0 281 002 443</b>
5340005	<b>0 281 002 538</b>
5341342	<b>0 470 504 206</b>
5342381	<b>0 470 504 208</b>
5342423	<b>0 432 193 570</b>
5342951	<b>0 281 002 605</b>
55190587	<b>0 281 002 764</b>
55192739	<b>0 445 110 159</b>
55198218	<b>0 445 110 243</b>
574325	<b>0 986 430 039</b>
574326	<b>0 986 430 074</b>
574331	<b>0 986 430 034</b>
574332	<b>0 986 430 031</b>
574333	<b>0 986 430 030</b>
574336	<b>0 986 430 120</b>
574337	<b>0 986 430 031</b>
574339	<b>0 432 131 846</b>
574339	<b>0 986 430 274</b>
574341	<b>0 986 430 213</b>
574342	<b>0 986 430 212</b>
574344	<b>0 432 192 876</b>
574347	<b>0 986 430 385</b>
574349	<b>0 986 430 382</b>
574350	<b>0 986 430 387</b>
574355	<b>0 432 131 724</b>
574359	<b>0 432 131 712</b>
574360	<b>0 986 430 390</b>
<b>SDEC (SHANGHAI DIESEL ENGINE)</b>	
S00001280	<b>0 445 010 312</b>

<b>SEAT</b>	
028 130 081 P	<b>0 986 440 553</b>
028 130 082	<b>0 986 440 551</b>
028 130 082 A	<b>0 986 440 552</b>
028 130 082 H	<b>0 986 440 570</b>
028 130 082 HX	<b>0 986 440 570</b>
028 130 107	<b>0 986 440 084</b>
028 130 107 D	<b>0 986 440 557</b>
028 130 107 J	<b>0 986 440 142</b>
028 130 107 R	<b>0 986 440 247</b>
028 130 108 G	<b>0 986 440 249</b>
028 130 110 H	<b>0 460 404 971</b>
028 130 110 H	<b>0 986 440 555</b>
028 130 110 S	<b>0 986 440 240</b>
028 130 115 A	<b>0 460 404 969</b>
028 130 115 A	<b>0 986 440 554</b>
028 130 115 B	<b>0 986 440 567</b>
028 130 115 M	<b>0 460 404 971</b>
028 130 115 M	<b>0 986 440 555</b>
028 130 115 P	<b>0 986 440 240</b>
028 130 115 Q	<b>0 986 440 241</b>
028 130 115 QX	<b>0 460 484 128</b>
028 130 115 T	<b>0 986 440 251</b>
028 130 201 B	<b>0 432 217 284</b>
028 130 201 B	<b>0 986 430 206</b>
028 130 201 G	<b>0 432 193 838</b>
028 130 201 J	<b>0 432 193 829</b>
028 130 201 R	<b>0 432 193 795</b>
028 130 202 H	<b>0 432 193 704</b>
028 130 202 J	<b>0 432 193 702</b>
028 130 202 N	<b>0 432 193 707</b>
028 130 202 P	<b>0 432 193 695</b>
028 130 202 R	<b>0 432 193 682</b>
028 130 202 S	<b>0 432 193 680</b>
028 906 461	<b>0 281 002 216</b>
028 906 461	<b>0 986 284 001</b>
03G 130 073 B	<b>0 414 720 402</b>
03G 130 073 B	<b>0 414 720 453</b>
03G 130 073 B	<b>0 986 441 580</b>
03G 130 073 G	<b>0 414 720 454</b>
03G 130 073 G	<b>0 986 441 566</b>
03G 906 461 C	<b>0 281 002 735</b>
03L 130 277	<b>0 445 116 029</b>
03L 130 277	<b>0 986 435 360</b>
03L 130 277 J	<b>0 445 110 368</b>
03L 130 277 J	<b>0 445 110 646</b>
03L 130 277 J	<b>0 986 435 166</b>
03L 130 277 Q	<b>0 445 110 646</b>
03L 130 277 Q	<b>0 986 435 166</b>
03L 130 755	<b>0 445 010 546</b>
03L 130 755	<b>0 986 437 410</b>
03L 130 755 A	<b>0 445 010 543</b>
03L 130 755 A	<b>0 986 437 410</b>
03L 130 755 AA	<b>0 445 010 565</b>



03L 130 755 AA	<b>0 986 437 405</b>
03L 130 755 AC	<b>0 445 010 562</b>
03L 130 755 AC	<b>0 986 437 434</b>
03L 130 755 AE	<b>0 445 010 568</b>
03L 130 755 AE	<b>0 986 437 434</b>

03L 130 755 AF	<b>0 445 010 567</b>
03L 130 755 AF	<b>0 986 437 438</b>
03L 130 755 D	<b>0 445 010 551</b>
03L 130 755 L	<b>0 445 010 560</b>
03L 906 461 A	<b>0 281 002 956</b>

03P 906 461	<b>0 281 006 132</b>
037 906 461 C	<b>0 280 217 117</b>
037 906 461 C	<b>0 986 280 201</b>
038 130 073 AC	<b>0 414 720 029</b>
038 130 073 AC	<b>0 986 441 554</b>

038 130 073 AG	<b>0 414 720 265</b>
038 130 073 AG	<b>0 986 441 559</b>
038 130 073 AH	<b>0 414 720 086</b>
038 130 073 AH	<b>0 986 441 553</b>
038 130 073 AJ	<b>0 414 720 087</b>

038 130 073 AJ	<b>0 986 441 556</b>
038 130 073 AK	<b>0 414 720 088</b>
038 130 073 AK	<b>0 986 441 554</b>
038 130 073 AL	<b>0 414 720 089</b>
038 130 073 AL	<b>0 986 441 557</b>

038 130 073 BA	<b>0 414 720 116</b>
038 130 073 BA	<b>0 414 720 266</b>
038 130 073 BA	<b>0 986 441 560</b>
038 130 073 BE	<b>0 986 441 560</b>
038 130 073 BJ	<b>0 414 720 279</b>

038 130 073 BJ	<b>0 986 441 574</b>
038 130 073 BL	<b>0 414 720 307</b>
038 130 073 BL	<b>0 986 441 568</b>
038 130 073 BN	<b>0 414 720 363</b>
038 130 073 BN	<b>0 986 441 568</b>

038 130 073 BP	<b>0 414 720 364</b>
038 130 073 BP	<b>0 986 441 577</b>
038 130 073 BQ	<b>0 414 720 362</b>
038 130 073 BQ	<b>0 986 441 567</b>
038 130 073 F	<b>0 414 720 007</b>

038 130 073 F	<b>0 986 441 551</b>
038 130 073 H	<b>0 414 720 014</b>
038 130 073 H	<b>0 986 441 553</b>
038 130 079 BX	<b>0 986 441 557</b>
038 130 079 CX	<b>0 986 441 556</b>

038 130 107 B	<b>0 460 404 972</b>
038 130 107 B	<b>0 986 440 556</b>
038 130 107 BX	<b>0 986 440 556</b>
038 130 107 D	<b>0 460 404 977</b>
038 130 201 F	<b>0 432 193 734</b>

038 130 201 G	<b>0 432 193 732</b>
038 130 201 S	<b>0 432 193 579</b>
038 130 202	<b>0 432 193 575</b>
038 130 202 A	<b>0 432 193 594</b>
038 130 202 B	<b>0 432 193 592</b>

038 130 202 C	<b>0 432 193 573</b>
038 130 202 K	<b>0 432 193 544</b>
038 906 461 B	<b>0 986 284 009</b>
038 906 461 C	<b>0 280 217 121</b>
038 906 461 C	<b>0 281 002 757</b>

038 906 461 C	<b>0 986 280 202</b>
038 906 461 C	<b>0 986 284 010</b>
038 906 461 CX	<b>0 986 280 202</b>
038 906 461 D	<b>0 281 002 768</b>
04L 130 277	<b>0 445 110 468</b>

04L 130 277	<b>0 986 435 258</b>
04L 130 277 A	<b>0 445 110 472</b>
04L 130 277 A	<b>0 986 435 259</b>
04L 130 277 AC	<b>0 445 110 468</b>
04L 130 277 AC	<b>0 986 435 258</b>

04L 130 277 AD	<b>0 445 110 472</b>
04L 130 277 AE	<b>0 445 110 470</b>
04L 130 277 AE	<b>0 986 435 257</b>
04L 130 277 AJ	<b>0 445 110 476</b>
04L 130 277 AK	<b>0 445 110 474</b>

04L 130 277 AK	<b>0 986 435 242</b>
04L 130 277 E	<b>0 445 110 474</b>
04L 130 277 E	<b>0 986 435 242</b>
04L 130 277 G	<b>0 445 110 476</b>
04L 130 277 G	<b>0 986 435 241</b>

04L 130 277 K	<b>0 445 110 470</b>
04L 130 277 K	<b>0 986 435 257</b>
04L 130 755 D	<b>0 445 010 570</b>
04L 130 755 D	<b>0 986 437 440</b>
04L 130 755 E	<b>0 445 010 583</b>

04L 130 755 E	<b>0 986 437 440</b>
045 130 073 T	<b>0 414 720 085</b>
045 130 073 T	<b>0 986 441 551</b>
045 906 461	<b>0 281 002 318</b>
045 906 461	<b>0 986 284 002</b>

06A 906 461	<b>0 280 217 121</b>
06A 906 461	<b>0 281 002 757</b>
06A 906 461	<b>0 986 280 202</b>
06A 906 461	<b>0 986 284 010</b>
06A 906 461 C	<b>0 280 218 023</b>

06A 906 461 C	<b>0 986 280 209</b>
06A 906 461 D	<b>0 280 217 529</b>
06A 906 461 D	<b>0 986 280 210</b>
06A 906 461 G	<b>0 986 280 216</b>
06A 906 461 L	<b>0 986 280 217</b>

06A 906 461 M	<b>0 280 218 065</b>
06A 906 461 M	<b>0 986 280 218</b>
068 130 109 R	<b>0 460 484 108</b>
068 130 202 A	<b>0 432 217 210</b>
068 130 202 A	<b>0 986 430 234</b>

068 130 202 E	<b>0 986 430 225</b>
068 130 202 F	<b>0 986 430 187</b>
071 906 461 A	<b>0 280 217 529</b>
071 906 461 A	<b>0 986 280 204</b>
071 906 461 B	<b>0 280 218 017</b>

071 906 461 B	<b>0 986 280 208</b>
074 906 461 B	<b>0 281 002 461</b>
074 906 461 B	<b>0 986 284 007</b>
3C0 131 113 C	<b>0 444 021 021</b>
5Q0 131 971 B	<b>F 01C 600 266</b>

561 198 969	<b>F 01C 600 155</b>
561 198 969	<b>F 01C 600 194</b>

### SEAT ERSATZTEILE

028 130 201 J	<b>0 432 193 829</b>
038 130 073 AG	<b>0 414 720 265</b>

### SEEBER GMBH

107989300	<b>0 281 002 936</b>
1300182	<b>0 281 002 713</b>

### SETRA

4710700387	<b>0 445 120 194</b>
4710700387	<b>0 986 435 537</b>
4710700387	<b>0 986 435 642</b>

### SFH POWERTRAIN

5041880760	<b>0 445 020 093</b>
5041880760	<b>0 986 437 389</b>
5042551850	<b>0 445 120 157</b>

5042551850	<b>0 986 435 564</b>
5801479314	<b>0 445 120 361</b>
5801799074	<b>0 445 020 007</b>
5801799074	<b>0 445 020 175</b>
5801799074	<b>0 445 020 265</b>

### S.I.S.

8370 73240	<b>0 445 110 381</b>
8370 73240	<b>0 986 435 206</b>

### SISU

8363 54615	<b>0 432 191 631</b>
8364 64785	<b>0 460 424 311</b>
8366 64790	<b>0 460 423 019</b>

8366 69330	<b>0 460 423 028</b>
8366 72205	<b>0 460 423 037</b>
8366 72207	<b>0 460 423 041</b>
8367 64611	<b>0 470 004 017</b>
8367 64787	<b>0 460 424 319</b>

8368 54985	<b>0 470 006 004</b>
8368 54985	<b>0 470 006 008</b>
8368 54987	<b>0 470 506 042</b>
8368 54987	<b>0 986 444 063</b>
8368 64610	<b>0 470 006 004</b>

8368 64610	<b>0 470 006 008</b>
8368 69461	<b>0 470 006 008</b>
8370 69146	<b>0 445 020 054</b>
8370 69146	<b>0 986 437 384</b>
8370 69148	<b>0 445 020 056</b>

8370 69214	<b>0 445 120 062</b>
8370 69214	<b>0 986 435 546</b>
8370 69215	<b>0 445 120 063</b>
837073713	<b>0 445 120 235</b>
8370 73731	<b>0 445 020 610</b>

### SISU DIESEL

836664790	<b>0 460 423 019</b>
836669330	<b>0 460 423 028</b>
8366 72205	<b>0 460 423 037</b>

8366 72207	<b>0 460 423 041</b>
8367 64785	<b>0 460 424 311</b>
8367 64787	<b>0 460 424 319</b>
8367 72203	<b>0 460 424 415</b>
8367 72286	<b>0 460 424 438</b>

8370 72106	<b>0 444 022 007</b>
8370 72106	<b>0 444 022 026</b>
8370 72107	<b>0 444 023 011</b>
8370 72654	<b>0 444 022 026</b>
837073730	<b>0 445 020 512</b>

837073731	<b>0 445 020 610</b>
837074805	<b>0 445 020 611</b>
837074860	<b>0 445 124 025</b>

### SKODA

028 130 115 M	<b>0 460 404 971</b>
028 130 115 M	<b>0 986 440 555</b>
028 130 202 H	<b>0 432 193 704</b>

028 130 202 J	<b>0 432 193 702</b>
028 130 202 P	<b>0 432 193 695</b>
028 130 202 Q	<b>0 432 193 693</b>
028 130 203 E	<b>0 432 193 597</b>
028 130 203 F	<b>0 432 193 599</b>

03G 130 073 G	<b>0 414 720 454</b>
03G 130 073 G	<b>0 986 441 566</b>
03G 906 461 C	<b>0 281 002 735</b>
03H906461	<b>0 280 218 175</b>
03H 906 461 A	<b>0 280 218 260</b>

03L 130 277	<b>0 445 116 029</b>
03L 130 277	<b>0 986 435 360</b>
03L 130 277 J	<b>0 445 110 368</b>
03L 130 277 J	<b>0 986 435 166</b>
03L 130 277 Q	<b>0 445 110 646</b>

03L 130 755	<b>0 445 010 546</b>
03L 130 755	<b>0 986 437 410</b>
03L 130 755 A	<b>0 445 010 543</b>
03L 130 755 A	<b>0 986 437 410</b>
03L 130 755 AA	<b>0 445 010 565</b>

◀ SKODA

03L 130 755 AA	<b>0 986 437 405</b>
03L 130 755 AB	<b>0 445 010 566</b>
03L 130 755 AB	<b>0 986 437 405</b>
03L 130 755 AB	<b>0 986 437 420</b>
03L 130 755 D	<b>0 445 010 551</b>

03L 130 755 F	<b>0 986 437 405</b>
03L 130 755 F	<b>0 986 437 420</b>
03L 906 461 A	<b>0 281 002 956</b>
03P 906 461	<b>0 281 006 132</b>
037 906 461 C	<b>0 280 217 117</b>

037 906 461 C	<b>0 986 280 201</b>
038 130 073 AG	<b>0 414 720 265</b>
038 130 073 AG	<b>0 986 441 559</b>
038 130 073 AJ	<b>0 414 720 087</b>
038 130 073 AJ	<b>0 986 441 556</b>

038 130 073 AL	<b>0 414 720 089</b>
038 130 073 AL	<b>0 986 441 557</b>
038 130 073 AR	<b>0 414 720 214</b>
038 130 073 AR	<b>0 986 441 560</b>
038 130 073 BA	<b>0 414 720 116</b>

038 130 073 BA	<b>0 414 720 266</b>
038 130 073 BA	<b>0 986 441 560</b>
038 130 073 BH	<b>0 414 720 280</b>
038 130 073 BH	<b>0 986 441 575</b>
038 130 073 BJ	<b>0 414 720 279</b>

038 130 073 BJ	<b>0 986 441 574</b>
038 130 073 BN	<b>0 414 720 363</b>
038 130 073 BN	<b>0 986 441 568</b>
038 130 073 BP	<b>0 414 720 364</b>
038 130 073 BP	<b>0 986 441 577</b>

038 130 073 BQ	<b>0 414 720 362</b>
038 130 073 BQ	<b>0 986 441 567</b>
038 130 073 J	<b>0 414 720 015</b>
038 130 073 J	<b>0 986 441 556</b>
038 130 107 B	<b>0 460 404 972</b>

038 130 107 B	<b>0 986 440 556</b>
038 130 107 BX	<b>0 986 440 556</b>
038 130 107 D	<b>0 460 404 977</b>
038 130 107 D	<b>0 986 440 557</b>
038 130 107 J	<b>0 986 440 561</b>

038 130 107 KX	<b>0 986 440 557</b>
038 130 201 R	<b>0 432 193 584</b>
038 130 201 S	<b>0 432 193 579</b>
038 130 202 A	<b>0 432 193 594</b>
038 130 202 B	<b>0 432 193 592</b>

038 130 202 C	<b>0 432 193 573</b>
038 130 202 E	<b>0 432 193 542</b>
038 906 461	<b>0 281 002 463</b>
038 906 461	<b>0 986 284 008</b>
038 906 461 B	<b>0 986 284 009</b>

038 906 461 C	<b>0 280 217 121</b>
038 906 461 C	<b>0 281 002 757</b>
038 906 461 C	<b>0 986 280 202</b>
038 906 461 C	<b>0 986 284 010</b>
038 906 461 CX	<b>0 986 280 202</b>

04L 130 277	<b>0 445 110 468</b>
04L 130 277	<b>0 986 435 258</b>
04L 130 277 A	<b>0 445 110 472</b>
04L 130 277 A	<b>0 986 435 259</b>
04L 130 277 AA	<b>0 445 110 638</b>

04L 130 277 AD	<b>0 445 110 472</b>
04L 130 277 AE	<b>0 445 110 470</b>
04L 130 277 AE	<b>0 986 435 257</b>
04L 130 277 AJ	<b>0 445 110 476</b>
04L 130 277 AK	<b>0 445 110 474</b>

04L 130 277 AK	<b>0 986 435 242</b>
04L 130 277 E	<b>0 445 110 474</b>
04L 130 277 E	<b>0 986 435 242</b>
04L 130 277 G	<b>0 445 110 476</b>
04L 130 277 G	<b>0 986 435 241</b>

04L 130 755 D	<b>0 445 010 570</b>
04L 130 755 D	<b>0 986 437 440</b>
04L 130 755 E	<b>0 445 010 583</b>
04L 130 755 E	<b>0 986 437 440</b>
045 130 073 T	<b>0 414 720 085</b>

045 130 073 T	<b>0 986 441 551</b>
059 130 106 J	<b>0 986 444 072</b>
059 130 106 K	<b>0 986 444 083</b>
059 130 201 F	<b>0 432 133 794</b>
059 130 201 G	<b>0 432 133 785</b>

059 130 202 F	<b>0 432 133 792</b>
059 130 202 G	<b>0 432 133 783</b>
06A 906 461	<b>0 280 217 121</b>
06A 906 461	<b>0 281 002 757</b>
06A 906 461	<b>0 986 280 202</b>

06A 906 461	<b>0 986 284 010</b>
06A 906 461 D	<b>0 280 217 529</b>
06A 906 461 D	<b>0 986 280 210</b>
06A 906 461 G	<b>0 986 280 216</b>
06A 906 461 L	<b>0 986 280 217</b>

06A 906 461 LX	<b>0 986 280 217</b>
06A 906 461 N	<b>0 280 218 100</b>
06A 906 461 N	<b>0 986 280 223</b>
068 130 202 F	<b>0 986 430 187</b>
074 906 461 B	<b>0 281 002 461</b>

074 906 461 B	<b>0 986 284 007</b>
3C0 131 113 C	<b>0 444 021 021</b>
5Q0 131 971 B	<b>F 01C 600 266</b>

SMART (MCC)	
Q0001456V003	<b>0 986 437 019</b>
Q0001456V004	<b>0 445 010 273</b>
Q0001587V002	<b>0 445 110 022</b>

000 1456 V003	<b>0 986 437 019</b>
000 1456 V004	<b>0 445 010 273</b>
000 1587 V002	<b>0 445 110 022</b>
640 070 06 01	<b>0 986 437 368</b>
640 070 07 01	<b>0 986 437 368</b>

640 070 07 87	<b>0 445 110 166</b>
640 070 07 87	<b>0 986 435 117</b>
660 070 01 87	<b>0 445 110 022</b>
660 070 01 87	<b>0 986 435 008</b>
660 070 03 87	<b>0 445 110 302</b>

660 070 03 87	<b>0 986 435 184</b>
---------------	----------------------

SMP (STANDARD MOTOR PARTS)	
FJ1009	<b>0 986 435 518</b>
FJ1010	<b>0 986 435 519</b>

FJ1168	<b>0 986 435 367</b>
FJ1173	<b>0 445 117 049</b>
FJ1174	<b>0 986 435 382</b>
FJ1216	<b>0 445 117 037</b>
FJ1221	<b>0 986 435 415</b>

FJ1222	<b>0 986 435 415</b>
FJ1223	<b>0 986 435 433</b>
FJ1224	<b>0 986 435 433</b>
FJ1227	<b>0 986 435 409</b>
FJ489	<b>0 986 435 504</b>

FJ495	<b>0 986 435 502</b>
FJ921	<b>0 986 435 053</b>
FJ922	<b>0 986 435 109</b>
FJ932	<b>0 986 435 503</b>
FJ933	<b>0 986 435 505</b>

FJ961	<b>0 986 435 520</b>
FJ962	<b>0 986 435 521</b>
IP24	<b>F 00E 200 431</b>
IP31	<b>0 986 437 366</b>
IP32	<b>0 986 437 363</b>

MF21178	<b>0 280 218 230</b>
MF21178	<b>0 280 218 234</b>

SNCF	
07700163	<b>0 432 131 628</b>
07710101	<b>0 432 193 816</b>
07710104	<b>0 432 131 831</b>

07710105	<b>0 432 131 631</b>
07710106	<b>0 432 131 633</b>
07710128	<b>0 432 131 629</b>
07710142	<b>0 445 120 014</b>
07710148	<b>0 432 191 616</b>

07710300	<b>F 00B C00 010</b>
07711300	<b>0 445 120 068</b>
07728207	<b>0 445 120 154</b>
7711300	<b>0 445 120 068</b>
77710618	<b>0 445 020 208</b>

SPICA	
55226700	<b>0 445 110 398</b>
55226700	<b>0 986 435 247</b>

SSANGYONG	
A 665 094 31 48	<b>0 280 218 199</b>
000 094 05 48	<b>0 280 217 517</b>
002 017 34 21	<b>0 432 217 157</b>

002 017 97 21	<b>0 986 430 205</b>
003 017 29 21	<b>0 432 217 169</b>
003 017 57 21	<b>0 432 231 678</b>
003 017 57 21	<b>0 986 430 205</b>
162 094 31 48	<b>0 280 217 517</b>

661 017 31 21	<b>0 432 217 157</b>
665 094 30 48	<b>0 280 218 130</b>
665 094 31 48	<b>0 280 218 199</b>

STANADYNE	
XHDM 781589	<b>0 986 430 031</b>
29300	<b>0 432 131 850</b>
29300	<b>0 986 430 031</b>

STAR TRUCK	
51101007377	<b>0 432 131 820</b>
51101007397	<b>0 432 131 702</b>
51111037536	<b>0 460 424 150</b>

STEYR FAHRZEUGTECHNIK	
125 809 77	<b>0 280 218 136</b>
164 490 05 13	<b>0 444 021 024</b>

551 905 87	<b>0 281 002 764</b>
553 500 48	<b>0 281 002 683</b>
7531702	<b>0 280 218 159</b>
7566989	<b>0 280 218 159</b>
7801951	<b>0 281 002 849</b>

7801951	<b>0 281 002 936</b>
---------	----------------------

STEYR (STEYR-DAIMLER-PUCH AG)	
0000100651	<b>0 432 217 280</b>
0000100651	<b>0 986 430 388</b>

0020171812	<b>0 432 217 290</b>
0020171812	<b>0 986 430 505</b>
311 00 08 0125	<b>0 432 291 619</b>
409 08 0071	<b>0 432 281 812</b>
47506932	<b>0 444 043 080</b>



475 06 9320	<b>0 444 043 080</b>
475 117 24	<b>0 444 023 058</b>
475 11 7240	<b>0 444 023 058</b>
612 60 08 0193	<b>0 432 191 638</b>
612 60 08 0230	<b>0 432 291 512</b>

615 60 08 0148	<b>0 432 191 817</b>
615 60 08 0178	<b>0 432 191 773</b>
615 60 08 0218	<b>0 432 191 773</b>
615 60 08 0276	<b>0 432 191 659</b>
815 60 08 0282	<b>0 432 281 699</b>

842 46 8920	<b>0 444 022 021</b>
842 47 0210	<b>0 444 023 058</b>
843 49 0240	<b>0 444 043 011</b>
915 60 08 0148	<b>0 432 191 773</b>

**SUBARU**

22100 0W010	<b>0 445 010 214</b>
22100 0W010	<b>0 986 437 338</b>
22100 33050	<b>0 445 010 214</b>

22100 33050	<b>0 986 437 338</b>
-------------	----------------------

**SUZUKI**

127603	<b>0 281 002 619</b>
13800 T68L5 0	<b>0 281 006 054</b>
13800 T7950 001	<b>0 281 002 683</b>

13800-T84E50	<b>0 281 002 619</b>
13800 T86J0	<b>0 281 002 862</b>
13800-68L50	<b>0 281 006 054</b>
13800 68L50 000	<b>0 281 006 054</b>
13800-79J50	<b>0 281 002 683</b>

13800 79J50 000	<b>0 281 002 683</b>
13800-79J80	<b>0 281 002 860</b>
13800 79J80 000	<b>0 281 002 860</b>
13800-84E50	<b>0 281 002 619</b>
13800 84E50 000	<b>0 281 002 619</b>

13800-86J00	<b>0 281 002 862</b>
13800 86J00 000	<b>0 281 002 862</b>
15110-84E50	<b>0 445 010 277</b>
15110-84E50	<b>0 986 437 024</b>
15110-84E50	<b>0 986 437 201</b>

15110 84E50 000	<b>0 445 010 277</b>
15110 84E50 000	<b>0 986 437 024</b>
15110-84E51	<b>0 445 010 278</b>
15110-84E51	<b>0 986 437 024</b>
15110-84E51	<b>0 986 437 201</b>

15200-62M01	<b>0 445 010 414</b>
15200-62M01-000	<b>0 445 010 414</b>
15200-63P00	<b>0 445 010 310</b>
15200-63P00	<b>0 986 437 038</b>
15200 63P00 000	<b>0 445 010 310</b>

15200 63P00 000	<b>0 986 437 038</b>
15200 63P00 010	<b>0 986 437 097</b>
15200-67G00	<b>0 445 010 010</b>
15200-67G00	<b>0 445 010 162</b>
15200 67G00 000	<b>0 445 010 010</b>

15200 67G00 000	<b>0 445 010 162</b>
15200-67G10	<b>0 445 010 021</b>
15200-67G10	<b>0 986 437 012</b>
15200 67G10 000	<b>0 445 010 021</b>
15200 67G10 000	<b>0 986 437 012</b>

15200-68L10	<b>0 445 010 293</b>
15200-68L10	<b>0 986 437 036</b>
15200 68L10 000	<b>0 445 010 293</b>
15200 68L10 000	<b>0 986 437 036</b>
15200-69K00	<b>0 445 010 296</b>

15200-69K00	<b>0 986 437 028</b>
15200 69K00 000	<b>0 445 010 296</b>
15200 69K00 000	<b>0 986 437 028</b>
15200-79J80	<b>0 445 010 184</b>
15200-79J80	<b>0 445 010 241</b>

15200-86J00	<b>0 445 010 278</b>
15200-86J00	<b>0 986 437 024</b>
15200-86J00	<b>0 986 437 201</b>
15210-67JG2-000	<b>0 445 010 087</b>
15210-67JH1-000	<b>0 445 010 148</b>

15210-67JH1-000	<b>0 986 437 043</b>
15210-67JH2-000	<b>0 445 010 218</b>
15310-67G00	<b>0 445 110 044</b>
15310-67G00	<b>0 986 435 003</b>
15310 67G00 000	<b>0 445 110 044</b>

15310 67G00 000	<b>0 986 435 003</b>
15310-67G10	<b>0 445 110 044</b>
15310-67G12	<b>0 445 110 044</b>
15310-67G12	<b>0 986 435 003</b>
15310 67G12 000	<b>0 445 110 044</b>

15310 67G12 000	<b>0 986 435 003</b>
15310-67G30	<b>0 445 110 057</b>
15310-67G30	<b>0 986 435 093</b>
15310 67G30 000	<b>0 445 110 057</b>
15310 67G30 000	<b>0 986 435 093</b>

15310-67JG0	<b>0 445 110 230</b>
15310-67JG0	<b>0 986 435 124</b>
15310 67JG0 000	<b>0 445 110 230</b>
15310-67JG0-000	<b>0 986 435 124</b>
15310-69K00	<b>0 445 110 239</b>

15310-69K00	<b>0 986 435 122</b>
15310 69K00 000	<b>0 445 110 239</b>
15310 69K00 000	<b>0 986 435 122</b>
15310-80KAO-000	<b>0 445 110 328</b>
15310-80KAO-000	<b>0 986 435 188</b>

15710-63P00	<b>0 445 110 351</b>
15710 63P00 000	<b>0 445 110 351</b>
15710-68L00	<b>0 445 110 398</b>
15710-68L00	<b>0 986 435 247</b>
15710-79J50	<b>0 445 110 276</b>

15710-79J50	<b>0 986 435 148</b>
15710 79J50 000	<b>0 445 110 276</b>
15710 79J50 000	<b>0 986 435 148</b>
15710-79J81	<b>0 445 110 299</b>
15710-79J81	<b>0 986 435 230</b>

15710-84E60	<b>0 445 110 083</b>
15710 84E60 000	<b>0 445 110 083</b>
15710-86J20	<b>0 445 110 316</b>
15710-86J20	<b>0 986 435 226</b>
15710 86J20 000	<b>0 445 110 316</b>

15710 86J20 000	<b>0 986 435 226</b>
-----------------	----------------------

**SWAG AUTOTEILE**

10 92 8340	<b>0 281 002 152</b>
10 92 9315	<b>0 281 002 535</b>
10 92 9517	<b>0 281 002 656</b>

10 92 9910	<b>0 281 002 384</b>
30 92 8532	<b>0 281 002 429</b>
30 92 8596	<b>0 281 002 757</b>
30 92 8596	<b>0 986 284 010</b>
30 92 8603	<b>0 281 002 216</b>

30 93 1412	<b>0 281 002 461</b>
40 92 3877	<b>0 281 002 180</b>
40 92 7703	<b>0 281 002 428</b>
40 93 7228	<b>0 281 002 683</b>

**SWARAJ MAZDA**

LP24-13-H50	<b>F 002 C7Z 211</b>
-------------	----------------------

**TALBOT**

1979 46	<b>0 986 430 015</b>
1979 46	<b>0 986 430 028</b>
91 538 877 80	<b>0 280 202 097</b>

93 501 091 80	<b>0 986 430 015</b>
93 501 091 80	<b>0 986 430 028</b>
93 501 380 80	<b>0 986 430 010</b>
93 510 454 80	<b>0 986 430 028</b>
96 004 017 80	<b>0 986 430 028</b>

96 011 913 80	<b>0 986 430 028</b>
---------------	----------------------

**TATA (TELCO)**

252501160123	<b>F 002 C8Z 860</b>
252501160141	<b>0 445 110 497</b>
252507120156	<b>0 445 025 012</b>

252701160140	<b>0 445 110 438</b>
252707100243	<b>0 460 424 996</b>
278607990155	<b>0 445 025 608</b>
278607990157	<b>0 445 120 369</b>
279715209903	<b>0 280 218 183</b>

5292180	<b>0 460 426 520</b>
---------	----------------------

**TEMISA**

A028Y793	<b>0 444 042 014</b>
D1674662	<b>0 444 012 003</b>
1435558	<b>0 414 755 008</b>

1642684	<b>0 432 191 254</b>
4988595	<b>0 445 020 150</b>
4 988 835	<b>0 445 120 161</b>
51 10100 6083	<b>0 445 120 162</b>
51 10100 6083	<b>0 986 435 565</b>

51 10100 6085	<b>0 445 120 147</b>
51 10100 6085	<b>0 986 435 562</b>
51 10100 6126	<b>0 445 120 217</b>
51 10100 6127	<b>0 445 120 219</b>
51 10100 7441	<b>0 432 133 799</b>

51 10100 7442	<b>0 432 133 798</b>
51 11103 7763	<b>0 445 020 060</b>
51 11103 7792	<b>0 445 020 075</b>
51 11103 7797	<b>0 986 437 359</b>
5 263 321	<b>0 445 120 250</b>

**TOPRAN**

108 719	<b>0 281 002 216</b>
109 683	<b>0 281 002 429</b>
110 888	<b>0 281 002 461</b>

110 897	<b>0 281 002 757</b>
110 897	<b>0 986 284 010</b>
111 047	<b>0 281 002 463</b>
206 616	<b>0 281 002 428</b>
206 618	<b>0 281 002 180</b>

207 186	<b>0 281 002 479</b>
207 187	<b>0 281 002 549</b>
207 550	<b>0 281 002 139</b>
401 334	<b>0 281 002 384</b>
401 625	<b>0 281 002 489</b>

721 271	<b>0 281 002 184</b>
---------	----------------------

**TOYO-SHA**

6501515001	<b>9 430 610 360</b>
6541515001	<b>9 430 610 362</b>





**TOYOTA**

22100 0N010	<b>0 445 010 113</b>
22100 0N011	<b>0 445 010 113</b>
22100 0N020	<b>0 445 010 134</b>

22100 0N020	<b>0 986 437 372</b>
22100 0N030	<b>0 445 010 460</b>
22100 0N030 00	<b>0 445 010 460</b>
22100 0W010	<b>0 445 010 214</b>
22100 0W010	<b>0 445 010 258</b>

22100 0W010	<b>0 986 437 338</b>
22100 0W020	<b>0 445 010 392</b>
22100 0W020	<b>0 986 437 338</b>
22100 33011	<b>0 445 010 112</b>
22100 33011	<b>0 445 010 113</b>

22100 33020	<b>0 445 010 114</b>
22100 33030	<b>0 445 010 106</b>
2210033030C	<b>0 445 010 106</b>
22100 33040	<b>0 445 010 105</b>
22100 33040	<b>0 986 437 335</b>

22100 33050	<b>0 445 010 214</b>
22100 33050	<b>0 986 437 338</b>
2360058110C	<b>9 430 610 299</b>
23670 0N020	<b>0 445 110 214</b>
23670 0N030	<b>0 445 110 262</b>

23670 0N030	<b>0 986 435 191</b>
23670 0N040	<b>0 445 110 262</b>
23670 0N040	<b>0 986 435 191</b>
23670 0N050	<b>0 445 110 590</b>
23670 0N050 00	<b>0 445 110 699</b>

23670 0W010	<b>0 445 116 009</b>
23670 0W010	<b>0 445 116 053</b>
23670 0W010	<b>0 986 435 418</b>
23670 0W020	<b>0 445 116 054</b>
23670 0W020	<b>0 986 435 419</b>

23670 0W020 00	<b>0 445 110 699</b>
23670 33010B	<b>0 445 110 215</b>
23670 33020	<b>0 445 110 142</b>
23670 33020	<b>0 445 110 143</b>
23670 33030	<b>0 445 110 215</b>

23670 33040	<b>0 445 110 227</b>
23670 33040	<b>0 986 435 177</b>
23670 33050	<b>0 445 116 009</b>
23670 33050	<b>0 445 116 052</b>
23670 33050	<b>0 986 435 416</b>

23670 33051	<b>0 445 116 009</b>
23670 33060	<b>0 445 116 044</b>
23670 33060	<b>0 986 435 417</b>
23670 366F0	<b>0 445 110 227</b>
23670 366F0	<b>0 986 435 177</b>

**TOYOTA MOTOR  
CORP. AUSTRALIA**

22100 E0120	<b>0 445 020 068</b>
22100 E0521	<b>0 445 020 135</b>

23670 E0243	<b>0 445 120 095</b>
23670 E0243	<b>0 986 435 636</b>
23670 E0470	<b>F 01G 001 010</b>
23670 E0470	<b>0 986 435 639</b>
23670 E0490	<b>0 445 120 243</b>

23670 E0490	<b>0 986 435 638</b>
23670 33010	<b>0 445 110 085</b>

**TRW**

JCS156	<b>0 281 002 478</b>
--------	----------------------

**TÜRK TRAKTÖR**

5099371	<b>0 432 191 231</b>
84193102	<b>0 460 423 049</b>
84300595	<b>0 460 423 055</b>

**UAZ**

20 3855	<b>0 280 218 037</b>
293 3763000-04	<b>0 280 218 037</b>
31602 3877012	<b>0 280 218 037</b>

31602 3877014	<b>0 280 218 037</b>
3163-00-3877013-	<b>0 280 218 220</b>
316310.3877010.00	<b>0 281 002 763</b>
316310.3877010.00	<b>0 281 002 764</b>
316310.3877010.00	<b>0 281 006 048</b>

504088755	<b>0 445 110 273</b>
504088755	<b>0 986 435 165</b>
504245256	<b>0 445 010 181</b>
504245256	<b>0 986 437 085</b>
51432.1112010	<b>0 445 110 502</b>

**UD TRUCKS**

16600 J2000	<b>9 430 610 308</b>
16600 J5570	<b>9 430 610 322</b>
16600 J5571	<b>9 430 610 318</b>

16600 J6500	<b>9 430 610 323</b>
16600LC30A	<b>0 445 110 433</b>
16600 L9200	<b>9 430 610 052</b>
16600 T7200	<b>9 430 610 056</b>
16600 T7225	<b>9 430 610 054</b>

16600 T9000	<b>9 430 610 004</b>
16600 T9300	<b>9 430 610 915</b>
16600 T9301	<b>9 430 610 988</b>
16600 T9302	<b>9 430 610 999</b>
16600 T9303	<b>9 430 611 044</b>

16600 V1300	<b>9 430 613 166</b>
16600 V6600	<b>9 430 610 355</b>
16600 V6625	<b>9 430 610 364</b>
16600 Y8400	<b>9 430 610 003</b>
16600 Y8401	<b>9 430 610 038</b>

16600 Y8425	<b>9 430 613 164</b>
16600 Z0000	<b>9 430 610 962</b>
16600 Z0001	<b>9 430 611 016</b>
16600 Z0002	<b>9 430 611 117</b>
16600 Z0003	<b>9 430 612 952</b>

16600 Z5503	<b>9 430 610 808</b>
16600 Z5505	<b>9 430 610 839</b>
16600 Z5519	<b>9 430 610 044</b>
16600 Z5560	<b>9 430 611 047</b>
16600 Z5561	<b>9 430 612 979</b>

16600 Z5565	<b>9 430 611 337</b>
16600 Z5568	<b>9 430 611 341</b>
16600 Z5570	<b>9 430 611 371</b>
16600 Z5574	<b>9 430 611 401</b>
16600 Z5575	<b>9 430 611 157</b>

16600 Z5577	<b>9 430 611 445</b>
16600 Z5579	<b>9 430 611 455</b>
16600 Z5604	<b>9 430 611 565</b>
16600 Z5606	<b>9 430 611 505</b>
16600 Z5608	<b>9 430 611 510</b>

16600 Z5609	<b>9 430 611 522</b>
16600 Z5610	<b>9 430 613 010</b>
16600 Z5611	<b>9 430 612 991</b>
16600 Z5612	<b>9 430 612 990</b>
16600 Z5615	<b>9 430 612 618</b>

16600 Z5616	<b>9 430 613 183</b>
16600 Z5617	<b>9 430 612 718</b>
16600 Z5618	<b>9 430 612 627</b>
16600 Z5619	<b>9 430 613 184</b>
16600 Z5660	<b>9 430 613 052</b>

16600 Z5661	<b>9 430 613 185</b>
16600 Z5662	<b>9 430 613 053</b>
16600 Z5663	<b>9 430 612 723</b>
16600 Z5665	<b>9 430 610 521</b>
16600 Z5670	<b>9 430 611 688</b>

16600 Z5674	<b>9 430 610 582</b>
16600 Z5679	<b>9 430 610 586</b>
16600 Z5700	<b>9 430 610 201</b>
16600 Z5701	<b>9 430 610 202</b>
16600 Z5702	<b>9 430 610 203</b>

16600 Z5708	<b>9 430 610 222</b>
16600 Z5709	<b>9 430 612 694</b>
16600 Z5711	<b>9 430 610 230</b>
16600 Z6000	<b>9 430 612 619</b>
16600 Z6001	<b>9 430 612 620</b>

16600 Z6002	<b>9 430 613 051</b>
16600 Z6003	<b>9 430 612 722</b>
16600 Z6006	<b>9 430 610 204</b>
16600 0F000	<b>9 430 610 125</b>
16600 0T300	<b>9 430 613 285</b>

16600 01D00	<b>9 430 611 390</b>
16600 01D01	<b>9 430 611 400</b>
16600 01D02	<b>9 430 611 406</b>
16600 01T00	<b>9 430 611 347</b>
16600 01T01	<b>9 430 611 355</b>

16600 01T02	<b>9 430 611 367</b>
16600 01T20	<b>9 430 611 375</b>
16600 01T60	<b>9 430 611 348</b>
16600 13G00	<b>9 430 610 394</b>
16600 17D01	<b>9 430 612 634</b>

16600200531	<b>9 430 610 057</b>
16600 29D00	<b>9 430 612 673</b>
16600 36W00	<b>9 430 610 006</b>
16600 37500	<b>9 430 611 990</b>
16600 37502	<b>9 430 610 002</b>

16600 4K001	<b>9 430 613 718</b>
16600 43G01	<b>9 430 610 405</b>
16600 43G02	<b>9 430 610 048</b>
16600 43G21	<b>9 430 610 065</b>
16600 43G22	<b>9 430 610 065</b>

16600 43G23	<b>9 430 613 539</b>
16600 45K00	<b>9 430 612 592</b>
16600 45K01	<b>9 430 612 593</b>
16600 54T00	<b>9 430 612 484</b>
16600 63G01	<b>9 430 610 135</b>

16600 64W00	<b>9 430 610 354</b>
16600 9X700	<b>0 432 193 548</b>
16600 9X701	<b>0 432 193 548</b>
16600 90013	<b>9 430 611 257</b>
16600 90017	<b>9 430 611 258</b>

16600 90018	<b>9 430 611 259</b>
16600 90019	<b>9 430 610 053</b>
16600 90021	<b>9 430 610 315</b>
16600 90025	<b>9 430 613 163</b>
16600 90060	<b>9 430 610 058</b>

16600 90062	<b>9 430 612 976</b>
16600 90064	<b>9 430 611 043</b>
16600 90071	<b>9 430 613 160</b>
16600 90108	<b>9 430 613 144</b>
16600 95001	<b>9 430 611 281</b>

16600 95002	<b>9 430 610 734</b>
16600 95003	<b>9 430 610 968</b>
16600 95004	<b>9 430 610 997</b>
16600 95006	<b>9 430 610 998</b>
16600 95008	<b>9 430 612 980</b>

16600 95009	<b>9 430 611 048</b>
16600 95011	<b>9 430 611 060</b>
16600 95014	<b>9 430 611 354</b>
16600 95015	<b>9 430 611 370</b>
16600 95016	<b>9 430 613 016</b>

16600 95018	<b>9 430 613 186</b>
16600 95500	<b>9 430 611 158</b>
16600 95503	<b>9 430 611 503</b>
16600 95504	<b>9 430 612 775</b>
16600 95505	<b>9 430 611 912</b>

16600 96003	<b>9 430 610 752</b>
16600 96005	<b>9 430 610 767</b>
16600 96008	<b>9 430 611 032</b>
16600 96010	<b>9 430 611 034</b>
16600 96011	<b>9 430 611 035</b>

16600 96500	<b>9 430 610 455</b>
16600 96504	<b>9 430 610 905</b>
16600 96506	<b>9 430 610 917</b>
16600 96508	<b>9 430 610 940</b>
16600 96509	<b>9 430 610 963</b>

16600 96512	<b>9 430 611 012</b>
16600 96513	<b>9 430 611 079</b>
16600 96518	<b>9 430 611 340</b>
16600 96562	<b>9 430 611 129</b>
16600 96564	<b>9 430 611 141</b>

16600 96565	<b>9 430 611 152</b>
16600 96566	<b>9 430 611 153</b>
16600 96567	<b>9 430 611 154</b>
16600 96568	<b>9 430 611 159</b>
16600 96569	<b>9 430 611 171</b>

16600 96577	<b>9 430 611 462</b>
16600 96578	<b>9 430 611 475</b>
16600 96600	<b>9 430 612 778</b>
16600 96601	<b>9 430 612 777</b>
16600 96602	<b>9 430 611 504</b>

16600 96604	<b>9 430 611 897</b>
16600 96605	<b>9 430 611 529</b>
16600 96606	<b>9 430 610 509</b>
16600 96611	<b>9 430 611 950</b>
16600 97005	<b>9 430 611 289</b>

16600 97006	<b>9 430 611 298</b>
16600 97009	<b>9 430 610 753</b>
16600 97012	<b>9 430 610 788</b>
16600 97014	<b>9 430 610 814</b>
16600 97018	<b>9 430 610 902</b>

16600 97019	<b>9 430 610 083</b>
16600 97061	<b>9 430 611 049</b>
16600 97063	<b>9 430 611 089</b>
16600 97064	<b>9 430 611 093</b>
16600 97065	<b>9 430 611 344</b>

16600 97066	<b>9 430 611 097</b>
16600 97068	<b>9 430 611 388</b>
16600 97069	<b>9 430 611 135</b>
16600 97072	<b>9 430 611 146</b>
16600 97073	<b>9 430 611 536</b>

16600 97076	<b>9 430 612 779</b>
16600 97077	<b>9 430 612 780</b>
16600 97102	<b>9 430 612 774</b>
16600 97103	<b>9 430 612 773</b>
16600 97104	<b>9 430 612 790</b>

16600 97105	<b>9 430 611 808</b>
16600 97106	<b>9 430 610 508</b>
16600 97107	<b>9 430 612 788</b>
16600 97110	<b>9 430 613 466</b>
16600 97111	<b>9 430 613 182</b>

16600 97112	<b>9 430 611 929</b>
16600 97114	<b>9 430 611 895</b>
16600 97115	<b>9 430 611 911</b>
16600 97116	<b>9 430 612 789</b>
16600 97117	<b>9 430 611 901</b>

16600 97119	<b>9 430 611 945</b>
16600 97164	<b>9 430 612 937</b>
16600 97173	<b>9 430 613 492</b>
16600 97174	<b>9 430 613 493</b>
16600 97179	<b>9 430 613 495</b>

16600 97200	<b>9 430 613 499</b>
16600 97201	<b>9 430 613 501</b>
16600 97202	<b>9 430 613 503</b>
16610 L9200	<b>9 430 615 046</b>
16610 Z5506	<b>9 430 615 046</b>

16610 Z9002	<b>9 430 615 046</b>
16610 90016	<b>9 430 615 048</b>
16650 00710	<b>0 414 701 023</b>
16700MA70B	<b>0 445 010 136</b>
16700MA70B	<b>0 445 020 118</b>

16700MA70B	<b>0 986 437 031</b>
16700 R8114	<b>9 460 610 020</b>
16700 R8118	<b>9 460 610 248</b>
16700 R8302	<b>9 460 610 163</b>
16700 R8306	<b>9 460 610 049</b>

16700 R8307	<b>9 460 610 399</b>
16700 R8308	<b>9 460 610 050</b>
16700 R8309	<b>9 460 610 270</b>
16700 R8310	<b>9 460 610 279</b>
16700 R8313	<b>9 460 610 135</b>

16700 R8315	<b>9 460 610 136</b>
16700 R8801	<b>9 460 610 280</b>
16700 R8802	<b>9 460 610 281</b>
16700 R8803	<b>9 460 610 282</b>
16700 T7208	<b>9 460 610 400</b>

16700 T8206	<b>9 460 610 047</b>
16700 T8212	<b>9 460 610 048</b>
16700 T8270	<b>9 460 610 006</b>
16700 T8271	<b>9 460 610 229</b>
16700 T8273	<b>9 460 610 053</b>

16700 VH202	<b>9 460 611 503</b>
16700VX10B	<b>F 01G 09P 26U</b>
16700 OF005	<b>9 460 610 702</b>
16700 OT681	<b>9 460 611 179</b>
16700 OY100	<b>9 460 610 965</b>

16700 O2N14	<b>9 460 610 240</b>
16700 O2N18	<b>9 460 610 243</b>
16700 O2N19	<b>9 460 610 241</b>
16700 O2N70	<b>9 460 610 416</b>
16700 O2N72	<b>9 460 612 011</b>

16700 O2N73	<b>9 460 610 710</b>
16700 O2N74	<b>9 460 610 341</b>
16700 O2N75	<b>9 460 610 735</b>
16700 O5D10	<b>9 460 611 660</b>
16700 O5D11	<b>9 460 611 661</b>

16700 O9W01	<b>9 460 610 051</b>
16700 O9W05	<b>9 460 610 251</b>
16700 1S800	<b>9 460 610 826</b>
16700 10G03	<b>9 460 610 165</b>
16700 10H03	<b>9 460 610 256</b>

16700 10H05	<b>9 460 610 412</b>
16700 10T07	<b>9 460 610 242</b>
16700 10T10	<b>9 460 610 732</b>
16700 10T11	<b>9 460 610 388</b>
16700 11H02	<b>9 460 610 634</b>

16700 18G01	<b>9 460 610 653</b>
16700 2H213	<b>9 460 611 021</b>
16700 2S614	<b>9 460 611 356</b>
16700 21N01	<b>9 460 610 343</b>
16700 21T08	<b>9 460 610 436</b>

16700 21T12	<b>9 460 610 445</b>
16700 21T13	<b>9 460 610 430</b>
16700 24N00	<b>9 460 610 373</b>
16700 24N01	<b>9 460 614 311</b>
16700 28T04	<b>9 460 611 543</b>

16700 3S815	<b>9 460 613 990</b>
16700 30N05	<b>9 460 610 414</b>
16700 30N07	<b>9 460 610 351</b>
16700 30N08	<b>9 460 610 352</b>
16700 30N09	<b>9 460 610 564</b>

16700 30N12	<b>9 460 610 588</b>
16700 31N01	<b>9 460 610 344</b>
16700 31N09	<b>9 460 612 890</b>
16700 34T03	<b>9 460 610 473</b>
16700 40K01	<b>9 460 611 539</b>

16700 40K04	<b>9 460 610 673</b>
16700 40K07	<b>9 460 610 674</b>
16700 43G13	<b>9 460 610 325</b>
16700 43G14	<b>9 460 610 326</b>
16700 43G16	<b>9 460 610 327</b>

16700 43G19	<b>9 460 610 536</b>
16700 43G20	<b>9 460 610 538</b>
16700 43G21	<b>9 460 610 727</b>
16700 44G04	<b>9 460 610 314</b>
16700 44G06	<b>9 460 610 420</b>

16700 47N00	<b>9 460 610 734</b>
16700 47N11	<b>9 460 610 733</b>
16700 51H06	<b>9 460 610 571</b>
16700 51H07	<b>9 460 610 570</b>
16700 51H12	<b>9 460 612 000</b>

16700 51N20	<b>9 460 610 846</b>
16700 54W01	<b>9 460 610 555</b>
16700 54W03	<b>9 460 610 010</b>
16700 54W04	<b>9 460 610 052</b>
16700 56T02	<b>9 460 611 937</b>

1670069T01	<b>9 460 610 660</b>
16700 80G07	<b>9 460 610 519</b>
16700 80G17	<b>9 460 610 561</b>
16700 90078	<b>9 460 610 633</b>
16713 97204	<b>9 400 613 400</b>

20419-00Z0A	<b>0 444 012 010</b>
21190244	<b>0 444 022 029</b>
21687116	<b>0 444 022 042</b>
21911398	<b>0 444 022 047</b>
21966588	<b>0 444 022 052</b>

22169011	<b>0 444 022 059</b>
----------	----------------------

## UNIC

000 771 354	<b>0 432 297 034</b>
061 315 024	<b>0 432 191 818</b>
4 750 405	<b>0 432 281 704</b>

61 316 336	<b>0 432 191 818</b>
984 113 207	<b>0 432 291 580</b>
98 413 207	<b>0 432 291 580</b>

## UNICARRIERS

16600LC30A	<b>0 445 110 433</b>
16600LC30C	<b>0 445 110 856</b>
16600LC30C	<b>0 986 435 295</b>

16600T7225	<b>9 430 610 054</b>
16600T9000	<b>9 430 610 004</b>
1660090060	<b>9 430 610 058</b>
1661090016	<b>9 430 615 048</b>
16700LC30B	<b>0 445 010 418</b>

## URAL AUTOMOBIL PLANT

99434327	<b>0 432 291 516</b>
----------	----------------------

## VALMET

145 140	<b>9 430 082 289</b>
836 354 615	<b>0 432 191 631</b>

## VAUXHALL

R1090057	<b>0 986 444 005</b>
R1590037	<b>0 986 444 001</b>
R1590040	<b>0 470 504 003</b>

R1590040	<b>0 986 444 002</b>
R1590041	<b>0 986 444 012</b>
R1590042	<b>0 986 444 500</b>
R1590043	<b>0 986 444 014</b>
R1590050	<b>0 986 444 021</b>

R1590051	<b>0 986 444 028</b>
R1590052	<b>0 986 444 029</b>
R1590054	<b>0 986 444 030</b>
R1590055	<b>0 986 444 037</b>
R1590056	<b>0 986 444 036</b>

R1590063	<b>0 986 435 102</b>
R1590064	<b>0 986 435 082</b>
R1590065	<b>0 986 435 103</b>
R1590066	<b>0 986 435 088</b>
R1590067	<b>0 986 435 104</b>



◀ VAUXHALL

R1590068	<b>0 986 435 105</b>
R1590069	<b>0 986 435 089</b>
R1590070	<b>0 986 435 079</b>
R1590072	<b>0 986 435 075</b>
R1590073	<b>0 986 435 106</b>

R1590074	<b>0 986 435 086</b>
R1590075	<b>0 986 435 007</b>
R1590076	<b>0 986 435 095</b>
R1590077	<b>0 986 435 078</b>
09208679	<b>0 280 218 051</b>

09208679	<b>0 986 280 231</b>
13261544	<b>0 280 218 226</b>
13262124	<b>0 280 218 207</b>
13280277	<b>0 280 218 244</b>
13301682	<b>0 280 218 254</b>

24413104	<b>0 470 504 016</b>
24413104	<b>0 986 444 021</b>
55198218	<b>0 445 110 243</b>
55198218	<b>0 986 435 104</b>
55219886	<b>0 445 110 351</b>

55221017	<b>0 445 110 276</b>
55221023	<b>0 445 110 300</b>
55221024	<b>0 445 110 299</b>
55221024	<b>0 986 435 230</b>
55233955	<b>0 445 110 419</b>

55236707	<b>0 445 010 265</b>
55236707	<b>0 445 010 425</b>
55236707	<b>0 986 437 097</b>
55237688	<b>0 445 010 305</b>
55237689	<b>0 986 437 095</b>

55237690	<b>0 445 010 310</b>
55246223	<b>0 445 110 524</b>
55246223	<b>0 986 435 280</b>
55246508	<b>0 986 437 095</b>
55255408	<b>0 445 110 618</b>

55255416	<b>0 445 010 425</b>
55255416	<b>0 986 437 097</b>
55267246	<b>0 445 010 466</b>
55352883	<b>0 470 504 219</b>
55352883	<b>0 986 444 037</b>

55352884	<b>0 470 504 218</b>
55352884	<b>0 986 444 036</b>
55485045	<b>0 445 010 703</b>
55488616	<b>0 445 110 713</b>
55491093	<b>0 445 110 809</b>

55494494	<b>0 445 010 759</b>
55561912	<b>0 281 002 940</b>
55562426	<b>0 281 002 912</b>
55565209	<b>0 445 117 018</b>
55565209	<b>0 986 435 427</b>

55565210	<b>0 445 010 550</b>
55566050	<b>0 445 110 327</b>
55566050	<b>0 986 435 201</b>
55566498	<b>0 445 110 325</b>
55566498	<b>0 986 435 199</b>

55567369	<b>0 445 010 293</b>
55567369	<b>0 986 437 036</b>
55567370	<b>0 445 010 278</b>
55567370	<b>0 986 437 024</b>
55567370	<b>0 986 437 201</b>

55571005	<b>0 445 010 371</b>
55571005	<b>0 986 437 047</b>
55572537	<b>0 445 010 293</b>
55572537	<b>0 986 437 036</b>
55574632	<b>0 445 010 382</b>

55574632	<b>0 986 437 027</b>
55575157	<b>0 445 010 381</b>
55575157	<b>0 986 437 072</b>
55577668	<b>0 445 110 423</b>
55577668	<b>0 986 435 237</b>

55594059	<b>0 444 021 038</b>
55597787	<b>0 445 010 441</b>
55597787	<b>0 986 437 047</b>
55597788	<b>0 445 010 443</b>
55597788	<b>0 986 437 027</b>

55597789	<b>0 445 010 445</b>
90349026	<b>0 432 217 196</b>
90349026	<b>0 986 430 448</b>
90369648	<b>0 460 406 994</b>
90399392	<b>0 280 202 212</b>

90442374	<b>0 986 430 243</b>
90444313	<b>0 460 404 074</b>
90444313	<b>0 986 440 002</b>
90444993	<b>0 986 440 143</b>
90487306	<b>0 986 280 113</b>

90509260	<b>0 986 430 241</b>
90510152	<b>0 986 280 140</b>
90510153	<b>0 280 217 003</b>
90510154	<b>0 280 217 106</b>
90510156	<b>0 280 217 503</b>

90510940	<b>0 986 440 150</b>
90540931	<b>0 281 002 139</b>
90541239	<b>0 986 440 150</b>
90541240	<b>0 986 440 152</b>
90541591	<b>0 280 217 519</b>

90541723	<b>0 986 430 302</b>
90541915	<b>0 432 217 299</b>
90541915	<b>0 986 430 449</b>
90542288	<b>0 986 444 002</b>
90543282	<b>0 280 217 123</b>

90543463	<b>0 281 002 180</b>
90543761	<b>0 432 193 686</b>
9109268	<b>0 445 010 075</b>
9109268	<b>0 986 437 301</b>
9109795	<b>0 445 110 141</b>

9109795	<b>0 986 435 086</b>
9109795	<b>0 986 435 239</b>
9110535	<b>0 445 110 063</b>
9110535	<b>0 986 435 075</b>
9112247	<b>0 445 110 087</b>

9112247	<b>0 986 435 079</b>
9112247	<b>0 986 435 235</b>
91 12 247	<b>0 986 435 274</b>
91153667	<b>0 460 404 991</b>
91153783	<b>0 281 002 144</b>

9117868	<b>0 432 193 687</b>
9119514	<b>0 432 193 650</b>
9192712	<b>0 432 193 633</b>
9192713	<b>0 432 193 634</b>
9192988	<b>0 470 504 003</b>

9192989	<b>0 470 504 004</b>
9193149	<b>0 280 218 031</b>
9193149	<b>0 986 280 230</b>
9193454	<b>0 470 504 011</b>
9193533	<b>0 281 002 184</b>

9195729	<b>0 281 002 428</b>
9196701	<b>0 432 193 569</b>
9198651	<b>0 432 193 634</b>
9199204	<b>0 470 504 016</b>
9200844	<b>0 432 193 570</b>

9201425	<b>0 280 218 051</b>
9201425	<b>0 986 280 231</b>
9201510	<b>0 470 504 015</b>
93161695	<b>0 445 115 007</b>
93161695	<b>0 986 435 350</b>

93168205	<b>0 445 010 234</b>
93168205	<b>0 986 437 086</b>
93168206	<b>0 445 010 205</b>
93168206	<b>0 445 010 351</b>
93168206	<b>0 986 437 041</b>

93168212	<b>0 445 110 375</b>
93168212	<b>0 986 435 205</b>
93168212	<b>0 986 435 234</b>
93171355	<b>0 281 002 428</b>
93171356	<b>0 281 002 180</b>

93171527	<b>0 281 002 478</b>
93171683	<b>0 445 010 009</b>
93171683	<b>0 986 437 004</b>
93171707	<b>0 986 435 095</b>
93171760	<b>0 281 002 184</b>

93171940	<b>0 432 193 525</b>
93172230	<b>0 470 504 209</b>
93172230	<b>0 986 444 028</b>
93172231	<b>0 470 504 210</b>
93172231	<b>0 986 444 029</b>

93173727	<b>0 281 002 479</b>
93174129	<b>0 281 002 579</b>
93174504	<b>0 470 504 217</b>
93174504	<b>0 986 444 030</b>
93174628	<b>0 281 002 564</b>

93175731	<b>0 470 504 218</b>
93175731	<b>0 986 444 036</b>
93176086	<b>0 281 002 605</b>
93177319	<b>0 445 010 277</b>
93177319	<b>0 986 437 024</b>

93177319	<b>0 986 437 201</b>
93177373	<b>0 445 110 083</b>
93177373	<b>0 986 435 078</b>
93177718	<b>0 281 002 549</b>
93178050	<b>0 281 002 620</b>

93178243	<b>0 281 002 683</b>
93178684	<b>0 445 110 165</b>
93179047	<b>0 445 110 159</b>
93179047	<b>0 986 435 088</b>
93179927	<b>0 280 218 119</b>

93180992	<b>0 280 218 142</b>
93181894	<b>0 280 218 211</b>
93182410	<b>0 445 010 097</b>
93182410	<b>0 986 437 025</b>
93183595	<b>0 445 110 021</b>

93183897	<b>0 280 218 142</b>
93183910	<b>0 445 110 083</b>
93183910	<b>0 445 110 183</b>
93183910	<b>0 986 435 078</b>
93184174	<b>0 986 437 036</b>

93184178	<b>0 986 435 102</b>
93184794	<b>0 445 110 159</b>
93184794	<b>0 986 435 088</b>
93185444	<b>0 281 002 773</b>
93185455	<b>0 280 218 136</b>

93186084	<b>0 986 280 241</b>
93186431	<b>0 986 437 036</b>
93187882	<b>0 445 010 278</b>
93187882	<b>0 986 437 024</b>
93187882	<b>0 986 437 201</b>

93188709	<b>0 445 010 097</b>
93188709	<b>0 986 437 025</b>
93188710	<b>0 986 437 026</b>
93188724	<b>0 281 002 832</b>
93188745	<b>0 986 437 301</b>

93189943	<b>0 445 010 140</b>
93189943	<b>0 986 437 033</b>
93189952	<b>0 445 110 265</b>
93189952	<b>0 986 435 170</b>
93189952	<b>0 986 435 236</b>

93189952	<b>0 986 435 275</b>
93190244	<b>0 445 010 156</b>
93190244	<b>0 445 010 288</b>
93190244	<b>0 986 437 025</b>
93190245	<b>0 445 010 155</b>

93190245	<b>0 445 010 287</b>
93190245	<b>0 986 437 026</b>
93190330	<b>0 445 110 102</b>
93190330	<b>0 986 435 106</b>
93190336	<b>0 445 110 087</b>

93190336	<b>0 986 435 235</b>
93190336	<b>0 986 435 274</b>
93190429	<b>0 445 110 276</b>
93190429	<b>0 986 435 148</b>
93190435	<b>0 445 110 183</b>



93190668	<b>0 445 010 293</b>
93190668	<b>0 986 437 036</b>
93193470	<b>0 281 002 862</b>
93195389	<b>0 445 110 325</b>
93195389	<b>0 986 435 199</b>

93195390	<b>0 445 110 326</b>
93195390	<b>0 986 435 200</b>
93196362	<b>0 445 010 170</b>
93196362	<b>0 986 437 044</b>
93197091	<b>0 445 010 170</b>

93197091	<b>0 986 437 044</b>
93198624	<b>0 445 010 223</b>
93198624	<b>0 986 437 044</b>
93198683	<b>0 445 110 338</b>
93198683	<b>0 986 435 202</b>

94459142	<b>0 986 433 004</b>
94459142	<b>9 430 610 136</b>
94460004	<b>0 986 433 005</b>
94460004	<b>9 430 610 137</b>
95507631	<b>0 445 010 196</b>

95507631	<b>0 986 437 039</b>
95510006	<b>0 281 002 980</b>
95510015	<b>0 281 002 917</b>
95513367	<b>0 281 002 792</b>
95516147	<b>0 445 010 250</b>

95516147	<b>0 986 437 045</b>
95517996	<b>0 445 010 404</b>
95517996	<b>0 986 437 070</b>
95517997	<b>0 445 010 406</b>
95517997	<b>0 986 437 071</b>

95518000	<b>0 445 110 414</b>
95518001	<b>0 445 110 569</b>
95518865	<b>0 986 435 234</b>
96440341	<b>0 445 010 142</b>
96440341	<b>0 986 437 032</b>

96440397	<b>0 445 110 269</b>
96859151	<b>0 445 010 332</b>
97040843	<b>9 460 620 007</b>
97043760	<b>0 986 433 002</b>
97043760	<b>9 430 610 128</b>

97043761	<b>9 430 610 129</b>
97078638	<b>9 460 620 008</b>
97078639	<b>9 460 620 009</b>
97085182	<b>9 460 620 010</b>
97088673	<b>0 986 433 001</b>

97092955	<b>9 460 620 011</b>
97121228	<b>9 460 620 011</b>
97121228	<b>9 460 620 017</b>
97121228	<b>9 460 620 021</b>
97122823	<b>9 460 620 013</b>

97139269	<b>9 460 620 021</b>
97139270	<b>9 460 620 021</b>
97161455	<b>9 430 610 163</b>
97300091	<b>0 445 110 118</b>
97300091	<b>0 986 435 082</b>

97327924	<b>0 445 010 086</b>
97327924	<b>0 986 437 317</b>
97363811	<b>0 986 435 105</b>
97363812	<b>0 986 435 089</b>

### VCE (VOLVO CONSTR. EQUIPM.)

20450666	<b>0 414 750 004</b>
20513343	<b>0 445 124 008</b>

20798114	<b>0 445 120 066</b>
20798683	<b>0 445 120 067</b>
21006084	<b>0 445 120 074</b>
21574975	<b>0 986 44D 224</b>
21576178	<b>0 986 44D 222</b>

22851845	<b>0 986 44D 224</b>
24425916	<b>0 432 193 486</b>
9021576178	<b>0 986 44D 222</b>
9022851845	<b>0 986 44D 224</b>

### VDO

A2C59513178	<b>0 281 002 757</b>
A2C59513178	<b>0 986 284 010</b>
A2C59513179	<b>0 281 002 180</b>

A2C59513181	<b>0 281 002 309</b>
A2C59513540	<b>0 281 002 216</b>
A2C59513542	<b>0 281 002 461</b>
A2C59513977	<b>0 281 002 428</b>
A2C59513978	<b>0 281 002 478</b>

A2C59513980	<b>0 281 002 184</b>
-------------	----------------------

### VEMO

V10-72-0958	<b>0 281 002 757</b>
V10-72-0958	<b>0 986 284 010</b>
V10-72-0959	<b>0 281 002 216</b>

V10-72-0970	<b>0 281 002 429</b>
V10-72-1025	<b>0 281 002 216</b>
V10-72-1025	<b>0 281 002 757</b>
V10-72-1025	<b>0 986 284 010</b>
V10-72-1038	<b>0 281 002 461</b>

V10-72-1065	<b>0 281 002 403</b>
V10-72-1102	<b>0 281 002 403</b>
V10-72-1102	<b>0 281 002 429</b>
V10-72-1205	<b>0 281 002 463</b>
V10-72-1256	<b>0 281 002 318</b>

V24-72-0003	<b>0 281 002 309</b>
V24-72-0108	<b>0 281 002 308</b>
V24-72-0112	<b>0 281 002 533</b>
V24-72-0114	<b>0 281 002 917</b>
V25-72-1060	<b>0 281 002 980</b>

V26-72-0025	<b>0 281 002 120</b>
V30-72-0009	<b>0 281 002 281</b>
V30-72-0010	<b>0 281 002 152</b>
V30-72-0011	<b>0 281 002 384</b>
V30-72-0012	<b>0 281 002 535</b>

V30-72-0013	<b>0 281 002 489</b>
V30-72-0014	<b>0 281 002 152</b>
V30-72-0014	<b>0 281 002 384</b>
V30-72-0016	<b>0 281 002 896</b>
V30-72-0030	<b>0 281 002 656</b>

V40-72-0339	<b>0 281 002 180</b>
V40-72-0385	<b>0 281 002 428</b>
V40-72-0401	<b>0 281 002 182</b>
V40-72-0401	<b>0 281 002 478</b>
V40-72-0401	<b>0 281 002 479</b>

V40-72-0417	<b>0 281 002 180</b>
V40-72-0417	<b>0 281 002 184</b>
V40-72-0417	<b>0 281 002 428</b>
V40-72-0417	<b>0 281 002 549</b>
V40-72-0417	<b>0 281 002 579</b>

V40-72-0449	<b>0 281 002 478</b>
V40-72-0453	<b>0 281 002 447</b>
V40-72-0456	<b>0 281 002 549</b>
V40-72-0458	<b>0 281 002 683</b>
V40-72-0460	<b>0 281 002 619</b>

V40-72-0461	<b>0 281 002 447</b>
V40-72-0462	<b>0 281 002 683</b>
V40-72-0475	<b>0 281 002 912</b>
V52-72-0036	<b>0 281 002 600</b>
V95-72-0031	<b>0 281 002 195</b>

V95-72-0048	<b>0 281 006 248</b>
10-72-0958	<b>0 986 280 202</b>
10-72-0959	<b>0 281 002 216</b>
10-72-0970	<b>0 281 002 429</b>
10-72-0974	<b>0 280 218 013</b>

10-72-1022	<b>0 986 280 201</b>
20-72-0005	<b>0 928 400 527</b>
24-72-0003	<b>0 281 002 309</b>
24-72-0004	<b>0 280 218 019</b>
30-72-0003	<b>0 280 217 517</b>

40-72-0339	<b>0 281 002 180</b>
40-72-0385	<b>0 281 002 428</b>
40-72-0386	<b>0 280 217 123</b>
40-72-0387	<b>0 280 217 106</b>

### VICTORY (POLARIS-INDUSTRIES)

20908937	<b>0 444 023 017</b>
----------	----------------------

### VM (MOTORI/STABILIMENTI MEC.)

C5 02 0182A	<b>0 460 414 262</b>
112 061	<b>0 460 404 991</b>

15 06 003B	<b>0 432 297 047</b>
15 06 2012F	<b>0 432 217 222</b>
15 06 2018F	<b>0 432 217 281</b>
15 06 2022F	<b>0 432 217 303</b>
15 06 2023F	<b>0 432 217 304</b>

15 06 2026F	<b>0 432 217 303</b>
15 06 2027F	<b>0 432 217 311</b>
15 06 2036F	<b>0 445 110 059</b>
15 06 2038F	<b>0 432 193 693</b>
15 06 2042F	<b>0 432 193 514</b>

15 06 2043F	<b>0 432 193 513</b>
15 06 2047F	<b>0 445 110 217</b>
15062047F	<b>0 986 435 128</b>
15 06 2047F	<b>0 986 435 263</b>
15 06 2048F	<b>0 445 110 218</b>

15 06 2049F	<b>0 445 110 221</b>
15062049F	<b>0 986 435 265</b>
15 06 2050F	<b>0 445 115 049</b>
15 06 2050GF	<b>0 445 115 049</b>
15 06 2053F	<b>0 445 110 287</b>

15 06 2053F	<b>0 986 435 277</b>
15 06 2054F	<b>0 445 110 301</b>
15 06 2054F	<b>0 986 435 278</b>
15 06 2055F	<b>0 445 110 286</b>
15 06 2055F	<b>0 986 435 266</b>

15 06 2057F	<b>0 445 110 269</b>
15 06 2058F	<b>0 445 115 067</b>
15 06 2058F	<b>0 986 435 402</b>
15 06 2059F	<b>0 445 117 018</b>
15 06 2059F	<b>0 986 435 427</b>

35 02 2047F	<b>0 460 404 991</b>
35 02 2087F	<b>0 445 010 034</b>
35 02 2087G	<b>0 445 010 034</b>
35 02 2089F	<b>0 460 414 220</b>
35 02 2089 G	<b>0 460 414 284</b>

35 02 2091F	<b>0 460 416 094</b>
35 02 2092F	<b>0 460 424 254</b>
35 02 2092G	<b>0 460 424 254</b>
35 02 2093F	<b>0 460 426 994</b>
35 02 2098F	<b>0 445 010 104</b>

35 02 2101F	<b>0 460 424 998</b>
35 02 2102F	<b>0 460 426 390</b>
35 02 2103F	<b>0 445 010 084</b>
35 02 2104G	<b>0 445 010 152</b>
35 02 2114F	<b>0 445 010 152</b>

35 02 2115F	<b>0 460 414 262</b>
35 02 2115H	<b>0 460 414 262</b>
35 02 2115H	<b>0 460 414 283</b>
35 02 2123F	<b>0 445 010 259</b>
35 02 2129F	<b>0 445 010 238</b>

35 02 2131F	<b>0 445 010 689</b>
35 02 2140F	<b>0 445 010 684</b>
35 02 2140F	<b>0 986 437 468</b>
35 02 2143F	<b>0 445 010 684</b>
35 02 2143F	<b>0 445 010 696</b>

## ◀ VM

35 02 2143F	<b>0 986 437 468</b>
35022146F	<b>0 445 010 430</b>
35 06 2001F	<b>0 445 110 354</b>
35 06 2002F	<b>0 445 110 400</b>
35 06 2002F	<b>0 986 435 209</b>

35 06 2003F	<b>0 445 117 018</b>
35 06 2003F	<b>0 986 435 427</b>
35 06 2005F	<b>0 445 116 041</b>
35 06 2005F	<b>0 986 435 437</b>
35 06 2008F	<b>0 445 110 430</b>

35 06 2008F	<b>0 986 435 214</b>
35 06 2015F	<b>0 445 110 523</b>
35 06 2015F	<b>0 986 435 262</b>
35 06 2016F	<b>0 445 110 522</b>
35 06 2016F	<b>0 986 435 251</b>

35 062 018F	<b>0 445 110 621</b>
35062022F	<b>0 445 110 747</b>
43 00 2038F	<b>0 281 002 918</b>
43 00 2043F	<b>0 281 002 912</b>
44 50 10034	<b>0 445 010 034</b>

50 60 1330	<b>0 445 110 286</b>
50 60 1330	<b>0 986 435 266</b>

**VOLVO**

11032785	<b>0 986 430 491</b>
11043052	<b>0 986 430 492</b>
111030859	<b>0 986 430 498</b>

1271861	<b>0 986 280 114</b>
1275497	<b>0 986 440 564</b>
1326065	<b>0 986 280 106</b>
1328208	<b>0 986 430 080</b>
1336354	<b>0 986 280 115</b>

13363540	<b>0 986 280 115</b>
1336534	<b>0 986 280 115</b>
1346645	<b>0 986 280 102</b>
1543753	<b>0 986 430 169</b>
1544090	<b>0 986 430 002</b>

1545102	<b>0 986 430 000</b>
1556446	<b>0 986 430 301</b>
1660 0M A70A	<b>0 986 435 290</b>
1677158	<b>0 986 441 004</b>
20440409	<b>0 986 441 106</b>

20440412	<b>0 986 441 111</b>
20440415	<b>0 986 441 110</b>
20440675	<b>0 986 444 082</b>
20798114	<b>0 986 435 548</b>
20798683	<b>0 986 435 549</b>

20975638	<b>0 986 44D 103</b>
20975638	<b>0 986 44D 119</b>
21006085	<b>0 986 435 529</b>
21161861	<b>0 986 44D 103</b>
21161861	<b>0 986 44D 119</b>

21200982	<b>0 986 44D 113</b>
21200982	<b>0 986 44D 127</b>
21210636	<b>0 986 44D 113</b>
21210636	<b>0 986 44D 127</b>
21350672	<b>0 986 44D 115</b>

21577507	<b>0 986 44D 124</b>
21577507	<b>0 986 44D 200</b>
21587332	<b>0 986 435 542</b>
21966582	<b>0 986 44D 110</b>
21966582	<b>0 986 44D 115</b>

22057001	<b>0 986 44D 115</b>
22169009	<b>0 986 44D 115</b>
22169014	<b>0 986 44D 110</b>
22391563	<b>0 986 44D 280</b>
22668886	<b>0 986 44D 115</b>

22668890	<b>0 986 44D 110</b>
23126517	<b>0 986 435 677</b>
240339	<b>0 986 430 064</b>
30637375	<b>0 986 435 125</b>
30731567	<b>0 986 435 125</b>

30750282	<b>0 986 435 125</b>
30750283	<b>0 986 435 125</b>
30756063	<b>0 986 435 120</b>
30756094	<b>0 986 435 126</b>
30756125	<b>0 986 437 325</b>

30757314	<b>0 986 435 090</b>
30777226	<b>0 986 435 393</b>
30777314	<b>0 986 435 120</b>
30777346	<b>0 986 437 423</b>
30777526	<b>0 986 435 195</b>

31216724	<b>0 986 437 423</b>
31259247	<b>0 986 437 028</b>
31272690	<b>0 986 435 393</b>
31272767	<b>0 986 435 408</b>
31272896	<b>0 986 437 423</b>

31303238	<b>0 986 435 424</b>
31303259	<b>0 986 435 120</b>
31303409	<b>0 986 435 424</b>
31303475	<b>0 986 437 325</b>
31372081	<b>0 986 437 423</b>

3155044	<b>0 986 441 106</b>
3165869	<b>0 986 441 005</b>
3165869	<b>0 986 441 905</b>
3165874	<b>0 986 441 005</b>
3183295	<b>0 986 441 110</b>

3183496	<b>0 986 441 111</b>
3411906	<b>0 986 280 102</b>
3454442	<b>0 986 280 107</b>
3501987	<b>0 986 280 138</b>
3517020	<b>0 986 280 101</b>

35170200	<b>0 986 280 101</b>
3517569	<b>0 986 280 110</b>
3517763	<b>0 986 280 132</b>
3547266	<b>0 986 280 107</b>
36000262	<b>0 986 437 322</b>

36000265	<b>0 986 437 028</b>
36000269	<b>0 986 437 028</b>
36000573	<b>0 986 437 325</b>
36001127	<b>0 986 437 325</b>
36002064	<b>0 986 437 423</b>

36002235	<b>0 986 437 028</b>
36002503	<b>0 986 437 423</b>
36002662	<b>0 986 435 393</b>
36051165	<b>0 986 435 120</b>
3827636	<b>0 986 441 109</b>

3964829	<b>0 986 441 005</b>
3964829	<b>0 986 441 905</b>
420805	<b>0 986 430 311</b>
422950	<b>0 986 430 165</b>
422954	<b>0 986 430 166</b>

424530	<b>0 986 430 164</b>
425287	<b>0 986 430 359</b>
425369	<b>0 986 430 366</b>
425618	<b>0 986 430 367</b>
425693	<b>0 986 430 370</b>

465872	<b>0 986 430 162</b>
466513	<b>0 986 430 033</b>
468748	<b>0 986 430 032</b>
470933	<b>0 986 430 167</b>
471611	<b>0 986 430 163</b>

477504	<b>0 986 430 363</b>
477816	<b>0 986 430 364</b>
477953	<b>0 986 430 368</b>
478605	<b>0 986 430 353</b>
478606	<b>0 986 430 354</b>

478682	<b>0 986 430 250</b>
479443	<b>0 986 430 263</b>
4881621	<b>0 986 430 494</b>
5001837	<b>0 986 430 033</b>
5003019	<b>0 986 430 032</b>

5003020	<b>0 986 430 001</b>
5003026	<b>0 986 430 000</b>
5003034	<b>0 986 430 002</b>
5003099	<b>0 986 430 162</b>
5003150	<b>0 986 430 163</b>

5003151	<b>0 986 430 164</b>
5003291	<b>0 986 430 167</b>
5003305	<b>0 986 430 064</b>
5003317	<b>0 986 430 169</b>
5003392	<b>0 986 430 165</b>

5003400	<b>0 986 430 166</b>
5003722	<b>0 986 430 089</b>
5003723	<b>0 986 430 081</b>
5003724	<b>0 986 430 080</b>
5236686	<b>0 986 441 005</b>

6050251	<b>0 986 441 106</b>
8111112	<b>0 986 440 564</b>
8112268	<b>0 986 430 363</b>
8112303	<b>0 986 430 263</b>
8112314	<b>0 986 430 311</b>

8112746	<b>0 986 430 364</b>
8112787	<b>0 986 430 366</b>
8112809	<b>0 986 430 367</b>
8112813	<b>0 986 430 368</b>
8112818	<b>0 986 441 004</b>

8112898	<b>0 986 430 369</b>
8113010	<b>0 986 430 370</b>
8113226	<b>0 986 430 591</b>
8113286	<b>0 986 441 005</b>
8113286	<b>0 986 441 905</b>

8113408	<b>0 986 441 106</b>
8113845	<b>0 986 441 110</b>
8113891	<b>0 986 430 592</b>
8113893	<b>0 986 430 593</b>
8113895	<b>0 986 441 111</b>

8165874	<b>0 986 441 905</b>
8170569	<b>0 986 441 106</b>
819230	<b>0 986 444 082</b>
8194094	<b>0 986 430 369</b>
8251496	<b>0 986 280 102</b>

8251497	<b>0 986 280 101</b>
82514970	<b>0 986 280 101</b>
8251498	<b>0 986 280 110</b>
8251499	<b>0 986 280 114</b>
8251500	<b>0 986 280 115</b>

8251501	<b>0 986 280 107</b>
8251502	<b>0 986 280 138</b>
8251504	<b>0 986 280 106</b>
8251785	<b>0 986 437 312</b>
8251786	<b>0 986 437 301</b>

85003865	<b>0 986 44D 200</b>
85013130	<b>0 986 44D 115</b>
85013465	<b>0 986 44D 115</b>
85013737	<b>0 986 44D 115</b>
85020841	<b>0 986 44D 115</b>

85020843	<b>0 986 44D 110</b>
8602669	<b>0 986 435 120</b>
8602791	<b>0 986 280 102</b>
8602792	<b>0 986 280 101</b>
8602793	<b>0 986 280 110</b>

8602794	<b>0 986 280 114</b>
8602795	<b>0 986 280 115</b>
8602796	<b>0 986 280 107</b>
8602797	<b>0 986 280 138</b>
8602803	<b>0 986 280 106</b>

8603490	<b>0 986 435 090</b>
8603491	<b>0 986 437 322</b>
8603497	<b>0 986 437 325</b>
8603893	<b>0 986 437 312</b>
8627319	<b>0 986 435 120</b>

863050	<b>0 986 437 312</b>
8642781	<b>0 986 437 312</b>
8658350	<b>0 986 435 120</b>
8658351	<b>0 986 435 120</b>
8658352	<b>0 986 435 120</b>

8658353	<b>0 986 435 120</b>
8692521	<b>0 986 437 325</b>

**VOLVO BM**

11030783	<b>0 432 191 671</b>
11030859	<b>0 432 191 658</b>
11032785	<b>0 432 191 529</b>

11032785	<b>0 986 430 491</b>
11043052	<b>0 432 191 778</b>
11043052	<b>0 986 430 492</b>
11162407	<b>0 432 191 386</b>
1556446	<b>0 432 291 534</b>

1556446	<b>0 986 430 301</b>
422950	<b>0 432 191 770</b>
422950	<b>0 986 430 165</b>
468748	<b>0 432 191 863</b>
468748	<b>0 986 430 032</b>

470115	<b>0 432 191 852</b>
470933	<b>0 432 191 788</b>
470933	<b>0 986 430 167</b>
477504	<b>0 986 430 363</b>
478605	<b>0 432 191 737</b>

478605	<b>0 986 430 353</b>
478606	<b>0 432 191 715</b>
478606	<b>0 986 430 354</b>
479443	<b>0 432 191 730</b>
479443	<b>0 986 430 263</b>

4880892	<b>0 432 191 841</b>
4881621	<b>0 432 191 801</b>
4881621	<b>0 986 430 494</b>
848729	<b>0 432 191 807</b>

**VOLVO PENTA**

1543753	<b>0 432 291 635</b>
1543753	<b>0 986 430 169</b>
1545102	<b>0 432 191 848</b>

1545102	<b>0 986 430 000</b>
21160093	<b>0 414 702 025</b>
21188520	<b>0 445 120 173</b>
21188520	<b>0 986 435 557</b>
21188520	<b>0 986 435 677</b>

23324678	<b>0 445 120 552</b>
23324678	<b>0 986 435 677</b>
23324681	<b>0 445 120 550</b>
23324681	<b>0 445 120 551</b>
23324683	<b>0 445 120 548</b>

3581435	<b>0 432 193 690</b>
3801148	<b>0 445 120 108</b>
3803634	<b>0 445 120 033</b>
3803908	<b>0 445 120 051</b>
3817389	<b>0 445 020 057</b>

3825248	<b>0 432 191 614</b>
3825737	<b>0 432 191 600</b>
3825987	<b>0 432 291 513</b>
3826132	<b>0 432 191 581</b>
3826194	<b>0 432 191 567</b>

3826552	<b>0 432 191 552</b>
3829644	<b>0 414 702 023</b>
3887696	<b>0 445 120 108</b>
420805	<b>0 432 191 724</b>
420805	<b>0 986 430 311</b>

424530	<b>0 432 191 815</b>
424530	<b>0 986 430 164</b>
465872	<b>0 432 191 822</b>
465872	<b>0 986 430 162</b>
468748	<b>0 432 191 863</b>

468748	<b>0 986 430 032</b>
470933	<b>0 432 191 788</b>
470933	<b>0 986 430 167</b>
478605	<b>0 432 191 737</b>
478605	<b>0 986 430 353</b>

478606	<b>0 432 191 715</b>
479443	<b>0 432 191 730</b>
479443	<b>0 986 430 263</b>
838665	<b>0 432 191 809</b>
840595	<b>0 432 191 839</b>

847559	<b>0 432 191 834</b>
848069	<b>0 432 191 753</b>
848228	<b>0 432 191 808</b>
848729	<b>0 432 191 807</b>
848730	<b>0 432 191 806</b>

848799	<b>0 432 191 805</b>
858073	<b>0 432 191 810</b>
858299	<b>0 432 191 793</b>
859494	<b>0 432 191 765</b>
860270	<b>0 460 416 065</b>

860383	<b>0 432 193 861</b>
860556	<b>0 432 193 855</b>
860792	<b>0 432 193 849</b>
861102	<b>0 460 426 218</b>
861103	<b>0 432 191 684</b>

861262	<b>0 460 426 219</b>
861725	<b>0 432 193 689</b>
864069	<b>0 432 191 753</b>
865562	<b>0 432 191 685</b>
865568	<b>0 432 291 531</b>

865853	<b>0 432 191 677</b>
866143	<b>0 432 191 670</b>
866545	<b>0 432 291 517</b>
866882	<b>0 432 191 645</b>

**VOLVO TRUCK**

20440475	<b>0 432 191 361</b>
21234247	<b>0 444 023 053</b>
21332695	<b>0 444 042 009</b>

21332701-P02	<b>0 444 042 009</b>
21332711-P02	<b>0 444 043 004</b>
21335892	<b>0 444 042 012</b>
21335897	<b>0 986 44D 211</b>
21350672	<b>0 986 44D 110</b>

21350672	<b>0 986 44D 115</b>
21399653	<b>0 444 023 053</b>
21574975	<b>0 986 44D 224</b>
21576178	<b>0 986 44D 211</b>
21576178	<b>0 986 44D 222</b>

21582902	<b>0 986 44D 110</b>
21687107	<b>0 444 022 042</b>
21687107	<b>0 986 44D 110</b>
21738132	<b>0 444 023 053</b>
21773130	<b>0 445 120 246</b>

21911392	<b>0 444 022 047</b>
21911392	<b>0 986 44D 110</b>
21911392	<b>0 986 44D 115</b>
22851845	<b>0 444 042 155</b>
22851845	<b>0 986 44D 224</b>

3583073	<b>0 432 193 527</b>
3803297	<b>0 432 291 517</b>
3978828	<b>0 432 191 402</b>
3978866	<b>0 432 193 537</b>
3978867	<b>0 432 193 536</b>

8112269	<b>0 986 430 353</b>
85013280	<b>0 986 44D 115</b>
85013590	<b>0 986 44D 222</b>
85021151	<b>0 986 44D 224</b>

**VW (VOLKSWAGEN)**

TAE 130 201	<b>9 430 082 746</b>
TAF 130 201	<b>9 430 082 745</b>
TE3 130 201	<b>9 430 082 715</b>

TL7 130 201	<b>9 430 082 296</b>
T 121 302 01	<b>9 430 082 289</b>
T 121 302 05	<b>9 430 082 276</b>
T 121 302 05	<b>9 430 082 289</b>
X039 526 33	<b>0 280 200 045</b>

X039 610 06	<b>0 280 200 050</b>
X039 728 30	<b>0 280 200 052</b>
X039 762 45	<b>0 280 200 053</b>
000 VT5 077	<b>0 281 002 461</b>
000 395 263 3	<b>0 280 200 045</b>

000 397 283 0	<b>0 280 200 052</b>
021 906 461	<b>0 986 280 122</b>
021 906 462	<b>0 280 217 504</b>
021 906 462 A	<b>0 280 217 512</b>
021 906 462 A	<b>0 986 280 203</b>

021 906 462 AX	<b>0 986 280 203</b>
022 906 301	<b>0 280 200 001</b>
022 906 301 A	<b>0 280 200 012</b>
025 906 301	<b>0 280 200 039</b>
027 130 277 BB	<b>0 445 118 006</b>

028 130 081	<b>0 986 440 250</b>
028 130 081 A	<b>0 986 440 251</b>
028 130 081 K	<b>0 460 484 139</b>
028 130 081 P	<b>0 986 440 553</b>
028 130 081 PX	<b>0 986 440 553</b>

028 130 082	<b>0 986 440 551</b>
028 130 082 A	<b>0 986 440 552</b>
028 130 082 AX	<b>0 986 440 552</b>
028 130 082 D	<b>0 460 484 139</b>
028 130 082 H	<b>0 986 440 570</b>

028 130 082 HX	<b>0 986 440 570</b>
028 130 107	<b>0 986 440 084</b>
028 130 107 A	<b>0 986 440 237</b>
028 130 107 AX	<b>0 986 440 237</b>
028 130 107 D	<b>0 986 440 557</b>

028 130 107 DX	<b>0 986 440 557</b>
028 130 107 J	<b>0 986 440 142</b>
028 130 107 JX	<b>0 986 440 142</b>
028 130 107 M	<b>0 460 484 139</b>
028 130 107 Q	<b>0 460 484 046</b>

028 130 107 Q	<b>0 986 440 239</b>
028 130 107 QX	<b>0 986 440 239</b>
028 130 107 R	<b>0 986 440 247</b>
028 130 107 RX	<b>0 986 440 247</b>
028 130 107 X	<b>0 986 440 084</b>

028 130 108	<b>0 986 440 248</b>
028 130 108 G	<b>0 986 440 249</b>
028 130 108 GX	<b>0 986 440 249</b>
028 130 108 K	<b>0 986 440 240</b>
028 130 108 L	<b>0 986 440 551</b>

028 130 108 M	<b>0 986 440 560</b>
028 130 108 MX	<b>0 986 440 560</b>
028 130 108 Q	<b>0 986 440 240</b>
028 130 108 S	<b>0 460 494 335</b>
028 130 108 X	<b>0 986 440 248</b>

028 130 109 H	<b>0 460 404 971</b>
028 130 109 J	<b>0 986 440 559</b>
028 130 109 JX	<b>0 986 440 559</b>
028 130 109 L	<b>0 986 440 558</b>
028 130 109 LX	<b>0 986 440 558</b>

028 130 109 N	<b>0 986 440 255</b>
028 130 109 Q	<b>0 986 440 568</b>
028 130 110 B	<b>0 986 440 255</b>
028 130 110 BS	<b>0 986 440 240</b>
028 130 110 BX	<b>0 986 440 255</b>

028 130 110 G	<b>0 986 440 241</b>
028 130 110 H	<b>0 460 404 971</b>
028 130 110 H	<b>0 986 440 555</b>
028 130 110 HX	<b>0 986 440 555</b>
028 130 110 K	<b>0 986 440 551</b>

028 130 110 KX	<b>0 986 440 551</b>
028 130 110 M	<b>0 986 440 558</b>
028 130 110 MX	<b>0 986 440 558</b>
028 130 110 N	<b>0 986 440 568</b>
028 130 110 NX	<b>0 986 440 568</b>



## ◀ VW

028 130 110 P	<b>0 460 404 969</b>
028 130 110 P	<b>0 986 440 554</b>
028 130 110 PX	<b>0 986 440 554</b>
028 130 110 Q	<b>0 986 440 237</b>
028 130 110 QX	<b>0 986 440 237</b>

028 130 110 R	<b>0 986 440 257</b>
028 130 110 S	<b>0 986 440 240</b>
028 130 115 A	<b>0 460 404 969</b>
028 130 115 A	<b>0 986 440 554</b>
028 130 115 AX	<b>0 986 440 554</b>

028 130 115 B	<b>0 986 440 567</b>
028 130 115 BX	<b>0 986 440 567</b>
028 130 115 E	<b>0 986 440 552</b>
028 130 115 EX	<b>0 986 440 552</b>
028 130 115 G	<b>0 986 440 568</b>

028 130 115 GX	<b>0 986 440 568</b>
028 130 115 L	<b>0 986 440 257</b>
028 130 115 M	<b>0 460 404 971</b>
028 130 115 M	<b>0 986 440 555</b>
028 130 115 MX	<b>0 986 440 555</b>

028 130 115 N	<b>0 986 440 558</b>
028 130 115 NX	<b>0 986 440 558</b>
028 130 115 P	<b>0 986 440 240</b>
028 130 115 Q	<b>0 986 440 241</b>
028 130 115 QX	<b>0 460 484 128</b>

028 130 115 S	<b>0 986 440 250</b>
028 130 115 T	<b>0 986 440 251</b>
028 130 116 A	<b>0 986 440 240</b>
028 130 116 B	<b>0 460 484 161</b>
028 130 201	<b>0 986 430 253</b>

028 130 201 B	<b>0 432 217 284</b>
028 130 201 B	<b>0 986 430 206</b>
028 130 201 BX	<b>0 986 430 206</b>
028 130 201 G	<b>0 432 193 838</b>
028 130 201 H	<b>0 432 193 837</b>

028 130 201 J	<b>0 432 193 829</b>
028 130 201 JX	<b>0 432 193 829</b>
028 130 201 L	<b>0 432 217 272</b>
028 130 201 L	<b>0 986 430 187</b>
028 130 201 LX	<b>0 986 430 187</b>

028 130 201 R	<b>0 432 193 795</b>
028 130 201 R	<b>0 986 430 284</b>
028 130 201 T	<b>0 432 193 746</b>
028 130 201 X	<b>0 986 430 253</b>
028 130 202 H	<b>0 432 193 704</b>

028 130 202 H	<b>0 986 430 426</b>
028 130 202 J	<b>0 432 193 702</b>
028 130 202 M	<b>0 432 193 709</b>
028 130 202 N	<b>0 432 193 707</b>
028 130 202 P	<b>0 432 193 695</b>

028 130 202 Q	<b>0 432 193 693</b>
028 130 202 Q	<b>0 986 430 419</b>
028 130 202 R	<b>0 432 193 682</b>
028 130 202 S	<b>0 432 193 680</b>
028 130 203 C	<b>0 432 193 604</b>

028 130 203 D	<b>0 432 193 602</b>
028 130 203 E	<b>0 432 193 597</b>
028 130 203 F	<b>0 432 193 599</b>
028 906 301	<b>0 281 002 072</b>
028 906 461	<b>0 281 002 216</b>

028 906 461	<b>0 986 284 001</b>
028 906 461 X	<b>0 986 284 001</b>
03G 130 073	<b>0 414 720 401</b>
03G 130 073	<b>0 986 441 580</b>
03G 130 073 B	<b>0 414 720 402</b>

03G 130 073 B	<b>0 414 720 453</b>
03G 130 073 B	<b>0 986 441 580</b>
03G 130 073 BX	<b>0 986 441 580</b>
03G 130 073 G	<b>0 414 720 454</b>
03G 130 073 G	<b>0 986 441 566</b>

03G 130 073 GX	<b>0 414 720 454</b>
03G 130 073 GX	<b>0 986 441 566</b>
03G 906 461 C	<b>0 281 002 735</b>
03H 906 461	<b>0 280 218 175</b>
03H 906 461 A	<b>0 280 218 260</b>

03L 130 277	<b>0 445 116 029</b>
03L 130 277	<b>0 986 435 360</b>
03L 130 277 A	<b>0 445 116 010</b>
03L 130 277 A	<b>0 986 435 367</b>
03L 130 277 C	<b>0 445 116 034</b>

03L 130 277 J	<b>0 445 110 368</b>
03L 130 277 J	<b>0 986 435 166</b>
03L 130 277 N	<b>0 445 110 437</b>
03L 130 277 N	<b>0 986 435 190</b>
03L 130 277 P	<b>0 445 110 550</b>

03L 130 277 P	<b>0 986 435 276</b>
03L 130 277 Q	<b>0 445 110 646</b>
03L 130 277 Q	<b>0 986 435 166</b>
03L 130 277 R	<b>0 445 110 437</b>
03L 130 755	<b>0 445 010 546</b>

03L 130 755	<b>0 986 437 410</b>
03L 130 755 A	<b>0 445 010 543</b>
03L 130 755 A	<b>0 986 437 410</b>
03L 130 755 AA	<b>0 445 010 565</b>
03L 130 755 AA	<b>0 986 437 405</b>

03L 130 755 AB	<b>0 445 010 566</b>
03L 130 755 AB	<b>0 986 437 405</b>
03L 130 755 AB	<b>0 986 437 420</b>
03L 130 755 AC	<b>0 445 010 562</b>
03L 130 755 AC	<b>0 986 437 434</b>

03L 130 755 AE	<b>0 445 010 568</b>
03L 130 755 AE	<b>0 986 437 434</b>
03L 130 755 AF	<b>0 445 010 567</b>
03L 130 755 AF	<b>0 986 437 438</b>
03L 130 755 D	<b>0 445 010 551</b>

03L 130 755 D	<b>0 986 437 405</b>
03L 130 755 F	<b>0 986 437 405</b>
03L 130 755 F	<b>0 986 437 420</b>
03L 130 755 J	<b>0 445 010 555</b>
03L 130 755 J	<b>0 986 437 433</b>

03L 130 755 L	<b>0 445 010 560</b>
03L 130 755 L	<b>0 986 437 405</b>
03L 130 755 M	<b>0 986 437 405</b>
03L 130 755 R	<b>0 445 010 541</b>
03L 130 755 R	<b>0 986 437 433</b>

03L 130 851 AX	<b>0 986 437 410</b>
03L 130 851 BX	<b>0 986 437 405</b>
03L 130 851 CX	<b>0 986 437 405</b>
03L 130 851 CX	<b>0 986 437 420</b>
03L 130 851 HX	<b>0 986 437 405</b>

03L 130 851 X	<b>0 986 437 410</b>
03L 130 855 AX	<b>0 986 435 367</b>
03L 130 855 X	<b>0 986 435 360</b>
03L 906 461 A	<b>0 281 002 956</b>
03N 130 277	<b>0 445 118 002</b>

03N 130 755 A	<b>0 445 010 811</b>
03P 906 461	<b>0 281 006 132</b>
031 130 107 B	<b>0 986 440 238</b>
031 130 107 BX	<b>0 986 440 238</b>
034 133 471 D	<b>0 986 280 137</b>

034 133 471 K	<b>0 986 280 137</b>
034 133 471 N	<b>0 986 280 139</b>
036 906 461 A	<b>0 986 280 214</b>
036 906 461 AX	<b>0 986 280 214</b>
037 906 301	<b>0 280 202 106</b>

037 906 461	<b>0 280 217 103</b>
037 906 461 A	<b>0 280 217 103</b>
037 906 461 C	<b>0 280 217 117</b>
037 906 461 C	<b>0 986 280 201</b>
037 906 461 CX	<b>0 986 280 201</b>

038 130 073	<b>0 414 720 002</b>
038 130 073	<b>0 414 720 003</b>
038 130 073 A	<b>0 414 720 008</b>
038 130 073 AA	<b>0 414 720 028</b>
038 130 073 AA	<b>0 986 441 557</b>

038 130 073 AB	<b>0 414 720 021</b>
038 130 073 AB	<b>0 986 441 557</b>
038 130 073 AC	<b>0 414 720 029</b>
038 130 073 AC	<b>0 986 441 554</b>
038 130 073 AD	<b>0 414 720 023</b>

038 130 073 AD	<b>0 986 441 554</b>
038 130 073 AE	<b>0 414 720 218</b>
038 130 073 AG	<b>0 414 720 265</b>
038 130 073 AG	<b>0 986 441 559</b>
038 130 073 AH	<b>0 414 720 086</b>

038 130 073 AH	<b>0 986 441 553</b>
038 130 073 AJ	<b>0 414 720 087</b>
038 130 073 AJ	<b>0 986 441 556</b>
038 130 073 AK	<b>0 414 720 088</b>
038 130 073 AK	<b>0 986 441 554</b>

038 130 073 AL	<b>0 414 720 089</b>
038 130 073 AL	<b>0 986 441 557</b>
038 130 073 AM	<b>0 414 720 208</b>
038 130 073 AM	<b>0 986 441 559</b>
038 130 073 AN	<b>0 414 720 209</b>

038 130 073 AN	<b>0 986 441 560</b>
038 130 073 AP	<b>0 414 720 271</b>
038 130 073 AP	<b>0 986 441 562</b>
038 130 073 AQ	<b>0 414 720 213</b>
038 130 073 AQ	<b>0 986 441 559</b>

038 130 073 AR	<b>0 414 720 214</b>
038 130 073 AR	<b>0 986 441 560</b>
038 130 073 AS	<b>0 414 720 224</b>
038 130 073 AS	<b>0 986 441 564</b>
038 130 073 BA	<b>0 414 720 116</b>

038 130 073 BA	<b>0 414 720 266</b>
038 130 073 BA	<b>0 986 441 560</b>
038 130 073 BB	<b>0 414 720 277</b>
038 130 073 BB	<b>0 986 441 572</b>
038 130 073 BC	<b>0 414 720 272</b>

038 130 073 BC	<b>0 986 441 569</b>
038 130 073 BD	<b>0 414 720 276</b>
038 130 073 BD	<b>0 986 441 571</b>
038 130 073 BE	<b>0 986 441 560</b>
038 130 073 BF	<b>0 414 720 273</b>

038 130 073 BF	<b>0 986 441 570</b>
038 130 073 BH	<b>0 414 720 280</b>
038 130 073 BH	<b>0 986 441 575</b>
038 130 073 BJ	<b>0 414 720 279</b>
038 130 073 BJ	<b>0 986 441 574</b>

038 130 073 BK	<b>0 414 720 306</b>
038 130 073 BK	<b>0 986 441 567</b>
038 130 073 BL	<b>0 414 720 307</b>
038 130 073 BL	<b>0 986 441 568</b>
038 130 073 BM	<b>0 414 720 304</b>

038 130 073 BM	<b>0 414 720 308</b>
038 130 073 BM	<b>0 986 441 577</b>
038 130 073 BN	<b>0 414 720 363</b>
038 130 073 BN	<b>0 986 441 568</b>
038 130 073 BP	<b>0 414 720 364</b>

038 130 073 BP	<b>0 986 441 577</b>
038 130 073 BQ	<b>0 414 720 362</b>
038 130 073 BQ	<b>0 986 441 567</b>
038 130 073 BR	<b>0 414 720 282</b>
038 130 073 BR	<b>0 986 441 564</b>

038 130 073 D	<b>0 414 720 005</b>
038 130 073 F	<b>0 414 720 007</b>
038 130 073 F	<b>0 986 441 551</b>
038 130 073 G	<b>0 414 720 013</b>
038 130 073 G	<b>0 986 441 557</b>

038 130 073 H	<b>0 414 720 014</b>
038 130 073 H	<b>0 986 441 553</b>
038 130 073 J	<b>0 414 720 015</b>
038 130 073 J	<b>0 986 441 556</b>
038 130 073 K	<b>0 414 720 017</b>

038 130 073 L	<b>0 414 720 022</b>
038 130 073 L	<b>0 986 441 551</b>
038 130 073 N	<b>0 414 720 024</b>
038 130 073 N	<b>0 986 441 553</b>
038 130 073 P	<b>0 414 720 025</b>

038 130 073 P	<b>0 986 441 556</b>	038 130 201 T	<b>0 432 193 577</b>	045 130 073 AB	<b>0 986 441 552</b>	057 130 151 X	<b>0 986 437 344</b>
038 130 073 Q	<b>0 414 720 019</b>	038 130 202	<b>0 432 193 575</b>	045 130 073 B	<b>0 414 720 006</b>	057 130 276 H	<b>0 445 110 113</b>
038 130 073 Q	<b>0 414 720 201</b>	038 130 202 A	<b>0 432 193 594</b>	045 130 073 B	<b>0 414 720 010</b>	057 130 277 AD	<b>0 445 115 040</b>
038 130 073 Q	<b>0 414 720 204</b>	038 130 202 B	<b>0 432 193 592</b>	045 130 073 C	<b>0 414 720 011</b>	057 130 277 AG	<b>0 445 115 057</b>
038 130 073 Q	<b>0 986 441 560</b>	038 130 202 C	<b>0 432 193 573</b>	045 130 073 D	<b>0 414 720 012</b>	057 130 277 AG	<b>0 986 435 364</b>
038 130 073 R	<b>0 414 720 018</b>	038 130 202 E	<b>0 432 193 542</b>	045 130 073 F	<b>0 414 720 009</b>	057 130 277 AH	<b>0 445 117 002</b>
038 130 073 R	<b>0 986 441 554</b>	038 130 202 K	<b>0 432 193 544</b>	045 130 073 F	<b>0 986 441 552</b>	057 130 277 AH	<b>0 986 435 380</b>
038 130 073 S	<b>0 414 720 206</b>	038 906 461	<b>0 281 002 463</b>	045 130 073 J	<b>0 414 720 016</b>	057 130 277 AJ	<b>0 445 117 006</b>
038 130 073 S	<b>0 986 441 559</b>	038 906 461	<b>0 986 284 008</b>	045 130 073 J	<b>0 986 441 555</b>	057 130 277 AK	<b>0 445 115 085</b>
038 130 079 AX	<b>0 986 441 554</b>	038 906 461 B	<b>0 986 284 009</b>	045 130 073 L	<b>0 414 720 205</b>	057 130 277 AK	<b>0 986 435 374</b>
038 130 079 B	<b>0 986 441 557</b>	038 906 461 BX	<b>0 986 284 009</b>	045 130 073 P	<b>0 414 720 030</b>	057 130 277 AL	<b>0 445 117 013</b>
038 130 079 BX	<b>0 986 441 557</b>	038 906 461 C	<b>0 280 217 121</b>	045 130 073 P	<b>0 986 441 555</b>	057 130 277 AL	<b>0 986 435 386</b>
038 130 079 C	<b>0 986 441 556</b>	038 906 461 C	<b>0 281 002 757</b>	045 130 073 Q	<b>0 414 720 031</b>	057 130 277 AM	<b>0 445 117 019</b>
038 130 079 CX	<b>0 986 441 556</b>	038 906 461 C	<b>0 986 280 202</b>	045 130 073 Q	<b>0 986 441 555</b>	057 130 277 AM	<b>0 986 435 412</b>
038 130 079 D	<b>0 986 441 559</b>	038 906 461 CX	<b>0 986 280 202</b>	045 130 073 R	<b>0 414 720 203</b>	057 130 277 AN	<b>0 445 117 038</b>
038 130 079 DX	<b>0 986 441 559</b>	038 906 461 D	<b>0 281 002 768</b>	045 130 073 S	<b>0 414 720 207</b>	057 130 277 AN	<b>0 986 435 451</b>
038 130 079 F	<b>0 414 720 266</b>	038 906 461 X	<b>0 986 284 008</b>	045 130 073 T	<b>0 414 720 085</b>	057 130 277 BC	<b>0 445 118 011</b>
038 130 079 FX	<b>0 986 441 560</b>	04E 906 461 A	<b>0 280 218 486</b>	045 130 073 T	<b>0 986 441 551</b>	057 130 277 K	<b>0 445 110 132</b>
038 130 079 GX	<b>0 986 441 559</b>	04F 130 277	<b>0 445 110 650</b>	045 130 079 AX	<b>0 986 441 552</b>	057 130 277 L	<b>0 445 110 157</b>
038 130 079 HX	<b>0 986 441 562</b>	04L 130 277	<b>0 445 110 468</b>	045 130 079 BX	<b>0 986 441 555</b>	057 130 277 L	<b>0 986 435 168</b>
038 130 079 J	<b>0 414 720 224</b>	04L 130 277	<b>0 986 435 258</b>	045 130 079 X	<b>0 986 441 551</b>	057 130 277 M	<b>0 445 110 157</b>
038 130 079 MX	<b>0 986 441 569</b>	04L 130 277 A	<b>0 445 110 472</b>	045 906 461	<b>0 281 002 318</b>	057 130 277 M	<b>0 986 435 168</b>
038 130 079 NX	<b>0 986 441 570</b>	04L 130 277 A	<b>0 986 435 259</b>	045 906 461	<b>0 986 284 002</b>	057 130 277 N	<b>0 445 110 210</b>
038 130 079 PX	<b>0 986 441 572</b>	04L 130 277 AA	<b>0 445 110 638</b>	045 906 461 X	<b>0 986 284 002</b>	057 130 755 AC	<b>0 445 010 801</b>
038 130 079 QX	<b>0 986 441 574</b>	04L 130 277 AB	<b>0 445 110 641</b>	046 130 108 A	<b>0 986 440 566</b>	057 130 755 AC	<b>0 986 437 418</b>
038 130 079 RX	<b>0 986 441 575</b>	04L 130 277 AC	<b>0 445 110 468</b>	046 130 108 AX	<b>0 986 440 566</b>	057 130 755 AD	<b>0 445 010 664</b>
038 130 079 SX	<b>0 986 441 560</b>	04L 130 277 AC	<b>0 986 435 258</b>	046 130 108 C	<b>0 460 415 997</b>	057 130 755 AD	<b>0 986 437 416</b>
038 130 079 TX	<b>0 986 441 568</b>	04L 130 277 AD	<b>0 445 110 472</b>	046 130 108 D	<b>0 460 415 994</b>	057 130 755 AE	<b>0 445 010 675</b>
038 130 079 X	<b>0 986 441 553</b>	04L 130 277 AE	<b>0 445 110 470</b>	046 130 108 D	<b>0 986 440 563</b>	057 130 755 AE	<b>0 986 437 418</b>
038 130 080 AX	<b>0 986 441 567</b>	04L 130 277 AE	<b>0 986 435 257</b>	046 130 108 DX	<b>0 986 440 563</b>	057 130 755 AK	<b>0 445 010 826</b>
038 130 080 BX	<b>0 986 441 564</b>	04L 130 277 AF	<b>0 445 110 644</b>	046 130 108 F	<b>0 460 415 994</b>	057 130 755 AL	<b>0 445 010 826</b>
038 130 080 CX	<b>0 986 441 571</b>	04L 130 277 AJ	<b>0 445 110 476</b>	046 130 108 F	<b>0 986 440 563</b>	057130755AM	<b>0 445 010 838</b>
038 130 080 X	<b>0 986 441 577</b>	04L 130 277 AK	<b>0 445 110 474</b>	046 130 108 FX	<b>0 986 440 563</b>	057 130 755 G	<b>0 445 010 358</b>
038 130 107 B	<b>0 460 404 972</b>	04L 130 277 AK	<b>0 986 435 242</b>	046 130 108 G	<b>0 986 440 563</b>	057 130 755 G	<b>0 986 437 346</b>
038 130 107 B	<b>0 986 440 556</b>	04L 130 277 AL	<b>0 445 110 704</b>	046 130 108 GX	<b>0 986 440 563</b>	057 130 755 H	<b>0 445 010 340</b>
038 130 107 BX	<b>0 986 440 556</b>	04L 130 277 AM	<b>0 445 110 702</b>	046 804	<b>0 460 494 165</b>	057 130 755 K	<b>0 445 010 340</b>
038 130 107 D	<b>0 460 404 977</b>	04L 130 277 C	<b>0 445 110 470</b>	05A 130 277	<b>0 445 117 011</b>	057 130 755 L	<b>0 445 010 340</b>
038 130 107 D	<b>0 986 440 557</b>	04L 130 277 C	<b>0 986 435 257</b>	05A 130 277	<b>0 986 435 384</b>	057 130 755 M	<b>0 445 010 340</b>
038 130 107 DX	<b>0 460 404 977</b>	04L 130 277 E	<b>0 445 110 474</b>	05A 130 755 A	<b>0 445 010 663</b>	057 130 755 M	<b>0 986 437 344</b>
038 130 107 DX	<b>0 986 440 557</b>	04L 130 277 E	<b>0 986 435 242</b>	05A 130 755 A	<b>0 986 437 414</b>	057 130 755 S	<b>0 445 010 801</b>
038 130 107 E	<b>0 460 404 977</b>	04L 130 277 G	<b>0 445 110 476</b>	05A 130 755 B	<b>0 445 010 663</b>	057 130 755 S	<b>0 986 437 418</b>
038 130 107 E	<b>0 986 440 557</b>	04L 130 277 G	<b>0 986 435 241</b>	05A 130 755 B	<b>0 986 437 414</b>	057 130 755 T	<b>0 445 010 664</b>
038 130 107 EX	<b>0 986 440 557</b>	04L 130 277 K	<b>0 445 110 470</b>	05A 130 755 BC	<b>0 445 010 663</b>	057 130 755 T	<b>0 986 437 416</b>
038 130 107 H	<b>0 986 440 561</b>	04L 130 277 K	<b>0 986 435 257</b>	05A 130 755 BC	<b>0 986 437 414</b>	057 130 851 AX	<b>0 986 437 346</b>
038 130 107 HX	<b>0 986 440 561</b>	04L 130 277 N	<b>0 445 110 553</b>	05A 130 755 C	<b>0 445 010 663</b>	057 130 851 BX	<b>0 986 437 416</b>
038 130 107 J	<b>0 986 440 561</b>	04L 130 277 P	<b>0 445 110 555</b>	05A 130 755 C	<b>0 986 437 414</b>	057 130 851 CX	<b>0 986 437 418</b>
038 130 107 JX	<b>0 986 440 561</b>	04L 130 755 D	<b>0 445 010 570</b>	05A 130 755 T	<b>0 445 010 664</b>	057 130 851 DX	<b>0 986 437 316</b>
038 130 107 KX	<b>0 986 440 557</b>	04L 130 755 D	<b>0 986 437 440</b>	05A 130 851 X	<b>0 986 437 414</b>	057 130 851 X	<b>0 986 437 344</b>
038 130 201 F	<b>0 432 193 734</b>	04L 130 755 E	<b>0 445 010 583</b>	05L 130 277 B	<b>0 445 110 830</b>	057 130 855 AX	<b>0 986 435 364</b>
038 130 201 FX	<b>0 432 193 734</b>	04L 130 755 E	<b>0 986 437 440</b>	05L 130 277 H	<b>0 445 110 873</b>	057 130 855 AX	<b>0 986 435 374</b>
038 130 201 G	<b>0 432 193 732</b>	041 835 31	<b>9 430 082 276</b>	05L 130 277 J	<b>0 445 110 875</b>	057 906 461 C	<b>0 281 002 435</b>
038 130 201 GX	<b>0 432 193 732</b>	045 130 073	<b>0 414 720 004</b>	05L 130 277 K	<b>0 445 110 869</b>	057 906 461 C	<b>0 986 284 006</b>
038 130 201 R	<b>0 432 193 584</b>	045 130 073 AA	<b>0 414 720 084</b>	05L 130 277 L	<b>0 445 110 871</b>	057 906 461 CX	<b>0 986 284 006</b>
038 130 201 S	<b>0 432 193 579</b>	045 130 073 AA	<b>0 986 441 555</b>	053 906 301 1	<b>0 280 202 126</b>	058 133 471 A	<b>0 280 217 112</b>
038 130 201 S	<b>0 986 430 542</b>	045 130 073 AB	<b>0 414 720 083</b>	053 906 301 4	<b>0 280 202 136</b>	059 130 105 A	<b>0 986 444 067</b>



## ◀ VW

059 130 106	<b>0 986 444 070</b>	059 130 277 B	<b>0 445 115 003</b>	059 130 755 AL	<b>0 445 010 694</b>	059 130 755 T	<b>0 986 437 404</b>
059 130 106 A	<b>0 986 444 074</b>	059 130 277 BA	<b>0 445 115 082</b>	059 130 755 AN	<b>0 986 437 454</b>	059 130 851 AX	<b>0 986 437 348</b>
059 130 106 B	<b>0 470 506 049</b>	059 130 277 BA	<b>0 986 435 372</b>	059 130 755 BB	<b>0 445 010 659</b>	059 130 851 X	<b>0 986 437 093</b>
059 130 106 B	<b>0 986 444 068</b>	059 130 277 BB	<b>0 445 115 080</b>	059 130 755 BB	<b>0 445 010 685</b>	059 130 855 AX	<b>0 986 435 358</b>
059 130 106 BX	<b>0 986 444 068</b>	059 130 277 BD	<b>0 445 115 078</b>	059 130 755 BC	<b>0 445 010 654</b>	059 130 855 FX	<b>0 986 435 357</b>
059 130 106 C	<b>0 986 444 070</b>	059 130 277 BD	<b>0 986 435 358</b>	059 130 755 BC	<b>0 445 010 694</b>	059 130 855 GX	<b>0 986 435 380</b>
059 130 106 CX	<b>0 986 444 070</b>	059 130 277 BE	<b>0 445 116 022</b>	059 130 755 BD	<b>0 445 010 669</b>	059 906 461 B	<b>0 281 002 403</b>
059 130 106 D	<b>0 986 444 067</b>	059 130 277 BE	<b>0 445 118 006</b>	059 130 755 BD	<b>0 445 010 685</b>	059 906 461 B	<b>0 986 284 004</b>
059 130 106 DX	<b>0 986 444 067</b>	059 130 277 BE	<b>0 986 435 357</b>	059 130 755 BD	<b>0 986 437 404</b>	059 906 461 BX	<b>0 986 284 004</b>
059 130 106 E	<b>0 986 444 071</b>	059 130 277 CC	<b>0 445 116 039</b>	059 130 755 BE	<b>0 445 010 656</b>	059 906 461 E	<b>0 281 002 429</b>
059 130 106 EX	<b>0 986 444 071</b>	059 130 277 CC	<b>0 986 435 422</b>	059 130 755 BE	<b>0 445 010 694</b>	059 906 461 E	<b>0 986 284 005</b>
059 130 106 H	<b>0 986 444 073</b>	059 130 277 CD	<b>0 445 117 021</b>	059 130 755 BF	<b>0 445 010 657</b>	059 906 461 EX	<b>0 986 284 005</b>
059 130 106 J	<b>0 986 444 072</b>	059 130 277 CD	<b>0 986 435 413</b>	059 130 755 BF	<b>0 986 437 454</b>	06A 906 461	<b>0 280 217 121</b>
059 130 106 JX	<b>0 986 444 072</b>	059 130 277 CG	<b>0 986 435 432</b>	059 130 755 BG	<b>0 445 010 658</b>	06A 906 461	<b>0 281 002 757</b>
059 130 106 K	<b>0 986 444 083</b>	059 130 277 CH	<b>0 445 117 026</b>	059 130 755 BG	<b>0 986 437 435</b>	06A 906 461	<b>0 986 280 202</b>
059 130 106 KX	<b>0 986 444 083</b>	059 130 277 CH	<b>0 986 435 453</b>	059 130 755 BH	<b>0 986 437 463</b>	06A 906 461	<b>0 986 284 010</b>
059 130 106 L	<b>0 986 444 073</b>	059 130 277 CJ	<b>0 445 116 022</b>	059 130 755 BJ	<b>0 445 010 692</b>	06A 906 461 AC	<b>0 280 218 212</b>
059 130 106 LX	<b>0 986 444 073</b>	059 130 277 CK	<b>0 445 117 028</b>	059 130 755 BJ	<b>0 986 437 435</b>	06A 906 461 C	<b>0 280 218 023</b>
059 130 106 M	<b>0 986 444 084</b>	059 130 277 CK	<b>0 986 435 431</b>	059 130 755 BK	<b>0 445 010 673</b>	06A 906 461 C	<b>0 986 280 209</b>
059 130 108 A	<b>0 986 444 067</b>	059 130 277 CP	<b>0 986 435 432</b>	059 130 755 BK	<b>0 445 010 685</b>	06A 906 461 CX	<b>0 986 280 209</b>
059 130 108 AX	<b>0 986 444 067</b>	059 130 277 CR	<b>0 986 435 441</b>	059 130 755 BL	<b>0 445 010 673</b>	06A 906 461 D	<b>0 280 217 529</b>
059 130 201	<b>0 432 133 835</b>	059 130 277 CT	<b>0 986 435 455</b>	059 130 755 BL	<b>0 445 010 685</b>	06A 906 461 D	<b>0 986 280 210</b>
059 130 201 A	<b>0 432 133 824</b>	059 130 277 DE	<b>0 445 117 049</b>	059 130 755 BL	<b>0 986 437 404</b>	06A 906 461 DX	<b>0 986 280 210</b>
059 130 201 B	<b>0 432 133 817</b>	059 130 277 DE	<b>0 986 435 432</b>	059 130 755 BS	<b>0 445 010 685</b>	06A 906 461 E	<b>0 280 218 034</b>
059 130 201 D	<b>0 432 133 804</b>	059 130 277 DG	<b>0 445 117 049</b>	059 130 755 BS	<b>0 986 437 404</b>	06A 906 461 E	<b>0 986 280 211</b>
059 130 201 F	<b>0 432 133 794</b>	059 130 277 DG	<b>0 986 435 432</b>	059 130 755 BT	<b>0 445 010 694</b>	06A 906 461 EX	<b>0 986 280 211</b>
059 130 201 G	<b>0 432 133 785</b>	059 130 277 DR	<b>0 445 117 054</b>	059 130 755 CA	<b>0 445 010 682</b>	06A 906 461 G	<b>0 986 280 216</b>
059 130 202	<b>0 432 133 833</b>	059 130 277 ED	<b>0 986 435 441</b>	059 130 755 CA	<b>0 986 437 454</b>	06A 906 461 GX	<b>0 986 280 216</b>
059 130 202 B	<b>0 432 133 822</b>	059 130 277 EE	<b>0 986 435 455</b>	059 130 755 CB	<b>0 445 010 676</b>	06A 906 461 L	<b>0 986 280 217</b>
059 130 202 C	<b>0 432 133 815</b>	059 130 277 EF	<b>0 445 117 049</b>	059 130 755 CB	<b>0 986 437 435</b>	06A 906 461 LX	<b>0 986 280 217</b>
059 130 202 E	<b>0 432 133 802</b>	059 130 277 EG	<b>0 445 117 054</b>	059 130 755 CC	<b>0 445 010 690</b>	06A 906 461 M	<b>0 280 218 065</b>
059 130 202 F	<b>0 432 133 792</b>	059 130 277 EH	<b>0 445 116 039</b>	059 130 755 CC	<b>0 986 437 463</b>	06A 906 461 M	<b>0 986 280 218</b>
059 130 202 G	<b>0 432 133 783</b>	059 130 277 EH	<b>0 986 435 422</b>	059 130 755 CD	<b>0 445 010 692</b>	06A 906 461 MX	<b>0 986 280 218</b>
059 130 277 AA	<b>0 445 115 034</b>	059 130 277 EJ	<b>0 445 117 021</b>	059 130 755 CD	<b>0 986 437 435</b>	06A 906 461 N	<b>0 280 218 100</b>
059 130 277 AA	<b>0 445 115 078</b>	059 130 277 EJ	<b>0 986 435 413</b>	059 130 755 CG	<b>0 445 010 805</b>	06A 906 461 N	<b>0 986 280 223</b>
059 130 277 AB	<b>0 445 115 036</b>	059 130 277 EK	<b>0 445 117 026</b>	059 130 755 CG	<b>0 445 010 813</b>	06A 906 461 NX	<b>0 986 280 223</b>
059 130 277 AB	<b>0 445 115 078</b>	059 130 277 EK	<b>0 986 435 453</b>	059 130 755 CG	<b>0 986 437 456</b>	06A 906 461 T	<b>0 280 218 124</b>
059 130 277 AC	<b>0 445 115 038</b>	059 130 277 EL	<b>0 445 117 028</b>	059 130 755 CN	<b>0 445 010 813</b>	06A 906 461 X	<b>0 986 280 202</b>
059 130 277 AC	<b>0 986 435 353</b>	059 130 277 EQ	<b>0 445 117 064</b>	059 130 755 CN	<b>0 986 437 456</b>	06B 133 471	<b>0 280 218 013</b>
059 130 277 AC	<b>0 986 435 388</b>	059 130 277 ER	<b>0 445 117 062</b>	059 130 755 CS	<b>0 445 010 842</b>	06B 133 471 A	<b>0 280 218 058</b>
059 130 277 AH	<b>0 445 115 051</b>	059 130 277 ES	<b>0 445 118 014</b>	059 130 755 DA	<b>0 445 010 830</b>	06B 133 471 A	<b>0 986 280 215</b>
059 130 277 AH	<b>0 445 115 078</b>	059 130 277 FD	<b>0 445 117 079</b>	059 130 755 DB	<b>0 445 010 824</b>	06B 133 471 AX	<b>0 986 280 215</b>
059 130 277 AH	<b>0 986 435 358</b>	059 130 277 M	<b>0 445 115 018</b>	059 130 755 DF	<b>0 445 010 867</b>	06B 906 461	<b>0 280 218 132</b>
059 130 277 AJ	<b>0 445 115 053</b>	059 130 277 M	<b>0 986 435 353</b>	059 130 755 E	<b>0 986 437 348</b>	062 130 107	<b>0 460 424 138</b>
059 130 277 AJ	<b>0 986 435 353</b>	059 130 277 M	<b>0 986 435 388</b>	059 130 755 F	<b>0 986 437 348</b>	062 130 107	<b>0 986 440 228</b>
059 130 277 AJ	<b>0 986 435 388</b>	059 130 277 Q	<b>0 445 115 003</b>	059 130 755 H	<b>0 445 010 133</b>	062 130 107 A	<b>0 460 424 222</b>
059 130 277 AK	<b>0 445 116 002</b>	059 130 277 Q	<b>0 445 115 078</b>	059 130 755 H	<b>0 986 437 093</b>	062 130 201	<b>0 445 110 081</b>
059 130 277 AK	<b>0 986 435 377</b>	059 130 755 AB	<b>0 445 010 659</b>	059 130 755 J	<b>0 445 010 343</b>	062 130 201	<b>0 986 435 252</b>
059 130 277 AM	<b>0 445 117 004</b>	059 130 755 AB	<b>0 986 437 404</b>	059 130 755 L	<b>0 445 010 133</b>	062 130 201 A	<b>0 445 110 125</b>
059 130 277 AM	<b>0 986 435 382</b>	059 130 755 AG	<b>0 445 010 654</b>	059 130 755 L	<b>0 986 437 093</b>	062 130 205	<b>0 432 193 731</b>
059 130 277 AN	<b>0 445 116 002</b>	059 130 755 AH	<b>0 445 010 659</b>	059 130 755 N	<b>0 445 010 343</b>	062 130 755	<b>0 445 010 044</b>
059 130 277 AP	<b>0 445 116 007</b>	059 130 755 AH	<b>0 445 010 685</b>	059 130 755 N	<b>0 986 437 348</b>	068 130 081 F	<b>0 460 494 182</b>
059 130 277 AP	<b>0 986 435 357</b>	059 130 755 AK	<b>0 445 010 676</b>	059 130 755 S	<b>0 445 010 331</b>	068 130 081 F	<b>0 986 440 125</b>
059 130 277 AR	<b>0 445 116 014</b>	059 130 755 AK	<b>0 986 437 435</b>	059 130 755 S	<b>0 986 437 093</b>	068 130 081 FX	<b>0 986 440 125</b>
059 130 277 AR	<b>0 986 435 357</b>	059 130 755 AL	<b>0 445 010 654</b>	059 130 755 T	<b>0 445 010 659</b>	068 130 107 H	<b>0 986 440 113</b>

068 130 107 HX	<b>0 986 440 113</b>	07Z 130 073 FX	<b>0 414 720 260</b>	074 130 109 N	<b>0 986 440 256</b>	076 130 277	<b>0 445 115 028</b>
068 130 107 T	<b>0 460 494 152</b>	07Z 130 073 FX	<b>0 986 441 561</b>	074 130 109 NX	<b>0 986 440 256</b>	076 130 277	<b>0 986 435 352</b>
068 130 107 T	<b>0 986 440 123</b>	07Z 130 073 G	<b>0 414 720 217</b>	074 130 109 Q	<b>0 986 440 569</b>	077 133 471 D	<b>0 280 217 804</b>
068 130 107 TX	<b>0 460 494 152</b>	07Z 130 073 H	<b>0 414 720 270</b>	074 130 109 QX	<b>0 986 440 569</b>	077 133 471 E	<b>0 280 217 817</b>
068 130 107 TX	<b>0 986 440 123</b>	07Z 130 073 H	<b>0 986 441 565</b>	074 130 109 R	<b>0 986 440 571</b>	077 133 471 G	<b>0 280 218 015</b>
068 130 108 G	<b>0 986 440 246</b>	07Z 130 073 HX	<b>0 414 720 270</b>	074 130 109 RX	<b>0 986 440 571</b>	077 133 471 G	<b>0 986 280 207</b>
068 130 108 GX	<b>0 986 440 246</b>	07Z 130 073 HX	<b>0 986 441 565</b>	074 130 109 S	<b>0 986 440 244</b>	077 133 471 GX	<b>0 986 280 207</b>
068 130 108 M	<b>0 986 440 113</b>	07Z 130 073 K	<b>0 414 720 275</b>	074 130 109 T	<b>0 986 440 253</b>	077 133 471 H	<b>0 986 280 213</b>
068 130 109	<b>0 460 494 165</b>	07Z 130 073 K	<b>0 986 441 563</b>	074 130 110 A	<b>0 986 440 564</b>	077 133 471 HX	<b>0 986 280 213</b>
068 130 109 R	<b>0 460 484 108</b>	07Z 130 073 KX	<b>0 414 720 275</b>	074 130 110 AX	<b>0 986 440 564</b>	077 133 471 J	<b>0 280 218 069</b>
068 130 109 R1	<b>0 460 484 108</b>	07Z 130 073 KX	<b>0 986 441 563</b>	074 130 110 F	<b>0 986 440 244</b>	077 133 471 J	<b>0 986 280 220</b>
068 130 109 6	<b>0 460 494 165</b>	07Z 130 073 N	<b>0 414 720 359</b>	074 130 110 H	<b>0 986 440 253</b>	077 133 471 JX	<b>0 986 280 220</b>
068 130 110 B	<b>0 986 440 135</b>	07Z 130 073 N	<b>0 986 441 578</b>	074 130 110 J	<b>0 986 440 243</b>	077 133 471 K	<b>0 280 218 067</b>
068 130 110 BX	<b>0 986 440 135</b>	07Z 130 073 NX	<b>0 986 441 578</b>	074 130 110 K	<b>0 460 415 996</b>	077 133 471 K	<b>0 986 280 219</b>
068 130 110 Q	<b>0 986 440 135</b>	07Z 130 073 S	<b>0 414 720 301</b>	074 130 110 K	<b>0 986 440 565</b>	077 133 471 KX	<b>0 986 280 219</b>
068 130 110 QX	<b>0 986 440 135</b>	07Z 130 073 S	<b>0 414 720 305</b>	074 130 110 KX	<b>0 986 440 565</b>	077 133 471 M	<b>0 280 218 187</b>
068 130 201 B	<b>0 986 430 080</b>	07Z 130 073 S	<b>0 986 441 576</b>	074 130 110 M	<b>0 986 440 564</b>	077 906 461	<b>0 280 218 067</b>
068 130 201 BX	<b>0 986 430 080</b>	07Z 130 073 T	<b>0 414 720 361</b>	074 130 110 MX	<b>0 986 440 564</b>	078 906 461 B	<b>0 280 218 038</b>
068 130 201 C	<b>0 432 217 077</b>	07Z 130 073 T	<b>0 986 441 576</b>	074 130 110 N	<b>0 986 440 562</b>	078 906 461 B	<b>0 986 280 212</b>
068 130 201 E	<b>0 432 217 084</b>	07Z 130 073 TX	<b>0 986 441 576</b>	074 130 110 NX	<b>0 986 440 562</b>	078 906 461 BX	<b>0 986 280 212</b>
068 130 201 E	<b>0 986 430 081</b>	070 130 073 K	<b>0 414 720 211</b>	074 130 115 B	<b>0 986 440 562</b>	079 133 471	<b>0 280 218 214</b>
068 130 201 EX	<b>0 986 430 081</b>	070 130 073 N	<b>0 414 720 278</b>	074 130 115 BX	<b>0 986 440 562</b>	1JD 906 461	<b>0 986 280 216</b>
068 130 201 J	<b>0 986 430 089</b>	070 130 073 N	<b>0 986 441 573</b>	074 130 201 C	<b>0 432 193 823</b>	2EO 131 971	<b>F 01C 600 283</b>
068 130 201 JX	<b>0 986 430 089</b>	070 130 073 NX	<b>0 986 441 573</b>	074 130 201 G	<b>0 432 193 716</b>	2EO 906 461	<b>0 281 002 585</b>
068 130 201 K	<b>0 986 430 089</b>	070 130 073 R	<b>0 414 720 360</b>	074 130 201 J	<b>0 432 193 662</b>	2EO 906 461	<b>0 281 002 586</b>
068 130 201 KX	<b>0 986 430 089</b>	070 130 073 R	<b>0 986 441 579</b>	074 130 201 K	<b>0 432 193 669</b>	2EO 906 461 C	<b>0 281 002 896</b>
068 130 201 N	<b>0 432 217 164</b>	070 130 073 RX	<b>0 986 441 579</b>	074 130 201 Q	<b>0 432 193 615</b>	2PO 130 105	<b>0 445 010 294</b>
068 130 201 R	<b>0 986 430 190</b>	071 906 301 A	<b>0 280 200 028</b>	074 130 201 T	<b>0 432 193 552</b>	2PO 130 105 B	<b>0 445 020 122</b>
068 130 201 RX	<b>0 986 430 190</b>	071 906 461	<b>0 280 217 523</b>	074 130 202 A	<b>0 432 193 821</b>	2PO 130 105 B	<b>0 986 437 310</b>
068 130 202	<b>0 432 217 207</b>	071 906 461 A	<b>0 280 217 529</b>	074 130 202 M	<b>0 432 193 608</b>	2PO 130 201	<b>0 445 110 231</b>
068 130 202	<b>0 986 430 189</b>	071 906 461 A	<b>0 986 280 204</b>	074 130 202 P	<b>0 432 193 621</b>	2PO 130 201 A	<b>0 445 120 297</b>
068 130 202 A	<b>0 432 217 210</b>	071 906 461 AX	<b>0 986 280 204</b>	074 130 202 Q	<b>0 432 193 619</b>	2RD 130 105	<b>0 460 424 102</b>
068 130 202 A	<b>0 986 430 234</b>	071 906 461 B	<b>0 280 218 017</b>	074 130 202 R	<b>0 432 193 608</b>	2RD 130 105 A	<b>0 460 424 128</b>
068 130 202 D	<b>0 986 430 235</b>	071 906 461 B	<b>0 986 280 208</b>	074 130 202 S	<b>0 432 193 617</b>	2RD 130 201	<b>9 430 082 752</b>
068 130 202 DX	<b>0 986 430 235</b>	071 906 461 BX	<b>0 986 280 208</b>	074 130 203 A	<b>0 432 193 613</b>	2RD 130 201 A	<b>9 430 082 767</b>
068 130 202 E	<b>0 986 430 225</b>	074 130 107 E	<b>0 986 440 242</b>	074 130 203 B	<b>0 432 193 510</b>	2RE 130 105 A	<b>0 460 424 131</b>
068 130 202 EX	<b>0 986 430 225</b>	074 130 107 EX	<b>0 986 440 242</b>	074 130 204 C	<b>0 432 193 550</b>	2RE 130 105 B	<b>0 460 424 194</b>
068 130 202 F	<b>0 986 430 187</b>	074 130 107 N	<b>0 460 415 996</b>	074 130 204 D	<b>0 432 193 508</b>	2RE 130 201	<b>9 430 082 769</b>
068 130 202 FX	<b>0 432 217 240</b>	074 130 107 N	<b>0 986 440 565</b>	074 906 461 B	<b>0 281 002 461</b>	2RH 130 105 B	<b>0 460 426 250</b>
068 130 202 FX	<b>0 986 430 187</b>	074 130 107 NX	<b>0 986 440 565</b>	074 906 461 B	<b>0 986 284 007</b>	2RK 130 201 A	<b>9 430 082 762</b>
068 130 202 G	<b>0 986 430 188</b>	074 130 108 G	<b>0 986 440 242</b>	074 906 461 BX	<b>0 986 284 007</b>	2RL 130 105 A	<b>0 460 426 251</b>
068 130 202 GX	<b>0 986 430 188</b>	074 130 108 GX	<b>0 986 440 242</b>	075 130 107 D	<b>0 986 440 016</b>	2RL 130 201 B	<b>9 430 082 747</b>
068 130 202 X	<b>0 986 430 189</b>	074 130 108 L	<b>0 986 440 256</b>	075 130 107 DX	<b>0 986 440 016</b>	2RO 130 105	<b>0 445 020 007</b>
07C 906 461	<b>0 280 218 071</b>	074 130 108 M	<b>0 986 440 252</b>	075 130 107 E	<b>0 986 440 017</b>	2RO 130 105	<b>0 986 437 341</b>
07C 906 461	<b>0 986 280 221</b>	074 130 108 Q	<b>0 986 440 256</b>	075 130 107 EX	<b>0 986 440 017</b>	2RO 130 105 B	<b>0 445 020 033</b>
07C 906 461 A	<b>0 280 218 143</b>	074 130 108 S	<b>0 986 440 252</b>	075 130 107 L	<b>0 986 440 235</b>	2RO 130 105 C	<b>0 460 424 369</b>
07C 906 461 X	<b>0 986 280 221</b>	074 130 108 T	<b>0 986 440 256</b>	075 130 107 LX	<b>0 986 440 235</b>	2RO 130 201 A	<b>0 986 435 508</b>
07D 906 461	<b>0 986 280 222</b>	074 130 109 B	<b>0 986 440 562</b>	075 130 107 Q	<b>0 986 440 236</b>	2RO 130 201 B	<b>0 445 120 043</b>
07D 906 461 X	<b>0 986 280 222</b>	074 130 109 BX	<b>0 986 440 562</b>	075 130 107 QX	<b>0 986 440 236</b>	2RO 198 133	<b>0 445 120 212</b>
07W 130 205	<b>0 445 120 162</b>	074 130 109 C	<b>0 986 440 254</b>	075 130 108 A	<b>0 986 440 235</b>	2S0 129 405	<b>F 000 439 018</b>
07W 130 205 A	<b>0 445 120 186</b>	074 130 109 CX	<b>0 986 440 254</b>	076 130 107 G	<b>0 460 406 039</b>	2S0 130 081	<b>0 460 426 342</b>
07W 130 759 A	<b>0 445 020 207</b>	074 130 109 G	<b>0 986 440 243</b>	076 130 107 G	<b>0 986 440 233</b>	2 S0 130 107	<b>0 460 426 324</b>
07Z 130 073 D	<b>0 414 720 260</b>	074 130 109 H	<b>0 986 440 564</b>	076 130 107 GX	<b>0 986 440 233</b>	2S2 130 200	<b>0 445 120 077</b>
07Z 130 073 F	<b>0 414 720 260</b>	074 130 109 HX	<b>0 986 440 564</b>	076 130 107 H	<b>0 986 440 234</b>	2TA 130 105 A	<b>0 460 424 115</b>
07Z 130 073 F	<b>0 986 441 561</b>	074 130 109 K	<b>0 986 440 243</b>	076 130 107 HX	<b>0 986 440 234</b>	2TA 130 105 AX	<b>0 460 424 115</b>

◀ VW

2TA 130 201	<b>9 430 082 759</b>
2TB 130 201	<b>F 000 439 013</b>
2TG 130 201	<b>F 000 439 004</b>
2TJ 130 201	<b>F 000 439 005</b>
2 T0 130 201	<b>0 432 133 837</b>

2T0 130 201 A	<b>0 432 191 629</b>
2T0 130 201 B	<b>F 000 439 019</b>
2T0 130 201 C	<b>F 000 439 022</b>
2T0 130 201 D	<b>F 000 439 029</b>
2T2 130 201	<b>0 445 120 089</b>

2T2 130 201 A	<b>0 445 120 094</b>
2T2 130 201 D	<b>0 445 120 120</b>
2T2 130 201 D	<b>0 986 435 543</b>
2T2 198 133	<b>0 445 120 140</b>
2T2 198 133	<b>0 986 435 544</b>

2UV 130 105	<b>0 460 424 103</b>
2U0 130 201 A	<b>F 000 439 015</b>
2U0 130 201 B	<b>0 432 191 592</b>
2VC 130 105	<b>0 460 424 210</b>
2VC 130 105 A	<b>0 460 424 211</b>

2V5 131 113 A	<b>0 444 011 025</b>
2X0 130 277	<b>0 445 116 057</b>
2X0 130 277	<b>0 986 435 445</b>
2X0 133 277	<b>0 445 116 057</b>
2X0 133 277	<b>0 986 435 445</b>

2Z0 130 201	<b>0 445 120 257</b>
3C0 131 113 C	<b>0 444 021 021</b>
377 906 461	<b>0 280 218 053</b>
4G0 131 113	<b>0 444 021 035</b>
4H0 131 113 A	<b>0 444 021 034</b>

5Q0 131 969 C	<b>0 444 040 011</b>
5Q0 131 969 E	<b>0 444 040 022</b>
5Q0 131 971 B	<b>F 01C 600 266</b>
539 063 015	<b>0 280 202 137</b>
539 906 301 5	<b>0 280 202 137</b>

561 198 969	<b>F 01C 600 155</b>
561 198 969	<b>F 01C 600 194</b>
7L5 906 461 A	<b>0 280 218 141</b>
7L5 906 461 B	<b>0 280 218 198</b>
8Z0 906 461	<b>0 281 002 610</b>

90530767	<b>0 281 002 180</b>
90543463	<b>0 281 002 180</b>

<b>WAERTSILAE</b>	
PAAF010618	<b>0 445 020 274</b>
0016L036101	<b>0 432 480 002</b>
010101501R982A	<b>0 432 206 004</b>

0 432 291 530	<b>0 432 291 530</b>
414101511F906A	<b>0 432 380 016</b>
45657337	<b>0 432 291 530</b>

<b>WDEW (WEICHAH POWER CO.)</b>	
13024963	<b>0 445 020 071</b>
612600080611	<b>0 445 120 129</b>

612600080618	<b>0 445 120 130</b>
612600080618	<b>0 445 120 224</b>
612630030024	<b>0 445 020 064</b>
612630030057	<b>0 445 020 063</b>
612630090001	<b>0 445 120 086</b>

612630090008	<b>0 445 120 087</b>
--------------	----------------------

<b>WEICHAH POWER</b>	
X6260.068	<b>0 445 020 281</b>
X6260.244	<b>0 445 020 283</b>
1000035955	<b>0 445 120 461</b>

13024963	<b>0 445 020 116</b>
13024966	<b>0 445 120 150</b>
13024966	<b>0 445 120 244</b>
13034027	<b>0 445 120 191</b>
13034028	<b>0 445 120 260</b>

13035011	<b>0 445 120 107</b>
610800080072	<b>0 445 020 142</b>
610800080073	<b>0 445 120 261</b>
610800080588	<b>0 445 120 373</b>
612600080611	<b>0 445 120 149</b>

612600080611	<b>0 445 120 213</b>
612600080618	<b>0 445 120 170</b>
612600080674	<b>0 445 020 116</b>
612600080 924	<b>0 445 120 169</b>
612600080924	<b>0 445 120 214</b>

612600080964	<b>0 445 120 222</b>
612600080971	<b>0 445 120 129</b>
612600080971	<b>0 445 120 221</b>
612600080972	<b>0 445 120 200</b>
612600080974	<b>0 445 020 121</b>

612600080977	<b>0 445 120 227</b>
612600080978	<b>0 445 120 228</b>
612630030057	<b>0 445 020 165</b>
612630090012	<b>0 445 120 127</b>
612630090028	<b>0 445 120 265</b>

612640080015	<b>0 445 020 240</b>
612640080022	<b>0 445 120 344</b>
612640080031	<b>0 445 120 343</b>
612640090001	<b>0 445 120 266</b>
612640130003	<b>0 444 022 013</b>

612640130004	<b>0 444 023 023</b>
612640130089	<b>0 444 043 016</b>

<b>WULING</b>	
13301682	<b>0 280 218 254</b>

<b>WUXI SIDA DIESEL ENGINE</b>	
1112010 470	<b>0 445 120 081</b>
1112010 630	<b>0 445 120 078</b>

<b>XINCHEN</b>	
DK4A-1112010	<b>0 445 110 317</b>
XCEDK46020	<b>0 445 010 179</b>

<b>YAMZ (YAROSLAWL MOTORENWERKE)</b>	
53401111010	<b>0 445 020 110</b>
53401112010	<b>0 445 120 178</b>

6501111005	<b>0 445 020 086</b>
65011112010	<b>0 445 120 142</b>

<b>YANGCHAI (YANGZHOU DIESEL ENG)</b>	
YDE 2100528	<b>0 445 010 391</b>
Z20200033	<b>0 445 110 585</b>

2014355	<b>0 445 110 345</b>
2014994	<b>0 445 110 516</b>
2100626	<b>0 445 110 517</b>

<b>YOUNGMAN</b>	
L1 0100-6066	<b>0 445 120 045</b>
L1 10100-6126	<b>0 445 120 217</b>

<b>YUCHAI MACHINERY</b>	
A2000-1112100-A38	<b>0 445 120 379</b>
DM-A38	<b>0 444 043 008</b>
EG200-1112100-A38	<b>0 445 120 381</b>

FBC00-1112100-A38	<b>0 445 110 487</b>
FC700-1111100B-A38	<b>0 445 025 016</b>
FC700-1111100C-A38	<b>0 445 025 016</b>
FC700-1112100-A38	<b>0 445 110 356</b>
FG200-1111100A-A38	<b>0 445 025 029</b>

FG200-1111100-A38	<b>0 445 025 029</b>
FG200-1112100-A38	<b>0 445 110 486</b>
G2100-1111100-A38	<b>0 445 020 291</b>
G2100-1112100-A38	<b>0 445 120 083</b>
G5A00 1112100 A38	<b>0 445 120 163</b>

J0100-1112100A-A38	<b>0 445 120 291</b>
J0100-1112100-A38	<b>0 445 120 165</b>
J0100-1205350	<b>0 444 022 011</b>
J0100-1205580	<b>0 444 023 019</b>
J2000-1112100-A38	<b>0 445 120 380</b>

J5600-1112100-A38	<b>0 445 120 110</b>
J6A00-1112100-A38	<b>0 445 120 292</b>
K1000-1205350-A38	<b>0 444 042 037</b>
K1000-1205580-A38	<b>0 444 043 008</b>
K6000-1111100A-A38	<b>0 445 020 181</b>

L4700-1111100A-A38	<b>0 445 020 174</b>
L4700-1112100A-A38	<b>0 445 120 290</b>
L4700-1112100-A38	<b>0 445 120 156</b>
M6000-1111100A-A38	<b>0 445 020 184</b>
M6000-1112100A-A38	<b>0 445 120 333</b>

M6000 1112100 A38	<b>0 445 120 160</b>
SM-A38	<b>0 444 042 037</b>
S5000-1112100-A38	<b>0 445 120 372</b>

<b>YUNMA</b>	
15 06 2057F	<b>0 986 435 153</b>

<b>ZEXEL</b>	
H104701200	<b>9 460 611 581</b>
H104701203	<b>9 460 613 261</b>
H104721200	<b>9 460 611 586</b>

H104740010	<b>9 460 611 759</b>
H104740015	<b>9 460 610 726</b>
H104740045	<b>9 460 611 277</b>
H104740348	<b>9 460 610 168</b>
H104740473	<b>9 460 610 412</b>

H104740600	<b>9 460 620 011</b>
H104740614	<b>9 460 613 973</b>
H104740801	<b>9 460 610 625</b>
H104741816	<b>F 01G 09W 0GE</b>
H104741819	<b>F 01G 09W 0EL</b>

H104742701	<b>9 460 610 363</b>
H104742702	<b>9 460 610 364</b>
H104742703	<b>9 460 610 365</b>
H104742704	<b>9 460 611 109</b>
H104745331	<b>9 460 610 671</b>

H104745364	<b>9 460 611 605</b>
H104745412	<b>9 460 610 674</b>
H104748023	<b>9 460 610 613</b>
H104749149	<b>9 460 610 153</b>
H104749542	<b>9 460 620 015</b>

H104760411	<b>9 460 612 000</b>
H104761004	<b>9 460 612 054</b>
H104761401	<b>9 460 610 439</b>
H104761407	<b>9 460 610 767</b>
H104769217	<b>9 460 610 573</b>

H105031450	9 430 615 063	H105111470	9 430 613 791	H105119421	F 01G 09X 045	H105158222	9 430 610 128
H105031452	9 430 615 046	H105111487	9 430 612 143	H105119427	F 01G 09X 06V	H105158223	9 430 610 129
H105031453	9 430 615 061	H105111525	F 01G 09X 06P	H105119435	F 01G 09X 06X	H105158500	F 01G 0V4 000
H105031530	9 430 615 066	H105114360	F 01G 09X 076	H105140102	9 430 610 109	H105158501	F 01G 0V4 001
H105033302	9 430 615 047	H105114571	H 105 114 571	H105140119	9 430 610 165	H105158506	F 01G 001 000
H105071124	9 430 615 048	H105118411	9 430 612 390	H105140129	9 430 610 297	H105160404	9 430 610 513
H105081317	9 430 615 019	H105118412	9 430 610 046	H105141179	9 430 610 310	H105160410	9 430 610 520
H105100447	9 430 610 778	H105118416	9 430 610 068	H105141180	9 430 610 053	H105160417	9 430 610 525
H105100458	9 430 610 791	H105118422	9 430 613 671	H105141196	9 430 610 004	H105160429	9 430 610 536
H105100476	9 430 613 767	H105118425	9 430 612 409	H105141198	9 430 610 320	H105160437	9 430 612 730
H105100495	9 430 610 844	H105118427	9 430 612 412	H105141200	9 430 610 058	H105160466	9 430 610 567
H105100496	9 430 610 845	H105118443	9 430 612 436	H105141206	9 430 610 150	H105780814	9 430 610 168
H105100503	9 430 612 972	H105118471	9 430 612 474	H105141208	9 430 610 005	H105780818	9 430 613 641
H105100543	9 430 610 097	H105118472	9 430 612 478	H105141212	9 430 610 331	H105780819	9 430 610 134
H105100572	9 430 613 826	H105118503	9 430 612 516	H105141213	9 430 610 006	H105780831	9 430 613 457
H105100575	9 430 610 052	H105118521	9 430 612 541	H105141224	9 430 610 007	H105780832	9 430 613 755
H105100587	9 430 610 080	H105118522	9 430 612 545	H105141227	9 430 610 019	H146019252	9 460 610 208
H105100618	9 430 610 990	H105118575	9 430 612 603	H105141244	9 430 610 055	NP-VE4/10F2200R365-1	9 460 620 007
H105100624	9 430 610 996	H105118605	9 430 610 152	H105141251	9 430 610 033	NP VE4/10F2200R365 2	9 460 620 011
H105100669	9 430 610 044	H105118627	9 430 613 596	H105141252	9 430 610 358	NP-VE4/11F1800RNP110	9 460 610 609
H105100683	9 430 611 044	H105118640	9 430 613 689	H105141263	9 430 610 054	NP-VE4/11F1800RNP999	9 460 610 656
H105100699	9 430 611 063	H105118660	9 430 612 681	H105141287	9 430 610 385	NP VE 4/8 F 2600 R	9 460 620 008
H105100723	9 430 611 092	H105118669	9 430 610 184	H105141290	9 430 610 388	NP-VE4/8F2600R284	9 460 620 001
H105100751	9 430 611 126	H105118681	9 430 613 697	H105148100	9 430 610 397	NP-VE4/9F2500R305	9 460 620 002
H105100796	9 430 613 773	H105118683	9 430 613 447	H105148101	9 430 610 399	NP VE4/9F2500R305 2	9 460 620 009
H105101197	9 430 610 011	H105118692	9 430 613 530	H105148111	9 430 610 407	NP-VE4/9F2500R341	9 460 620 003
H105101457	9 430 611 278	H105118698	9 430 613 575	H105148115	9 430 613 539	VE 4/10F2200R365 3	9 460 620 017
H105101549	9 430 610 153	H105118702	9 430 610 072	H105148117	9 430 610 172	VE 4/10F2200R365-7	9 460 620 021
H105101562	9 430 611 370	H105118710	9 430 612 703	H105148118	9 430 610 157	VE 4/10F2250R 554-1	9 460 620 016
H105101642	9 430 611 464	H105118719	9 430 612 716	H105148122	9 430 610 135	VE 4/8F2600R284-3	9 460 620 014
H105101684	9 430 611 518	H105118723	9 430 613 634	H105148126	9 430 610 125	VE 4/9 F2500 R 305 3	9 460 620 015
H105101685	9 430 611 519	H105118728	9 430 610 167	H105148127	9 430 610 416	0445020083	0 445 020 083
H105101842	9 430 612 737	H105118733	9 430 610 193	H105148128	9 430 610 154	0445020118	0 445 020 118
H105101846	9 430 611 705	H105118737	9 430 613 958	H105148130	9 430 610 420	0445110307	0 986 435 196
H105104309	F 01G 09X 06Y	H105118738	9 430 610 198	H105148131	9 430 610 179	0445120126	0 445 120 126
H105110432	9 430 610 081	H105118754	9 430 613 635	H105148132	9 430 610 422	104700-2022	9 460 610 728
H105110470	9 430 613 993	H105118756	9 430 613 108	H105148135	F 01G 09X 06Z	104700-9142	9 460 615 083
H105110705	9 430 612 776	H105118762	9 430 613 869	H105148142	9 430 610 170	104701-2008	9 460 611 581
H105110706	9 430 612 785	H105118777	9 430 610 236	H105148148	9 430 610 158	104701-2032	9 460 613 261
H105110718	9 430 612 792	H105118783	9 430 613 989	H105148149	9 430 610 159	104721-2005	9 460 611 586
H105110734	9 430 611 917	H105118791	F 01G 09X 003	H105148150	9 430 610 160	104740-0105	9 460 611 759
H105110759	9 430 612 936	H105118793	9 430 613 206	H105148155	9 430 610 442	104740-0156	9 460 610 726
H105110763	9 430 611 945	H105118798	F 01G 09X 03R	H105148164	F 01G 09X 070	104740-0423	9 460 610 549
H105110812	9 430 613 825	H105118802	9 430 613 739	H105148165	9 430 613 543	104740-0454	9 460 611 277
H105110817	9 430 613 508	H105118806	9 430 613 217	H105148167	F 01G 09X 06L	104740-0642	9 460 611 536
H105110834	9 430 613 759	H105118813	9 430 613 960	H105148168	9 430 613 643	104740-1933	9 460 620 007
H105111115	9 430 612 944	H105118815	9 430 613 724	H105148170	F 01G 09X 06M	104740-1943	9 460 620 010
H105111402	9 430 613 651	H105118818	9 430 613 450	H105148172	F 01G 09X 06N	104740-4560	9 460 610 251
H105111404	9 430 612 035	H105118821	9 430 613 961	H105148178	F 01G 09X 041	104740-4621	9 460 610 254
H105111406	9 430 610 110	H105118822	9 430 613 873	H105148182	F 01G 09X 071	104740-4641	9 460 610 280
H105111453	9 430 612 113	H105118828	9 430 613 778	H105151137	9 430 610 077	104740-4734	9 460 610 412
H105111465	9 430 612 124	H105118829	9 430 613 974	H105151145	9 430 610 020	104740 6001	9 460 620 011
H105111466	9 430 613 658	H105118830	9 430 613 962	H105151148	9 430 610 456	104740 6002	9 460 620 011
H105111467	9 430 612 125	H105118839	F 01G 09X 03S	H105151153	9 430 610 459	104740-6050	9 460 620 013
H105111468	9 430 612 126	H105118861	F 01G 09X 05G	H105151160	9 430 610 462	104740-6060	9 460 620 016



◀ ZEXEL

104740-6070	<b>9 460 620 017</b>
104740-6071	<b>9 460 620 017</b>
104740-6120	<b>9 460 620 021</b>
104740-6143	<b>9 460 613 973</b>
104740-7680	<b>9 460 610 536</b>

104740-8012	<b>9 460 610 625</b>
104740-8311	<b>9 460 610 623</b>
104741-1064	<b>9 460 610 409</b>
104741-1272	<b>9 460 610 319</b>
104741-3250	<b>9 460 610 776</b>

104741-3690	<b>9 460 613 225</b>
104741-3750	<b>9 460 613 439</b>
104741-3822	<b>9 460 613 822</b>
104741-3831	<b>9 460 613 834</b>
104741-3842	<b>9 460 613 835</b>

104741-4413	<b>9 460 611 356</b>
104741-5472	<b>9 460 610 656</b>
104741-5891	<b>9 460 610 596</b>
104741-5901	<b>9 460 610 544</b>
104741-5990	<b>9 460 610 609</b>

104741-8161	<b>F 01G 09W 0GE</b>
104741-8190	<b>F 01G 09W 0EL</b>
104742-7044	<b>9 460 611 109</b>
104745-3150	<b>9 460 610 816</b>
104745-3153	<b>9 460 614 156</b>

104745-3310	<b>9 460 610 671</b>
104745-3641	<b>9 460 611 605</b>
104745-4124	<b>9 460 610 674</b>
104745-8470	<b>9 460 611 369</b>
104745-8473	<b>9 400 613 400</b>

104745-8473	<b>9 460 613 400</b>
104745-8691	<b>9 460 613 234</b>
104745-8810	<b>9 460 613 248</b>
104746-5170	<b>9 460 613 906</b>
104748-0232	<b>9 460 610 613</b>

104748-0344	<b>9 460 610 311</b>
104748-1722	<b>9 460 620 001</b>
104748-1724	<b>9 460 620 001</b>
104748-1841	<b>9 460 620 008</b>
104748-1850	<b>9 460 620 014</b>

104748-8473	<b>9 460 613 400</b>
104749-0344	<b>9 460 610 309</b>
104749-1491	<b>9 460 610 153</b>
104749-2144	<b>9 460 610 567</b>
104749-2230	<b>9 460 610 195</b>

104749-5090	<b>9 460 620 003</b>
104749-5091	<b>9 460 620 003</b>
104749-5354	<b>9 460 620 009</b>
104749-5420	<b>9 460 620 015</b>
104749-5421	<b>9 460 620 015</b>

104749-5481	<b>9 460 614 107</b>
104749-6913	<b>9 460 620 002</b>
104749-6916	<b>9 460 620 002</b>
104760-4112	<b>9 460 612 000</b>
104761-0046	<b>9 460 612 054</b>

104761-4022	<b>9 460 610 321</b>
104761-4072	<b>9 460 610 767</b>
104769-2176	<b>9 460 610 573</b>
105031-4520	<b>9 430 615 046</b>
105071-0681	<b>0 986 433 006</b>

105071-0681	<b>0 986 433 011</b>
105071-1241	<b>9 430 615 048</b>
105071-1270	<b>0 986 433 010</b>
105071-1361	<b>0 986 433 007</b>
105071-1361	<b>0 986 433 012</b>

105071-1361	<b>0 986 433 013</b>
105078-0050	<b>0 986 433 009</b>
105078-0150	<b>9 430 610 097</b>
105088-1061	<b>0 986 433 005</b>
105088-1090	<b>0 986 433 002</b>

105088-1090	<b>0 986 433 004</b>
105088-1090	<b>0 986 433 005</b>
105088-1120	<b>0 986 433 000</b>
105088-1130	<b>0 986 433 001</b>
105100-4470	<b>9 430 610 778</b>

105100-4582	<b>9 430 610 791</b>
105100-4762	<b>9 430 613 767</b>
105100-4950	<b>9 430 610 844</b>
105100-4960	<b>9 430 610 845</b>
105100-5031	<b>9 430 612 972</b>

105100-5351	<b>9 430 610 901</b>
105100-5430	<b>9 430 610 097</b>
105100-5721	<b>9 430 613 826</b>
105100-5870	<b>9 430 610 080</b>
105100-6180	<b>9 430 610 990</b>

105100-6210	<b>9 430 610 106</b>
105100-6241	<b>9 430 610 996</b>
105100-6830	<b>9 430 611 044</b>
105100-6991	<b>9 430 611 063</b>
105100-7230	<b>9 430 611 092</b>

105100-7510	<b>9 430 611 126</b>
105100-7961	<b>9 430 613 773</b>
105101-4570	<b>9 430 611 278</b>
105101-5490	<b>9 430 610 153</b>
105101-5620	<b>9 430 611 370</b>

105101-5790	<b>9 430 611 387</b>
105101-6420	<b>9 430 611 464</b>
105101-6840	<b>9 430 611 518</b>
105101-6850	<b>9 430 611 519</b>
105101-7882	<b>9 430 611 647</b>

105101-8422	<b>9 430 612 737</b>
105101-8460	<b>9 430 611 705</b>
105104-3090	<b>F 01G 09X 06Y</b>
105110-4320	<b>9 430 610 081</b>
105110-4702	<b>9 430 613 993</b>

105110-7053	<b>9 430 612 776</b>
105110-7062	<b>9 430 612 785</b>
105110-7183	<b>9 430 612 792</b>
105110-7341	<b>9 430 611 917</b>
105110-7370	<b>9 430 611 921</b>

105110-7591	<b>9 430 612 936</b>
105110-7630	<b>9 430 611 945</b>
105110-8122	<b>9 430 613 825</b>
105110-8172	<b>9 430 613 508</b>
105110-8341	<b>9 430 613 759</b>

105111-1153	<b>9 430 612 944</b>
105111-4023	<b>9 430 613 651</b>
105111-4040	<b>9 430 612 035</b>
105111-4060	<b>9 430 610 110</b>
105111-4530	<b>9 430 612 113</b>

105111-4650	<b>9 430 612 124</b>
105111-4661	<b>9 430 613 658</b>
105111-4670	<b>9 430 612 125</b>
105111-4680	<b>9 430 612 126</b>
105111-4701	<b>9 430 613 791</b>

105111-4870	<b>9 430 612 143</b>
105111-5250	<b>F 01G 09X 06P</b>
105113-3300	<b>9 430 612 186</b>
105113-3870	<b>H 105 113 387</b>
105114-3401	<b>H 105 114 368</b>

105114-3441	<b>H 105 114 344</b>
105114-3450	<b>F 01G 09X 06T</b>
105114-3451	<b>F 01G 09X 06T</b>
105114-3451	<b>H 105 114 345</b>
105114-3460	<b>H 105 114 346</b>

105114-3520	<b>H 105 114 352</b>
105114-3561	<b>H 105 114 356</b>
105114-3600	<b>F 01G 09X 076</b>
105114-5430	<b>H 105 114 543</b>
105115-3064	<b>F 01G 09X 05Y</b>

105115-3065	<b>F 01G 09X 05Y</b>
105115-3120	<b>F 01G 09X 06W</b>
105115-3121	<b>F 01G 09X 06W</b>
105115-5131	<b>H 105 115 518</b>
105118-4110	<b>9 430 612 390</b>

105118-4212	<b>9 430 610 126</b>
105118-4223	<b>9 430 612 402</b>
105118-4224	<b>9 430 613 671</b>
105118-4252	<b>9 430 612 409</b>
105118-4271	<b>9 430 612 412</b>

105118-4431	<b>9 430 612 436</b>
105118-4710	<b>9 430 612 474</b>
105118-4724	<b>9 430 612 478</b>
105118-5031	<b>9 430 612 516</b>
105118-5210	<b>9 430 612 541</b>

105118-5225	<b>9 430 612 545</b>
105118-5750	<b>9 430 612 603</b>
105118-6051	<b>9 430 610 152</b>
105118-6272	<b>9 430 613 596</b>
105118-6400	<b>9 430 610 163</b>

105118-6401	<b>9 430 613 689</b>
105118-6600	<b>9 430 612 681</b>
105118-6690	<b>9 430 610 184</b>
105118-6710	<b>9 430 612 692</b>
105118-6811	<b>9 430 613 697</b>

105118-6831	<b>9 430 613 447</b>
105118-6920	<b>9 430 613 530</b>
105118-6980	<b>9 430 613 575</b>
105118-7101	<b>9 430 612 703</b>
105118-7190	<b>9 430 612 716</b>

105118-7233	<b>9 430 613 634</b>
105118-7281	<b>9 430 610 167</b>
105118-7331	<b>9 430 610 193</b>
105118-7372	<b>9 430 613 603</b>
105118-7373	<b>9 430 613 958</b>

105118-7380	<b>9 430 610 198</b>
105118-7542	<b>9 430 613 635</b>
105118-7560	<b>9 430 613 108</b>
105118-7621	<b>9 430 613 869</b>
105118-7770	<b>9 430 610 236</b>

105118-7833	<b>9 430 613 745</b>
105118-7834	<b>9 430 613 989</b>
105118-7910	<b>9 430 612 757</b>
105118-7911	<b>9 430 613 608</b>
105118-7912	<b>F 01G 09X 003</b>

105118-7931	<b>9 430 613 206</b>
105118-7981	<b>9 430 613 871</b>
105118-7982	<b>F 01G 09X 03R</b>
105118-8021	<b>9 430 613 533</b>
105118-8022	<b>9 430 613 739</b>

105118-8060	<b>9 430 613 217</b>
105118-8133	<b>9 430 613 960</b>
105118-8151	<b>9 430 613 724</b>
105118-8180	<b>9 430 613 450</b>
105118-8212	<b>9 430 613 961</b>

105118-8220	<b>9 430 613 873</b>
105118-8280	<b>9 430 613 778</b>
105118-8291	<b>9 430 613 974</b>
105118-8303	<b>9 430 613 962</b>
105118-8310	<b>9 430 613 876</b>

105118-8362	<b>9 430 613 968</b>
105118-8371	<b>9 430 613 921</b>
105118-8372	<b>9 430 613 969</b>
105118-8381	<b>9 430 613 920</b>
105118-8390	<b>9 430 613 801</b>

105118-8391	<b>F 01G 09X 03S</b>
105118-8611	<b>F 01G 09X 05G</b>
105119-4211	<b>F 01G 09X 045</b>
105119-4270	<b>F 01G 09X 06V</b>
105119-4350	<b>F 01G 09X 06X</b>

105140-1021	<b>9 430 610 109</b>
105140-1070	<b>0 986 433 007</b>
105140-1070	<b>9 430 610 132</b>
105140-1191	<b>9 430 610 165</b>
105140-1290	<b>9 430 610 297</b>

105141-1792	<b>9 430 610 310</b>
105141-1961	<b>9 430 610 004</b>
105141-1981	<b>9 430 610 320</b>
105141-2001	<b>9 430 610 058</b>
105141-2061	<b>9 430 610 150</b>



105141-2080	<b>9 430 610 005</b>	105158-2162	<b>9 430 610 136</b>	107750-0120	<b>0 445 110 091</b>	107755-0220	<b>0 445 120 025</b>
105141-2122	<b>9 430 610 331</b>	105158-2171	<b>0 986 433 005</b>	107750-0120	<b>0 986 435 154</b>	107755-0220	<b>0 986 435 625</b>
105141-2130	<b>0 986 433 010</b>	105158-2171	<b>9 430 610 137</b>	107750-0151	<b>0 445 110 143</b>	107755-0230	<b>0 445 120 073</b>
105141-2130	<b>9 430 610 006</b>	105158-2224	<b>0 986 433 002</b>	107750-0152	<b>0 445 110 143</b>	107755-0230	<b>0 986 435 550</b>
105141-2240	<b>9 430 610 007</b>	105158-2225	<b>0 986 433 002</b>	107750-0222	<b>0 445 110 168</b>	107755-0240	<b>0 445 120 072</b>
105141-2391	<b>0 986 433 012</b>	105158-2225	<b>9 430 610 128</b>	107750-0260	<b>0 445 110 215</b>	107755-0250	<b>0 445 120 059</b>
105141-2440	<b>9 430 610 055</b>	105158-2234	<b>9 430 610 129</b>	107750-0261	<b>0 445 110 215</b>	107755-028	<b>0 445 120 080</b>
105141-2512	<b>0 986 433 006</b>	105158-2262	<b>0 986 433 000</b>	107750-0271	<b>0 445 110 214</b>	107755-0280	<b>0 445 120 080</b>
105141-2512	<b>9 430 610 033</b>	105158-2263	<b>0 986 433 000</b>	107750-0272	<b>0 445 110 214</b>	107755-0300	<b>0 445 120 091</b>
105141-2520	<b>9 430 610 358</b>	105158-2300	<b>0 986 433 001</b>	107750-0291	<b>0 445 110 227</b>	107755-0300	<b>0 986 435 635</b>
105141-2630	<b>9 430 610 054</b>	105158-2301	<b>0 986 433 001</b>	107750-0291	<b>0 986 435 177</b>	107755-0320	<b>0 445 120 093</b>
105141-2660	<b>0 986 433 011</b>	105158-2380	<b>9 430 610 505</b>	107750-0292	<b>F 01G 09P 218</b>	107755-0332	<b>0 445 120 095</b>
105141-2821	<b>0 986 433 013</b>	105158-5002	<b>F 01G 0V4 000</b>	107750-0320	<b>0 445 110 233</b>	107755-0332	<b>0 986 435 636</b>
105141-2870	<b>9 430 610 385</b>	105158-5012	<b>F 01G 0V4 001</b>	107750-0390	<b>0 445 110 236</b>	107755-0341	<b>0 445 120 090</b>
105141-2900	<b>9 430 610 388</b>	105158-5061	<b>F 01G 001 000</b>	107750-0390	<b>0 986 435 145</b>	107755-0341	<b>0 986 435 634</b>
105141-2950	<b>0 986 433 008</b>	105158-5080	<b>9 430 613 451</b>	107750-0500	<b>0 445 110 169</b>	107755-0350	<b>0 445 120 040</b>
105141-2950	<b>9 430 610 105</b>	105160-4041	<b>9 430 610 513</b>	107750-0510	<b>0 445 110 262</b>	107755-0360	<b>0 445 120 076</b>
105148-1002	<b>9 430 610 397</b>	105160-4051	<b>9 430 610 514</b>	107750-0511	<b>0 986 435 191</b>	107755-0380	<b>0 445 120 109</b>
105148-1012	<b>9 430 610 399</b>	105160-4061	<b>9 430 610 515</b>	107750-0581	<b>0 445 110 288</b>	107755-0380	<b>0 986 435 637</b>
105148-1112	<b>9 430 610 407</b>	105160-4100	<b>9 430 610 520</b>	107750-0600	<b>0 445 110 296</b>	107755-0400	<b>0 445 120 041</b>
105148-1120	<b>9 430 610 048</b>	105160-4170	<b>9 430 610 525</b>	107750-0610	<b>0 445 110 307</b>	107755-0420	<b>0 445 120 125</b>
105148-1150	<b>0 986 433 009</b>	105160-4292	<b>9 430 610 536</b>	107750-0610	<b>0 986 435 196</b>	107755-0430	<b>0 445 120 145</b>
105148-1150	<b>9 430 610 065</b>	105171-1361	<b>0 986 433 008</b>	107750-0630	<b>F 01G 09P 1XH</b>	107755-0440	<b>0 445 120 146</b>
105148-1151	<b>9 430 613 539</b>	105780-8140	<b>9 430 610 168</b>	107750-0630	<b>0 445 110 284</b>	107755-0450	<b>F 01G 09P 1XV</b>
105148-1170	<b>9 430 610 172</b>	105780-8180	<b>9 430 613 641</b>	107750-0630	<b>0 986 435 290</b>	107755-0460	<b>F 01G 09P 1XW</b>
105148-1183	<b>9 430 610 157</b>	105780-8190	<b>9 430 610 134</b>	107750-0640	<b>0 445 110 232</b>	109341-1020	<b>0 470 504 048</b>
105148-1221	<b>9 430 610 135</b>	105780-8310	<b>9 430 613 457</b>	107750-0650	<b>F 01G 09P 1XJ</b>	109342-4026	<b>9 443 611 856</b>
105148-1261	<b>9 430 610 125</b>	105780-8320	<b>9 430 613 755</b>	107750-0650	<b>0 445 110 315</b>	109342-4027	<b>9 443 615 728</b>
105148-1271	<b>9 430 610 416</b>	107714-0010	<b>0 445 020 010</b>	107750-0650	<b>0 986 435 291</b>	109962-0050	<b>F 01G 09P 1P1</b>
105148-1282	<b>9 430 610 154</b>	107716-0020	<b>0 445 020 012</b>	107750-0660	<b>0 445 116 006</b>	146019-2520	<b>9 460 610 208</b>
105148-1301	<b>9 430 610 420</b>	107716-1032	<b>F 01G 000 00V</b>	107755-0030	<b>0 445 120 006</b>	407709-0020	<b>0 444 010 007</b>
105148-1311	<b>9 430 610 179</b>	107722-0003	<b>0 445 010 047</b>	107755-0030	<b>0 986 435 632</b>	904740-0105	<b>F 01G 09W 0GV</b>
105148-1321	<b>9 430 610 422</b>	107722-0003	<b>0 445 010 113</b>	107755-0065	<b>0 445 120 006</b>	904741-4952	<b>F 01G 09W 0HB</b>
105148-1350	<b>9 430 610 426</b>	107722-0010	<b>0 445 010 039</b>	107755-0065	<b>0 986 435 632</b>	904760-7070	<b>F 01G 09W 0HF</b>
105148-1351	<b>F 01G 09X 06Z</b>	107722-0010	<b>0 986 437 317</b>	107755-0066	<b>0 445 120 006</b>	904761-4056	<b>F 01G 09W 0HE</b>
105148-1420	<b>9 430 610 170</b>	107722-0040	<b>0 445 010 086</b>	107755-0066	<b>0 986 435 632</b>	905101-7904	<b>F 01G 09X 079</b>
105148-1480	<b>9 430 610 158</b>	107722-0060	<b>0 445 010 106</b>	107755-0073	<b>0 986 435 525</b>	905101-8301	<b>F 01G 09X 078</b>
105148-1490	<b>9 430 610 159</b>	107722-0071	<b>0 445 010 105</b>	107755-0083	<b>0 986 435 531</b>	905101-8390	<b>F 01G 09P 29D</b>
105148-1500	<b>9 430 610 160</b>	107722-0071	<b>0 986 437 335</b>	107755-0090	<b>0 445 120 012</b>	905110-7891	<b>F 01G 09X 00G</b>
105148-1551	<b>9 430 610 442</b>	107722-0080	<b>0 986 437 348</b>	107755-0091	<b>0 445 120 012</b>	905110-8062	<b>F 01G 09X 06K</b>
105148-1644	<b>F 01G 09X 070</b>	107722-0090	<b>0 445 010 107</b>	107755-0091	<b>0 986 435 525</b>	905118-6641	<b>F 01G 09X 03W</b>
105148-1650	<b>9 430 613 543</b>	107722-0090	<b>0 986 437 385</b>	107755-0101	<b>0 445 120 016</b>	905118-7950	<b>F 01G 09X 00J</b>
105148-1672	<b>F 01G 09X 06L</b>	107722-0100	<b>0 445 010 134</b>	107755-0101	<b>0 986 435 531</b>	905118-8470	<b>F 01G 09X 07A</b>
105148-1680	<b>9 430 613 643</b>	107722-0100	<b>0 986 437 372</b>	107755-0151	<b>0 445 120 047</b>	907750-0650	<b>F 01G 09P 1XJ</b>
105148-1702	<b>F 01G 09X 06M</b>	107723-0010	<b>0 445 010 094</b>	107755-0161	<b>0 445 120 048</b>	909342-4027	<b>F 01G 09R 00Y</b>
105148-1722	<b>F 01G 09X 06N</b>	107723-0022	<b>0 445 020 027</b>	107755-0162	<b>0 445 120 048</b>	909342-4033	<b>F 01G 09R 00Z</b>
105148-1780	<b>F 01G 09X 041</b>	107723-0032	<b>0 445 020 028</b>	107755-0171	<b>0 445 120 049</b>	909342-4051	<b>F 01G 09R 00R</b>
105148-1822	<b>F 01G 09X 071</b>	107723-0040	<b>0 445 020 029</b>	107755-0172	<b>0 445 120 049</b>	980900-0029	<b>0 445 020 042</b>
105148-1840	<b>H 105 148 184</b>	107723-0080	<b>0 445 020 037</b>	107755-0180	<b>0 445 120 040</b>		
105151-1480	<b>9 430 610 456</b>	107740-0000	<b>0 445 010 136</b>	107755-0190	<b>0 445 120 041</b>		
105151-1530	<b>9 430 610 459</b>	107750-0002	<b>0 445 110 044</b>	107755-0200	<b>0 445 120 043</b>		
105158-2061	<b>0 986 433 005</b>	107750-0011	<b>0 445 110 062</b>	107755-0211	<b>0 445 120 058</b>		
105158-2081	<b>0 986 433 004</b>	107750-0031	<b>0 445 110 076</b>	107755-0211	<b>0 986 435 633</b>		
105158-2160	<b>0 986 433 004</b>	107750-0084	<b>0 445 110 085</b>	107755-0212	<b>0 445 120 058</b>		
105158-2162	<b>0 986 433 004</b>	107750-0100	<b>0 445 110 101</b>	107755-0212	<b>0 986 435 633</b>		



<b>24S</b>	24 Volt
<b>24Z</b>	Für Zylinder 2 - 4
<b>3T5</b>	Für Fahrzeuge mit 3,5 t zulässigem Gesamtgewicht
<b>4T5</b>	Für Fahrzeuge mit 4,5 t zulässigem Gesamtgewicht
<b>5PL</b>	Für Fahrzeuge mit Abgasnorm Euro 5 Plus
<b>6PL</b>	Für Fahrzeuge mit Abgasnorm Euro 6 Plus
<b>ABS</b>	Für Fahrzeuge mit ABS
<b>ABS</b>	Für Fahrzeuge ohne ABS
<b>AG</b>	Für Fahrzeuge mit automatischem Getriebe
<b>AGF</b>	Für Fahrzeuge mit Abgasentgiftung
<b>AGF</b>	Für Fahrzeuge ohne Abgasentgiftung
<b>AGR</b>	Abgasrückführung
<b>AGR</b>	Ohne Abgasrückführung
<b>ASB</b>	Anschluss beachten
<b>ATW</b>	Bei Bestellung beachten: in Düsenhalterkombination mit NBF (Nadelbewegungsfühler) ist Düsenwechsel nicht möglich. Eingebautes Erzeugnis muß am Fahrzeug oder Motor ermittelt werden.
<b>BG4</b>	Für Performance Paket
<b>BKN</b>	Bosch-Ausrüstung ohne Kaltstartanlage
<b>BO</b>	Bosch, nur als Ersatz für Bosch-Ausrüstung
<b>BOK</b>	Bosch-Ausrüstung mit Kaltstartanlage
<b>BOW</b>	Bosch, nur als Ersatz für Bosch-Ausrüstung, für Fahrzeuge mit Wegfahrsperr.
<b>BOW</b>	Bosch, nur als Ersatz für Bosch-Ausrüstung, für Fahrzeuge ohne Wegfahrsperr
<b>BS1</b>	Für BS 1 Applikation
<b>BS2</b>	Für BS 2 Applikation
<b>CAV</b>	Für CAV Erzeugnis
<b>CVT</b>	Für Fahrzeuge mit CVT-Getriebe
<b>CVT</b>	Nicht für Fahrzeuge mit CVT-Getriebe
<b>DBB</b>	Brennraumdichtring beige packt
<b>DBJ</b>	Brennraumdichtring am Injektor vormontiert
<b>DBJ</b>	Brennraumdichtring im Lieferumfang nicht enthalten
<b>DKF</b>	Zexel-Fertigung
<b>E93</b>	Für Abgasnorm EEC 93
<b>E96</b>	Für Abgasnorm EEC 96
<b>EC9</b>	Für Abgasnorm EEC 99
<b>EDC</b>	Elektronische Dieselregelung
<b>EE2</b>	Für Abgasnorm EEC 2000
<b>EFV</b>	Auch Ersatz für Vorgänger
<b>EFZ</b>	Ersatz für Fremderzeugnisse, satzweise auswechseln
<b>EQ0</b>	Für Pickup mit großer Doppelkabine (4-türig)
<b>ERL</b>	Für Fahrzeuge mit erhöhter Leistung
<b>EU2</b>	Für Fahrzeuge mit Abgasnorm Euro 2
<b>EU2</b>	Nicht für Abgasnorm Euro 2
<b>EU3</b>	Für Fahrzeuge mit Abgasnorm Euro 3
<b>EU3</b>	Nicht für Fahrzeuge mit Abgasnorm Euro 3
<b>EU4</b>	Für Fahrzeuge mit Abgasnorm Euro 4
<b>EU4</b>	Nicht für Fahrzeuge mit Abgasnorm Euro 4
<b>EU5</b>	Für Fahrzeuge mit Abgasnorm Euro 5
<b>EU5</b>	Nicht für Fahrzeuge mit Abgasnorm Euro 5
<b>EU6</b>	Für Fahrzeuge mit Abgasnorm Euro 6
<b>EU6</b>	Nicht für Fahrzeuge mit Abgasnorm Euro 6
<b>EXW</b>	Tausch der Exzenterwelle nur in Verbindung mit Zahnradpumpe 0 440 020 044
<b>FBH</b>	Für Betrieb in Höhenlagen
<b>FD3</b>	Für Abgasnorm D3
<b>FE2</b>	Für Euro 2/B-Motore
<b>FE2</b>	Nicht für Euro 2/B-Motore
<b>FKR</b>	Für Fahrzeuge mit kurzem Radstand
<b>FL5</b>	Für Abgasnorm L5
<b>FLR</b>	Für Fahrzeuge mit langem Radstand
<b>FMA</b>	Für Fahrzeuge ohne Airbag
<b>FWT</b>	Für Wärmetauscher
<b>GES</b>	Für Fahrzeuge mit Geschwindigkeitsregelanlage
<b>GES</b>	Für Fahrzeuge ohne Geschwindigkeitsregelanlage
<b>GNL</b>	Ausführung Green Line
<b>GS</b>	Für Fahrzeuge mit Handschaltgetriebe

<b>HAG</b>	Für Fahrzeuge mit halbautomatischem Getriebe
<b>HEF</b>	Für Fahrzeuge mit beheizbarer Frontscheibe
<b>HEF</b>	Für Fahrzeuge ohne beheizbare Frontscheibe
<b>HIW</b>	Straßenausführung
<b>I1B</b>	Für Injektor Klasse 1, mit Kennziffer 1 oder Farbkennzeichnung blau
<b>I2G</b>	Für Injektor Klasse 2, mit Kennziffer 2 oder Farbkennzeichnung grün
<b>I3K</b>	Für Injektor Klasse 3, mit Kennziffer 3
<b>KGL</b>	Nicht für Ausführung Green Line
<b>KKA</b>	Mit Kennzeichnung Klasse A
<b>KKB</b>	Mit Kennzeichnung Klasse B
<b>KKX</b>	Mit Kennzeichnung Klasse X
<b>KKY</b>	Mit Kennzeichnung Klasse Y
<b>KKZ</b>	Mit Kennzeichnung Klasse Z
<b>KL</b>	Für Fahrzeuge mit Klimaanlage
<b>KL</b>	Für Fahrzeuge ohne Klimaanlage
<b>KOB</b>	Für Kombiwagen
<b>KOC</b>	Reparaturanfragen: BDC/BDS, Neuteil: inquiry@de.bosch.com
<b>KSE</b>	Kaltstarteinrichtung eingebaut
<b>KZB</b>	Kennzeichen: blau
<b>KZE</b>	Kennzeichen: gelb
<b>KZG</b>	Kennzeichen: grün
<b>LAB</b>	Linksanbau
<b>LEN</b>	Für Motor mit Normalleistung
<b>LET</b>	Für Motor mit Niedrigleistung
<b>LLE</b>	Für Linkslenker
<b>LWG</b>	Für Lieferwagen
<b>MEB</b>	Mit Einspritzsystem Bosch
<b>MG5</b>	Für Fahrzeuge mit Handschaltgetriebe, 5 Gänge
<b>MG6</b>	Für Fahrzeuge mit Handschaltgetriebe, 6 Gänge
<b>MKO</b>	Für Fahrzeuge mit Klimaanlage, ohne Lenkhilfe
<b>MLK</b>	Für Fahrzeuge mit Lenkhilfe und Klimaanlage
<b>MLU</b>	Für Fahrzeuge mit Sekundärluftpumpe
<b>MPR</b>	Für Fahrzeuge mit Rußpartikelfilter
<b>MPR</b>	Für Fahrzeuge ohne Rußpartikelfilter
<b>MRQ</b>	Für Fahrzeuge mit Enddrehzahlregler RQ
<b>MVR</b>	Verstellregler, eingebaut
<b>N03</b>	Für Abgasnorm Euro 93 - CEE 19.5
<b>N05</b>	Für Abgasnorm Euro 96, CEE 95, L3
<b>N07</b>	Für Abgasnorm US 87
<b>N09</b>	Für Abgasnorm US 84 LDT
<b>N11</b>	Für Abgasnorm US 90 LDT
<b>N13</b>	Für Abgasnorm Euro 96
<b>N14</b>	Für Abgasnorm Euro 2000, CEE 2000
<b>N25</b>	Für Abgasnorm Euro 2005, EC 2005
<b>N25</b>	Nicht für Abgasnorm Euro 2005, EC 2005
<b>N39</b>	Für Abgasnorm Euro 93 - CEE 19.5 und US 84 LDT
<b>N5P</b>	Nicht für Fahrzeuge mit Abgasnorm Euro 5 Plus
<b>NC8</b>	Für Abgaswertecode NC8
<b>NC9</b>	Für Abgaswertecode NC9
<b>NL4</b>	Für Abgasnorm L4
<b>NOR</b>	Normale Ausführung
<b>NT5</b>	Für Abgaswertecode NT5
<b>OBD</b>	Für Fahrzeuge mit On-Board-Diagnose (OBD)
<b>ØBD</b>	Für Fahrzeuge ohne On-Board-Diagnose (OBD)
<b>OLK</b>	Für Fahrzeuge ohne Lenkhilfe und ohne Klimaanlage
<b>OWK</b>	Für Fahrzeuge ohne Wegfahrsperr, mit Klimaanlage
<b>OWO</b>	Für Fahrzeuge ohne Wegfahrsperr und ohne Klimaanlage
<b>RAB</b>	Rechtsanbau
<b>RAP</b>	Für RME (Rapsölmethylester) geeignet
<b>RAP</b>	Nicht für RME (Rapsölmethylester) geeignet
<b>RLE</b>	Für Rechtslenker
<b>RSA</b>	Farbkennzeichnung rosa
<b>SCJ</b>	Für Fahrzeuge mit SCR-Katalysator (Selective Catalytic Reduction)
<b>SGJ</b>	Für Fahrzeuge ohne SCR-Katalysator (Selective Catalytic Reduction)
<b>SDK</b>	Standardkabine

<b>SFU</b>	Steckfühler, einzeln
<b>SFZ</b>	Für Sonderfahrzeuge
<b>SLX</b>	Für Fahrzeuge mit SLX-Ausstattung
<b>SSJ</b>	Für Fahrzeuge mit Start-Stopp-Funktion
<b>SSJ</b>	Für Fahrzeuge ohne Start-Stopp-Funktion
<b>THD</b>	Nach Einbau muss das integrierte Steuergerät in einer Vertragswerkstatt des Fahrzeugherstellers programmiert werden.
<b>THI</b>	Nach Tausch von Pumpen-Steuergerät oder Einspritzpumpe muss die Wegfahrsperrung in einer Vertragswerkstatt des Fahrzeugherstellers aktiviert werden.
<b>THS</b>	Das Steuergerät muss nach dem Einbau der Einspritzpumpe, in einer Vertragswerkstatt des Fahrzeugherstellers programmiert werden.
<b>TIE</b>	Für Fahrzeuge mit Abgasnorm TIER 1
<b>TNK</b>	Zur eindeutigen Identifikation der Bosch-Nummer muß die Datenkarte des Fahrzeuges vorliegen. Die beim Erzeugnis aufgeführten Komponenten müssen mit denen in der Datenkarte übereinstimmen.
<b>TW</b>	Eingebautes Erzeugnis muss am Fahrzeug oder Motor ermittelt werden.
<b>ULE</b>	Für Fahrzeuge mit Abgasnorm ULEV (Ultra-Low Emission Vehicles)
<b>ULT</b>	Ausführung Ultra
<b>UPE</b>	Wird 0 928 400 527 als Ersatz von 0 928 400 314 eingebaut, muss das Steuergerät durch eine BMW-Werkstatt umprogrammiert werden.
<b>UV2</b>	Für Fahrzeuge mit Abgasnorm ULEV2 (Ultra-Low Emission Vehicles)
<b>V86</b>	Fahrgestell mit Fahrerhaus
<b>VAE</b>	Für Fahrzeuge mit verschärfter Abgasentgiftung
<b>VBS</b>	Achtung! Ersatz für Volvo Truck 0 444 022 069 (ohne Druckausgleichselement im Gehäusedeckel). Nach Einbau des neuen Fördermoduls muss das integrierte Steuergerät in einer Volvo Vertragswerkstatt programmiert werden.

<b>VGT</b>	VGT Motor
<b>VTF</b>	Achtung! Für Volvo Truck muss Gehäusedeckel F 00B H40 091 (ohne Druckausgleichselement) bestellt und das Fördermodul umgebaut werden. Nach Einbau des neuen Fördermoduls muss das integrierte Steuergerät in einer Vertragswerkstatt programmiert werden.
<b>WAS</b>	Mit Wasserabscheider
<b>WAS</b>	Ohne Wasserabscheider
<b>WEG</b>	Für Fahrzeuge mit Wegfahrsperrung
<b>WEG</b>	Für Fahrzeuge ohne Wegfahrsperrung
<b>WEI</b>	Farbkennzeichnung: weiß
<b>WEK</b>	Für Fahrzeuge mit Wegfahrsperrung und Klimaanlage
<b>WGT</b>	VGT Motor
<b>WOK</b>	Für Fahrzeuge mit Wegfahrsperrung, ohne Klimaanlage
<b>WW</b>	Wahlweise
<b>WZT</b>	Für Fahrzeuge mit Wegfahrsperrung, Freisaltung über Zündschlüssel (Transpondersystem)
<b>X10</b>	Für Zylinder 1
<b>X56</b>	Für Zylinder 2 - 6
<b>X96</b>	Abgasnorm TIER2
<b>XXX</b>	Lieferung nur solange Vorrat
<b>YE8</b>	Für Pickup mit Doppelkabine (4-türig)
<b>YK1</b>	Nicht für Performance Ausstattung
<b>Z25</b>	Nicht für Fahrzeuge mit Abgasnorm ULEV (Ultra Low Emission Vehicles)
<b>ZDA</b>	Ersatzteilliste auf ESPI-ZD (Zexel) Archiv verfügbar
<b>ZE</b>	Zwei erforderlich
<sup>1</sup>	Mit Nadelbewegungsfühler

	Information / Erläuterung
	Bestellnummer
	Pkw / Kleintransporter
	Nkw / Kleintransporter
	Land- oder Baumaschine
	Stationärmotor / Einbaumotor
	Hubraum in l
	Motorleistung in kW (PS)
	Motortyp
	Zylinderzahl

	Exportland
	Datum / Einbauzeitraum
	Sonderfälle
	Bosch-Austauschteil
	Düsenhalterkombination
	Common Rail injector
	Dichtscheibe
	Common Rail Hochdruckpumpe
	Verteilereinspritzpumpe VE und VR
	Luftmassenmesser



Unit Injection System UIS (Pumpe-Düse-Einheit)



Unit Pump System UPS



Denoxtronic-Fördermodul



Düsenhalter Typformel



Düse Typformel



Öffnungsdruck



Dichtring Zylinderkopf/Wärmeschutzscheibe DHK



DNOX Einspritzdüse



Dichtring Leckölanschluss DHK



Pumpe-Düse Einheit (PDE)



Düse



Wärmeschutz



Gegenüberstellung



Seitenverweis























DNOX Dosiermodul

<b>24S</b>	24 V	<b>GNL</b>	Model Green Line
<b>24Z</b>	For cylinders 2 - 4	<b>GS</b>	For vehicles with manual transmission
<b>3T5</b>	For vehicles with 3.5 t gross permissible weight	<b>HAG</b>	For vehicles with semi-automatic transmission
<b>4T5</b>	For vehicles with 4.5 t gross permissible weight	<b>HEF</b>	For vehicles with heated windshield
<b>5PL</b>	For vehicles with emission standard Euro 5 plus	<b>HEF</b>	For vehicles without heated windshield
<b>6PL</b>	For vehicles with emission standard Euro 6 plus	<b>HIW</b>	Road version
<b>ABS</b>	For vehicles with ABS	<b>I1B</b>	For injector class 1, with code number 1 or blue color coding
<b>ABS</b>	For vehicles without ABS	<b>I2G</b>	For injector class 2, with code number 2 or green color coding
<b>AG</b>	For vehicles with automatic transmission	<b>I3K</b>	For injector class 3, with code number 3
<b>AGF</b>	For vehicles with emission control	<b>KGL</b>	Not for model Green Line
<b>AGF</b>	For vehicles without emission control	<b>KKA</b>	With Class A marking
<b>AGR</b>	Exhaust-gas recirculation	<b>KKB</b>	With Class B marking
<b>AGR</b>	Without exhaust-gas recirculation	<b>KKX</b>	With class X marking
<b>ASB</b>	Note connection	<b>KKY</b>	With class Y marking
<b>ATW</b>	Note when ordering: Nozzle change not possible in nozzle and holder assembly with needle motion sensor. Product fitted must be determined on vehicle/engine.	<b>KKZ</b>	With class Z marking
<b>BG4</b>	With performance package	<b>KL</b>	For vehicles with air conditioner
<b>BKN</b>	Bosch equipment without cold starting system	<b>KL</b>	For vehicles without air conditioner
<b>BO</b>	Bosch, only as replacement for Bosch equipment	<b>KOB</b>	For station wagon
<b>BOK</b>	Bosch equipment with cold start system	<b>KOC</b>	On demand: Repair by BDC/BDS, New part: inquiry@de.bosch.com
<b>BOW</b>	Bosch, only as replacement for Bosch equipment, for vehicles with immobilizer	<b>KSE</b>	Cold start device fitted
<b>BOW</b>	Bosch, only as replacement for Bosch equipment, for vehicles without immobilizer	<b>KZB</b>	Identification: blue
<b>BS1</b>	For BS 1 application	<b>KZE</b>	Identification: yellow
<b>BS2</b>	For BS 2 application	<b>KZG</b>	Identification: green
<b>CAV</b>	For CAV unit	<b>LAB</b>	Left side mounting
<b>CVT</b>	For vehicles with CVT-gearbox	<b>LEN</b>	For engine with normal power
<b>CVT</b>	Not for vehicles with CVT-gearbox	<b>LET</b>	For engine with low power
<b>DBB</b>	Combustion chamber seal ring included	<b>LLE</b>	For LHD vehicles
<b>DBJ</b>	Combustion chamber seal ring pre-assembled at injector	<b>LWG</b>	For delivery van
<b>DBJ</b>	Combustion chamber seal ring not included in scope of delivery	<b>MEB</b>	With Bosch injection system
<b>DKF</b>	Zexel production	<b>MG5</b>	For vehicles with 5-speed manual transmission
<b>E93</b>	For emission standard EEC 93	<b>MG6</b>	For vehicles with 6-speed manual transmission
<b>E96</b>	For emission standard EEC 96	<b>MKO</b>	For vehicles with air conditioner, without power steering
<b>EC9</b>	For emission standard EEC 99	<b>MLK</b>	For vehicles with power steering and air conditioner
<b>EDC</b>	Electronic diesel control	<b>MLU</b>	For vehicles with secondary air pump
<b>EE2</b>	For emission standard EEC 2000	<b>MPR</b>	For vehicles with particulate filter
<b>EFV</b>	Also replacement for predecessor	<b>MPR</b>	For vehicles without particulate filter
<b>EFZ</b>	Replacement for non-Bosch products, replace as a set	<b>MRQ</b>	For vehicles with maximum speed governor RQ
<b>EQ0</b>	Extended crew cab pickup	<b>MVR</b>	Variable speed governor, flush mounted
<b>ERL</b>	For vehicles with increased power	<b>N03</b>	For emission standard Euro 93 - CEE 19.5
<b>EU2</b>	For vehicles with emission standard Euro 2	<b>N05</b>	For emission standard Euro 96, CEE 95, L3
<b>EU2</b>	Not for emission standard Euro 2	<b>N07</b>	For emission standard US 87
<b>EU3</b>	For vehicles with emission standard Euro 3	<b>N09</b>	For emission standard US 84 LDT
<b>EU3</b>	Not for vehicles with emission standard Euro 3	<b>N11</b>	For emission standard US 90 LDT
<b>EU4</b>	For vehicles with emission standard Euro 4	<b>N13</b>	For emission standard Euro 96
<b>EU4</b>	Not for vehicles with emission standard Euro 4	<b>N14</b>	For emission standard Euro 2000, CEE 2000
<b>EU5</b>	For vehicles with emission standard Euro 5	<b>N25</b>	For emission standard Euro 2005, EC 2005
<b>EU5</b>	Not for vehicles with emission standard Euro 5	<b>N26</b>	Not for emission standard Euro 2005, EC 2005
<b>EU6</b>	For vehicles with emission standard Euro 6	<b>N39</b>	For emission standard Euro 93 - CEE 19.5 and US 84 LDT
<b>EU6</b>	Not for vehicles with emission standard Euro 6	<b>N5P</b>	Not for vehicles with emission standard Euro 5 plus
<b>EXW</b>	Replacement of the eccentric shaft only in conjunction with gear pump 0 440 020 044	<b>NC8</b>	For emission value code NC8
<b>FBH</b>	For high altitude operation	<b>NC9</b>	For emission value code NC9
<b>FD3</b>	For emission standard D3	<b>NL4</b>	For emission standard L4
<b>FE2</b>	For Euro 2/B engines	<b>NOR</b>	Standard version
<b>FE2</b>	Not for Euro 2/B engines	<b>NT5</b>	For emission value code NT5
<b>FKR</b>	For vehicles with short wheelbase	<b>OBD</b>	For vehicles with on-board diagnosis (OBD)
<b>FL5</b>	For emission standard L5	<b>ØBD</b>	For vehicles without on-board diagnosis (OBD)
<b>FLR</b>	For vehicles with long wheelbase	<b>OLK</b>	For vehicles without power steering and without air conditioner
<b>FMA</b>	For vehicles without airbag	<b>OWK</b>	For vehicles without immobilizer, with air conditioner
<b>FWT</b>	For heat exchanger	<b>OWO</b>	For vehicles without immobilizer and without air conditioner
<b>GES</b>	For vehicles with cruise control system	<b>RAB</b>	Right side mounting
<b>GES</b>	For vehicles without cruise control system	<b>RAP</b>	Suitable for RME (rapeseed oil methyl ester)
		<b>RAP</b>	Not suitable for RME (rapeseed oil methyl ester)
		<b>RLE</b>	For RHD vehicles
		<b>RSA</b>	Color coding: Pink
		<b>SCJ</b>	For vehicles with SCR catalyst (Selective Catalytic Reduction)

<b>SGJ</b>	For vehicles without SCR catalyst (Selective Catalytic Reduction)
<b>SDK</b>	Standard cab
<b>SFU</b>	Plug-in sensor, single
<b>SFZ</b>	For special-purpose vehicles
<b>SLX</b>	For vehicles with SLX equipment
<b>SSJ</b>	For vehicles with Start-Stop function
<b>SSJ</b>	For vehicles without Start-Stop function
<b>THD</b>	After replacement, the integrated control unit needs to be programmed at a vehicle manufacturer's franchised workshop.
<b>THI</b>	After replacing pump control unit or injection pump, immobilizer must be activated at a vehicle manufacturer's franchised workshop.
<b>THS</b>	After installing the injection pump, the control unit must be programmed at a vehicle manufacturer's franchised workshop.
<b>TIE</b>	For vehicles with emission standard TIER 1
<b>TNK</b>	The vehicle data card is required for definite identification of the Bosch number. The components listed with the product must coincide with those on the data card.
<b>TW</b>	The product fitted must be identified on the vehicle or engine
<b>ULE</b>	With emission standard ULEV (Ultra Low Emission Vehicles) (Ultra-Low Emission Vehicles)
<b>ULT</b>	Model Ultra
<b>UPE</b>	If 0 928 400 527 is installed as replacement for 0 928 400 314, the control unit must be re-programmed at a BMW workshop
<b>UV2</b>	With emission standard ULEV2 (Ultra Low Emission Vehicles)
<b>V86</b>	Chassis Cab
<b>VAE</b>	For vehicles with more stringent emission control

<b>VBS</b>	Attention! Replacement for Volvo truck 0 444 022 069 (without pressure equalizing element in housing cover). After assembly of the new supply module the integrated control unit needs to be programmed in an authorized Volvo workshop.
<b>VGT</b>	VGT engine
<b>VTF</b>	Attention! For Volvo truck the housing cover F 00B H40 091 (w/o pressure element) needs to be ordered and module needs to be rebuilt. After assembly of the new supply module the integrated control unit needs to be programmed in an authorized workshop.
<b>WAS</b>	With water separator
<b>WAS</b>	Without water separator
<b>WEG</b>	For vehicles with immobilizer
<b>WEG</b>	For vehicles without immobilizer
<b>WEI</b>	Color coding: white
<b>WEK</b>	For vehicles with immobilizer and air conditioner
<b>WGT</b>	WGT engine
<b>WOK</b>	For vehicles with immobilizer, without air conditioner
<b>WW</b>	Optional
<b>WZT</b>	For vehicles with immobilizer, release via ignition key (transponder system)
<b>X10</b>	For cylinder 1
<b>X56</b>	For cylinders 2 - 6
<b>X96</b>	Emission standard TIER2
<b>XXX</b>	Available while stocks last
<b>YE8</b>	For crew cab pickup
<b>YK1</b>	Except performance package
<b>Z25</b>	Except ULEV (Ultra Low Emission Vehicles)
<b>ZDA</b>	Partlist available in ESPI-ZD (Zexel) archive
<b>ZE</b>	Two required
<b>1</b>	with needle travel sensor

	Information/Explanations
	Part number
	Passenger cars/Small vans
	Commercial vehicle / small transporter
	Agricultural machine / construction machine
	Statonary engine / built-in engine
	Piston displacement in l
	Engine power output in kW (HP)
	Engine type
	Number of cylinders

	Export market
	Date/ Production period
	Special case
	Bosch exchange part
	Nozzle-and-holder assembly
	Common Rail Injector
	Packing plate
	Common-Rail high-pressure pump
	Distributor pump VE and VR
	Air mass meter



Unit Injection System UIS



Unit pump system UPS



Denoxtronic delivery module



Nozzle-holder assembly type designation



Nozzle type designation



Opening pressure



Cylinder head/thermal protection disc DHK sealing ring



DNOX nozzle



DHK fuel leakage connection sealing ring



Unit Injector System (UIS)



Nozzle



Thermal protection



Cross-reference



Page reference



DNOX dosing module























<b>24S</b>	24 V
<b>24Z</b>	Pour cylindres 2 à 4
<b>3T5</b>	Pour les véhicules avec un PTAC de 3,5 t
<b>4T5</b>	Pour les véhicules avec un PTAC de 4,5 t
<b>5PL</b>	Pour véhicules avec norme antipollution Euro 5 Plus
<b>6PL</b>	Pour véhicules avec norme antipollution Euro 6 Plus
<b>ABS</b>	Pour véhicules avec ABS
<b>ABS</b>	Pour véhicules sans ABS
<b>AG</b>	Pour véhicules avec boîte automatique
<b>AGF</b>	Pour véhicules av. dépollution de l'échap.
<b>AGF</b>	Pour véhicules ss dépollution de l'échap.
<b>AGR</b>	Recyclage des gaz d'échappement
<b>AGR</b>	Sans recyclage des gaz d'échappement
<b>ASB</b>	Vérifier les connexions
<b>ATW</b>	Attention à la commande : l'injecteur de l'ensemble injecteur/porte-injecteur avec capteur de déplacement d'aiguille ne peut pas être remplacé. Le produit installé doit être déterminé sur le véhicule ou le moteur.
<b>BG4</b>	Pour Pack performance
<b>BKN</b>	Equipement Bosch sans dispositif de démarrage à froid
<b>BO</b>	Bosch, uniquement comme remplacement pour équipement Bosch
<b>BOK</b>	Equipement Bosch avec dispositif de démarrage à froid
<b>BOW</b>	Bosch, uniquement comme remplacement pour équipement Bosch, pour véhicules avec antidémarrage.
<b>BOW</b>	Bosch, uniquement comme remplacement pour équipement Bosch, pour véhicules sans antidémarrage
<b>BS1</b>	Pour application BS 1
<b>BS2</b>	Pour application BS 2
<b>CAV</b>	Pour produit CAV
<b>CVT</b>	Pour véhicules avec boîte CVT
<b>CVT</b>	Pas pour véhicules avec boîte CVT
<b>DBB</b>	Joint de chambre de combustion joint
<b>DBJ</b>	Joint de chambre de combustion prémonté sur l'injecteur
<b>DBJ</b>	Joint circulaire de chambre de combustion non compris dans la livraison
<b>DKF</b>	Fabrication "Zexel"
<b>E93</b>	Pour norme antipollution CEE 93
<b>E96</b>	Pour norme antipollution CEE 96
<b>EC9</b>	Pour norme antipollution CEE 99
<b>EDC</b>	Régulation électronique diesel
<b>EE2</b>	Pour norme antipollution CEE 2000
<b>EFV</b>	Remplacement aussi pour ancien modèle
<b>EFZ</b>	Remplacement pour produits d'autre marque, à remplacer par jeux
<b>EQ0</b>	Pour Pickup à grande double cabine (4 portes)
<b>ERL</b>	Pour véhicules à puissance accrue
<b>EU2</b>	Pour véhicules avec norme antipollution Euro 2
<b>EU2</b>	Pas pour norme antipollution Euro 2
<b>EU3</b>	Pour véhicules avec norme antipollution Euro 3
<b>EU3</b>	Pas pour les véhicules selon la norme antipollution Euro 3
<b>EU4</b>	Pour véhicules avec norme antipollution Euro 4
<b>EU4</b>	Pas pour les véhicules selon la norme antipollution Euro 4
<b>EU5</b>	Pour véhicules avec norme antipollution Euro 5
<b>EU5</b>	Pas pour les véhicules selon la norme antipollution Euro 5
<b>EU6</b>	Pour véhicules avec norme antipollution Euro 6
<b>EU6</b>	Pas pour les véhicules selon la norme antipollution Euro 6
<b>EXW</b>	Remplacement de l'arbre excentrique uniquement en liaison avec la pompe à engrenage 0 440 020 044
<b>FBH</b>	Adapté à un fonctionnement en altitude
<b>FD3</b>	Pour norme antipollution D3
<b>FE2</b>	Pour moteurs Euro 2/B
<b>FE2</b>	Pas pour moteurs Euro 2/B
<b>FKR</b>	Pour véhicules à empattement court
<b>FL5</b>	Pour norme antipollution L5
<b>FLR</b>	Pour véhicules à empattement long
<b>FMA</b>	Pour véhicules sans airbag
<b>FWT</b>	Pour échangeur de chaleur
<b>GES</b>	Pour véhicules avec régulateur de vitesse
<b>GES</b>	Pour véhicules sans régulateur de vitesse
<b>GNL</b>	Version Green Line
<b>GS</b>	Pour véhicules avec boîte manuelle
<b>HAG</b>	Pour véhicules avec boîte semi-automatique
<b>HEF</b>	Pour véhicules avec pare-brise chauffant
<b>HEF</b>	Pour véhicules sans pare-brise chauffant
<b>HIW</b>	Version route
<b>I1B</b>	Pour injecteur classe 1, avec code 1 ou code couleur bleu
<b>I2G</b>	Pour injecteur classe 2, avec code 2 ou code couleur vert
<b>I3K</b>	Pour injecteur classe 3, avec code 3
<b>KGL</b>	Pas pour la version Green Line
<b>KKA</b>	Avec désignation classe A
<b>KKB</b>	Avec désignation classe B
<b>KKX</b>	Avec désignation classe X
<b>KKY</b>	Avec désignation classe Y
<b>KKZ</b>	Avec désignation classe Z
<b>KL</b>	Pour véhicules avec climatiseur
<b>KL</b>	Pour véhicules sans climatiseur
<b>KOB</b>	Pour break
<b>KOC</b>	Demandes de réparation : BDC/BDS, Pièces neuves : inquiry@de.bosch.com
<b>KSE</b>	Avec dispositif de démarrage à froid
<b>KZB</b>	Identifiant : bleu
<b>KZE</b>	Identifiant : jaune
<b>KZG</b>	Identifiant : vert
<b>LAB</b>	Montage à gauche
<b>LEN</b>	Pour moteur de puissance normale
<b>LET</b>	Pour moteur de faible puissance
<b>LLE</b>	Pour véhicules avec direction à gauche
<b>LWG</b>	Pour fourgonnette
<b>MEB</b>	Avec système d'injection Bosch
<b>MG5</b>	Pour véhicules avec boîte manuelle, 5 rapports
<b>MG6</b>	Pour véhicules avec boîte manuelle, 6 rapports
<b>MKO</b>	Pour véhicules avec climatiseur, sans direction assistée
<b>MLK</b>	Pour véhicules avec direction assistée et climatiseur
<b>MLU</b>	Pour véhicules avec pompe à air secondaire
<b>MPR</b>	Pour véhicules avec filtre à particules
<b>MPR</b>	Pour véhicules sans filtre à particules
<b>MRQ</b>	Pour véhicules avec régulateur de vitesse maximale RQ
<b>MVR</b>	Avec régulateur toutes vitesses
<b>N03</b>	Pour norme antipollution Euro 93 - CEE 19.5
<b>N05</b>	Pour norme antipollution Euro 96, CEE 95, L3
<b>N07</b>	Pour norme antipollution US 87
<b>N09</b>	Pour norme antipollution US 84 LDT
<b>N11</b>	Pour norme antipollution US 90 LDT
<b>N13</b>	Pour norme antipollution Euro 96
<b>N14</b>	Pour norme antipollution Euro 2000, CEE 2000
<b>N25</b>	Pour norme antipollution Euro 2005, CE 2005
<b>N25</b>	Pas pour la norme antipollution Euro 2005, CE 2005
<b>N39</b>	Pour norme antipollution Euro 93 - CEE 19.5 et US 84 LDT
<b>N5P</b>	Pas pour véhicules avec norme antipollution Euro 5 Plus
<b>NC8</b>	Pour code d'émission NC8
<b>NC9</b>	Pour code d'émission NC9
<b>NL4</b>	Pour norme antipollution L4
<b>NOR</b>	Version standard
<b>NT5</b>	Pour code d'émission NT5
<b>OBD</b>	Pour véhicules avec diagnostic embarqué (OBD)
<b>OBD</b>	Pour véhicules sans diagnostic embarqué (OBD)
<b>OLK</b>	Pour véhicules sans direction assistée ni climatiseur
<b>OWK</b>	Pour véhicules sans antidémarrage, avec climatiseur
<b>OWO</b>	Pour véhicules sans antidémarrage ni climatiseur
<b>RAB</b>	Montage à droite
<b>RAP</b>	Adapté RME (Esther méthylique huile végétale)
<b>RAP</b>	Non adapté RME (Esther méthyle huile végétale)
<b>RLE</b>	Pour véhicules avec direction à droite
<b>RSA</b>	Code couleur rose

<b>SCJ</b>	Pour véhicules avec catalyseur SCR (Selective Catalytic Reduction)
<b>SGJ</b>	Pour véhicules sans catalyseur SCR (Selective Catalytic Reduction)
<b>SDK</b>	Cabine standard
<b>SFU</b>	Capteur enfichable, séparé
<b>SFZ</b>	Pour véhicules spéciaux
<b>SLX</b>	Pour véhicules avec équipement SLX
<b>SSJ</b>	Pour véhicules avec fonction démarrage-arrêt
<b>SSJ</b>	Pour véhicules sans fonction démarrage-arrêt
<b>THD</b>	Après le montage, la centrale de commande intégrée doit être programmée chez un concessionnaire du constructeur.
<b>THI</b>	Après le remplacement de la centrale de commande de la pompe ou de la pompe d'injection, l'antidémarrage doit être activé chez un concessionnaire du constructeur.
<b>THS</b>	La centrale de commande doit être programmée chez un concessionnaire du constructeur après la pose de la pompe d'injection.
<b>TIE</b>	Pour véhicules avec norme antipollution TIER 1
<b>TNK</b>	Vous devez disposer de la carte signalétique du véhicule pour l'identification exacte de la référence Bosch. Les composants énumérés pour le produit doivent correspondre à ceux de la carte signalétique.
<b>TW</b>	Le produit monté doit être déterminé sur le véhicule ou le moteur.
<b>ULE</b>	Pour véhicules avec norme antipollution ULEV (Ultra-Low Emission Vehicles)
<b>ULT</b>	Version Ultra
<b>UPE</b>	Si 0 928 400 527 est monté en remplacement de 0 928 400 314, La centrale de cde doit être reprogrammée par un atelier BMW.
<b>UV2</b>	Pour véhicules avec norme antipollution ULEV2 (Ultra-Low Emission Vehicles)
<b>V86</b>	Châssis avec cabine
<b>VAE</b>	Pour véhicules avec dépollution accrue de l'échappement
<b>VBS</b>	Attention ! Remplacement pour Volvo Truck 0 444 022 069 (sans élément compensateur de pression dans le couvercle du boîtier). Après le montage du nouveau module d'alimentation, la centrale de commande intégrée doit être programmée dans un atelier agréé Volvo.

<b>VGT</b>	Moteur VGT
<b>VTF</b>	Attention ! Pour Volvo Truck le couvercle de carter F00B H40 091 (sans élément de compensation de pression) doit être commandé et le module de transport transformé. Après l'installation du nouveau module de transport, la centrale de commande intégrée doit être programmée dans un atelier contractuel.
<b>WAS</b>	Avec séparateur d'eau
<b>WAS</b>	Sans séparateur d'eau
<b>WEG</b>	Pour véhicules avec antidémarrage
<b>WEG</b>	Pour véhicules sans antidémarrage
<b>WEI</b>	Code couleur : blanc
<b>WEK</b>	Pour véhicules avec antidémarrage et climatiseur
<b>WGT</b>	Moteur WGT
<b>WOK</b>	Pour véhicules avec antidémarrage, sans climatiseur
<b>WW</b>	Au choix
<b>WZT</b>	Pour véhicules avec antidémarrage, activation avec la clé de contact (système à transpondeur)
<b>X10</b>	Pour cylindre 1
<b>X56</b>	Pour cylindres 2 à 6
<b>X96</b>	Norme d'échappement TIER2
<b>XXX</b>	Dans la limite des stocks disponibles
<b>YE8</b>	Pour véhicules à double cabine (4 portes)
<b>YK1</b>	Pas pour équipement Performance
<b>Z25</b>	Pas pour véhicules avec norme antipollution ULEV (Ultra-Low Emission Vehicles)
<b>ZDA</b>	Liste de pièces détachées sur ESPI-ZD (Zexel) Archive disponible
<b>ZE</b>	2 nécessaires
<sup>1</sup>	Avec capteur de déplacement d'aiguille

	Information / explication
	Référence
	Voiture particulière / véhicule utilitaire léger
	Véhicule utilitaire / Fourgonnette
	Machine agricole ou machine de travaux publics
	Moteur stationnaire / moteur incorporé
	Cylindrée en l
	Puissance du moteur en kW (ch)
	Type de moteur

	Nombre de cylindres
	Pays d'exportation
	Date/période de montage
	Cas spécial
	Pièce d'échange standard Bosch
	Ensemble injecteur/porte-injecteur
	Injecteur Common Rail
	Joint
	Pompe haute pression Common Rail





Pompe d'injection distributrice VE et VR



Débitmètre d'air massique



Unit Injection System UIS (système inject.-pompe)



Unit Pump System UPS



Module d'alimentation Denoxtronic



Porte-injecteur réf. alphanumérique



Injecteur réf. alphanumérique



Pression d'ouverture



Injecteur DNOX



Joint circulaire culasse/rondelle calorifuge DHK



Joint circulaire raccord d'huile de fuite DHK



Unité pompe-injecteur



Injecteur



Protection thermique



Comparaison



Renvoi à la page











Module de dosage DNOX

<b>24S</b>	24 Volt
<b>24Z</b>	Per cilindri 2- 4
<b>3T5</b>	Per veicoli con peso massimo complessivo ammesso di 3,5 t
<b>4T5</b>	Per veicoli con peso massimo complessivo ammesso di 4,5 t
<b>5PL</b>	Per veicoli con norma sui gas di scarico Euro 5 Plus
<b>6PL</b>	Per veicoli con norma sui gas di scarico Euro 6 Plus
<b>ABS</b>	Per veicoli con ABS
<b>ABS</b>	Per veicoli senza ABS
<b>AG</b>	Per veicoli con cambio automatico
<b>AGF</b>	Per veicoli con depurazione dei gas di scarico
<b>AGF</b>	Per veicoli senza depurazione dei gas di scarico
<b>AGR</b>	Ricircolo gas di scarico
<b>AGR</b>	Senza ricircolo dei gas di scarico
<b>ASB</b>	Prestare attenzione alla connessione
<b>ATW</b>	Da considerare al momento dell'ordinazione: nel gruppo portapolverizzatore completo, dotato di sensore spostamento ago non è possibile sostituire il polverizzatore. Il prodotto installato deve essere verificato sul veicolo/motore.
<b>BG4</b>	Per Performance Paket
<b>BKN</b>	Equipaggiamento Bosch senza dispositivo per avviamento a freddo
<b>BO</b>	Solo come ricambio per l'equipaggiamento Bosch
<b>BOK</b>	Equipaggiamento Bosch con dispositivo di avviamento a freddo
<b>BOW</b>	Bosch, solo come ricambio dell'equipaggiamento Bosch, per veicoli con immobilizzatore.
<b>BOW</b>	Bosch, solo come ricambio per equipaggiamento Bosch, per veicoli senza immobilizzatore
<b>BS1</b>	Per applicazione BS 1
<b>BS2</b>	Per applicazione BS 2
<b>CAV</b>	Per prodotti CAV
<b>CVT</b>	Per veicoli con cambio CVT
<b>CVT</b>	Non per veicoli con cambio CVT
<b>DBB</b>	Anello di tenuta camera di combustione accluso
<b>DBJ</b>	Anello di tenuta camera di combustione premontato sull'iniettore
<b>DBJ</b>	Anello di tenuta camera di combustione non compreso nel volume di fornitura
<b>DKF</b>	Fabbricazione "Zexel"
<b>E93</b>	Per norma sui gas di scarico EEC 93
<b>E96</b>	Per norma sui gas di scarico EEC 96
<b>EC9</b>	Per norma sui gas di scarico EEC 99
<b>EDC</b>	Regolazione elettronica, diesel
<b>EE2</b>	Per norma gas di scarico EEC 2000
<b>EFV</b>	Ricambio anche per il modello precedente
<b>EFZ</b>	Ricambio per prodotti esterni, sostituire a gruppi
<b>EQ0</b>	Per pickup con cabina doppia grande (4 porte)
<b>ERL</b>	Per veicoli con potenza superiore
<b>EU2</b>	Per veicoli con norma sui gas di scarico Euro 2
<b>EU2</b>	Non per norma sui gas di scarico Euro 2
<b>EU3</b>	Per veicoli con norma sui gas di scarico Euro 3
<b>EU3</b>	Non per veicoli con norma sui gas di scarico Euro 3
<b>EU4</b>	Per veicoli con norma sui gas di scarico Euro 4
<b>EU4</b>	Non per veicoli con norma sui gas di scarico Euro 4
<b>EU5</b>	Per veicoli con norma sui gas di scarico Euro 5
<b>EU5</b>	Non per veicoli con norma sui gas di scarico Euro 5
<b>EU6</b>	Per veicoli con norma sui gas di scarico Euro 6
<b>EU6</b>	Non per veicoli con norma sui gas di scarico Euro 6
<b>EXW</b>	Sostituzione dell'albero eccentrico solo in combinazione con la pompa ad ingranaggi 0 440 020 044
<b>FBH</b>	Per uso in alta quota
<b>FD3</b>	Per norma gas di scarico D3
<b>FE2</b>	Per Euro 2/B-Motore
<b>FE2</b>	Non per Euro 2/B-Motore
<b>FKR</b>	Per veicoli a passo corto
<b>FL5</b>	Per norma gas di scarico L5
<b>FLR</b>	Per veicoli a passo lungo
<b>FMA</b>	Per veicoli senza airbag
<b>FWT</b>	Per scambiatore di calore
<b>GES</b>	Per veicoli con impianto di regolazione velocità
<b>GES</b>	Per veicoli senza impianto di regolazione velocità
<b>GNL</b>	Versione Green Line
<b>GS</b>	Per veicoli con cambio meccanico
<b>HAG</b>	Per veicoli con cambio semiautomatico
<b>HEF</b>	Per veicoli con parabrezza termico
<b>HEF</b>	Per veicoli senza parabrezza riscaldabile
<b>HIW</b>	Versione per strada
<b>I1B</b>	Per iniettore classe 1, con numero identificativo 1 o colore distintivo blu
<b>I2G</b>	Per iniettore classe 2, con numero identificativo 2 o colore distintivo verde
<b>I3K</b>	Per iniettore classe 3, con numero identificativo 3
<b>KGL</b>	Non per esecuzione Green Line
<b>KKA</b>	Con sigla classe A
<b>KKB</b>	Con sigla classe B
<b>KKX</b>	Con sigla classe X
<b>KKY</b>	Con sigla classe Y
<b>KKZ</b>	Con sigla classe Z
<b>KL</b>	Per veicoli con climatizzatore
<b>KL</b>	Per veicoli senza climatizzatore
<b>KOB</b>	Per station wagon
<b>KOC</b>	Richiesta riparazione: BDC/BDS, componenti nuovi: inquiry@de.bosch.com
<b>KSE</b>	Con dispositivo per avviamento a freddo incorporato
<b>KZB</b>	Contrassegno: blu
<b>KZE</b>	Contrassegno: giallo
<b>KZG</b>	Contrassegno: verde
<b>LAB</b>	Montaggio a sinistra
<b>LEN</b>	Per motore con prestazioni normali
<b>LET</b>	Per motore con prestazioni ridotte
<b>LLE</b>	Per guida a sinistra
<b>LWG</b>	Per furgone per consegne
<b>MEB</b>	Con sistema di iniezione Bosch
<b>MG5</b>	Per veicoli con cambio meccanico a 5 marce
<b>MG6</b>	Per veicoli con cambio meccanico a 6 marce
<b>MKO</b>	Per veicoli con climatizzatore, senza servosterzo
<b>MLK</b>	Per veicoli con servosterzo e climatizzatore
<b>MLU</b>	Per veicoli con pompa aria secondaria
<b>MPR</b>	Per veicoli con filtro antiparticolato
<b>MPR</b>	Per veicoli senza filtro antiparticolato
<b>MRQ</b>	Per veicoli con regolatore del numero di giri massimo RQ
<b>MVR</b>	Con regolatore d'anticipo integrato
<b>N03</b>	Per norma gas di scarico Euro 93 - CEE 19.5
<b>N05</b>	Per norma gas di scarico Euro 96, CEE 95, L3
<b>N07</b>	Per norma gas di scarico US 87
<b>N09</b>	Per norma gas di scarico US 84 LDT
<b>N11</b>	Per norma gas di scarico US 90 LDT
<b>N13</b>	Per norma gas di scarico Euro 96
<b>N14</b>	Per norma gas di scarico Euro 2000, CEE 2000
<b>N25</b>	Per norma gas di scarico Euro 2005, EC 2005
<b>N25</b>	Non per norma gas di scarico Euro 2005, EC 2005
<b>N39</b>	Per norma gas di scarico Euro 93 - CEE 19.5 e US 84 LDT
<b>N5P</b>	Non per veicoli con norma sui gas di scarico Euro 5 Plus
<b>NC8</b>	Per codice valori gas di scarico NC8
<b>NC9</b>	Per codice valori gas di scarico NC9
<b>NL4</b>	Per norma gas di scarico L4
<b>NOR</b>	Versione normale
<b>NT5</b>	Per codice valori gas di scarico NT5
<b>OBD</b>	Per veicoli con diagnosi On-Board (OBD)
<b>OBD</b>	Per veicoli senza diagnosi On-Board (OBD)
<b>OLK</b>	Per veicoli senza servosterzo e senza climatizzatore
<b>OWK</b>	Per veicoli senza immobilizzatore, con climatizzatore
<b>OWO</b>	Per veicoli senza immobilizzatore e senza climatizzatore
<b>RAB</b>	Montaggio a destra
<b>RAP</b>	Idoneo per RME (metilestere di colza)
<b>RAP</b>	Non indicato per RME (metilestere di colza)
<b>RLE</b>	Per guida a destra
<b>RSA</b>	Contrassegno colorato rosa

<b>SCJ</b>	Per veicoli con catalizzatore SCR (Selective Catalytic Reduction)
<b>SGJ</b>	Per veicoli senza catalizzatore SCR (Selective Catalytic Reduction)
<b>SDK</b>	Cabina standard
<b>SFU</b>	Sensore ad innesto, singolo
<b>SFZ</b>	Per veicoli speciali
<b>SLX</b>	Per veicoli con equipaggiamento SLX
<b>SSJ</b>	Per veicoli con funzione di avviamento/arresto
<b>SSJ</b>	Per veicoli senza funzione di avviamento/arresto
<b>THD</b>	Dopo il montaggio la centralina integrata deve essere programmata in un'officina autorizzata del costruttore del veicolo.
<b>THI</b>	Dopo la sostituzione della centralina pompa o della pompa di iniezione è necessario attivare l'immobilizzatore in un'officina autorizzata del costruttore del veicolo.
<b>THS</b>	Dopo il montaggio della pompa di iniezione la centralina deve essere programmata in un'officina autorizzata del costruttore del veicolo.
<b>TIE</b>	Per veicoli con norma sui gas di scarico TIER 1
<b>TNK</b>	Per un'identificazione sicura del numero Bosch deve essere disponibile la scheda dati del veicolo. I componenti riportati sul prodotto devono coincidere con quelli nella scheda dati.
<b>TW</b>	Il prodotto montato deve essere rilevato sul veicolo o sul motore.
<b>ULE</b>	Per veicoli con norma gas di scarico ULEV (Ultra Low Emission Vehicles)
<b>ULT</b>	Versione Ultra
<b>UPE</b>	Se viene montato 0 928 400 527 in sostituzione di 0 928 400 314, la centralina deve essere riprogrammata da un'officina BMW.
<b>UV2</b>	Per veicoli con norma gas di scarico ULEV2 (Ultra Low Emission Vehicles)
<b>V86</b>	Autotelaio con cabina di guida
<b>VAE</b>	Per veicoli con depurazione dei gas di scarico potenziata

<b>VBS</b>	Attenzione! Ricambio per Volvo Truck 0 444 022 069 (senza elemento di compensazione pressione nel coperchio della scatola). Dopo il montaggio del nuovo modulo alimentazione, la centralina integrata deve essere programmata in un'officina autorizzata Volvo.
<b>VGT</b>	Motore VGT
<b>VTF</b>	Attenzione! Per Volvo Truck occorre ordinare il coperchio della scatola F 00B H40 091 (senza elemento di compensazione pressione) e montare il modulo alimentazione. Dopo il montaggio del nuovo modulo di alimentazione, la centralina integrata deve essere programmata in un'officina autorizzata.
<b>WAS</b>	Con separatore acqua
<b>WAS</b>	Senza separatore acqua
<b>WEG</b>	Per veicoli con immobilizzatore
<b>WEG</b>	Per veicoli senza immobilizzatore
<b>WEI</b>	Contrassegno colorato: bianco
<b>WEK</b>	Per veicoli con immobilizzatore e climatizzatore
<b>WGT</b>	Motore WGT
<b>WOK</b>	Per veicoli con immobilizzatore, senza climatizzatore
<b>WW</b>	A scelta
<b>WZT</b>	Per veicoli con immobilizzatore, abilitabile tramite chiave di accensione (sistema Transponder)
<b>X10</b>	Per cilindro 1
<b>X56</b>	Per cilindri 2 - 6
<b>X96</b>	Norma gas di scarico TIER2
<b>XXX</b>	Consegna solo fino ad esaurimento scorte
<b>YE8</b>	Per pickup con cabina doppia (4 porte)
<b>YK1</b>	Non per equipaggiamento Performance
<b>Z25</b>	Non per veicoli con norma gas di scarico ULEV (Ultra Low Emission Vehicles)
<b>ZDA</b>	Elenco dei pezzi di ricambio disponibile in archivio ESPI-ZD (Zexel)
<b>ZE</b>	Sono necessari due pezzi
<b>1</b>	Con sensore movimento ago

	Informazione / dichiarazione
	Numero di ordinazione
	Autovettura / furgone
	Veicoli commerciali / camioncini
	Trattore o macchina per l'edilizia
	Motore stazionario / motore incorporato
	Cilindrata in l
	Potenza motore in kW (CV)
	Tipo motore

	Numero cilindri
	Paese d'esportazione
	Data/Periodo di montaggio
	Caso specifico
	Componente revisionato Bosch
	Combinazione portapolverizzatori
	Common Rail Injector
	Rondella di tenuta
	Pompa alta pressione Common Rail



Pompa iniezione rotativa VE e VR



Misuratore della massa d'aria



Unit Injection System UIS (unità pompa-iniettore)



Unit Pump System UPS



Modulo di alimentazione Denoxtronic



Portapolverizzatore formula tipo



Polverizzatore formula tipo



Pressione di apertura



Iniettore DNOX



Anello di tenuta testata/rondella termoisolante DHK



Anello di tenuta raccordo carburante di recupero DHK



Unità pompa-iniettore (PDE)



Polverizzatore



Protezione termica



Confronto



Rimando ad un'altra pagina



Modulo di dosaggio DNOX





















<b>24S</b>	24 voltios
<b>24Z</b>	Para cilindro 2 - 4
<b>3T5</b>	Para vehículos con un peso total admisible de 3,5 t
<b>4T5</b>	Para vehículos con un peso total admisible de 4,5 t
<b>5PL</b>	Para vehículos con norma de gases de escape Euro 5 Plus
<b>6PL</b>	Para vehículos con norma de gases de escape Euro 6 Plus
<b>ABS</b>	Para vehículos con ABS
<b>ABS</b>	Para vehículos sin ABS
<b>AG</b>	Para vehículos con cambio automático
<b>AGF</b>	Para vehículos con desintoxicación de gases de escape
<b>AGF</b>	Para vehículos sin desintoxicación de gases de escape
<b>AGR</b>	Retroalimentación de gases de escape
<b>AGR</b>	Sin retroalimentación de gases de escape
<b>ASB</b>	Observar la conexión
<b>ATW</b>	En el conjunto inyector con detector de movimientos de aguja no es posible el cambio de inyector. Tenerlo en cuenta al cursar el pedido. El producto instalado tiene que averiguarse en el vehículo/motor.
<b>BG4</b>	Para paquete Performance
<b>BKN</b>	Equipamiento Bosch sin dispositivo de arranque en frío
<b>BO</b>	Bosch, sólo como producto de sustitución para el equipo Bosch
<b>BOK</b>	Equipo Bosch con dispositivo de arranque en frío
<b>BOW</b>	Bosch, sólo como producto de sustitución para el equipo Bosch, para vehículos con dispositivo electrónico de inmovilización.
<b>BOW</b>	Bosch, sólo como repuesto para equipo Bosch, para vehículos sin inmovilizador electrónico
<b>BS1</b>	Para BS 1, aplicación
<b>BS2</b>	Para BS 2, aplicación
<b>CAV</b>	Para productos CAV
<b>CVT</b>	Para vehículos con caja de cambios CVT
<b>CVT</b>	No para vehículos con caja de cambios CVT
<b>DBB</b>	Junta de cámara de combustión adjunta
<b>DBJ</b>	Junta de cámara de combustión premontada en inyector
<b>DBJ</b>	Junta anular de cámara de combustión no contenida en volumen de suministro
<b>DKF</b>	Fabricación ""Zexel""
<b>E93</b>	Para norma de gases de escape EEC 93
<b>E96</b>	Para norma de gases de escape EEC 96
<b>EC9</b>	Para norma de gases de escape EEC 99
<b>EDC</b>	Regulación electrónica diesel
<b>EE2</b>	Para norma de gases de escape EEC 2000
<b>EFV</b>	También sustitución del anterior
<b>EFZ</b>	Recambio para productos independientes, sustituir por conjuntos
<b>EQ0</b>	Para camioneta con cabina doble, (4 puertas)
<b>ERL</b>	Para vehículos con carga útil elevada
<b>EU2</b>	Para vehículos con norma de gases de escape EURO 2
<b>EU2</b>	No para norma de gases de escape Euro 2
<b>EU3</b>	Para vehículos con norma de gases de escape EURO 3
<b>EU3</b>	No para vehículos con norma de gases de escape Euro 3
<b>EU4</b>	Para vehículos con norma de gases de escape Euro 4
<b>EU4</b>	No para vehículos con norma de gases de escape Euro 4
<b>EU5</b>	Para vehículos con norma de gases de escape EURO 5
<b>EU5</b>	No para vehículos con norma de gases de escape Euro 5
<b>EU6</b>	Para vehículos con norma de gases de escape EURO 6
<b>EU6</b>	No para vehículos con norma de gases de escape Euro 6
<b>EXW</b>	Sustitución del árbol excéntrico sólo en combinación con la bomba de engranajes 0 440 020 044
<b>FBH</b>	Para uso en sitios altos
<b>FD3</b>	Para norma de gases de escape D3
<b>FE2</b>	Para Euro 2/Motores B
<b>FE2</b>	No para Euro 2/Motores B
<b>FKR</b>	Para vehículos con corta distancia entre ejes
<b>FL5</b>	Para norma de gases de escape L5
<b>FLR</b>	Para vehículos con larga distancia entre ejes
<b>FMA</b>	Para vehículos sin airbag
<b>FWT</b>	Para intercambiador de calor
<b>GES</b>	Para vehículos con sistema regulador de la velocidad
<b>GES</b>	Para vehículos sin instalación reguladora de velocidad
<b>GNL</b>	Ejecución Green Line
<b>GS</b>	Para vehículos con cambio manual
<b>HAG</b>	Para vehículos con cambio semiautomático
<b>HEF</b>	Para vehículos con parabrisas calefactable
<b>HEF</b>	Para vehículos sin parabrisas calefactable
<b>HIW</b>	Versión de carretera
<b>I1B</b>	Para clase de inyector 1, con cifra clave 1 ó marca de color azul
<b>I2G</b>	Para clase de inyector 2, con cifra clave 2 ó marca de color verde
<b>I3K</b>	Para clase de inyector 3, con cifra clave 3
<b>KGL</b>	No para ejecución Green Line
<b>KKA</b>	Con identificación clase A
<b>KKB</b>	Con identificación clase B
<b>KKX</b>	Con identificación clase X
<b>KKY</b>	Con identificación clase Y
<b>KKZ</b>	Con identificación clase Z
<b>KL</b>	Para vehículos con acondicionador de aire
<b>KL</b>	Para vehículos sin acondicionador de aire
<b>KOB</b>	Para vehículos combinados
<b>KOC</b>	Consultas de reparación: BDC/BDS, piezas nuevas: inquiry@de.bosch.com
<b>KSE</b>	Dispositivo de arranque en frío incorporado
<b>KZB</b>	Distintivo característico de color: azul
<b>KZE</b>	Distintivo característico: amarillo
<b>KZG</b>	Distintivo característico: verde
<b>LAB</b>	Montaje a la izquierda
<b>LEN</b>	Para motor con potencia normal
<b>LET</b>	Para motor de baja potencia
<b>LLE</b>	Para dirección a la izquierda
<b>LWG</b>	Para vehículos de reparto
<b>MEB</b>	Con sistema de inyección Bosch
<b>MG5</b>	Para vehículos con cambio manual, 5 marchas
<b>MG6</b>	Para vehículos con cambio manual, 6 marchas
<b>MKO</b>	Para vehículos con acondicionador de aire sin servodirección
<b>MLK</b>	Para vehículos con servodirección y con acondicionador de aire
<b>MLU</b>	Para vehículos con bomba de aire secundario
<b>MPR</b>	Para vehículos con filtro de partículas de hollín
<b>MPR</b>	Para vehículos sin filtro de partículas de hollín
<b>MRQ</b>	Para vehículos con regulador del número final de revoluciones RQ
<b>MVR</b>	Con regulador de ajuste, incorporado
<b>N03</b>	Para norma de gases de escape Euro 93 - CEE 19.5
<b>N05</b>	Para norma de gases de escape Euro 96, CEE 95, L3
<b>N07</b>	Para norma de gases de escape US 87
<b>N09</b>	Para norma de gases de escape US 84 LDT
<b>N11</b>	Para norma de gases de escape US 90 LDT
<b>N13</b>	Para norma de gases de escape EURO 96
<b>N14</b>	Para norma de gases de escape Euro 2000, CEE 2000
<b>N25</b>	Para norma de gases de escape Euro 2005, EC 2005
<b>N25</b>	No para norma de gases de escape Euro 2005, EC 2005
<b>N39</b>	Para norma de gases de escape Euro 93 - CEE 19.5 y US 84 LDT
<b>N5P</b>	No para vehículos con norma de gases de escape Euro 5 Plus
<b>NC8</b>	Para código de valores de gases de escape NC8
<b>NC9</b>	Para código de gas de escape NC9
<b>NL4</b>	Para norma de gases de escape L4
<b>NOR</b>	Versión normal
<b>NT5</b>	Para código de valor de gases de escape NT5
<b>OBD</b>	Para vehículos con diagnóstico de a bordo (OBD)
<b>OBD</b>	Para vehículos sin diagnóstico de a bordo (OBD)
<b>OLK</b>	Para vehículos sin servodirección y sin acondicionador de aire
<b>OWK</b>	Para vehículos sin inmovilizador electrónico con acondicionador de aire
<b>OWO</b>	Para vehículos sin inmovilizador electrónico y sin acondicionador de aire
<b>RAB</b>	montaje a la derecha
<b>RAP</b>	Adecuado para RME (Metilester de colza)
<b>RAP</b>	No adecuado para RME (Metilester de colza)
<b>RLE</b>	Para vehículos de volante a la derecha
<b>RSA</b>	Caracterización de color rosa

<b>SCJ</b>	Para vehículos con catalizador SCR (Selective Catalytic Reduction)
<b>SGJ</b>	Para vehículos sin catalizador SCR (Selective Catalytic Reduction)
<b>SDK</b>	Cabina standard
<b>SFU</b>	Sensor de enchufe, individual
<b>SFZ</b>	Para vehículos especiales
<b>SLX</b>	Para vehículos con equipamiento SLX
<b>SSJ</b>	Para vehículos con función de arranque/parada
<b>SSJ</b>	Para vehículos sin función de arranque/parada
<b>THD</b>	Después del montaje se debe programar la unidad de mando integrada en un taller bajo contrato del fabricante del vehículo.
<b>THI</b>	Tras cambiar la unidad de mando de la bomba o la bomba de inyección, debe activarse el inmovilizador electrónico en un taller concertado del fabricante de automóviles.
<b>THS</b>	La unidad de mando se debe programar en un taller bajo contrato del fabricante del vehículo, tras el montaje de la bomba de inyección.
<b>TIE</b>	Para vehículos con norma de gases de escape TIER 1
<b>TNK</b>	Para identificación inequívoca del número Bosch se debe tener a la vista la tarjeta de datos del vehículo. Los componentes enumerados en el producto deben coincidir con los de la tarjeta de datos.
<b>TW</b>	El producto montado se debe determinar en el vehículo o en el motor.
<b>ULE</b>	Para vehículos con norma de gases de escape ULEV (Ultra-Low Emission Vehicles)
<b>ULT</b>	Modelo Ultra
<b>UPE</b>	En caso de que se instale 0 928 400 527 para sustituir a 0 928 400 314, debe programarse la unidad de mando en un taller BMW.
<b>UV2</b>	Para vehículos con norma de gases de escape ULEV2 (Ultra-Low Emission Vehicles)
<b>V86</b>	Chasis con cabina
<b>VAE</b>	Para vehículos con desintoxicación de gases de escape intensificada

<b>VBS</b>	¡Atención! Repuesto para Volvo Truck 0 444 022 069 (sin elemento de compensación de presión en la tapa de la carcasa). Tras el montaje del nuevo módulo de alimentación se debe programar la unidad de mando integrada en un taller bajo contrato Volvo.
<b>VGT</b>	Motor VGT
<b>VTF</b>	¡Atención! Para Volvo Truck se debe pedir la tapa de la carcasa F 00B H40 091 (sin elemento de compensación de presión) y se debe transformar el módulo de alimentación. Tras el montaje del nuevo módulo de alimentación se debe programar la unidad de mando integrada en un taller bajo contrato.
<b>WAS</b>	Con separador de agua
<b>WAS</b>	Sin separador de agua
<b>WEG</b>	Para vehículos con dispositivo electrónico de inmovilización
<b>WEG</b>	Para vehículos sin inmovilizador electrónico
<b>WEI</b>	Caracterización de color: blanco
<b>WEK</b>	Para vehículos con inmovilizador electrónico y con acondicionador de aire
<b>WGT</b>	Motor WGT
<b>WOK</b>	Para vehículos con inmovilizador electrónico sin acondicionador de aire
<b>WW</b>	A elección
<b>WZT</b>	Para vehículos con dispositivo electrónico de inmovilización, liberación de conexión con llave de encendido (sistema Transponder)
<b>X10</b>	Para cilindro 1
<b>X56</b>	Para cilindro 2 - 6
<b>X96</b>	Norma de gases de escape TIER2
<b>XXX</b>	Suministro mientras duren las reservas
<b>YE8</b>	Para pickup con cabina doble, (4 puertas)
<b>YK1</b>	No para equipamiento de rendimiento
<b>Z25</b>	No para vehículos con norma de gases de escape ULEV (Ultra-Low Emission Vehicles)
<b>ZDA</b>	Lista de repuestos disponible en archivo ESPI-ZD (ZEXEL)
<b>ZE</b>	2 necesarios
<sup>1</sup>	Con detector de movimientos de aguja

	Información / explicación
	Número de referencia
	Turismo / furgoneta
	Vehículos industriales / de transporte pequeño
	Maquinaria agrícola o de construcción
	Motor estacionario / motor industrial
	Cilindrada en l
	Potencia del motor en kW (CV)
	Tipo de motor

	Número de cilindros
	País de exportación
	Fecha/periodo de fabricación
	Caso especial
	Pieza de intercambio Bosch
	Combinación de portainyector
	Inyector Common Rail
	Junta
	Bomba de alta presión Common Rail



Bomba de inyección distribuidora VE y VR



Medidor de masa de aire



Unit Injection System UIS (Unidad bomba-inyector)



Unit Pump System UPS



Módulo de suministro Denoxtronic



Formula tipo portainyector



Formula tipo inyector



Presión de apertura



Inyector DNOX



Anillo de junta de culata/arandela calorífuga DHK



Anillo de junta de conexión de aceite de fuga DHK



Unidad bomba-inyector (PDE)



Inyector



Protección calorífuga



Confrontación



Referencia de página

















Módulo dosificador DNOX

<b>24S</b>	24 Volt
<b>24Z</b>	Para cilindros 2 a 4
<b>3T5</b>	Para veículos com 3,5 t de peso máximo admissível
<b>4T5</b>	Para veículos com 4,5 t de peso máximo admissível
<b>5PL</b>	Para veículos com norma relativa aos gases de escape Euro 5 Plus
<b>6PL</b>	Para veículos com norma relativa aos gases de escape Euro 6 Plus
<b>ABS</b>	Para veículos com ABS
<b>ABS</b>	Para veículos sem ABS
<b>AG</b>	Para veículos com caixa de câmbio automática
<b>AGF</b>	Para veículos com descontaminação de gases de escapamento
<b>AGF</b>	Para veículos sem descontaminação de gases de escapamento
<b>AGR</b>	Recirculação dos gases de escapamento
<b>AGR</b>	Sem recirculação dos gases de escapamento
<b>ASB</b>	Observar a conexão
<b>ATW</b>	A troca do injetor não é possível no caso de conjuntos porta-injetor + injetor com sensor do movimento da agulha. Favor observar por ocasião do pedido. O produto instalado deve ser verificado no veículo ou no motor.
<b>BG4</b>	Para pacote Performance
<b>BKN</b>	Equipamento Bosch sem sistema de partida a frio
<b>BO</b>	Bosch, somente como peça de reposição para equipamento Bosch
<b>BOK</b>	Equipamento Bosch com sistema de partida a frio
<b>BOW</b>	Bosch, somente como peça de reposição para equipamento Bosch, para veículos com imobilizador eletrônico
<b>BOW</b>	Bosch, somente como peça de reposição de equipamento Bosch, para veículos sem imobilizador eletrônico
<b>BS1</b>	Para aplicação BS 1
<b>BS2</b>	Para aplicação BS 2
<b>CAV</b>	Para produto CAV
<b>CVT</b>	Para veículos com caixa CVT
<b>CVT</b>	Não para veículos com câmbio CVT
<b>DBB</b>	Anel de vedação da câmara de combustão incluído
<b>DBJ</b>	Anel de vedação da câmara de combustão pré-montada no injetor
<b>DBJ</b>	Anel de vedação da câmara de combustão não incluído no fornecimento
<b>DKF</b>	Fabricação Zexel
<b>E93</b>	Para norma sobre emissões de gases de escapamento CEE 93
<b>E96</b>	Para norma sobre emissões de gases de escapamento CEE 96
<b>EC9</b>	Para norma sobre emissões de gases de escapamento CEE 99
<b>EDC</b>	Regulagem diesel eletrônica
<b>EE2</b>	Para norma sobre emissões de gases de escapamento CEE 2000
<b>EFV</b>	Também como peça de reposição da peça anterior
<b>EFZ</b>	Substitui produtos de terceiros, substituir jogo completo
<b>EQ0</b>	Para Pickup com cabine dupla grande (4 portas)
<b>ERL</b>	Para veículos com potência aumentada
<b>EU2</b>	Para veículos com norma relativa aos gases de escape Euro 2
<b>EU2</b>	Não para norma relativa aos gases de escape Euro 2
<b>EU3</b>	Para veículos com norma relativa aos gases de escape Euro 3
<b>EU3</b>	Não p/ veículos c/ norma relativa aos gases de escape Euro 3
<b>EU4</b>	Para veículos com norma relativa aos gases de escape Euro 4
<b>EU4</b>	Não p/ veículos c/ norma relativa aos gases de escape Euro 4
<b>EU5</b>	Para veículos com norma relativa aos gases de escape Euro 5
<b>EU5</b>	Não p/ veículos c/ norma relativa aos gases de escape Euro 5
<b>EU6</b>	Para veículos com norma relativa aos gases de escape Euro 6
<b>EU6</b>	Não p/ veículos c/ norma relativa aos gases de escape Euro 6
<b>EXW</b>	Substituição do eixo excêntrico apenas conjuntamente com a bomba de engrenagens 0 440 020 044
<b>FBH</b>	Não para operação em altitudes
<b>FD3</b>	Para a norma sobre emissões de gases de escapamento D3
<b>FE2</b>	Para motores Euro 2/B
<b>FE2</b>	Não se destina a motores Euro 2/B
<b>FKR</b>	Para veículos com distância entre eixos curta
<b>FL5</b>	Para norma sobre emissões de gases de escapamento L5
<b>FLR</b>	Para veículos com distância entre eixos longa
<b>FMA</b>	Para veículos sem airbag
<b>FWT</b>	Para trocador de calor
<b>GES</b>	Para veículos com sistema de regulação da velocidade
<b>GES</b>	Para veículos sem sistema de regulação da velocidade
<b>GNL</b>	Versão Green Line
<b>GS</b>	Para veículos com caixa de câmbio manual
<b>HAG</b>	Para veículos com caixa de câmbio semi-automática
<b>HEF</b>	Para veículos com desembaçador do pára-brisa
<b>HEF</b>	Para veículos sem desembaçador do pára-brisa
<b>HIW</b>	Versão de estrada
<b>I1B</b>	Para injetor classe 1, com número de identificação 1 ou código de cores azul
<b>I2G</b>	Para injetor classe 2, com número de identificação 2 ou código de cores verde
<b>I3K</b>	Para injetor classe 3, com número de identificação 3
<b>KGL</b>	Não para a versão Green Line
<b>KKA</b>	Com identificação Classe A
<b>KKB</b>	Com identificação Classe B
<b>KKX</b>	Com identificação Classe X
<b>KKY</b>	Com identificação Classe Y
<b>KKZ</b>	Com identificação Classe Z
<b>KL</b>	Para veículos com ar condicionado
<b>KL</b>	Para veículos sem ar condicionado
<b>KOB</b>	Para perua
<b>KOC</b>	Pedidos de reparos: BDC/BDS, peça nova: <a href="mailto:inquiry@de.bosch.com">inquiry@de.bosch.com</a>
<b>KSE</b>	Para sistema de partida a frio
<b>KZB</b>	Identificação: azul
<b>KZE</b>	Identificação: amarelo
<b>KZG</b>	Identificação: verde
<b>LAB</b>	Montagem à esquerda
<b>LEN</b>	Para motores com rendimento normal
<b>LET</b>	Para motores com baixo rendimento
<b>LLE</b>	Para volante à esquerda
<b>LWG</b>	Para furgonetas
<b>MEB</b>	Com sistema de injeção Bosch
<b>MG5</b>	Para veículos com caixa de câmbio manual de 5 marchas
<b>MG6</b>	Para veículos com caixa de câmbio manual de 6 marchas
<b>MKO</b>	Para veículos com ar condicionado, sem direção hidráulica
<b>MLK</b>	Para veículos com direção hidráulica e ar condicionado
<b>MLU</b>	Para veículos com bomba de ar secundário
<b>MPR</b>	Para veículos com filtro de partículas de fuligem
<b>MPR</b>	Para veículos sem filtro de partículas de fuligem
<b>MRQ</b>	Para veículos com regulador das rotações máximas RQ
<b>MVR</b>	Com variador de velocidade integrado
<b>N03</b>	Para norma relativa aos gases de escape Euro 93 - CEE 19.5
<b>N05</b>	Para norma relativa aos gases de escape Euro 96, CEE 95, L3
<b>N07</b>	Para a norma sobre emissões de gases de escapamento US 87
<b>N09</b>	Para a norma sobre emissões de gases de escapamento US 84 LDT
<b>N11</b>	Para a norma sobre emissões de gases de escapamento US 90 LDT
<b>N13</b>	Para norma relativa aos gases de escape Euro 96
<b>N14</b>	Para a norma relativa aos gases de escape Euro 2000, CEE 2000
<b>N25</b>	Para norma relativa aos gases de escape Euro 2005, EC 2005
<b>N25</b>	Não para norma relativa aos gases de escape Euro 2005, EC 2005
<b>N39</b>	Para norma relativa aos gases de escape Euro 93 - CEE 19.5 e US 84 LDT
<b>N5P</b>	Não para veículos com norma relativa aos gases de escape Euro 5 Plus
<b>NC8</b>	Para código de valores de gases de escapamento NC8
<b>NC9</b>	Para código de valores de gases de escapamento NC9
<b>NL4</b>	Para norma sobre emissões de gases de escapamento L4
<b>NOR</b>	Versão normal
<b>NT5</b>	Para código de valores de gases de escapamento NT5
<b>OBD</b>	Para veículos com diagnose On-Board (OBD)
<b>OBD</b>	Para veículos sem diagnose On-Board (OBD)
<b>OLK</b>	Para veículos sem direção hidráulica e sem ar condicionado
<b>OWK</b>	Para veículos sem imobilizador eletrônico, com ar condicionado
<b>OWO</b>	Para veículos sem imobilizador eletrônico e sem ar condicionado
<b>RAB</b>	Montagem à direita
<b>RAP</b>	Adequado para RME (éster metílico de óleo de colza)
<b>RAP</b>	Inadequado para RME (éster metílico de óleo de colza)
<b>RLE</b>	Para volante à direita
<b>RSA</b>	Identificação da cor, rosa

<b>SCJ</b>	Para veículos com catalisador SCR (Selective Catalytic Reduction)
<b>SGJ</b>	Para veículos sem catalisador SCR (Selective Catalytic Reduction)
<b>SDK</b>	Cabine standard
<b>SFU</b>	Sensor de encaixe, individual
<b>SFZ</b>	Para veículos especiais
<b>SLX</b>	Para veículos com nível de equipamento SLX
<b>SSJ</b>	Para veículos com função de arranque/paragem
<b>SSJ</b>	Para veículos sem função de arranque/paragem
<b>THD</b>	Após a montagem, a unidade de comando integrada tem de ser programada em uma oficina autorizada pelo fabricante do veículo.
<b>THI</b>	Após a substituição da unidade de comando da bomba ou da bomba injetora, o imobilizador tem de ser ativado numa oficina concessionada do fabricante do veículo.
<b>THS</b>	Após a montagem da bomba injetora, a unidade de comando tem de ser programada numa oficina da concessionária do fabricante do veículo.
<b>TIE</b>	Para veículos que obedecem à norma de emissões TIER 1
<b>TNK</b>	A ficha de dados do veículo deve estar à disposição para a identificação inequívoca do número Bosch. Os componentes especificados para o produto devem coincidir com aqueles da ficha de dados.
<b>TW</b>	Produto montado tem que ser averiguado no veículo ou no motor.
<b>ULE</b>	Para veículos com norma relativa aos gases de escape ULEV (Ultra-Low Emission Vehicles)
<b>ULT</b>	Versão Ultra
<b>UPE</b>	Se montar o componente 0 928 400 527 como substituto de 0 928 400 314, a unidade de comando tem de ser reprogramada em uma oficina da BMW.
<b>UV2</b>	Para veículos com norma sobre emissões de gases de escapamento ULEV2 (Ultra-Low Emission Vehicles)
<b>V86</b>	Chassis com cabina
<b>VAE</b>	Para veículos com descontaminação de gases de escapamento reforçada

<b>VBS</b>	Atenção! Substituição para Volvo Truck 0 444 022 069 (sem elemento de compensação de pressão na tampa da carcaça). Após montagem do módulo de alimentação, a unidade de comando integrada deve ser programada em uma oficina autorizada Volvo.
<b>VGT</b>	Motor VGT
<b>VTF</b>	Atenção! Para Volvo Truck, é necessário encomendar a tampa da carcaça F 00B H40 091 (sem elemento de compensação de pressão) e converter o módulo de alimentação. Após a montagem do novo módulo de alimentação, a unidade de comando integrada deve ser programada em uma oficina autorizada.
<b>WAS</b>	Com separador de água
<b>WAS</b>	Sem separador de água
<b>WEG</b>	Para veículos com imobilizador eletrónico
<b>WEG</b>	Para veículos sem imobilizador eletrónico
<b>WEI</b>	Identificação da cor: branco
<b>WEK</b>	Para veículos com imobilizador eletrónico e ar condicionado
<b>WGT</b>	Motor WGT
<b>WOK</b>	Para veículos com imobilizador eletrónico, sem ar condicionado
<b>WW</b>	Opcional
<b>WZT</b>	Para veículos com imobilizador eletrónico, liberação através da chave de ignição (sistema transponder)
<b>X10</b>	Para cilindro 1
<b>X56</b>	Para cilindros 2 - 6
<b>X96</b>	Norma relativa aos gases de escape TIER2
<b>XXX</b>	Disponível para entrega enquanto existir estoque
<b>YE8</b>	Para Pickup com cabine dupla (4 portas)
<b>YK1</b>	Não para equipamento Performance
<b>Z25</b>	Não para veículos com norma relativa aos gases de escape ULEV (Ultra Low Emission Vehicles)
<b>ZDA</b>	Lista de peças sobressalentes disponível em arquivo ESPI-ZD (Zexel)
<b>ZE</b>	Necessários dois
<sup>1</sup>	Com sensor do movimento da agulha

	Informação / explicação
	Número de pedido
	Veículo ligeiro / Furgão
	Veículo utilitário/furgão
	Máquinas agrícolas / de construção
	Motor estacionário / motor de montagem
	Cilindradas em l
	Potência do motor em kW (PS)
	Tipo de motor

	Número de cilindros
	País de exportação
	Data/Período de instalação
	Caso especial
	Peça de substituição Bosch
	Combinação de porta-injetor
	Injetor Common Rail
	Arruela de vedação
	Bomba de alta pressão Common Rail



Bomba injetora distribuidora VE e VR



Medidor de massa de ar



Unit Injection System UIS (unidade injetor-bomba)



Unit Injection System UPS (unidade bomba-injetor)



Módulo de alimentação Denoxtronic



Designação do porta-injetor



Designação do bico injetor



Pressão de abertura



Bico injetor DNOX



Anel de vedação cabeçote do motor/arruela de isolamento térmico DHK



Anel de vedação ligação de vazamento de óleo DHK



Unidade bomba-injetor



Bocal



Proteção térmica



Confrontação



Referência do lado



Módulo de dosagem DNOX



























<b>24S</b>	24 volt
<b>24Z</b>	För cylinder 2-4
<b>3T5</b>	För fordon med 3,5 t högsta tillåtna totalvikt
<b>4T5</b>	För fordon med 4,5 t högsta tillåtna totalvikt
<b>5PL</b>	För fordon med avgasstandard Euro 5 plus
<b>6PL</b>	För fordon med avgasstandard Euro 6 plus
<b>ABS</b>	För fordon med ABS
<del>ABS</del>	För fordon utan ABS
<b>AG</b>	För fordon med automatlåda
<b>AGF</b>	För fordon med avgasrening
<del>AGF</del>	För fordon utan avgasrening
<b>AGR</b>	Avgasåterföring
<del>AGR</del>	Ej avgasåterföring
<b>ASB</b>	Observera anslutningen
<b>ATW</b>	I insprutare med NBF (nälyftssensor) är byte av spridare ej möjligt, beakta detta vid beställning. Inbyggd detalj måste konstateras på fordonet eller motorn.
<b>BG4</b>	För Performance-paket
<b>BKN</b>	Bosch-utrustning utan kallstartsystem
<b>BO</b>	Bosch, endast som ersättning för Bosch-utrustning
<b>BOK</b>	Bosch-utrustning med kallstartanordning
<b>BOW</b>	Bosch, endast som ersättning för Bosch-utrustning, för fordon med immobiliser
<del>BOW</del>	Bosch, endast som ersättning för Bosch-utrustning, för fordon utan immobiliser
<b>BS1</b>	För BS 1 applikation
<b>BS2</b>	För BS 2 applikation
<b>CAV</b>	För CAV-fabrikat
<b>CVT</b>	För bilar med CVT-växellåda
<del>CVT</del>	Inte för bilar med CVT-växellåda
<b>DBB</b>	Förbränningsrums-packningsring bifogad
<b>DBJ</b>	förbränningsrums-packningsring på injektor förmonterad
<del>DBJ</del>	Tätningring för förbränningsrum medföljer inte
<b>DKF</b>	Tillverkning ""Zexel""
<b>E93</b>	För avgasstandard EEC 93
<b>E96</b>	För avgasstandard EEC 96
<b>EC9</b>	För avgasstandard EEC 99
<b>EDC</b>	Elektronisk dieselreglering
<b>EE2</b>	För avgasstandard EEC 2000
<b>EFV</b>	Även ersättning för föregångare
<b>EFZ</b>	Ersättning för främmande produkt, byt ut satsvis
<b>EQ0</b>	För pickup med stor dubbelhytt (4-dörrars)
<b>ERL</b>	För fordon med förhöjd effekt
<b>EU2</b>	För bilar med avgasstandard Euro 2
<del>EU2</del>	Ej för avgasstandard Euro 2
<b>EU3</b>	För bilar med avgasstandard Euro 3
<del>EU3</del>	Inte för bilar med avgasstandard EURO 3
<b>EU4</b>	För bilar med avgasstandard Euro 4
<del>EU4</del>	Inte för bilar med avgasstandard EURO 4
<b>EU5</b>	För bilar med avgasstandard Euro 5
<del>EU5</del>	Inte för bilar med avgasstandard EURO 5
<b>EU6</b>	För bilar med avgasstandard Euro 6
<del>EU6</del>	Inte för fordon med avgasstandard EURO 6
<b>EXW</b>	Byte av excenteraxel endast tillsammans med kugghjulspump O 440 020 044
<b>FBH</b>	För drift på hög höjd
<b>FD3</b>	För avgasstandard D3
<b>FE2</b>	För Euro 2/B-motorer
<del>FE2</del>	Ej för Euro 2/B-motorer
<b>FKR</b>	För bil med kort hjulbas
<b>FL5</b>	För avgasstandard L5
<b>FLR</b>	För bil med lång hjulbas
<b>FMA</b>	För fordon utan krockkudde
<b>FWT</b>	För värmväxlare
<b>GES</b>	För fordon med hastighetsreglersystem
<del>GES</del>	För fordon utan hastighetsreglersystem
<b>GNL</b>	Utförande Green Line
<b>GS</b>	För fordon med manuell växellåda
<b>HAG</b>	För fordon med halvautomatisk växellåda

<b>HEF</b>	För bilar med uppvärmbär vindruta
<del>HEF</del>	För fordon utan uppvärmbär framruta
<b>HIW</b>	Vägutförande
<b>I1B</b>	För injektor klass 1, med kodsiffror 1 eller blå färgmarkering
<b>I2G</b>	För injektor klass 2, med kodsiffror 2 eller grön färgmarkering
<b>I3K</b>	För injektor klass 3, med kodsiffror 3
<b>KGL</b>	Ej för utförande Green Line
<b>KKA</b>	Med märkning klass A
<b>KKB</b>	Med märkning klass B
<b>KKX</b>	Med märkning klass X
<b>KKY</b>	Med märkning klass Y
<b>KKZ</b>	Med märkning klass Z
<b>KL</b>	För fordon med AC-anläggning
<del>KL</del>	För bilar utan AC-anläggning
<b>KOB</b>	För kombibil
<b>KOC</b>	Reparationsförfrågningar: BDC/BDS, delar: inquiry@de.bosch.com
<b>KSE</b>	Inbyggd kallstartanordning
<b>KZB</b>	Märkning: blå
<b>KZE</b>	Märkning: gul
<b>KZG</b>	Märkning: grön
<b>LAB</b>	Vänstermontering
<b>LEN</b>	För motor med normaleffekt
<b>LET</b>	För motor med låg effekt
<b>LLE</b>	För vänsterstyrda fordon
<b>LWG</b>	För distributionsbil
<b>MEB</b>	Med Bosch insprutningssystem
<b>MG5</b>	För fordon med 5-växlad manuell växellåda
<b>MG6</b>	För fordon med 6-växlad manuell växellåda
<b>MKO</b>	För fordon med -anläggning, utan styrervo
<b>MLK</b>	För fordon med styrervo och AC-anläggning
<b>MLU</b>	För fordon med sekundärluftump
<b>MPR</b>	För bilar med sotpartikelfilter
<del>MPR</del>	För bilar utan sotpartikelfilter
<b>MRQ</b>	För fordon med fullvarvsregulator RQ
<b>MVR</b>	Inbyggd ställregulator
<b>N03</b>	För avgasnorm Euro 93, CEE 19.5
<b>N05</b>	För avgasnorm Euro 96, CEE 95, L3
<b>N07</b>	För avgasstandard US 87
<b>N09</b>	För avgasstandard US 84 LDT
<b>N11</b>	För avgasstandard US 90 LDT
<b>N13</b>	För avgasstandard Euro 96
<b>N14</b>	För avgasnorm Euro 2000, CEE 2000
<b>N25</b>	För avgasnorm Euro 2005, EC 2005
<del>N25</del>	Ej för avgasnorm Euro 2005, EC 2005
<b>N39</b>	För avgasnorm Euro 93 - CEE 19.5 och US 84 LDT
<b>N5P</b>	Inte för fordon med avgasstandard Euro 5 plus
<b>NC8</b>	För avgasvärdeskod NC8
<b>NC9</b>	För avgasvärdeskod NC9
<b>NL4</b>	För avgasstandard L4
<b>NOR</b>	Normalt utförande
<b>NT5</b>	För avgasvärdeskod NT5
<b>OBD</b>	För fordon med On-Board-diagnos (OBD)
<del>OBD</del>	För fordon utan On-Board-diagnos (OBD)
<b>OLK</b>	För fordon utan styrhjälp och utan ABS
<b>OWK</b>	För fordon utan immobiliser, med AC-anläggning
<b>OWO</b>	För fordon utan immobiliser och utan AC-anläggning
<b>RAB</b>	Högermontering
<b>RAP</b>	Lämplig för RME (rapsolemetylster)
<del>RAP</del>	Inte lämplig för RME (rapsolemetylster)
<b>RLE</b>	För högerstyrda fordon
<b>RSA</b>	Färgmarkering rosa
<b>SCJ</b>	För fordon med SCR-katalysator (Selective Catalytic Reduction)
<del>SCJ</del>	För fordon utan SCR-katalysator (Selective Catalytic Reduction)
<b>SDK</b>	Standardhytt
<b>SFU</b>	Instickssensor, enkel

<b>SFZ</b>	För specialfordon
<b>SLX</b>	För fordon med SLX-utrustning
<b>SSJ</b>	För bilar med start-/stoppfunktion
<b>SSJ</b>	För bilar utan start-/stoppfunktion
<b>THD</b>	Efter installation måste det integrerade styrdonet programmeras i en av fordonstillverkarens kontraktsverkstäder.
<b>THI</b>	Efter byte av pumpstyrdon eller insprutningspump måste startspärren aktiveras i en av biltillverkarens kontraktsverkstäder.
<b>THS</b>	Styranordningen måste, efter monteringen av insprutningspumpen, programmeras på en märkesverkstad.
<b>TIE</b>	För bilar med avgasstandard TIER 1
<b>TNK</b>	För entydig identifiering av Bosch-numret måste bilens datakort föreligga. De vid produkten angivna komponenterna måste stämma överens med de på datakortet.
<b>TW</b>	Monterad produkt måste identifieras på bilen eller motorn.
<b>ULE</b>	För fordon med avgasnorm ULEV (Ultra-Low Emission Vehicles)
<b>ULT</b>	Utförande Ultra
<b>UPE</b>	Om 0 928 400 527 monteras som ersättning för 0 928 400 314, så måste styrdonet programmeras om av en BMW-verkstad.
<b>UV2</b>	För fordon med avgasnorm ULEV2 (Ultra-Low Emission Vehicles)
<b>V86</b>	Chassi med förarhytt
<b>VAE</b>	För fordon med utökad avgasrening
<b>VBS</b>	Varning: Reserv till Volvo Truck 0 444 022 069 (utan tryckutjämningslement i huslocket). Efter montering av den nya matarmodulen måste den integrerade styrenheten programmeras i en Volvo märkesverkstad.

<b>VGT</b>	VGT motor
<b>VTF</b>	Varning! Till Volvo Truck måste huslock F 00B H40 091 (utan tryckutjämningslement) beställas och matarmodulen byggas om. Efter montering av den nya matarmodulen måste det integrerade styrdonet programmeras i en märkesverkstad.
<b>WAS</b>	Med vattenavskiljare
<b>WAS</b>	Utan vattenavskiljare
<b>WEG</b>	För fordon med immobiliser
<b>WEG</b>	För fordon utan immobiliser
<b>WEI</b>	Färgmärkning: vit
<b>WEK</b>	För fordon med styrservo och AC-anläggning
<b>WGT</b>	WGT motor
<b>WOK</b>	För fordon med immobiliser, utan AC-anläggning
<b>WW</b>	Valfritt
<b>WZT</b>	För fordon med immobiliser, frigivning över startnyckel (transpondersystem)
<b>X10</b>	För cylinder 1
<b>X56</b>	För cylinder 2 - 6
<b>X96</b>	Avgasstandard TIER2
<b>XXX</b>	Levereras endast så länge den finns i lager
<b>YE8</b>	För pickup med dubbelhytt (4-dörrars)
<b>YK1</b>	Inte för Performance utrustning
<b>Z25</b>	Inte för fordon med avgasnorm ULEV (Ultra-Low Emission Vehicles)
<b>ZDA</b>	Reservdelsslista på ESPI-ZD (Zexel) arkiv tillgängligt
<b>ZE</b>	2 erfordras
<sup>1</sup>	Med nålliftssensor

	Information/förklaring
	Artikelnummer
	Personbil/lätt lastbil
	Nyttfordon / pickup
	Jordbruks- eller entreprenadmaskin
	Stationär motor/inbyggd motor
	Slagvolym i l
	Motoreffekt i kW (hk)
	Motortyp
	Cylinderantal
	Exportland

	Datum/monteringstidpunkt
	Speciellt fall
	Bosch-bytesdel
	Spridarhållarkombination
	Common rail- injektor
	Tätningbricka
	Common rail-högtryckspump
	Fördelarinsprutningspump VE och VR
	Luftmassamätare
	Unit Injection System UIS
	Unit Pump System UPS





Denoxtronic-matarmodul



Spridarhållare typformel



Spridare typformel



Öppningstryck



Tätningring cylinderlock/värmskyddsskiva DHK



Tätningring läckoljeanslutning DHK



DNOX insprutningsmunstycke



Enhetsinsprutare



Spridare



Värmskydd



Jämförelse



Sidhänvisning



DNOX doseringsmodul







<b>24S</b>	24 V
<b>24Z</b>	Sylintereihin 2 - 4
<b>3T5</b>	Mallit, joiden sallittu kokonaispaino on 3,5 t
<b>4T5</b>	Mallit, joiden sallittu kokonaispaino on 4,5 t
<b>5PL</b>	Malleihin, joissa pakokaasunormi Euro 5 Plus
<b>6PL</b>	Malleihin, joissa pakokaasunormi Euro 6 Plus
<b>ABS</b>	ABS-varusteiset mallit
<b>ABS</b>	Ajoneuvot ilman ABS-järjestelmää
<b>AG</b>	Automaattivaihteistolla varustetut ajoneuvot
<b>AGF</b>	Mallit, joissa pakokaasupuhdistus
<b>AGF</b>	Mallit ilman pakokaasujen puhdistusta
<b>AGR</b>	Pakokaasun kierrätys
<b>AGR</b>	ilman pakokaasun kierrätystä
<b>ASB</b>	Huomioi liitäntä
<b>ATW</b>	Huomioi tilattaessa: Suutinta ei voi vaihtaa erikseen suutinpidin-yhdistelmissä, joissa on neulan liiketunnistin (NBF). Tuotteen numero varmistettava ajoneuvosta / moottorista.
<b>BG4</b>	Performance Package -pakettiin
<b>BKN</b>	Bosch-varuste ilman kylmäkäynnistyslaitetta
<b>BO</b>	Bosch vain Bosch-varusteen korvaamiseksi
<b>BOK</b>	Bosch-varuste kylmäkäynnistyslaitteella
<b>BOW</b>	Bosch, vain Bosch-varusteen korvaamiseksi, ajonestolaitteella varustetut ajoneuvot.
<b>BOW</b>	Bosch, vain Bosch-varusteen korvaamiseksi, mallit ilman ajonestoa
<b>BS1</b>	BS 1 -sovellukseen
<b>BS2</b>	BS 2 -sovellukseen
<b>CAV</b>	Soveltuu CAV -tuotteelle
<b>CVT</b>	Malleihin, joissa CVT-vaihteisto
<b>CVT</b>	Ei malleihin, joissa CVT-vaihteisto
<b>DBB</b>	Palotilan tiivisterengas kuuluu toimitukseen
<b>DBJ</b>	Palotilan tiivisterengas esiasennettu injektoriin
<b>DBJ</b>	Palotilan tiivisterengas ei sisälly toimitukseen
<b>DKF</b>	Valmistaja Zexel
<b>E93</b>	EEC 93 -pakokaasustandardiin
<b>E96</b>	EEC 96 -pakokaasustandardiin
<b>EC9</b>	EEC 99 -pakokaasustandardiin
<b>EDC</b>	Elektroninen ohjaus, diesel
<b>EE2</b>	ETY 2000 -pakokaasustandardiin
<b>EFV</b>	Korvaa myös aikaisemman mallin
<b>EFZ</b>	Korvaa vierasvalmisteisen tuotteen, koko sarja uusittava
<b>EQ0</b>	Pick-up-malleihin, joissa doppleri (4-ovinen)
<b>ERL</b>	Malleihin, joiden tehoa on lisätty
<b>EU2</b>	Malleihin, joissa pakokaasunormi Euro 2
<b>EU2</b>	Ei pakokaasunormiin EURO 2
<b>EU3</b>	Malleihin, joissa pakokaasunormi Euro 3
<b>EU3</b>	Ei malleihin, joissa pakokaasunormi Euro 3
<b>EU4</b>	Malleihin, joissa pakokaasunormi Euro 4
<b>EU4</b>	Ei autoihin, joissa Euro 4 pakokaasustandardi
<b>EU5</b>	Malleihin, joissa pakokaasunormi Euro 5
<b>EU5</b>	Ei malleihin, joissa pakokaasunormi Euro 5
<b>EU6</b>	Malleihin, joissa pakokaasunormi Euro 6
<b>EU6</b>	Ei malleihin, joissa pakokaasunormi Euro 6
<b>EXW</b>	Epäkeskoakseli uusittava vain, josa varusteena hammashihnapumppu 0 440 020 044
<b>FBH</b>	Käytettäväksi korkealla
<b>FD3</b>	pakokaasustandardiin D3
<b>FE2</b>	Euro 2/B-moottoreihin
<b>FE2</b>	Ei Euro 2/B-moottoreihin
<b>FKR</b>	Malleihin, joissa lyhyt akseliväli
<b>FL5</b>	pakokaasustandardi L5
<b>FLR</b>	Mallit, joissa pitkä akseliväli
<b>FMA</b>	Mallit ilman turvatyynyä
<b>FWT</b>	lämmönvaihtimeen
<b>GES</b>	Malleihin, joissa vakionopeussäädin
<b>GES</b>	Mallit ilman ajonopeuden säätöä

<b>GNL</b>	Malli Green Line
<b>GS</b>	Mekaanisella vaihteistolla varust. mallit
<b>HAG</b>	Malleihin, joissa puoliautomaattivaihteisto
<b>HEF</b>	Malleihin, joissa lämmitettävä tuulilasi
<b>HEF</b>	Mallit ilman tuulilasin lämmitystä
<b>HIW</b>	Normaali ajotiemalli
<b>I1B</b>	Luokan 1 injektoreihin, tunnus 1 tai sininen väritunniste
<b>I2G</b>	Luokan 2 injektoreihin, tunnus 2 tai vihreä väritunniste
<b>I3K</b>	Luokan 3 injektoreihin, tunnus 3
<b>KGL</b>	Ei malliin Green Line
<b>KKA</b>	+ tunnus A-luokka
<b>KKB</b>	+ tunnus B-luokka
<b>KKX</b>	+ tunnus X-luokka
<b>KKY</b>	+ tunnus Y-luokka
<b>KKZ</b>	+ tunnus Z-luokka
<b>KL</b>	Malleihin, joissa ilmastointilaitte
<b>KL</b>	Mallit ilman ilmastointilaitetta
<b>KOB</b>	farmari
<b>KOC</b>	Korjauskyselyt: BDC/BDS, uudet osat: inquiry@de.bosch.com
<b>KSE</b>	varust. kylmäkäynnistyslaite
<b>KZB</b>	Väritunnus: sininen
<b>KZE</b>	Väritunnus: keltainen
<b>KZG</b>	Väritunnus: vihreä
<b>LAB</b>	asennus vasemmalle
<b>LEN</b>	normaalitehoiselle moottorille
<b>LET</b>	pienitehoiseen moottoriin
<b>LLE</b>	Vasemmalta ohjattavaan malliin
<b>LWG</b>	jakeluajoneuvoihin
<b>MEB</b>	varust. Bosch-ruiskutusjärjestelmä
<b>MG5</b>	Mallit, joissa 5-vaiht. mekaaninen vaihteisto
<b>MG6</b>	Mallit, joissa 6-vaiht. mekaaninen vaihteisto
<b>MKO</b>	Mallit, joissa autom. ilmastointi, ei ohjaustehostinta
<b>MLK</b>	Malleihin, joissa ohjaustehostin ja ilmastointi
<b>MLU</b>	Malleihin, joissa toisioliimapumppu
<b>MPR</b>	Autot, joissa on nokihukkuusodatin
<b>MPR</b>	Autot, joissa ei ole nokihukkuusodatin
<b>MRQ</b>	Malleihin, joissa RQ-ajanopeussäädin
<b>MVR</b>	varust. siirtosäädin
<b>N03</b>	Pakokaasunormi EURO 93, CEE 19.5
<b>N05</b>	Pakokaasunormi EURO 96, CEE 95, L3
<b>N07</b>	Pakokaasustandardi US 87
<b>N09</b>	Pakokaasustandardi US 84 LDT
<b>N11</b>	Pakokaasustandardi US 90 LDT
<b>N13</b>	Pakokaasunormi EURO 96
<b>N14</b>	Pakokaasunormi EURO 2000, CEE 2000
<b>N25</b>	Pakokaasunormi EURO 2005, EC 2005
<b>N26</b>	Ei pakokaasunormiin EURO 2005, EC 2005
<b>N39</b>	Pakokaasunormi Euro 93 - CEE 19.5 ja US 84 LDT
<b>N5P</b>	Ei malleihin, joissa pakokaasunormi Euro 5 Plus
<b>NC8</b>	Pakokaasukoodi NC8
<b>NC9</b>	Pakokaasukoodi NC9
<b>NL4</b>	L4-pakokaasustandardiin
<b>NOR</b>	Normaali versio
<b>NT5</b>	NT5-pakokaasukoodi
<b>OBD</b>	Autoja varten, joissa on On-Board-diagnoosi (OBD)
<b>ØBD</b>	Autoja varten, joissa ei ole On-Board-diagnoosia (OBD)
<b>OLK</b>	Mallit ilman ohjaustehostinta ja ilman ilmastointia
<b>OWK</b>	Mallit ilman ajonestoa, + ilmastointilaitte
<b>OWO</b>	Mallit ilman ajonestoa ja ilman ilmastointia
<b>RAB</b>	Asennus oikealle
<b>RAP</b>	Sopii RME:hen (rapsiöljymetyyliesteri)
<b>RAP</b>	Ei sovi RME:hen (rapsiöljymetyyliesteri)
<b>RLE</b>	oikealta ohjattava
<b>RSA</b>	Tunnusväri roosa

<b>SCJ</b>	Ajoneuvomalleihin selektiivisellä SCR-katalyysaattorilla (Selective Catalytic Reduction)
<b>SGJ</b>	Ajoneuvomalleihin ilman selektiivistä SCR-katalyysaattoria (Selective Catalytic Reduction)
<b>SDK</b>	vakiomallinen ohjaamo
<b>SFU</b>	Pikaliitettävä tunnistin, yksittäinen
<b>SFZ</b>	Erikoisajoneuvoihin
<b>SLX</b>	Malleihin, joissa SLX-varustus
<b>SSJ</b>	Ajoneuvoihin, joissa on Start-/Stop-toiminto
<b>SSJ</b>	Ajoneuvoihin ilman Start-/Stop-toimintoa
<b>THD</b>	Asennuksen päätteeksi on integroitu ohjainlaite annettava ohjelmoida ajoneuvon valmistajan sopimuskorjaamossa.
<b>THI</b>	Jos ruiskutuspumppu tai sen ohjainlaite on jouduttu uusimaan, on ajonestolaite annettava aktivoida ajoneuvon valmistajan sopimuskorjaamossa.
<b>THS</b>	Ruiskutuspumpun asennuksen päätteeksi ohjainlaite on annettava ohjelmoida ajoneuvon valmistajan sopimuskorjaamossa.
<b>TIE</b>	Mallit, joiden pakokaasunormi on TIER 1
<b>TNK</b>	Bosch-numero on voitava tunnistaa yksiselitteisesti ajoneuvon papereista. Tuotteeseen kuuluvien komponenttien on oltava samat kuin datakortissa annetut osat.
<b>TW</b>	Asennettu tuote on määritettävä ajoneuvoa tai moottoria varten.
<b>ULE</b>	Malleihin, joissa ULEV-pakokaasunormi (Low Emission Vehicles)
<b>ULT</b>	Malli Ultra
<b>UPE</b>	Jos 0 928 400 527 asennetaan 0 928 400 314 :n tilalle, ohjainlaite on koodattava BMW-korjaamossa.
<b>UV2</b>	Malleihin, joissa ULEV2-pakokaasunormi (Ultra-Low Emission Vehicles)
<b>V86</b>	Alusta ja ohjaamo
<b>VAE</b>	Mallit, joissa tehostettu pakokaasujen puhdistus

<b>VBS</b>	Huomio! Varaosa Volvo Truck 0 444 022 069 (ilman paineentasauselementtiä kotelon kannessa). Uuden kuljetinmoduulin asennuksen jälkeen integroitu ohjainlaite täytyy ohjelmoida Volvon sopimuskorjaamossa.
<b>VGT</b>	VGT-moottori
<b>UTF</b>	Huomio! Volvo Truckia varten pitää tilata kotelon kansi F 00B H40 091 (ilman paineentasauselementtiä) ja syöttömoduulia pitää muuttaa. Kun uusi syöttömoduuli on asennettu, integroitu ohjainlaite pitää ohjelmoisa sopimuskorjaamossa.
<b>WAS</b>	+ vedenerotin
<b>WAS</b>	Ei vedenerotinta
<b>WEG</b>	ajonestolaitteella varustetut ajoneuvot
<b>WEG</b>	Mallit ilman ajonestolaitetta
<b>WEI</b>	Värimerkintä: valkoinen
<b>WEK</b>	Malleihin, joissa ajonesto ja ilmastointi
<b>WGT</b>	WGT-moottori
<b>WOK</b>	Mallit, joissa ajonesto, ei ilmastointia
<b>WW</b>	Optio
<b>WZT</b>	Ajonestolaitteella varustetut ajoneuvot, koodattu virta-avain (transponder)
<b>X10</b>	Sylinteri 1
<b>X56</b>	Sylinterit 2 - 6
<b>X96</b>	Pakokaasustandardi TIER2
<b>XXX</b>	Toimitetaan niin kauan kuin varastoa riittää
<b>YE8</b>	Pick-up-malleihin, joissa kaksoisohjain (4-ovinen)
<b>YK1</b>	Ei Performance-varustukseen
<b>Z25</b>	Ei malleihin, joissa ULEV-pakokaasunormi (Low Emission Vehicles)
<b>ZDA</b>	Varaosaluettelo ESPI-keskustyökalun (Zexel) arkistosta saatavilla
<b>ZE</b>	Tarvittava määrä: 2
<b>1</b>	+ neulan liiketunnistin

	Informaatio / selitys
	Tilausnumero
	HA / pienkuljetusauto
	Hyötyajoneuvo/kevytpakettiauto
	Maatalouskone tai työkone
	Paikallismoottori / asennusmoottori
	Iskutilavuus l
	Moottorin teho kW (hv)
	Moottorityyppi
	Sylinteriluku

	Vientimaa
	Päiväys/asennusaikaväli
	Erytistapaus
	Bosch-vaihto-osa
	Suutinpidinkokonaisuus
	Common Rail -injektori
	tiivistelevy
	Common Rail -korkeapainepumppu
	VE- ja VR-jakajaruiskutuspumppu
	Ilmamassanmittari



Unit Injection System UIS (pumppusuutin-yksikkö)



Unit Pump System UPS



Denoxtronic-syöttömoduuli



suutinpidin, tyyppikaava



suutin, tyyppikaava



avautumispaine



Tiivisterengas, sylinterinkansi/lämmönsuojalevy DHK



DNOX-ruiskutus-suutin



Tiivisterengas, vuotoöljyliitäntä DHK



Pumppusuutin-yksikkö (PDE)



Suutin



Lämmönsuoja



Vertailu



Sivuviite



DNOX-annostelumoduuli













<b>24S</b>	24 Volt
<b>24Z</b>	Dla cylindrów 2 - 4
<b>3T5</b>	Dla pojazdów o dopuszczalnej masie całkowitej 3,5 t
<b>4T5</b>	Dla pojazdów o dopuszczalnej masie całkowitej 4,5 t
<b>5PL</b>	Dla pojazdów spełniających wymagania normy spalin EURO 5 plus
<b>6PL</b>	Dla pojazdów spełniających wymagania normy spalin EURO 6 plus
<b>ABS</b>	Do pojazdów z ABS
<b>ABS</b>	Dla pojazdów bez ABS
<b>AG</b>	Do pojazdów z automatyczną skrzynią biegów
<b>AGF</b>	Dla pojazdów z oczyszczaniem spalin
<b>AGF</b>	Dla pojazdów bez oczyszczania spalin
<b>AGR</b>	Układ recyrkulacji spalin
<b>AGR</b>	Bez układu recyrkulacji spalin
<b>ASB</b>	Zwrócić uwagę na przyłącze
<b>ATW</b>	Przy zamawianiu pamiętać: w przypadku kombinacji korpusu wtryskiwaczy z NBF (czujnikiem ruchu iglicy) wymiana wtryskiwaczy nie jest możliwa. Zamontowana część musi zostać określona na podstawie pojazdu lub silnika.
<b>BG4</b>	Do Performance Paket
<b>BKN</b>	Wyposażenie firmy Bosch bez instalacji do zimnego rozruchu
<b>BO</b>	Bosch, jedynie jako część zamienna do wyposażenia Boscha
<b>BOK</b>	Wyposażenie Boscha z układem rozruchu zimnego silnika
<b>BOW</b>	Bosch, jedynie jako część zamienna do wyposażenia Boscha, dla pojazdów z immobilizerem.
<b>BOW</b>	Bosch, jedynie jako część zamienna do wyposażenia Boscha, dla pojazdów bez immobilizera.
<b>BS1</b>	Do aplikacji BS 1
<b>BS2</b>	Do aplikacji BS 2
<b>CAV</b>	Do produktów CAV
<b>CVT</b>	Dla pojazdów ze skrzynią biegów CVT
<b>GVF</b>	Nie dla pojazdów ze skrzynią biegów CVT
<b>DBB</b>	Pierścień uszczelniający komorę spalania znajduje się w zestawie
<b>DBJ</b>	Pierścień uszczelniający komorę spalania przy wtryskiwaczu, wstępnie zmontowany
<b>DBJ</b>	Dostawa nie obejmuje pierścienia uszczelniającego komory spalania
<b>DKF</b>	Produkcja Zexel
<b>E93</b>	Dla normy emisji spalin EEC 93
<b>E96</b>	Dla normy emisji spalin EEC 96
<b>EC9</b>	Dla normy emisji spalin EEC 99
<b>EDC</b>	Elektroniczna regulacja silnika wysokoprężnego
<b>EE2</b>	Dla normy emisji spalin EEC 2000
<b>EFV</b>	Części zamienne również dla modelu poprzedniego
<b>EFZ</b>	Zastępczy do zdarzeń obcych, wymieniać cały komplet
<b>EQ0</b>	Dla pojazdów typu pickup z dużą podwójną kabiną (4-drzw.)
<b>ERL</b>	Dla pojazdów ze zwiększoną mocą silnika
<b>EU2</b>	Dla pojazdów z normą emisji spalin Euro 2
<b>EU2</b>	Nie dla normy emisji spalin Euro 2
<b>EU3</b>	Dla pojazdów z normą emisji spalin Euro 3
<b>EU3</b>	Nie dla pojazdów spełniających wymagania normy spalin EURO 3
<b>EU4</b>	Dla pojazdów z normą emisji spalin Euro 4
<b>EU4</b>	Nie dla pojazdów z normą emisji spalin Euro 4
<b>EU5</b>	Dla pojazdów z normą emisji spalin Euro 5
<b>EU5</b>	Nie dla pojazdów spełniających wymagania normy spalin EURO 5
<b>EU6</b>	Dla pojazdów z normą emisji spalin Euro 6
<b>EU6</b>	Nie dla pojazdów spełniających wymagania normy spalin EURO 6
<b>EXW</b>	Wymiana wałka mimośrodowego tylko w połączeniu z pompą zębatą 0 440 020 044
<b>FBH</b>	Do pracy na wysokościach
<b>FD3</b>	Dla normy emisji spalin D3
<b>FE2</b>	Dla silników Euro 2/B
<b>FE2</b>	Nie dla silników Euro 2/B
<b>FKR</b>	Dla pojazdów z krótkim rozstawem kół
<b>FL5</b>	Dla normy emisji spalin L5
<b>FLR</b>	Dla pojazdów z długim rozstawem kół
<b>FMA</b>	Dla pojazdów bez poduszki powietrznej
<b>FWT</b>	Do wymiennika ciepła
<b>GES</b>	Do pojazdów z urządzeniem regulującym prędkość
<b>GES</b>	Dla pojazdów bez regulatora prędkości
<b>GNL</b>	Wykonanie Green Line
<b>GS</b>	Do pojazdów z ręczną skrzynią biegów
<b>HAG</b>	Dla pojazdów z półautomatyczną skrzynią biegów
<b>HEF</b>	Dla pojazdów z ogrzewaną szybą przednią
<b>HEF</b>	Dla pojazdów bez ogrzewanej szyby przedniej
<b>HIW</b>	Wersja do jazdy po ulicach
<b>I1B</b>	Dla wtryskiwaczy klasy 1, z oznaczeniem cyfrowym 1 albo oznaczeniem barwnym niebieskim
<b>I2G</b>	Dla wtryskiwaczy klasy 2, z oznaczeniem cyfrowym 2 albo oznaczeniem barwnym zielonym
<b>I3K</b>	Dla wtryskiwaczy klasy 3, z oznaczeniem cyfrowym 3
<b>KGL</b>	Nie do wykonania Green Line
<b>KKA</b>	Z oznakowaniem klasy A
<b>KKB</b>	Z oznakowaniem klasy B
<b>KKX</b>	Z oznakowaniem klasy X
<b>KKY</b>	Z oznakowaniem klasy Y
<b>KKZ</b>	Z oznakowaniem klasy Z
<b>KL</b>	Dla pojazdów z klimatyzacją
<b>KL</b>	Dla pojazdów bez klimatyzacji
<b>KOB</b>	Do samochodów kombi
<b>KOC</b>	Zapytania dot. napraw: BDC/BDS, Nowa część: inquiry@de.bosch.com
<b>KSE</b>	Układ rozruchu zimnego silnika wbudowany
<b>KZB</b>	Oznaczenie: kolor niebieski
<b>KZE</b>	Oznaczenie: kolor żółty
<b>KZG</b>	Oznaczenie: kolor zielony
<b>LAB</b>	Montaż z lewej strony
<b>LEN</b>	Do silnika z normalną mocą
<b>LET</b>	Do silnika z obniżoną mocą
<b>LLE</b>	Dla pojazdów z kierownicą z lewej strony
<b>LWG</b>	Dla samochodu dostawczego
<b>MEB</b>	Z układem wtryskowym firmy Bosch
<b>MG5</b>	Do pojazdów z 5-cio biegową ręczną skrzynią biegów
<b>MG6</b>	Do pojazdów z 6-cio biegową ręczną skrzynią biegów
<b>MKO</b>	Dla pojazdów z klimatyzacją, bez wspomaganie układu kierowniczego
<b>MLK</b>	Dla pojazdów ze wspomaganie kierownicy i klimatyzacją
<b>MLU</b>	Dla pojazdów z pompą powietrza wtórnego
<b>MPR</b>	Dla pojazdów z filtrem cząstek sadzy
<b>MPR</b>	Dla pojazdów bez filtra sadzy
<b>MRQ</b>	Dla pojazdów z wysokozakresowym regulatorem prędkości obrotowej RQ
<b>MVR</b>	Regulator, wmontowany
<b>N03</b>	Dla normy emisji spalin Euro 93 - CEE 19.5
<b>N05</b>	Dla normy emisji spalin Euro 96, CEE 95, L3
<b>N07</b>	Dla normy emisji spalin US 87
<b>N09</b>	Dla normy emisji spalin US 84 LDT
<b>N11</b>	Dla normy emisji spalin US 90 LDT
<b>N13</b>	Dla normy emisji spalin Euro 96
<b>N14</b>	Dla normy emisji spalin Euro 2000, CEE 2000
<b>N25</b>	Dla normy emisji spalin Euro 2005, EC 2005
<b>N25</b>	Nie dla normy spalin 2005, EC 2005
<b>N39</b>	Dla normy emisji spalin Euro 93 - CEE 19.5 i US 84 LDT
<b>N5P</b>	Nie dla pojazdów spełniających wymagania normy spalin EURO 5 plus
<b>NC8</b>	Dla kodu emisji spalin NC8
<b>NC9</b>	Dla kodu emisji spalin NC9
<b>NL4</b>	Dla normy emisji spalin L4
<b>NOR</b>	Wykonanie normalne
<b>NT5</b>	Dla kodu emisji spalin NT5
<b>OBD</b>	Dla pojazdów z diagnostyką On-Board (OBD)
<b>OBD</b>	Dla pojazdów bez diagnostyki On-Board (OBD)
<b>OLK</b>	Dla pojazdów bez wspomaganie układu kierowniczego i bez klimatyzacji
<b>OWK</b>	Dla pojazdów bez immobilizera, z klimatyzacją
<b>OWO</b>	Dla pojazdów bez immobilizera i bez klimatyzacji
<b>RAB</b>	Montaż z prawej strony
<b>RAP</b>	Nadaje się do RME (estru metylowego oleju rzepakowego)

<b>RAP</b>	Nie nadaje się do RME (estru metylowego oleju rzepakowego)
<b>RLE</b>	Dla pojazdów z kierownicą z prawej strony
<b>RSA</b>	Oznaczenie w kolorze różowym
<b>SCJ</b>	Dla pojazdów z katalizatorem SCR (Selective Catalytic Reduction)
<b>SCJ</b>	Dla pojazdów bez katalizatora SCR (Selective Catalytic Reduction)
<b>SDK</b>	Kabina standardowa
<b>SFU</b>	Czujnik wtykany, pojedynczy
<b>SFZ</b>	Dla pojazdów specjalnych
<b>SLX</b>	Dla pojazdów z wyposażeniem SLX
<b>SSJ</b>	Dla pojazdów z funkcją start/stop
<b>SSJ</b>	Dla pojazdów bez funkcji start/stop
<b>THD</b>	Po montażu należy zaprogramować zintegrowany sterownik w autoryzowanym warsztacie producenta.
<b>THI</b>	Po wymianie sterownika pompy albo pompy wtryskowej immobilizer musi być uaktywniany w autoryzowanym warsztacie producenta.
<b>THS</b>	Sterownik po montażu pompy wtryskowej musi zostać zaprogramowany w autoryzowanym warsztacie producenta pojazdu.
<b>TIE</b>	Dla pojazdów z normą emisji spalin TIER 1
<b>TNK</b>	W celu jednoznacznej identyfikacji numeru Boscha należy przedłożyć kartę danych pojazdu. Elementy towarzyszące wyrobowi muszą być zgodne z wymienionymi w karcie danych.
<b>TW</b>	Zamontowany wyrób musi być zidentyfikowany w pojeździe lub silniku.
<b>ULE</b>	Dla pojazdów spełniających wymogi normy emisji spalin ULEV (Ultra Low Emission Vehicles)
<b>ULT</b>	Wersja Ultra
<b>UPE</b>	W razie montażu 0 928 400 527 zamiast 0 928 400 314 konieczna jest reprogramacja sterownika przez serwis BMW.
<b>UV2</b>	Dla pojazdów, spełniających wymagania normy spalin ULEV2 (Ultra-Low Emission Vehicles)
<b>V86</b>	Podwozie z kabiną kierowcy
<b>VAE</b>	Dla pojazdów z zintensyfikowanym systemem oczyszczania spalin z substancji szkodliwych

<b>VBS</b>	Uwaga! Zastępstwo dla Volvo Truck 0 444 022 069 (bez elementu wyrównującego ciśnienie w pokrywie obudowy). Po zamontowaniu nowego modułu tłoczenia należy zaprogramować zintegrowany sterownik w autoryzowanym serwisie Volvo.
<b>VGT</b>	Silnik VGT
<b>VTF</b>	Uwaga: Dla Volvo Truck należy zamówić pokrywę obudowy F 00B H40 091 (bez elementu wyrównującego ciśnienie) i zamontować moduł tłoczenia. Po zamontowaniu nowego modułu tłoczenia należy zaprogramować zintegrowany sterownik w autoryzowanym warsztacie.
<b>WAS</b>	Z oddzielaczem wody
<b>WAS</b>	Bez oddzielacza wody
<b>WEG</b>	Dla pojazdów z immobilizerem
<b>WEG</b>	Dla pojazdów bez immobilizera
<b>WEI</b>	Oznaczenie kolorem: biały
<b>WEK</b>	Dla pojazdów z immobilizerem i klimatyzacją
<b>WGT</b>	Silnik WGT
<b>WOK</b>	Dla pojazdów z immobilizerem, bez klimatyzacji
<b>WW</b>	Do wyboru
<b>WZT</b>	Dla pojazdów z immobilizerem, odblokowanie przez kluczyk zapłonowy (system Transponder)
<b>X10</b>	Dla cylindra 1
<b>X56</b>	Dla cylindrów 2 - 6
<b>X96</b>	Norma czystości spalin TIER2
<b>XXX</b>	Dostawa tylko do wyczerpania zapasu
<b>YE8</b>	Do pojazdów typu pickup z podwójną kabiną (4-drzwiową)
<b>YK1</b>	Nie do wyposażenia Performance
<b>Z25</b>	Nie dla pojazdów spełniających wymogi normy emisji spalin ULEV (Ultra Low Emission Vehicles)
<b>ZDA</b>	Wykaz cz.zam. dost. w arch.ESPI-ZD/Zexel
<b>ZE</b>	Konieczne dwa
<sup>1</sup>	Z czujnikiem położenia iglicy

	Informacja / objaśnienie
	Nr katalogowy
	Sam. osobowy / mała furgonetka
	Pojazd użytkowy / mała furgonetka
	Maszyny rolnicze / budowlane
	Silnik stacjonarny / silnik do wbudowania
	Pojemność silnika w litrach
	Moc silnika w kW (KM)
	Typ silnika

	Liczba cylindrów
	Kraj eksportu
	Data produkcji
	Informacje dodatkowe
	Część zamienna Bosch
	Wtryskiwacz
	Wtryskiwacz Common Rail
	Pierścień uszczelniający
	Pompa wysokiego ciśnienia Common Rail





Pompa wtryskowa rozdzielaczowa VE i VR



Przepływomierz masowy powietrza



System Pompowtryskiwaczy (Unit Injection System)



Unit Pump System UPS



Moduł tłoczący Denoxtronic



Kod typu uchwytu wtryskiwacza



Kod typu dyszy



Ciśnienie otwarcia



Wtryskiwacz DNOX



Uszczelka głowicy cylindrów/podkładka termoizolacyjna DHK



Uszczelka przyłącza oleju odciekowego DHK



Pompowtryskiwacz (PDE)



Rozpylacz



Izolacja cieplna



Zestawienie



Odesłanie do strony



Moduł dozujący DNOX

<b>24S</b>	24 Вольт
<b>24Z</b>	Для цилиндров 2 - 4
<b>3T5</b>	Для автомобилей с допустимой полной массой 3,5 т
<b>4T5</b>	Для автомобилей с допустимой полной массой 4,5 т
<b>5PL</b>	Для автомобилей с нормой токсичности ОГ Euro 5 Plus
<b>6PL</b>	Для автомобилей с нормой токсичности ОГ Euro 6 Plus
<b>ABS</b>	для автомобилей с антиблокировочным устройством
<b>ABS</b>	для автомобилей без антиблокировочного устройства
<b>AG</b>	для автомобилей с автоматической коробкой скоростей
<b>AGF</b>	Для автомобилей со сниженной токсичностью ОГ
<b>AGF</b>	Не для автомобилей со сниженным уровнем ОГ
<b>AGR</b>	Рециркуляция отработавших газов
<b>AGR</b>	без рециркуляции ОГ
<b>ASB</b>	обратить внимание на соединение
<b>ATW</b>	При заказе обратить внимание: комбинации корпуса форсунки с датчиком движения иглы (NBF) замена форсунки невозможна. Встроенное изделие должно быть определено в автомобиле или моторе.
<b>BG4</b>	Для Performance Package
<b>BKN</b>	Оснащение Bosch без устройства для пуска холодного двигателя
<b>BO</b>	Bosch, только в качестве замены оснащения фирмы Bosch
<b>BOK</b>	Оборудование фирмы Bosch с установкой для пуска холодного двигателя
<b>BOW</b>	Bosch, только в качестве замены оснащения фирмы Bosch, для автомобилей с противоугонным устройством.
<b>BOW</b>	Bosch, только в качестве замены оснащения фирмы Bosch, для автомобилей без противоугонного устройства.
<b>BS1</b>	Для приложений BS 1
<b>BS2</b>	Для приложений BS 2
<b>CAV</b>	Для продукции марки CAV
<b>CVT</b>	Для автомобилей с коробкой передач CVT
<b>CVT</b>	Не для автомобилей с КПП CVT
<b>DBB</b>	Уплотнительное кольцо камеры сгорания прилагается
<b>DBJ</b>	Уплотнительное кольцо камеры сгорания, предварительно смонтированное на инжекторе
<b>DBJ</b>	Уплотнительное кольцо камеры сгорания не входит в комплект поставки
<b>DKF</b>	производство Цексель
<b>E93</b>	Для нормы токсичности ОГ EEC 93
<b>E96</b>	Для нормы токсичности ОГ EEC 96
<b>EC9</b>	Для нормы токсичности ОГ EEC 99
<b>EDC</b>	электронное управление дизелем
<b>EE2</b>	Для стандарта по отработавшим газам EEC 2000
<b>EFV</b>	Также замена для предшественника
<b>EFZ</b>	Вместо изделий других фирм, заменять комплект
<b>EQ0</b>	Для пикапа с большой двойной кабиной (4-дверный)
<b>ERL</b>	Для транспортных средств с повышающейся мощностью
<b>EU2</b>	Для автомобилей с нормой токсичности ОГ Euro 2
<b>EU2</b>	Не для нормы токсичности ОГ Euro 2
<b>EU3</b>	Для автомобилей с нормой токсичности ОГ Euro 3
<b>EU3</b>	Не для автомобилей с нормой токсичности ОГ Euro 3
<b>EU4</b>	Для автомобилей с нормой токсичности ОГ Euro 4
<b>EU4</b>	Не для а/м с нормами токсичности ОГ Euro 4
<b>EU5</b>	Для автомобилей с нормой токсичности ОГ Euro 5
<b>EU5</b>	Не для автомобилей с нормой токсичности ОГ Euro 5
<b>EU6</b>	Для автомобилей с нормой токсичности ОГ Euro 6
<b>EU6</b>	Не для автомобилей с нормой токсичности ОГ Euro 6
<b>EXW</b>	Замена эксцентрикового вала только вместе с шестеренным насосом 0 440 020 044
<b>FBH</b>	Для эксплуатации в высоких положениях
<b>FD3</b>	Для нормы выпуска ОГ D3
<b>FE2</b>	Для двигателей Euro 2/B
<b>FE2</b>	Не для двигателей Euro 2/B
<b>FKR</b>	для автомобилей с короткой базой
<b>FL5</b>	Для нормы токсичности ОГ L5
<b>FLR</b>	для автомобилей с длинной базой
<b>FMA</b>	Для транспортных средств без надувной подушки безопасности
<b>FWT</b>	Для теплообменника
<b>GES</b>	для автомобилей с устройством регулятора скорости
<b>GES</b>	для автомобилей без устройства регулятора скорости
<b>GNL</b>	Исполнение Green Line
<b>GS</b>	для автомобилей с коробкой передач с ручным управлением
<b>HAG</b>	Для автомобилей с полуавтоматической коробкой передач
<b>HEF</b>	Для автомоб.с обогреваемым лобовым стеклом
<b>HEF</b>	Для автомобилей без подогрева ветрового стекла
<b>HIW</b>	Исполнение для обычной дороги
<b>I1B</b>	Для инжекторов класса 1, с индексом 1 или синей цветовой маркировкой
<b>I2G</b>	Для инжекторов класса 2, с индексом 2 или зеленой цветовой маркировкой
<b>I3K</b>	Для инжекторов класса 3, с индексом 3
<b>KGL</b>	Не для исполнения Green Line
<b>KKA</b>	С маркировкой класса А
<b>KKB</b>	С маркировкой класса В
<b>KKX</b>	С обозначением класса X
<b>KKY</b>	С обозначением класса Y
<b>KKZ</b>	С обозначением класса Z
<b>KL</b>	для автомобилей с кондиционером
<b>KL</b>	для автомобилей без кондиционера
<b>KOB</b>	для автомобиля комби
<b>KOC</b>	Запрос ремонт: BDC/BDS, новая деталь: inquiry@de.bosch.com
<b>KSE</b>	приспособление холодного запуска, встроенное
<b>KZB</b>	номерной знак: синий
<b>KZE</b>	Номерной знак : желтый
<b>KZG</b>	номерной знак: зеленый
<b>LAB</b>	встроенная слева
<b>LEN</b>	Для двигателя с расчетной мощностью
<b>LET</b>	Для двигателя с низкой мощностью
<b>LLE</b>	для автомобилей с левосторонним расположением рулевого колеса
<b>LWG</b>	для автомобилей для перевозки мелкопартийных грузов
<b>MEB</b>	с системой впрыскивания Bosch
<b>MG5</b>	для автомобилей с коробкой передач с ручным управлением, 5-ти скоростной
<b>MG6</b>	для автомобилей с коробкой передач с ручным управлением, 6 -ти скоростной
<b>MKO</b>	Для транспортных средств с климатической установкой, без усилителя рулевого привода
<b>MLK</b>	для автомобилей с усилителем рулевого привода и кондиционером
<b>MLU</b>	Для автомобилей с насосом вторичного воздуха
<b>MPR</b>	Для автомобилей с сажевым пылевым фильтром
<b>MPR</b>	Для автомобилей без сажевого пылевого фильтра
<b>MRQ</b>	Для автомобилей с ограничителем максимальной частоты вращения RQ
<b>MVR</b>	всережимный регулятор частоты вращения, встроенный
<b>N03</b>	Для нормы токсичности ОГ Euro 93 - CEE 19.5
<b>N05</b>	Для нормы токсичности ОГ Euro 96, CEE 95, L3
<b>N07</b>	Для нормы ОГ US 87
<b>N09</b>	Для нормы ОГ US 84 LDT
<b>N11</b>	Для нормы ОГ US 90 LDT
<b>N13</b>	Для нормы токсичности ОГ Euro 96
<b>N14</b>	Для нормы токсичности ОГ Euro 2000, CEE 2000
<b>N25</b>	Для нормы токсичности ОГ Euro 2005, EC 2005
<b>N25</b>	Не для нормы токсичности ОГ Euro 2005, EC 2005
<b>N39</b>	Для нормы токсичности ОГ Euro 93 - CEE 19.5 и US 84 LDT
<b>N5P</b>	Не для автомобилей с нормой токсичности ОГ Euro 5 Plus
<b>NC8</b>	Для кода значения ОГ NC8
<b>NC9</b>	Для кода показателей состава ОГ NC9
<b>NL4</b>	Для нормы токсичности ОГ L4
<b>NOR</b>	Обычное исполнение
<b>NT5</b>	Для кода значения ОГ NT5
<b>OBD</b>	Для автомобилей с бортовой диагностикой (OBD)
<b>OBV</b>	Для автомобилей без бортовой диагностики(OBD)
<b>OLK</b>	без усилителя рулевого привода и кондиционера
<b>OWK</b>	для автомобилей без противоугонного устройства, с кондиционером
<b>OWO</b>	Для транспортных средств без противоугонной функции и без климатической установки

<b>RAB</b>	встроенная справа
<b>RAP</b>	Подходит для МЭРМ (метиловый эфир рапсового масла)
<b>RAP</b>	Не подходит для МЭРМ (метиловый эфир рапсового масла)
<b>RLE</b>	для автомобилей с правосторонним расположением рулевого колеса
<b>RSA</b>	Цветовая маркировка: розовая
<b>SCJ</b>	Для автомобилей с катализатором SCR (Selective Catalytic Reduction)
<b>SCJ</b>	Для автомобилей без катализатора SCR (Selective Catalytic Reduction)
<b>SDK</b>	стандартная кабина
<b>SFU</b>	Вставляемый датчик, одиночный
<b>SFZ</b>	для специальных автомобилей
<b>SLX</b>	Для автомобилей с пакетом оснащения SLX
<b>SSJ</b>	Для автомобилей с функцией пуск-останов
<b>SSJ</b>	Для автомобилей без функции пуск-останов
<b>THD</b>	После установки необходимо запрограммировать интегрированный блок управления в официальной СТО изготовителя автомобиля.
<b>THI</b>	После замены блока управления насоса или ТНВД необходимо активировать иммобилайзер на СТО изготовителя автомобиля.
<b>THS</b>	Блок управления должен программироваться после установки насоса для впрыска топлива в гарантийной мастерской производителя автомобиля.
<b>TIE</b>	Для автомобилей с нормой токсичности ОГ TIER 1
<b>TNK</b>	Для однозначной идентификации № Bosch требуется карта данных автомобиля. Компоненты, установленные в изделии, должны совпадать с компонентами карты данных.
<b>TW</b>	Встроенное издание должно определяться в автомобиле или двигателе.
<b>ULE</b>	Для автомобилей с нормой токсичности ОГ ULEV (Ultra Low Emission Vehicles)
<b>ULT</b>	Исполнение Ultra
<b>UPE</b>	Устанавливается 0 928 400 527 вместо 0 928 400 314. Блок управления должен быть перепрограммирован на СТОА BMW.
<b>UV2</b>	Для автомобилей с нормой токсичности ОГ ULEV2 (Ultra Low Emission Vehicles)
<b>V86</b>	Шасси с кабиной
<b>VAE</b>	для автомобилей с особым снижением токсичности ОГ

<b>VBS</b>	Внимание! Замена для грузового автомобиля Volvo: 0 444 022 069 (без элемента выравнивания давления в крышке корпуса). После установки нового транспортного модуля необходимо запрограммировать встроенный блок управления на СТО Volvo.
<b>VGT</b>	Двигатель VGT
<b>VTF</b>	Внимание! Для грузовых автомобилей Volvo необходимо заказывать крышку корпуса F 00В Н40 091 (без элемента выравнивания давления) и переделывать транспортный модуль. После установки нового транспортного модуля встроенный блок управления необходимо запрограммировать на СТО.
<b>WAS</b>	с водоотделителем
<b>WAS</b>	без водоотделителя
<b>WEG</b>	для автомобилей с противоугонным устройством
<b>WEG</b>	для автомобилей без противоугонного устройства
<b>WEI</b>	Цветной опознавательный знак : Белый
<b>WEK</b>	для автомобилей с противоугонным устройством и кондиционером
<b>WGT</b>	Двигатель WGT
<b>WOK</b>	Для транспортных средств с противоугонной функцией, без климатической установки
<b>WW</b>	на выбор
<b>WZT</b>	Для транспортных средств с противоугонной функцией, свободное выключение через ключ зажигания (транспондер-система)
<b>X10</b>	Для цилиндра 1
<b>X56</b>	Для цилиндров 2 - 6
<b>X96</b>	Норма токсичности ОГ TIER2
<b>XXX</b>	Поставка, пока есть на складе
<b>YE8</b>	Для пикапа с двойной кабиной (4-дверный)
<b>YK1</b>	Не для оснащения Performance
<b>Z25</b>	Не для автомобилей с нормой токсичности ОГ ULEV (Ultra Low Emission Vehicles)
<b>ZDA</b>	Список запасных частей на ESPI-ZD (Zexel), доступен архив
<b>ZE</b>	необходимо два
<b>1</b>	С датчиком движения иглы

	Информация / Пояснение
	Номер для заказа
	Легковой автомобиль / малый автомобиль-фургон
	Грузовик/автомобиль-фургон
	Сельскохозяйственная или строительная машина
	Стационарный двигатель / встроенный двигатель
	Рабочий объем цилиндра в л
	Мощность двигателя в кВт (л. с.)

	Тип двигателя
	Количество цилиндров
	Страна-экспортер
	Дата / Период сборки
	Особый случай
	Восстановленная деталь Bosch
	Форсунка в сборе
	Инжектор общей топливной магистрали



Уплотнительная шайба



Насос высокого давления общей топливной магистрали



ТНВД VE и VR



Измеритель массы воздуха



Unit Injection System UIS (насос - форсунка)



Unit Pump System UPS



Модуль подачи Denoxtronic



Корпус форсунки, содержание маркировки



Форсунка, содержание маркировки



Форсунка DNOX



Давление открытия



Кольцевая прокладка головки цилиндра/шайба теплоизоляции DHK



Кольцевая прокладка линии отвода утечек масла DHK



насос-форсунка (PDE)



Форсунка



Тепловая защита



Сравнение



Сторонняя ссылка



Дозировочный модуль DNOX











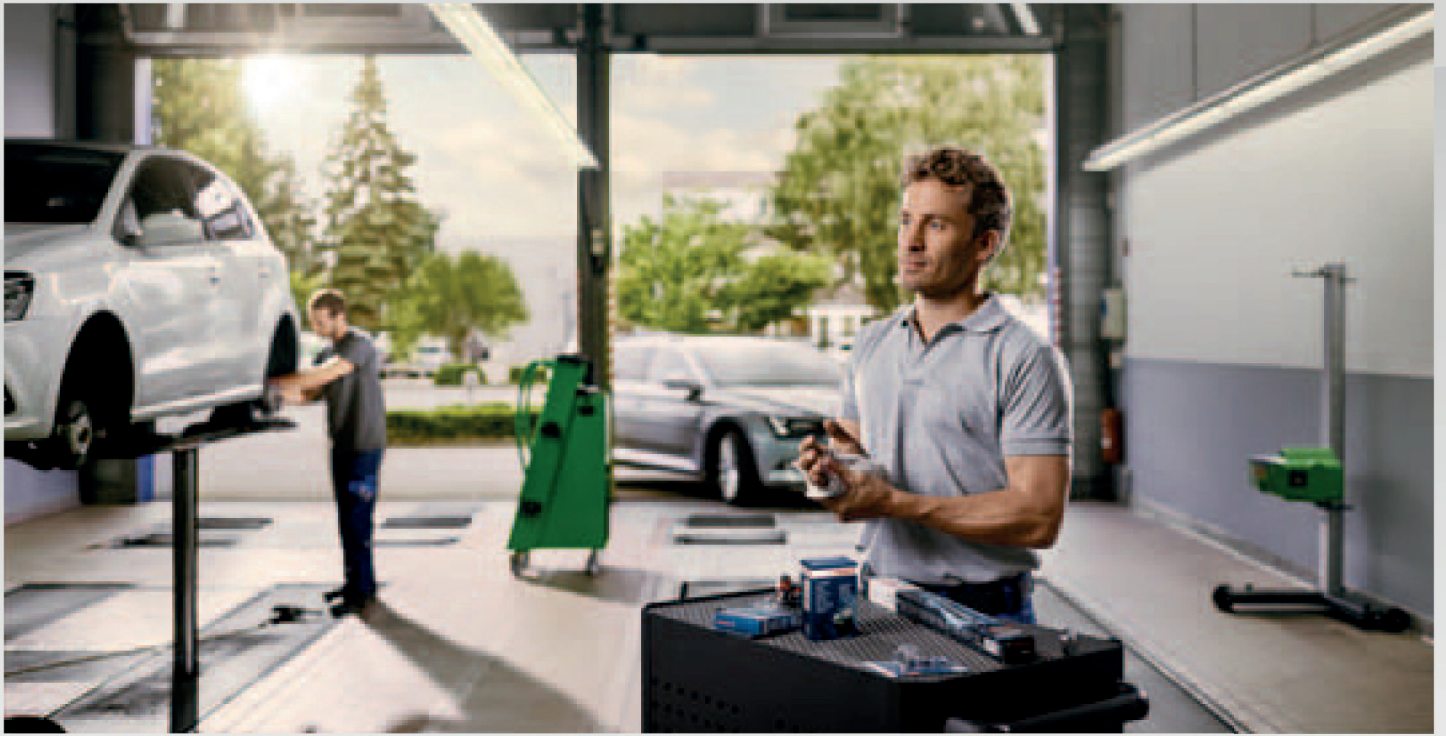

de

**Effizienz ist unser Antrieb**

Technologien von Bosch kommen weltweit in fast allen Fahrzeugen zum Einsatz. Dabei stehen für uns die Menschen und die Sicherstellung ihrer Mobilität im Vordergrund.

Ihnen widmen wir über 125 Jahre Pioniergeist, Forschung, Fertigung und Expertise.

Und für sie arbeiten wir unentwegt an einer Kombination aus Ersatzteilen, Diagnose, Werkstattausrüstung und Serviceleistungen.

en

**Driven by efficiency**

Bosch technologies are used worldwide in almost all vehicles. People, and assuring their mobility, is what we are focused on.

Therefore, we have dedicated the last 125 years of pioneering spirit and expertise in research and manufacturing to achieving this.

We continue to work on our unique combination of solutions for spare parts, diagnostic devices, workshop equipment and services.

fr

**Guidés par l'efficacité**

Les technologies de Bosch sont utilisées partout dans le monde, dans la quasi-totalité des véhicules. Nous nous concentrons sur les populations et cherchons avant tout à assurer leur mobilité.

Depuis 125 ans, nous mettons notre esprit pionnier et notre expertise en matière de recherche et de fabrication au service de cet objectif.

Chaque jour, nous travaillons sur notre offre unique de pièces détachées, d'appareils de diagnostic, de matériel et sur les services proposés dans les ateliers.

it

**Guidati dall'efficienza**

Le tecnologie Bosch sono utilizzate a livello mondiale in quasi tutti i veicoli. Siamo concentrati sulle persone e sulla loro mobilità.

Per raggiungere questo risultato, abbiamo dedicato gli ultimi 125 anni alla ricerca e produzione, con spirito pionieristico e competenza.

Continuiamo a lavorare sulla nostra combinazione unica di soluzioni per ricambi, dispositivi di diagnosi, attrezzature e servizi per l'officina.

es

**La eficiencia es nuestra motivación**

La tecnología de Bosch se utiliza en todo el mundo en casi todos los vehículos. Garantizar la movilidad de las personas es nuestra prioridad.

Llevamos más de 125 años siendo pioneros en el mundo del automóvil, investigando, fabricando y aportando nuestra experiencia.

Trabajamos para ofrecer una combinación exclusiva de piezas de recambio, diagnosis, equipamiento de taller y servicios.

ru

**Обеспечивая эффективность**

Технологии Bosch используются по всему миру практически во всех автомобилях. Центром внимания для нас являются забота о людях и обеспечение их мобильности.

Достижению этого мы посвятили последние 125 лет своего новаторского духа и знаний в сфере исследований и производства.

Мы продолжаем работать над тем, чтобы обеспечить уникальный комплекс решений по запчастям, оборудованию для СТО и сервисным концепциям.



☎ 1 987 720 018/201811

AA/SCE4 – 11.2018 – Int

© 2018 Robert Bosch GmbH  
Automotive Aftermarket  
Postfach 41 09 60  
76225 Karlsruhe

Token fee: € 5,00

Editorial closing: 15.09.2018

Subject to change without notice. Please direct questions and comments to our Authorized Representative in your country. This edition supersedes all previous editions.



Bosch parts fast and easy on:  
[bosch-automotive-catalog.com](http://bosch-automotive-catalog.com)



4 047 024 069954